

# Contents

## A-Z

BMW M



The Ultimate  
Driving Machine®



# THE BMW M2 COUPE.

## OWNER'S MANUAL.



## **M2** **Owner's Manual for the vehicle**

Thank you for choosing a BMW M2.

The more familiar you are with your vehicle, the better control you will have on the road. We therefore strongly suggest:

Read this Owner's Manual before starting off in your new BMW M2. Also use the Integrated Owner's Manual in your vehicle. It contains important information on vehicle operation that will help you make full use of the technical features available in your BMW M2. The manual also contains information designed to enhance operating reliability and road safety, and to contribute to maintaining the value of your BMW M2.

Any updates made after the editorial deadline can be found in the appendix of the printed Owner's Manual for the vehicle.

Supplementary information can be found in the additional brochures in the onboard literature.

We wish you a safe and enjoyable trip.



The Owner's Manual is available in many countries as an app.  
Additional information on the Internet:

[www.bmw.com/bmw\\_drivers\\_guide](http://www.bmw.com/bmw_drivers_guide)

© 2016 Bayerische Motoren Werke  
Aktiengesellschaft  
Munich, Germany  
Reprinting, including excerpts, only with the written  
consent of BMW AG, Munich.  
US English ID4 VI/16, 07 16 490  
Printed on environmentally friendly paper, bleached  
without chlorine, suitable for recycling.

# Contents

The fastest way to find information on a particular topic or item is by using the index, refer to page 214.

## 6 Information

### At a glance

- 14 Cockpit
- 18 iDrive
- 26 Voice activation system
- 29 Integrated Owner's Manual in the vehicle

### Controls

- 34 Opening and closing
- 49 Settings
- 61 Transporting children safely
- 65 Driving
- 79 Displays
- 93 Lights
- 98 Safety
- 115 Driving stability control systems
- 120 Driving comfort
- 128 Climate control
- 135 Interior equipment
- 144 Storage compartments

### Driving tips

- 150 BMW M2 Technology
- 152 Things to remember when driving
- 156 Loading
- 159 Saving fuel

### Mobility

- 164 Refueling
- 166 Fuel
- 168 Wheels and tires
- 180 Engine compartment
- 182 Engine oil
- 185 Coolant
- 187 Maintenance
- 189 Replacing components
- 196 Breakdown assistance
- 202 Care

### Reference

- 210 Technical data
- 212 Appendix
- 214 Everything from A to Z

# Information

## Using this Owner's Manual

### Orientation

The fastest way to find information on a particular topic is by using the index.

An initial overview of the vehicle is provided in the first chapter.

### Updates made after the editorial deadline

Due to updates after the editorial deadline, differences may exist between the printed Owner's Manual and the following Owner's Manuals:

- ▷ Integrated Owner's Manual in the vehicle.
- ▷ Online Owner's Manual.
- ▷ BMW Driver's Guide app.

Notes on updates can be found in the appendix of the printed Owner's Manual for the vehicle.

### Owner's Manual for Navigation, Entertainment, Communication

The Owner's Manual for Navigation, Entertainment, and Communication can be obtained as printed book from the service center.

The topics of Navigation, Entertainment, and Communication can be called up via the following Owner's Manuals:

- ▷ Integrated Owner's Manual in the vehicle on the Control Display.
- ▷ Online Owner's Manual.
- ▷ BMW Driver's Guide app.

## Additional sources of information

### Dealer's service center

A dealer's service center will be glad to answer additional questions at any time.

### Internet

Owner's Manual and general information about BMW, such as about the technology, in the Internet: [www.bmwusa.com](http://www.bmwusa.com).

### BMW Driver's Guide App



The Owner's Manual is available in many countries as an app. Additional information on the Internet:

[www.bmw.com/bmw\\_drivers\\_guide](http://www.bmw.com/bmw_drivers_guide)

## Symbols and displays

### Symbols in the Owner's Manual

 Indicates precautions that must be followed precisely in order to avoid the possibility of personal injury and serious damage to the vehicle.

◀ Marks the end of a specific item of information.

 Refers to measures that can be taken to help protect the environment.

"..." Identifies display texts in vehicle used to select individual functions.

>...< Verbal instructions to use with the voice activation system.

»...« Identifies the answers generated by the voice activation system.

## Action steps

Action steps to be carried out are presented as numbered list. The steps must be carried out in the defined order.

1. First action step.
2. Second action step.

## Enumerations

Enumerations without mandatory order or alternative possibilities are presented as list with bullet points.

- ▷ First possibility.
- ▷ Second possibility.

## Symbols on vehicle components

 Indicates that you should consult the relevant section of this Owner's Manual for information on a particular part or assembly.

## Vehicle features and options

This Owner's Manual describes all models and all standard, country-specific and optional equipment that is offered in the model series. Therefore, this Owner's Manual also describes and illustrates features and functions that are not available in your vehicle, e.g., because of the selected optional features or the country-specific version.

This also applies to safety-related functions and systems.

When using these functions and systems, the applicable country provisions must be observed.

For any options and equipment not described in this Owner's Manual, refer to the Supplementary Owner's Manuals.

On right-hand drive vehicles, some control elements are arranged differently from what is shown in the illustrations.

## Status of the Owner's Manual

### Basic information

The manufacturer of your vehicle pursues a policy of constant development that is conceived to ensure that our vehicles continue to embody the highest quality and safety standards. In rare cases, therefore, the features described in this Owner's Manual may differ from those in your vehicle.

### Updates made after the editorial deadline

Due to updates after the editorial deadline, differences may exist between the printed Owner's Manual and the following Owner's Manuals:

- ▷ Integrated Owner's Manual in the vehicle.
- ▷ Online Owner's Manual.
- ▷ BMW Driver's Guide app.

Notes on updates can be found in the appendix of the printed Owner's Manual for the vehicle.

## Own safety

### Intended use

Observe the following when using the vehicle:

- ▷ Owner's Manual.
- ▷ Information on the vehicle. Do not remove stickers.
- ▷ Technical vehicle data.
- ▷ The laws and safety standards applicable in the country, where the vehicle is driven.
- ▷ Vehicle documents and statutory documents.

### Warranty

Your vehicle is technically configured for the operating conditions and registration require-

ments applying in the country of first delivery, also known as homologation. If your vehicle is to be operated in a different country it might be necessary to adapt your vehicle to potentially differing operating conditions and permit requirements. If your vehicle does not comply with the homologation requirements in a certain country you may not be able to lodge warranty claims for your vehicle there. Further information on warranty is available from a dealer's service center.

### Maintenance and repairs

Advanced technology, e.g., the use of modern materials and high-performance electronics, requires suitable maintenance and repair work.

The manufacturer of the vehicle recommends that you entrust corresponding procedures to a BMW dealer's service center. If you choose to use another service facility, BMW recommends use of a facility that performs work, e.g., maintenance and repair, according to BMW specifications with properly trained personnel, referred to in this Owner's Manual as "another qualified service center or repair shop".

If work, e.g., maintenance and repair, is performed improperly, there is a risk of subsequent damage and related safety risks.

### Parts and accessories

BMW recommends the use of parts and accessory products approved by BMW.

Approved parts and accessories, and advice on their use and installation are available from a BMW dealer's service center.

BMW parts and accessories have been tested by BMW for their safety and suitability in BMW vehicles.

BMW warrants genuine BMW parts and accessories.

BMW does not evaluate whether each individual product from another manufacturer can be used with BMW vehicles without presenting a safety hazard, even if a country-specific official

approval was issued. BMW does not evaluate whether these products are suitable for BMW vehicles under all usage conditions.

### California Proposition 65 Warning

California laws require us to state the following warning:

Engine exhaust and a wide variety of automobile components and parts, including components found in the interior furnishings in a vehicle, contain or emit chemicals known to the State of California to cause cancer and birth defects and reproductive harm. In addition, certain fluids contained in vehicles and certain products of component wear contain or emit chemicals known to the State of California to cause cancer and birth defects or other reproductive harm. Battery posts, terminals and related accessories contain lead and lead compounds. Wash your hands after handling. Used engine oil contains chemicals that have caused cancer in laboratory animals. Always protect your skin by washing thoroughly with soap and water.

### Service and warranty

We recommend that you read this publication thoroughly. Your vehicle is covered by the following warranties:

- ▷ New Vehicle Limited Warranty.
- ▷ Rust Perforation Limited Warranty.
- ▷ Federal Emissions System Defect Warranty.
- ▷ Federal Emissions Performance Warranty.
- ▷ California Emission Control System Limited Warranty.

Detailed information about these warranties is listed in the Service and Warranty Information Booklet for US models or in the Warranty and Service Guide Booklet for Canadian models.

Your vehicle has been specifically adapted and designed to meet the particular operating conditions and homologation requirements in your country and continental region in order to de-

liver the full driving pleasure while the vehicle is operated under those conditions. If you wish to operate your vehicle in another country or region, you may be required to adapt your vehicle to meet different prevailing operating conditions and homologation requirements. You should also be aware of any applicable warranty limitations or exclusions for such country or region. In such case, please contact Customer Relations for further information.

## Maintenance

Maintain the vehicle regularly to sustain the road safety, operational reliability and the New Vehicle Limited Warranty.

Specifications for required maintenance measures:

- ▷ BMW Maintenance system
- ▷ Service and Warranty Information Booklet for US models
- ▷ Warranty and Service Guide Booklet for Canadian models

If the vehicle is not maintained according to these specifications, this could result in serious damage to the vehicle. Such damage is not covered by the BMW New Vehicle Limited Warranty.

## Data memory

Many electronic components on your vehicle are equipped with data memories that temporarily or permanently store technical information about the condition of the vehicle, events and faults. This technical information generally records the state of a component, a module, a system or the environment:

- ▷ Operating states of system components, e.g., fill levels.
- ▷ Status messages for the vehicle and from its individual components, e.g., wheel rotation speed, wheel speed, deceleration, transverse acceleration.

- ▷ Malfunctions and faults in important system components, e.g., lights and brakes.
- ▷ Responses by the vehicle to special situations such as airbag deployment or engagement of the stability control systems.
- ▷ Ambient conditions, such as temperature.

This data is purely technical in nature and is used to detect and correct faults and to optimize vehicle functions. Motion profiles over routes traveled cannot be created from this data. When service offerings are used, e.g., repair services, service processes, warranty claims, quality assurance, this technical information can be read out from the event and fault memories by employees of a dealer's service center or another qualified service center or repair shop, including the manufacturer, using special diagnostic tools. You can obtain further information there if you need it. After an error is corrected, the information in the fault memory is deleted or overwritten on a continuous basis.

With the vehicle in use there are situations where you can associate this technical data with individuals if combined with other information, e.g., an accident report, damage to the vehicle, eye witness accounts — possibly with the assistance of an expert.

Additional functions that are contractually agreed with the customer — such as vehicle emergency locating — allow certain vehicle data to be transmitted from the vehicle.

## Event Data Recorder EDR

This vehicle is equipped with an event data recorder EDR. The main purpose of an EDR is to record, in certain crash or near crash-like situations, such as an air bag deployment or hitting a road obstacle, data that will assist in understanding how a vehicle's systems performed. The EDR is designed to record data related to vehicle dynamics and safety systems for a

short period of time, typically 30 seconds or less.

The EDR in this vehicle is designed to record such data as:

- ▷ How various systems in your vehicle were operating.
- ▷ Whether or not the driver and passenger safety belts were fastened.
- ▷ How far, if at all, the driver was depressing the accelerator and/or brake pedal.
- ▷ How fast the vehicle was traveling.

This data can help provide a better understanding of the circumstances in which crashes and injuries occur.

EDR data is recorded by your vehicle only if a nontrivial crash situation occurs; no data is recorded by the EDR under normal driving conditions and no personal data, e.g., name, gender, age, and crash location, are recorded.

However, other parties, such as law enforcement, could combine the EDR data with the type of personally identifying data routinely acquired during a crash investigation.

To read data recorded by an EDR, special equipment is required, and access to the vehicle or the EDR is needed. In addition to the vehicle manufacturer, other parties, such as law enforcement, that have the special equipment, can read the information if they have access to the vehicle or the EDR.

## Vehicle identification number

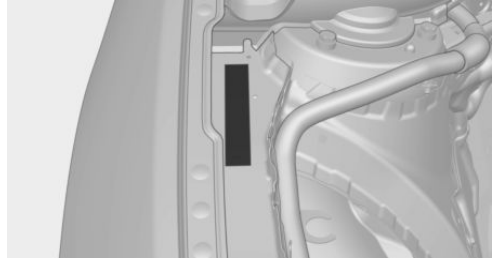

The vehicle identification number can be found in the engine compartment.

The vehicle identification number can also be found behind the windshield.

## Reporting safety defects

### For US customers

The following only applies to vehicles owned and operated in the US.

If you believe that your vehicle has a defect which could cause a crash or could cause injury or death, you should immediately inform the National Highway Traffic Safety Administration NHTSA, in addition to notifying BMW of North America, LLC, P.O. Box 1227, Westwood, New Jersey 07675-1227, Telephone 1-800-831-1117.

If NHTSA receives similar complaints, it may open an investigation, and if it finds that a safety defect exists in a group of vehicles, it may order a recall and remedy campaign.

However, NHTSA cannot become involved in individual problems between you, your dealer, or BMW of North America, LLC.

To contact NHTSA, you may call the Vehicle Safety Hotline toll-free at 1-888-327-4236 (TTY: 1-800-424-9153); go to <http://www.safercar.gov>; or write to: Administrator, NHTSA, 400 Seventh Street, SW., Washington, DC 20590. You can also obtain other in-

formation about motor vehicle safety from <http://www.safercar.gov>.

### **For Canadian customers**

Canadian customers who wish to report a safety-related defect to Transport Canada, Defect Investigations and Recalls, may call the toll-free hotline 1-800-333-0510. You can also obtain other information about motor vehicle safety from <http://www.tc.gc.ca/roadsafety>.



## At a glance

These overviews of buttons, switches and displays are intended to familiarize you with your vehicle. Moreover, you will become familiar with the available control concepts and options quickly.

# Cockpit

## Vehicle features and options

This chapter describes all standard, country-specific and optional features offered with the series. It also describes features that are not necessarily available in your vehicle, e. g., due

to the selected options or country versions. This also applies to safety-related functions and systems. When using these functions and systems, the applicable country provisions must be observed.

## Functions and controls in the cockpit

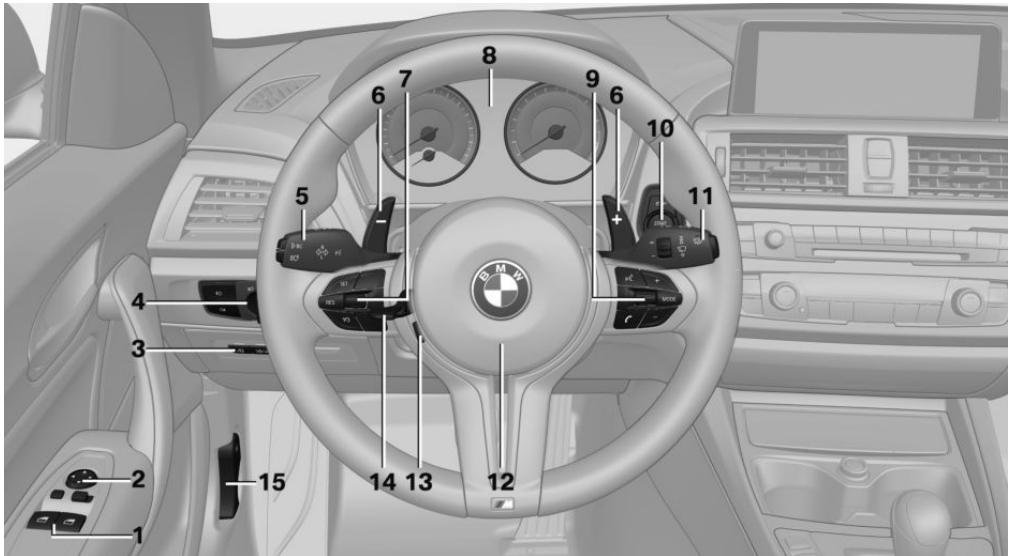

1 Power windows 45

2 Exterior mirror operation 57

3 Glove compartment on the driver's side 145

Driver assistance systems



Intelligent Safety 106



Lane departure warning 112

4 Lights



Light switch 93



Lights off





















Daytime running lights 95



Parking lights 93





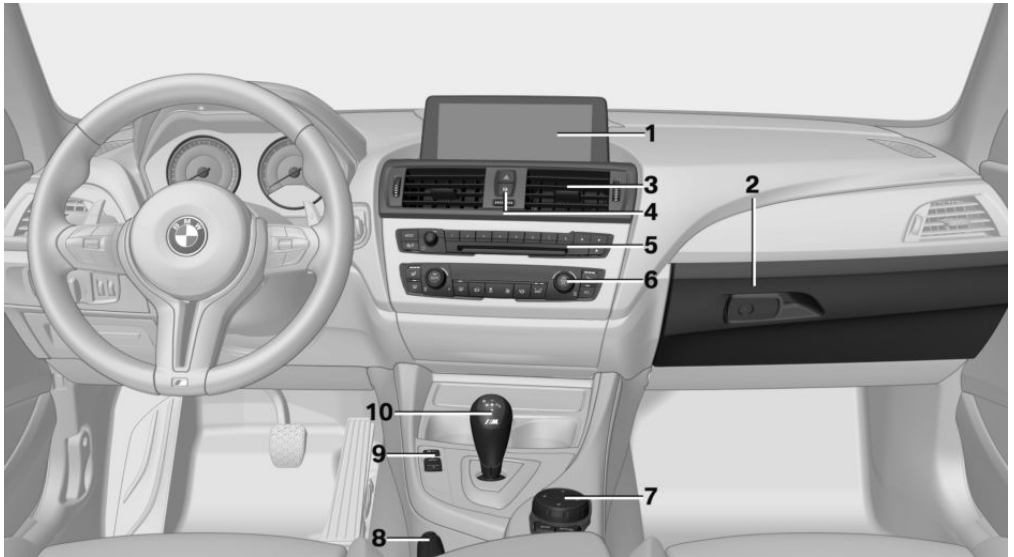

Low beams 93

-  Automatic headlamp control [94](#)  
Adaptive Light Control [95](#)  
High-beam Assistant [95](#)
-  Instrument lighting [96](#)
- 5** Steering column stalk, left
-  Turn signal [70](#)
-  High beams, headlight flasher [70](#)
-  High-beam Assistant [95](#)
-  Roadside parking lights [93](#)
-  Onboard computer [88](#)
- 6** M double-clutch transmission: shift paddles [75](#)
- 7** Steering wheel buttons, left
-  Cruise control on/off, interrupt [120](#)
-  Cruise control: store speed
-  Cruise control: resume speed
- Cruise control rocker switch
- 8** Instrument cluster [79](#)
- 9** Steering wheel buttons, right
-  Entertainment source, see Owner's Manual for Navigation, Entertainment and Communication [6](#)
-  Volume, see Owner's Manual for Navigation, Entertainment and Communication [6](#)
-  Voice activation [26](#)
-  Telephone, see Owner's Manual for Navigation, Entertainment and Communication [6](#)
- Thumbwheel for selection lists [88](#)
- 10**  Start/stop the engine and switch the ignition on/off [66](#)
-  Auto Start/Stop function [67](#)
- 11** Steering column stalk, right
-  Wiper [71](#)
-  Rain sensor [72](#)
-  Clean the windshield and headlights [72](#)
- 12**  Horn, entire surface
- 13**  Steering wheel heating [60](#)
- 14** Adjust the steering wheel [59](#)
- 15** Unlock hood [180](#)





## Functions and controls in the center console



- |   |  |     |    |  |     |
|---|--|-----|----|--|-----|
| 1 | Control Display  | 18  | 6  | Climate control  | 128 |
| 2 | Glove compartment  | 144 | 7  | Controller with buttons  | 19  |
| 3 | Ventilation  | 133 | 8  | Parking brake  | 70  |
| 4 |  Hazard warning system   | 196 | 9  |  Driving Dynamics Control   | 117 |
|   |  Central locking system | 38  |    |  Dynamic Stability Control | 115 |
| 5 | Radio/CD/multimedia, see Owner's Manual for Navigation, Entertainment and Communication                  | 6   | 10 | M double-clutch transmission, selector lever   | 75  |
|   |  |     |    | Manual transmission, selector lever  | 74  |

## All about the roofliner



- |   |   |   |   |   |                                    |
|---|---|---|---|---|------------------------------------|
| 1 |  | Intelligent emergency call <a href="#">196</a>                  | 4 |  | Reading lights <a href="#">96</a>  |
| 2 |  | Glass sunroof <a href="#">46</a>                                | 5 |  | Interior lights <a href="#">96</a> |
| 3 |  | Indicator lamp, front-seat passenger airbag <a href="#">101</a> |   |   |                                    |

# iDrive

## Vehicle features and options

This chapter describes all standard, country-specific and optional features offered with the series. It also describes features that are not necessarily available in your vehicle, e. g., due to the selected options or country versions. This also applies to safety-related functions and systems. When using these functions and systems, the applicable country provisions must be observed.

## Concept

The iDrive combines the functions of many switches. Thus, these functions can be operated from a central location.

## Safety information



### WARNING

Operating the integrated information systems and communication devices while driving can distract from traffic. It is possible to lose control of the vehicle. There is a risk of an accident. Only use the systems or devices when the traffic situation allows. If necessary, stop and use the systems and devices while the vehicle is stationary. ◀

## Overview of control elements

### Operation

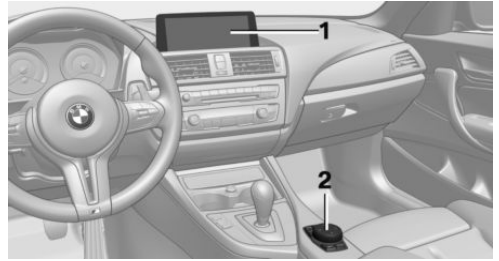

- 1 Control Display
- 2 Controller with buttons and, depending on the equipment version, with touchpad

### Control Display

#### General information

To clean the Control Display, follow the care instructions.

Do not place objects close to the Control Display; otherwise, the Control Display can be damaged.

In the case of very high temperatures on the Control Display, e.g., due to intense solar radiation, the brightness may be reduced down to complete deactivation. Once the temperature is reduced, e.g., through shadow or climate control system, the normal functions are restored.

#### Switching on

1. Switch on the ignition.
2. Press the controller.

#### Switching off

1.  Press button.

## 2. "Turn off control display"

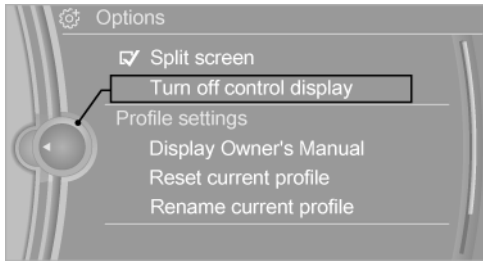

## Controller with navigation system

The buttons can be used to open the menus directly. The controller can be used to select menu items and enter the settings.

Some iDrive functions can be operated using the touchpad on the controller.

### 1. Turn.

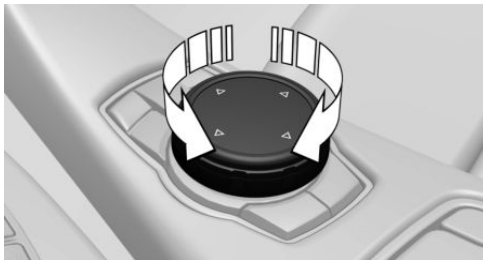

### 2. Press.



### 3. Move in four directions.

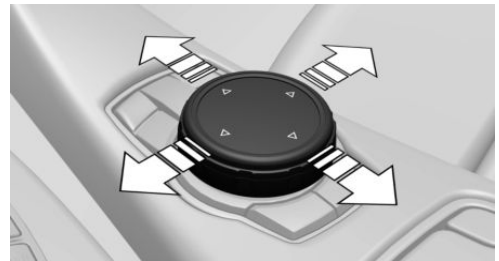

## Buttons on the controller

Button	Function
MENU	Opens the main menu.
RADIO	Opens the Radio menu.
MEDIA	Opens the Multimedia menu.
NAV	Opens the Navigation menu.
TEL	Opens the Phone menu.
BACK	Displays the previous panel.
OPTION	Open the Options menu.

## Controller without navigation system

The buttons can be used to open the menus directly. The controller can be used to select menu items and enter the settings.

### 1. Turn.

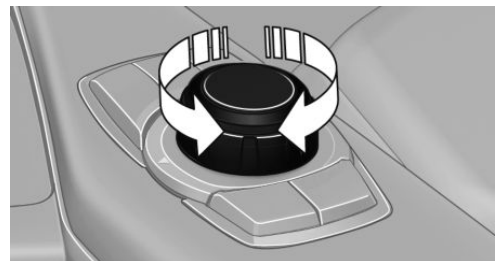

2. Press.

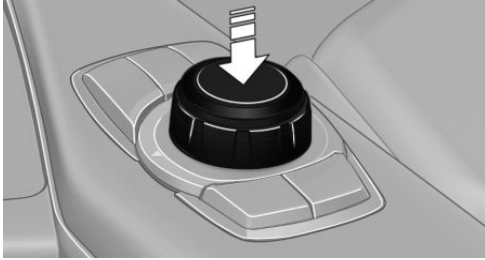

3. Move in two directions.

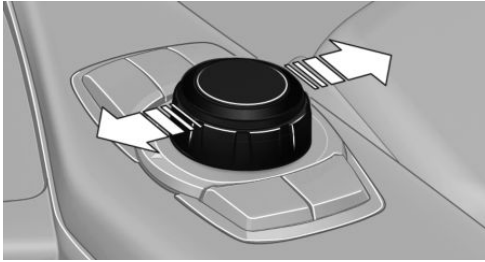

## Buttons on the controller

Button	Function
MENU	Opens the main menu.
AUDIO	Open audio menu last listened to, switch between audio menus.
TEL	Opens the Phone menu.
BACK	Open previous panel.
OPTION	Open the Options menu.

## Operating concept

### Opening the main menu

 Press button.

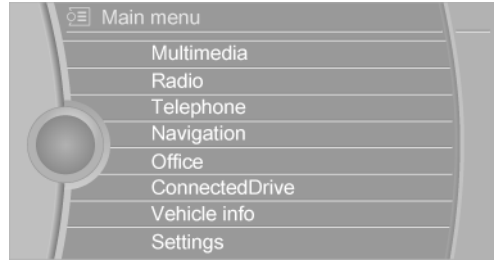

The main menu is displayed.

All iDrive functions can be called up via the main menu.

### Selecting menu items

Highlighted menu items can be selected.

1. Turn the controller until the desired menu item is highlighted.

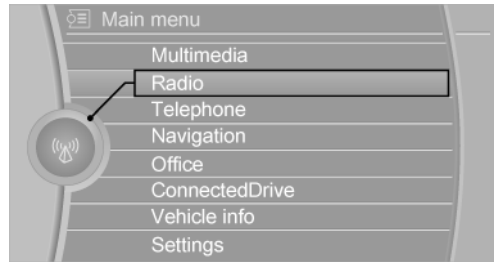

2. Press the controller.

### Menu items in the Owner's Manual

In the Owner's Manual, menu items that can be selected are set in quotation marks, e.g., "Settings".

### Changing between panels

After a menu item is selected, e.g., "Radio", a new panel is displayed. Panels can overlap.

- ▷ Move the controller to the left.  
Closes current panel and shows previous display.  
Reopens previous display by pressing BACK button. In this case, the current panel is not closed.
- ▷ Move the controller to the right.

Opens new panel on top of previous screen.

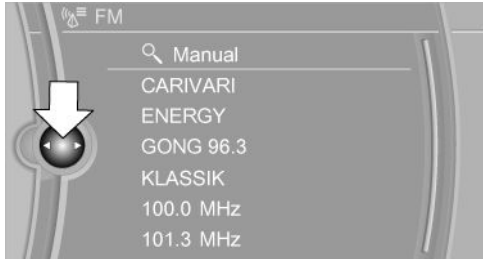

White arrows pointing to the left or right indicate that additional panels can be opened.

## Opening the Options menu

 Press button.

The "Options" menu is displayed.

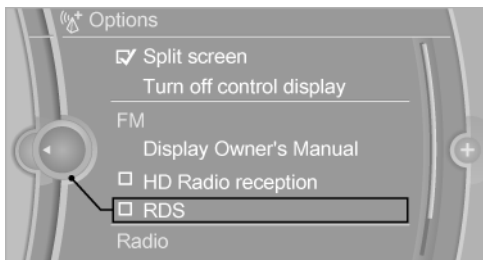

Additional options: move the controller to the right repeatedly until the "Options" menu is displayed.

## Options menu

The "Options" menu consists of various areas:

- ▶ Screen settings, e.g., "Split screen".
- ▶ Control options for the selected main menu, e.g., for "Radio".
- ▶ If applicable, further operating options for the selected menu, e.g., "Store station".

## Changing settings

1. Select a field.

2. Turn the controller until the desired setting is displayed.

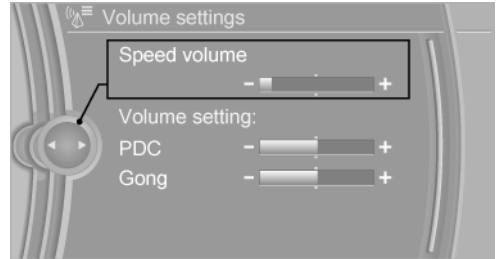

3. Press the controller.

## Activating/deactivating the functions

Several menu items are preceded by a check-box. It indicates whether the function is activated or deactivated. Selecting the menu item activates or deactivates the function.

- Function is activated.
- Function is deactivated.

## Touchpad

Some iDrive functions can be operated using the touchpad on the controller.

## Selecting functions

1. "Settings"
2. "Touchpad"
3. Select the desired function.
  - ▶ "Speller": enter letters and numbers.
  - ▶ "Interactive map": use the interactive map.
  - ▶ "Browser": enter Internet addresses.
  - ▶ "Audio feedback": pronounces entered letters and numbers.

## Entering letters and numbers

Entering letters requires some practice at the beginning. When entering, pay attention to the following:

- ▶ The system distinguishes between upper and lower-case letters and numbers. For entries, it may be necessary to change between upper and lower-case letters, numbers and characters, refer to page 25.
- ▶ Enter characters as they are displayed on the Control Display.
- ▶ Always enter associated characters, such as accents or periods so that the letter can be clearly recognized. The set language determines what input is possible. Where necessary, enter special characters via the controller.
- ▶ To delete a character, swipe to the left on the touchpad.
- ▶ To enter a blank space, swipe to the right in the center of the touchpad.
- ▶ To enter a hyphen, swipe to the right in the upper area of the touchpad.
- ▶ To enter an underscore, swipe to the right in the lower area of the touchpad.

## Using the interactive map and Internet

The interactive map in the navigation system and Internet pages can be moved using the touchpad.

Function	Operation
Move interactive map or Internet pages.	Swipe into respective direction.
Enlarge/shrink interactive map or Internet pages.	Drag in or out on the touchpad with fingers.
Display the menu or open a link on the Internet.	Tap once.

## Changing settings

You can use the touchpad to change Control Display settings, e.g., volume. Swipe left or right accordingly.

## Example: setting the clock

### Setting the clock

On the Control Display:

1.  Press button. The main menu is displayed.
2. Turn the controller until "Settings" is highlighted, and then press the controller.

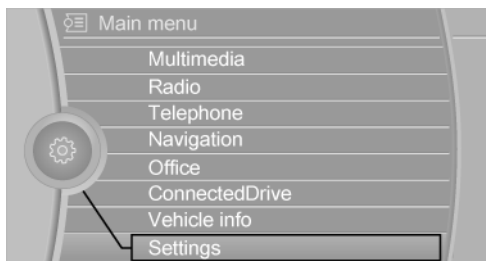

3. If necessary, move the controller to the left to display "Time/Date".
4. Turn the controller until "Time/Date" is highlighted, and then press the controller.



5. Turn the controller until "Time:" is highlighted, and then press the controller.



6. Turn the controller to set the hours, and then press the controller.
7. Turn the controller to set the minutes, and then press the controller.

## Status information

### Status field



The following information is displayed in the status field at the top right:

- ▷ Time.
- ▷ Current entertainment source.
- ▷ Sound output, on/off.
- ▷ Signal strength of cellular network.
- ▷ Phone status.
- ▷ Traffic bulletin reception.







### Status field symbols





The symbols are grouped as follows:

#### Radio symbols







Symbol	Meaning
	HD Radio station is being received.
	Satellite radio is switched on.

#### Telephone symbols



Symbol	Meaning
	Incoming or outgoing call.
	Missed call.
	Signal strength of cellular network. Symbol flashes: network search.
	Cellular network is not available.
	Bluetooth is switched on.
	Roaming is active.

Symbol	Meaning
	SMS text message received.
	Check the SIM card.
	SIM card is blocked.
	SIM card is missing.
	Enter PIN.

#### Entertainment symbols

Symbol	Meaning
	CD/DVD player.
	Music collection.
	Gracenote® database.
	AUX-IN port.
	USB audio interface.
	Mobile phone audio interface.

#### Additional symbols

Symbol	Meaning
	Spoken instructions are turned off.
	Checking the current vehicle position.

## Split screen

### General information

Additional information can be displayed on the right side of the split screen, e.g., information from the onboard computer.

In the divided screen view, the so-called split screen, this information remains visible even when switching to another menu.

## Switching the split screen on/off

On the Control Display:

1.  Press button.
2. "Split screen"

## Selecting the display

On the Control Display:

1.  Press button.
2. "Split screen"
3. Move the controller until the split screen is selected.
4. Press the controller or select "Split screen content".
5. Select the desired menu item.

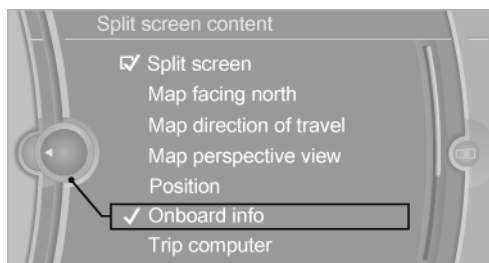

## Programmable memory buttons

### General information

The iDrive functions can be stored on the programmable memory buttons and called up directly, e.g., radio stations, navigation destinations, phone numbers and menu entries.

Settings are stored for the profile currently used.

### Without navigation system and telephone

Only radio stations can be stored on the buttons.

## Saving a function

1. Highlight the function via iDrive.
2.  Press and hold the desired button, until a signal sounds.

## Running a function

1.  Press button.
- The function will work immediately. This means, e.g., that the number is dialed when a phone number is selected.

## Displaying the key assignment

Touch buttons with finger. Do not wear gloves or use objects.

The button assignment is displayed at the top edge of screen.

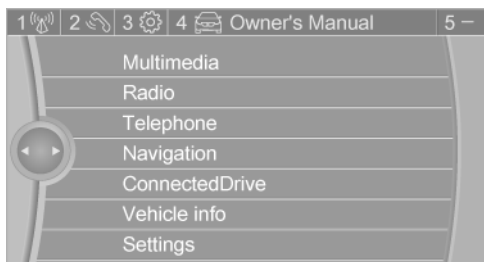

## Deleting the button assignments

1. Press buttons 1 and 8 simultaneously for approx. 5 seconds.
2. "OK"

## Deleting personal data in the vehicle

### Concept

Depending on the usage, the vehicle saves personal data, such as stored radio stations. This personal data can be permanently deleted using iDrive.

## General information

Depending on the equipment package, the following data can be deleted:

- ▶ Personal Profile settings.
- ▶ Stored radio stations.
- ▶ Stored Favorites buttons.
- ▶ Travel and onboard computer information.
- ▶ Music collection.
- ▶ Navigation, e.g., stored destinations.
- ▶ Phone book.
- ▶ Online data, e.g., Favorites, cookies.
- ▶ Voice notes.
- ▶ Login accounts.
- ▶ RemoteApp smartphone tethering.

Altogether, the deletion of the data can take up to 30 minutes.

## Functional requirement

Data can only be deleted while stationary.

## Deleting data

Heed and follow the instructions on the Control Display.

1. Switch on the ignition.
2. "Settings"
3. Open "Options".
4. "Delete personal data"
5. "Continue"
6. "OK"



## Entering letters and numbers

### General information

On the Control Display:

1. Turn the controller: select a letter or number.
2. Select additional letters or numbers, if needed.

3. "OK": confirm the entry.

Symbol	Function
	Press the controller: delete the letter or number.
	Press the controller for an extended period: delete all letters or numbers.

## Switching between upper/lower case, numbers and characters

Depending on the menu, you can switch between entering upper and lower case letters and numbers:

Symbol	Function
<b>A<sup>B</sup>C</b>	Enter the letters.
1@+	Enter the numbers.
abc or <b>ABC</b>	Tip the controller up.

## Without navigation system

@<sup>A</sup> A<sup>a</sup> a<sup>@</sup> Select the symbol.

## Entry comparison

When entering names and addresses, the choice is narrowed down with every letter entered and letters may be added automatically.

Entries are continuously compared with data stored in the vehicle.

- ▶ Only those letters are offered during entry for which data is available.
- ▶ Destination search: place names can be entered in all languages that are available on the Control Display.

# Voice activation system

## Vehicle features and options

This chapter describes all standard, country-specific and optional features offered with the series. It also describes features that are not necessarily available in your vehicle, e. g., due to the selected options or country versions. This also applies to safety-related functions and systems. When using these functions and systems, the applicable country provisions must be observed.

## Concept

- ▷ Most functions displayed on the Control Display can be operated by voice commands via the voice activation system. The system supports you with announcements during input.
- ▷ Functions that can only be used when the vehicle is stationary cannot be used via the voice activation system.
- ▷ The system uses a special microphone on the driver's side.
- ▷ ›...‹ in the Owner's Manual denotes verbal instructions to use with the voice activation system.

## Requirements

Via the Control Display, set a language that is also supported by the voice activation system so that the spoken commands can be identified.

Set the language, refer to page 91.

## Using the voice activation system

### Activating the voice activation system

1.  Press button on the steering wheel.
2. Wait for the signal.
3. Say the command.

A command that is recognized by the voice activation system is announced and displayed in the instrument cluster.

 This symbol in the instrument cluster indicates that the voice activation system is active. If no other commands are possible, operate the function via iDrive.

### Terminating the voice activation system

 Press the button on the steering wheel or ›Cancel‹.

## Possible commands

Most menu items on the Control Display can be voiced as commands.

The available commands depend on the menu that is currently displayed on the Control Display.

There are short commands for many functions. You may select list entries such as phone list entries via voice activation. Read these list entries out loud exactly as they are shown in the respective list.

### Having possible commands read aloud

You can have available commands read out loud for you: ›Voice commands‹.

E.g., if the "Settings" menu is displayed, the commands for the settings are read out loud.

## Executing functions using short commands

Execute functions on the main menu via short commands. It almost doesn't matter which menu item is selected, e.g., ›Vehicle status‹.

The list for short commands of the voice activation system can be called up via the Integrated Owner's Manual on the Control Display.

## Help dialog for the voice activation system

Calling up help dialog: ›Help‹.

Additional commands for the help dialog:

- ▷ ›Help with examples‹: announces information about the current operating options and the most important commands for them.
- ▷ ›Help with voice activation‹: announces information about the principle of operation for the voice activation system.

## Example: opening the tone settings

### Via the main menu

The commands of the menu items are spoken just as they are selected via the controller.

1. Turn on the Entertainment sound output, if needed.
2.  Press button on the steering wheel.
3. ›Radio‹
4. ›Tone‹

### Via short command

The desired tone settings can also be started via a short command.

1. Turn on the Entertainment sound output, if needed.
2.  Press button on the steering wheel.
3. ›Tone‹

## Setting the voice dialog

You can set the system to use standard dialog or a short version.

The short version of the voice dialog plays back short messages in abbreviated form.

1. "Settings"
2. "Language/Units"
3. "Speech type:"
4. Select setting.

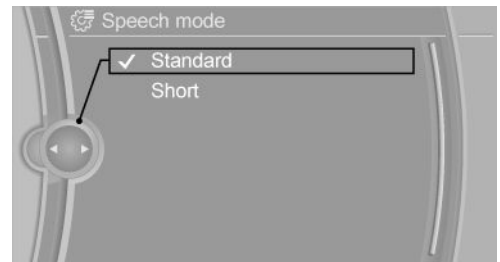

## Adjusting the volume

Turn the volume button during the spoken instructions until the desired volume is set.

- ▷ The volume remains constant even if the volume of other audio sources is changed.
- ▷ The volume is stored for the profile currently used.

## Information on Emergency Requests

Do not use the voice activation system to initiate an Emergency Request. In stressful situations, the voice and vocal pitch can change. This can unnecessarily delay the establishment of a phone connection.

Instead, use the SOS button, refer to page 196, close to the interior mirror.

## Environmental conditions

- ▷ Say the commands, numbers, and letters smoothly and with normal volume, emphasis, and speed.
- ▷ Always say commands in the language of the voice activation system.
- ▷ Keep the doors, windows, and glass sunroof closed to prevent noise interference.
- ▷ Avoid making other noise in the vehicle while speaking.

# Integrated Owner's Manual in the vehicle

## Vehicle features and options

This chapter describes all standard, country-specific and optional features offered with the series. It also describes features that are not necessarily available in your vehicle, e. g., due to the selected options or country versions. This also applies to safety-related functions and systems. When using these functions and systems, the applicable country provisions must be observed.

## Integrated Owner's Manual in the vehicle

The Integrated Owner's Manual can be displayed on the Control Display. It specifically describes features and functions found in the vehicle.

### Components of the Integrated Owner's Manual

The Integrated Owner's Manual consists of three parts, which offer various levels of information or possible access.

#### Quick Reference Guide

The Quick Reference Guide provides information on how to operate the vehicle, how to use basic vehicle functions and what to do in case of a breakdown. This information can also be displayed while driving.

#### Search by images

Based on illustrations, image search provides information and descriptions. This is useful, e.g., when the terminology for a feature is not known.

## Owner's Manual

Search for information and descriptions by entering terms selected from the index.

### Select components

1.  Press button.
2. Turn the controller: open "Vehicle info".
3. Press the controller.
4. Selecting desired range:
  - ▷ "Quick reference"
  - ▷ "Search by pictures"
  - ▷ "Owner's Manual"

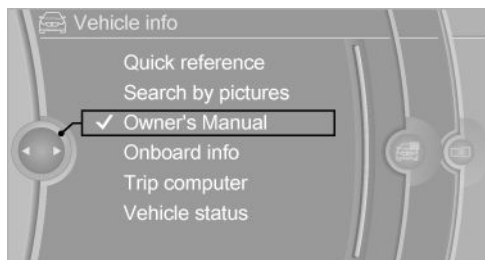

### Leafing through the Owner's Manual

#### Page by page with link access

Turn the controller until the next or previous page is displayed.

#### Page by page without link access

Scroll through the pages directly while skipping the links.

Highlight the symbol once. Now simply press the controller to browse from page to page.



Scroll back.



Scroll forward.

## Context help - operating instructions for the currently selected function

The relevant information can be opened directly.

### Opening via iDrive

To move directly from the application on the Control Display to the Options menu:

1.  Press button or move the controller to the right repeatedly until the "Options" menu is displayed.
2. "Display Owner's Manual"



### Opening when a Check Control message is displayed

Directly from the Check Control message on the Control Display:

"Display Owner's Manual"

### Changing between a function and the operating instructions

To switch from a function, e.g., radio, to the Owner's Manual on the Control Display and to alternate between the two displays:

1.  Press button or move the controller to the right repeatedly until the "Options" menu is displayed.
2. "Display Owner's Manual"
3. Select the desired page in the Owner's Manual.
4.  Press button again to return to last displayed function.
5.  Press button to return to the page of the Owner's Manual displayed last.

To alternate permanently between the last displayed function and the Owner's Manual repeat steps 4 & 5. Opens a new display every time.

## Programmable memory buttons

### General information

The Owner's Manual can be stored on the programmable memory buttons and called up directly.

### Storing

1. "Owner's Manual" Select via iDrive.
2.  Press selected button for more than 2 seconds.

### Executing

1.  Press button.  
The Owner's Manual is displayed immediately.





## Controls

The information in this chapter helps you in confidently operating your vehicle. All features and accessories that are useful for driving and your safety, comfort and convenience are described here.

# Opening and closing

## Vehicle features and options

This chapter describes all standard, country-specific and optional features offered with the series. It also describes features that are not necessarily available in your vehicle, e. g., due to the selected options or country versions. This also applies to safety-related functions and systems. When using these functions and systems, the applicable country provisions must be observed.

## Remote control

### General information

The vehicle is supplied with two remote controls with integrated key.

Each remote control contains a replaceable battery. Replace the battery, refer to page 36.

You may set the key functions depending on the optional features and country-specific version. Settings, refer to page 43.

The vehicle stores personal settings for every remote control. Personal Profile, refer to page 41.

The remote controls hold information about required maintenance. Service data in the remote control, refer to page 187.

### Safety information

#### ! WARNING

People or animals in the vehicle can lock the doors from the inside and lock themselves in. The vehicle can then not be opened from the outside. There is a risk of injury. Take the remote control with you so that the vehicle can be opened from the outside. ◀

#### ! WARNING

Unlocking from the inside is only possible with special knowledge.

If people must spend a longer time in the vehicle while it is very hot or cold outside, there is a risk of injury or danger to life. Do not lock the vehicle from the outside when there are people in it. ◀

#### ! WARNING

Unattended children or animals can cause the vehicle to move and endanger themselves and traffic, e.g., due to the following actions:

- ▷ Pressing the Start/Stop button.
- ▷ Releasing the parking brake.
- ▷ Opening and closing the doors or windows.
- ▷ Engaging selector lever position N.
- ▷ Using vehicle equipment.

There is a risk of accidents or injuries. Do not leave children or animals unattended in the vehicle. Take the remote control with you when exiting and lock the vehicle. ◀

### Overview

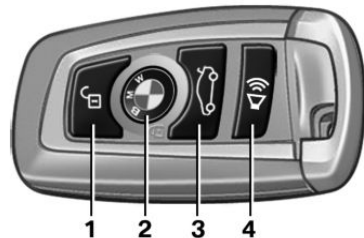

- 1 Unlock
- 2 Lock
- 3 Unlocking the tailgate
- 4 Panic mode

## Unlocking



Press button on the remote control.

Depending on the settings, refer to page 43, the following access points are unlocked.

- ▷ Driver's door and fuel filler flap.
- ▷ All doors, tailgate, and fuel filler flap.

In addition, the following functions are executed:

- ▷ The settings saved in the driver profile, refer to page 41, are applied.
- ▷ The interior lights and courtesy lamps are activated. This function is not available, if the interior lamps were switched off manually.
- ▷ The welcome lights are switched on, if this function was activated.
- ▷ The alarm system, refer to page 44, is switched off.

The light functions may depend on the ambient brightness.

## Convenient opening



Press and hold this button on the remote control after unlocking.

The windows and the glass sunroof are opened, as long as the button on the remote control is pressed.

## Locking

1. Close the driver's door.
2.  Press button on the remote control.
  - ▷ All doors, the tailgate, and the fuel filler flap are being locked.
  - ▷ The alarm system, refer to page 44, is switched on.

If the vehicle horn honks twice when you lock the vehicle, this means that the engine or ignition is still switched on. In this case, switch off

the engine or the ignition using the Start/Stop button.

## Lock



Press button on the remote control with the vehicle locked.

This function is not available, if the interior lamps were switched off manually.

The light functions may depend on the ambient brightness.

If the button is pressed again within 10 seconds after vehicle was locked, the interior motion sensor and tilt alarm sensor of the anti-theft warning system, refer to page 45, are turned off. After locking, wait 10 seconds before pressing the button again.

## Tailgate

### General information

To avoid locking it into the vehicle, do not place the remote control in the cargo area.

Depending on your vehicle's equipment and the country version, it is possible to specify whether the doors are also unlocked when unlocking with the remote control. Create the settings, refer to page 43.

### Safety information



#### WARNING

Body parts can be jammed when operating the tailgate. There is a risk of injury. Make sure that the area of movement of the tailgate is clear during opening and closing. ◀



#### NOTE

During opening, the tailgate pivots back and up. There is a risk of property damage. Make sure that the area of movement of the tailgate is clear during opening and closing. ◀

## Opening



Press button on the remote control for approx. 1 second.

## Panic mode

You can trigger the alarm system if you find yourself in a dangerous situation.



Press button on the remote control for at least 3 seconds.

To switch off the alarm: press any button.

## Replacing the battery

1. Remove the integrated key from the remote control, refer to page 37.
2. Place the integrated key underneath the battery compartment cover, arrow 1, and lift the cover with a lever movement of the integrated key, arrow 2.

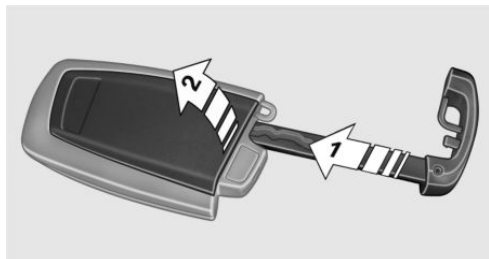

3. Using a pointed object, press battery in direction of arrow and lift it out.

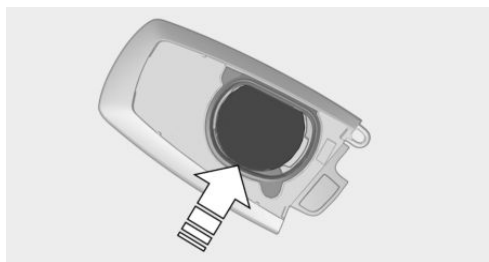

4. Insert a type CR 2450 battery with the positive side facing up.
5. Press the cover closed.



Have old batteries disposed of by a dealer's service center or another qualified service center or repair shop or take them to a collection point.

## New remote controls

New remote controls are available from a dealer's service center or another qualified service center or repair shop.

## Blocking remote controls

A lost remote control can be blocked by a dealer's service center or another qualified service center or repair shop.

## Malfunction

### General information

A Check Control message is displayed.

Remote control detection by the vehicle may malfunction under the following circumstances:

- ▷ The battery of the remote control is discharged. Replace the battery, refer to page 36.
- ▷ Interference of the radio connection from transmission towers or other equipment with high transmitting power.
- ▷ Shielding of the remote control due to metal objects.

Do not transport the remote control together with metal objects.

- ▷ Interference of the radio connection from mobile phones or other electronic devices in direct proximity to the remote control.

Do not transport the remote control together with electronic devices.

- ▷ Interference of radio transmission by a charging process of a mobile device, e.g., charging of a mobile phone.

In the case of interference, the vehicle can be unlocked and locked from the outside with the integrated key, refer to page 37.

## Starting the engine via emergency detection of the remote control

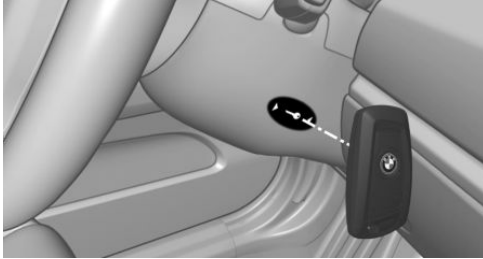

1. Hold the remote control with its back against the marked area on the steering column.
  2. Start the engine within 10 seconds.
- If the remote control is not detected, slightly change the position of the remote control and repeat the procedure.

## Integrated key

### General information

The driver's door can be locked and unlocked without remote control using the integrated key.

The integrated key can also be used for the glove compartment on the front passenger side.

### Safety information



#### WARNING

Unlocking from the inside is only possible with special knowledge.

If people must spend a longer time in the vehicle while it is very hot or cold outside, there is a risk of injury or danger to life. Do not lock the vehicle from the outside when there are people in it. ◀



#### NOTE

The door lock is permanently joined with the door. The door handle can be moved. When pulling the door handle with the integrated key inserted, paint or key can be damaged. There is a risk of property damage. Remove the integrated key before pulling the outside door handle. ◀

### Removing

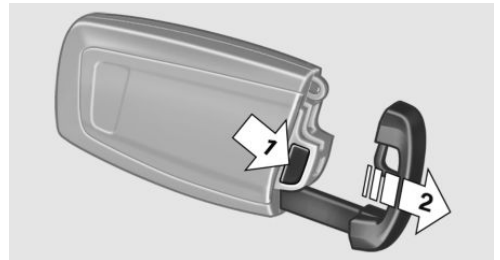

Press button, arrow 1, and remove key, arrow 2.

### Locking/unlocking via the door lock

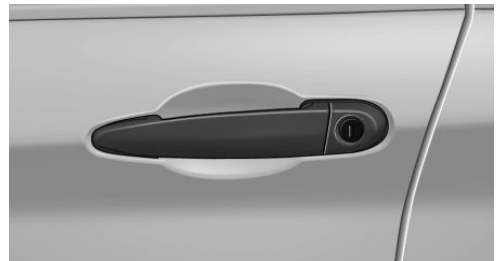

Unlock or lock the driver's door via the door lock using the integrated key.

The other doors must be unlocked or locked from the inside.

### Alarm system

The alarm system is not switched on if the vehicle is locked with the integrated key.

The alarm system is triggered when the door is opened, if the vehicle has been unlocked via the door lock.

In order to stop this alarm, unlock vehicle with the remote control or switch on the ignition, if needed, through emergency detection of the remote control, refer to page 37.

## Button for central locking system

### General information

In the event of a severe accident, the vehicle is automatically unlocked. The hazard warning system and interior lights come on.

### Overview

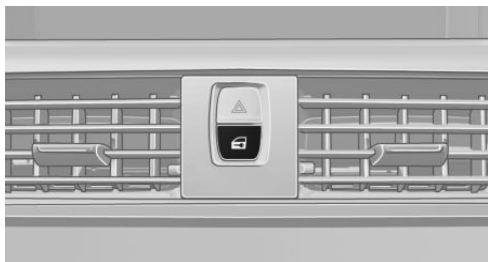

Button for the central locking system.

### Unlocking and locking

Pressing the central locking system button locks or unlocks the vehicle with the doors closed.

- ▷ The fuel filler flap remains unlocked.
- ▷ The vehicle is not secured against theft when locking.

### Unlocking and opening

- ▷  Press the central locking system button to unlock the doors together, and then pull the door handle above the armrest.

- ▷ On the door to be opened, pull the door handle twice: the first time unlocks the door, the second time opens it. The other doors remain locked.

## Comfort Access

### Concept

The vehicle can be accessed without activating the remote control.

All you need to do is to have the remote control with you, such as in your pants pocket.

The vehicle automatically detects the remote control when it is in close proximity or in the vehicle's interior.

### General information

Comfort Access supports the following functions:

- ▷ Unlocking/locking of the vehicle.
- ▷ Convenient closing.
- ▷ Opening tailgate.

### Functional requirements

- ▷ To lock the vehicle, the remote control must be located outside of the vehicle near the doors.
- ▷ The next unlocking and locking cycle is not possible until after approx. 2 seconds.

### Unlocking

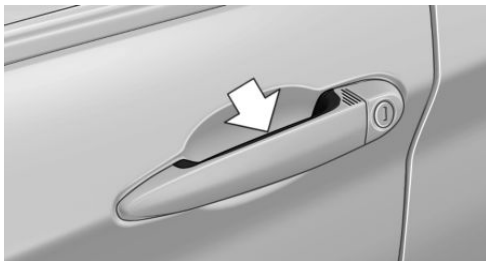

Grasp the door handle on the driver's or front passenger door completely, arrow.

This corresponds with pressing the button  on the remote control.

## Locking

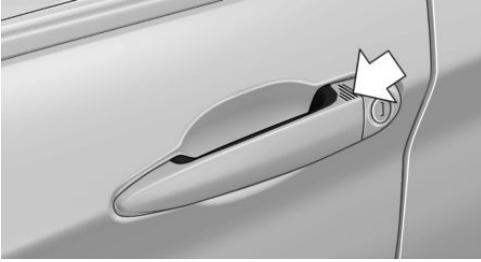

Touch the surface on the door handle of the driver's or front passenger door, arrow, with your finger for approx. 1 second without grasping the door handle.

This corresponds with pressing the button  on the remote control.

## Convenient closing

### Safety information

#### WARNING

With convenient closing, body parts can be jammed. There is a risk of injury. Make sure that the area of movement of the doors is clear during convenient closing. ◀

## Closing

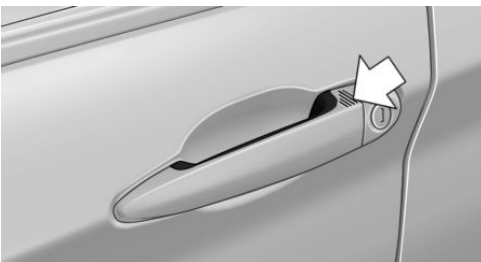

Touch the surface on the door handle of the driver's or front passenger door, arrow, with your finger and hold it there without grasping the door handle.

This corresponds with pressing and holding the button  on the remote control.

In addition to locking, the windows and the glass sunroof close and the exterior mirrors fold in.

## Open tailgate

### General information

If you open the tailgate via Comfort Access, locked doors will not be unlocked.

To avoid locking it in the vehicle, do not place the remote control in the cargo area.

### Safety information

#### WARNING

Body parts can be jammed when operating the tailgate. There is a risk of injury. Make sure that the area of movement of the tailgate is clear during opening and closing. ◀

#### NOTE

During opening, the tailgate pivots back and up. There is a risk of property damage. Make sure that the area of movement of the tailgate is clear during opening and closing. ◀

## Opening

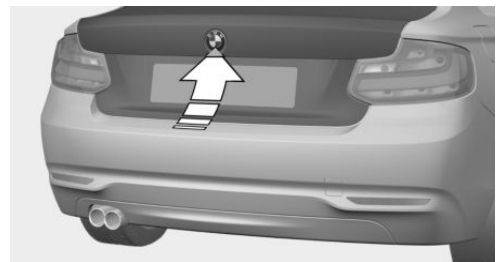

Press button on the tailgate.

The tailgate opens slightly and can be swung upward.

## Malfunction

Remote control detection by the vehicle may malfunction under the following circumstances:

- ▷ The battery of the remote control is discharged. Replace the battery, refer to page 36.
- ▷ Interference of the radio connection from transmission towers or other equipment with high transmitting power.
- ▷ Shielding of the remote control due to metal objects.  
Do not transport the remote control together with metal objects.
- ▷ Interference of the radio connection by mobile phones or other electronic devices in direct proximity of the remote control.  
Do not transport the remote control together with electronic devices.

In the case of a malfunction, unlock and lock the vehicle using the buttons of the remote control or using the integrated key, refer to page 37.

## Tailgate

### General information

To avoid locking it into the vehicle, do not place the remote control in the cargo area.

Depending on your vehicle's equipment and the country version, it is possible to specify whether the doors are also unlocked when unlocking with the remote control. Create the settings, refer to page 43.

### Safety information

#### WARNING

Body parts can be jammed when operating the tailgate. There is a risk of injury. Make sure that the area of movement of the tailgate is clear during opening and closing. ◀

#### NOTE

During opening, the tailgate pivots back and up. There is a risk of property damage. Make sure that the area of movement of the tailgate is clear during opening and closing. ◀

## Opening and closing

### Opening from the outside

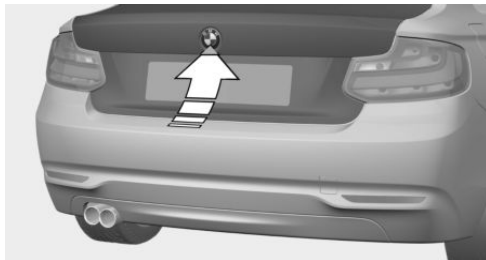

- ▷ Without Comfort Access: unlock the vehicle.  
Press on the top half of the BMW label.
- ▷  Press button on the remote control for approx. 1 second.  
As the case may be, the doors are also unlocked. Unlocking with the remote control, refer to page 35.

The tailgate opens slightly and can be swung upward.

### Opening from the inside

- ▷  With the vehicle stationary, press the button in the driver's floor area.

## Closing

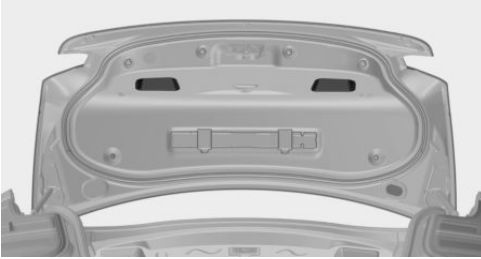

Grasp the recess grip and pull tailgate down.

## Locking separately

The tailgate can be locked separately using the switch in the glove compartment. If the glove compartment is locked, the tailgate cannot be opened.



- ▷ Tailgate secured, arrow 1.
- ▷ Tailgate not secured, arrow 2.

Slide the switch into the arrow 1 position. The tailgate is secured and disconnected from the central locking system.

This is beneficial when the vehicle is parked using valet service. The remote control can be handed out without the integrated key.

## Emergency unlocking



Pull the handle inside the cargo area.

The tailgate unlocks.

## Personal Profile

### Concept

Using Personal Profile, individual settings for several drivers can be saved and called up again at a later time.

### General information

There are three driver profiles with which personal vehicle settings can be stored. Every remote control has one of these driver profiles assigned.

If the vehicle is unlocked using a remote control, the assigned personal driver profile will be activated. All settings stored in the driver profile are automatically applied.

If several drivers use their own remote control, the vehicle will adjust the personal settings during unlocking. These settings are also restored, if the vehicle has been used in the meantime by a person with a different remote control.

Changes to the settings are automatically saved in the driver profile currently activated.

If another driver profile is selected via iDrive, the settings saved in it will be applied automatically. The new driver profile is assigned to the remote control currently used.

There is an additional profile available that is not assigned to any remote control: It can be used to apply settings in the vehicle without changing the personal driver profiles.

### Settings

The settings for the following systems and functions are saved in the active profile. The scope of storable settings depends on country and equipment.

- ▷ Unlocking and locking.
- ▷ Lights.
- ▷ Climate control.
- ▷ Radio.
- ▷ Instrument cluster.

- ▷ Programmable memory buttons.
- ▷ Volumes, tone.
- ▷ Control Display.
- ▷ Navigation.
- ▷ Park Distance Control PDC.
- ▷ Rearview camera.
- ▷ Driving Dynamics Control.
- ▷ Driver's seat position, exterior mirror position, steering wheel position.
- ▷ Intelligent Safety.

## Profile management

### Opening profiles

Regardless of the remote control in use, a different profile may be activated. This allows you to call up personal vehicle settings if you did not unlock the vehicle with your own key.

Via iDrive:

1. "Settings"
  2. "Profiles"
  3. Select a profile.
- ▷ All settings stored in the called-up profile are automatically applied.
  - ▷ The called-up profile is assigned to the remote control being used at the time.
  - ▷ If the profile is already assigned to a different remote control, this profile will apply to both remote controls.

### Using the guest profile

The guest profile is for individual settings that are saved in none of the three personal profiles.

This can be useful for drivers who are using the vehicle temporarily and do not have their own profile.

On the Control Display:

1. "Settings"
2. "Profiles"

3. "Guest"

The guest profile cannot be renamed. It is not assigned to the current remote control.

### Renaming profiles

A personal name can be assigned to every profile to avoid confusion between the profiles.

On the Control Display:

1. "Settings"
2. "Profiles"
3. Open "Options".
4. "Rename current profile"

### Reset profiles

The settings of the active profile are reset to their factory settings.

On the Control Display:

1. "Settings"
2. "Profiles"
3. Open "Options".
4. "Reset current profile"

### Exporting profiles

Most settings of the active profile can be exported.

This can be helpful for saving and retrieving personal settings, e.g., before delivering the vehicle to a workshop. Profiles can be taken to another vehicle equipped with the Personal Profile function.

On the Control Display:

1. "Settings"
2. "Profiles"
3. "Export profile"
4. BMW Online: "BMW Online"  
USB interface: "USB device"

Popular file systems for USB media are supported. FAT32 and exFAT are the recommended formats for profile export. Other formats may not support the export.

## Importing profiles

Profiles exported via BMW Online can also be imported via BMW Online.

Profiles stored on a USB storage device can be imported via the USB interface.

Existing settings are overwritten with the imported profile.

On the Control Display:

1. "Settings"
2. "Profiles"
3. "Import profile"
4. BMW Online: "BMW Online"  
USB interface: "USB device"

## Display profile list during start

The profile list can be displayed during each start to select the desired profile.

On the Control Display:

1. "Settings"
2. "Profiles"
3. Open "Options".
4. "Display user list at startup"

## Settings

### General information

Depending on the equipment and country-specific variant of your vehicle, different opening and closing settings are available.

These settings are saved in the active driver profile, refer to page 41.

### Unlocking

#### Doors

1. "Settings"
2. "Doors/key"
3.  Select the symbol.
4. Select the desired function:

- ▶ "Driver's door only"

Only the driver's door and the fuel filler flap are unlocked. Pressing again unlocks the entire vehicle.

- ▶ "All doors"

The entire vehicle is unlocked.

### Tailgate

1. "Settings"
2. "Doors/key"
3.  Select the symbol.
4. Select the desired function:

- ▶ "Tailgate"

The tailgate unlocks.

- ▶ "Tailgate + door(s)"

The tailgate and the doors are unlocked.

### Confirmation signals from the vehicle

1. "Settings"
2. "Doors/key"
3. Deactivate or activate the desired confirmation signals.

- ▶ With alarm system:

"Acoustic sig. lock/unlock"

Unlocking is signaled by one honk of the horn.

- ▶ "Flash when lock/unlock"

Unlocking is signaled by two flashes, locking by one.

### Automatic locking

1. "Settings"
2. "Doors/key"
3. Select the desired function:

- ▶ "Lock if no door is opened"

The vehicle locks automatically after a short period of time if no door is opened after unlocking.

- ▶ "Lock after start driving"

The vehicle locks automatically after you drive off.

## Adjusting the last seat and mirror position

1. "Settings"
2. "Doors/key"
3. "Last seat position autom."

When the vehicle is unlocked, the driver's seat and exterior mirrors resume their last set positions.

## Alarm system

### General information

When the vehicle is locked, the vehicle alarm system reacts to the following changes:

- ▷ Unauthorized opening of a door, the hood or the tailgate.
- ▷ Movements in the interior.
- ▷ Changes in the vehicle tilt, e. g., during attempts at stealing a wheel or when towing the vehicle.
- ▷ Disconnected battery voltage.

The alarm system signals these changes visually and acoustically:

- ▷ Acoustic alarm.
- ▷ By switching on the hazard warning system.
- ▷ By flashing the daytime running lights.

### Switching on and off

When you lock and unlock the vehicle with the remote control or with Comfort Access, the alarm system is switched on and off at the same time.

### Door lock with the alarm system switched on

The alarm system is triggered when the door is opened, if the vehicle has been unlocked via the door lock.

Switching off the alarm, refer to page 45.

### Tailgate with the alarm system switched on

The tailgate can be opened even when the alarm system is switched on.

After the tailgate is closed, it is locked and monitored again provided the doors are locked. The hazard warning system flashes once.

### Panic mode

You can trigger the alarm system if you find yourself in a dangerous situation.



Press button on the remote control for at least 3 seconds.

To switch off the alarm: press any button.

### Indicator lamp on the interior mirror

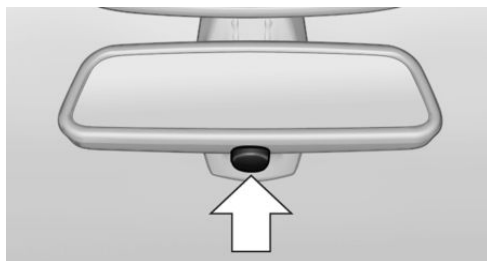

- ▷ The indicator lamp flashes briefly every 2 seconds:  
The alarm system is switched on.
- ▷ Indicator lamp flashes for approx. 10 seconds, then it flashes briefly every 2 seconds:

Interior motion sensor and tilt alarm sensor are not active, as doors, hood, or tailgate

are not correctly closed. Correctly closed access points are secured.

When the still open access points are closed, interior motion sensor and tilt alarm sensor will be switched on.

- ▷ The indicator lamp goes out after unlocking:

  - The vehicle has not been tampered with.

- ▷ The indicator lamp flashes after unlocking until the engine ignition is switched on, but no longer than approx. 5 minutes:

  - An alarm has been triggered.

### Tilt alarm sensor

The tilt of the vehicle is monitored.

The alarm system responds in situations such as attempts to steal a wheel or when the vehicle is towed.

### Interior motion sensor

The windows and the glass sunroof must be closed for the system to function properly.

## Avoiding unintentional alarms

### General information

The tilt alarm sensor and interior motion sensor can trigger an alarm, although no unauthorized action occurred.

Possible situations for an unwanted alarm:

- ▷ In automatic vehicle washes.
- ▷ In duplex garages.
- ▷ During transport on trains carrying vehicles, at sea or on a trailer.
- ▷ With animals in the vehicle.

The tilt alarm sensor and the interior motion sensor can be switched off in such situations.

## Switching off the tilt alarm sensor and interior motion sensor



Press the remote control button again within 10 seconds as soon as the vehicle is locked.

The indicator lamp lights up for approx. 2 seconds and then continues to flash.

The tilt alarm sensor and interior motion sensor are turned off until the vehicle is locked again.

## Switching off the alarm

- ▷ Unlock the vehicle with the remote control or switch on the ignition, if needed through emergency detection of remote control, refer to page 36.
- ▷ With Comfort Access:  
If you are carrying the remote control on your person, grasp the door handle on the driver's or front passenger door completely.

## Power windows

### Safety information



#### WARNING

When operating the windows, body parts and objects can be jammed. There is a risk of injury or risk of property damage. Make sure that the area of movement of the windows is clear during opening and closing. ◀



#### WARNING

Unattended children or animals can cause the vehicle to move and endanger themselves and traffic, e.g., due to the following actions:

- ▷ Pressing the Start/Stop button.
- ▷ Releasing the parking brake.
- ▷ Opening and closing the doors or windows.

- ▷ Engaging selector lever position N.
- ▷ Using vehicle equipment.



There is a risk of accidents or injuries. Do not leave children or animals unattended in the vehicle. Take the remote control with you when exiting and lock the vehicle. ◀

## Overview





 Power windows

## Opening

- ▷  Press the button to the resistance point.  
The window opens while the switch is held.
- ▷  Press the switch beyond the resistance point.  
The window opens automatically. Pressing the switch again stops the motion.

Convenient opening via the remote control, refer to page 35.

## Closing

- ▷  Pull the switch to the resistance point.  
The window closes while the switch is held.
- ▷  Pull the switch beyond the resistance point.

The window closes automatically. Pulling again stops the motion.

Closing by means of Comfort Access, refer to page 39.

## Pinch protection system

### General information

If closing force exceeds a specific threshold as a window closes, closing is interrupted.



The window reopens slightly.

### Safety information

 **WARNING**  
Accessories on the windows such as antennas can impact jam protection. There is a risk of injury. Do not install accessories in the area of movement of the windows. ◀

## Closing without the pinch protection system

In case of danger from the outside or if ice might prevent normal closing, proceed as follows:

1.  Pull the switch past the resistance point and hold it there.  
The pinch protection is limited and the window reopens slightly if the closing force exceeds a certain threshold.
2.  Pull the switch past the resistance point again within approx. 4 seconds and hold it there.  
The window closes without jam protection.

## Glass sunroof, electric

### General information

The glass sunroof and the sliding visor can be operated together or separately using the same switch.

The glass sunroof is operational when the ignition is switched on.

## Safety information

### WARNING

Body parts can be jammed when operating the glass sunroof. There is a risk of injury. Make sure that the area of movement of the glass sunroof is clear during opening and closing. ◀

### WARNING

Unattended children or animals can cause the vehicle to move and endanger themselves and traffic, e.g., due to the following actions:

- ▷ Pressing the Start/Stop button.
- ▷ Releasing the parking brake.
- ▷ Opening and closing the doors or windows.
- ▷ Engaging selector lever position N.
- ▷ Using vehicle equipment.

There is a risk of accidents or injuries. Do not leave children or animals unattended in the vehicle. Take the remote control with you when exiting and lock the vehicle. ◀

## Overview



## Tilting the glass sunroof

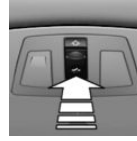

Push switch briefly upward.

- ▷ The closed glass sunroof is tilted.
- ▷ The opened glass sunroof closes until it is in its tilted position. The sliding visor does not move.

## Opening/closing the glass sunroof and sliding visor together

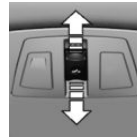

- ▷ Press the switch in the desired direction to the resistance point and hold it there. Glass sunroof and sliding visor open together as long as the switch is held down. The glass sunroof closes as long as the switch is held down. The sliding visor can be manually closed.

- ▷ Press the switch in the desired direction past the resistance point. The glass sunroof and sliding visor open automatically. The glass sunroof closes automatically. The sliding visor can be manually closed. Pressing the switch upward stops the motion.

Convenient opening via the remote control, refer to page 35.

Closing by means of Comfort Access, refer to page 38.

## Comfort position

If the glass sunroof is not completely opened automatically, the comfort position has been attained. In this position the wind noises in the interior are the least.

If desired, continue the movement by pressing the switch.

## Pinch protection system

### General information

If the closing force when closing the glass sunroof exceeds a certain value, the closing movement is stopped, beginning at approximately the middle of the opening in the roof, or from the tilted position during closing. The glass sunroof reopens slightly.

### Closing from the open position without pinch protection

If there is an external danger, proceed as follows:

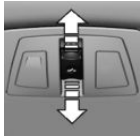

1. Press the switch forward beyond the resistance point and hold.

The pinch protection is limited and the glass sunroof reopens slightly if the closing force exceeds a certain threshold.

2. Press the switch forward again beyond the resistance point and hold until the glass sunroof closes without jam protection. Make sure that the closing area is clear.

### Closing from the raised position without pinch protection

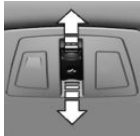

If there is an external danger, push the switch forward past the resistance point and hold it.

The glass sunroof closes without jam protection.

## Initializing after a power interruption

### General information

After a power failure during the opening or closing process, the glass sunroof can only be operated to a limited extent.

The system can be initialized when the vehicle is stationary and the engine is running.

During the initialization, the glass sunroof closes without jam protection.

Make sure that the closing area is clear.

### Initializing the system

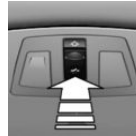

Press the switch up and hold it until the initialization is complete:

Initialization begins within 15 seconds and is completed when the glass sunroof is completely closed.

# Settings

## Vehicle features and options

This chapter describes all standard, country-specific and optional features offered with the series. It also describes features that are not necessarily available in your vehicle, e. g., due to the selected options or country versions. This also applies to safety-related functions and systems. When using these functions and systems, the applicable country provisions must be observed.

## Sitting safely

An ideal seating position that meets the needs of the occupants can make a vital contribution to relaxed, fatigue-free driving.

The seating position also plays an important role in an accident in combination with:

- ▶ Safety belts, refer to page 53.
- ▶ Head restraints, refer to page 54.
- ▶ Airbags.

## Seats

### Safety information

**!** **WARNING**  
Seat adjustments while driving can lead to unexpected movements of the seat. Vehicle control could be lost. There is a risk of an accident. Only adjust the seat on the driver's side when the vehicle is stationary. ◀

**!** **WARNING**  
With a backrest inclined too far to the rear, the protective effect of the safety belt cannot be ensured anymore. There is a risk of sliding under the safety belt in an accident. There is a risk of injuries or danger to life. Adjust the seat prior to starting the trip. Adjust

the backrest so that it is in the most upright position as possible and do not adjust again while driving. ◀

**!** **WARNING**  
There is a risk of jamming when moving the seats. There is a risk of injury or risk of property damage. Make sure that the area of movement of the seat is clear prior to any adjustment. ◀

## Manually adjustable seats

### Overview

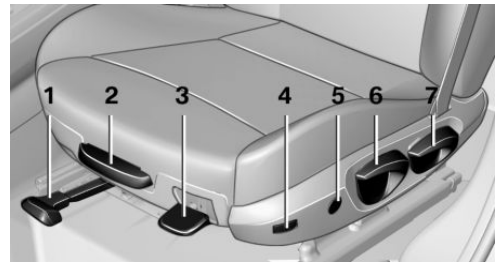

- 1 Forward/backward
- 2 Thigh support
- 3 Seat tilt
- 4 Backrest width
- 5 Lumbar support
- 6 Height
- 7 Backrest tilt

## Forward/backward

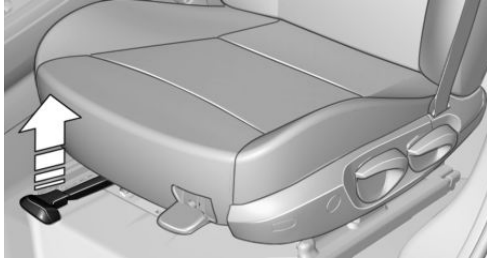

Pull the lever and slide the seat in the desired direction.

After releasing the lever, move the seat forward or back slightly making sure it engages properly.

## Seat tilt

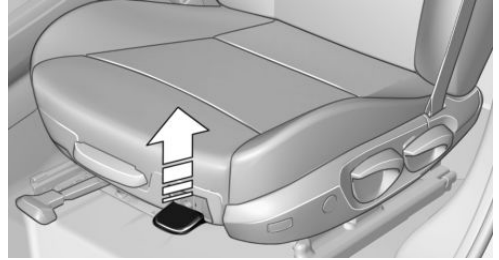

Pull the lever and move the seat to the desired tilt. After releasing the lever, apply your weight to the seat or lift it off to make sure the seat engages properly.

## Height

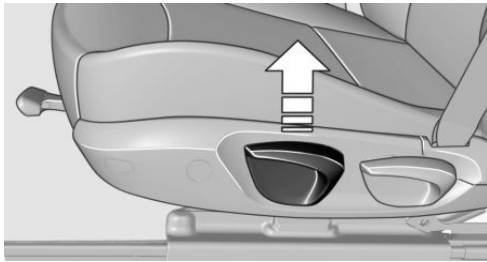

Pull the lever and apply your weight to the seat or lift it off, as necessary.

## Backrest tilt



Pull the lever and apply your weight to the backrest or lift it off, as necessary.

## Electrically adjustable seats

### Overview

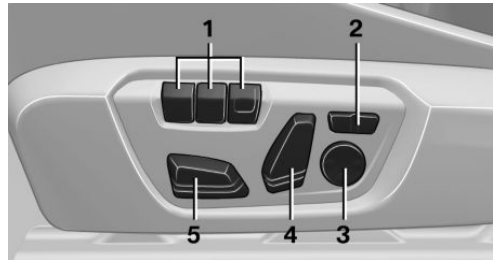

- 1 Seat and mirror memory
- 2 Backrest width
- 3 Lumbar support
- 4 Backrest tilt
- 5 Forward/backward, height, seat tilt

### General information

The seat setting for the driver's seat is stored for the profile currently used. When the vehicle is unlocked via the remote control, the position is automatically retrieved if the function is activated for this purpose.

### Forward/backward

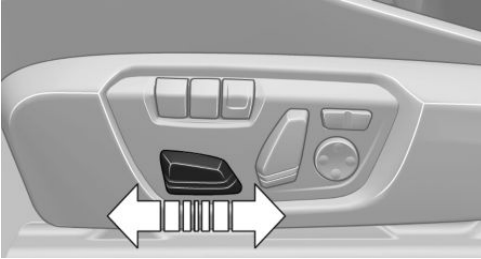

Push switch forward or backward.

### Backrest tilt

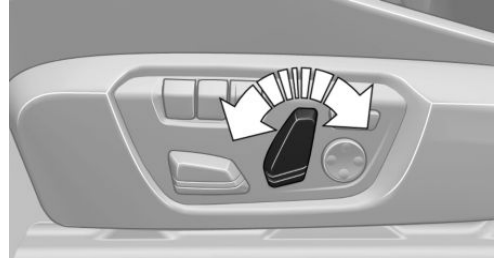

Move switch forward or backward.

### Height

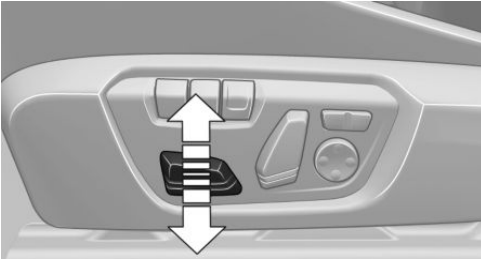

Push switch up or down.

### Thigh support

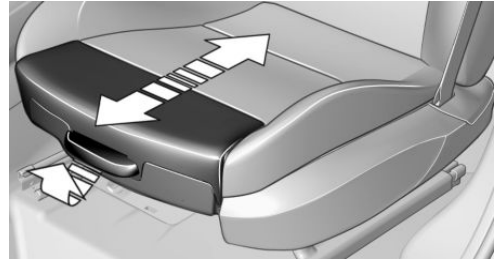

Pull the lever at the front of the seat and adjust the thigh support.

### Seat tilt

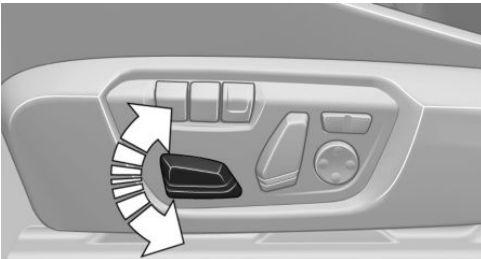

Move switch up or down.

### Lumbar support

The curvature of the seat backrest can be adjusted in a way that it supports the lumbar region of the spine. The lower back and the spine are supported for upright posture.



- ▶ Press the front/rear section of the switch:  
The curvature is increased/decreased.
- ▶ Press the upper/lower section of the switch:  
The curvature is shifted up/down.

### Backrest width

You can change the width of the backrest using the side wings to adjust the lateral support.



Press button on the corresponding side.

## Front seat heating

### Overview



Seat heating

### Switching on



Press button once for each temperature level.

The maximum temperature is reached when three LEDs are lit.

If the trip is continued within approx. 15 minutes after a stop, seat heating is activated automatically with the temperature selected last.

### Switching off



Press and hold the button, until the LEDs go out.

## Entering the rear

### Safety information



#### WARNING

There is a risk of jamming when moving the seats. There is a risk of injury or risk of property damage. Make sure that the area of

movement of the seat is clear prior to any adjustment. ◀



#### WARNING

Unexpected movements of the backrest while driving may occur due to an unlocked backrest. Vehicle control could be lost. There is a risk of injury. Fold back and lock the backrests before driving. ◀

## Manual length adjustment

### Comfort entry

The comfort entry contains a memory function for forward/backward and backrest adjustment.

1. Pull lever up to the stop.

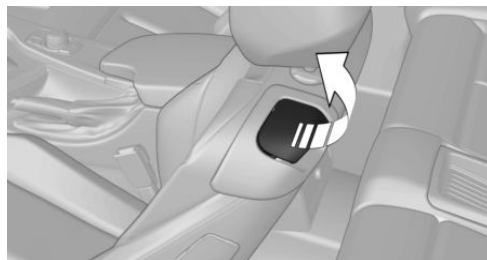

2. Fold backrest forward.
3. Push the seat forward.

### Original position

1. Push the seat back into the original position.
2. Fold back the backrest to lock the seat.



## Electric forward/backward adjustment

### Comfort entry



The comfort entry contains a memory function for forward/backward and backrest adjustment.

1. Pull lever up to the stop.



2. Fold backrest forward.
3. To change the entry area:
  - ▶  Press and hold this button until the seat has moved to the desired position. Releasing the button stops window/roof movement.
  - ▶  Press button briefly. The seat automatically moves to the end position. Pressing again stops the motion.

### Original position

1. Moving the seat to its original position:
  - ▶  Press and hold this button until the seat has moved to its original position. Releasing the button stops window/roof movement.
  - ▶  Press button briefly. The seat moves to its original position. Pressing again stops the motion.
2. Fold the backrest back.

## Safety belts

### Number of safety belts

The vehicle is fitted with four safety belts to ensure occupant safety. However, they can only offer protection when adjusted correctly.

### General information

Always make sure that safety belts are being worn by all occupants before driving off. Although airbags enhance safety by providing added protection, they are not a substitute for safety belts.

Slowly guide the safety belt out of the holder when fastening it.

The upper shoulder strap's anchorage point will be correct for adult seat occupants of every build if the seat is correctly adjusted.

### Safety information



#### WARNING

If the safety belt is used by more than one person, the protective effect of the safety belt cannot be ensured anymore. There is a risk of injuries or danger to life. Do not allow more than one person to wear a single safety belt. Infants and children are not allowed on an occupant's lap, but must be transported and respectively secured in designated child restraint systems. ◀



#### WARNING

The protective effect of the safety belts can be limited or lost when safety belts are fastened incorrectly. An incorrectly fastened safety belt can cause additional injuries, e.g., in the event of an accident or during braking and evasive maneuvers. There is a risk of injuries or danger to life. Make sure that all occupants are wearing safety belts correctly. ◀

## Correct use of safety belts

- ▷ Wear the safety belt twist-free and as tight to your body as possible over your lap and shoulders.
- ▷ Wear the safety belt deep on your hips over your lap. The safety belt may not press on your stomach.
- ▷ Do not wear the safety belt on your throat, rub it on sharp edges, guide it or jam it in across hard or fragile objects.
- ▷ Avoid thick clothing.
- ▷ Re-tighten the safety belt frequently upward around your upper body.

## Buckling the safety belt

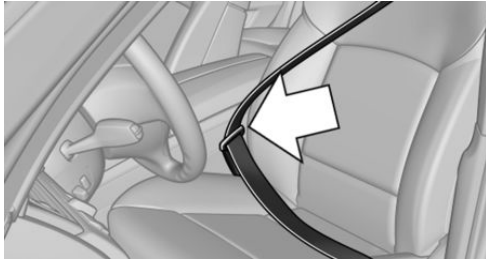

Make sure you hear the latch plate engage in the belt buckle.

## Unbuckling the safety belt

1. Hold the safety belt firmly.
2. Press the red button in the belt buckle.
3. Guide the safety belt back into its roll-up mechanism.

## Safety belt reminder for driver's and passenger's seat



The indicator lamp lights up and a signal sounds. Make sure that the safety belts are positioned correctly. The safety belt reminder is active at speeds above approx. 6 mph/10 km/h. It can also be activated if objects are placed on the front passenger seat.

## Damage to safety belts



### WARNING

The protective effect of the safety belts may not be fully functional or fail in the following situations:

- ▷ Safety belts are damaged, soiled or changed in any other way.
- ▷ Safety belt buckle is damaged or heavily soiled.
- ▷ Belt tensioners or belt retractors were modified.

Safety belts can be imperceptibly damaged in the event of an accident. There is a risk of injuries or danger to life. Do not modify safety belts, safety belt buckles, belt tensioners, belt retractors or belt anchors and keep them clean. Have the safety belts checked after an accident at the dealer's service center or another qualified service center or repair shop. ◀

## Front head restraints

### Safety information



### WARNING

A missing protective effect due to removed or not correctly adjusted head restraints can cause injuries in the head and neck area. There is a risk of injury. Install head restraints on occupied seats prior to driving and make sure that the center of the head restraint supports the back of the head at eye level. ◀



### WARNING

Body parts can be jammed when moving the head restraint. There is a risk of injury. Make sure that the area of movement is clear when moving the head restraint. ◀

**WARNING**

Objects on the head restraint reduce the protective effect in the head and neck area. There is a risk of injury.

- ▷ Do not use seat or head restraint covers.
- ▷ Do not hang objects, e.g., clothes hangers, directly on the head restraint.
- ▷ Only use accessories that have been determined to be safe for attachment to a head restraint.
- ▷ Do not use any accessories, e.g., pillows, while driving. ◀

**Correctly adjusted head restraint****General information**

A correctly adjusted head restraint reduces the risk of injury to cervical vertebrae in the event of an accident.

**Height**

Adjust the head restraint so that its center is approximately at eye level.

**Distance**

Adjust the distance so that the head restraint is as close as possible to the back of the head. If necessary, adjust the distance by adjusting the tilt of the backrest.

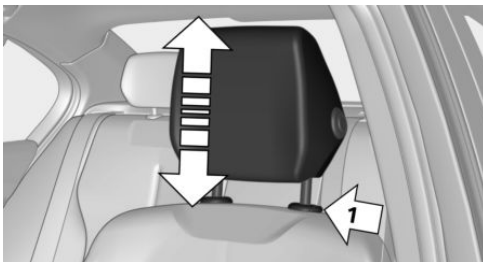
**Adjusting the height**

- ▷ To raise: push the head restraint up.

- ▷ To lower: press button, arrow 1, and push head restraint down.

**Removing**

Only remove the head restraint if no one will be sitting in the seat in question.

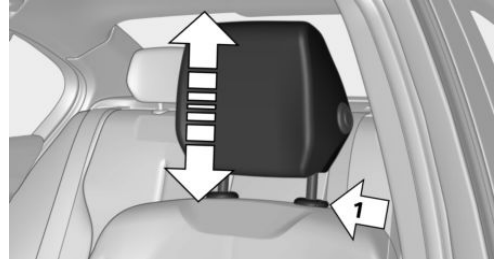

1. Raise the head restraint up against the resistance.
2. Press button, arrow 1, and pull the head restraint out completely.

**Rear head restraints****Safety information****WARNING**

A missing protective effect due to removed or not correctly adjusted head restraints can cause injuries in the head and neck area. There is a risk of injury. Install head restraints on occupied seats prior to driving and make sure that the center of the head restraint supports the back of the head at eye level. ◀

**WARNING**

Body parts can be jammed when moving the head restraint. There is a risk of injury. Make sure that the area of movement is clear when moving the head restraint. ◀

**WARNING**

Objects on the head restraint reduce the protective effect in the head and neck area. There is a risk of injury.

- ▷ Do not use seat or head restraint covers.
- ▷ Do not hang objects, e.g., clothes hangers, directly on the head restraint.
- ▷ Only use accessories that have been determined to be safe for attachment to a head restraint.
- ▷ Do not use any accessories, e.g., pillows, while driving. ◀

## Correctly adjusted head restraint

### General information

A correctly adjusted head restraint reduces the risk of injury to cervical vertebrae in the event of an accident.

### Height

Adjust the head restraint so that its center is approximately at eye level.

### Adjusting the height

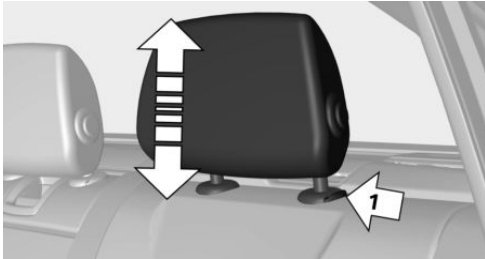

- ▷ To raise: push the head restraint up.
- ▷ To lower: press button, arrow 1, and push head restraint down.

### Fold down head restraints

Only fold down the head restraint if no one will be sitting in the seat in question.

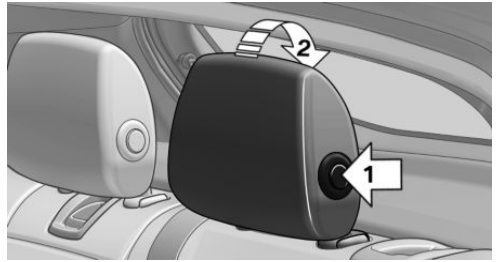

- ▷ To fold down: press the button, arrow 1, and press down the head restraint, arrow 2.
- ▷ To fold up: pull up head restraints.

### Removing

Only remove the head restraint if no one will be sitting in the seat in question.

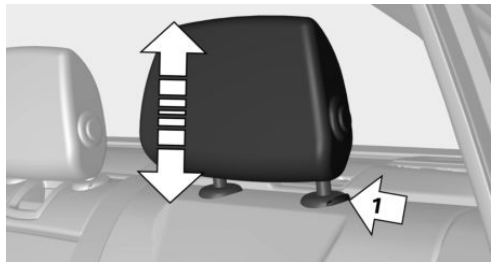

1. Raise the head restraint up against the resistance.
2. Press button, arrow 1, and pull the head restraint out completely.

## Seat and mirror memory

### Concept

Two driver's seat and exterior mirror positions can be stored per profile and called up. Settings for the backrest width and lumbar support are not stored in memory.

## Safety information



### WARNING

Using the memory function while driving can lead to unexpected movements of the seat. Vehicle control could be lost. There is a risk of an accident. Only retrieve the memory function when the vehicle is stationary. ◀



### WARNING

There is a risk of jamming when moving the seats. There is a risk of injury or risk of property damage. Make sure that the area of movement of the seat is clear prior to any adjustment. ◀

## Overview



## Storing

1. Switch on the ignition.
2. Set the desired position.
3.  Press button. The LED in the button lights up.
4. Press selected button 1 or 2 while the LED is lit. The LED goes out.



Button was pressed inadvertently:

Press button again.

The LED goes out.

## Calling up settings

The stored position is called up automatically. Press selected button 1 or 2.

The procedure stops when a switch for setting the seat or one of the memory buttons is pressed.

While driving, the seat position adjustment on the driver's side is interrupted after a short time.

## Calling up of a seat position deactivated

After a brief period, calling up stored seat positions is deactivated to save battery power.

To reactivate calling up of a seat position:

- ▷ Open and close the door or tailgate.
- ▷ Press a button on the remote control.
- ▷ Press the Start/Stop button.

## Mirrors

### Exterior mirrors

#### General information

The mirror on the passenger side is more curved than the driver's side mirror.

Depending on the vehicle equipment, the mirror setting is stored for the profile currently used. When the vehicle is unlocked via the remote control, the position is automatically retrieved if this function is active.

#### Safety information



### WARNING

Objects reflected in the mirror are closer than they appear. The distance to the traffic behind could be incorrectly estimated, e.g., while changing lanes. There is a risk of an accident. Estimate the distance to the traffic behind by looking over your shoulder. ◀

## Overview



- 1 Settings 58
- 2 Left/right, Automatic Curb Monitor
- 3 Folding in and out 58

## Selecting a mirror



To change over to the other mirror:  
Slide the switch.

## Adjusting electrically



Press button.

The mirror movement follows the button movement.

## Saving positions

The current exterior mirror position can be stored via the seat and mirror memory.

## Adjusting manually

In case of electrical malfunction press edges of mirror.

## Automatic Curb Monitor

### Concept

If reverse gear is engaged, the mirror glass on the front passenger side is tilted downward. This improves your view of the curb and other low-lying obstacles when parking, e.g.

## Activating

1.  Slide the switch to the driver's side mirror position.
2. Engage selector lever position R.

## Deactivating

Slide the switch to the passenger side mirror position.

## Folding in and out



### NOTE

Depending on the vehicle width, the vehicle can be damaged in vehicle washes. There is a risk of property damage. Before washing, fold in the mirrors by hand or with the button. ◀



Press button.

Possible at speeds up to approx.  
15 mph/20 km/h.

Fold the mirrors in and out is advantageous in the following situations:

- ▷ In vehicle washes.
- ▷ On narrow roads.
- ▷ For folding mirrors back out that were folded away manually.

Mirrors that were folded in are folded out automatically at a speed of approx.  
25 mph/40 km/h.

## Automatic heating

Both exterior mirrors are automatically heated whenever the engine is running.

## Automatic dimming feature

The exterior mirror on the driver's side is automatically dimmed. Photocells are used to control the Interior mirror.

## Interior mirror, manually dimmable

### Flip lever

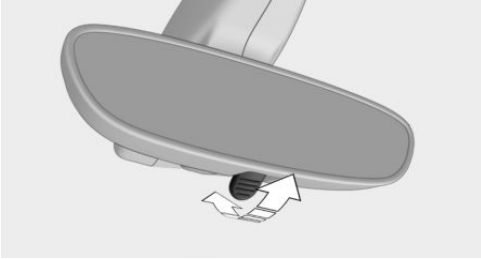

To reduce the blinding effect of the interior rear view mirror, flip the lever forward.

### Turn knob

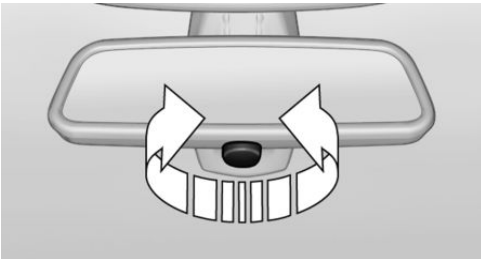

Turn the knob to reduce the blinding effect by the interior mirror.

## Interior mirror, automatic dimming feature

### Overview

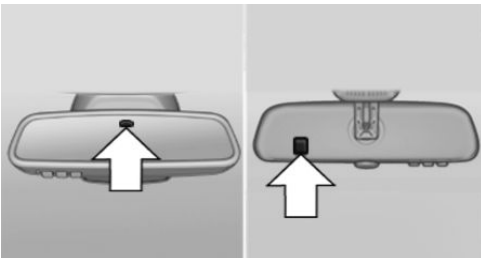

Photocells are used for control:

- ▷ In the mirror glass.
- ▷ On the back of the mirror.

### Functional requirements

- ▷ Keep the photocells clean.
- ▷ Do not cover the area between the inside rearview mirror and the windshield.

## Steering wheel

### Safety information



#### WARNING

Steering wheel adjustments while driving can lead to unexpected steering wheel movements. Vehicle control could be lost. There is a risk of an accident. Adjust the steering wheel while the vehicle is stationary only. ◀

### Settings

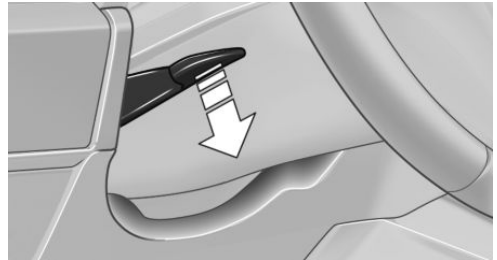

1. Fold the lever down.
2. Move the steering wheel to the preferred height and angle to suit your seating position.
3. Fold the lever back up.

## Heated steering wheel

### Overview

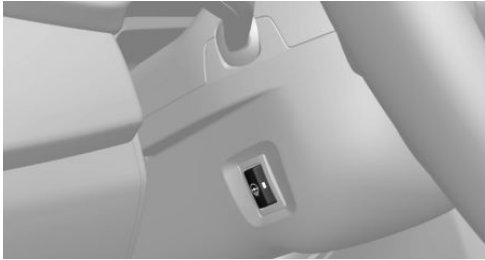

Heated steering wheel

### Switching on/off



Press button.

- ▷ On: the LED lights up.
- ▷ Off: the LED goes out.

# Transporting children safely

## Vehicle features and options

This chapter describes all standard, country-specific and optional features offered with the series. It also describes features that are not necessarily available in your vehicle, e. g., due

to the selected options or country versions. This also applies to safety-related functions and systems. When using these functions and systems, the applicable country provisions must be observed.

## The right place for children

### Safety information



#### WARNING

Unattended children or animals can cause the vehicle to move and endanger themselves and traffic, e.g., due to the following actions:

- ▶ Pressing the Start/Stop button.
- ▶ Releasing the parking brake.
- ▶ Opening and closing the doors or windows.
- ▶ Engaging selector lever position N.
- ▶ Using vehicle equipment.

There is a risk of accidents or injuries. Do not leave children or animals unattended in the vehicle. Take the remote control with you when exiting and lock the vehicle. ◀

### Children should always be in the rear

#### General information

Accident research shows that the safest place for children is in the rear seat.

Only transport children younger than 13 years of age or shorter than 5 ft, 150 cm in the rear in suitable child restraint systems provided in accordance with the age, weight and size of the child. Children 13 years of age or older must wear a safety belt as soon as a suitable child restraint system can no longer be used due to their age, weight and size.

### Safety information



#### WARNING

Children shorter than 5 ft, 150 cm cannot correctly fasten the safety belt without suitable additional restraint systems. The protective effect of the safety belts can be limited or lost when safety belts are fastened incorrectly. An incorrectly fastened safety belt can cause additional injuries, e.g., in the event of an accident or during braking and evasive maneuvers. There is a risk of injuries or danger to life. Secure children shorter than 5 ft, 150 cm using suitable restraint systems. ◀

### Children on the front passenger seat

Should it ever be necessary to use a child restraint system in the front passenger seat, make sure that the front, knee and side airbags on the front passenger side are deactivated. Automatic deactivation of front-seat passenger airbags, refer to page 100.

### Safety information



#### WARNING

Active front-seat passenger airbags can injure a child in a child restraint system when the airbags are activated. There is a risk of injury. Make sure that the front-seat passenger airbags are deactivated and that the PASSENGER AIRBAG OFF indicator lamp lights up. ◀

**WARNING**

The stability of the child restraint system is limited or compromised with incorrect seat adjustment or improper installation of the child seat. There is a risk of injuries or danger to life. Make sure that the child restraint system fits securely against the backrest. If possible, adjust the backrest tilt for all affected backrests and correctly adjust the seats. Make sure that seats and backrests are securely engaged. If possible, adjust the height of the head restraints or remove them. ◀

## Installing child restraint systems

### General information

Pay attention to the specifications of the child restraint system manufacturer when selecting, installing, and using child restraint systems.

### Safety information

**WARNING**

The stability of the child restraint system is limited or compromised with incorrect seat adjustment or improper installation of the child seat. There is a risk of injuries or danger to life. Make sure that the child restraint system fits securely against the backrest. If possible, adjust the backrest tilt for all affected backrests and correctly adjust the seats. Make sure that seats and backrests are securely engaged. If possible, adjust the height of the head restraints or remove them. ◀

### On the front passenger seat

#### Deactivating airbags

**WARNING**

Active front-seat passenger airbags can injure a child in a child restraint system when the airbags are activated. There is a risk of in-

jury. Make sure that the front-seat passenger airbags are deactivated and that the **PASSENGER AIRBAG OFF** indicator lamp lights up. ◀

After installing a child restraint system in the front passenger seat, make sure that the front, knee and side airbags on the front passenger side are deactivated.

Deactivate the front-seat passenger airbags automatically, refer to page 100.

#### Seat position and height

Before installing a child restraint system, move the front passenger seat as far back as possible and bring it as far up as possible to obtain the best possible position for the belt and to offer optimal protection in the event of an accident.

If the upper anchorage of the safety belt is located in front of the belt guide of the child seat, move the passenger seat carefully forward until the best possible belt guide position is reached.

#### Backrest width

Adjustable backrest width: before installing a child restraint system in the front passenger seat, open the backrest width completely. Do not change the backrest width again and do not call up a memory position.

#### Child seat security



The rear safety belts and the front passenger safety belt can be permanently locked to fasten child restraint systems.

## Locking the safety belt

1. Pull out the belt strap completely.
2. Secure the child restraint system with the safety belt.
3. Allow the belt strap to be pulled in and pull it tight against the child restraint system.  
The safety belt is locked.

## Unlocking the safety belt

1. Unbuckle the belt buckle.
2. Remove the child restraint system.
3. Allow the belt strap to be pulled in completely.

# LATCH child restraint fixing system

## General information

LATCH: Lower Anchors and Tether for Children.

Pay attention to the operating and safety information of the child restraint system manufacturer when installing and using LATCH child restraint fixing system.

## Mounts for the lower LATCH anchors

The lower anchors may be used to attach the CRS to the vehicle seat up to a combined child and CRS weight of 65 lb/30 kg when the child is restrained by the internal harnesses.

## Safety information



### WARNING

If the LATCH child restraint fixing systems are not correctly engaged, the protective effect of the LATCH child restraint fixing system can be limited. There is a risk of injuries or danger to life. Make sure that the lower anchors are securely engaged and that the LATCH child restraint fixing system fits securely against the backrest. ◀

## Position



The corresponding symbol shows the mounts for the lower LATCH anchors. Seats equipped with lower anchors are marked with a pair (2) of LATCH symbols. Use of inner lower anchors from standard outboard LATCH positions to install a child restraint system in the center is



not recommended. For the center position, use the vehicle seat belt instead.

## Before installing LATCH child restraint fixing systems

Pull the safety belt away from the area of the child restraint system.

## Assembly of LATCH child restraint fixing systems

1. Install child restraint system, see manufacturer's information.
2. Ensure that both LATCH anchors are properly connected.

## Child restraint system with a tether strap

## Mounting points



The respective symbol shows the anchor for the upper retaining strap.

Seats with an upper top tether are marked with this symbol. It can be found on the rear seat backrest or the rear window shelf.

## Safety information



### NOTE

The mounting points for the upper retaining straps of child restraint systems are only provided for these retaining straps. When other objects are mounted, the anchors can be damaged. There is a risk of property damage.

Only mount child restraint systems to the upper retaining straps. ◀

### Routing the retaining strap



#### WARNING

If the upper retaining strap is incorrectly used for the child restraint system, the protective effect can be reduced. There is a risk of injury. Make sure that the upper retaining strap is not guided across sharp edges and without twisting to the upper retaining strap. ◀

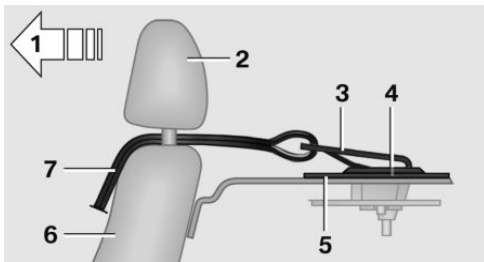

- 1 Direction of travel
- 2 Head restraint
- 3 Hook for upper retaining strap
- 4 Mounting point
- 5 Rear window shelf
- 6 Seat backrest
- 7 Upper retaining strap

### Attaching the upper retaining strap to the mounting point

1. Remove the mounting point cover.
2. Raise the head restraint.
3. Guide the upper retaining strap between the supports of the head restraint.
4. Attach the hook of the retaining strap to the anchor.
5. Tighten the retaining strap by pulling it down.
6. Lower and lock head restraints as needed.

# Driving

## Vehicle features and options

This chapter describes all standard, country-specific and optional features offered with the series. It also describes features that are not necessarily available in your vehicle, e. g., due to the selected options or country versions. This also applies to safety-related functions and systems. When using these functions and systems, the applicable country provisions must be observed.

## Start/Stop button

### Concept



Pressing the Start/Stop button switches the ignition on or off and starts the engine.

**M double-clutch transmission:** the engine starts with the brake pedal pressed when you press the Start/Stop button.

**Manual transmission:** the engine starts with the clutch pedal pressed when the Start/Stop button is pressed.

### Ignition on

**M double-clutch transmission:** press the Start/Stop button, and do not press on the brake pedal at the same time.

**Manual transmission:** press the Start/Stop button without stepping on the clutch pedal.

All vehicle systems are ready for operation.

Most of the indicator and warning lights in the instrument cluster light up for a varied length of time.

To save battery power when the engine is off, switch off the ignition and any unnecessary electronic systems/power consumers.

### Ignition off

**M double-clutch transmission:** press the Start/Stop button again without stepping on the brake.

**Manual transmission:** press the Start/Stop button again without stepping on the clutch pedal.

All indicator lights in the instrument cluster go out.

To save battery power when the engine is off, switch off the ignition and any unnecessary electronic systems/power consumers.

### Safety measures

When switching off the ignition, the transmission position P is selected automatically if the selector lever position D or R is selected.

The ignition is switched off automatically in the following situations while the vehicle is stationary and the engine is off:

- ▶ When locking the vehicle, and when the low beams are activated.
- ▶ Shortly before the battery is discharged completely, so that the engine can still be started.
- ▶ When opening or closing the driver door, if the driver's safety belt is unbuckled and the low beams are switched off.
- ▶ While the driver's safety belt is unbuckled with driver's door open and low beams off.

The low beams switch to parking lights after approx. 15 minutes of no use.

### Radio ready state

Activate radio-ready state: when the engine is running: press the Start/Stop button.

Some electronic systems/power consumers remain ready for operation.

The radio-ready state is switched off automatically in the following situations:

- ▷ After approx. 8 minutes.
- ▷ When the vehicle is locked using the central locking system.
- ▷ Shortly before the battery is discharged completely, so that the engine can still be started.

The radio-ready state remains active if, e.g., the ignition is automatically switched off for the following reasons:

- ▷ Opening or closing the driver's door.
- ▷ Unfastening of the driver's safety belt.
- ▷ When automatically switching from low beams to parking lights.

If the engine is switched off and the ignition is switched on, the system automatically switches to the radio-ready state if the lights are turned off or, if correspondingly equipped, the daytime running lights are activated.

## Starting the engine

### Safety information



#### DANGER

If the exhaust pipe is blocked or ventilation is insufficient, harmful exhaust gases can enter into the vehicle. The exhaust gases contain carbon monoxide, an odorless and colorless but highly toxic gas. In enclosed areas, exhaust gases can also accumulate outside of the vehicle. There is danger to life. Keep the exhaust pipe free and ensure sufficient ventilation. ◀



#### WARNING

An unsecured vehicle can begin to move and possibly roll away. There is a risk of an accident. Before exiting, secure the vehicle against rolling.

In order to ensure that the vehicle is secured against rolling away, observe the following:

- ▷ Set the parking brake.

- ▷ On uphill grades or on a downhill slope, turn the front wheels in the direction of the curb.
- ▷ On uphill grades or on a downhill slope, also secure the vehicle, e.g., with a wheel chock. ◀



#### NOTE

In the case of repeated starting attempts or repeated starting in quick succession, the fuel is not burned or is inadequately burned. The catalytic converter can overheat. There is a risk of property damage. Avoid repeated starting in quick succession. ◀

## M double-clutch transmission

### Starting the engine

1. Depress the brake pedal.
2. Press the Start/Stop button.

The ignition is activated automatically for a certain time and is stopped as soon as the engine starts.

### Manual transmission

#### Starting the engine

1. Depress the brake pedal.
2. Press on the clutch pedal and shift to neutral.
3. Press the Start/Stop button.

The ignition is activated automatically for a certain time and is stopped as soon as the engine starts.

## Engine stop

### Safety information



#### WARNING

Unattended children or animals can cause the vehicle to move and endanger themselves and traffic, e.g., due to the following actions:

- ▷ Pressing the Start/Stop button.
- ▷ Releasing the parking brake.
- ▷ Opening and closing the doors or windows.
- ▷ Engaging selector lever position N.
- ▷ Using vehicle equipment.

There is a risk of accidents or injuries. Do not leave children or animals unattended in the vehicle. Take the remote control with you when exiting and lock the vehicle. ◀



#### WARNING

An unsecured vehicle can begin to move and possibly roll away. There is a risk of an accident. Before exiting, secure the vehicle against rolling.

In order to ensure that the vehicle is secured against rolling away, observe the following:

- ▷ Set the parking brake.
- ▷ On uphill grades or on a downhill slope, turn the front wheels in the direction of the curb.
- ▷ On uphill grades or on a downhill slope, also secure the vehicle, e.g., with a wheel chock. ◀

### Before driving into a vehicle wash

So that the vehicle can roll into a vehicle wash, observe instructions for going into an automatic vehicle wash, refer to page 202.

## M double-clutch transmission

### Switching off the engine

1. Apply the brakes until the vehicle comes to a stop.
2. Press the Start/Stop button.  
The engine is switched off.  
The radio-ready state is switched on.
3. Set the parking brake.

### Manual transmission

### Switching off the engine

1. With the vehicle at a standstill, press the Start/Stop button.
2. Shift into first gear or reverse.
3. Set the parking brake.

## Auto Start/Stop function

### Concept

The Auto Start/Stop function helps save fuel. The system switches off the engine during a stop, e.g., in traffic congestion or at traffic lights. The ignition remains switched on. The engine starts again automatically for driving off.

The Auto Start/Stop function is only available in the COMFORT or TRACTION driving programs, refer to page 117.

### General information

After every start of the engine using the Start/Stop button, the Auto Start/Stop function is in the last selected state. When the Auto Start/Stop function is active, it is available when the vehicle is traveling faster than about 3 mph/5 km/h.

### Engine stop

The engine is switched off automatically during a stop under the following conditions:

M double-clutch transmission:

- ▷ The selector lever is in selector lever position D.
- ▷ The brake pedal remains depressed while the vehicle is stopped.
- ▷ The driver's safety belt is buckled or the driver's door is closed.

Manual transmission:

- ▷ Neutral is engaged and the clutch pedal is not pressed.
- ▷ The driver's safety belt is buckled or the driver's door is closed.

The air flow from the air conditioner is reduced when the engine is switched off.

### Displays in the instrument cluster



The READY display in the tachometer signals that the Auto Start/Stop function is ready to start the engine automatically.



The display indicates that the conditions for an automatic engine stop have not been met.

### Functional limitations

The engine is not switched off automatically in the following situations:

- ▷ External temperature too low.
- ▷ The external temperature is high and automatic climate control is running.
- ▷ The vehicle's interior has not yet been heated or cooled to the required level.
- ▷ The engine is not yet at operating temperature.
- ▷ The wheels are at a sharp angle or the steering wheel is being turned.
- ▷ After driving in reverse.

- ▷ Fogging of the windows when the automatic climate control is switched on.
- ▷ Vehicle battery is heavily discharged.
- ▷ At higher elevations.
- ▷ The engine compartment lid is unlocked.
- ▷ Stop-and-go traffic.
- ▷ Use of fuel with high ethanol content.

### Starting the engine

The engine starts automatically under the following conditions:

- ▷ M double-clutch transmission: by releasing the brake pedal.
- ▷ Manual transmission: clutch pedal is pressed.

After the engine starts, accelerate as usual.

### Safety mode

After the engine switches off automatically, it will not start again automatically if any one of the following conditions are met:

- ▷ The driver's safety belt is unbuckled and the driver's door is open.
- ▷ The hood was unlocked.

Some indicator lights light up for a varied length of time.

The engine can only be started via the Start/Stop button.

### Functional limitations

Even if driving off was not intended, the deactivated engine starts up automatically in the following situations:

- ▷ Excessive warming of the vehicle's interior when the cooling function is switched on.
- ▷ The steering wheel is turned.
- ▷ Double-clutch transmission: change from selector lever position D to N, R or D/S.
- ▷ M double-clutch transmission: accelerating while simultaneously applying the brake.

- ▷ The vehicle begins rolling.
- ▷ Fogging of the windows when the automatic climate control is switched on.
- ▷ Vehicle battery is heavily discharged.
- ▷ Excessive cooling of the vehicle's interior when the heating is switched on.
- ▷ Low brake vacuum pressure; this can occur, e.g., if the brake pedal is depressed a number of times in succession.

## Preventing an automatic engine stop with aM double-clutch transmission

### Concept

To make it possible to drive off very quickly, such as at an intersection, the automatic engine stop can be actively prevented.

### Preventing an engine stop using the brake pedal

The engine stop can be actively prevented within one second after the vehicle comes to a standstill:

- ▷ Immediately after the vehicle comes to a standstill, briefly press the brake pedal forcefully.
- ▷ Then press the brake pedal with normal braking force.

## Activating/deactivating the system manually

### Using the button

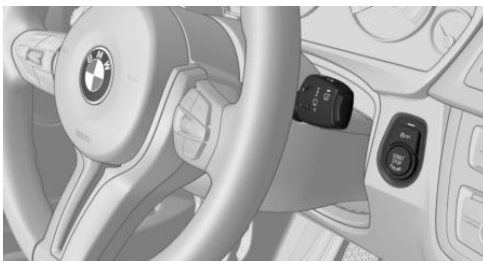

Press button.

- ▷ LED comes on: Auto Start/Stop function is deactivated.  
The engine is started during an automatic engine stop.  
The engine can only be stopped or started via the Start/Stop button.
- ▷ LED goes out: Auto Start/Stop function is activated.

## Switching off the vehicle during an automatic engine stop

During an automatic engine stop, the vehicle can be switched off permanently, e.g., when leaving it.

M double-clutch transmission:

1. Press the Start/Stop button. The ignition is switched off. The Auto Start/Stop function is deactivated.  
Selector lever position P is engaged automatically.

2. Set the parking brake.

Manual transmission:

1. Press the Start/Stop button. The ignition is switched off. The Auto Start/Stop function is deactivated.
2. Shift into first gear or reverse.
3. Set the parking brake.

Engine start as usual via Start/Stop button.

## Automatic deactivation

In certain situations, the Auto Start/Stop function is deactivated automatically for safety reasons, e.g., if no driver is detected.

## Malfunction

The Auto Start/Stop function no longer switches off the engine automatically. A Check Control message is displayed. It is possible to continue driving. Have the system checked by

a dealer's service center or another qualified service center or repair shop.

## Parking brake

### Safety information



#### WARNING

An unsecured vehicle can begin to move and possibly roll away. There is a risk of an accident. Before exiting, secure the vehicle against rolling.

In order to ensure that the vehicle is secured against rolling away, observe the following:

- ▷ Set the parking brake.
- ▷ On uphill grades or on a downhill slope, turn the front wheels in the direction of the curb.
- ▷ On uphill grades or on a downhill slope, also secure the vehicle, e.g., with a wheel chock.◀

### Applying

The lever automatically engages after being pulled up.

**BRAKE** The indicator lamp lights up red. The parking brake is set.

**(!)** Lower lamp: indicator lamp in Canadian models

If for once use during driving is required, engage the parking brake slightly and hold the button down.

To prevent corrosion and one-sided brake action, lightly apply the parking brake periodically while coasting, if traffic conditions permit.

The brake lights will not light up if the parking brake is set.

### Releasing

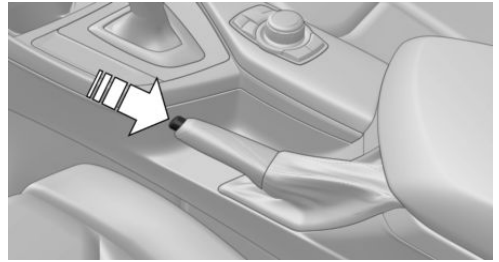

Raise lever slightly, press the button and guide the lever down.

## Turn signal, high beams, headlight flasher

### Turn signal

#### Turn signal in exterior mirror

When driving and during operation of the turn signals or hazard warning system, do not fold in the exterior mirrors, so that the signal lights on the exterior mirror are easy to see.

### Using turn signals

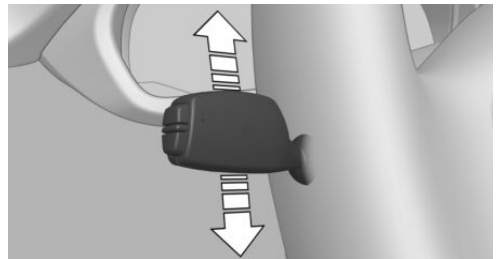

Press the lever beyond the resistance point.

The lever returns into its starting position after actuation.

To switch off manually, slightly tap the lever to the resistance point.

### Triple turn signal activation

Lightly tap the lever up or down.

The turn signal flashes three times.

The function can be activated or deactivated.

On the Control Display:

1. "Settings"
2. "Lighting"
3. "Triple turn signal"

Settings are stored for the profile currently used.

### Signaling briefly

Press the lever to the resistance point and hold it there for as long as you want the turn signal to flash.

### Malfunction

Unusually rapid flashing of the indicator lamp indicates that a turn signal bulb has failed.

### High beams, headlight flasher

Push the lever forward or pull it backward.

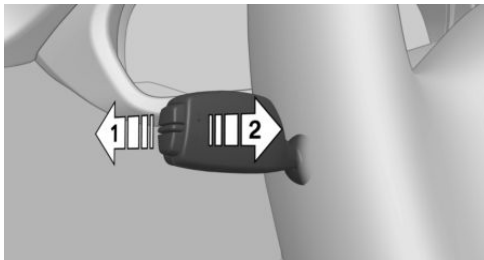

- ▷ High beams, arrow 1.
- ▷ High beams off/headlight flasher, arrow 2.

## Washer/wiper system

### General information

Do not use the wipers if the windshield is dry, as this may damage the wiper blades or cause them to become worn more quickly.

### Safety information



#### NOTE

If the wipers are frozen to the windshield, the wiper blades can be torn off and the wiper motor can overheat when switching on. There is a risk of property damage. Defrost the windshield prior to switching the wipers on. ◀

### Switching on

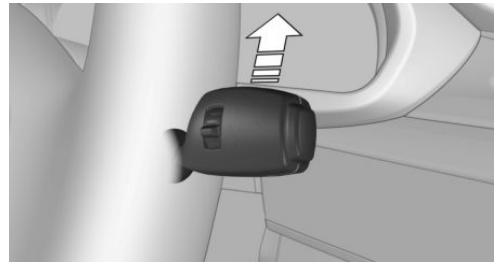

Tap the lever up or press it beyond the resistance point.

- ▷ Normal wiper speed: tap up once.  
The wipers switch to intermittent operation when the vehicle is stationary.
- ▷ Fast wiper speed: tap up twice or tap once beyond the resistance point.  
Wipers change to normal speed when vehicle comes to standstill.

The lever automatically returns to its initial position when released.

### Switching off and brief wipe

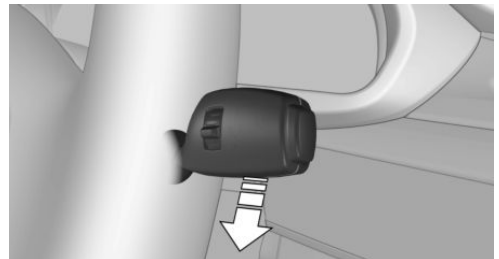

Press the lever down.

- ▷ To switch off from fast wiper speed: press down twice.
- ▷ To switch off from normal wiper speed: press down once.
- ▷ Single wipe: press down once.

The lever automatically returns to its initial position when released.

## Interval mode or rain sensor

### Concept

The rain sensor automatically controls the time between wipes depending on the intensity of the rainfall.

### General information

The sensor is located on the windshield, directly in front of the interior mirror. Without the rain sensor, the frequency of the wiper operation is preset.

### Safety information



#### NOTE

If the rain sensor is activated, the wipers can accidentally start moving in vehicle washes. There is a risk of property damage. Deactivate the rain sensor in vehicle washes. ◀

### Activating/deactivating

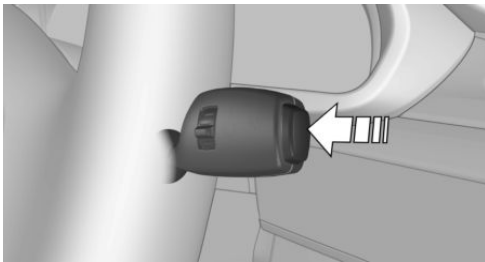

Press button on the wiper lever.

Wiping is started.

If the vehicle is equipped with a rain sensor: LED in wiper lever lights up.

If wipers are frozen to windshield, wiper operation is deactivated.

### Setting the frequency or sensitivity of the rain sensor

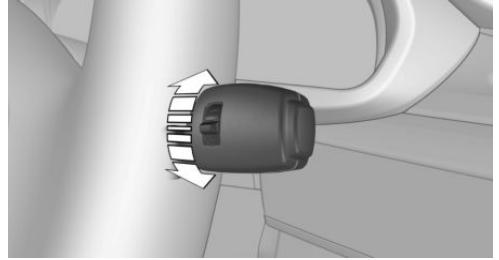

Turn the thumbwheel to adjust the frequency or sensitivity of the rain sensor.

Up: short interval or high sensitivity of the rain sensor.

Down: long interval or low sensitivity of the rain sensor.

### Windshield and headlamp washer system

#### Safety information



#### WARNING

The washer fluid can freeze onto the window at low temperatures and obstruct the view. There is a risk of an accident. Only use the washer systems, if the washer fluid cannot freeze. Use antifreeze, if needed. ◀



#### NOTE

When the washer fluid reservoir is empty, the wash pump cannot work as intended. There is a risk of property damage. Do not use the washer system when the washer fluid reservoir is empty. ◀

## Cleaning

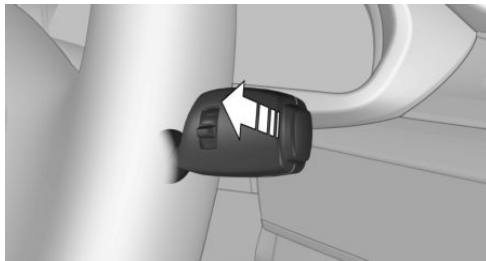

Pull the lever.

The system sprays washer fluid on the windshield and activates the wipers briefly.

In addition, the headlights are cleaned at regular intervals when the vehicle's lights are activated.

## Windshield washer nozzles

The windshield washer nozzles are automatically heated while the ignition is switched on.

## Fold-away position of the wipers

### Concept

The wipers can be folded away from the windshield in the fold-away position.

### General information

Important, e.g., when changing the wiper blades or when folding out under frosty conditions.

### Safety information



#### WARNING

If the wipers start moving in the folded away state, body parts can be jammed or damage may occur to parts of the vehicle. There is a risk of injury or risk of property damage. Make sure that the vehicle is switched off when the wipers are in the folded away state and the wipers are folded in when switching on. ◀

## Folding away the wipers

1. Switch the ignition on and off again.
2. With frosty conditions, make sure that the blades are not frozen to the windshield.
3. Press the wiper lever up beyond the point of resistance and hold it for approx. 3 seconds, until the wipers remain in a nearly vertical position
4. Lift the wiper all the way off of the windshield.

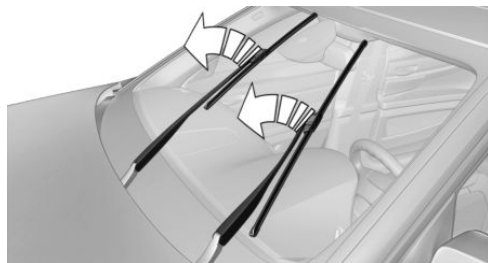

## Folding down the wipers

After the wipers are folded back down, the wiper system must be reactivated.

1. Switch on the ignition.
2. Push wiper lever down. Wipers return to their resting position and are ready again for operation.

## Washer fluid

### General information

All washer nozzles are supplied from one reservoir.

Use a mixture of tap water, windshield washer concentrate, and possibly antifreeze for the windshield washer system.

Recommended minimum fill quantity:  
0.2 US gal/1 liter.

## Safety information

### WARNING

Some antifreeze agents can contain harmful substances and are flammable. There is a risk of fire and a risk of injury. Observe the instructions on the containers. Keep antifreeze away from ignition sources. Do not refill operating materials into different bottles. Store operating materials out of reach of children.

United States: The washer fluid mixture ratio is regulated by the U.S. EPA and many individual states; do not exceed the allowable washer fluid dilution ratio limits that apply. Follow the usage instructions on the washer fluid container.

Use of BMW's Windshield Washer Concentrate or the equivalent is recommended. ◀

### WARNING

Washer fluid can ignite and catch fire on contact with hot engine parts. There is a risk of injury or risk of property damage. Only add washer fluid when the engine is cooled down. Next, fully close the lid of the washer fluid reservoir. ◀

### NOTE

Silicon-containing additives in the washer fluid for the water-repelling effect on the windows can lead to damage to the washing system. There is a risk of property damage. Do not add silicon-containing additives to the washer fluid. ◀

### NOTE

Mixing different windshield washer concentrates or antifreeze agents can damage the washing system. There is a risk of property damage. Do not mix different windshield washer concentrates or antifreeze agents. Observe the information and mixing ratios provided on the containers. ◀

## Overview

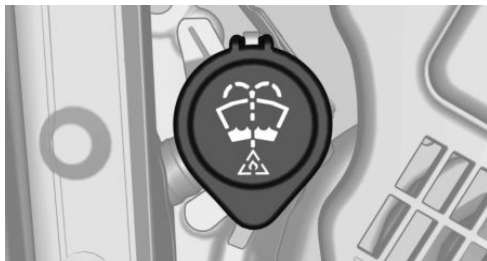

The washer fluid reservoir is located in the engine compartment.

## Malfunction

The use of undiluted windshield washer concentrate or alcohol-based antifreeze can lead to incorrect readings at temperatures below + 5 °F/- 15 °C.

## Manual transmission

### Safety information

#### WARNING

An unsecured vehicle can begin to move and possibly roll away. There is a risk of an accident. Before exiting, secure the vehicle against rolling.

In order to ensure that the vehicle is secured against rolling away, observe the following:

- ▷ Set the parking brake.
- ▷ On uphill grades or on a downhill slope, turn the front wheels in the direction of the curb.
- ▷ On uphill grades or on a downhill slope, also secure the vehicle, e.g., with a wheel chock. ◀

#### NOTE

When shifting to a lower gear, excessive speeds can damage the engine. There is a risk of property damage. When shifting into 5th or

6th gear, press the gearshift lever to the right. ◀

## Shifting

### General information

The engine speed during a shifting operation is adjusted automatically for harmonious and dynamic gear shifting.

### Reverse gear

Select only when the vehicle is stationary.

To overcome the resistance push the gearshift lever dynamically to the left and engage reverse gear with a forward shifting movement.

## M double-clutch transmission with Drivelogic

### General information

The M double-clutch transmission with Drivelogic is an automatic shift transmission with two clutches and partial transmissions in which the gears can be changed without interrupting the tractive force.

The operation is via the selector lever or two shift paddles on the steering wheel.

### Functions

- ▷ Drive mode or Sequential mode.
- ▷ Various drive programs, Drivelogic.
- ▷ Automatic downshifting and protection from misshifting even in sequential mode.
- ▷ Launch Control.
- ▷ Low Speed Assistant.

## Safety information



### WARNING

An unsecured vehicle can begin to move and possibly roll away. There is a risk of an accident. Before exiting, secure the vehicle against rolling.

In order to ensure that the vehicle is secured against rolling away, observe the following:

- ▷ Set the parking brake.
- ▷ On uphill grades or on a downhill slope, turn the front wheels in the direction of the curb.
- ▷ On uphill grades or on a downhill slope, also secure the vehicle, e.g., with a wheel chock. ◀

## Selector lever, selector lever positions

### Overview



- ▷ R: reverse gear.
- ▷ N: neutral.
- ▷ ◉ Center position, forward position.
- ▷ +: manual upshifting.
- ▷ -: manual downshifting.
- ▷ D/S: switch between drive mode and sequential mode.

### Engaging a selector lever position

Press on the brake pedal and pull or push the selector lever in the corresponding direction.

As soon as the selector lever is released, it reverts to the center position. In position R, the selector lever locks.

The engaged selector lever position is displayed in the instrument cluster and on the selector lever.

If a selector lever position is engaged, the vehicle may start rolling, after the brake is released, e.g., on downhill slopes. Thus, drive off immediately after releasing the brake.

Use the Slow Speed Assistant for maneuvering and during stop-and-go traffic.

## Low Speed Assistant

### Concept

The Low Speed Assistant gives assistance at very low speeds. The vehicle moves at walking speed.

This can also be used for rocking the vehicle in the snow. To do this, switch between reverse gear and forward gear without stepping on the brakes in the process.

### Safety information



#### NOTE

When using the function and simultaneously stepping on the brake pedal for a longer time, the transmission can overheat. There is a risk of property damage. When using the function, do not brake for a longer period. ◀

### Activating

1. Engage a driving position.
2. Briefly tap the accelerator pedal.

The vehicle rolls at minimum speed.

This is possible in 1st and 2nd gear and in reverse gear.

### Deactivating

Apply the brakes until the vehicle comes to a stop.

## Flashing display on the selector lever of the double clutch transmission

The actually engaged transmission position can deviate from the selector lever position in some situations. The display in the selector lever flashes.

Observe the display in the instrument cluster in these cases.

### D is Drive mode

In Drive mode, all forward gears are automatically changed.

Kickdown: for maximum acceleration, e.g., when passing. To do this, depress the accelerator pedal past the resistance point.

Switch to Sequential mode: shift using the shift paddles or the selector lever, or push the selector lever in the D/S direction.

### S is Sequential mode

Use the shift paddles or the selector lever to upshift or downshift without letting off the gas.

- ▷ Shortly before falling below a gear-dependent minimum speed, the transmission is automatically downshifted.
- ▷ Upshifting or downshifting is done only if the rpm and vehicle speed are appropriate. E.g., there is no downshifting if the engine speed is too high.
- ▷ Kickdown: the lowest possible gear is selected by simultaneously operating the kickdown and the left shift paddle or selector lever.
- ▷ It is also possible to start out in 2nd gear, e.g., on icy roads.

Switch to Drive mode: push selector lever in D/S direction.

### Reverse R

Select only when the vehicle is stationary.

It is also possible to rock the vehicle up to 6 mph/10 km/h. To do this, switch between

forward gear and reverse gear without stepping on the brakes in the process.

### N is Neutral

The vehicle may roll in selector lever position N, e.g., in vehicle washes, refer to page 202.

### P Park

The drive wheels are blocked.

P is engaged automatically:

- ▷ After the engine is switched off when the vehicle is in radio-ready state, refer to page 65, or when the ignition is switched off, refer to page 65, and when position R or D is set.
- ▷ With the ignition is off, if position N is set.

### Displays in the instrument cluster



The selector lever position is displayed, for example: P.

### Information

When the external temperature is very low, the display may not work. Current driving direction is recognizable at the engaged selector lever position.

### Gear change

#### General information

Shifting in Sequential mode possible.

A shift in Drive mode causes a switch to Sequential mode.

#### Using the selector lever

- ▷ To shift up: pull the selector lever rearwards.
- ▷ To shift down: press the selector lever forward.

### Using the shift paddles on the steering wheel

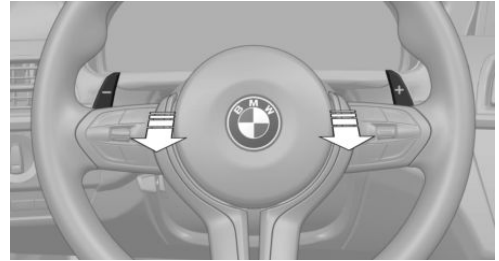

- ▷ Shift up: pull right shift paddle.
- ▷ Shift down: pull left shift paddle.

### Drivelogic

#### Concept

Using Drivelogic, the characteristics of the hybrid system can be adjusted. For this purpose, different driving programs are available in Drive and Sequential mode.

The driving programs can be programmed using Driving Dynamics Control.

#### Overview

#### Button in the vehicle



### Driving programs

#### Drive mode

Choice of three driving programs:

- ▷ COMFORT: efficient driving.
- ▷ SPORT: sporty driving.

- ▶ SPORT+: consistently sporty driving.

### Sequential mode

Choice of three driving programs:

- ▶ COMFORT: comfortable shifting operations.
- ▶ SPORT: sporty, fast shifting operations.
- ▶ SPORT+: maximum shifting speed, Launch Control, refer to page 78.

### Activating

Activate program via the Driving Dynamics Control, refer to page 117, button.

### Launch Control

#### Concept

Launch Control enables optimum acceleration on surfaces with good traction.

#### General information

The use of Launch Control causes premature component wear since this function represents a very heavy load for the vehicle.

Do not use Launch Control during the break-in, refer to page 152, period.

#### Requirements

Launch Control is available when the engine is warmed up, that is, after uninterrupted driving of at least 6 miles/10 km.

To start with Launch Control do not steer the steering wheel.

### Activate Launch Control

1. Deactivate Dynamic Stability Control, refer to page 115.
2. Select Sequential mode with gear 1.
3. With the engine running, apply the brake with the left foot.
4. Fully depress the accelerator pedal.  
The starting engine speed adjusts.

5. If necessary, change the starting engine speed by 500 rpm via cruise control.
6. Release the brake, the vehicle accelerates. Continue to depress the accelerator pedal.  
Upshifting occurs automatically as long as the accelerator pedal is fully depressed.

Launch Control is available again only after a certain distance has been driven.

### System limits

This transmission has an overheating protection mechanism, which protects the clutch from extreme stress.



- ▶ Indicator lamp lights up yellow: transmission too hot.  
Avoid high engine stress and frequent starts.
- ▶ Indicator lamp lights up red: transmission is overheating.  
Further driving at a moderate pace is possible. At the next opportunity, stop the vehicle, shut off the engine and allow the transmission to cool down.

Avoid fast starts, and on inclines did not accelerate lightly while letting the clutch slip; otherwise, the transmission may overheat.

During traffic jams or at very low speeds, use the Low Speed Assistant, refer to page 76.

# Displays

## Vehicle features and options

This chapter describes all standard, country-specific and optional features offered with the series. It also describes features that are not necessarily available in your vehicle, e. g., due

to the selected options or country versions. This also applies to safety-related functions and systems. When using these functions and systems, the applicable country provisions must be observed.

## Overview, instrument cluster

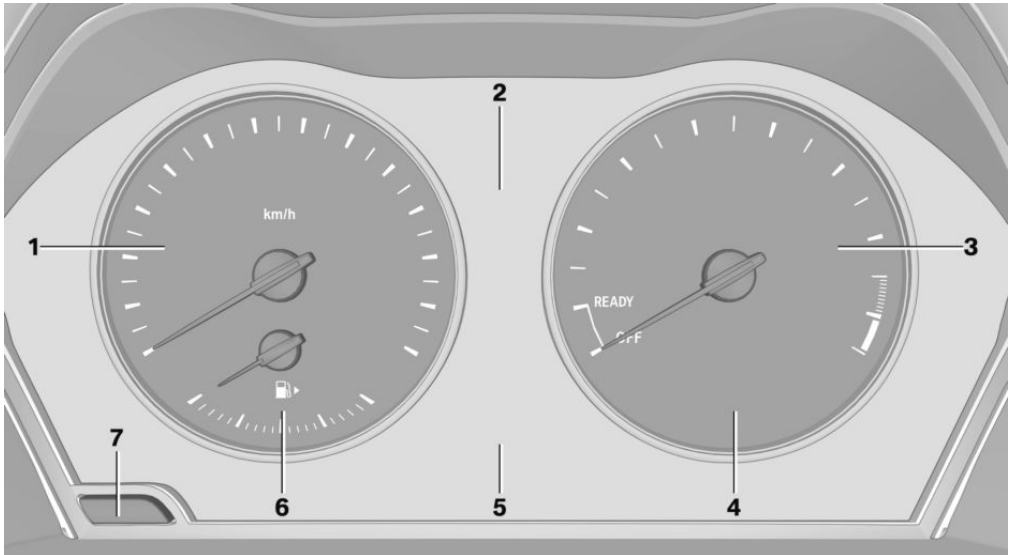

- |   |                               |   |  |
|---|-------------------------------|---|--|
| 1 | Speedometer                   | 5 | Electronic displays <a href="#">79</a> |
| 2 | Messages, e.g., Check Control | 6 | Fuel gauge <a href="#">83</a>          |
| 3 | Tachometer <a href="#">83</a> | 7 | Reset miles <a href="#">84</a>         |
| 4 | Current fuel consumption      |   |  |

## Electronic displays

- ▷ Selection lists, refer to page [88](#).
- ▷ External temperature, refer to page [84](#).
- ▷ Auto Start/Stop function, refer to page [68](#).
- ▷ On-board computer, refer to page [88](#).
- ▷ Date, refer to page [84](#).
- ▷ Energy recovery, refer to page [85](#).
- ▷ Miles/trip miles, refer to page [83](#).

- ▷ Messages, e.g., Check Control, refer to page 80.
- ▷ Range, refer to page 84.
- ▷ Status, Driving Dynamics Control, refer to page 117.
- ▷ Service requirements, refer to page 85.
- ▷ Speed Limit Info, refer to page 86.
- ▷ Time, refer to page 84.

## Check Control

### The concept

The Check Control system monitors functions in the vehicle and notifies you of malfunctions in the monitored systems.

A Check Control message is displayed as a combination of indicator or warning lights and text messages in the instrument cluster.

In addition, an acoustic signal may sound and a text message may appear on the Control Display.

### Indicator/warning lights

#### General information

The indicator and warning lights in the instrument cluster can light up in a variety of combinations and colors.

Several of the lights are checked for proper functioning and light up temporarily when the engine is started or the ignition is switched on.

#### Red lights

#### Safety belt reminder



Safety belt on the driver's side is not buckled. For some country-specific models: passenger belt is not worn or objects are detected on the front passenger seat.

Indicator lamp flashes or is illuminated: safety belt on the driver or passenger side is not

buckled. The safety belt reminder can also be activated if objects are placed on the front passenger seat.

Make sure that the safety belts are positioned correctly.

#### Airbag system



Airbag system and belt tensioner are not working.

Have the vehicle checked immediately by a dealer's service center or another qualified service center or repair shop.

#### Parking brake, brake system



For additional information, see Releasing the parking brake, refer to page 70.



#### Approach control warning



Indicator lamp illuminates: advance warning is issued, for example when there is the impending danger of a collision or the distance to the vehicle ahead is too small.

Increase distance.

Indicator lamp flashes: acute warning of the imminent danger of a collision when the vehicle approaches another vehicle at a relatively high differential speed.

Intervention by braking or make an evasive maneuver.

#### Person warning



Symbol in the instrument cluster.

If a collision with a person detected in this way is imminent, the symbol lights up and a signal sounds.

## Yellow lights

### Anti-lock Braking System ABS



Braking force boost may not be working. Avoid abrupt braking. Take the longer braking distance into account.



Have the system immediately checked by a dealer's service center or another qualified service center or repair shop.

### DSC Dynamic Stability Control



The indicator lamp flashes: DSC controls the drive and braking forces. The vehicle is stabilized. Reduce speed and adapt driving style to the driving circumstances.

The indicator lamp lights up: DSC has malfunctioned.

Have the system checked by a dealer's service center or another qualified service center or repair shop.

For additional information, refer to Dynamic Stability Control DSC, refer to page 115.

### DSC Dynamic Stability Control deactivated



DSC Dynamic Stability Control is deactivated.

For additional information, refer to Dynamic Stability Control DSC, refer to page 115.

### M Dynamic Mode MDM



M Dynamic Mode MDM is switched on.

For more information, see M Dynamic Mode, refer to page 116.



Indicator lamp also flashes: MDM controls the drive and brake forces. The vehicle is stabilized.



The indicator lamp illuminates: MDM has malfunctioned. Have the system checked by a dealer's service center or another qualified service center or repair shop.



For more information, see M Dynamic Mode, refer to page 116.

### Flat Tire Monitor FTM



The Flat Tire Monitor signals a loss of tire inflation pressure in a tire.

Reduce your speed and stop cautiously. Avoid sudden braking and steering maneuvers.

For more information, see Flat Tire Monitor, refer to page 105.

### Tire Pressure Monitor TPM



The indicator lamp is illuminated.

The Tire Pressure Monitor reports a low tire inflation pressure or a flat tire.

Observe the information in the Check Control message.

The indicator lamp flashes and is then illuminated continuously.

No flat tire or loss of tire inflation pressure can be detected.

- ▶ Interference caused by systems or devices with the same radio frequency: After leaving the area of the interference, the system automatically becomes active again.
- ▶ TPM was unable to complete the reset. Reset the system again.
- ▶ A wheel without TPM electronics is mounted: Have it checked by a dealer's service center or another qualified service center or repair shop as needed.
- ▶ Malfunction: have the system checked by a dealer's service center or another qualified service center or repair shop.

For more information, see Tire Pressure Monitor, refer to page 101.

### Steering system



Steering system in some cases not working.

Have the steering system checked by a dealer's service center or another qualified service center or repair shop.

### Engine functions



Engine function impaired.

Have the vehicle checked by a dealer's service center or another qualified service center or repair shop.

For additional information, refer to On-board Diagnostics socket, refer to page 188.

### Lane departure warning



System is switched on and under certain circumstances warns if a detected lane is left without flashing beforehand.

For additional information, refer to Lane departure warning, refer to page 112.

### Green lights

#### Turn signal



Turn signal switched on.

Unusually rapid flashing of the indicator lamp indicates that a turn signal bulb has failed.

For additional information, refer to Turn signal, refer to page 70.

### Parking lights, headlight



Parking lights or headlights are activated.

### High-beam Assistant



High-beam Assistant is switched on.

High beams are switched on and off automatically depending on the traffic situation.

For additional information, refer to High-beam Assistant, refer to page 95.

### Cruise control



The system is switched on. It maintains the speed that was set using the control elements on the steering wheel.

### Blue lights

#### High beams



High beams are activated.

For additional information, see High beams, refer to page 71.

### General lamps

#### Check Control



At least one Check Control message is displayed or is stored.

### SMS text messages

SMS text messages in combination with a symbol in the instrument cluster explain a Check Control message and the meaning of the indicator and warning lights.



### Supplementary text messages

Additional information, such as on the cause of an error or the required action, can be called up via Check Control.

With urgent messages the added text will be automatically displayed on the Control Display.

## Symbols

Within the supplementary text, the following functions can be selected independent of the check control message.

- ▶  Display additional information about the Check Control message in the Integrated Owner's Manual.
- ▶  "Service request"  
Contact a dealer's service center or another qualified service center or repair shop.
- ▶  "Roadside Assistance"  
Contact Roadside Assistance.

## Hiding Check Control messages

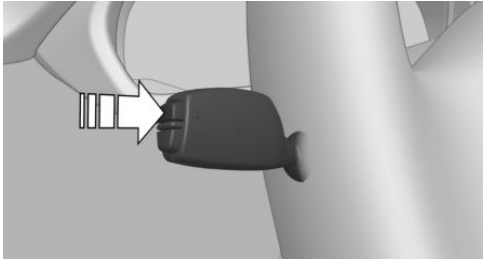

Press and hold button on signal lever.

- ▶ Some Check Control messages are displayed continuously and are not cleared until the malfunction is eliminated. If several malfunctions occur at once, the messages are displayed consecutively.  
These messages can be hidden for approx. 8 seconds. After this time, they are displayed again automatically.
- ▶ Other Check Control messages are hidden automatically after approx. 20 seconds. They are stored and can be displayed again later.

## Displaying stored Check Control messages

On the Control Display:

1. "Vehicle info"
2. "Vehicle status"
3.  "Check Control"
4. Select the text message.

## Messages after trip completion

Special messages displayed while driving are displayed again after the ignition is switched off.

## Fuel gauge

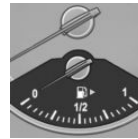

Vehicle tilt position may cause the display to vary.

Depending on the equipment version, the arrow beside the fuel pump symbol shows which side of the vehicle the fuel filler flap is on.

Notes on refueling, refer to page 164.



The yellow indicator lamp illuminates, once the fuel reserve is reached.

## Tachometer

Always avoid engine speeds in the red warning field. In this range, the fuel supply is interrupted to protect the engine.

## Odometer and trip odometer

### Display

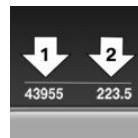

- ▶ Odometer, arrow 1.
- ▶ Trip odometer, arrow 2.

## Show/reset miles



Press the button.

▷ When the ignition is switched off, the time, the external temperature and the odometer are displayed.

▷ When the ignition is switched on, the trip odometer is reset.

## External temperature

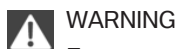

### WARNING

Even at temperatures above +37 °F/+3 °C there can be a risk of icy roads, e.g., on bridges or shady sections of road. There is a risk of an accident. Adjust your driving style to the weather conditions at low temperatures. ◀

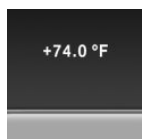

If the indicator drops to +37 °F/+3 °C or lower, a signal sounds.

A Check Control message is displayed.

There is an increased risk of ice on roads.

## Time

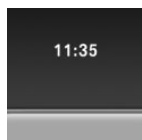

The time is displayed in the instrument cluster.

The time can be set on the Control Display.

## Date

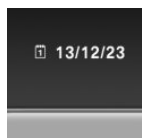

The date is displayed in the instrument cluster.

The date can be set on the Control Display.

## Range

### Display

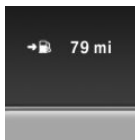

With a low remaining range:

▷ A Check Control message is displayed briefly.

▷ The remaining range is shown on the onboard computer.

▷ With a dynamic driving style, e.g., taking curves aggressively, the engine function is not always ensured.

The Check Control message appears continuously below a range of approx. 30 miles/50 km.



### NOTE

With a range of less than 30 miles/50 km it is possible that the engine will no longer have sufficient fuel. Engine functions are not ensured anymore. There is a risk of property damage. Refuel promptly. ◀

## Current fuel consumption

### Instrument cluster



Displays the current fuel consumption. Check whether you are currently driving in an efficient and environmentally-friendly manner.

### Displaying the current fuel consumption

Depending on your vehicle's optional features, the current fuel consumption can also be displayed as bar in the instrument cluster.

1. "Settings"
2. "Instrument cluster"
3. "Additional indicators"

## Energy recovery

### Display



The energy of motion of the vehicle is converted to electrical energy while coasting. The vehicle battery is partially charged and fuel consumption can be reduced.

## EfficientDynamics display

### Displaying Efficient Dynamics

Information on fuel consumption and technology can be displayed while driving.

1. "Vehicle info"
2. "EfficientDynamics"

### Displaying fuel consumption history

The average fuel consumption can be displayed within an adjustable time frame.

 "Consumption history"

### Adjusting fuel consumption history time frame

 Select the symbol.

### Resetting fuel consumption history

1. Open "Options".
2. "Reset consumption history"

### Displaying EfficientDynamics info

The current efficiency can be displayed.

 "EfficientDynamics info"

The following systems are displayed:

- ▶ Auto Start/Stop function.
- ▶ Energy recovery.
- ▶ Climate control output.

## Service requirements

### General information

After the ignition is turned on the instrument cluster briefly displays available driving distance or time to the next scheduled maintenance.

A service advisor can read out the current service requirements from your remote control.



### Display

### Detailed information on service requirements

More information on the scope of service required can be displayed on the Control Display.

1. "Vehicle info"
2. "Vehicle status"
3.  "Service required"  
Required maintenance procedures and legally mandated inspections are displayed.
4. Select an entry to call up detailed information.

### Symbols

Symbols	Description
	No service is currently required.
	The deadline for scheduled maintenance or a legally mandated inspection is approaching.
	The service deadline has already passed.

### Entering appointment dates

Enter the dates for the required inspections.

Make sure that the vehicle's date and time are set correctly.

On the Control Display:

1. "Vehicle info"
2. "Vehicle status"
3.  "Service required"
4. "§ Vehicle inspection"
5. "Date:"
6. Adjust the settings.
7. Confirm.

The entered date is stored.

### Automatic Service Request

Data regarding the service status or legally mandated vehicle inspections is automatically transmitted to your dealer's service center before a service due date.

You can check when your dealer's service center was notified.

On the Control Display:

1. "Vehicle info"
2. "Vehicle status"
3. Open "Options".
4. "Last Service Request"

## Gear shift indicator

### Concept

The system recommends the most fuel efficient gear for the current driving situation.





### General information

The gear shift indicator is active in the sequential mode of the M double clutch transmission and for the manual transmission.

Suggestions to shift gear up or down are displayed in the instrument cluster.

On vehicles without a gear shift indicator, the engaged gear is displayed.

## Manual transmission: displaying

Symbol	Description
	Fuel efficient gear is set.
	Shift up to fuel efficient gear.
	Shift down to fuel efficient gear.
	Shift into neutral.

## M double-clutch transmission: displaying

Example	Description
	Fuel efficient gear is set.
	Shift into fuel efficient gear.

## Speed Limit Info

### Speed Limit Info

#### Concept

Speed Limit Info shows the current maximum permitted speed in the instrument cluster.

#### General information

The camera in the area of the interior mirror detects traffic signs at the edge of the road as well as variable overhead sign posts. Traffic signs with extra symbols for wet road conditions, etc. are also detected and compared with the vehicle's onboard data, such as for the rain sensor, and will be displayed depending on the situation. The system takes into ac-

count the information stored in the navigation system and also displays speed limits present on routes without signs.

## Safety information



### WARNING

The system does not release from the personal responsibility to correctly assess visibility and traffic situation. There is a risk of an accident. Adjust the driving style to the traffic conditions. Watch traffic closely and actively intervene in the respective situations. ◀

## Overview

### Camera

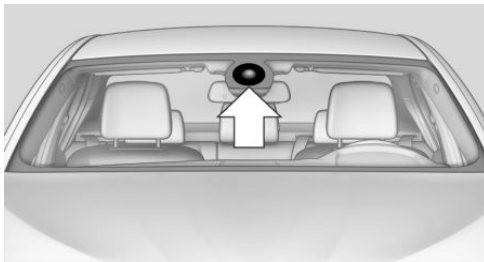

The camera is installed near the interior mirror. Keep the windshield in front of the interior mirror clean and clear.

### Switching on/off

On the Control Display:

1. "Settings"
2. "Instrument cluster"
3. "Speed limit information"

If Speed Limit Info is switched on, it can be displayed on the CID (central information display) in the instrument cluster via the onboard computer.

### Display

The following is displayed in the instrument cluster:

## Speed Limit Info



Current speed limit.



Speed Limit Info not available.

## System limits

The system may not be fully functional and may provide incorrect information in the following situations:

- ▷ In heavy fog, rain or snowfall.
- ▷ When signs are fully or partially concealed by objects, stickers or paint.
- ▷ When driving very close to the vehicle in front of you.
- ▷ When driving toward bright lights or strong reflections.
- ▷ When the windshield in front of the interior mirror is fogged over, dirty or covered by a sticker, etc.
- ▷ In the event of incorrect detection by the camera.
- ▷ If the speed limits stored in the navigation system are incorrect.
- ▷ In areas not covered by the navigation system.
- ▷ When roads differ from the navigation, such as due to changes in road routing.
- ▷ When passing buses or trucks with a speed sticker.
- ▷ If the traffic signs are non-conforming.
- ▷ During calibration of the camera immediately after vehicle delivery.
- ▷ When signs that are valid for a parallel road are detected.

## Selection lists in the instrument cluster

### General information

Depending on your vehicle's equipment, the following can be displayed or operated using the buttons and the thumbwheel on the steering wheel and the display in the instrument cluster:

- ▷ Current audio source.
- ▷ Redial phone feature.
- ▷ Turn on voice activation system.

It also displays programs of the Driving Dynamics Control.

### Activating a list and adjusting the setting

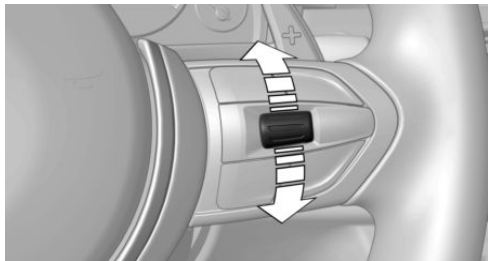

On the right side of the steering wheel, turn the thumbwheel to activate the corresponding list.

1. Turn the thumbwheel and select the desired setting.
2. Press the thumbwheel.

### Display

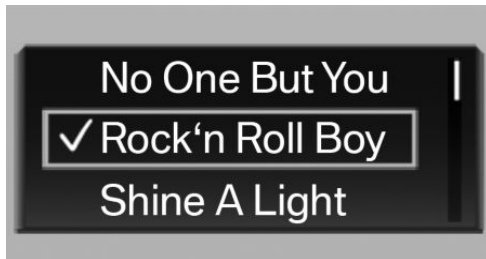

Depending on your vehicle's optional features, the list in the instrument cluster can differ from the illustration shown.

## Onboard computer

### Calling up information on the CID (central information display)

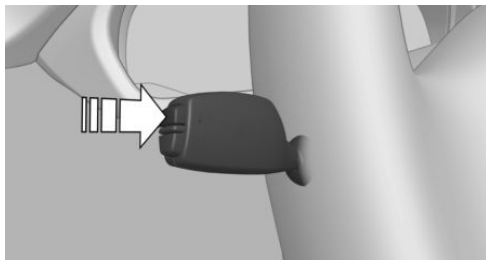

Press and hold button on signal lever.

Information is displayed in the CID (central information display) of the instrument cluster.

### Information at a glance

#### CID (central information display)

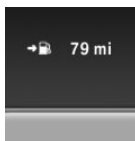

Repeatedly pressing the button on the turn signal lever calls up the following information in the CID (central information display):

- ▷ Range.
- ▷ Average consumption, fuel.
- ▷ Current consumption, fuel.

- ▷ Average speed.
- ▷ Date.
- ▷ Engine temperature display.
- ▷ Speed Limit Info.
- ▷ Time of arrival.  
When destination guidance is activated in the navigation system.
- ▷ Distance to destination.  
When destination guidance is activated in the navigation system.
- ▷ Arrow view of navigation system.  
When destination guidance is activated in the navigation system.

## Selecting information

Depending on the vehicle equipment version, you can select what information from the on-board computer is to be displayed on the info display of the instrument cluster.

On the Control Display:

1. "Settings"
2. "Instrument cluster"
3. Select the desired information.

Settings are stored for the profile currently used.

## Information in detail

### Range

Displays the estimated cruising range available with the remaining fuel.

It is calculated based on your driving style over the last 20 miles/30 km.

### Average fuel consumption

The average fuel consumption is calculated for the period while the engine is running.

The average fuel consumption is calculated for the distance traveled since the last reset by the onboard computer.

## Average speed

Periods in which the vehicle is parked with the engine manually stopped are not included in the calculation of the average speed.

## Resetting average values

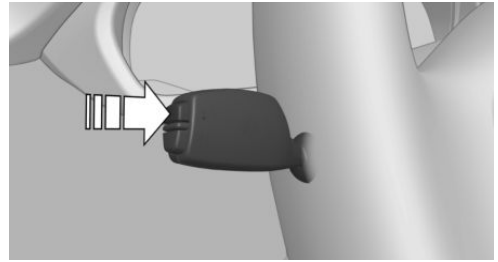

Press and hold button on turn signal lever.

## Engine temperature display

Displays the current engine temperature, based on a combination of coolant and engine oil temperature. As soon as the optimum operating temperature has been attained, the indicator is in the center position.

If the engine oil or coolant, thus the engine, become too hot, a Check Control message is displayed.

Check the coolant level, refer to page 185.

## Distance to destination

The distance remaining to the destination is displayed if a destination is entered in the navigation system before the trip is started.

The distance to the destination is adopted automatically.

## Time of arrival

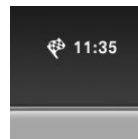

The estimated time of arrival is displayed if a destination is entered in the navigation system before the trip is started.

The time must be correctly set.

## Speed Limit Info

Further information, see chapter Speed Limit Info.

## Trip onboard computer

The vehicle features two types of onboard computers.

- ▷ "Onboard info": the values can be reset as often as necessary.
- ▷ "Trip computer": the values provide an overview of the current trip.

## Resetting the trip onboard computer

On the Control Display:

1. "Vehicle info"
2. "Trip computer"
3. "Reset": all values are reset.  
"Automatically reset": all values are reset approx. 4 hours after the vehicle came to a standstill.

## Display on the Control Display

Display the onboard computer or trip onboard computer on the Control Display.

On the Control Display:

1. "Vehicle info"
2. "Onboard info" or "Trip computer"

## Resetting the fuel consumption and speed

On the Control Display:

1. "Vehicle info"
2. "Onboard info"
3. "Consumpt." or "Speed"
4. "Yes"

## Sport displays

### The concept

On the Control Display, the current values for performance and torque can be displayed if the vehicle is appropriately equipped.

### Displaying sport displays

1. "Vehicle info"
2. "Sport displays"

## Speed warning

### Concept

A speed limit can be set that when reached will cause a warning to be issued.

### General information

The warning is repeated if the vehicle speed drops below the set speed limit once by at least 3 mph/5 km/h.

### Displaying, setting or changing the speed warning

On the Control Display:

1. "Settings"
2. "Speed"
3. "Warning at:"
4. Turn the controller until the desired speed is displayed.
5. Press the controller.  
Speed warning is stored.

### Activating/deactivating the speed warning

On the Control Display:

1. "Settings"
2. "Speed"
3. "Warning"
4. Press the controller.

## Setting your current speed as the speed warning

On the Control Display:

1. "Settings"
2. "Speed"
3. "Select current speed"
4. Press the controller.

The current vehicle speed is stored as the speed warning.

## Settings on the Control Display

### Time

#### Setting the time zone

1. "Settings"
2. "Time/Date"
3. "Time zone:"
4. Select the desired time zone.

The time zone is stored.

#### Setting the time

1. "Settings"
2. "Time/Date"
3. "Time:"
4. Turn the controller until the desired hours are displayed.
5. Press the controller.
6. Turn the controller until the desired minutes are displayed.
7. Press the controller.

The time is stored.

#### Setting the time format

1. "Settings"
2. "Time/Date"

3. "Format:"
4. Select the desired format.

The time format is stored.

### Automatic time setting

Depending on your vehicle's optional features, the time, date and, if needed, the time zone are updated automatically.

1. "Settings"
2. "Time/Date"
3. "Auto time set"

### Date

#### Setting the date

1. "Settings"
2. "Time/Date"
3. "Date:"
4. Turn the controller until the desired day is displayed.
5. Press the controller.
6. Make the necessary settings for the month and year.

The date is stored.

#### Setting the date format

1. "Settings"
2. "Time/Date"
3. "Format:"
4. Select the desired format.

The date format is stored.

### Language

#### Setting the language

To set the language on the Control Display:

1. "Settings"
2. "Language/Units"
3. "Language:"
4. Select the desired language.

Settings are stored for the profile currently used.

2. "GPS tracking"
3. "GPS tracking"

### Setting the voice dialog

Voice dialog for the voice activation system, refer to page 27.

## Units of measurement

### Setting the units of measurement

To set the units for fuel consumption, route/distance and temperature:

1. "Settings"
2. "Language/Units"
3. Select the desired menu item.
4. Select the desired unit.

Settings are stored for the profile currently used.

## Brightness

### Setting the brightness

To set the brightness of the Control Display:

1. "Settings"
2. "Control display"
3. "Brightness"
4. Turn the controller until the desired brightness is set.
5. Press the controller.

Settings are stored for the profile currently used.

Depending on the light conditions, the brightness settings may not be clearly visible.

### Activating/deactivating the display of the current vehicle position

If GPS geolocation has been activated, the current vehicle position can be displayed in the BMW ConnectedDrive app or in the ConnectedDrive customer portal.

1. "Settings"

# Lights

## Vehicle features and options

This chapter describes all standard, country-specific and optional features offered with the series. It also describes features that are not necessarily available in your vehicle, e. g., due to the selected options or country versions. This also applies to safety-related functions and systems. When using these functions and systems, the applicable country provisions must be observed.



## Overview



### Switches in the vehicle



The light switch element is located next to the steering wheel.

### Light functions

Symbol	Function
	Automatic headlamp control Adaptive Light Control
	Lights off Daytime running lights
	Parking lights

Symbol	Function
	Low beams
	Instrument lighting



## Parking lights, cornering lights and roadside parking lights

### General information

Position of switch: 0, , 

If the driver door is opened with the ignition switched off, the exterior lighting is automatically switched off at these switch settings.

### Parking lights

Position of switch:  

The vehicle is illuminated on all sides.

Do not use the parking lights for extended periods; otherwise, they might drain the battery and it would then be impossible to start the engine.

When parking, switch on the one-sided roadside parking lamp, refer to page 93.

### Low beams

Position of switch: 

The low beams light up when the ignition is switched on.

### Roadside parking lights

#### Concept

The vehicle can be illuminated on one side.

## Switching on

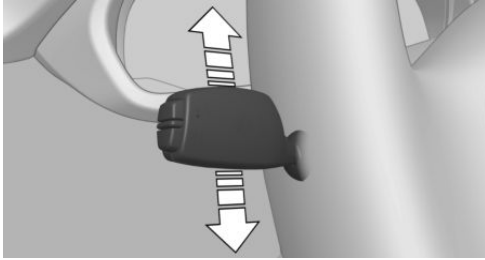

With the ignition switched off, press the lever either up or down past the resistance point for approx. 2 seconds.



## Switching off

Briefly press the lever to the resistance point in the opposite direction.

## Welcome lights and headlamp courtesy delay feature

### Welcome lights

#### General information

Depending on the equipment, when switching off the vehicle, switch position  or .

Depending on the ambient brightness, individual light functions may be switched on briefly, when the vehicle is unlocked.

#### Activating/deactivating

On the Control Display:

1. "Settings"
2. "Lighting"
3. "Welcome lights"

Settings are stored for the profile currently used.

## Headlamp courtesy delay feature

### General information

The low beams stay lit for a short while if the headlight flasher is switched on after the radio-ready state is switched off.

### Setting the duration

On the Control Display:

1. "Settings"
2. "Lighting"
3. "Pathway lighting:"
4. Set length of time.

Settings are stored for the profile currently used.

## Automatic headlamp control

### Concept

The low beams are switched on and off automatically depending on the ambient brightness, e.g., in tunnels, in twilight or if there is precipitation.

### General information

A blue sky with the sun low on the horizon can cause the lights to be switched on.

When emerging from a tunnel during the day, the low beams are not switched off immediately but instead only after approx. 2 minutes.

### Activating

Position of switch: 

The indicator lamp in the instrument cluster is illuminated when the low beams are switched on.

### System limits

The automatic headlamp control cannot serve as a substitute for your personal judgment of lighting conditions.

For example, the sensors are unable to detect fog or hazy weather. To avoid safety risks under these conditions, you should always switch on the lights manually.

## Daytime running lights

### General information

Position of switch: 0 ,  , 

The daytime running lights light up when the ignition is switched on. After the ignition is switched off, the parking lights light up in position  .

### Activating/deactivating

In some countries, daytime running lights are mandatory, so it may not be possible to deactivate the daytime running lights.

On the Control Display:

1. "Settings"
2. "Lighting"
3. "Daytime running lamps"

Settings are stored for the profile currently used.

## Adaptive Light Control

### The concept

Adaptive Light Control is a variable headlight control system that enables dynamic illumination of the road surface.

### General information

Depending on the steering angle and other parameters, the light from the headlight follows the course of the road.

To avoid blinding oncoming traffic, the Adaptive Light Control does not swivel to the driver's side when the vehicle is at a standstill.

### Activating

Position of switch  with the ignition switched on.

### Malfunction

A Check Control message is displayed.

Adaptive Light Control is malfunctioning or has failed. Have the system immediately checked by a dealer's service center or another qualified service center or repair shop.

## High-beam Assistant

### Concept

The high-beam Assistant detects other traffic participants early on and automatically switches the high beams on or off depending on the traffic situation. The assistant ensures that the high beams are switched on, whenever the traffic situation allows. In the low speed range, the high beams are not switched on by the system.



### General information

The system responds to light from oncoming traffic and traffic driving ahead of you, and to adequate illumination, e.g., in towns and cities.

The driver can intervene at any time and switch the high beams on and off as usual.

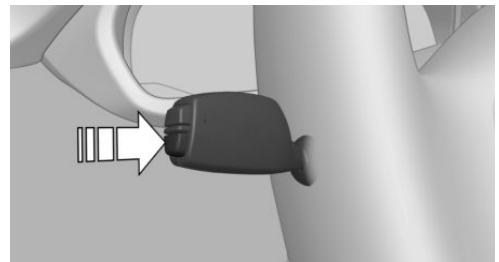
### Activating



1. Depending on the equipment, turn the light switch into position  or  .

- Press button on the turn signal lever, arrow.



The indicator lamp in the instrument cluster is illuminated when the low beams are switched on.

The high beams are switched on and off automatically.



The blue indicator lamp in the instrument cluster lights up when the system switches on the high beams.

## Deactivating

The High-beam Assistant is deactivated when manually switching the high beams on and off, refer to page 71. To reactivate the high-beam Assistant, press the button on the turn signal lever.

## System limits

The high-beam Assistant cannot serve as a substitute for the driver's personal judgment of when to use the high beams. Therefore, manually switch off the high beams in situations where required to avoid a safety risk.

The system is not fully functional in the following situations, and driver intervention may be necessary:

- ▷ In very unfavorable weather conditions, such as fog or heavy precipitation.
- ▷ When detecting poorly-lit road users such as pedestrians, cyclists, horseback riders and wagons; when driving close to train or ship traffic; and at animal crossings.
- ▷ In tight curves, on hilltops or in depressions, in cross traffic or half-observed oncoming traffic on highways.
- ▷ In poorly-lit towns and cities and in the presence of highly reflective signs.
- ▷ When the windshield in front of the interior mirror is fogged over, dirty or covered with stickers, etc.

## Instrument lighting

### Settings



The parking lights or low beams must be switched on to adjust the brightness.

Adjust the brightness with the thumbwheel.

## Interior lights

### General information

Depending on the equipment, the interior lights, footwell lights, entry lamps, and courtesy lamps are controlled automatically.

Thumb wheel for the instrument lighting controls brightness of some of these features.

### Overview



- Interior lights
- Reading lights

### Switching the interior lights on and off



Press button.

To switch off permanently: press the button for approx. 3 seconds.

Switch back on: press button.

## Switching the reading lamps on and off manually



Press button.

Reading lights are located at the front and rear next to the interior lights.

## Ambient light

Depending on your optional features lighting can be adjusted for some lights in the interior.

## Selecting color scheme

On the Control Display:

1. "Settings"
2. "Lighting"
3. "Ambient:"
4. Select the desired setting.

With a color scheme selected and welcome lights activated they light up in the line's color when vehicle is unlocked.

## Setting the brightness

Depending on the equipment, the brightness of the ambient light can be adjusted via the thumbwheel for the instrument lighting or on the Control Display.

On the Control Display:

1. "Settings"
2. "Lighting"
3. "Brightness:"
4. Adjust the brightness.

# Safety

## Vehicle features and options

This chapter describes all standard, country-specific and optional features offered with the series. It also describes features that are not necessarily available in your vehicle, e. g., due

to the selected options or country versions. This also applies to safety-related functions and systems. When using these functions and systems, the applicable country provisions must be observed.

## Airbags

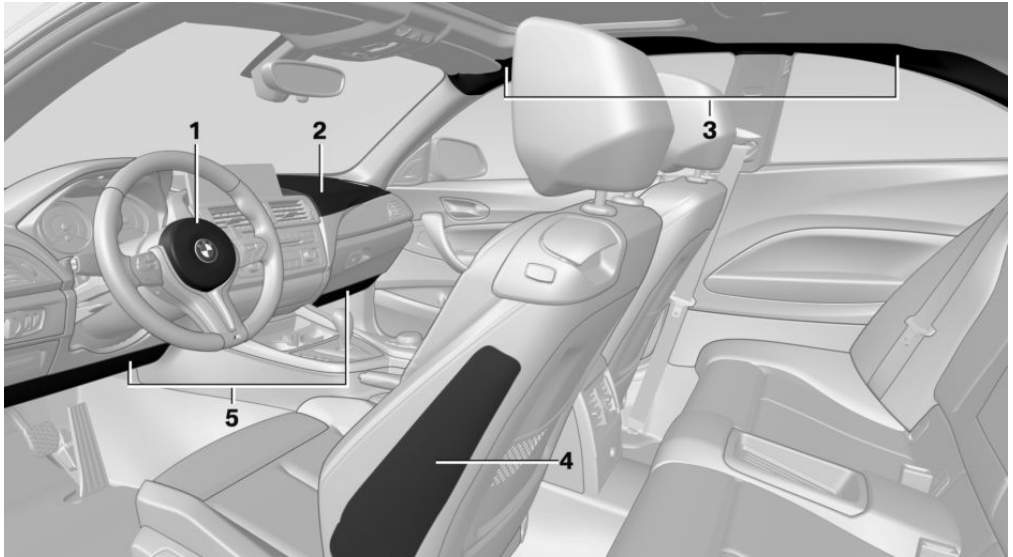

- |   |                               |   |             |
|---|-------------------------------|---|-------------|
| 1 | Front airbag, driver          | 4 | Side airbag |
| 2 | Front airbag, front passenger | 5 | Knee airbag |
| 3 | Head airbag                   |   |             |

### Front airbags

Front airbags help protect the driver and front passenger by responding to frontal impacts in which safety belts alone would not provide adequate restraint.

### Side airbag

In a lateral impact, the side airbag supports the side of the body in the chest and lap area.

### Head airbag

In a lateral impact, the head airbag supports the head.

## Ejection Mitigation

The head airbag system is designed as an ejection mitigation countermeasure to reduce the likelihood of ejections of vehicle occupants through side windows during rollovers or side impact events.

## Knee airbag

The knee airbag supports the legs in a frontal impact.

## Protective action

Airbags are not triggered in every impact situation, e.g., in less severe accidents or rear-end collisions.

## Information on optimum effect of the airbags



### WARNING

If the seat position is incorrect or the deployment area of the airbags is impaired, the airbag system cannot protect as intended or may cause additional injuries due to triggering. There is a risk of injuries or danger to life. Follow the information on optimum protective effect of the airbag system. ◀

- ▷ Keep a distance from the airbags.
- ▷ Make sure that occupants keep their heads away from the side airbag.
- ▷ Always grasp the steering wheel on the steering wheel rim. Hold your hands at the 3 o'clock and 9 o'clock positions, to keep the risk of injury to your hands or arms as low as possible when the airbag is triggered.
- ▷ Make sure that the front passenger is sitting correctly, i.e., keeps his or her feet and legs in the floor area and does not support them on the dashboard.
- ▷ There should be no additional persons, animals or objects between an airbag and a person.

- ▷ Do not apply adhesive materials to the airbag cover panels, do not cover them or modify them in any way.
- ▷ Dashboard and windshield on the front passenger side must stay clear - do not attach adhesive labels or coverings and do not attach brackets or cables, for instance for GPS devices or mobile phones.
- ▷ Do not use the cover of the front airbag on the front passenger side as a storage area.
- ▷ Do not place slip covers, seat cushions or other objects on the front passenger seat that are not specifically suited for seats with integrated side airbags.
- ▷ Do not hang pieces of clothing, such as jackets, over the backrests.
- ▷ Never modify either the individual components or the wiring in the airbag system. This also applies to steering wheel covers, the dashboard, and the seats.
- ▷ Do not remove the airbag system.

Even when you follow all instructions very closely, injury from contact with the airbags cannot be fully ruled out in certain situations.

The ignition and inflation noise may lead to short-term and, in most cases, temporary hearing impairment in sensitive occupants.

Vehicle modifications for a person with disabilities may affect the air bag system; therefore, contact BMW Customer Relations or your authorized BMW service center.

Warnings and information on the airbags are also found on the sun visors.

## Functional readiness of the airbag system

### Safety information



### WARNING

Individual components can be hot after triggering of the airbag system. There is a risk of injury. Do not touch individual components. ◀

**WARNING**

Improperly executed work can lead to failure, malfunction or unintentional triggering of the airbag system. In the case of a malfunction, the airbag system might not trigger as intended in the event of an accident despite respective accident severity. There is a risk of injuries or danger to life. Have the airbag system checked, repaired, dismantled and scrapped by a dealer's service center or another qualified service center or repair shop. ◀

**Correct function**

When the ignition is switched on, the warning lamp in the instrument cluster lights up briefly and thereby indicates the operational readiness of the entire airbag system and the belt tensioner.

**Airbag system malfunctioning**

- ▷ Warning lamp does not come on when the ignition is turned on.
- ▷ The warning lamp lights up continuously.

**Automatic deactivation of the front-seat passenger airbags****Concept**

The system reads if the front passenger seat is occupied by measuring the human body's resistance.

Front, knee and side airbag on the front passenger's side are either activated or deactivated.

**General information**

Before transporting a child on the front passenger seat, refer to the safety notes and instructions for children on the front passenger seat, see Children.

**Safety information****WARNING**

To ensure the front-seat passenger airbag function, the system must be able to detect whether a person is sitting in the front passenger seat. The entire seat cushion area must be used for this purpose. There is a risk of injuries or danger to life. Make sure that the front passenger keeps his or her feet in the floor area. ◀

**Malfunction of the automatic deactivation system**

When transporting older children and adults, the front-seat passenger airbags may be deactivated in certain sitting positions. In this case, the indicator lamp for the front-seat passenger airbags lights up.

In this case, change the sitting position so that the front-seat passenger airbags are activated and the indicator lamp goes out.

If it is not possible to activate the airbags, have the person sit in the rear.

To enable correct recognition of the occupied seat cushion

- ▷ Do not attach covers, cushions, ball mats or other items to the front passenger seat unless they are specifically determined to be safe for use on the front passenger seat.
- ▷ Do not place any electronic devices on the passenger seat if a child restraint system is to be installed on it.
- ▷ Do not place objects under the seat that could press against the seat from below.
- ▷ No moisture in or on the seat.

## Indicator lamp for the front-seat passenger airbags



The indicator lamp for the front-seat passenger airbags indicates the operating state of the front-seat passenger airbags.

The lamp indicates whether the airbags are either activated or deactivated.



- ▶ The indicator lamp lights up when a child is properly seated in a child restraint fixing system or when the seat is empty. The airbags on the front passenger side are not activated.
- ▶ The indicator lamp does not light up when, e.g., a correctly seated person of sufficient size is detected on the seat. The airbags on the front passenger side are activated.

## Detected child seats

The system generally detects children seated in a child seat, particularly in child seats required by NHTSA at the point in time when the vehicle was manufactured. After installing a child seat, make sure that the indicator lamp for the front-seat passenger airbags lights up. This indicates that the child seat has been detected and the front-seat passenger airbags are not activated.

## Strength of the driver's and front-seat passenger airbag

The explosive power that activates driver's/front passenger's airbags very much depends

on the positions of the driver's/front passenger's seat.

To maintain the accuracy of this function over the long term, calibrate the front seats as soon as a respective message appears on the Control Display.

## Calibrating the front seats



### WARNING

There is a risk of jamming when moving the seats. There is a risk of injury or risk of property damage. Make sure that the area of movement of the seat is clear prior to any adjustment. ◀

A corresponding message appears on the Control Display.

1. Press the switch and move the respective seat all the way forward.
2. Press the switch forward again. The seat still moves forward slightly.
3. Readjust the seat to the desired position.

The calibration procedure is completed when the message on the Control Display disappears.

If the message continues to be displayed, repeat the calibration.

If the message does not disappear after a repeat calibration, have the system checked as soon as possible.

## Tire Pressure Monitor TPM

### Concept

The system monitors tire inflation pressure in the four mounted tires. The system warns you if there is a significant loss of pressure in one or more tires. For this purpose, sensors in the tire valves measure the tire inflation pressure and tire temperature.

## General information

With use of the system observe further information found under Tire inflation pressure, refer to page 168.

## Functional requirements

The system must have been reset with the correct tire inflation pressure; otherwise, reliable signaling of tire inflation pressure loss is not assured.

Reset the system after each adjustment of the tire inflation pressure and after every tire or wheel change.

Always use wheels with TPM electronics to ensure that the system will operate properly.

## Status display

The current status of the Tire Pressure Monitor TPM can be displayed on the Control Display, for example, whether or not the TPM is active.

1. "Vehicle info"
2. "Vehicle status"
3. (!) "Tire Pressure Monitor (TPM)"

The status is displayed.

## Status control display

Tire and system status are indicated by the color of the wheels and a SMS text message on the Control Display.

### All wheels green

System is active and will issue a warning based on the tire inflation pressures stored during the last reset.

### One wheel is yellow

A flat tire or major drop in inflation pressure in the indicated tire.

### All wheels are yellow

A flat tire or major drop in inflation pressure in several tires.

## Wheels, gray

The system cannot detect a flat tire due to a malfunction.

## Status information

The status control display additionally shows the current tire inflation pressures and, depending on the model, tire temperatures. It shows the actual values read; they may vary depending on driving style or weather conditions.

## Reset the system

Reset the system after each adjustment of the tire inflation pressure and after every tire or wheel change.

On the Control Display and on the vehicle:

1. "Vehicle info"
2. "Vehicle status"
3. (!) "Perform reset"
4. Start the engine but do not drive off.
5. Reset tire inflation pressure: "Perform reset".
6. Drive away.

The wheels are displayed in gray and the status is displayed.

After driving faster than 19 mph/30 km/h for a short period, the set tire inflation pressures are accepted as reference values. The reset is completed automatically while driving.

The progress of the reset is displayed.

After a successfully completed Reset, the wheels on the Control Display are shown in green and "Tire Pressure Monitor (TPM) active" is displayed.

You may interrupt this trip at any time. When you continue the reset resumes automatically.

## Messages

### Required tire inflation pressure check message



A Check Control message is displayed.

- ▶ The system has detected a wheel change, but no reset was done.
- ▶ No reset was performed for the system. System will issue a warning related to the tire inflation pressures stored during the last reset.
- ▶ Inflation was not carried out according to specifications.



A Check Control message is displayed.

The tire inflation pressure has fallen below the level of the last reset.

In these cases:

1. Check the tire pressure and correct as needed.
2. Reset the system.

### Message in case of low tire pressure



The yellow warning lamp lights up.



A Check Control message is displayed.

- ▶ There is a tire inflation pressure loss.
- ▶ No reset was performed for the system. System will issue a warning related to the tire inflation pressures stored during the last reset.

In these cases:

1. Reduce your speed and drive moderately. Do not exceed a speed of 80 mph/130 km/h.
2. At the next opportunity, e.g., gas station, check and correct the tire inflation pressure in all four tires, if necessary.

3. Reset the system.

### Message in case of sharp tire inflation pressure loss



The yellow warning lamp lights up.

In addition, a symbol with the affected tires will be displayed in the Check

Control message.

- ▶ There is a flat tire or a major loss in tire inflation pressure.
- ▶ No reset was performed for the system. The system issues a warning based on the tire inflation pressures stored during the last reset.

In these cases:

Reduce your speed and stop cautiously. Avoid sudden braking and steering maneuvers.



#### WARNING

A damaged regular tire with low or missing tire inflation pressure impacts handling, such as steering and braking response. Run-flat tires can maintain limited stability. There is a risk of an accident. Do not continue driving if the vehicle is not equipped with run-flat tires. Follow the information on run-flat tires and continued driving with these tires. ◀

A low tire inflation pressure might turn on DSC Dynamic Stability Control.

### Actions in the event of a flat tire

1. Identify the damaged tire.

Check the air pressure in all four tires, e.g., using the tire pressure gage of a tire repair kit.

If the tire inflation pressure in all four tires is correct, the Tire Pressure Monitor may not have been initialized. In this case, initialize the system.

If identification of flat tire damage is not possible, please contact a dealer's service

center or another qualified service center or repair shop.

2. Repair the flat tire, e.g., with a tire repair kit or by changing the tire.

Use of tire sealant, e.g., the Mobility System, may damage the TPM wheel electronics. In this case, have the electronics checked at the next opportunity and have them replaced, if needed.

## System limits

The system does not function properly if a reset has not been carried out, e.g., a flat tire is reported though tire inflation pressures are correct.

The tire inflation pressure depends on the tire's temperature. Driving or exposure to the sun will increase the tire's temperature, thus increasing the tire inflation pressure. The tire inflation pressure is reduced when the tire temperature falls again. These circumstances may cause a warning when temperatures fall very sharply.

The system cannot indicate sudden serious tire damage caused by external circumstances.

## Malfunction



The yellow warning lamp flashes and then lights up continuously. A Check Control message is displayed. No flat tire or loss of tire inflation pressure can be detected.

Examples and recommendations in the following situations:

- ▶ A wheel without TPM electronics is mounted: Have it checked by a dealer's service center or another qualified service center or repair shop as needed.
- ▶ Malfunction: Have system checked by a dealer's service center or another qualified service center or repair shop.
- ▶ TPM was unable to complete the reset. Reset the system again.

- ▶ Interference caused by systems or devices with the same radio frequency: After leaving the area of the interference, the system automatically becomes active again.

## Declaration according to NHTSA/FMVSS 138 Tire Pressure Monitoring System

Each tire, including the spare (if provided) should be checked monthly when cold and inflated to the inflation pressure recommended by the vehicle manufacturer on the vehicle placard or tire inflation pressure label. (If your vehicle has tires of a different size than the size indicated on the vehicle placard or tire inflation pressure label, you should determine the proper tire inflation pressure for those tires.) As an added safety feature, your vehicle has been equipped with a tire pressure monitoring system (TPMS) that illuminates a low tire pressure telltale when one or more of your tires is significantly under-inflated. Accordingly, when the low tire pressure telltale illuminates, you should stop and check your tires as soon as possible, and inflate them to the proper pressure. Driving on a significantly under-inflated tire causes the tire to overheat and can lead to tire failure. Under-inflation also reduces fuel efficiency and tire tread life, and may affect the vehicle's handling and stopping ability. Please note that the TPMS is not a substitute for proper tire maintenance, and it is the driver's responsibility to maintain correct tire pressure, even if under-inflation has not reached the level to trigger illumination of the TPMS low tire pressure telltale. Your vehicle has also been equipped with a TPMS malfunction indicator to indicate when the system is not operating properly. The TPMS malfunction indicator is combined with the low tire pressure telltale. When the system detects a malfunction, the telltale will flash for approximately one minute and then remain continuously illuminated. This sequence will continue upon subsequent vehicle start-ups as long as the malfunction exists. When the malfunction indicator

is illuminated, the system may not be able to detect or signal low tire pressure as intended. TPMS malfunctions may occur for a variety of reasons, including the installation of replacement or alternate tires or wheels on the vehicle that prevent the TPMS from functioning properly. Always check the TPMS malfunction tell-tale after replacing one or more tires or wheels on your vehicle to ensure that the replacement or alternate tires and wheels allow the TPMS to continue to function properly.

## FTM Flat Tire Monitor

### Concept

The system detects tire inflation pressure loss on the basis of rotation speed differences between the individual wheels while driving.

In the event of a tire inflation pressure loss, the diameter and therefore the rotational speed of the corresponding wheel changes. This will be detected and reported as a flat tire.

The system does not measure the actual inflation pressure in the tires.

### Functional requirements

The system must have been initialized when the tire inflation pressure was correct; otherwise, reliable flagging of a flat tire is not assured. Initialize the system after each correction of the tire inflation pressure and after every tire or wheel change.

### Status display

The current status of the Flat Tire Monitor can be displayed on the Control Display, for example, whether or not the FTM is active.

1. "Vehicle info"
2. "Vehicle status"
3.  "Flat Tire Monitor (FTM)"

The status is displayed.

### Initialization

When initializing, the set tire inflation pressures serve as reference values in order to detect a flat tire. Initialization is started by confirming the tire inflation pressures.

Do not initialize the system when driving with snow chains.

On the Control Display:

1. "Vehicle info"
2. "Vehicle status"
3.  "Perform reset"
4. Start the engine but do not drive off.
5. Start the initialization with "Perform reset".
6. Drive away.

The initialization is completed while driving, which can be interrupted at any time.

The initialization automatically continues when driving resumes.

### Indication of a flat tire



The yellow warning lamp lights up. A Check Control message is displayed.

There is a flat tire or a major loss in tire inflation pressure.

1. Reduce your speed and stop cautiously. Avoid sudden braking and steering maneuvers.
2. Identify the damaged wheel. Do so by checking the tire inflation pressure using the Mobility System. If the tire inflation pressure in all tires is correct, the Flat Tire Monitor may not have been initialized. In this case, initialize the system.
3. Repair flat tire with the Mobility System or replace the damaged wheel.

### System limits

A natural, even tire inflation pressure loss in all four tires will not be recognized. Therefore, check the tire inflation pressure regularly.

Sudden serious tire damage caused by external circumstances cannot be recognized in advance.

The system could be delayed or malfunction in the following situations:

- ▷ When the system has not been initialized.
- ▷ When driving on a snowy or slippery road surface.
- ▷ Sporty driving style: spinning traction wheels, high lateral acceleration (drifting).
- ▷ When driving with snow chains.

## Intelligent Safety

### The concept

Intelligent Safety enables central operation of the driver assistance system.

Depending on how the vehicle is equipped, Intelligent Safety consists of one or more systems that can help prevent an imminent collision. These systems are active automatically every time the engine is started using the Start/Stop button:

- ▷ Front-end collision warning with City Braking function, refer to page 107.
- ▷ Pedestrian warning, refer to page 109.

### Safety information

#### WARNING

Indicators and warnings do not relieve the driver from personal responsibility. Due to system limits, warnings or reactions of the system may not be output or they may be output too late or incorrectly. There is a risk of an accident. Adjust the driving style to the traffic conditions. Watch traffic closely and actively intervene in the respective situations. ◀

#### WARNING

Due to system limits, individual functions can malfunction during tow-starting/towing with the Intelligent Safety systems activated,

e.g., approach control warning with light braking function. There is a risk of an accident. Switch all Intelligent Safety systems off prior to tow-starting/towing. ◀

### Overview

#### Button in the vehicle



Intelligent Safety button

#### Camera

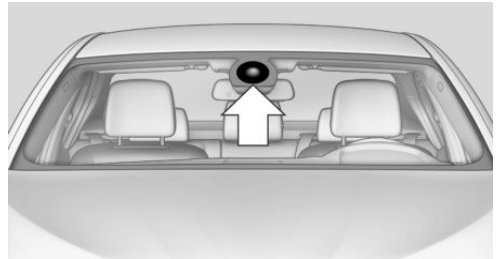

The camera is installed near the interior mirror. Keep the windshield in front of the interior mirror clean and clear.

### Switching on/off

The Intelligent Safety systems are automatically active after every departure.



Press button: the systems are turned off. The LED goes out.

Press button: the systems are turned on. The LED lights up.

Settings can be made on the Control Display.

## Approach control warning with City light braking function

### Concept

The system can help prevent accidents. If an accident cannot be prevented, the system will help reduce the collision speed.

The system sounds a warning before an imminent collision and actuates brakes independently, if needed.

The automatic braking intervention is done with limited force and duration.

A camera in the area of the rearview mirror controls the system.

The approach control warning is available even if cruise control has been deactivated.

With the vehicle approaching another vehicle intentionally, the approach control warning and braking are delayed in order to avoid false system reactions.

### General information

The system warns at two levels of an imminent danger of collision at speeds from approx. 3 mph/5 km/h. Time of warnings may vary with the current driving situation.

Appropriate braking kicks in at speeds of up to 35 mph/60 km/h.

### Detection range

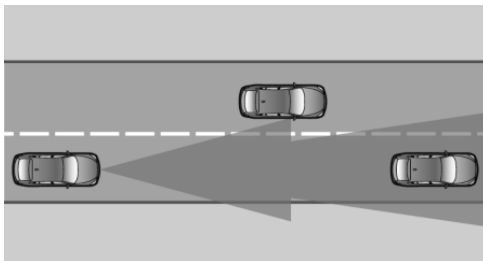

Objects are responded to if they are detected by the system.

## Safety information



### WARNING

Indicators and warnings do not relieve the driver from personal responsibility. Due to system limits, warnings or reactions of the system may not be output or they may be output too late or incorrectly. There is a risk of an accident. Adjust the driving style to the traffic conditions. Watch traffic closely and actively intervene in the respective situations. ◀



### WARNING

Due to system limits, individual functions can malfunction during tow-starting/towing with the Intelligent Safety systems activated, e.g., approach control warning with light braking function. There is a risk of an accident. Switch all Intelligent Safety systems off prior to tow-starting/towing. ◀

## Overview

### Button in the vehicle



Intelligent Safety button

## Camera

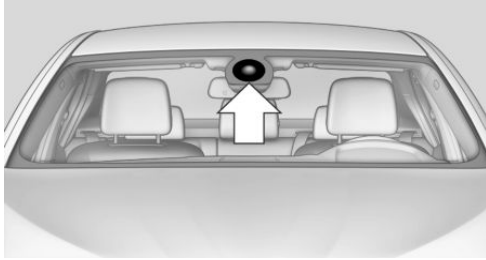

The camera is installed near the interior mirror. Keep the windshield in front of the interior mirror clean and clear.

## Switching on/off

### Switching on automatically

The system is automatically active after every driving off.

### Switching off



Press button: the system is switched off. The LED goes out.

Re-press button: the system is switched on. The LED lights up.

## Setting the warning time

The warning time can be set via iDrive.

1. "Settings"
2. "Frontal Coll. Warning"
3. Activate the desired time on the Control Display.

The selected time is stored for the profile currently used.

## Warning with braking function

### Display

If a collision with a vehicle detected in this way is imminent, a warning symbol appears on the instrument cluster.

Symbol	Measure
	Symbol lights up red: prewarning. Brake and increase distance.
	Symbol flashes red and an acoustic signal sounds: acute warning. You are requested to intervene by braking or make an evasive maneuver.



Symbol lights up red: prewarning. Brake and increase distance.



Symbol flashes red and an acoustic signal sounds: acute warning.

You are requested to intervene by braking or make an evasive maneuver.

## Prewarning

This warning is issued, e.g., when there is the impending danger of a collision or the distance to the vehicle ahead is too small.

The driver must intervene actively when there is a prewarning.

## Acute warning with braking function

Acute warning is displayed in case of the imminent danger of a collision when the vehicle approaches another object at a high differential speed.

The driver must intervene actively when there is an acute warning. If necessary, the driver is assisted by a minor automatic braking intervention in a possible risk of collision.

Acute warnings can also be triggered without previous forewarning.

## Braking intervention

The warning prompts the driver himself/herself to react. During a warning, the maximum braking force is used. Prerequisite for the brake booster is sufficiently quick and hard stepping on the brake pedal. The system can assist with some braking intervention if there is a risk of a collision. At low speeds vehicles may thus come to a complete stop.

Manual transmission: During a braking intervention up to a complete stop, the engine may be shut down.

The braking intervention is executed only if vehicle stability has not been restricted, e.g., by

deactivating the DSC Dynamic Stability Control.

The braking intervention can be interrupted by stepping on the accelerator pedal or by actively moving the steering wheel.

Object detection can be restricted. Observe the limitations of the detection range and functional restrictions.

## System limits

### Safety information



#### WARNING

The system can react incorrectly or not at all due to the system limits. There is a risk of accidents or risk of property damage. Observe the information regarding the system limits and actively intervene, if needed. ◀

### Detection range

The system's detection potential is limited. Thus, a system reaction might not come or might come late.

E.g., the following situations may not be detected:

- ▶ Slow moving vehicles when you approach them at high speed.
- ▶ Vehicles that suddenly swerve in front of you, or sharply decelerating vehicles.
- ▶ Vehicles with an unusual rear appearance.
- ▶ Two-wheeled vehicles ahead of you.

### Functional limitations

The system may not be fully functional in the following situations:

- ▶ In heavy fog, rain, sprayed water or snow-fall.
- ▶ In tight curves.
- ▶ If the driving stability control systems are limited or deactivated, e.g., DSC OFF.

- ▶ If the field of view of the camera in the mirror is dirty or obscured.
- ▶ Up to 10 seconds after the start of the engine via the Start/Stop button.
- ▶ During calibration of the camera immediately after vehicle delivery.
- ▶ If there are constant blinding effects because of oncoming light, e.g., from the sun low in the sky.

### Warning sensitivity

The more sensitive the warning settings are, such as the warning time, the more warnings are displayed. However, there may also be an excess of false warnings.

## Pedestrian warning with Approach control

### Concept

The system can help prevent accidents with pedestrians.

When driving at city speeds, the system will issue a warning if there is imminent danger of a collision with pedestrians and includes a braking function.

The camera in the area of the rearview mirror controls the system.

### General information

With sufficient brightness, the system warns about possible collision danger with pedestrians starting at approx. 6 mph/10 km/h to approx. 35 mph/60 km/h and assists with braking before a collision.

Under those circumstances it reacts to people who are within the detection range of the system.

## Detection range

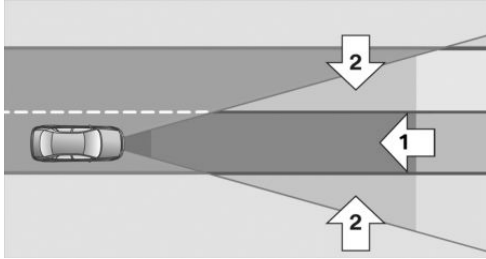

The detection area in front of the vehicle is divided into two areas:

- ▷ Central area, arrow 1, directly in front of the vehicle.
- ▷ Expanded area, arrow 2, to the right and left.

A collision is imminent if pedestrians are located within the central area. A warning is issued about pedestrians who are located within the extended area only if they are moving in the direction of the central area.

## Safety information



### WARNING

Indicators and warnings do not relieve the driver from personal responsibility. Due to system limits, warnings or reactions of the system may not be output or they may be output too late or incorrectly. There is a risk of an accident. Adjust the driving style to the traffic conditions. Watch traffic closely and actively intervene in the respective situations. ◀



### WARNING

Due to system limits, individual functions can malfunction during tow-starting/towing with the Intelligent Safety systems activated, e.g., approach control warning with light braking function. There is a risk of an accident. Switch all Intelligent Safety systems off prior to tow-starting/towing. ◀

## Overview

### Button in the vehicle



Intelligent Safety button

### Camera

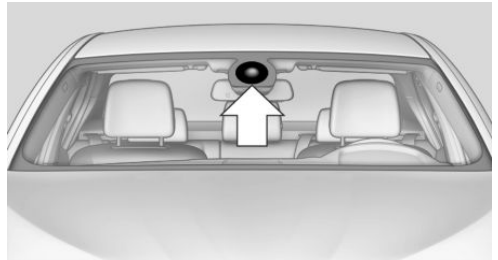

The camera is installed near the interior mirror. Keep the windshield in front of the interior mirror clean and clear.

### Switching on/off

#### Switching on automatically

The system is automatically active after every driving off.

#### Switching off



Press button: the systems are turned off. The LED goes out.

Press button: the systems are turned on. The LED lights up.

## Warning with braking function

### Display

If a collision with a person detected in this way is imminent, a warning symbol appears on the instrument cluster.



The red symbol is displayed and a signal sounds.

Intervene immediately by braking or make an evasive maneuver.

### Braking intervention

The warning prompts the driver himself/herself to react. During a warning, the maximum braking force is used. Prerequisite for the brake booster is sufficiently quick and hard stepping on the brake pedal. The system can assist with some braking intervention if there is a risk of a collision. At low speeds vehicles may thus come to a complete stop.

Manual transmission: During a braking intervention up to a complete stop, the engine may be shut down.

The braking intervention is executed only if vehicle stability has not been restricted, e.g., by deactivating the DSC Dynamic Stability Control.

The braking intervention can be interrupted by stepping on the accelerator pedal or by actively moving the steering wheel.

Object detection can be restricted. Observe the limitations of the detection range and functional restrictions.

## System limits

### Safety information



#### WARNING

The system can react incorrectly or not at all due to the system limits. There is a risk of accidents or risk of property damage. Observe

the information regarding the system limits and actively intervene, if needed. ◀

### Detection range

The detection potential of the camera is limited.

Thus, a warning might not be issued or be issued late.

E.g., the following situations may not be detected:

- ▷ Partially covered pedestrians.
- ▷ Pedestrians that are not detected as such because of the viewing angle or contour.
- ▷ Pedestrians outside of the detection range.
- ▷ Pedestrians having a body size less than 32 in/80 cm.

### Functional limitations

The system may not be fully functional or may not be available in the following situations:

- ▷ In heavy fog, rain, sprayed water or snowfall.
- ▷ In tight curves.
- ▷ If the driving stability control systems are deactivated, e.g., DSC OFF.
- ▷ If the field of view of the camera or the windshield are dirty or covered.
- ▷ Up to 10 seconds after the start of the engine via the Start/Stop button.
- ▷ During calibration of the camera immediately after vehicle delivery.
- ▷ If there are constant blinding effects because of oncoming light, e.g., from the sun low in the sky.
- ▷ When it is dark outside.

## Lane departure warning

### Concept

Starting at a specific speed, this system alerts you when the vehicle on streets with lane markings is about to leave the lane. This speed, depending on the country version, is between 35 mph/55 km/h and 45 mph/70 km/h.

When switching on the system below this speed, a message is displayed in the instrument cluster.

The steering wheel begins vibrating gently in the event of warnings. The time of the warning may vary depending on the current driving situation.

The system does not provide a warning if the turn signal is set before leaving the lane.

### Safety information

#### WARNING

The system does not release the driver from the personal responsibility to correctly assess route and traffic situation. There is a risk of an accident. Adjust the driving style to the traffic conditions. Watch traffic closely and actively intervene in the respective situations. In the event of a warning, do not unnecessarily jerk the steering wheel. ◀

### Overview

#### Button in the vehicle



Lane departure warning

### Camera

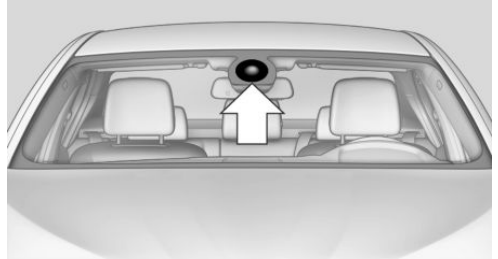

The camera is installed near the interior mirror. Keep the windshield in front of the interior mirror clean and clear.

### Switching on/off



Press button.

- ▷ On: the LED lights up.
- ▷ Off: the LED goes out.

Settings are stored for the profile currently used.

### Display in the instrument cluster



- ▷ Lines: system is activated.
- ▷ Arrows: at least one lane marking was detected and warnings can be issued.

### Issued warning

If you leave the lane and if a lane marking has been detected, the steering wheel begins vibrating.

If the turn signal is set before changing the lane, a warning is not issued.

### End of warning

The warning is canceled in the following situations:

- ▷ Automatically after approx. 3 seconds.
- ▷ When returning to your own lane.
- ▷ When braking hard.
- ▷ When using the turn signal.

## System limits

### Safety information



#### WARNING

The system can react incorrectly or not at all due to the system limits. There is a risk of accidents or risk of property damage. Observe the information regarding the system limits and actively intervene, if needed. ◀

### Functional limitations

The system may not be fully functional in the following situations:

- ▷ In heavy fog, rain or snowfall.
- ▷ In the event of missing, worn, poorly visible, merging, diverging, or multiple lane markings such as in construction areas.
- ▷ When lane markings are covered in snow, ice, dirt or water.
- ▷ In tight curves or on narrow lanes.
- ▷ When the lane markings are covered by objects.
- ▷ When driving very close to the vehicle in front of you.
- ▷ When driving toward bright lights.
- ▷ When the windshield in front of the interior mirror is fogged over, dirty or covered with stickers, etc.
- ▷ During calibration of the camera immediately after vehicle delivery.

## Brake force display

### Concept

Additional brake lamps indicate emergency braking to the traffic behind. This can reduce the risk of a rear-end collision.

### General information



- ▷ During normal brake application, the bottom brake lights light up.
- ▷ During heavy brake application, the top brake lights additionally light up.

## Attentiveness assistant

### Concept

The system can detect decreasing alertness or fatigue of the driver during long, monotonous trips, e.g., on highways. In this situation, it is recommended that the driver takes a break.

### Safety information



#### WARNING

The system does not release from the personal responsibility to correctly assess one's physical state. An increasing lack of alertness or fatigue may not be detected or not be detected in time. There is a risk of an accident. Make sure that the driver is rested and alert. Adjust the driving style to the traffic conditions. ◀

## Function

The system is activated each time the engine is started and cannot be switched off.

After travel has begun, the system monitors certain aspects of the driver's behavior, so that decreasing alertness or fatigue can be detected.

This procedure takes the following criteria into account:

- ▷ Personal driving style, e.g., steering behavior.
- ▷ Driving conditions, e.g., length of trip.

Starting at approximately 43 mph/70 km/h, the system is active and can display a recommendation to take a break.

## Break recommendation

If the driver becomes less alert or fatigued, a message is displayed in the Control Display with the recommendation to take a break.

A recommendation to take a break is displayed only once during an uninterrupted trip.

After a break, another recommendation to take a break cannot be displayed until after approximately 45 minutes.

## System limits

The function may be limited in the following situations, e.g., and will either output an incorrect warning or no warning at all:

- ▷ When the clock is set incorrectly.
- ▷ When the vehicle speed is mainly below about 43 mph/70 km/h.
- ▷ With a sporty driving style, such as during rapid acceleration or when cornering fast.
- ▷ In active driving situations, such as when changing lanes frequently.
- ▷ When the road surface is poor.
- ▷ In the event of strong side winds.

The system is reset approx. 45 minutes after parking the vehicle, e.g., in the case of a break during longer trips on highways.

# Driving stability control systems

## Vehicle features and options

This chapter describes all standard, country-specific and optional features offered with the series. It also describes features that are not necessarily available in your vehicle, e. g., due to the selected options or country versions. This also applies to safety-related functions and systems. When using these functions and systems, the applicable country provisions must be observed.

## Anti-lock Braking System ABS

ABS prevents locking of the wheels during braking.

The vehicle maintains its steering power even during full brake applications, thus increasing active safety.

ABS is operational every time you start the engine.

## Brake assistant

When you apply the brakes rapidly, this system automatically produces the greatest possible braking force boost. It reduces the braking distance to a minimum during emergency stop. This system utilizes all of the benefits provided by ABS.

Do not reduce the pressure on the brake pedal for the duration of the emergency stop.

## DSC Dynamic Stability Control

### Concept

Within the physical limits, the system helps to keep the vehicle on a steady course by reducing engine speed and by applying brakes to the individual wheels.

### General information

Dynamic Stability Control detects, e.g., the following unstable driving conditions:

- ▷ Fishtailing, which can lead to oversteering.
- ▷ Loss of traction of the front wheels, which can lead to understeering.

### Safety information



#### WARNING

The system does not release from the personal responsibility to correctly assess the traffic situation. Based on the limits of the system, it cannot independently react to all traffic situations. There is a risk of an accident. Adjust the driving style to the traffic conditions. Watch traffic closely and actively intervene in the respective situations. ◀



#### WARNING

When driving with roof load, e.g., with roof-mounted luggage rack, driving safety may not be ensured in driving-critical situations due to the elevated center of gravity. There is a risk of accidents or risk of property damage. Do not deactivate Dynamic Stability Control DSC when driving with roof load. ◀

## Overview

### Button in the vehicle



 DSC OFF button

### Indicator/warning lights

 The indicator lamp flashes: DSC controls the drive and braking forces.

The indicator lamp lights up: DSC has malfunctioned.

## Deactivating DSC: DSC OFF

### General information

When DSC is deactivated, driving stability is reduced during acceleration and when driving in curves.

To increase vehicle stability, activate DSC again as soon as possible.

### Deactivating DSC

 Press and hold this button but not longer than approx. 10 seconds, until the indicator lamp for DSC OFF lights up in the instrument cluster and displays DSC OFF.

DSC is switched off.

Engine tuning switches to a sportier setting.

### Activating DSC

 Press button.

DSC OFF and the DSC OFF indicator lamp go out.

### Indicator/warning lights

When DSC is deactivated, DSC OFF is displayed in the instrument cluster.



The indicator lamp lights up: DSC is deactivated.

## M Dynamic Mode MDM

### Concept

M Dynamic Mode makes it possible to drive on a dry roadway with high longitudinal and transverse acceleration but with limited driving stability.

Only in the absolute limit area does the system intervene for stabilization by reducing the engine power and by braking interventions on the wheels. In this driving condition, additional steering corrections may be necessary.

You may find it useful to briefly activate MDM under the following special circumstances:

- ▶ When driving in slush or on uncleared, snow-covered roads.
- ▶ When freeing vehicle from deep snow or driving off from loose ground.
- ▶ When driving with snow chains.

### Safety information



#### WARNING

When M Dynamic Mode is activated, stabilizing interventions are carried out only to a reduced extent. There is a risk of accidents or risk of property damage. Adapt to traffic conditions. Watch traffic closely and actively intervene in the respective situations. In the event of a warning, do not unnecessarily jerk the steering wheel. ◀

To increase vehicle stability, activate DSC again as soon as possible.

## Activating MDM



Press button briefly.

The DSC OFF indicator lamp is illuminated and TRACTION is displayed in the instrument cluster.

## Deactivating MDM



Press button.

DSC OFF indicator lamp and TRACTION indicator are no longer illuminated.

## Indicator/warning lights



Indicator lamp is illuminated and TRACTION is displayed in the instrument cluster:

M Dynamic Mode is activated.



DSC indicator lamp also flashes:

M Dynamic Mode controls the drive forces and brake forces.



Indicator lights light up:

M Dynamic Mode or DSC has failed.



## Active M differential

### The concept

The active M differential assures continuously variable locking of the rear axle differential depending on the driving situation. This prevents individual rear wheels from spinning even when DSC is switched off and in M Dynamic Mode, so that optimum traction is always assured in all driving situations.

The driver is responsible adapting his or her driving behavior to the situation.

## Servotronic

### Concept

The Servotronic varies the steering force required to turn the wheels in accordance with the vehicle speed. At low speeds, the steering force is strongly supported, i. e. during steering, low force is required. As the speed increases, the assistance of the steering force is reduced.

Furthermore, the steering force adapts according to the driving program, so that a direct, sporty feel and/or comfortable steering is conveyed.

### Programs

Steering force setting options:

- ▷ COMFORT: low.
- ▷ SPORT: high.
- ▷ SPORT+: high.

### Selecting a channel

The desired channel is selected using the Driving Dynamics Control, refer to page 117.

## Driving Dynamics Control

### Concept



The Driving Dynamics Control helps to fine-tune the vehicle's settings and features. Various programs can be selected for this purpose. The Driving Dynamics Control and the DSC OFF buttons can each be used to activate a program.

## Overview

### Button in the vehicle



### Operating the programs

Button	Program
	DSC OFF TRACTION
	SPORT+ SPORT COMFORT

### Automatic program change

The system may automatically switch to COMFORT in the following situations:

- ▷ Failure of DSC Dynamic Stability Control.
- ▷ The vehicle has a flat tire.
- ▷ When activating cruise control in TRACTION or DSC OFF mode.

### DSC OFF

When DSC OFF, refer to page 116, is active, driving stability is limited during acceleration and when driving in curves.

Engine tuning switches to a sportier setting.

### TRACTION

When TRACTION is active, the vehicle has maximum traction on loose road surfaces. M Dynamic Mode MDM, refer to page 116, is

activated. Driving stability is limited during acceleration and when driving in curves.

### SPORT+

Consistently sporty driving with optimized chassis and suspension and adjusted drivetrain.

M Dynamic Mode is switched on.

The driver handles several of the stabilization tasks.

### Activating SPORT+



Press button repeatedly until SPORT+ appears in the instrument cluster and the DSC OFF indicator lamp lights up.

### Automatic program change

When activating cruise control, the program automatically switches to SPORT mode.

### Indicator/warning lights

SPORT+ is displayed in the instrument cluster.



DSC OFF indicator lamp is illuminated: M Dynamic Mode is activated.

### SPORT

Sporty tuning of the steering and drivetrain for greater driving agility.

The program can be configured to individual specifications. The configuration is stored for the profile currently used.

### Activating SPORT



Press button repeatedly until SPORT is displayed in the instrument cluster.

### Configuring SPORT

When the display is activated on the Control Display, refer to page 119, the SPORT driving mode can be set to individual specifications.

- ▷ Activate SPORT.

- ▷ "Configure SPORT"
  - ▷ Configure the SPORT driving mode.
- SPORT can also be configured before it is activated:

1. "Settings"
2. "Driving mode"
3. "Configure SPORT"
4. Configure driving mode.

This configuration is retrieved when the SPORT driving mode is activated.

## COMFORT

For a balanced tuning with maximum driving stabilization.

### Activating COMFORT



Press button repeatedly until COMFORT is displayed in the instrument cluster.

In certain situations, the system automatically changes to the NORMAL program, automatic program change, refer to page [118](#).

## Displays

### Program selection

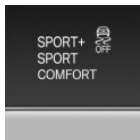

Pressing the button displays a list of the selectable programs. Depending on your vehicle's optional features, the list in the instrument cluster can differ from the illustration shown.

### Selected program

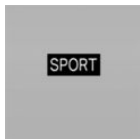

The instrument cluster displays the selected program.

### Display on the Control Display

Program changes can be displayed on the Control Display.

1. "Settings"
2. "Control display"
3. "Driving mode info"

## Drive-off assistant

### Concept

This system supports driving off on inclines. The parking brake is not required.

### Driving off with the drive-off assistant

1. Hold the vehicle in place with the foot brake.
2. Release the foot brake and drive off without delay.

After the foot brake is released, the vehicle is held in place for approx. 2 seconds.

Depending on the vehicle load, the vehicle may roll back slightly.

# Driving comfort

## Vehicle features and options

This chapter describes all standard, country-specific and optional features offered with the series. It also describes features that are not necessarily available in your vehicle, e. g., due to the selected options or country versions. This also applies to safety-related functions and systems. When using these functions and systems, the applicable country provisions must be observed.

## Cruise control

### Concept

Using this system, a desired speed can be adjusted using the buttons on the steering wheel. The system maintains the desired speed. The system accelerates and brakes automatically as needed.

### General information

Depending on the driving settings, the features of the cruise control can change in certain areas.

### Safety information

#### WARNING

The system does not release from the personal responsibility to correctly assess the traffic situation. Based on the limits of the system, it cannot independently react to all traffic situations. There is a risk of an accident. Adjust the driving style to the traffic conditions. Watch traffic closely and actively intervene in the respective situations. ◀

#### WARNING

The use of the system can lead to an increased risk of accidents in the following situations:

- ▷ On winding roads.
- ▷ In heavy traffic.
- ▷ On slippery roads, in fog, snow or rain, or on a loose road surface.





There is a risk of accidents or risk of property damage. Only use the system if driving at constant speed is possible. ◀

#### WARNING

The desired speed can be incorrectly adjusted or called up by mistake. There is a risk of an accident. Adjust the desired speed to the traffic conditions. Watch traffic closely and actively intervene in the respective situations. ◀

## Overview

### Buttons on the steering wheel

Button	Function
	Cruise control on/off, interrupting, refer to page 120.
	Store speed, refer to page 121.
	Resume speed, continue cruise control, refer to page 122.
	Rocker switch: adjust speed, refer to page 121.

### Switching on/off and interrupting cruise control

#### Switching on

 Press button on the steering wheel.

The marking in the speedometer is set to the current speed.

Cruise control can be used.

DSC will be switched on, if needed.

## Switching off



Press button on the steering wheel.

- ▷ If active: press twice.
- ▷ If interrupted: press once.

The displays go out. The stored desired speed is deleted.

## Interrupting manually



When active, press the button on the steering wheel.

## Interrupting automatically

The system is automatically interrupted in the following situations:

- ▷ When the driver applies the brakes.
- ▷ If the clutch pedal is depressed for a few seconds or released while a gear is not engaged.
- ▷ If the gear engaged is too high for the current speed.
- ▷ If MDM is activated or DSC is deactivated.
- ▷ When DSC is actively controlling stability.
- ▷ When SPORT+ is activated with Driving Dynamics Control.

## Setting the speed

### Maintaining/storing the speed

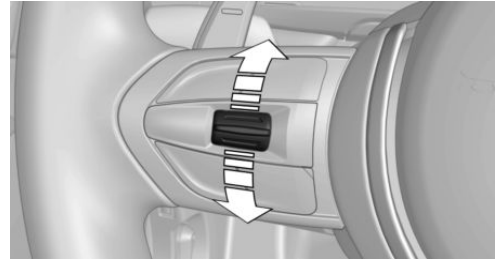

Press the rocker switch while the system is interrupted.

When the system is switched on, the current speed is maintained and stored as the desired speed.

The stored speed is displayed in the speedometer and briefly in the instrument cluster, refer to page 122.

DSC will be switched on, if needed.

The speed can also be stored by pressing a button.



Press button.

## Changing the speed

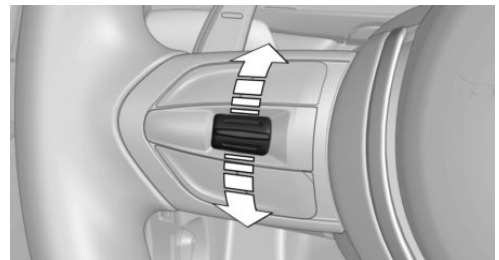

Press the rocker switch up or down repeatedly until the desired speed is set.

If active, the displayed speed is stored and the vehicle reaches the stored speed when the road is clear.

- ▷ Each time the rocker switch is pressed to the point of resistance, the desired speed increases or decreases by approx. 1 mph/1 km/h.
- ▷ Each time the rocker switch is pressed past the point of resistance, the desired speed increases or decreases by a maximum of 5 mph/10 km/h.  
The maximum speed that can be set depends on the vehicle.
- ▷ Pressing the rocker switch to the resistance point and holding it accelerates or decelerates the vehicle without requiring pressure on the accelerator pedal.  
After the rocker switch is released, the vehicle maintains its final speed. Pressing the switch beyond the resistance point causes the vehicle to accelerate more rapidly.

## Continuing cruise control

### General information

An interrupted cruise control can be continued by calling up the stored speed.

Make sure that the difference between current speed and stored speed is not too large before calling up the stored speed. Otherwise, unintentional braking or accelerating may occur.

In the following cases, the stored speed value is deleted and cannot be called up again:

- ▷ When the system is switched off.
- ▷ When the ignition is switched off.

### Calling up stored speed



Press button on the steering wheel.

The stored speed is reached again and maintained.

## Displays in the instrument cluster

### Indicator lamp



Depending on how the vehicle is equipped, the indicator lamp in the instrument cluster indicates whether the system is switched on.

### Desired speed and stored speed

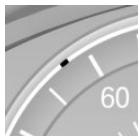

- ▷ Marking lights up green: system is active, the marking indicates the desired speed.
- ▷ Marking lights up orange: system is interrupted, the marking indicates the stored speed.
- ▷ The marking does not light up: the system is switched off.

### Brief status display



Selected desired speed.

If no speed is indicated, it is possible that the conditions necessary for operation are not currently fulfilled.

## System limits

### Engine power

The desired speed is also maintained downhill, but may not be maintained on uphill grades if engine power is insufficient.

## PDC Park Distance Control

### Concept

PDC is a support when parking. When you slowly approach an object in the rear, then the object is reported through:

- ▷ Signal tones.

- ▷ Visual display.

## General information

The ultrasound sensors for measuring the distances are located in the rear bumper.

The maneuvering range, depending on the obstacle and environmental conditions, is approx. 6 ft/2 m.

An acoustic warning is first given in the following situations:

- ▷ By the two rear corner sensors at approx. 24 in/60 cm from the object.
- ▷ By the rear middle sensors at approx. 5 ft/1.50 m from the object.
- ▷ When a collision is imminent.

## Safety information



### WARNING

The system does not release from the personal responsibility to correctly assess the traffic situation. Based on the limits of the system, it cannot independently react to all traffic situations. There is a risk of an accident. Adjust the driving style to the traffic conditions. Watch traffic closely and actively intervene in the respective situations. ◀



### WARNING

Due to high speeds when PDC is activated, the warning can be delayed due to physical circumstances. There is a risk of injury or risk of property damage. Avoid approaching an object too fast. Avoid driving off fast while PDC is not yet active. ◀

## Overview

### Ultrasound sensors



Ultrasound sensors of the PDC, e.g., in the bumpers.

## Functional requirements

To ensure full functionality:

- ▷ Do not cover sensors, e.g., with stickers, bicycle racks.
- ▷ Keep sensors clean and unobstructed.

## Switching on/off

### Switching on automatically

With the engine running, engage lever in position R.

The rearview camera also switches on.

### Automatic deactivation during forward travel

The system switches off when a certain driving distance or speed is exceeded.

Switch the system back on, if needed.

## WARNING

### Signal tones

When approaching an object, an intermittent sound indicates the position of the object. E.g., if an object is detected to the left rear of the vehicle, a signal tone sounds from the left rear speaker.

The shorter the distance to the object, the shorter the intervals.

If the distance to a detected object is less than approx. 10 inches/25 cm, a continuous tone is sounded.

### Volume

The ratio of the PDC signal tone volume to the entertainment volume can be adjusted.

1. "Multimedia", "Radio" or "Settings"
2. "Tone"
3. "Volume settings"
4. "PDC"

5. Turn the controller until the desired setting is selected.
6. Press the controller.

Settings are stored for the profile currently used.

### Visual warning

The approach of the vehicle to an object can be shown on the Control Display. Objects that are farther away are already displayed on the Control Display before a signal sounds.

A display appears as soon as Park Distance Control (PDC) is activated.

The range of the sensors is represented in the colors green, yellow and red.

When the image of the rearview camera is displayed, the switch can be made to PDC:

 "Rear view camera"

### System limits

#### Safety information



#### WARNING

The system can react incorrectly or not at all due to the system limits. There is a risk of accidents or risk of property damage. Observe the information regarding the system limits and actively intervene, if needed. ◀

#### Limits of ultrasonic measurement

Ultrasonic measurements might not function in the following situations:

- ▷ For small children and animals.
- ▷ For persons with certain clothing, e.g., coats.
- ▷ With external interference of the ultrasound, e.g., from passing vehicles or loud machines.
- ▷ When sensors are dirty, iced over, damaged or out of position.

- ▷ Under certain weather conditions such as high relative humidity, rain, snowfall, extreme heat or strong wind.
- ▷ With tow bars and trailer couplings of other vehicles.
- ▷ With thin or wedge-shaped objects.
- ▷ With moving objects.
- ▷ With elevated, protruding objects such as ledges or cargo.
- ▷ With objects with corners and sharp edges.
- ▷ With objects with a fine surface structure such as fences.
- ▷ For objects with porous surfaces.
- ▷ If cargo protrudes.
- ▷ Low objects already displayed, e.g., curbs, can move into the blind area of the sensors before or after a continuous tone sounds.

#### False warnings

The system may issue a warning under the following conditions even though there is no obstacle within the detection range:

- ▷ In heavy rain.
- ▷ When sensors are very dirty or covered with ice.
- ▷ When sensors are covered in snow.
- ▷ On rough road surfaces.
- ▷ On uneven surfaces, such as speed bumps.
- ▷ In large buildings with right angles and smooth walls, e.g., in underground garages.
- ▷ In automatic vehicle washes.
- ▷ Due to heavy exhaust.
- ▷ Due to other ultrasound sources, e.g., sweeping machines, high pressure steam cleaners or neon lights.

As soon as the malfunction due to other ultrasound sources is no longer present, the system is again fully functional.

## Malfunction

A Check Control message is displayed.

The range of the sensors is shown as a shaded area on the Control Display.

PDC has failed. Have the system checked.

## Rearview camera

### Concept

The rearview camera provides assistance in parking and maneuvering backwards. The area behind the vehicle is shown on the Control Display.

### Safety information



#### WARNING

The system does not relieve from the personal responsibility to correctly assess the traffic situation. There is a risk of an accident. Adjust the driving style to the traffic conditions. Watch traffic and vehicle surroundings closely and actively intervene in the respective situations. ◀

### Overview

#### Camera

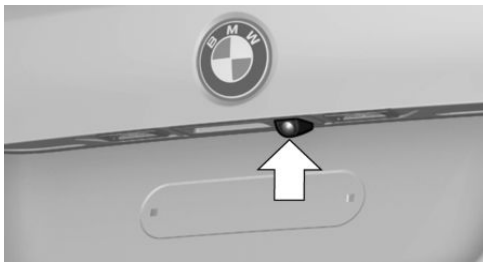

The camera lens is located in the handle of the tailgate.

The image quality may be impaired by dirt. If necessary, clean the camera lens.

## Switching on/off

### Switching on automatically

The system is switched on automatically if selector lever position R is engaged when the engine is running.

The rearview camera image is displayed if the system was switched on via iDrive.

### Automatic deactivation during forward travel

The system switches off when a certain driving distance or speed is exceeded.

Switch the system back on, if needed.

### Switching the view via iDrive

With PDC activated:

"Rear view camera"

The rearview camera image is displayed.

### Display on the Control Display

#### Functional requirement

- ▷ The rearview camera is switched on.
- ▷ The tailgate is fully closed.
- ▷ Keep the recording range of the camera clear. Protruding cargo can lead to malfunctions.

### Activating assistance functions

More than one assistance function can be active at the same time.

- ▷ Parking aid lines
  - "Parking aid lines"  
Lanes and turning radius are indicated.
- ▷ Obstacle marking
  - "Obstacle marking"  
Spatially-shaped markings are displayed.

## Pathway lines

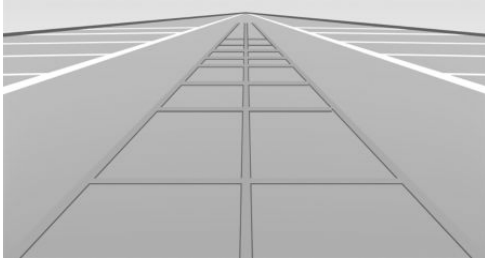

Pathway lines can be superimposed on the image of the rearview camera.

Pathway lines help you to estimate the space required when parking and maneuvering on level roads.

Pathway lines depend on the current steering angle and are continuously adjusted to the steering wheel movements.

## Turning radius lines

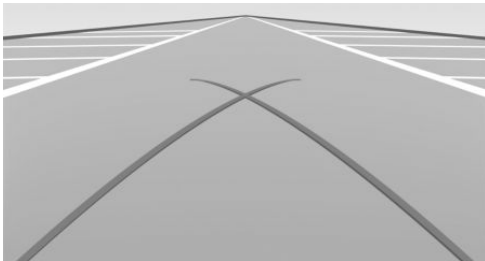

Turning radius lines can only be superimposed on the rearview camera image together with pathway lines.

Turning radius lines show the course of the smallest possible turning radius on a level road.

Only one turning radius line is displayed after the steering wheel is turned past a certain angle.

## Obstacle marking

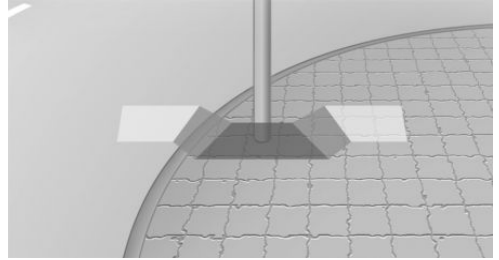

Obstacle markings can be faded into the image of the rearview camera.

The colored thresholds of the obstacle markings match the markings of the PDC.

## Parking using pathway and turning radius lines

1. Position the vehicle so that the turning radius lines lead to within the limits of the parking space.

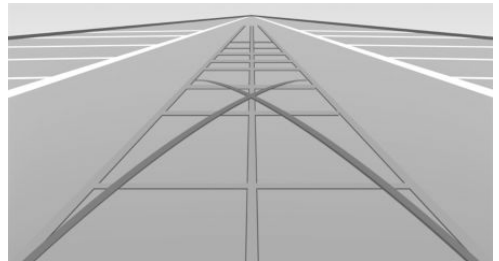

2. Turn the steering wheel to the point where the pathway line covers the corresponding turning radius line.

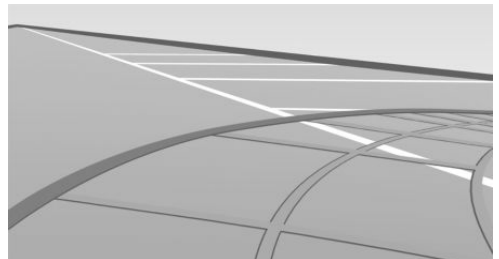

## Display settings

### Brightness

With the rearview camera switched on:

1. ☀ Select the symbol.
2. Turn the controller until the desired setting is reached, and press the controller.

### Contrast

With the rearview camera switched on:

1. ● Select the symbol.
2. Turn the controller until the desired setting is reached, and press the controller.

## System limits

### Detection of objects

Very low obstacles as well as high, protruding objects such as ledges may not be detected by the system.

Assistance functions also take into account data of the PDC.

Follow instructions in the PDC chapter.

The objects displayed on the Control Display may be closer than they appear. Do not estimate the distance from the objects on the display.

# Climate control

## Vehicle features and options

This chapter describes all standard, country-specific and optional features offered with the series. It also describes features that are not necessarily available in your vehicle, e. g., due

to the selected options or country versions. This also applies to safety-related functions and systems. When using these functions and systems, the applicable country provisions must be observed.

## Automatic climate control

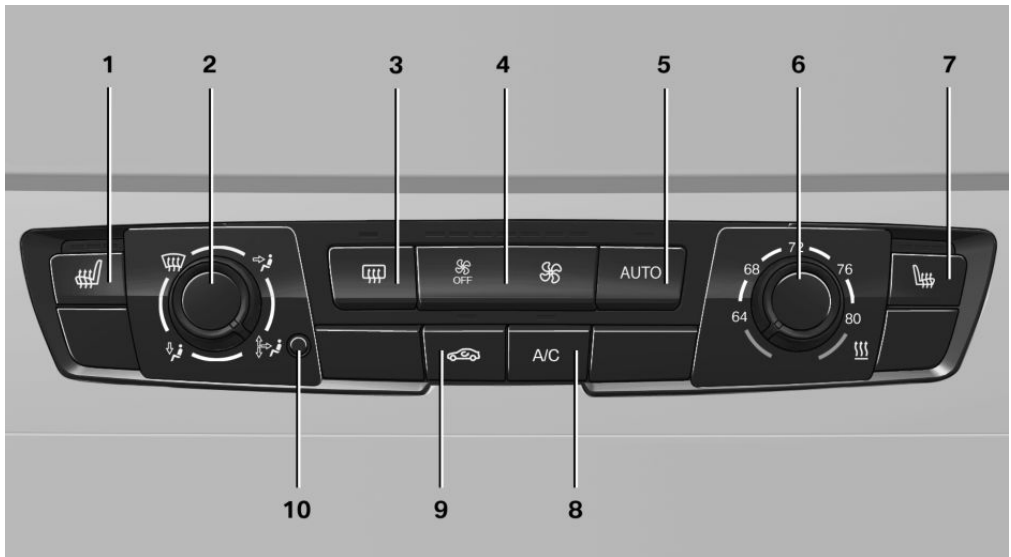

- |   |                       |                    |    |                             |
|---|-----------------------|--------------------|----|-----------------------------|
| 1 | Seat heating, left    | <a href="#">52</a> | 6  | Temperature                 |
| 2 | Vent settings         |                    | 7  | Seat heating, right         |
| 3 | Rear window defroster |                    | 8  | Cooling function            |
| 4 | Air flow              |                    | 9  | Recirculated-air mode       |
| 5 | AUTO program          |                    | 10 | Interior temperature sensor |

## Climate control functions in detail

### Switching the system on/off

#### Switching on

Press any button except

- ▷ Rear window defroster.
- ▷ Seat heating.

## Switching off



Press the left button for the minimum speed.

## Temperature



Turn the ring to set the desired temperature.

The automatic climate control reaches this temperature as quickly as possible, if needed by increasing the cooling or heating output, and then keeps it constant.

Do not rapidly switch between different temperature settings. Otherwise, the automatic climate control will not have sufficient time to adjust the set temperature.

## Air conditioning

The air in the vehicle's interior will be cooled and dehumidified and, depending on the temperature setting, warmed again.

The vehicle's interior can only be cooled with the engine running.



Press button.

Air conditioning is switched on or off.

Depending on the weather, the windshield and side windows may fog up briefly when the engine is started.

The cooling function is switched on automatically with the AUTO program.

When using the automatic climate control, condensation water, refer to page 154, develops and drains underneath the vehicle. This is normal.

## AUTO program



Press button.

Air flow, air distribution and temperature are controlled automatically.

Depending on the selected temperature and outside influences, the air is directed to the windshield, side windows, upper body, and into the floor area.

The cooling function, refer to page 129, is switched on automatically with the AUTO program.

## Recirculated-air mode

You may react to unpleasant odors or pollutants in the immediate environment by temporarily suspending the supply of outside air. The system then recirculates the air currently within the vehicle.



Press button repeatedly to select an operating mode:

- ▷ LED off: outside air flows in continuously.
- ▷ LED on, recirculated-air mode: the supply of outside air into the vehicle is permanently blocked.

To prevent window fogging, recirculated-air mode switches off automatically after a certain amount of time, depending on the environmental conditions.

With constant recirculated-air mode, the air quality in the vehicle's interior deteriorates and the fogging of the windows increases.

If the windows fog over, switch off recirculated-air mode and increase the air flow, if needed.

## Air flow, manual



Press the left or right side of the button: decrease or increase air flow.

The air flow from the air conditioner may be reduced automatically to save battery power.

## Manual air distribution



Turn the wheel to select the desired program or the desired intermediate setting.

- ▷ Windows.
- ▷ Upper body region.
- ▷ Windows, upper body region, and floor area.
- ▷ Floor area.

## Defrosting windows and removing condensation

Direct the air distribution toward windows, increase the air flow and temperature, and if needed, use the cooling function.

## Rear window defroster



Press button.

The rear window defroster switches off automatically after a certain period of time.

## Microfilter

In external and recirculated-air mode the microfilter filters dust and pollen from the air.

This filter should be replaced during scheduled maintenance, refer to page 187, of your vehicle.

## Automatic climate control with enhanced features

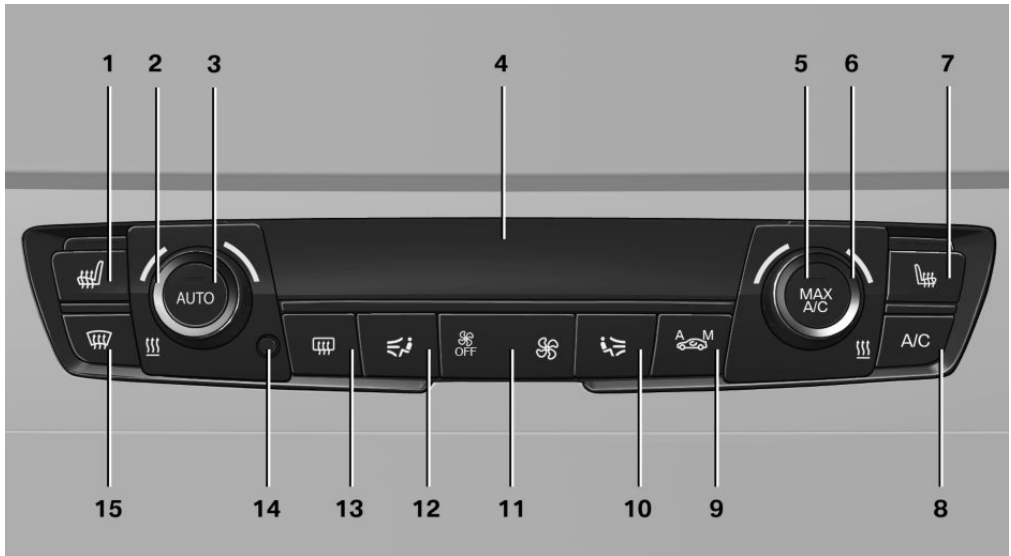

- 1 Seat heating, left [52](#)
- 2 Temperature, left
- 3 AUTO program

- 4 Display
- 5 Maximum cooling
- 6 Temperature, right

- 7 Seat heating, right 52
- 8 Air conditioning
- 9 Automatic recirculated-air control/recirculated-air mode
- 10 Air distribution, right
- 11 Air flow, AUTO intensity
- 12 Air distribution, left
- 13 Rear window defroster
- 14 Interior temperature sensor — always keep clear
- 15 Defrosting windows and removing condensation

## Climate control functions in detail

### Switching the system on/off

#### Switching on

Press any button except

- Rear window defroster.
- Seat heating.

#### Switching off



Press the left button for the minimum speed.

### Temperature



Turn the ring to set the desired temperature.

The automatic climate control reaches this temperature as quickly as possible, if needed, by increasing the cooling or heating output, and then keeps it constant.

Do not rapidly switch between different temperature settings. Otherwise, the automatic climate control will not have sufficient time to adjust the set temperature.

### Air conditioning

The air in the vehicle's interior will be cooled and dehumidified and, depending on the temperature setting, warmed again.

The vehicle's interior can only be cooled with the engine running.



Press button.

Air conditioning is switched on or off.

Depending on the weather, the windshield and side windows may fog up briefly when the engine is started.

The cooling function is switched on automatically with the AUTO program.

When using the automatic climate control, condensation water, refer to page 154, develops and drains underneath the vehicle. This is normal.

### Maximum cooling



Press button.

The system is set to the lowest temperature, optimum air flow and recirculated-air mode.

Air flows out of the vents to the upper body region. The vents need to be open for this.

The function is available above an external temperature of approx. 32 °F/0 °C And with the engine running.

The air flow can be adjusted with the air flow active.

### AUTO program



Press button.

Air flow, air distribution and temperature are controlled automatically.

Depending on the selected temperature, the intensity of the AUTO program, and outside influences, the air is directed to the windshield,

side windows, upper body, and into the floor area.

The cooling function, refer to page 131, is switched on automatically with the AUTO program.

At the same time, a condensation sensor controls the program so as to prevent window condensation as much as possible.

### Intensity of the AUTO program

With the AUTO program activated, the automatic intensity control can be changed.



Press the left or right side of the button: decrease or increase intensity.

The selected intensity is shown on the display of the automatic climate control.

### Automatic recirculated-air control/ recirculated-air mode

You may react to unpleasant odors or pollutants in the immediate environment by temporarily suspending the supply of outside air. The system then recirculates the air currently within the vehicle.



Press button repeatedly to select an operating mode:

- ▷ LEDs off: outside air flows in continuously.
- ▷ Left LED on, automatic recirculated-air control: a sensor detects pollutants in the outside air and shuts off automatically.
- ▷ Right LED on, recirculated-air mode: the supply of outside air into the vehicle is permanently blocked.

Recirculated-air mode switches off automatically at low external temperatures after a certain amount of time in order to avoid window fogging.

With constant recirculated-air mode, the air quality in the vehicle's interior deteriorates and the fogging of the windows increases.

If the windows are fogged over, switch off the recirculated-air mode and press the AUTO

button to utilize the condensation sensor. Make sure that air can flow to the windshield.

### Air flow, manual

To manually adjust air flow turn off AUTO program first.



Press the left or right side of the button: decrease or increase air flow.

The selected air flow is shown on the display of the automatic climate control.

The air flow of the automatic climate control may be reduced automatically to save battery power.

### Manual air distribution



Press button repeatedly to select a program:

- ▷ Upper body region.
- ▷ Upper body region and floor area.
- ▷ Floor area.
- ▷ Windows and floor area: driver's side only.
- ▷ Windows, upper body region and floor area: driver's side only.

If the windows are fogged over, press the AUTO button to utilize the condensation sensor.

### Defrosting windows and removing condensation



Press button.

Ice and condensation are quickly removed from the windshield and the front side windows.

For this purpose, point the side vents towards the side windows as needed.

The air flow can be adjusted with the air flow active.

If the windows are fogged over, you can also switch on the cooling function or press the

AUTO button to utilize the condensation sensor.

### Rear window defroster



Press button.

The rear window defroster switches off automatically after a certain period of time.

### Microfilter/activated-charcoal filter

In external and recirculated-air mode the microfilter/activated charcoal filter filters dust, pollen, and gaseous pollutants out of the air.

This filter should be replaced during vehicle maintenance, refer to page 187.

## Ventilation

### Front ventilation

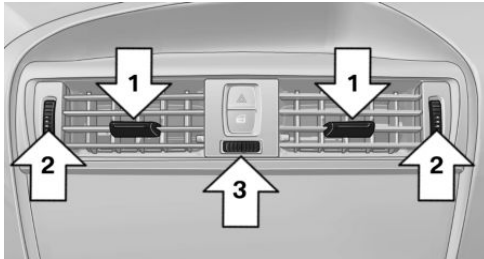

- ▷ Lever for changing the air flow direction, arrow 1.
- ▷ Thumbwheels for opening and closing the vents continuously, arrows 2.
- ▷ Thumbwheel to vary the ventilation temperature in the upper body region, arrow 3.  
Toward blue: colder.  
Toward red: warmer.  
This does not change the set interior temperature for the driver and front passenger.

### Adjusting the ventilation

- ▷ Ventilation for cooling:

Direct vent in your direction when vehicle's interior is too hot.

- ▷ Draft-free ventilation:

Adjust the vent to let the air flow past you.

### Ventilation in the rear

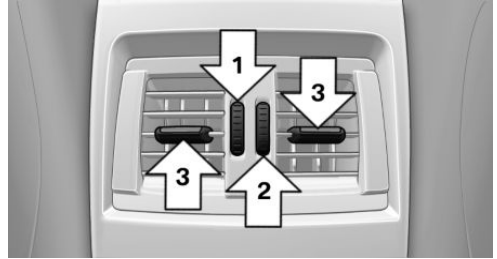

- ▷ Thumbwheel for variable opening and closing of the vents, arrow 1.
- ▷ Thumbwheel to vary the ventilation temperature, arrow 2.  
Toward blue: colder.  
Toward red: warmer.  
This does not change the adjusted interior temperature.
- ▷ Lever for changing the air flow direction, arrow 3.

## Parked-car ventilation

### The concept

The parked-car ventilation ventilates the vehicle interior and lowers its temperature, if needed.

The system can be switched on and off at any external temperature, either directly or by using two preset activation times. It remains switched on for 30 minutes.

Open the vents to allow air to flow out.

## Switching on/off directly

On the Control Display:

1. "Settings"
2. "Climate"
3. "Activate comf. ventilation"

☞ The symbol on the automatic climate control flashes if the system is switched on.

## Preselecting the activation time

On the Control Display:

1. "Settings"
2. "Climate"
3. "Timer 1:" or "Timer 2:"
4. Set the desired time.

## Activating the activation time

On the Control Display:

1. "Settings"
2. "Climate"
3. "Activate timer 1" or "Activate timer 2"

☞ The symbol on the automatic climate control lights up when the switch-on time is activated.

☞ The symbol on the automatic climate control flashes when the system has been switched on.

The system will only be switched on within the next 24 hours. After that, it needs to be reactivated.

# Interior equipment

## Vehicle features and options

This chapter describes all standard, country-specific and optional features offered with the series. It also describes features that are not necessarily available in your vehicle, e. g., due to the selected options or country versions. This also applies to safety-related functions and systems. When using these functions and systems, the applicable country provisions must be observed.

## Universal Integrated Remote Control

### Concept

The Universal Integrated Remote Control can operate up to 3 functions of remote-controlled systems such as garage door drives or lighting systems. The Universal Integrated Remote Control replaces up to 3 different hand-held transmitters. To operate the remote control, the buttons on the interior mirror must be programmed with the desired functions. The hand-held transmitter for the particular system is required in order to program the remote control.

Before selling the vehicle, delete the stored functions for the sake of security.

### Safety information



#### WARNING

Body parts can be jammed when operating remote-controlled systems, e.g., the garage door, using the integrated universal remote control. There is a risk of injury or risk of property damage. Make sure that the area of movement of the respective system is clear during programming and operation. Also follow

the safety instructions of the hand-held transmitter. ◀

### Compatibility



If this symbol is printed on the packaging or in the owner's manual of the system to be controlled, the system is generally compatible with the Universal Integrated Remote Control.

If you have any questions, please contact:

- ▷ A dealer's service center or another qualified service center or repair shop.
- ▷ [www.homelink.com](http://www.homelink.com) on the Internet.

HomeLink is a registered trademark of Gentex Corporation.

### Control elements on the interior mirror

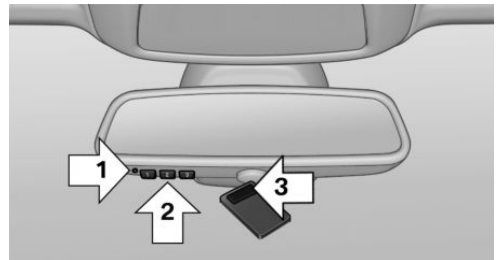

- ▷ LED, arrow 1.
- ▷ Buttons, arrow 2.
- ▷ The hand-held transmitter, arrow 3, is required for programming.

### Programming

#### General information

1. Switch on the ignition.
2. Initial setup:

Press and hold the left and right button on the interior mirror simultaneously for ap-

proximately 20 seconds until the LED on the interior mirror flashes. This erases all programming of the buttons on the interior mirror.

3. Hold the hand-held transmitter for the system to be controlled approx. 1 to 3 inches/2.5 to 8 cm away from the buttons of the interior mirror. The required distance depends on the hand-held transmitter.
4. Simultaneously press and hold the button of the desired function on the hand-held transmitter and the button to be programmed on the interior mirror. The LED on the interior mirror will begin flashing slowly.
5. Release both buttons as soon as the LED flashes more rapidly. The LED flashing faster indicates that the button on the interior mirror has been programmed.

If the LED does not flash faster after at least 60 seconds, change the distance between the interior mirror and the hand-held transmitter and repeat the step. Several more attempts at different distances may be necessary. Wait at least 15 seconds between attempts.

Canada: if programming with the hand-held transmitter was interrupted, hold down the interior mirror button and repeatedly press and release the hand-held transmitter button for 2 seconds.

6. To program other functions on other buttons, repeat steps 3 to 5.

The systems can be controlled using the interior mirror buttons.

### Special feature of the rolling code wireless system

If you are unable to operate the system after repeated programming, please check if the system to be controlled features a rolling code radio system.

Read the system's owner's manual, or press the programmed button on the interior mirror longer. If the LED on the interior mirror starts

flashing rapidly and then stays lit constantly for 2 seconds, the system features a rolling code radio system. Flashing and continuous illumination of the LED will repeat for approximately 20 seconds.

For systems with a rolling code radio system, the universal remote control and the system also have to be synchronized.

Please read the owner's manual to find out how to synchronize the system.

Synchronizing is easier with the aid of a second person.

Synchronizing the universal remote control with the system:

1. Park the vehicle within range of the remote-controlled system.
2. Program the relevant button on the interior mirror as described.
3. Locate and press the synchronizing button on the system being programmed. You have approx. 30 seconds for the next step.
4. Hold down the programmed button on the interior mirror for approximately 3 seconds and then release it. If necessary, repeat this step up to three times in order to finish synchronization. Once synchronization is complete, the programmed function will be carried out.

### Reprogramming individual buttons

1. Switch on the ignition.
2. Press and hold the interior mirror button to be programmed.
3. As soon as the interior mirror LED starts flashing slowly, hold the hand-held transmitter for the system to be controlled approx. 1 to 3 inches/2.5 to 8 cm away from the buttons of the interior mirror. The required distance depends on the hand-held transmitter.

4. Likewise, press and hold the button of the desired function on the hand-held transmitter.
5. Release both buttons as soon as the interior mirror LED flashes more rapidly. The LED flashing faster indicates that the button on the interior mirror has been programmed. The system can then be controlled by the button on the interior mirror. If the LED does not flash faster after at least 60 seconds, change the distance and repeat the step. Several more attempts at different distances may be necessary. Wait at least 15 seconds between attempts. Canada: if programming with the hand-held transmitter was interrupted, hold down the interior mirror button and repeatedly press and release the hand-held transmitter button for 2 seconds.

## Operation



### WARNING

Body parts can be jammed when operating remote-controlled systems, e.g., the garage door, using the integrated universal remote control. There is a risk of injury or risk of property damage. Make sure that the area of movement of the respective system is clear during programming and operation. Also follow the safety instructions of the hand-held transmitter. ◀

The system, such as the garage door, can be operated using the button on the interior mirror while the engine is running or when the ignition is started. To do this, hold down the button within receiving range of the system until the function is activated. The interior mirror LED stays lit while the wireless signal is being transmitted.

## Deleting stored functions

Press and hold the left and right button on the interior mirror simultaneously for approximately 20 seconds until the LED flashes rap-

idly. All stored functions will be deleted. The functions cannot be deleted individually.

## Digital compass

### Overview

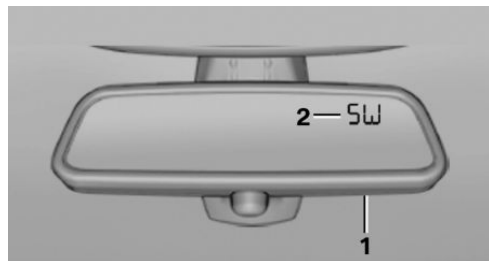

- 1 Control button
- 2 Mirror display

### Mirror display

The point of the compass is displayed in the mirror when driving straight.

### Operating concept

Various functions can be called up by pressing the control button with a pointed object, such as the tip of a ballpoint pen or similar object. The following setting options are displayed in succession, depending on how long the control button is pressed:

- ▶ Pressed briefly: turns display on/off.
- ▶ 3 to 6 seconds: compass zone setting.
- ▶ 6 to 9 seconds: compass calibration.
- ▶ 9 to 12 seconds: left/right-hand steering setting.
- ▶ 12 to 15 seconds: language setting.

### Setting the compass zones

Sets the particular compass zones on the vehicle so that the compass operates correctly; refer to World map with compass zones.

## World map with magnetic zones

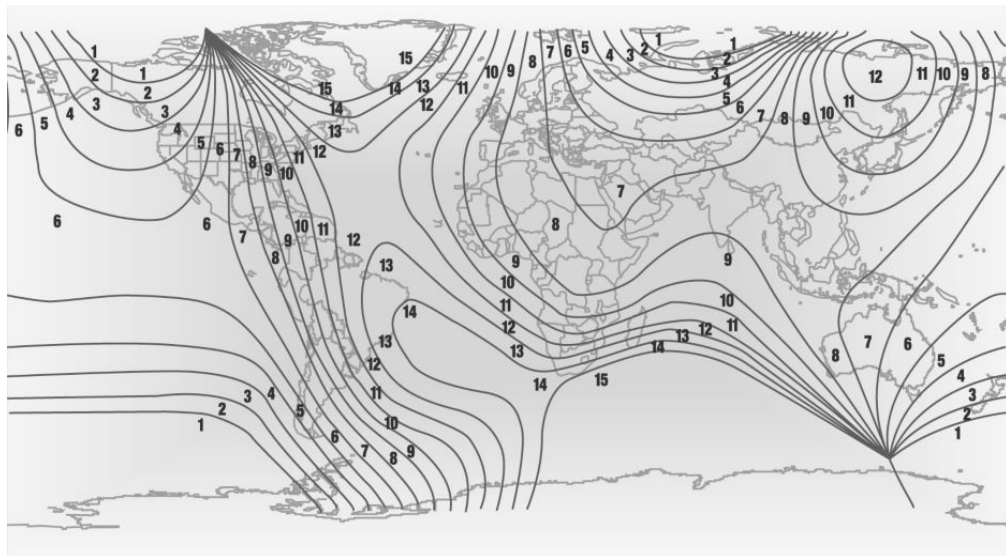

### Procedure

1. Press and hold the control button for approx. 3 to 4 seconds. The number of the set compass zone appears in the mirror.
2. To change the zone setting, press the control button quickly and repeatedly until the number of the compass zone that corresponds with your location appears in the mirror.

The set zone is stored automatically. The compass is ready for use again after approximately 10 seconds.

### Calibrating the digital compass

The digital compass must be calibrated in the event of the following:

- ▷ The wrong compass point is displayed.
- ▷ The point of the compass displayed does not change despite changing the direction of travel.
- ▷ Not all points of the compass are displayed.

### Procedure

1. Make sure that there are no large metallic objects or overhead power lines near the vehicle and that there is sufficient room to drive around in a circle.
2. Set the currently applicable compass zone.
3. Press and hold the control button for approx. 6 to 7 seconds so that "C" appears on the display. Next, drive in a complete circle at least once at a speed of no more than 4 mph/7 km/h. If calibration is successful, the "C" is replaced by the points of the compass.

### Left/right-hand steering

The digital compass is already set for right or left-hand steering at the factory.

### Setting the language

Press and hold the control button for approx. 12 to 13 seconds. Briefly press the control button again to switch between English "E" and German "O".

Settings are stored automatically after approximately 10 seconds.

## Sun visor

### Glare shield

Fold the sun visor down or up.

### Vanity mirror

A vanity mirror is located in the sun visor behind a cover. When the cover is opened, the mirror lighting switches on.

## Ashtray/cigarette lighter

### Ashtray

#### Opening

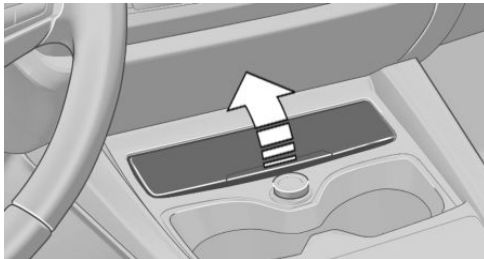

Raise cover.

#### Emptying

Take out the insert.

#### Lighter



#### WARNING

Contact with hot heating elements or the hot socket of the cigarette lighter can cause burns. Flammable materials can ignite if the cigarette lighter falls down or is held against the respective objects. There is a risk of fire and injuries. Hold the cigarette lighter by its handle. Make sure that children do not use the

cigarette lighter and do not burn themselves, e.g., by carrying the remote control with you when exiting the vehicle. ◀



#### NOTE

If metal objects fall into the socket, they can cause a short circuit. There is a risk of property damage. Replace the cigarette lighter or socket cover again after using the socket. ◀



The cigarette lighter is located in the center console.



Push in the lighter.

The lighter can be removed as soon as it pops back out.

## Sockets

### General information

The lighter socket can be used as a socket for electrical equipment while the engine is running or when the ignition is switched on.

The total load of all sockets must not exceed 140 watts at 12 volts.

Do not damage the socket by using non-compatible connectors.

### Safety information



#### NOTE

Battery chargers for the vehicle battery can work with high voltages and currents, which means that the 12 volt on-board net-

work can be overloaded or damaged. There is a risk of property damage. Only connect battery chargers for the vehicle battery to the starting aid terminals in the engine compartment. ◀



#### NOTE

If metal objects fall into the socket, they can cause a short circuit. There is a risk of property damage. Replace the cigarette lighter or socket cover again after using the socket. ◀

### Front center console

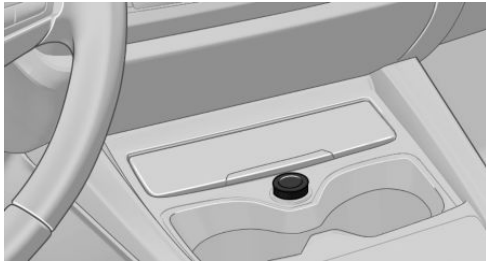

Remove the cover or cigarette lighter.

### Rear center console



Remove the cover.

### In the cargo area

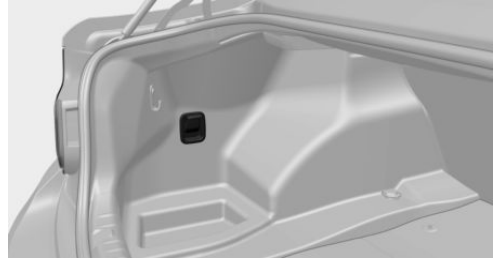

The socket is located on the left side in the cargo area.

## USB interface/AUX-IN port

### Concept

Mobile devices with USB port can be connected to the USB interface.

A mobile audio device, e.g., a MP3 player, can be connected using the AUX-IN port.

### General information

Depending on the equipment, the USB interface is located in the center console or in the glove compartment.

### USB interface in the glove compartment

Mobile storage devices with USB port can be connected to the USB interface in the glove compartment.

Common file systems are supported. FAT32 and exFAT are the recommended formats.

The following applications are possible:

- ▷ Exporting and importing profiles, refer to page 41.
- ▷ Loading of software updates.
- ▷ Adding music files to the music collection and saving the music collection.

## USB interface in the center console

In addition to the USB storage devices described above, additional mobile devices with USB port can be connected to the USB interface in the center console.

- ▷ Mobile phones supported by the USB interface.

The snap-in adapter features a separate USB port that is automatically connected when a compatible mobile phone is inserted.

- ▷ Audio devices with USB port, for example MP3 player.

This allows further uses:

- ▷ Playing music files via USB audio.
- ▷ Playing video films via USB video.

Information about compatible USB devices can be found at [www.bmwusa.com/bluetooth](http://www.bmwusa.com/bluetooth).

## Overview

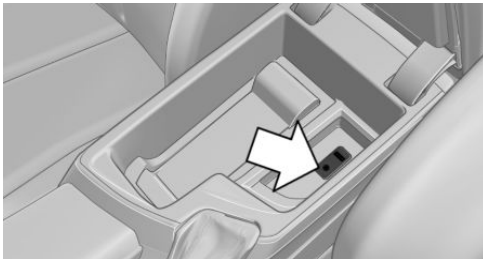

The USB interface and the AUX-IN port are located in the center armrest.

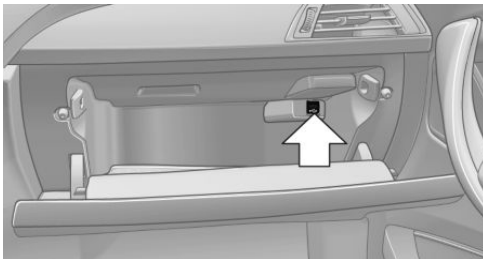

The USB interface is located in the glove compartment.

## Connecting an external device

Observe the following when connecting:

- ▷ Do not use force when plugging the connector into the USB interface.
- ▷ Use a flexible adapter cable.
- ▷ Protect the USB storage device against mechanical damage.
- ▷ Due to the large number of USB media available on the market, it cannot be guaranteed that every device is operable on the vehicle.
- ▷ Do not expose USB media to extreme environmental conditions, such as very high temperatures; refer to the device owner's manual.
- ▷ Due to the many different compression techniques, proper playback of the media stored on the USB storage device cannot be guaranteed in all cases.
- ▷ A connected USB storage device will be supplied with charging current via the USB interface if the device supports this.
- ▷ To ensure proper transmission of the stored data, do not charge a USB storage device via the onboard socket, when it is connected to the USB interface.
- ▷ Depending on how the USB storage device should be used, settings may be required on the USB storage device, refer to the device owner's manual.

Non-compatible USB media:

- ▷ USB hard drives.
- ▷ USB hubs.
- ▷ USB memory card readers with multiple inserts.
- ▷ HFS-formatted USB media.
- ▷ MTP devices.
- ▷ Devices such as fans or lights.

## Through-loading system

### Concept

The cargo area can be enlarged by folding down the rear seat backrest.

The rear seat backrest is divided into two parts at a ratio of 60 to 40.

With through-loading system: the rear seat backrest is divided into three parts at a 40/20/40 ratio.

The sides can be folded down separately or together.

### Safety information

#### WARNING

Danger of jamming with folding down the backrests. There is a risk of injury or risk of property damage. Make sure that the area of movement of the rear backrest and the of the head restraint is clear prior to folding down. ◀

#### WARNING

The stability of the child restraint system is limited or compromised with incorrect seat adjustment or improper installation of the child seat. There is a risk of injuries or danger to life. Make sure that the child restraint system fits securely against the backrest. If possible, adjust the backrest tilt for all affected backrests and correctly adjust the seats. Make sure that seats and backrests are securely engaged. If possible, adjust the height of the head restraints or remove them. ◀

#### NOTE

Vehicle parts can be damaged when folding down the rear backrest. There is a risk of property damage. Make sure that the area of movement of the rear backrest including head restraint is clear when folding down. ◀

### Opening

1. Pull the corresponding lever in the cargo area to release the rear seat backrest.

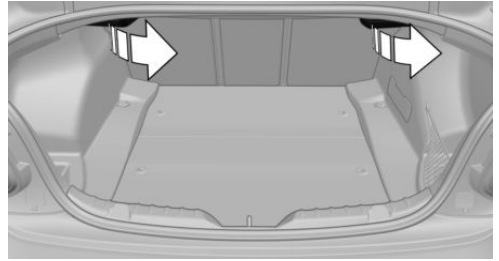

2. The unlocked backrest moves forward slightly.



3. Fold backrest forward.

### Closing

#### WARNING

With an unlocked backrest, an unsecured load can be thrown into the vehicle's interior, e.g., in case of an accident, braking or evasive maneuver. There is a risk of injury. Make sure that the backrest engages into the locking after folding it back. ◀

Return the rear seat backrest to the upright seating position and engage it.

To secure cargo, refer to page 157, with nets or draw straps, the cargo area is fitted with lashing eyes.

## Fold down the middle section

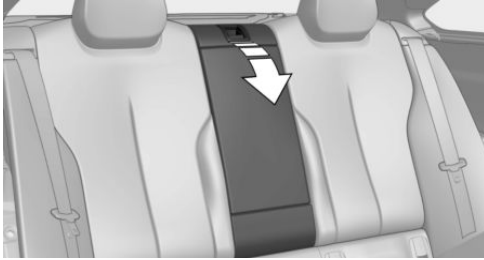

Reach into the recess and pull the middle section forward.

# Storage compartments

## Vehicle features and options

This chapter describes all standard, country-specific and optional features offered with the series. It also describes features that are not necessarily available in your vehicle, e. g., due to the selected options or country versions. This also applies to safety-related functions and systems. When using these functions and systems, the applicable country provisions must be observed.

- ▷ Without Smoker's package: Front storage compartment, in front of the cup holders, refer to page 145.
- ▷ Storage compartment in the front center armrest, refer to page 145.
- ▷ Nets on the backrests of the front seats.
- ▷ Storage compartment in the rear center console, refer to page 146.
- ▷ With two rear seats: Storage compartment between the rear seats, refer to page 146.

## Safety information

### WARNING

Loose objects or devices with a cable connection to the vehicle, e.g., mobile phones, can be thrown into the vehicle's interior while driving, e.g., in the event of an accident or during braking and evasive maneuvers. There is a risk of injury. Secure loose objects or devices with a cable connection to the vehicle in the vehicle's interior. ◀

### NOTE

Anti-slip pads such as anti-slip mats can damage the dashboard. There is a risk of property damage. Do not use anti-slip pads. ◀

## Storage compartments

The following storage compartments are available in the vehicle interior:

- ▷ Glove compartment on the front passenger side, refer to page 144.
- ▷ Glove compartment on the driver's side, refer to page 145.
- ▷ Compartments in the doors, refer to page 145.

## Glove compartment

### Front passenger side

#### Safety information

### WARNING

Folded open, the glove compartment protrudes in the vehicle's interior. Objects in the glove compartment can be thrown into the vehicle's interior while driving, e.g., in the event of an accident or during braking and evasive maneuvers. There is a risk of injury. Always close the glove compartment immediately after using it. ◀

#### Opening



Pull the handle.

The light in the glove compartment switches on.

### Closing

Fold cover closed.

### Locking

The glove compartment can be locked with an integrated key to separately secure the tailgate, refer to page 41, e.g.

This prevents access to the glove compartment and to the cargo area.

After the glove compartment is locked, the remote control can be handed over, such as at a hotel, without the integrated key.

### Driver's side

### Safety information



#### WARNING

Folded open, the glove compartment protrudes in the vehicle's interior. Objects in the glove compartment can be thrown into the vehicle's interior while driving, e.g., in the event of an accident or during braking and evasive maneuvers. There is a risk of injury. Always close the glove compartment immediately after using it. ◀

### Opening



Pull the handle.

### Closing

Fold cover closed.

## Compartments in the doors



#### WARNING

Breakable objects, e.g., glass bottles, can break in the event of an accident. Broken glass can be scattered in the vehicle's interior. There is a risk of injury. Do not stow any breakable objects in the vehicle's interior. ◀

## Front storage compartment



A storage compartment is located in the center armrest in front of the cup holders.

## Center armrest

### Front

A storage compartment is located in the center armrest between the front seats.

## Opening

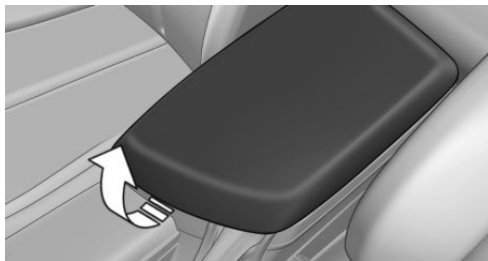

Fold the center armrest up.

## Repositioning

Center armrest can be pushed forwards or backwards. It engages in the end positions.

## Connection for an external audio device



An external audio device, e.g., an MP3 player, can be connected via the AUX-IN port or the USB audio interface in the center armrest.

## Storage compartment in the rear

A storage compartment is located in the center armrest.

## Storage compartment between the rear seats

There is a storage compartment between the rear seats.

## Cup holders

### Safety information



#### WARNING

Unsuitable containers in the cup holder and hot beverages can damage the cup holder and increase the risk of injury in the event of an accident. There is a risk of injury or risk of property damage. Use light-weight, unbreakable, and sealable containers. Do not transport hot beverages. Do not force objects into the cup holder. ◀

### Front



### Rear

In the center armrest.

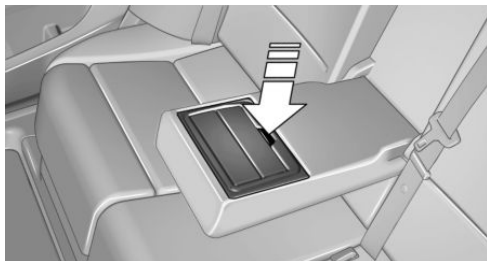

Pull the center armrest forward at the strap.

To open: press the button.

To close: push both covers back in, one after the other.

**NOTE**

With an open cup holder, the center armrest cannot be folded back up. There is a risk of property damage. Press back the covers before the center armrest is folded up. ◀

## Clothes hooks

### Safety information

**WARNING**

Clothing articles on the clothes hooks can obstruct the view while driving. There is a risk of an accident. When suspending clothing articles from the hooks, ensure that they will not obstruct the driver's view. ◀

**WARNING**

Improper use of the clothes hooks can lead to a risk of objects flying about during braking and evasive maneuvers. There is a risk of injury and risk of property damage. Only hang lightweight objects, e.g., clothing articles, from the clothes hooks. ◀

### General information

The clothes hooks are located in the rear.

## Storage compartments in the cargo area

### Storage compartment

One storage compartment each is located on the left and right side.

### Net for storage compartment

Smaller objects can be stored in the net of right storage compartment.

## Multi-function hook

**WARNING**

Improper use of the multi-function hooks can lead to a risk of objects flying about during braking and evasive maneuvers. There is a risk of injury and risk of property damage. Only hang lightweight objects, e.g., shopping bags, from the multi-function hooks. Only transport heavy luggage in the cargo area if it has been appropriately secured. ◀



A multi-function hook is located on each side of the cargo area.

## Lashing eyes in the cargo area

To secure the cargo, refer to page 157, there are two or four lashing eyes in the cargo area.

## Floor net

The floor net can also be used to secure the cargo, refer to page 157, and store small parts.



## Driving tips

This chapter provides you with information useful in dealing with specific driving and operating modes.

# BMW M2 Technology

## Vehicle features and options

This chapter describes all standard, country-specific and optional features offered with the series. It also describes features that are not necessarily available in your vehicle, e. g., due to the selected options or country versions. This also applies to safety-related functions and systems. When using these functions and systems, the applicable country provisions must be observed.

## High-performance engine

### General information

With a displacement of 3 liters, the high-performance engine generates a maximum power of 365 hp and a maximum torque of 343 lb ft/465 Nm with Overboost 369 lb ft/500 Nm. With its spontaneous response behavior, a speed range of wide utility results. The maximum engine speed is 7,000 rpm and is electronically controlled. Because of the high engine dynamics, the maximum engine speed with the vehicle stationary is reduced.

### Warm-up

During the engine warm-up phase, the high-performance engine has a somewhat rougher running behavior because of the emission controls.

When the engine is cold, the exhaust system has a slightly metallic undertone due to the nature of the system.

### Overboost

Overboost temporarily increases the maximum torque to 369 lb ft/500 Nm, for example when passing.

For this purpose, fully depress the accelerator pedal.

## Compound brake

The high-performance braking system has perforated compound brake discs.

Because of particular structural characteristics, there may be operation-related noises during braking. However, this has no effect on performance, operational reliability and reliability of the brake.

### Correct braking

To keep the brake system in optimum condition, it is expedient to apply them at regular intervals corresponding to the vehicle character.

## Drivetrain

With this vehicle, particular value was placed on the direct connection from engine to the drivetrain. Due to the torsionally rigid design of the drivetrain, as is typical in a sports car, the transmission of the torque also gives acoustic feedback.

When there are load changes, this may result in clicking noises. They do not cause any impairment of the operation or the service life of the components.

## Driving on racetracks

Higher mechanical and thermal loads during racetrack operation lead to increased wear. This wear is not covered by the warranty. The vehicle is not designed for motorsports competitive use.

The standard brake linings and the wear indicators are not designed for racetrack operation.

# Things to remember when driving

## Vehicle features and options

This chapter describes all standard, country-specific and optional features offered with the series. It also describes features that are not necessarily available in your vehicle, e. g., due to the selected options or country versions. This also applies to safety-related functions and systems. When using these functions and systems, the applicable country provisions must be observed.

## Breaking-in period

### General information

Moving parts need time to adjust to one another (break-in time).

The following instructions will help you to achieve a long vehicle life and good efficiency.

During break-in, do not use the Launch Control.

### Safety information



#### WARNING

Due to new parts and components, safety and driver assistance systems can react with a delay. There is a risk of an accident. After installing new parts or with a new vehicle, drive conservatively and intervene early if necessary. Observe the break-in procedures of the respective parts and components. ◀

## Engine, transmission, and axle drive

### Up to 1,200 miles/2,000 km

Drive at varying engine and road speeds, but do not exceed 5,500 rpm and 106 mph/170 km/h.

Avoid full load or kickdown under all circumstances.

### At 1,200 miles/2,000 km

Have drive-in checkup maintenance performed.

### From 1,200 miles/2,000 km to 3,100 miles/5,000 km

The engine and road speed can gradually be increased to a constant speed of 137 mph/220 km/h.

Use the maximum speed of 155 mph/250 km/h only briefly, e.g., when passing.

### Tires

Tire traction is not optimal due to manufacturing circumstances when tires are brand-new; they achieve their full traction potential after a break-in time.

Drive conservatively for the first 200 miles/300 km.

### Brake system

Brakes require an initial break-in period of approx. 300 miles/500 km to achieve optimal performance between brake discs and brake pads. Drive moderately during this break-in period.

### Clutch

The function of the clutch reaches its optimal level only after a distance driven of approx. 300 miles/500 km. During this break-in period, engage the clutch gently.

### Following part replacement

The same break-in procedures should be observed if any of the components above-mentioned have to be renewed in the course of the vehicle's operating life.

## General driving notes

### Closing the trunk lid



#### WARNING

An open tailgate protrudes from the vehicle and can endanger occupants and other traffic participants or damage the vehicle in the event of an accident, braking or evasive maneuvers. In addition, exhaust fumes may enter the vehicle interior. There is a risk of injury or risk of property damage. Do not drive with the tailgate open. ◀

If driving with the tailgate open cannot be avoided:

- ▷ Close all windows and the glass sunroof.
- ▷ Greatly increase the air flow from the vents.
- ▷ Drive moderately.

### Hot exhaust system



#### WARNING

During driving operation, high temperatures can occur underneath the vehicle body, e.g., caused by the exhaust gas system. If combustible materials, such as leaves or grass, come in contact with hot parts of the exhaust gas system, these materials can ignite. There is a risk of injury or risk of property damage. Do not remove the heat shields installed and never apply undercoating to them. Make sure that no combustible materials can come in contact with hot vehicle parts in driving operation, idle or during parking. Do not touch the hot exhaust system. ◀

### Mobile communication devices in the vehicle



#### WARNING

Vehicle electronics and mobile phones can influence one another. There is radiation due to the transmission operations of mobile phones. There is a risk of injury or risk of property damage. If possible, in the vehicle's inte-

rior use only mobile phones with direct connections to an exterior antenna in order to exclude mutual interference and deflect the radiation from the vehicle's interior. ◀

### Hydroplaning

On wet or slushy roads, a wedge of water can form between the tires and road surface.

This phenomenon is referred to as hydroplaning. It is characterized by a partial or complete loss of contact between the tires and the road surface, ultimately undermining your ability to steer and brake the vehicle.

### Driving through water



#### NOTE

When driving too quickly through too deep water, water can enter into the engine compartment, the electrical system or the transmission. There is a risk of property damage. When driving through water, do not exceed the maximum indicated water level and the maximum speed for driving through water. ◀

When driving through water, observe the following:

- ▷ Drive through calm water only.
- ▷ Drive through water only if it is not deeper than maximum 9.8 in/25 cm.
- ▷ Drive through water no faster than walking speed, up to 3 mph/5 km/h.

### Braking safely

Your vehicle is equipped with ABS as a standard feature.

Perform an emergency stop in situations that require such.

Steering is still responsive. You can still avoid any obstacles with a minimum of steering effort.

The pulsing of the brake pedal indicates that ABS is in its active mode.

In certain braking situations, the perforated brake discs can emit functional noises. However, this has no effect on the performance and operational reliability of the brake.

### Objects in the movement area around pedals and floor area



#### WARNING

Objects in the driver's floor area can limit the pedal distance or block a depressed pedal. There is a risk of an accident. Stow objects in the vehicle such that they are secured and cannot enter into the driver's floor area. Use floor mats that are suitable for the vehicle and can be safely attached to the floor. Do not use loose floor mats and do not layer several floor mats. Make sure that there is sufficient clearance for the pedals. Ensure that the floor mats are securely fastened again after they were removed, e.g., for cleaning. ◀

### Driving in wet conditions

When roads are wet, salted, or in heavy rain, gently press the brake pedal every few miles.

Ensure that this action does not endanger other traffic.

The heat generated during braking dries brake discs and brake pads and protects them against corrosion.

In this way braking efficiency will be available when you need it.

### Hills



#### WARNING

Light but consistent brake pressure can lead to high temperatures, brakes wearing out and possibly even brake failure. There is a risk of an accident. Avoid placing excessive stress on the brake system. ◀



#### WARNING

In idle state or with the engine switched off, safety-relevant functions, e.g., engine braking effect, braking force boost and steer-

ing assistance, are restricted or not available at all. There is a risk of an accident. Do not drive in idle state or with the engine switched off. ◀

Drive long or steep downhill gradients in the gear that requires least braking effort. Otherwise, the brakes may overheat and reduce brake efficiency.

Manual transmission:

You can increase the engine's braking effect by shifting down, going all the way to first gear, if needed.

M double-clutch transmission:

You can increase the engine's braking effect by shifting down in sequential mode, refer to page 76.

### Brake disc corrosion

Corrosion on the brake discs and contamination on the brake pads are increased by the following circumstances:

- ▶ Low mileage.
- ▶ Extended periods when the vehicle is not used at all.
- ▶ Infrequent use of the brakes.
- ▶ Aggressive, acidic, or alkaline cleaning agents.

Corrosion buildup on the brake discs will cause a pulsating effect on the brakes in their response - generally this cannot be corrected.

### Condensation water under the parked vehicle

When using the automatic climate control, condensation water develops and collects underneath the vehicle.

### Ground clearance



#### NOTE

If ground clearance is insufficient, there might be contact with the front or rear spoiler, e.g., when driving over curbs or entering into underground vehicle parking garages. There is

a risk of property damage. Ensure that there is sufficient ground clearance available.◀

### **M Driver's Package: driving in the higher speed range**



#### **WARNING**

Damage to vehicle components can negatively impact the driving performance at high speeds. This includes, among other things tires, underbody and parts for improving aerodynamics. There is a risk of an accident. Have damage corrected by a dealer's service center or another qualified service center or repair shop. Do not drive at high speeds until the damage is corrected.◀

# Loading

## Vehicle features and options

This chapter describes all standard, country-specific and optional features offered with the series. It also describes features that are not necessarily available in your vehicle, e. g., due to the selected options or country versions. This also applies to safety-related functions and systems. When using these functions and systems, the applicable country provisions must be observed.

## Safety information

### WARNING

High gross weight can overheat the tires, damage them, and cause a sudden drop in tire inflation pressure. There is a risk of an accident. Pay attention to the permitted load capacity of the tires and never exceed the permitted gross weight. ◀

### WARNING

Loose objects or devices with a cable connection to the vehicle, e.g., mobile phones, can be thrown into the vehicle's interior while driving, e.g., in the event of an accident or during braking and evasive maneuvers. There is a risk of injury. Secure loose objects or devices with a cable connection to the vehicle in the vehicle's interior. ◀

### WARNING

Improperly stowed objects can shift and be thrown into the vehicle's interior, e.g., in the event of an accident or during braking and evasive maneuvers. Vehicle occupants can be hit and injured. There is a risk of injury. Stow and secure objects and cargo properly. ◀

### NOTE

Fluids in the cargo area can cause damage. There is a risk of property damage. Make sure that no fluids leak in the cargo area. ◀

## Determining the load limit

1. Locate the following statement on your vehicle's placard:

The combined weight of occupants and cargo should never exceed XXX kg or YYY lbs. Otherwise, damage to the vehicle and unstable driving situations may result.



2. Determine the combined weight of the driver and passengers that will be riding in your vehicle.
3. Subtract the combined weight of the driver and passengers from XXX kilograms or YYY pounds.
4. The resulting figure equals the available amount of cargo and luggage load capacity.
 

E.g., if the YYY amount equals 1,000 lbs and there will be four 150 lbs passengers in your vehicle, the amount of available cargo and luggage load capacity is 400 lbs: 1,000 lbs minus 600 lbs = 400 lbs.
5. Determine the combined weight of luggage and cargo being loaded on the vehicle. That weight may not safely exceed the

available cargo and luggage load capacity calculated in Step 4.

## Load

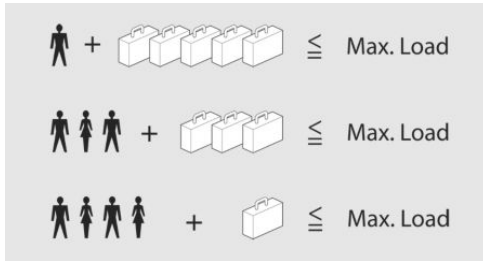

The maximum load is the sum of the weight of the occupants and the cargo.

The greater the weight of the occupants, the less cargo that can be transported.

## Stowing and securing cargo

- ▶ Cover sharp edges and corners on the cargo.
- ▶ Heavy cargo: stow as far forward as possible, directly behind and at the bottom of the rear passenger seat backrests.
- ▶ Very heavy cargo: when the rear seat is not occupied, secure each of the outer safety belts in the opposite buckle.
- ▶ If necessary, fold down the rear backrests to stow cargo.
- ▶ Do not stack cargo above the top edge of the backrests.
- ▶ Smaller and lighter cargo: secure with ratchet straps, the floor net, or draw straps.
- ▶ Larger and heavy cargo: secure with cargo straps.

## Lashing eyes in the cargo area

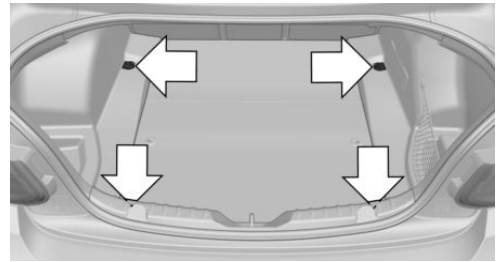

To secure the cargo there are two or four lashing eyes in the cargo area.

Attach load securing aids, such as lashing straps, retaining straps, draw straps or cargo nets, to the lashing eyes in the cargo area.

## Floor net

To secure the cargo the floor net can also be used.

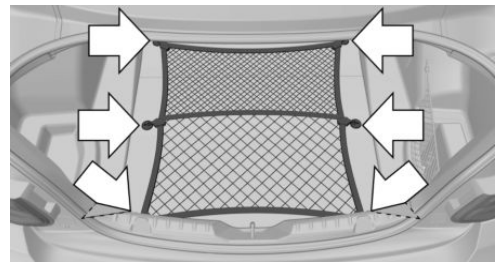

Hook the floor net into the fittings in the cargo area floor.

## Roof-mounted luggage rack

### General information

Roof racks are available as special accessories.

## Safety information



### WARNING

When driving with roof load, e.g., with roof-mounted luggage rack, driving safety may not be ensured in driving-critical situations due to the elevated center of gravity. There is a risk of accidents or risk of property damage. Do not deactivate Dynamic Stability Control DSC when driving with roof load. ◀

## Securing

Follow the installation instructions of the roof rack.

## Roof drip rail with flaps

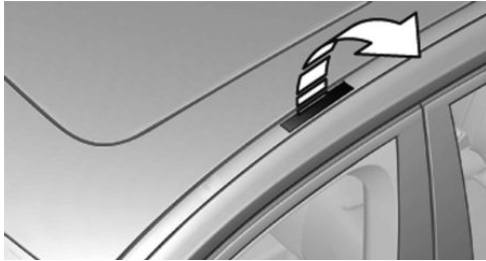

The anchorage points are located in the roof drip rail above the doors.

Fold the cover outward.

## Loading

Because roof-mounted luggage racks raise the vehicle's center of gravity when loaded, they have a major effect on vehicle handling and steering response.

Therefore, note the following when loading and driving:

- ▶ Do not exceed the approved roof/axle loads and the approved gross vehicle weight.
- ▶ Be sure that adequate clearance is maintained for tilting and opening the glass sunroof.
- ▶ Distribute the roof load uniformly.

- ▶ The roof load should not extend past the loading area.
- ▶ Always place the heaviest pieces on the bottom.
- ▶ Secure the roof luggage firmly, e.g., using ratchet straps.
- ▶ Do not let objects project into the opening path of the tailgate.
- ▶ Drive cautiously and avoid sudden acceleration and braking maneuvers. Take corners gently.

# Saving fuel

## Vehicle features and options

This chapter describes all standard, country-specific and optional features offered with the series. It also describes features that are not necessarily available in your vehicle, e. g., due to the selected options or country versions. This also applies to safety-related functions and systems. When using these functions and systems, the applicable country provisions must be observed.

## General information

The vehicle contains advanced technologies for the reduction of fuel consumption and emission values.

Fuel consumption depends on a number of different factors.

Carrying out certain measures, such as a moderate driving style and regular maintenance, can influence fuel consumption and the environmental impact.

## Remove unnecessary cargo

Additional weight increases fuel consumption.

## Remove attached parts following use

Remove roof-mounted luggage racks which are no longer required following use.

Attached parts on the vehicle impair the aerodynamics and increase the fuel consumption.

## Close the windows and glass sunroof

Driving with the glass sunroof and windows open results in increased air resistance and thereby reduces the range.

## Tires

### General information

Tires can affect fuel consumption in various ways, e.g., tire size may influence fuel consumption.

### Check the tire inflation pressure regularly

Check and, if needed, correct the tire inflation pressure at least twice a month and before starting on a long trip.

Low tire inflation pressure increases rolling resistance and thus raises fuel consumption and tire wear.

## Drive away immediately

Do not wait for the engine to warm-up while the vehicle remains stationary. Start driving right away, but at moderate engine speeds.

This is the quickest way of warming the cold engine up to operating temperature.

## Look well ahead when driving

Avoid unnecessary acceleration and braking.

By maintaining a suitable distance to the vehicle driving ahead of you.

Driving smoothly and proactively reduces fuel consumption.

## Avoid high engine speeds

As a rule: driving at low engine speeds lowers fuel consumption and reduces wear.

Use 1st gear to get the vehicle moving. Starting with the 2nd gear, accelerate rapidly. When accelerating, shift up before reaching high engine speeds.

When you reach the desired speed, shift into the highest applicable gear and drive with the engine speed as low as possible and at a constant speed.

If necessary, observe the gear shift indicator of the vehicle, refer to page [86](#).

## Use coasting

When approaching a red light, take your foot off the accelerator and let the vehicle coast to a halt.

For going downhill take your foot off the accelerator and let the vehicle roll.

The flow of fuel is interrupted while coasting.

## Switch off the engine during longer stops

Switch off the engine during longer stops, e.g., at traffic lights, railroad crossings or in traffic congestion.

### Auto Start/Stop function

The Auto Start/Stop function of the vehicle automatically switches off the engine during a stop.

If the engine is switched off and then restarted rather than leaving the engine running constantly, fuel consumption and emissions are reduced. Savings can begin within a few seconds of switching off the engine.

In addition, fuel consumption is also determined by other factors, such as driving style,

road conditions, maintenance or environmental factors.

## Switch off any functions that are not currently needed

Functions such as seat heating and the rear window defroster require a lot of energy and reduce the range, especially in city and stop-and-go traffic.

Switch off these functions if they are not needed.

## Have maintenance carried out

Have the vehicle maintained regularly to achieve optimal vehicle efficiency and service life. BMW recommends that maintenance work be performed by a BMW dealer's service center.

For information on the BMW Maintenance System, refer to page [187](#).







## Mobility

In order to always ensure your mobility, you will find important information on operating fluids, wheels and tires, maintenance and Roadside Assistance in the following.

# Refueling

## Vehicle features and options

This chapter describes all standard, country-specific and optional features offered with the series. It also describes features that are not necessarily available in your vehicle, e. g., due to the selected options or country versions. This also applies to safety-related functions and systems. When using these functions and systems, the applicable country provisions must be observed.

## General information

Observe the fuel recommendation, refer to page 166, prior to refueling.

## Safety information



### NOTE

With a range of less than 30 miles/50 km it is possible that the engine will no longer have sufficient fuel. Engine functions are not ensured anymore. There is a risk of property damage. Refuel promptly. ◀

## Fuel cap

### Opening

1. Briefly press the rear edge of the fuel filler flap.



2. Turn the fuel cap counterclockwise.

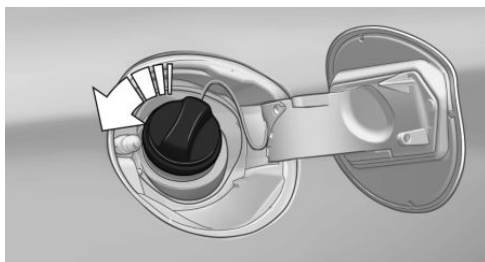

3. Place the fuel cap in the bracket attached to the fuel filler flap.

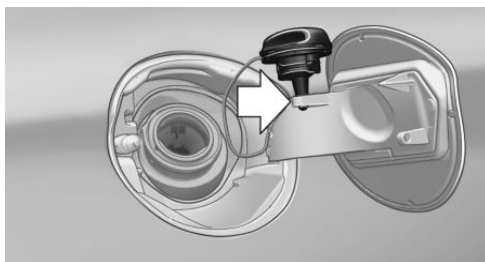

### Closing

1. Fit the lid and turn it clockwise until you clearly hear a click.

2. Close the fuel filler flap.



#### WARNING

The retaining strap of the fuel cap can be jammed and crushed during closing. The cap cannot be correctly closed. Fuel or fuel vapors can escape. There is a risk of injury or risk of property damage. Pay attention that the retaining strap is not jammed or crushed when closing the lid. ◀

### Manually unlocking fuel filler flap

E.g., in the event of an electrical malfunction.

Have fuel filler flap unlocked by a dealer's service center or another qualified service center or repair shop.

## Observe the following when refueling

### General information

The fuel tank is full when the filler nozzle clicks off the first time.

Observe safety regulations posted at the gas station.

### Safety information



#### NOTE

Fuels are toxic and aggressive. Overfilling of the fuel tank can damage the fuel system. Painted surfaces may be damaged by contact with fuel. Escaping fuel can harm the environment. There is a risk of property damage. Avoid overfilling. ◀

# Fuel

## Vehicle features and options

This chapter describes all standard, country-specific and optional features offered with the series. It also describes features that are not necessarily available in your vehicle, e. g., due to the selected options or country versions. This also applies to safety-related functions and systems. When using these functions and systems, the applicable country provisions must be observed.

## Fuel recommendation

### General information

Depending on the region, many gas stations sell fuel that has been customized to winter or summer conditions. Fuel that is available in winter, e.g., helps make a cold start easier.

### Gasoline

#### General information

For the best fuel efficiency, the gasoline should be sulfur-free or very low in sulfur content.

Fuels that are marked on the gas pump as containing metal must not be used.

Fuels with a maximum ethanol content of 10 %, i. e., E10, may be used for refueling.

Ethanol should satisfy the following quality standards:

US: ASTM 4806–xx

CAN: CGSB-3.511–xx

xx: comply with the current standard in each case.

## Safety information



### NOTE

Do not press the Start/Stop button after refueling with the wrong fuel. Furthermore, the catalytic converter is permanently damaged. There is a risk of property damage. Do not refuel or add the following in the case of gasoline engines:

- ▷ Leaded gasoline.
- ▷ Metallic additives, e.g., manganese or iron.

Do not press the Start/Stop button after refueling with the wrong fuel. Contact a dealer's service center or another qualified service center or repair shop. ◀



### NOTE

Incorrect fuels can damage the fuel system and the engine. There is a risk of property damage. Do not use a fuel with a higher ethanol percentage than recommended or one with other types of alcohol, e.g., M5 to M100. ◀



### NOTE

Fuel that does not comply with the minimum quality can compromise engine function or cause engine damage. There is a risk of property damage. Do not fill with fuel that does not comply with the minimum quality. ◀



### CAUTION

The use of poor-quality fuels may result in harmful engine deposits or damage. Additionally, problems relating to drivability, starting and stalling, especially under certain environmental conditions such as high ambient temperature and high altitude, may occur.

If drivability problems are encountered, we recommend switching to a high quality gasoline brand and a higher octane grade — AKI number — for a few tank fills. To avoid harmful en-

gine deposits, it is highly recommended to purchase gasoline from Top Tier retailers.

Failure to comply with these recommendations may result in the need for unscheduled maintenance.◀

### Recommended fuel grade

BMW recommends AKI 93.

### Minimum fuel grade

BMW recommends AKI 91.

If you use gasoline with this minimum AKI Rating, the engine may produce knocking sounds when starting at high outside temperatures.

This has no effect on the engine life.

**BMW M recommends**  **Shell V-Power**

# Wheels and tires

## Vehicle features and options

This chapter describes all standard, country-specific and optional features offered with the series. It also describes features that are not necessarily available in your vehicle, e. g., due to the selected options or country versions. This also applies to safety-related functions and systems. When using these functions and systems, the applicable country provisions must be observed.

## Tire inflation pressure

### Safety information

The tire characteristics and tire inflation pressure influence the following:

- ▷ The service life of the tires.
- ▷ Road safety.
- ▷ Driving comfort.

### Checking the tire inflation pressure



#### WARNING

A tire with low or missing tire inflation pressure impacts handling, such as steering and braking response. There is a risk of an accident. Regularly check the tire inflation pressure, and correct it as needed, e.g., twice a month and before a long trip. ◀

Tires have a natural, consistent loss of tire inflation pressure.

Tires heat up while driving, and the tire inflation pressure increases along with the tire's temperature. The tire inflation pressure specifications relate to cold tires or tires at ambient temperature.

Only check the tire inflation pressure when the tires are cold. This means after driving no more

than 1.25 miles/2 km or when the vehicle has been parked for at least 2 hours.

The displays of inflation devices may under-read by up to 0.1 bar/2 psi.

For Flat Tire Monitor: after correcting the tire inflation pressure, reinitialize the Flat Tire Monitor.

For Tire Pressure Monitor: perform a reset of the Tire Pressure Monitor after adjusting tire pressure to a new value.

### Tire inflation pressure specifications

The tire inflation pressure table, refer to page 169, contains all tire inflation pressure specifications for the specified tire sizes at the ambient temperature. The tire inflation pressure values apply to tire sizes approved by the manufacturer of the vehicle for the vehicle type.

To identify the correct tire inflation pressure, please note the following:

- ▷ Tire sizes of your vehicle.
- ▷ Maximum permitted driving speed.

### Tire inflation pressures up to 100 mph/160 km/h

For speeds of up to 100 mph/160 km/h and for optimum driving comfort, note the pressure values in the tire inflation pressure table, refer to page 169, and adjust as necessary.



These pressure values can also be found on the tire inflation pressure label on the driver's door pillar.

Do not exceed a speed of 100 mph/160 km/h.

## Tire inflation pressure values up to 100 mph/160 km/h

### M2

Tire size	Pressure specifications in bar/PSI	
Specifications in bar/PSI with cold tires		
235/40 R 18 95 V M+S XL Std	2.1 / 30	2.3 / 33
F: 245/35 R 19 93 (Y) XL Std	2.4 / 35	-
R: 265/35 R 19 98 (Y) XL Std	-	2.4 / 35

## Tire inflation pressures at max. speeds above 100 mph/160 km/h



### WARNING

In order to drive at maximum speeds in excess of 100 mph/160 km/h, please observe, and, if necessary, adjust tire pressures for speeds exceeding 100 mph/160 km/h from the

relevant table on the following pages. Otherwise, tire damage and accidents could occur. ◀

## Tire inflation pressure values over 100 mph/160 km/h

### M2

Tire size	Pressure specifications in bar/PSI	
Specifications in bar/PSI with cold tires		
235/40 R 18 95 V M+S XL Std	2.4 / 35	2.7 / 39
F: 245/35 R 19 93 (Y) XL Std	2.7 / 39	-
R: 265/35 R 19 98 (Y) XL Std	-	2.9 / 42

## Tire identification marks

### Tire size

245/45 R 18 96 Y

245: nominal width in mm

45: aspect ratio in %

R: radial tire code

18: rim diameter in inches

96: load rating, not for ZR tires

Y: speed rating, before the R on ZR tires

### Speed letter

Q = up to 100 mph, 160 km/h

R = up to 106 mph, 170 km/h

S = up to 112 mph, 180 km/h

T = up to 118 mph, 190 km/h

H = up to 131 mph, 210 km/h

V = up to 150 mph, 240 km/h

W = up to 167 mph, 270 km/h

Y = up to 186 mph, 300 km/h

## Tire Identification Number

DOT code: DOT xxxx xxx 2116

xxxx: manufacturer code for the tire brand

xxx: tire size and tire design

2116: tire age

Tires with DOT codes meet the guidelines of the U.S. Department of Transportation.

## Tire age

DOT ... 2116: the tire was manufactured in the 21st week of 2016.

## Recommendation

Regardless of wear and tear, replace tires at least every 6 years.

## Uniform Tire Quality Grading

Quality grades can be found where applicable on the tire sidewall between tread shoulder and maximum section width.

E.g.: Treadwear 200; Traction AA; Temperature A

## DOT Quality Grades

Treadwear

Traction AA A B C

Temperature A B C

All passenger vehicle tires must conform to Federal Safety Requirements in addition to these grades.

## Treadwear

The treadwear grade is a comparative rating based on the wear rate of the tire when tested under controlled conditions on a specified government test course. E.g., a tire graded 150 would wear one and one-half, 1 g, times as well on the government course as a tire graded

100. The relative performance of tires depends upon the actual conditions of their use, however, and may depart significantly from the norm due to variations in driving habits, service practices and differences in road characteristics and climate.

## Traction

The traction grades, from highest to lowest, are AA, A, B, and C.

Those grades represent the tire's ability to stop on wet pavement as measured under controlled conditions on specified government test surfaces of asphalt and concrete. A tire marked C may have poor traction performance.

The traction grade assigned to this tire is based on straight-ahead braking traction tests, and does not include acceleration, cornering, hydroplaning, or peak traction characteristics.

## Temperature

The temperature grades are A, the highest, B, and C, representing the tire's resistance to the generation of heat and its ability to dissipate heat when tested under controlled conditions on a specified indoor laboratory test wheel. Sustained high temperature can cause the material of the tire to degenerate and reduce tire life, and excessive temperature can lead to sudden tire failure. The grade C corresponds to a level of performance which all passenger vehicle tires must meet under the Federal Motor Vehicle Safety Standard No. 109. Grades Band A represent higher levels of performance on the laboratory test wheel than the minimum required by law.



### WARNING

The temperature grade for this tire is established for a tire that is properly inflated and not overloaded. Excessive speed, underinflation, or excessive loading, either separately or in combination, can cause heat buildup and possible tire failure. ◀

## M+S

Winter and all-season tires with better cold weather performance than summer tires.

## Tire tread

### Summer tires

Do not drive with a tire tread depth of less than 0.12 inches/3 mm.

There is an increased risk of hydroplaning if the tire tread depth is less than 0.12 inches/3 mm.

### Winter tires

Do not drive with a tire tread depth of less than 0.16 inches/4 mm.

Below a tread depth of 0.16 inches/4 mm, tires are less suitable for winter operation.

### Minimum tread depth

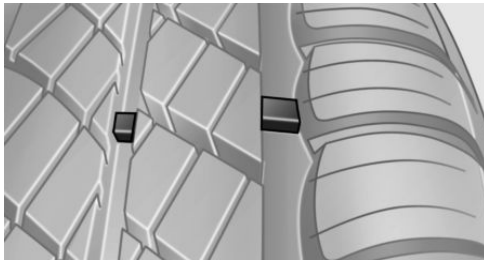

Wear indicators are distributed around the tire's circumference and have the legally required minimum height of 0.063 inches/1.6 mm.

They are marked on the side of the tire with TWI, Tread Wear Indicator.

## Tire damage

### General information

Inspect your tires regularly for damage, foreign objects lodged in the tread, and tread wear.

Driving over rough or damaged road surfaces, as well as debris, curbs and other obstacles can cause serious damage to wheels, tires and suspension parts. This is more likely to occur with low-profile tires, which provide less cushioning between the wheel and the road. Be careful to avoid road hazards and reduce your speed, especially if your vehicle is equipped with low-profile tires.

Indications of tire damage or other vehicle malfunctions:

- ▶ Unusual vibrations while driving.
- ▶ Unusual handling such as a strong tendency to pull to the left or right.

Damage can, e.g., be caused by driving over curbs, road damage, or similar things.

### Safety information



#### WARNING

Damaged tires can lose tire inflation pressure, which can lead to loss of vehicle control. There is a risk of an accident. If tire damage is suspected while driving, immediately reduce speed and stop. Have wheels and tires checked. For this purpose, drive carefully to the nearest dealer's service center or another qualified service center or repair shop. Have vehicle towed or transported as needed. ◀



#### WARNING

Damaged tires can lose tire inflation pressure, which can lead to loss of vehicle control. There is a risk of an accident. Do not repair damaged tires, but have them replaced. ◀

## Changing wheels and tires

### Mounting

Have mounting and wheel balancing carried out by a dealer's service center or another qualified service center or repair shop.

## Wheel and tire combination

You can ask the dealer's service center or another qualified service center or repair shop about the correct wheel/tire combination and wheel rim versions for the vehicle.

Incorrect wheel and tire combinations impair the function of a variety of systems such as ABS or DSC.

To maintain good handling and vehicle response, use only tires with a single tread configuration from a single manufacturer.

Following tire damage, have the original wheel and tire combination remounted on the vehicle as soon as possible.

### WARNING

Wheels and tires which are not suitable for your vehicle can damage parts of the vehicle, e.g., due to contact with the body due to tolerances despite the same official size rating. There is a risk of an accident. The manufacturer of your vehicle strongly suggests that you use wheels and tires that have been recommended by the vehicle manufacturer for your vehicle type. ◀

## Recommended tire brands



For each tire size, BMW recommends certain tire brands. These can be identified by a star on the tire sidewall.

## New tires

Tire traction is not optimal due to manufacturing circumstances when tires are brand-new;

they achieve their full traction potential after a break-in time.

Drive conservatively for the first 200 miles/300 km.

## Retreaded tires

The manufacturer of your vehicle does not recommend the use of retreaded tires.



### WARNING

Retreaded tires can have different tire casing structures. With advanced age the service life can be limited. There is a risk of an accident. The manufacturer of your vehicle does not recommend the use of retreaded tires. ◀

## Winter tires

Winter tires are recommended for operating on winter roads.

Although so-called all-season M+S tires provide better winter traction than summer tires, they do not provide the same level of performance as winter tires.

## Maximum speed of winter tires

If the maximum speed of the vehicle is higher than the permissible speed for the winter tires, then attach a corresponding information label/sticker in the field of view. The label is available from a dealer's service center or another qualified service center or repair shop.

With mounted winter tires, observe and adhere to the permissible maximum speed.

## Rotating wheels between axles

The manufacturer of your vehicle advises against switching wheels between the front and rear axles. This can impair the handling characteristics.

Rotating the tires between the axes is not permissible on vehicles with different tire sizes or rim sizes on the front and rear axles.

## Storage

Store wheels and tires in a cool, dry place with as little exposure to light as possible.

Always protect tires against all contact with oil, grease and fuels.

Do not exceed the maximum tire inflation pressure indicated on the side wall of the tire.

## Repairing a flat tire

### Safety measures

- ▷ Park the vehicle as far away as possible from passing traffic and on solid ground.
- ▷ Switch on the hazard warning system.
- ▷ Secure the vehicle against rolling away by setting the parking brake.
- ▷ Turn the steering wheel until the front wheels are in the straight-ahead position and engage the steering wheel lock.
- ▷ Have all vehicle occupants get out of the vehicle and ensure that they remain outside the immediate area in a safe place, such as behind a guardrail.
- ▷ If necessary, set up a warning triangle at an appropriate distance.

## Mobility System

### Concept

With the Mobility System, minor tire damage can be sealed temporarily to enable continued travel. To accomplish this, sealant is pumped into the tires, which seals the damage from the inside.

The compressor can be used to check the tire inflation pressure.

### General information

- ▷ Follow the instructions on using the Mobility System found on the compressor and sealant container.

- ▷ Use of the Mobility System may be ineffective if the tire puncture measures approx. 1/8 inches/4 mm or more.
- ▷ Contact a dealer's service center or another qualified service center or repair shop if the tire cannot be made drivable.
- ▷ If possible, do not remove foreign bodies that have penetrated the tire.
- ▷ Pull the speed limit sticker off the sealant container and apply it to the steering wheel.
- ▷ The use of a sealant can damage the TPM wheel electronics. In this case, have the electronics checked at the next opportunity and have them replaced, if needed.

### Storage

The Mobility System is located under the cargo floor panel.

### Sealant container



- ▷ Sealant container, arrow 1.
- ▷ Filling hose, arrow 2.

Observe use-by date on the sealant container.

## Compressor

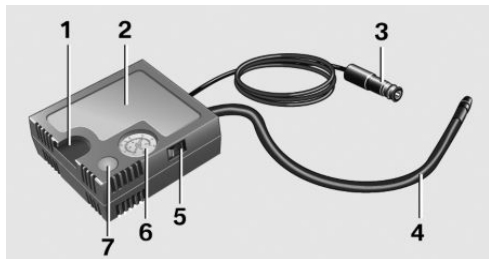

- 1 Holder for sealant container
- 2 Compressor
- 3 Connector/cable for socket
- 4 Connection hose
- 5 On/off switch
- 6 Inflation pressure dial
- 7 Reduce inflation pressure

## Filling the tire with sealant

1. Shake the sealant container.



2. Pull the connection hose fully out of the compressor housing. Do not kink the hose.

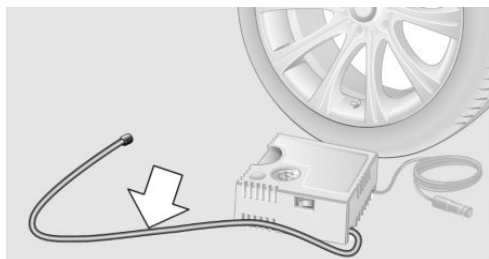

3. Screw the connection hose onto the connector of the sealant container.

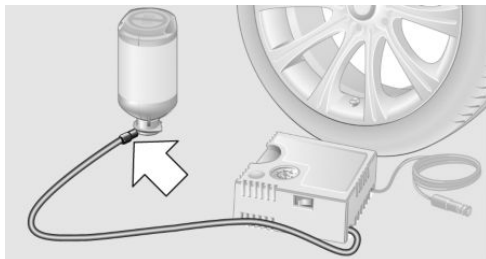

4. Insert the sealant container on the compressor housing in an upright position.

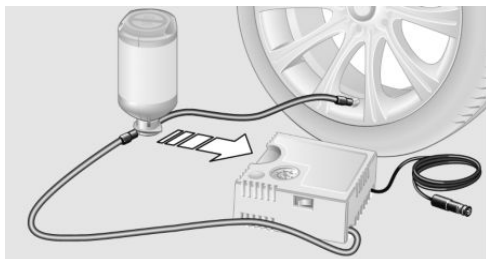

5. Screw the filling hose of the sealant container onto the tire valve of the nonworking wheel.

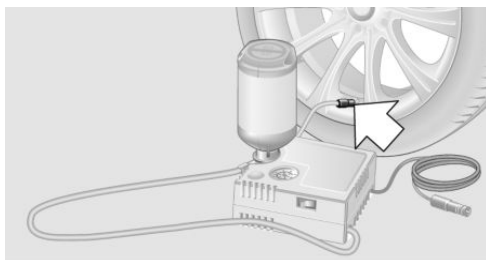

6. With the compressor switched off, insert the plug into the power socket inside the vehicle.

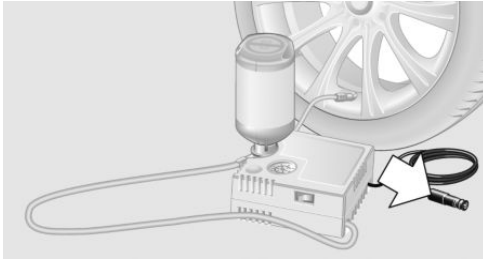

7. With the ignition turned on or the engine running, switch on the compressor.

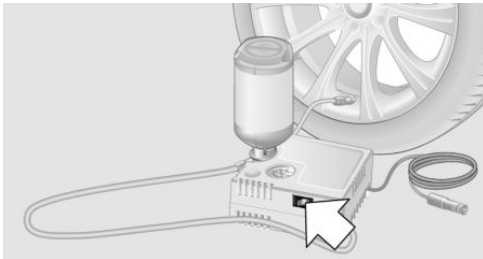

#### DANGER

If the exhaust pipe is blocked or ventilation is insufficient, harmful exhaust gases can enter into the vehicle. The exhaust gases contain carbon monoxide, an odorless and colorless but highly toxic gas. In enclosed areas, exhaust gases can also accumulate outside of the vehicle. There is danger to life. Keep the exhaust pipe free and ensure sufficient ventilation. ◀



#### NOTE

The compressor can overheat during extended operation. There is a risk of property damage. Do not run the compressor for more than 10 min. ◀

Let the compressor run for approx. 3 to 8 minutes to fill the tire with sealant and achieve a tire inflation pressure of approx. 2.5 bar.

While the tire is being filled with sealant, the tire inflation pressure may sporadically reach approx. 5 bar. Do not switch off the compressor at this point.

If a tire inflation pressure of 2 bar is not reached:

1. Switch off the compressor.
2. Unscrew the filling hose from the wheel.
3. Drive 33 ft/10 m forward and back to distribute the sealant in the tire.
4. Inflate the tire again using the compressor.

If a tire inflation pressure of 2 bar cannot be reached, contact your dealer's service center or another qualified service center or repair shop.

### Stowing the Mobility System

1. Unscrew the filling hose of the sealant container from the wheel.
2. Unscrew the connection hose of the compressor from the sealant container.
3. Connect the filling hose of the sealant container previously connected to the tire valve with the available connector on the sealant container.

This prevents leftover sealant from escaping from the container.

4. Wrap the empty sealant container in suitable material to avoid dirtying the cargo area.
5. Stow the Mobility System back in the vehicle.

### Distributing the sealant

Immediately drive approx. 5 miles/10 km to ensure that the sealant is evenly distributed in the tire.

Do not exceed a speed of 50 mph/80 km/h.

If possible, do not drive at speeds less than 12 mph/20 km/h.

## Correcting the tire inflation pressure

1. Stop at a suitable location.
2. Screw the connection hose of the compressor directly onto the tire valve stem.
3. Insert the connector into the power socket inside the vehicle.
4. Correct the tire inflation pressure to 2.5 bar.
  - ▶ Increase pressure: with the ignition turned on or the engine running, switch on the compressor.
  - ▶ To reduce the pressure: press the button on the compressor.

## Continuing the trip

Do not exceed the maximum permissible speed of 50 mph/80 km/h.

Reinitialize the Flat Tire Monitor.

Reinitialize the Tire Pressure Monitor.

Replace the nonworking tire and the sealant container of the Mobility System as soon as possible.

## Snow chains

### Fine-link snow chains

The manufacturer of your vehicle recommends use of fine-link snow chains. Certain types of fine-link snow chains have been tested by the manufacturer of the vehicle and recommended as road-safe and suitable.

Information regarding suitable snow chains is available from a dealer's service center or another qualified service center or repair shop.

### Use

 **WARNING**

With the mounting of snow chains on unsuitable tires, the snow chains can come into contact with vehicle parts. There is a risk of accidents or risk of property damage. Only mount

snow chains on tires that are designated by their manufacturer as suitable for the use of snow chains. ◀

Use only in pairs on the rear wheels, equipped with the tires of the following size:

- ▶ 235/40 R 18.

Follow the snow chain manufacturer's instructions.

Make sure that the snow chains are always sufficiently tight. Re-tighten as needed according to the snow chain manufacturer's instructions.

Do not initialize the Flat Tire Monitor after mounting snow chains, as doing so may result in incorrect readings.

Do not initialize the Tire Pressure Monitor after mounting snow chains, as doing so may result in incorrect readings.

When driving with snow chains, if needed, briefly activate M Dynamic Mode.

### Maximum speed with snow chains

Do not exceed a speed of 30 mph/50 km/h when using snow chains.

## Changing wheels/tires

### General information

When tire sealants are used, an immediate wheel change when there is a loss of tire inflation pressure in the event of a flat tire is not always necessary.

If needed, the tools for changing wheels are available as accessories from a dealer's service center or another qualified service center or repair shop.

### Safety information

 **WARNING**

On soft or slippery ground, e.g., snow, ice, tiles, etc., the vehicle jack can slip away. There is a risk of injury. If possible, change the

tire/wheel on a flat, solid and slip-resistant surface. ◀

**⚠ WARNING**

The vehicle jack is only provided for short-term lifting of the vehicle for wheel changes. Even if all safety measures are observed, there is a risk of the raised vehicle falling, if the vehicle jack tilts over. There is a risk of injuries or danger to life. If the vehicle is raised, do not lie under the vehicle and do not start the engine. ◀

**⚠ WARNING**

The vehicle jack is optimized for lifting the vehicle and for the jacking points on the vehicle only. There is a risk of injury. Do not lift any other vehicle or cargo using the vehicle jack. ◀

**⚠ WARNING**

If the vehicle jack is not inserted into the designated jacking point, damage to the vehicle may occur while cranking the vehicle up, or the vehicle jack can slip away. There is a risk of injury or risk of property damage. Make sure that the vehicle jack is inserted into the jacking point next to the wheel house while cranking the vehicle up. ◀

## Securing the vehicle against rolling

### General information

The vehicle manufacturer recommends to additionally secure the vehicle against rolling away when changing a wheel.

### On a level surface



Place chocks or other suitable objects, for example a rock, in front of and behind the wheel that is diagonally opposite to the wheel that you wish to change.

### On slight down-hill grades

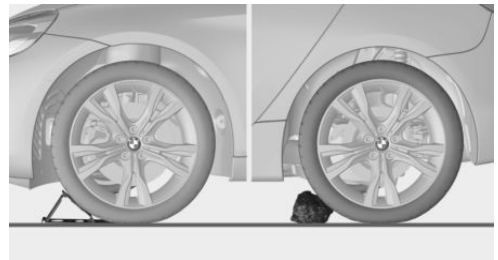

If a wheel needs to be changed on a slight down-hill grade, place wheel chocks or other suitable objects, e.g. a stone, under the wheels of the front and rear axle.

### Preparing the vehicle

- ▷ Change the wheel as far away as possible from passing traffic.
- ▷ Park the vehicle on solid, non-slip and level ground.
- ▷ Switch on the hazard warning system.
- ▷ Set the parking brake.
- ▷ Engage a gear or selector lever position P.
- ▷ As soon as permitted by the traffic flow, have all vehicle occupants get out of the vehicle and ensure that they remain out-

side the immediate area in a safe place, such as behind a guardrail.

- ▷ Depending on the equipment version, get tools and the emergency wheel from the vehicle.
- ▷ If necessary, set up a warning triangle or portable hazard warning lamp at an appropriate distance.
- ▷ Do not place wood blocks or similar items under the vehicle jack; otherwise, it cannot reach its carrying capacity because of the restricted height.
- ▷ Secure the vehicle additionally against rolling.
- ▷ Loosen the lug bolts a half turn.

### Jacking points for the vehicle jack

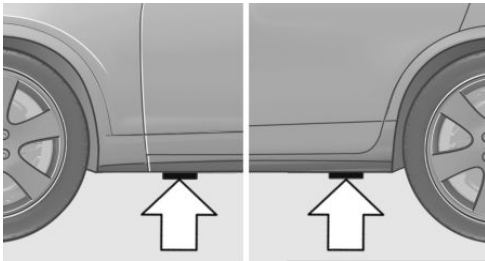

The jacking points for the vehicle jack are located at the positions shown.

### Jacking up the vehicle

1. Hold the vehicle jack with one hand, arrow 1, and grasp the crank, arrow 2, with the other hand.



**WARNING**

Hands and fingers can be jammed when using the vehicle jack. There is a risk of injury. Comply with the described hand

position and do not change this position while using the vehicle jack. ◀

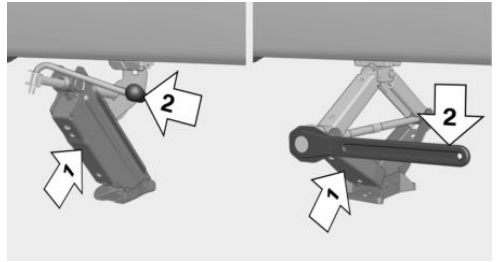

2. Insert the vehicle jack into the rectangular recess of the jacking point closest to the wheel to be changed.

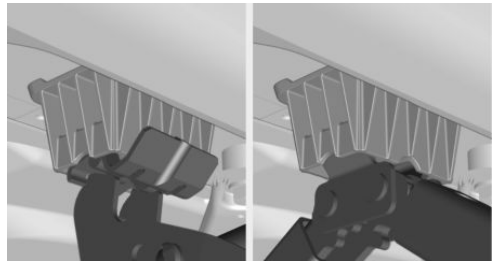

3. Extend the vehicle jack by turning the crank clockwise.

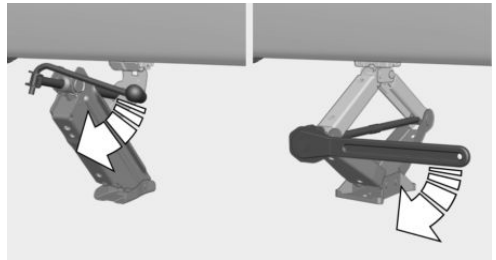

4. Make sure that the vehicle jack foot is extended vertically.

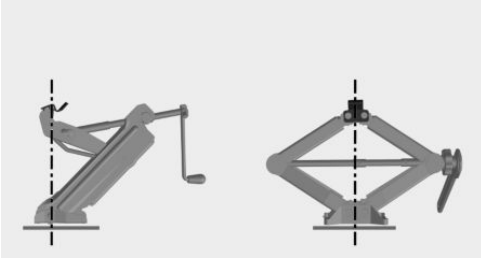

5. Make sure that the vehicle jack foot stands vertically and perpendicularly beneath the jacking point after extending the vehicle jack.

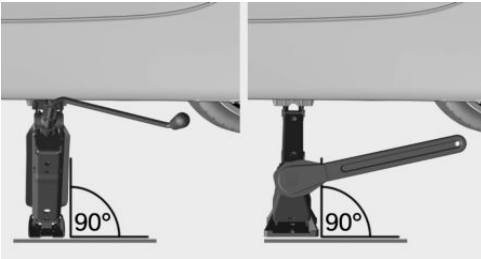

6. Crank up the vehicle jack until the entire surface of the jack is in contact with the ground and the wheel in question is raised a maximum of 1.2 inches/3 cm off the ground.

## Wheel mounting

Mount a maximum of one emergency wheel.

1. Unscrew the lug bolts and remove the wheel.
2. Put the new wheel or emergency wheel on and hand-tighten at least two bolts in a crosswise pattern.

If non-original light-alloy wheels of the vehicle manufacturer are mounted, the accompanying lug bolts may have to be used as well.

3. Hand-tighten the remaining lug bolts and tighten all bolts well in a crosswise pattern.

4. Turn the crank of the vehicle jack counter-clockwise to retract the vehicle jack and lower the vehicle.
5. Remove the vehicle jack.

## After the wheel change

1. Tighten the lug bolts crosswise. The tightening torque is 101 lb ft/140 Nm.
2. Stow the nonworking wheel in the cargo area.  
The nonworking wheel cannot be stored under the cargo floor panel because of its size.
3. Check tire inflation pressure at the next opportunity and correct as needed.
4. Reinitialize the Flat Tire Monitor.  
Reset the Tire Pressure Monitor.
5. Check to make sure the lug bolts are tight with a calibrated torque wrench.
6. Drive to the nearest dealer's service center or another qualified service center or repair shop to have the damaged tire replaced.

# Engine compartment

## Vehicle features and options

This chapter describes all standard, country-specific and optional features offered with the series. It also describes features that are not necessarily available in your vehicle, e. g., due

to the selected options or country versions. This also applies to safety-related functions and systems. When using these functions and systems, the applicable country provisions must be observed.

## Important features in the engine compartment

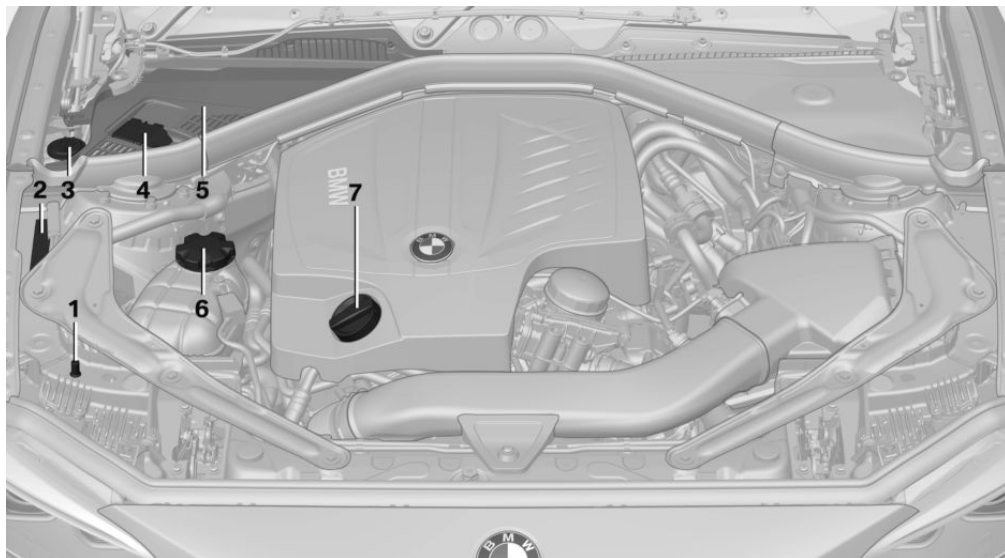

- |   |  |   |                             |
|---|--|---|-----------------------------|
| 1 | Jump-starting, negative battery terminal | 5 | Engine compartment fuse box |
| 2 | Vehicle identification number            | 6 | Coolant reservoir           |
| 3 | Washer fluid reservoir                   | 7 | Oil filler neck             |
| 4 | Jump-starting, positive battery terminal |   |                             |

## Hood

### Safety information



#### WARNING

Improperly executed work in the engine compartment can damage vehicle components and impair vehicle functions. There is a

risk of personal and property damage. The manufacturer of your vehicle recommends that, in the effort to avoid such risks, work in the engine compartment be performed by a dealer's service center or another qualified service center or repair shop. ◀

**WARNING**

The engine compartment accommodates moving components. Certain components in the engine compartment can also move with the vehicle switched off, e.g., the radiator fan. There is a risk of injury. Do not reach into the area of moving parts. Keep articles of clothing and hair away from moving parts. ◀

**WARNING**

There are protruding parts, e.g., locking hook, on the inside of the hood. There is a risk of injury. If the hood is open, pay attention to protruding parts and keep these areas clear. ◀

**WARNING**

An incorrectly locked hood can open while driving and restrict visibility. There is a risk of an accident. Stop immediately and correctly close the hood. ◀

**WARNING**

Body parts can be jammed when opening and closing the hood. There is a risk of injury. Make sure that the area of movement of the hood is clear during opening and closing. ◀

**NOTE**

Folded-away wipers can be jammed when the hood is opened. There is a risk of property damage. Make sure that the wipers with the wiper blades mounted are folded down onto the windshield before opening the hood. ◀

## Opening the hood

1. Pull lever, arrow 1.

Hood is unlocked.

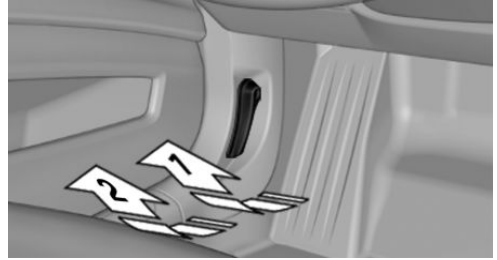

2. After the lever is released, pull the lever again, arrow 2.

Hood can be opened.

## Indicator/warning lights

When the hood is unlocked, a Check Control message is displayed.

## Closing the hood

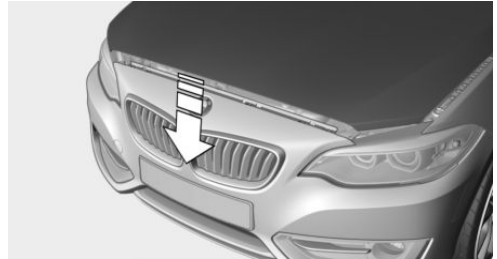

Let the hood drop from a height of approx. 16 inches/40 cm and push down on it to lock it fully.

The hood must engage on both sides.

# Engine oil

## Vehicle features and options

This chapter describes all standard, country-specific and optional features offered with the series. It also describes features that are not necessarily available in your vehicle, e. g., due to the selected options or country versions. This also applies to safety-related functions and systems. When using these functions and systems, the applicable country provisions must be observed.

## General information

The engine oil consumption is dependent on the driving style and driving conditions.

The engine oil consumption can increase in the following situations, for example:

- ▷ Sporty driving style.
- ▷ Break-in of the engine.
- ▷ Idling of the engine.
- ▷ With use of engine oil types that are classified as not suitable.

Therefore, regularly check the engine oil level after refueling.

When a dynamic driving style is used, such as when cornering fast, the system is unable to measure the engine oil level. With this driving style, measure the engine oil level using a detailed measurement, refer to page 183.

The vehicle is equipped with electronic oil measurement.

The electronic oil measurement has two measuring principles:

- ▷ Status display.
- ▷ Detailed measurement.

## Electronic oil measurement

### Status display

#### Concept

The engine oil level is monitored electronically while driving and shown on the Control Display.

If the engine oil level reaches the minimum level, a Check Control message is displayed.

#### Requirements

A current measured value is available after approx. 30 minutes of driving. During a shorter trip, the status of the last, sufficiently long trip is displayed.

With frequent short-distance trips, regularly perform a detailed measurement.

### Displaying the engine oil level

Via iDrive:

1. "Vehicle info"
2. "Vehicle status"
3.  "Engine oil level"

The engine oil level is displayed.

### Engine oil level display messages

Different messages appear on the display depending on the engine oil level. Pay attention to these messages.

If the engine oil level is too low within the next 125 miles/200 km, add engine oil.



A red indicator lamp indicates too high engine oil pressure.



#### NOTE

An engine oil level that is too low causes engine damage. There is a risk of property damage. Immediately add engine oil. ◀

Take care not to add too much engine oil.

### NOTE

Too much engine oil can damage the engine or the catalytic converter. There is a risk of property damage. Do not add too much engine oil. When too much engine oil is added, have oil level corrected by a dealer's service center or another qualified service center or repair shop. ◀

## Detailed measurement

### Concept

In the detailed measurement the engine oil level is checked when the vehicle is stationary, and displayed via a scale.

If the engine oil level reaches the minimum level, a Check Control message is displayed.

During the measurement, the idle speed is increased somewhat.

### Requirements

- ▶ Vehicle is parked in a horizontal position.
- ▶ Manual transmission: shift lever in neutral position, clutch and accelerator pedals not depressed.
- ▶ M Double clutch transmission: selector lever in selector lever position N and accelerator pedal not depressed.
- ▶ Engine is running and is at operating temperature.

### Performing a detailed measurement

In order to perform a detailed measurement of the engine oil level:

1. "Vehicle info"
2. "Vehicle status"
3.  "Measure engine oil level"
4. "Start measurement"

The engine oil level is checked and displayed via a scale.

Time: approx. 1 minute.

## Adding engine oil

### General information

Only add engine oil when the message is displayed in the instrument cluster. The quantity to be added is indicated in the message displayed in the instrument cluster.

Switch off the ignition and safely park the vehicle before engine oil is added.

Take care not to add too much engine oil.

### Safety information

#### WARNING

Operating materials, e.g., oils, greases, coolants, fuels, can contain harmful ingredients. There is a risk of injuries or danger to life. Observe the instructions on the containers. Avoid the contact of articles of clothing, skin or eyes with operating materials. Do not refill operating materials into different bottles. Store operating materials out of reach of children. ◀

#### NOTE

An engine oil level that is too low causes engine damage. There is a risk of property damage.

Add engine oil within the next 125 miles/200 km. ◀

#### NOTE

Too much engine oil can damage the engine or the catalytic converter. There is a risk of property damage. Do not add too much engine oil. When too much engine oil is added, have oil level corrected by a dealer's service center or another qualified service center or repair shop. ◀

### Overview

The oil filler neck is located in the engine compartment, refer to page 180.

## Opening the oil filler neck

1. Open the hood, refer to page 180.
2. Turn the oil filler neck counter-clockwise.

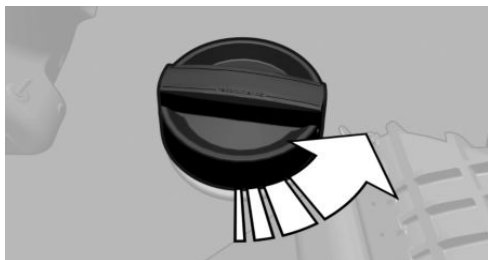

3. Add engine oil.

## Engine oil types to add

### General information

The engine oil quality is critical for the life of the engine.

### Safety information



#### NOTE

Oil additives can damage the engine. There is a risk of property damage. Do not use oil additives. ◀



#### NOTE

Incorrect engine oil can cause malfunctions in the engine or damage it. There is a risk of property damage. When selecting an engine oil, make sure that the engine oil has the correct oil rating. ◀

### Suitable engine oil types

You can add engine oils that meet the following oil rating standards:

#### Gasoline engine

BMW Longlife-01 FE.

More information about suitable engine oil ratings and viscosities of engine oils is available

at a dealer's service center or another qualified service center or repair shop.

### Alternative engine oil types

If an engine oil suitable for continuous use is not available, up to 1 US quart/liter of an engine oil with the following oil rating can be added:

#### Gasoline engine

BMW Longlife-01.

API SL or superior oil rating.

### Viscosity grades

More information about suitable engine oil ratings and viscosities of engine oils can be requested from a dealer's service center or another qualified service center or repair shop.

## Engine oil change



#### NOTE

Engine oil that is not changed in timely fashion can cause increased engine wear and thus engine damage. There is a risk of property damage. Do not exceed the service data indicated in the vehicle. ◀

The vehicle manufacturer recommends that you have a dealer's service center or another qualified service center or repair shop change the engine oil.

**BMW recommends  
Original BMW Engine Oil.**

# Coolant

## Vehicle features and options

This chapter describes all standard, country-specific and optional features offered with the series. It also describes features that are not necessarily available in your vehicle, e. g., due to the selected options or country versions. This also applies to safety-related functions and systems. When using these functions and systems, the applicable country provisions must be observed.

## General information

Not all commercially available additives are suitable for the vehicle. Information about suitable additives is available from a dealer's service center or another qualified service center or repair shop.

## Safety information

### WARNING

With the engine hot and the cooling system open, coolant can escape and lead to scalding. There is a risk of injury. Only open the cooling system with the engine cooled down. ◀

### WARNING

Additives are harmful and incorrect additives can damage the engine. There is a risk of injury and risk of property damage. Do not allow additives to come into contact with skin, eyes or articles of clothing. Use suitable additives only. ◀

## Coolant level

### Checking

1. Let the engine cool.
2. Turn the lid of the coolant reservoir slightly counterclockwise to allow any excess pressure to dissipate, then open it.

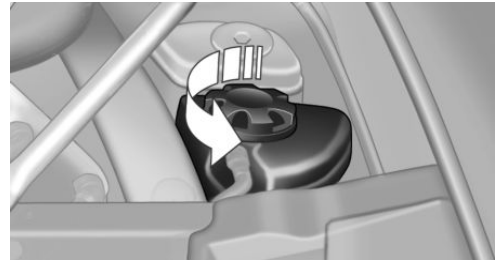

3. Open the coolant reservoir lid.
4. The coolant level is correct if it lies between the minimum and maximum marks in the filler neck.



## Adding

1. Let the engine cool.
2. Turn the lid of the coolant reservoir slightly counterclockwise to allow any excess pressure to dissipate, then open it.

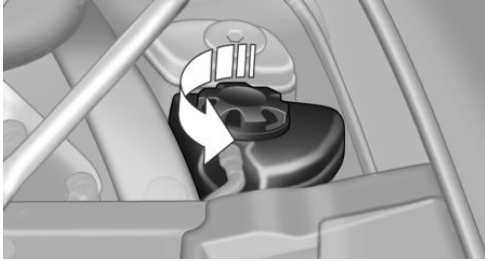

3. If the coolant is low, slowly add coolant up to the specified level; do not overfill.
4. Turn the lid until there is an audible click. The arrows on the coolant reservoir and the lid must point towards one another.
5. Have the cause of the coolant loss eliminated as soon as possible.

## Disposal



Comply with the relevant environmental protection regulations when disposing of coolant and coolant additives.

# Maintenance

## Vehicle features and options

This chapter describes all standard, country-specific and optional features offered with the series. It also describes features that are not necessarily available in your vehicle, e. g., due to the selected options or country versions. This also applies to safety-related functions and systems. When using these functions and systems, the applicable country provisions must be observed.

## BMW maintenance system

The maintenance system indicates required maintenance measures, and thereby provides support in maintaining road safety and the operational reliability of the vehicle.

In some cases, scopes and intervals may vary according to the country-specific version. Replacement work, spare parts, fuels and lubricants, and wear materials are calculated separately. Further information is available from a dealer's service center or another qualified service center or repair shop.

## Condition Based Service CBS

Sensors and special algorithms take into account the driving conditions of the vehicle. Based on this, Condition Based Service recognizes the maintenance requirements.

The system makes it possible to adapt the amount of maintenance corresponding to your user profile.

Information on service requirements can be displayed on the Control Display.

## Service data in the remote control

Information on the required maintenance is continuously stored in the remote control. The dealer's service center can read this data out and suggest a maintenance scope for the vehicle.

Therefore, hand the service advisor the remote control with which the vehicle was driven most recently.

## Storage periods

Storage periods during which the vehicle battery was disconnected are not taken into account.

If this occurs, have a dealer's service center or another qualified service center or repair shop update the time-dependent maintenance procedures, such as checking brake fluid and, if necessary, changing the engine oil and the microfilter/activated-charcoal filter.

## Service and Warranty Information Booklet for US models and Warranty and Service Guide Booklet for Canadian models

Please consult your Service and Warranty Information Booklet for US models and Warranty and Service Guide Booklet for Canadian models for additional information on service requirements.

The manufacturer of your vehicle recommends that maintenance and repair be performed by a dealer's service center or another qualified service center or repair shop. Records of regular maintenance and repair work should be retained.

## Socket for OBD Onboard Diagnosis

### Safety information



#### NOTE

The socket for Onboard Diagnosis is an intricate component intended to be used in conjunction with specialized equipment to check the vehicle's primary emissions system. Improper use of the socket for Onboard Diagnosis, or contact with the socket for Onboard Diagnosis for other than its intended purpose, can cause vehicle malfunctions and creates risks of personal and property damage. Given the foregoing, the manufacture of your vehicle strongly recommends that access to the socket for Onboard Diagnosis be limited to a dealer's service center or another qualified service center or repair shop or other persons that have the specialized training and equipment for purposes of properly utilizing the socket for Onboard Diagnosis. ◀

- ▷ The warning lamp flashes under certain circumstances:

This indicates that there is excessive misfiring in the engine.

Reduce the vehicle speed and have the system checked immediately; otherwise, serious engine misfiring within a brief period can seriously damage emission control components, in particular the catalytic converter.

### Position

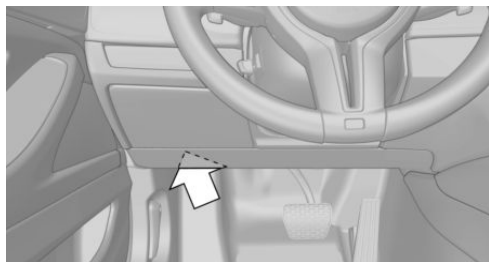

There is an OBD socket on the driver's side for checking the primary components in the vehicle's emissions.

### Emissions



- ▷ The warning lamp lights up:  
Emissions are deteriorating. Have the vehicle checked as soon as possible.

# Replacing components

## Vehicle features and options

This chapter describes all standard, country-specific and optional features offered with the series. It also describes features that are not necessarily available in your vehicle, e. g., due to the selected options or country versions. This also applies to safety-related functions and systems. When using these functions and systems, the applicable country provisions must be observed.

## Onboard vehicle tool kit

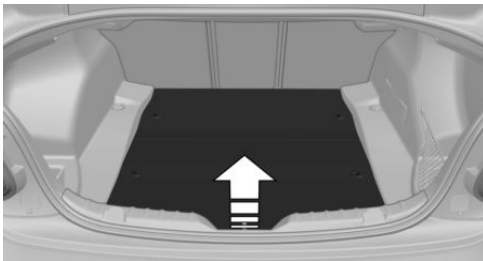

The onboard vehicle tool kit is located under the cargo floor panel.

## Wiper blade replacement

### Safety information



#### NOTE

If the wiper arm falls onto the windshield without the wiper blades installed, the windshield can be damaged. There is a risk of property damage. Secure the wiper arm when replacing the wiper blades and do not fold down the wipers without the wiper blades installed. ◀

## Replacing the wiper blades

1. To change the wiper blades, fold up, refer to page 73, the wiper arms.
2. Fold up and hold the wiper arm firmly.
3. Squeeze the retainer spring, arrow 1, and fold up the wiper blade, arrow 2.

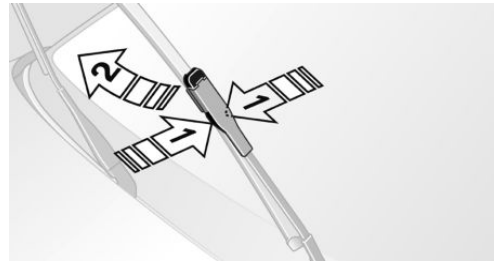

4. Remove the wiper blade forward from the catch.
5. Insert the new wiper blade in reverse order of removal until it locks in place.
6. Fold down the wipers.



#### NOTE

Folded-away wipers can be jammed when the hood is opened. There is a risk of property damage. Make sure that the wipers with the wiper blades mounted are folded down onto the windshield before opening the hood. ◀

## Lamp and bulb replacement

### General information

#### Lights and bulbs

Lights and bulbs make an essential contribution to vehicle safety.

The vehicle manufacturer recommends that you have the relevant work carried out a deal-

er's service center or another qualified service center or repair shop.

A spare lamp box is available from a dealer's service center or another qualified service center or repair shop.

Observe the safety information, refer to page 190.

### Light-emitting diodes (LEDs)

Some items of equipment use light-emitting diodes installed behind a cover as a light source. These light-emitting diodes, which are related to conventional lasers, are officially designated as Class 1 light-emitting diodes.

Observe the safety information, refer to page 190.

### Headlight glass

Condensation can form on the inside of the external lights in cool or humid weather. When driving with the lights switched on, the condensation evaporates after a short time. The headlight glass does not need to be changed.

If despite driving with the lights switched on, increasing humidity forms, e.g., water droplets in the lamp, the manufacturer of your vehicle recommends having it checked by a dealer's service center or another qualified service center or repair shop.

### Headlight setting

The headlight adjustments can be affected by changing lights and bulbs. After the headlight adjustment was changed, have it checked and, if necessary, corrected by a dealer's service center or another qualified service center or repair shop.

## Safety information

### Lights and bulbs



#### WARNING

Bulbs can get hot during operation. Contact with the bulbs can cause burns. There is a risk of injury. Only change bulbs after they have cooled off. ◀



#### WARNING

Work on switched-on lighting systems can cause short circuits. There is a risk of injury or risk of property damage. When working on the lighting system, switch off the lamps in question. If necessary, heed the bulb manufacturer's instructions. ◀



#### NOTE

Dirty bulbs have a reduced service life. There is a risk of property damage. Do not hold new bulbs with your bare hands. Use a clean cloth or something similar, or hold the bulb by its base. ◀

### Xenon headlights



#### DANGER

There can be high voltage in the lighting system. There is danger to life. The manufacturer of your vehicle recommends that the work on the lighting system including bulb replacement be performed by a dealer's service center or another qualified service center or repair shop. ◀

### Light-emitting diodes (LEDs)



#### WARNING

Too intensive brightness can irritate or damage the retina of the eye. There is a risk of injury. Do not look directly into the headlights or other light sources. Do not remove the LED covers. ◀

## Front lights, bulb replacement

### Xenon headlights

#### Safety information



#### DANGER

There can be high voltage in the lighting system. There is danger to life. The manufacturer of your vehicle recommends that the work on the lighting system including bulb replacement be performed by a dealer's service center or another qualified service center or repair shop. ◀

#### Overview

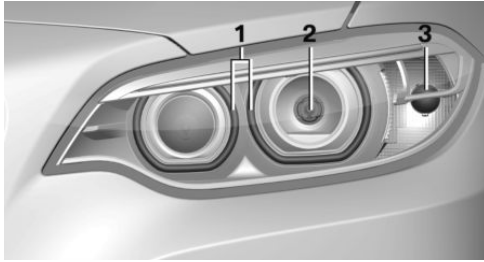

- 1 Parking lights / daytime running lights
- 2 Low beams/high beams/headlight flasher
- 3 Turn signal

### Xenon headlights

Low beams and high beams are designed with xenon technology.

The parking lights and daylight running lights are made using LED technology.

In the case of a malfunction, contact a dealer's service center or another qualified service center or repair shop.

### Turn signal

Observe the safety information, refer to page 190.

21-watt bulb, PY21W

1. In the wheel house, loosen the two brackets and remove the cover.

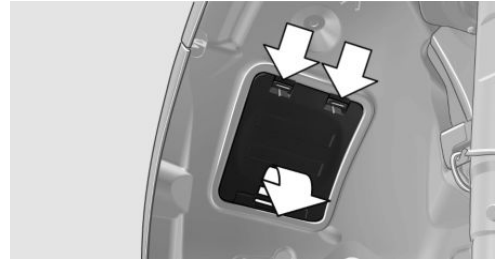

2. If necessary, pull the inside trim of the wheel house slightly inward. Turn the bulb socket counterclockwise and remove.



3. Press the bulb gently into the socket, turn counterclockwise and remove.
4. Install the new bulb and bulb holder in reverse order of removal.
5. Attach the cover to the wheel house.

### Turn signal in exterior mirror

The turn signals in the exterior mirrors feature LED technology. In the case of a malfunction, contact a dealer's service center or another qualified service center or repair shop.

## Tail lamps, bulb replacement

### Overview

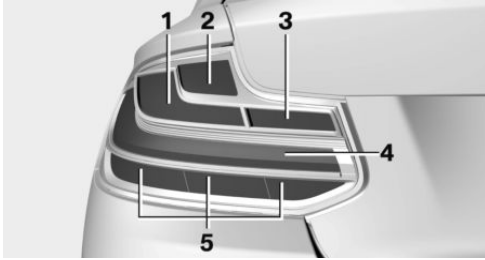

- 1 Turn signal
- 2 Top brake lamp
- 3 Reversing lamp
- 4 Rear lamp
- 5 Bottom brake lights

### Bulb replacement

Observe the safety information, refer to page 190.

Turn signal, brake, tail, rear or reversing lamp:  
21-watt bulb, P21W

Rear fog lamp: 6-watt bulb, H6W.

### Removing the tail lamp

1. Open tailgate.
2. Open the two covers on the tail lamp.

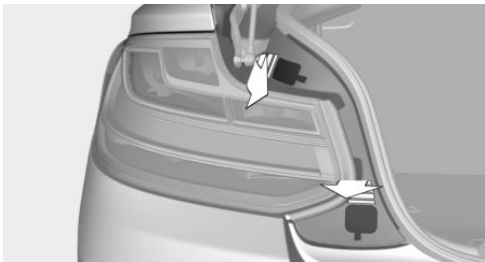

3. With the handle of the screwdriver from the onboard vehicle tool kit, loosen and remove the nuts on the two fasteners. Make sure that the nuts do not drop into the

bumper area. In addition to the two outer fasteners, there is another inner fastener.

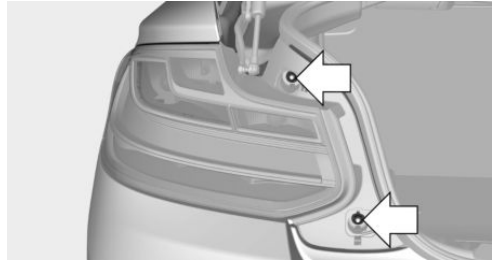

4. Hold the grip rail in one hand, arrow 1, and brace against the outside with your other hand, arrow 2. Carefully pry out the tail lamp, arrow 3, until the rubber mount releases from the inner fastener.

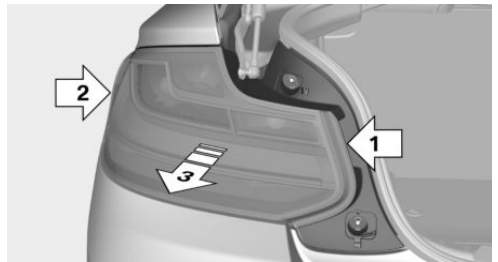

5. Remove the plug from the bulb holder.

### Replacing the bulbs

1. Loosen the six fasteners on the tail lamp, arrows 1, and remove the tail lamp from the lamp holder, arrow 2.

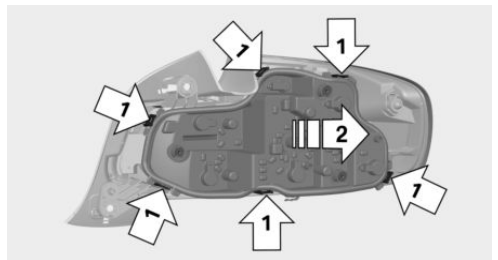

2. Press the nonworking bulb gently into the socket, turn counterclockwise and remove.

- Proceed in the reverse order to insert the new bulb and attach the bulb holder to the tail lamp. Make sure that the bulb holder engages in all fasteners.

### Installing the tail lamp

- Connect the plug to the bulb holder.
- Insert the tail lamp straight in and press it in, arrow 1, until the rubber mount latches in the inner fastener. Make sure when inserting the tail lamp that the rubber lip, arrow 2, on the top side of the tail lamp does not fold over. Screw on the two nuts, arrow 3, and close covers.

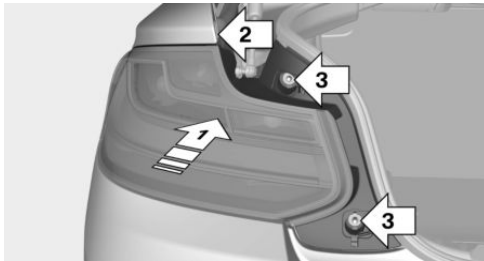

### Central brake lamp and license plate lamp

Observe the safety information, refer to page 190.

These lights are made using LED technology. In the case of a malfunction, contact a dealer's service center or another qualified service center or repair shop.

## Vehicle battery

### Maintenance

The battery is maintenance-free.

The added amount of acid is sufficient for the service life of the battery.

More information about the battery can be requested from a dealer's service center or another qualified service center or repair shop.

### Battery replacement



#### NOTE

Vehicle batteries that are not compatible can damage vehicle systems and impair vehicle functions. There is a risk of personal and property damage. Only vehicle batteries that are compatible with your vehicle type should be installed in your vehicle. Information on compatible vehicle batteries is available at your dealer's service center. ◀

After a battery replacement, the manufacturer of your vehicle recommends that the vehicle battery be registered on the vehicle by a dealer's service center or another qualified service center or repair shop to ensure that all comfort features are fully available and that any Check Control messages of these comfort features are no longer displayed.

### Charging the battery

#### General information

Make sure that the battery is always sufficiently charged to guarantee that the battery remains usable for its full service life.



A discharged battery is indicated by a red indicator lamp.

The battery may need to be charged in the following cases:

- ▶ When making frequent short-distance drives.
- ▶ If the vehicle is not used for more than a month.

### Safety information



#### NOTE

Battery chargers for the vehicle battery can work with high voltages and currents, which means that the 12 volt on-board network can be overloaded or damaged. There is a risk of property damage. Only connect battery chargers for the vehicle battery to the

starting aid terminals in the engine compartment. ◀

### Starting aid terminals

In the vehicle, only charge the battery via the starting aid terminals, refer to page 198, in the engine compartment with the engine off.

### Power failure

After a power loss, some equipment needs to be newly initialized or individual settings updated, for example:

- ▷ Seat and mirror memory: store the positions again.
- ▷ Time: update.
- ▷ Date: update.
- ▷ Glass sunroof and sliding visor: initialize the system.

### Disposing of old batteries



Have old batteries disposed of by a dealer's service center or another qualified service center or repair shop or take them to a collection point.

Maintain the battery in an upright position for transport and storage. Secure the battery so that it does not tip over during transport.

## Fuses

### General information

Plastic tweezers and information on the fuse types and locations are stored in the fuse box in the cargo area.

### Safety information



#### WARNING

Incorrect and repaired fuses can overload electrical lines and components. There is a risk of fire. Never attempt to repair a blown fuse.

Do not replace a nonworking fuse with a substitute of another color or amperage rating. ◀

### In the engine compartment

1. Use the onboard vehicle tool kit to loosen the three cover screws, arrow 1.

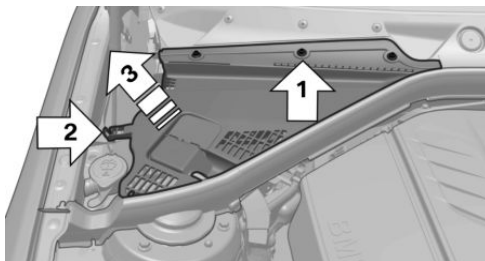

2. Squeeze and raise the holder, arrow 2.
3. Remove the cover from one side, arrow 3.
4. Press the four fasteners and remove the cover.

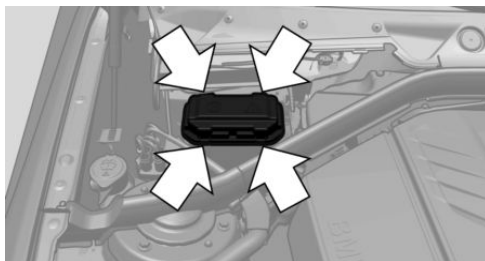

### Attaching the covers

1. When attaching the cover, make sure that all four fasteners are engaged.
2. Attach the cover under the rubber lip and then thread it between the bars.

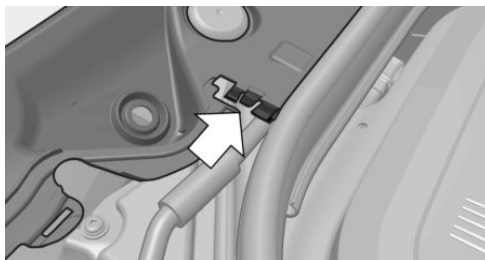

3. Press down on the holder and tighten the three screws.

### In the cargo area

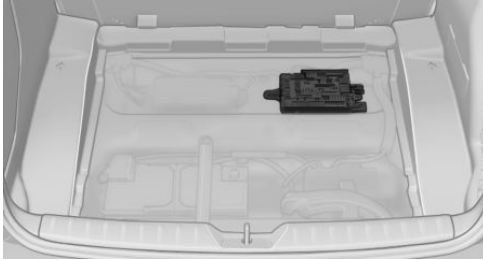

Fold up the cargo floor panel.

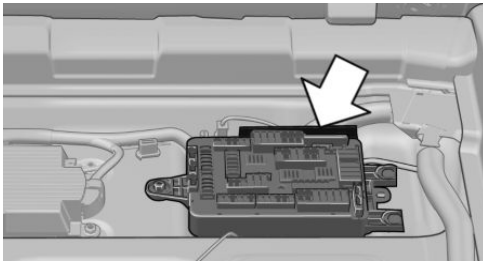

Information on the fuse types and locations is found on a separate sheet.

# Breakdown assistance

## Vehicle features and options

This chapter describes all standard, country-specific and optional features offered with the series. It also describes features that are not necessarily available in your vehicle, e. g., due to the selected options or country versions. This also applies to safety-related functions and systems. When using these functions and systems, the applicable country provisions must be observed.

## Hazard warning flashers

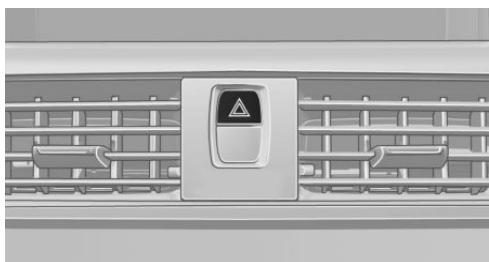

The button is located in the center console. The red lamp in the button flashes with the hazard warning flashers switched on.

## Intelligent emergency call

### Concept

In case of an emergency, an Emergency Request can be made through the system.

### General information

Only press the SOS button in an emergency.

For technical reasons, the Emergency Request cannot be guaranteed under unfavorable conditions.

## Overview



SOS button in the roofliner

## Requirements

- ▶ The SIM card integrated in the vehicle has been activated.
- ▶ The radio-ready state is switched on.
- ▶ The Assist system is functional.

## Initiating an Emergency Request

1. Press the cover briefly to open it.
  2. Press the SOS button until the LED at the button lights up green.
- ▶ The LED illuminates green when the Emergency Request has been initiated. If a cancel prompt appears on the Control Display, the Emergency Request can be aborted. If the situation allows, wait in your vehicle until the voice connection has been established.
  - ▶ The LED flashes green when a connection to the BMW Response Center has been established.

When the Emergency Request is received at the BMW Response Center, the BMW Response Center contacts you and takes further steps to help you.

Even if you are unable to respond, the BMW Response Center can take further steps to help you under certain circumstances.

For this, data is transmitted to the BMW Response Center which serves to determine the necessary rescue measures. E.g., the current position of the vehicle, if it can be established.

- ▶ If the LED is flashing green, but the BMW Response Center can no longer be heard via the speaker, you can nevertheless still be heard at the BMW Response Center.

## Initiating an Emergency Request automatically

Under certain conditions, an Emergency Request is automatically initiated immediately after a severe accident. Automatic Collision Notification is not affected by pressing the SOS button.

## Roadside Assistance

### Service availability

Roadside Assistance can be reached around the clock in many countries. You can obtain assistance there in the event of a vehicle breakdown.

### Roadside Assistance

The Roadside Assistance phone number can be viewed via iDrive or a connection to Roadside Assistance can be established directly.

## Warning triangle

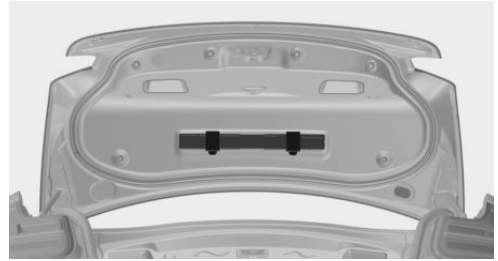

The warning triangle is located on the inside of the tailgate.

To remove, loosen the bracket.

## First-aid kit

### General information

Some of the articles have a limited service life. Check the expiration dates of the contents regularly and replace any expired items promptly.

### Storage



The first-aid kit is located in the cargo area in the storage compartment.

## Jump-starting

### General information

If the battery is discharged, the engine can be started using the battery of another vehicle

and two jumper cables. Only use jumper cables with fully insulated clamp handles.

## Safety information



### DANGER

Contact with live components can lead to an electric shock. There is a risk of injuries or danger to life. Do not touch any components that are under voltage. ◀

To prevent personal injury or damage to both vehicles, adhere strictly to the following procedure.

## Preparation



### NOTE

In the case of body contact between the two vehicles, a short circuit can occur during jump-starting. There is a risk of property damage. Make sure that no body contact occurs. ◀

1. Check whether the battery of the other vehicle has a voltage of 12 volts. The voltage information can be found on the battery.
2. Switch off the engine of the assisting vehicle.
3. Switch off any electronic systems/power consumers in both vehicles.

## Starting aid terminals



### WARNING

If the jumper cables are connected in the incorrect order, sparking may occur. There is a risk of injury. Pay attention to the correct order during connection. ◀

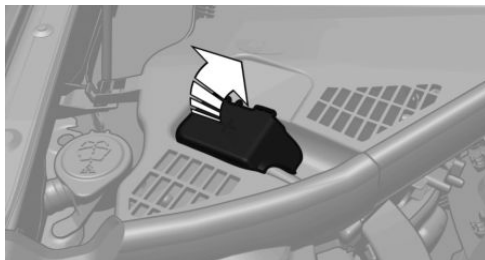

The starting aid terminal in the engine compartment acts as the battery's positive terminal.

Open the cover of the starting aid terminal.

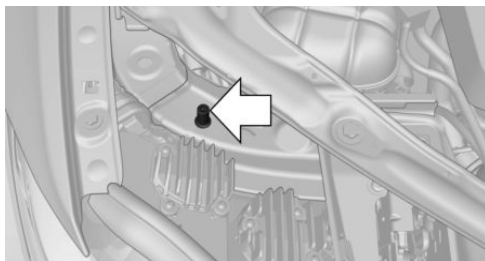

The body ground or a special nut acts as the battery negative terminal.

## Connecting the cables

1. Pull off the lid of the BMW starting aid terminal.
2. Attach one terminal clamp of the positive jumper cable to the positive terminal of the battery, or to the corresponding starting aid terminal of the vehicle providing assistance.
3. Attach the terminal clamp on the other end of the cable to the positive terminal of the battery, or to the corresponding starting aid terminal of the vehicle to be started.
4. Attach one terminal clamp of the negative jumper cable to the negative terminal of the battery, or to the corresponding engine or body ground of assisting vehicle.
5. Attach the second terminal clamp to the negative terminal of the battery, or to the

corresponding engine or body ground of the vehicle to be started.

## Starting the engine

Never use spray fluids to start the engine.

1. Start the engine of the assisting vehicle and let it run for several minutes at an increased idle speed.
2. Start the engine of the vehicle that is to be started in the usual way.

If the first starting attempt is not successful, wait a few minutes before making another attempt in order to allow the discharged battery to recharge.

3. Let both engines run for several minutes.
4. Disconnect the jumper cables in the reverse order.

Check the battery and recharge, if needed.

## Tow-starting and towing

### Safety information



#### WARNING

Due to system limits, individual functions can malfunction during tow-starting/towing with the Intelligent Safety systems activated, e.g., approach control warning with light braking function. There is a risk of an accident. Switch all Intelligent Safety systems off prior to tow-starting/towing. ◀

### Manual transmission

Gearshift lever in neutral position.

### Towing

Information the following instructions:

- ▷ Make sure that the ignition is switched on; otherwise, the low beams, tail lamps, turn signals, and wipers may be unavailable.
- ▷ Do not tow the vehicle with the rear axle tilted, as the front wheels could turn.

- ▷ When the engine is stopped, there is no power assist. Consequently, more force needs to be applied when braking and steering.
- ▷ Larger steering wheel movements are required.
- ▷ The towing vehicle must not be lighter than the vehicle being towed; otherwise, it will not be possible to control the vehicle's response.
- ▷ Do not exceed a towing speed of 30 mph/50 km/h.
- ▷ Do not exceed a towing distance of 30 miles/50 km.

### Tow truck

#### With rear-wheel drive

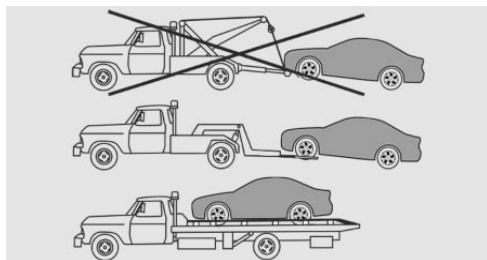

Your vehicle should be transported with a tow truck with a so-called lift bar or on a flat bed.



#### NOTE

When lifting the vehicle by the tow fitting or body and chassis parts; damage can occur on vehicle parts. There is a risk of property damage. Lift vehicle using suitable means. ◀

### M double-clutch transmission: transporting the vehicle

#### General information

The vehicle is not permitted to be towed.

## Safety information

### NOTE

The vehicle can be damaged when towing the vehicle with a single lifted axle. There is a risk of property damage. The vehicle should only be transported on a loading platform. ◀

## Tow truck

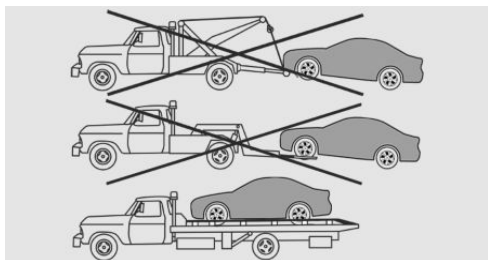

The vehicle should only be transported on a loading platform.

### NOTE

When lifting the vehicle by the tow fitting or body and chassis parts; damage can occur on vehicle parts. There is a risk of property damage. Lift vehicle using suitable means. ◀

Use tow fitting located in the front only for positioning the vehicle.

## Towing other vehicles

### General information

Switch on the hazard warning system, depending on local regulations.

If the electrical system has failed, clearly identify the vehicle being towed by placing a sign or a warning triangle in the rear window.

## Safety information

### WARNING

If the approved gross vehicle weight of the towing vehicle is lighter than the vehicle to be towed, the tow fitting can tear off or it will not be possible to control the vehicle's re-

sponse. There is a risk of an accident! Make sure that the gross vehicle weight of the towing vehicle is heavier than the vehicle to be towed. ◀

### NOTE

If the tow bar or tow rope is attached incorrectly, damage to other vehicle parts can occur. There is a risk of property damage. Correctly attach the tow bar or tow rope to the tow fitting. ◀

## Tow bar

The tow fittings used should be on the same side on both vehicles.

Should it prove impossible to avoid mounting the tow bar at an offset angle, please observe the following:

- ▶ Maneuvering capability is limited going around corners.
- ▶ The tow bar will generate lateral forces if it is secured with an offset.

## Tow rope

When starting to tow the vehicle, make sure that the tow rope is taut.

To avoid jerking and the associated stresses on the vehicle components when towing, always use nylon ropes or nylon straps.

## Tow fitting

### General information

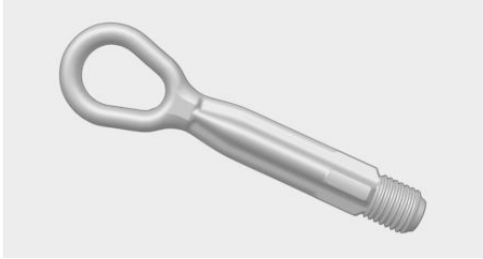

The screw-in tow fitting should always be carried in the vehicle.

The tow fitting can be screwed in at the front or rear of the vehicle.

The tow fitting and the onboard vehicle tool kit, refer to page 189, are together in the cargo area.

Use of the tow fitting:

- ▶ Use only the tow fitting provided with the vehicle and screw it all the way in.
- ▶ Use the tow fitting for towing on paved roads only.
- ▶ Use tow fitting located in the front only for positioning the vehicle.
- ▶ Avoid lateral loading of the tow fitting, e.g., do not lift the vehicle by the tow fitting.

### Safety information



#### NOTE

If the tow fitting is not used as intended, there can be damage to the vehicle or to the tow fitting. There is a risk of property damage. Observe the notes on using the tow fitting. ◀

## Screw thread for tow fitting



Press on the mark of the front cover to push it out.

Press out the rear cover at the recess using the screw driver from the onboard vehicle tool kit.

## Tow-starting

### M double-clutch transmission

Do not tow-start the vehicle.

Tow-starting the engine is not possible due to the M double-clutch transmission.

Have the cause of the starting problems fixed.

### Manual transmission

If possible, do not tow-start the vehicle but start the engine by jump-starting, refer to page 197. If the vehicle is equipped with a catalytic converter, only tow-start while the engine is cold.

1. Switch on the hazard warning system and comply with local regulations.
2. Switch on the ignition, refer to page 65.
3. Engage third gear.
4. Have the vehicle tow-started with the clutch pedal pressed and slowly release the pedal. After the engine starts, immediately press on the clutch pedal again.
5. Stop at a suitable location, remove the tow bar or rope, and switch off the hazard warning system.
6. Have the vehicle checked.

# Care

## Vehicle features and options

This chapter describes all standard, country-specific and optional features offered with the series. It also describes features that are not necessarily available in your vehicle, e. g., due to the selected options or country versions. This also applies to safety-related functions and systems. When using these functions and systems, the applicable country provisions must be observed.

## Vehicle washes

### General information

Regularly remove foreign objects such as leaves in the area below the windshield when the hood is raised.

Wash your vehicle frequently, particularly in winter. Intense soiling and road salt can damage the vehicle.

### Steam blaster and high-pressure washer

#### Safety information



#### NOTE

When cleaning with high-pressure washers, components can be damaged due to the pressure or temperatures being too high. There is a risk of property damage. Maintain sufficient distance and do not spray too long continuously. Follow the operating instructions for the high-pressure washer. ◀

#### Distances and temperature

- ▷ Maximum temperature: 140 °F/60 °C.
- ▷ Minimum distance from sensors, cameras, seals: 12 inches/30 cm.

- ▷ Minimum distance from glass sunroof: 31.5 in/80 cm.

## Automatic vehicle washes

### Safety information



#### NOTE

Water can penetrate in the windshield area due to high-pressure washers. There is a risk of property damage. Avoid high-pressure washers. ◀



#### NOTE

Improper use of automatic vehicle washes can cause damage to the vehicle. There is a risk of property damage. Information the following instructions:

- ▷ Give preference to cloth vehicle washes or those that use soft brushes in order to avoid paint damage.
- ▷ Avoid vehicle washes with guide rails higher than 4 in/10 cm to avoid damage to the chassis.
- ▷ Observe the tire width of the guide rail to avoid damage to tires and rims.
- ▷ Fold in exterior mirrors to avoid damage to the exterior mirrors.
- ▷ Deactivate rain sensor, if necessary, to avoid damage to the wiper system. ◀

### Before driving into a vehicle wash

In order to ensure that the vehicle can roll in a vehicle wash, take the following steps:

Manual transmission:

1. Drive into the vehicle wash.
2. Shift to neutral.
3. Switch the engine off.

M double-clutch transmission:

1. Drive into the vehicle wash.
2. Engage selector lever position N.
3. Switch the engine off.

In this way, the ignition remains switched on, and a Check-Control message is displayed.



#### NOTE

Selector lever position P is automatically engaged when the ignition is switched off. There is a risk of property damage. Do not switch drive-ready state off in vehicle washes. ◀

Some vehicle washes do not permit persons in the vehicle. The vehicle cannot be locked from the outside when in selector lever position N. A signal sounds when an attempt is made to lock the vehicle.

## Exiting a vehicle wash

To start the engine with manual transmission:

1. Make sure that the vehicle key is in the vehicle.
2. Press on the clutch pedal.
3. Press the Start/Stop button.

To start the engine with a M double clutch transmission:

1. Make sure that the vehicle key is in the vehicle.
2. Depress the brake pedal.
3. Press the Start/Stop button.

Pressing the Start/Stop button without stepping on the brake turns the ignition off.

## Transmission position

Transmission position P is engaged automatically:

- ▶ When the ignition is switched off.
- ▶ After approx. 15 minutes.

## Headlamps

- ▶ Do not rub dry and do not use abrasive or acidic cleansers.
- ▶ Soak areas that have been dirtied, e.g., from insects, with shampoo and wash off with water.
- ▶ Thaw ice with de-icing spray; do not use an ice scraper.

## After washing the vehicle

After washing the vehicle, apply the brakes briefly to dry them; otherwise, braking action can be reduced. The heat generated during braking dries brake discs and brake pads and protects them against corrosion.

Completely remove all residues on the windows, to minimize loss of visibility due to smearing and to reduce wiper noises and wiper blade wear.

## Vehicle care

### Vehicle care products

#### General information

BMW recommends using vehicle care and cleaning products from BMW.

#### Safety information



#### WARNING

Cleansers can contain substances that are dangerous and harmful to your health. There is a risk of injury. When cleaning the interior, open the doors or windows. Only use products intended for cleaning vehicles. Follow the instructions on the container. ◀

### Vehicle paint

Regular care contributes to driving safety and value retention. Environmental influences in areas with elevated air pollution or natural contaminants, such as tree resin or pollen can af-

fect the vehicle's paintwork. Tailor the frequency and extent of your vehicle care to these influences.

Aggressive substances such as spilled fuel, oil, grease or bird droppings, must be removed immediately to prevent the finish from being altered or discolored.

### Leather care

Remove dust from the leather often, using a cloth or vacuum cleaner.

Otherwise, particles of dust and road grime chafe in pores and folds, and lead to increased wear and premature degradation of the leather surface.

To guard against discoloration, such as from clothing, clean leather and provide leather care roughly every two months.

Clean light-colored leather more frequently because soiling on such surfaces is substantially more visible.

Use leather care products; otherwise, dirt and grease will gradually break down the protective layer of the leather surface.

Suitable care products are available from a dealer's service center or another qualified service center or repair shop.

### Upholstery material care

#### General information

Vacuum regularly with a vacuum cleaner.

If upholstery is very dirty, e.g., with beverage stains, use a soft sponge or microfiber cloth with a suitable interior cleaner.

Clean the upholstery down to the seams using large sweeping motions. Avoid rubbing the material vigorously.

### Safety information



#### NOTE

Open Velcro® fasteners on articles of clothing can damage the seat covers. There is a risk of property damage. Ensure that any Velcro® fasteners are closed. ◀

### Caring for special components

#### Light-alloy wheels

When cleaning the vehicle, use only neutral wheel cleaners having a pH value from 5 to 9. Do not use abrasive cleaning agents or steam jets above 140 °F/60 °C. Follow the manufacturer's instructions.

Aggressive, acidic or alkaline cleaning agents can destroy the protective layer of adjacent components, such as the brake disk.

After cleaning, apply the brakes briefly to dry them. The heat generated during braking dries brake discs and brake pads and protects them against corrosion.

#### Chrome surfaces

Carefully clean components such as the radiator grille or door handles with an ample supply of water, possibly with shampoo added, particularly when they have been exposed to road salt.

#### Rubber components

Environmental influences can cause surface soiling of rubber parts and a loss of gloss. Use only water and suitable cleaning agents for cleaning. The manufacturer of your vehicle recommends original BMW care products.

Treat especially worn rubber parts with rubber care agents at regular intervals. When cleaning rubber seals, do not use any silicon-containing vehicle care products in order to avoid damage or noises.

## Fine wood parts

Clean fine wood facing and fine wood components only with a moist rag. Then dry with a soft cloth.

## Plastic components



### NOTE

Cleansers that contain alcohol or solvents, such as lacquer thinners, heavy-duty grease removers, fuel, or such, can damage plastic parts. There is a risk of property damage. Clean with a microfiber cloth. Dampen cloth lightly with water. ◀

Plastic components are e.g.:

- ▷ Imitation leather surfaces.
- ▷ Roofliner.
- ▷ Lamp lenses.
- ▷ Instrument cluster cover.
- ▷ Matt black spray-coated components.
- ▷ Painted parts in the interior.

Clean with a microfiber cloth.

Dampen cloth lightly with water.

Do not soak the roofliner.

## Safety belts



### WARNING

Chemical cleansers can destroy the safety belt webbing. Missing protective effect of the safety belts. There is a risk of injuries or danger to life. Use only a mild soapy solution for cleaning the safety belts. ◀

Dirty belt straps impede the reeling action and thus have a negative impact on safety.

Use only a mild soapy solution, with the safety belts clipped into their buckles.

Do not allow the switches to retract the safety belts until they are dry.

## Carpets and floor mats



### WARNING

Objects in the driver's floor area can limit the pedal distance or block a depressed pedal. There is a risk of an accident. Stow objects in the vehicle such that they are secured and cannot enter into the driver's floor area. Use floor mats that are suitable for the vehicle and can be safely attached to the floor. Do not use loose floor mats and do not layer several floor mats. Make sure that there is sufficient clearance for the pedals. Ensure that the floor mats are securely fastened again after they were removed, e.g., for cleaning. ◀

Floor mats can be removed from the vehicle's interior for cleaning.

If the floor carpets are very dirty, clean with a microfiber cloth and water or a textile cleaner. To prevent matting of the carpet, rub back and forth in the direction of travel only.

## Sensor/camera lenses

To clean sensors and camera lenses, use a cloth moistened with a small amount of glass detergent.

## Displays/screens



### NOTE

Chemical cleansers, moisture or fluids of any kind can damage the surface of displays and screens. There is a risk of property damage. Clean with a clean, antistatic microfiber cloth. ◀



### NOTE

The surface of displays can be damaged with improper cleaning. There is a risk of property damage. Avoid pressure that is too high and do not use any scratching materials. ◀

Clean with a clean, antistatic microfiber cloth.

### Long-term vehicle storage

When the vehicle is shut down for longer than three months, special measures must be taken. Further information is available from a dealer's service center or another qualified service center or repair shop.





## Reference

This chapter contains the technical data and an index that will quickly take you to the information you need.

# Technical data

## Vehicle features and options

This chapter describes all standard, country-specific and optional features offered with the series. It also describes features that are not necessarily available in your vehicle, e. g., due

to the selected options or country versions. This also applies to safety-related functions and systems. When using these functions and systems, the applicable country provisions must be observed.

## General information

The technical data and specifications in this Owner's Manual are used as guidance values. The vehicle-specific data can deviate from this, e.g., due to the selected special equipment, country version or country-specific measurement method. Detailed values can be found in the approval documents, on labels on the vehi-

cle or can be obtained from a dealer's service center or another qualified service center or repair shop.

The information in the vehicle documents always has priority over the information in this Owner's Manual.

## Dimensions

The dimensions can vary depending on the model version, equipment or country-specific measurement method.

The specified heights do not take into account attached parts, e.g., a roof antenna, roof racks

or spoiler. The heights can deviate, e.g., due to the selected special equipment, tires, load and chassis version.

### BMW M2 Coupe

Width with mirrors	inches/mm	78.1/1,984
Width without mirrors	inches/mm	73/1,854
Height	inches/mm	55.5/1,410
Length	inches/mm	176.2/4,476
Wheelbase	inches/mm	106/2,693
Smallest turning radius diam.	ft/m	38.4/11.7

## Weights

M2		
Approved gross vehicle weight		
Manual transmission	lbs/kg	4,430/2,009
M double-clutch transmission	lbs/kg	4,430/2,009
Load	lbs/kg	840/381
Approved front axle load	lbs/kg	2,140/971
Approved rear axle load	lbs/kg	2,380/1,080
Approved roof load capacity	lbs/kg	165/75
Cargo area capacity	cu ft	13.8
Canada: cargo area capacity	cu ft/l	13.7/390

## Capacities

	US gal/liters	Notes
Fuel tank, approx.	13.7/52.0	Fuel quality, refer to page <a href="#">166</a>

# Appendix

Any updates to the Owner's Manual of the vehicle are listed here.



# Everything from A to Z

## Index

### A

ABS, Antilock Brake System 115

Acceleration Assistant, see Launch Control 78

Accessories and parts 8

Activated-charcoal filter 133

Activation times, parked-car ventilation 134

Active M differential 117

Adaptive brake lights, see Brake force display 113

Adaptive Light Control 95

Additives, oil 184

Adjustments, seats/head restraints 49

After washing vehicle 203

Airbags 98

Airbags, indicator/warning light 99

Air circulation, see Recirculated-air mode 129, 132

Air, dehumidifying, see Cooling function 129, 131

Air distribution, manual 130, 132

Air flow, air conditioner 129

Air flow, automatic climate control 132

Air pressure, tires 168

Air vents, see Ventilation 133

Alarm system 44

Alarm, unintentional 45

All around the roofliner 17

All-season tires, see Winter tires 172

Alternative oil types 184

Ambient light 97

Antifreeze, washer fluid 73

Antilock Brake System, ABS 115

Anti-slip control, see DSC 115

App, BMW Driver's Guide 6

Approach control warning with City light braking function 107

Approved axle load 211

Arrival time 89

Ashtray 139

Assistance, Roadside Assistance 197

Assistance when driving off 119

Attentiveness assistant 113

AUTO intensity 132

Automatic climate control 128

Automatic climate control with enhanced features 130

Automatic Curb Monitor 58

Automatic deactivation, Front-seat passenger airbags 100

Automatic headlamp control 94

Automatic locking 43

Automatic recirculated-air control 132

Automatic vehicle wash 202

AUTO program, automatic climate control 131

AUTO program, climate control 129

AUTO program, intensity 132

Auto Start/Stop function 67

Auto washing 202

AUX-IN port, general information 140

Average fuel consumption 89

Average speed 89

Axle loads, weights 211

### B

Backrest curvature, see Lumbar support 51

Backrest, width 51

Band-aids, see First-aid kit 197

Battery replacement, vehicle battery 193

Battery replacement, vehicle remote control 36

Battery, vehicle 193

Being towed, see Tow-starting and towing 199

Belts, safety belts 53

Beverage holder, cup holder 146

BMW Assist 6

BMW Driver's Guide app 6

BMW Homepage 6

BMW Internet page 6

BMW maintenance system 187

BMW M technology 150

Bottle holder, see Cup holder 146

Brake assistant 115

Brake discs, break-in 152

Brake force display 113

Brake lights, adaptive 113

Brake lights, brake force display 113

Brake pads, break-in 152

Braking, information 153

Breakdown assistance 196, 197

Break-in 152

Brightness of Control Display [92](#)  
Bulb replacement [189](#)  
Bulb replacement, front [191](#)  
Bulb replacement, rear [192](#)  
Bulbs and lights [189](#)  
Button, Start/Stop [65](#)  
Bypassing, see Jump-starting [197](#)

## C

California Proposition 65 Warning [8](#)  
Calling up mirror adjustment [44](#)  
Calling up seat adjustment [44](#)  
Camera-based assistance systems, see Intelligent Safety [106](#)  
Camera lenses, care [205](#)  
Camera, rearview camera [125](#)  
Can holder, see Cup holder [146](#)  
Care, displays [205](#)  
Care, vehicle [203](#)  
Care, washing the vehicle [202](#)  
Cargo [156](#)  
Cargo area, enlarging [142](#)  
Cargo area, loading [157](#)  
Cargo area, storage compartments [147](#)  
Cargo, stowing and securing [157](#)  
Carpet, care [205](#)  
Catalytic converter, see Hot exhaust system [153](#)  
CBS Condition Based Service [187](#)  
Center armrest [145](#)  
Center console [16](#)  
Central locking system [38](#)  
Central screen, see Control Display [18](#)  
Changes, technical, see Own Safety [7](#)  
Changing parts [189](#)  
Changing wheels [176](#)  
Changing wheels/tires [171](#)  
Chassis number, see Vehicle identification number [10](#)  
Check Control [80](#)  
Checking the engine oil level electronically [182](#)  
Checking the oil level electronically [182](#)  
Children, seating position [61](#)  
Children, transporting safely [61](#)  
Child restraint fixing system LATCH [63](#)  
Child restraint system [61](#)  
Child restraint systems, mounting [62](#)  
Child seat, mounting [62](#)  
Child seats [61](#)  
Chrome parts, care [204](#)  
Cigarette lighter [139](#)  
Cleaning, displays [205](#)  
Climate control [128](#), [130](#)  
Clothes hooks [147](#)  
Cockpit [14](#)  
Combination switch, see Turn signals [70](#)  
Combination switch, see Wiper system [71](#)  
Comfort Access [38](#)  
COMFORT program, driving dynamics [119](#)  
Compartments in the doors [145](#)  
Compass [137](#)  
Compound brake [150](#)  
Compressor [173](#)  
Condensation on windows [132](#)  
Condensation under the vehicle [154](#)

Condition Based Service CBS [187](#)  
Confirmation signal [43](#)  
ConnectedDrive [6](#)  
ConnectedDrive Services [6](#)  
Container for washer fluid [73](#)  
Control Display [18](#)  
Control Display, settings [91](#)  
Controller [19](#)  
Control systems, driving stability [115](#)  
Convenient opening with the remote control [35](#)  
Coolant [185](#)  
Cooling function [129](#), [131](#)  
Cooling, maximum [131](#)  
Cooling system [185](#)  
Corrosion on brake discs [154](#)  
Cosmetic mirror [139](#)  
Courtesy lamps during unlocking [35](#)  
Courtesy lamps with the vehicle locked [35](#)  
Cruise control [120](#)  
Cruise control without distance control, see cruise control [120](#)  
Cruising range [84](#)  
Cup holder [146](#)  
Current fuel consumption [84](#)

## D

Damage, tires [171](#)  
Data, technical [210](#)  
Date [91](#)  
Date display [84](#)  
Daytime running lights [95](#)  
Defrosting, see defrosting the windows [130](#)  
Defrosting, see Windows, defrosting [132](#)  
Defrosting the windows [130](#)  
Dehumidifying, air [129](#), [131](#)  
Deleting personal data [24](#)  
Deletion of personal data [24](#)

- Destination distance [89](#)
  - Differential lock [117](#)
  - Digital clock [84](#)
  - Digital compass [137](#)
  - Dimensions [210](#)
  - Dimmable exterior mirrors [58](#)
  - Dimmable interior mirror [59](#)
  - Direction indicator, see Turn signals [70](#)
  - Display, electronic, instrument cluster [79](#)
  - Display, engine temperature [89](#)
  - Display lighting, see Instrument lighting [96](#)
  - Displays, care [205](#)
  - Disposal, coolant [186](#)
  - Disposal, vehicle battery [194](#)
  - Distance control, see PDC [122](#)
  - Distance to destination [89](#)
  - Divided screen view, split screen [23](#)
  - Door key, see Remote control [37](#)
  - Double-clutch transmission [75](#)
  - Drivelogic [77](#)
  - Drive mode [76](#)
  - Drive-off assistant [119](#)
  - Drive-off assistant, see DSC [115](#)
  - Driver assistance, see Intelligent Safety [106](#)
  - Driving Assistant, see Intelligent Safety [106](#)
  - Driving Dynamics Control [117](#)
  - Driving instructions, break-in [152](#)
  - Driving mode [117](#)
  - Driving notes, general [153](#)
  - Driving on racetracks [150](#)
  - Driving program, see Drivelogic [77](#)
  - Driving stability control systems [115](#)
  - Driving tips [153](#)
  - DSC Dynamic Stability Control [115](#)
  - Dynamic Stability Control DSC [115](#)
- ## E
- EfficientDynamics [85](#)
  - Electronic displays, instrument cluster [79](#)
  - Electronic oil measurement [182](#)
  - Electronic Stability Program ESP, see DSC [115](#)
  - Emergency release, fuel filler flap [165](#)
  - Emergency Request [196](#)
  - Emergency service, see Roadside Assistance [197](#)
  - Emergency unlocking, tailgate [41](#)
  - Energy Control [84](#)
  - Energy recovery [85](#)
  - Engine, automatic Start/Stop function [67](#)
  - Engine, automatic switch-off [67](#)
  - Engine compartment [180](#)
  - Engine compartment, working in [180](#)
  - Engine coolant [185](#)
  - Engine oil [182](#)
  - Engine oil, adding [183](#)
  - Engine oil additives [184](#)
  - Engine oil change [184](#)
  - Engine oil filler neck [183](#)
  - Engine oil types, alternative [184](#)
  - Engine oil types, suitable [184](#)
  - Engine start, jump-starting [197](#)
  - Engine start, see Starting the engine [66](#)
  - Engine stop [67](#)
  - Engine temperature, display [89](#)
  - Entering a vehicle wash [202](#)
  - Equipment, interior [135](#)
  - Error displays, see Check Control [80](#)
  - ESP Electronic Stability Program, see DSC [115](#)
  - Exchanging wheels/tires [171](#)
  - Exhaust system [153](#)
  - Exiting a vehicle wash [202](#)
  - Exterior mirror, automatic dimming feature [58](#)
  - Exterior mirrors [57](#)
  - External start [197](#)
  - External temperature display [84](#)
  - External temperature warning [84](#)
- ## F
- Failure message, see Check Control [80](#)
  - False alarm, see Unintentional alarm [45](#)
  - Fan, see Air flow [129](#), [132](#)
  - Filler neck for engine oil [183](#)
  - Fine wood, care [205](#)
  - First-aid kit [197](#)
  - Flat tire, changing wheels [176](#)
  - Flat Tire Monitor FTM [105](#)
  - Flat tire, repairing [173](#)
  - Flat tire, Tire Pressure Monitor TPM [101](#)
  - Flat tire, warning lamp [103](#), [105](#)
  - Flooding [153](#)
  - Floor carpet, care [205](#)
  - Floor mats, care [205](#)
  - Fogged up windows [130](#)
  - Fold-away position, wiper [73](#)

Fold down the rear seat backrest, see Though-loading system [142](#)  
Foot brake [153](#)  
Front airbags [98](#)  
Front lights [191](#)  
Front-seat passenger airbags, automatic deactivation [100](#)  
Front-seat passenger airbags, indicator lamp [101](#)  
FTM Flat Tire Monitor [105](#)  
Fuel [166](#)  
Fuel cap [164](#)  
Fuel consumption, see Average fuel consumption [89](#)  
Fuel filler flap [164](#)  
Fuel gauge [83](#)  
Fuel quality [166](#)  
Fuel recommendation [166](#)  
Fuel, tank capacity [211](#)  
Functions and controls in the center console [16](#)  
Functions and controls in the cockpit [14](#)  
Fuse [194](#)

## G

Garage door opener, see Universal Integrated Remote Control [135](#)  
Gasoline [166](#)  
Gear change [77](#)  
Gear shift indicator [86](#)  
General driving notes [153](#)  
Glare shield [139](#)  
Glass sunroof, electric [46](#)  
Glass sunroof, initialize the system [48](#)  
Glove compartment [144](#)  
GPS location, vehicle position [92](#)  
Gross vehicle weight, approved [211](#)  
Ground clearance [154](#)

## H

Handbrake, see parking brake [70](#)  
Hand-held transmitter, alternating code [136](#)  
Hazard warning flashers [196](#)  
Head airbags [98](#)  
Headlamp control, automatic [94](#)  
Headlamp courtesy delay feature [94](#)  
Headlamps [191](#)  
Headlamps, care [203](#)  
Headlight flasher [71](#)  
Headlight glass [190](#)  
Head restraints [49](#)  
Head restraints, front [54](#)  
Head restraints, rear [55](#)  
Heavy cargo, stowing cargo [157](#)  
High-beam Assistant [95](#)  
High beams [71](#)  
High beams/low beams, see High-beam Assistant [95](#)  
Higher speed range [155](#)  
High-performance engine [150](#)  
Hills [154](#)  
Hill start assistant, see Drive-off assistant [119](#)  
Holder for beverages [146](#)  
Homepage [6](#)  
Hood [180](#)  
Horn [14](#)  
Hotel function, tailgate [41](#)  
Hot exhaust system [153](#)  
Hydroplaning [153](#)

## I

Ice warning, see External temperature warning [84](#)  
Icy roads, see External temperature warning [84](#)  
Identification marks, tires [169](#)

Identification number, see Vehicle identification number [10](#)  
iDrive [18](#)  
Ignition key, see Remote control [37](#)  
Ignition off [65](#)  
Ignition on [65](#)  
Indication of a flat tire [103](#), [105](#)  
Indicator and alarm lamps, see Check Control [80](#)  
Indicator lamp, see Check Control [80](#)  
Individual air distribution [130](#), [132](#)  
Individual settings, see Personal Profile [41](#)  
Inflation pressure, tires [168](#)  
Inflation pressure warning, tires [105](#)  
Info display, see On-Board computer [88](#)  
Information [6](#)  
Initialize, Tire Pressure Monitor TPM [102](#)  
Initializing, Flat Tire Monitor FTM [105](#)  
Instrument cluster [79](#)  
Instrument cluster, electronic displays [79](#)  
Instrument lighting [96](#)  
Integrated key [37](#)  
Integrated Owner's Manual in the vehicle [29](#)  
Intelligent emergency call [196](#)  
Intelligent Safety [106](#)  
Intended use [7](#)  
Intensity, AUTO program [132](#)  
Interior equipment [135](#)  
Interior lights [96](#)  
Interior lights during unlocking [35](#)

Interior lights with the vehicle locked [35](#)  
Interior mirror, automatic dimming feature [59](#)  
Interior mirror, compass [137](#)  
Interior mirror, manually dimmable [59](#)  
Interior motion sensor [45](#)  
Internet page [6](#)  
Interval display, service requirements [85](#)  
Interval mode [72](#)

## J

Jacking points for the vehicle jack [178](#)  
Jump-starting [197](#)

## K

Key/remote control [37](#)  
Keyless Go, see Comfort Access [38](#)  
Key Memory, see Personal Profile [41](#)  
Key, see Remote control [34](#)  
Knee airbag [99](#)

## L

Label on recommended tires [172](#)  
Lamp replacement [189](#)  
Lamp replacement, front [191](#)  
Lamp replacement, rear [192](#)  
Lane departure warning [112](#)  
Lane threshold, warning [112](#)  
Language on Control Display [91](#)  
LATCH child restraint fixing system [63](#)  
Launch Control [78](#)  
Leather, care [204](#)  
LEDs, light-emitting diodes [190](#)

Letters and numbers, entering [25](#)  
Light [93](#)  
Light-alloy wheels, care [204](#)  
Light control [95](#)  
Light-emitting diodes, LEDs [190](#)  
Lighting [93](#)  
Lights and bulbs [189](#)  
Light switch [93](#)  
Load [157](#)  
Loading [156](#)  
Locking, automatic [43](#)  
Locking, settings [43](#)  
Low beams [93](#)  
Low beams, automatic, see High-beam Assistant [95](#)  
Lower back support [51](#)  
Low Speed Assistant [76](#)  
Luggage rack, see Roof-mounted luggage rack [157](#)  
Lumbar support [51](#)

## M

Maintenance [187](#)  
Maintenance requirements [187](#)  
Maintenance, service requirements [85](#)  
Maintenance system, BMW [187](#)  
Make-up mirror [139](#)  
Malfunction displays, see Check Control [80](#)  
Manual air distribution [130](#), [132](#)  
Manual air flow [129](#), [132](#)  
Manual operation, exterior mirrors [58](#)  
Manual operation, fuel filler flap [165](#)  
Manual transmission [74](#)  
Master key, see Remote control [37](#)  
Maximum cooling [131](#)

Maximum speed, display [86](#)  
Maximum speed, winter tires [172](#)  
M Compound brake [150](#)  
M differential, active [117](#)  
MDM, M Dynamic Mode [116](#)  
M double-clutch transmission [75](#)  
M Driver's Package, driving instructions [155](#)  
M Dynamic Mode MDM [116](#)  
Measurement, units of [92](#)  
Medical kit [197](#)  
Memory, seat, mirror [56](#)  
Menu in instrument cluster [88](#)  
Menus, operating, iDrive [18](#)  
Menus, see iDrive operating concept [20](#)  
Messages, see Check Control [80](#)  
Microfilter [130](#), [133](#)  
Minimum tread, tires [171](#)  
Mirror [57](#)  
Mirror memory [56](#)  
Mobile communication devices in the vehicle [153](#)  
Mobility System [173](#)  
Modifications, technical, see Own Safety [7](#)  
Moisture in headlight [190](#)  
Monitor, see Control Display [18](#)  
Mounting of child restraint systems [62](#)  
M technology [150](#)  
Multifunction steering wheel, buttons [14](#)  
Multimedia [6](#)

## N

Navigation [6](#)  
Neck restraints, front, see Head restraints [54](#)

Neck restraints, rear, see  
Head restraints [55](#)  
Neutral cleaner, see Wheel  
cleaner [204](#)  
New wheels and tires [171](#)

## O

OBD Onboard Diagnosis [188](#)  
OBD, see OBD Onboard Di-  
agnosis [188](#)  
Obstacle marking, rearview  
camera [126](#)  
Octane rating, see Recom-  
mended fuel grade [167](#)  
Odometer [83](#)  
Office [6](#)  
Oil [182](#)  
Oil, adding [183](#)  
Oil additives [184](#)  
Oil change [184](#)  
Oil change interval, service  
requirements [85](#)  
Oil filler neck [183](#)  
Oil types, alternative [184](#)  
Oil types, suitable [184](#)  
Old batteries, disposal [194](#)  
Onboard computer [88](#)  
Onboard computer, see On-  
board computer [88](#)  
Onboard monitor, see Control  
Display [18](#)  
Onboard vehicle tool kit [189](#)  
Opening and closing [34](#)  
Operating concept, iDrive [18](#)  
Optional equipment [7](#)  
Outside air, see Automatic re-  
circulated-air control [132](#)  
Own Safety [7](#)

## P

Paint, vehicle [203](#)  
Park Distance Control  
PDC [122](#)  
Parked-car ventilation [133](#)

Parked vehicle, condensa-  
tion [154](#)  
Parking aid, see PDC [122](#)  
Parking brake [70](#)  
Parking lights [93](#)  
Parts and accessories [8](#)  
Passenger side mirror, tilting  
downward [58](#)  
Pathway lines, rearview cam-  
era [126](#)  
PDC Park Distance Con-  
trol [122](#)  
Pedestrian warning with Ap-  
proach control [109](#)  
Personal Profile [41](#)  
Personal Profile, exporting  
profiles [42](#)  
Personal Profile, importing  
profiles [43](#)  
Pinch protection system,  
glass sunroof [48](#)  
Pinch protection system, win-  
dows [46](#)  
Plastic, care [205](#)  
Power failure [194](#)  
Power sunroof, glass [46](#)  
Power windows [45](#)  
Prescribed engine oil  
types [184](#)  
Pressure, tire air pres-  
sure [168](#)  
Pressure warning, tires [105](#)  
Preventing Auto Start  
Stop [69](#)  
Profile, see Personal Pro-  
file [41](#)  
Programmable memory but-  
tons, iDrive [24](#)  
Protective function, glass  
sunroof [48](#)  
Protective function, win-  
dows [46](#)  
Push-and-turn reel, refer to  
controller [19](#)

## R

Racetrack operation [150](#)  
Radiator fluid [185](#)  
Radio [6](#)  
Radio-operated key, see Re-  
mote control [37](#)  
Radio-operated remote con-  
trol, opening/closing [34](#)  
Radio ready state [65](#)  
Rain sensor [72](#)  
Rear lights [192](#)  
Rear socket [140](#)  
Rearview camera [125](#)  
Rearview mirror [57](#)  
Rear window de-  
froster [130](#), [133](#)  
Recirculated-air filter [133](#)  
Recirculated-air  
mode [129](#), [132](#)  
Recommended fuel  
grade [167](#)  
Recommended tire  
brands [172](#)  
Refueling [164](#)  
Remaining range [84](#)  
Remote control/key [37](#)  
Remote control, malfunc-  
tion [36](#)  
Remote control, opening/  
closing [34](#)  
Remote control, univer-  
sal [135](#)  
Replacement fuse [194](#)  
Replacing parts [189](#)  
Replacing wheels/tires [171](#)  
Reporting safety malfunc-  
tions [10](#)  
RES button, see Cruise con-  
trol [120](#)  
Reserve warning, see  
Range [84](#)  
Reset, Tire Pressure Monitor  
TPM [102](#)  
Retreaded tires [172](#)  
Roadside parking lights [93](#)

Rolling code hand-held transmitter [136](#)  
RON recommended fuel grade [167](#)  
Roofliner [17](#)  
Roof load capacity [211](#)  
Roof-mounted luggage rack [157](#)  
Rubber components, care [204](#)

## S

Safe braking [153](#)  
Safety belt reminder for driver's seat and front passenger seat [54](#)  
Safety belts [53](#)  
Safety belts, care [205](#)  
Safety systems, airbags [98](#)  
Saving fuel [159](#)  
Screen, see Control Display [18](#)  
Screwdriver, see Onboard vehicle tool kit [189](#)  
Sealant [173](#)  
Seat and mirror memory [56](#)  
Seat belts, see Safety belts [53](#)  
Seat heating, front [52](#)  
Seating position for children [61](#)  
Seats [49](#)  
Securing cargo [157](#)  
Selection list in instrument cluster [88](#)  
Selector lever [75](#)  
Selector lever position [75](#)  
Sensors, care [205](#)  
Sequential mode [76](#)  
Service and warranty [8](#)  
Service requirements, Condition Based Service CBS [187](#)  
Service requirements, display [85](#)  
Service, Roadside Assistance [197](#)  
Services, ConnectedDrive [6](#)  
Servotronic [117](#)  
SET button, see Cruise control [120](#)  
Settings, locking/unlocking [43](#)  
Settings on Control Display [91](#)  
Settings, storing for seat, mirror [56](#)  
Side airbags [98](#)  
Signaling, horn [14](#)  
Signals when unlocking [43](#)  
Sitting safely [49](#)  
Size [210](#)  
Slide/tilt glass roof [46](#)  
Snow chains [176](#)  
Socket [139](#)  
Socket, OBD Onboard Diagnostics [188](#)  
SOS button [196](#)  
Spare fuse [194](#)  
Speed, average [89](#)  
Speed Limit Info [86](#)  
Speed Limit Info, computer [90](#)  
Speed limits, display [86](#)  
Speed warning [90](#)  
Split screen [23](#)  
SPORT+ - program, driving dynamics [118](#)  
Sport displays, torque display, performance display [90](#)  
SPORT program, driving dynamics [118](#)  
Stability control systems [115](#)  
Standard equipment [7](#)  
Start/stop, automatic function [67](#)  
Start/Stop button [65](#)  
Starting the engine [66](#)  
Status control display, tires [102](#)  
Status information, iDrive [23](#)  
Status of Owner's Manual [7](#)  
Steering assistance [117](#)  
Steering wheel, adjusting [59](#)  
Steering wheel heating [60](#)  
Stopping the engine [67](#)  
Storage compartment in the rear [146](#)  
Storage compartments [144](#)  
Storage, tires [173](#)  
Storing the vehicle [206](#)  
Stowing and securing cargo [157](#)  
Suitable engine oil types [184](#)  
Summer tires, tread [171](#)  
Sun visor [139](#)  
Supplementary text messages [82](#)  
Switch for driving dynamics [117](#)  
Switch, see Cockpit [14](#)  
Symbols [6](#)  
Symbols in the status field [23](#)

## T

Tachometer [83](#)  
Tailgate closing [41](#)  
Tailgate, emergency unlocking [41](#)  
Tailgate, hotel function [41](#)  
Tailgate opening [40](#)  
Tailgate via remote control [35](#)  
Tail lamps [192](#)  
Technical changes, see Own Safety [7](#)  
Technical data [210](#)  
Technology, BMW M [150](#)  
Telephone [6](#)  
Temperature, automatic climate control [129](#), [131](#)  
Temperature display for external temperature [84](#)  
Temperature, engine [89](#)  
Terminal, starting aid [198](#)

Text messages, supplementary [82](#)  
Theft alarm system, see Alarm system [44](#)  
Thigh support [51](#)  
Through-loading system [142](#)  
Tilt alarm sensor [45](#)  
Time [91](#)  
Time of arrival [89](#)  
Tire damage [171](#)  
Tire identification marks [169](#)  
Tire inflation pressure [168](#)  
Tire inflation pressure monitor, see FTM [105](#)  
Tire Pressure Monitor TPM [101](#)  
Tire repair kit, see Mobility System [173](#)  
Tires, changing [171](#)  
Tire sealant, see Mobility System [173](#)  
Tires, everything on wheels and tires [168](#)  
Tire tread [171](#)  
Tone [6](#)  
Tool [189](#)  
Total vehicle weight [211](#)  
Touchpad [21](#)  
Towing [199](#)  
Tow-starting [199](#)  
TPM Tire Pressure Monitor [101](#)  
Transmission, manual transmission [74](#)  
Transporting children safely [61](#)  
Tread, tires [171](#)  
Triple turn signal activation [70](#)  
Trip odometer [83](#)  
Trip onboard computer [90](#)  
Trip recorder, see Trip odometer [83](#)  
Turning radius lines, rearview camera [126](#)  
Turn signals, operation [70](#)

Turn signals, rear, bulb replacement [192](#)

## U

Unintentional alarm [45](#)  
Units of measurement [92](#)  
Universal remote control [135](#)  
Unlocking, settings [43](#)  
Updates made after the editorial deadline [7](#)  
Upholstery care [204](#)  
USB interface, general information [140](#)  
USB port, see USB interface [140](#)  
Use, intended [7](#)

## V

Vanity mirror [139](#)  
Vehicle battery [193](#)  
Vehicle battery, replacing [193](#)  
Vehicle, break-in [152](#)  
Vehicle care [203](#)  
Vehicle care products [203](#)  
Vehicle features and options [7](#)  
Vehicle identification number [10](#)  
Vehicle jack [178](#)  
Vehicle key, see Remote control [37](#)  
Vehicle paint [203](#)  
Vehicle position, GPS location [92](#)  
Vehicle storage [206](#)  
Vehicle wash [202](#)  
Vehicle, washing [202](#)  
Ventilation [133](#)  
Ventilation, see Parked-car ventilation [133](#)  
VIN, see Vehicle identification number [10](#)  
Voice activation system [26](#)

## W

Warning and indicator lamps, see Check Control [80](#)  
Warning displays, see Check Control [80](#)  
Warning messages, see Check Control [80](#)  
Warning triangle [197](#)  
Warranty [7](#)  
Washer fluid [73](#)  
Washer nozzles, windshield [73](#)  
Washer system [71](#)  
Washing the vehicle [202](#)  
Water on roads [153](#)  
Weights [211](#)  
Welcome lights [94](#)  
Welcome lights during unlocking [35](#)  
Wheel cleaner [204](#)  
Wheels, changing [171](#)  
Wheels, everything on wheels and tires [168](#)  
Wheels, Flat Tire Monitor FTM [105](#)  
Wheels, Tire Pressure Monitor TPM [101](#)  
Window defroster, rear [130](#), [133](#)  
Windows, powered [45](#)  
Windshield washer fluid [73](#)  
Windshield washer nozzles [73](#)  
Windshield washer system [71](#)  
Windshield washer system, see Washer/wiper system [71](#)  
Windshield wiper, see Wiper system [71](#)  
Winter storage, care [206](#)  
Winter tires, suitable tires [172](#)  
Winter tires, tread [171](#)  
Wiper [71](#)

Wiper blades, replacing [189](#)  
Wiper fluid [73](#)  
Wiper, fold-away position [73](#)  
Wiper system [71](#)  
Wood, care [205](#)  
Word match concept [25](#)  
Wrench, see Onboard vehicle  
tool kit [189](#)

## X

Xenon headlights, bulb re-  
placement [191](#)



BMW M



The Ultimate  
Driving Machine®

01 40 2 974 681 ue

