

Contents

A-Z

Owner's Manual
for Vehicle



The Ultimate
Driving Machine®



THE BMW X6.

OWNER'S MANUAL.

BMW EfficientDynamics
Less emissions. More driving pleasure.

X6 **Owner's Manual for the vehicle**

Thank you for choosing a BMW.

The more familiar you are with your vehicle, the better control you will have on the road. We therefore strongly suggest:

Read this Owner's Manual before starting off in your new BMW. Also use the Integrated Owner's Manual in your vehicle. It contains important information on vehicle operation that will help you make full use of the technical features available in your BMW. The manual also contains information designed to enhance operating reliability and road safety, and to contribute to maintaining the value of your BMW.

Any updates made after the editorial deadline can be found in the appendix of the printed Owner's Manual for the vehicle.

Supplementary information can be found in the additional brochures in the onboard literature.

We wish you a safe and enjoyable trip.



The Owner's Manual is available in many countries as an app. Additional information on the Internet:

www.bmw.com/bmw_drivers_guide

© 2016 Bayerische Motoren Werke
Aktiengesellschaft
Munich, Germany
Reprinting, including excerpts, only with the written
consent of BMW AG, Munich.
US English ID4 X/16, 11 16 490
Printed on environmentally friendly paper, bleached
without chlorine, suitable for recycling.

Contents

The fastest way to find information on a particular topic or item is by using the index, refer to page [272](#).

[6](#) Information

[At a glance](#)

- [14](#) Cockpit
- [18](#) iDrive
- [26](#) Voice activation system
- [29](#) Integrated Owner's Manual in the vehicle

[Controls](#)

- [34](#) Opening and closing
- [53](#) Settings
- [64](#) Transporting children safely
- [69](#) Driving
- [86](#) Displays
- [106](#) Lights
- [111](#) Safety
- [141](#) Driving stability control systems
- [149](#) Driving comfort
- [172](#) Climate control
- [180](#) Interior equipment
- [188](#) Storage compartments

[Driving tips](#)

- [196](#) Things to remember when driving
- [200](#) Loading
- [203](#) Saving fuel

[Mobility](#)

- [212](#) Refueling
- [214](#) Fuel
- [216](#) Wheels and tires
- [232](#) Engine compartment
- [235](#) Engine oil
- [239](#) Coolant
- [241](#) Maintenance
- [243](#) Replacing components
- [249](#) Breakdown assistance
- [255](#) Care

[Reference](#)

- [262](#) Technical data
- [265](#) Appendix
- [272](#) Everything from A to Z

Information

Using this Owner's Manual

Orientation

The fastest way to find information on a particular topic is by using the index.

An initial overview of the vehicle is provided in the first chapter.

Updates made after the editorial deadline

Due to updates after the editorial deadline, differences may exist between the printed Owner's Manual and the following Owner's Manuals:

- ▷ Integrated Owner's Manual in the vehicle.
- ▷ Online Owner's Manual.
- ▷ BMW Driver's Guide app.

Notes on updates can be found in the appendix of the printed Owner's Manual for the vehicle.

Owner's Manual for Navigation, Entertainment, Communication

The Owner's Manual for Navigation, Entertainment, and Communication can be obtained as printed book from the service center.

The topics of Navigation, Entertainment, and Communication can be called up via the following Owner's Manuals:

- ▷ Integrated Owner's Manual in the vehicle on the Control Display.
- ▷ Online Owner's Manual.
- ▷ BMW Driver's Guide app.

Additional sources of information

Dealer's service center

A dealer's service center will be glad to answer questions at any time.

Internet

The Owner's Manual and general information on BMW, for example on technology, are available on the Internet: www.bmwusa.com.

BMW Driver's Guide App



The Owner's Manual is available in many countries as an app. Additional information on the Internet:

www.bmw.com/bmw_drivers_guide

Symbols and displays

Symbols in the Owner's Manual

 Indicates precautions that must be followed precisely in order to avoid the possibility of personal injury and serious damage to the vehicle.

◀ Marks the end of a specific item of information.

 Refers to measures that can be taken to help protect the environment.

"..." Identifies display texts in vehicle used to select individual functions.

>...< Verbal instructions to use with the voice activation system.

»...« Identifies the answers generated by the voice activation system.

Action steps

Action steps to be carried out are presented as numbered list. The steps must be carried out in the defined order.

1. First action step.
2. Second action step.

Enumerations

Enumerations without mandatory order or alternative possibilities are presented as list with bullet points.

- ▷ First possibility.
- ▷ Second possibility.

Symbols on vehicle components

 Indicates that you should consult the relevant section of this Owner's Manual for information on a particular part or assembly.

Vehicle features and options

This Owner's Manual describes all models and all standard, country-specific and optional equipment that is offered in the model series. Therefore, this Owner's Manual also describes and illustrates features and functions that are not available in your vehicle, for example because of the selected optional features or the country-specific version.

This also applies to safety-related functions and systems.

When using these functions and systems, the applicable laws and regulations must be observed.

For any options and equipment not described in this Owner's Manual, refer to the Supplementary Owner's Manuals.

Your BMW dealer's service center is happy to answer any questions that you may have about the features and options applicable to your vehicle.

Status of the Owner's Manual

Basic information

The manufacturer of your vehicle pursues a policy of constant development that is conceived to ensure that our vehicles continue to embody the highest quality and safety standards. In rare cases, therefore, the features described in this Owner's Manual may differ from those in your vehicle.

Updates made after the editorial deadline

Due to updates after the editorial deadline, differences may exist between the printed Owner's Manual and the following Owner's Manuals:

- ▷ Integrated Owner's Manual in the vehicle.
- ▷ Online Owner's Manual.
- ▷ BMW Driver's Guide app.

Notes on updates can be found in the appendix of the printed Owner's Manual for the vehicle.

For Your Own Safety

Intended use

Observe the following when using the vehicle:

- ▷ Owner's Manual.
- ▷ Information on the vehicle. Do not remove stickers.
- ▷ Technical vehicle data.
- ▷ The traffic, speed, and safety laws where the vehicle is driven.
- ▷ Vehicle documents and statutory documents.

Warranty

Your vehicle is technically configured for the operating conditions and registration require-

ments applying in the country of first delivery, also known as homologation. If your vehicle is to be operated in a different country it might be necessary to adapt your vehicle to potentially differing operating conditions and permit requirements. If your vehicle does not comply with the homologation requirements in a certain country you may not be able to lodge warranty claims for your vehicle there. Further information on warranty is available from a dealer's service center.

Maintenance and repairs

Advanced technology, e. g. the use of modern materials and high-performance electronics, requires suitable maintenance and repair work.

The manufacturer of the vehicle recommends that you entrust corresponding procedures to a BMW dealer's service center. If you choose to use another service facility, BMW recommends use of a facility that performs work, for instance maintenance and repair, according to BMW specifications with properly trained personnel, referred to in this Owner's Manual as "another qualified service center or repair shop".

If work is performed improperly, for instance maintenance and repair, there is a risk of subsequent damage and related safety risks.

Parts and accessories

BMW recommends the use of parts and accessory products approved by BMW.

Approved parts and accessories, and advice on their use and installation are available from a BMW dealer's service center.

BMW parts and accessories have been tested by BMW for their safety and suitability in BMW vehicles.

BMW warrants genuine BMW parts and accessories.

BMW does not evaluate whether each individual product from another manufacturer can be used with BMW vehicles without presenting a

safety hazard, even if a country-specific official approval was issued. BMW does not evaluate whether these products are suitable for BMW vehicles under all usage conditions.

California Proposition 65 Warning

California laws require us to state the following warning:

Engine exhaust and a wide variety of automobile components and parts, including components found in the interior furnishings in a vehicle, contain or emit chemicals known to the State of California to cause cancer and birth defects and reproductive harm. In addition, certain fluids contained in vehicles and certain products of component wear contain or emit chemicals known to the State of California to cause cancer and birth defects or other reproductive harm. Battery posts, terminals and related accessories contain lead and lead compounds. Wash your hands after handling. Used engine oil contains chemicals that have caused cancer in laboratory animals. Always protect your skin by washing thoroughly with soap and water.

Service and warranty

We recommend that you read this publication thoroughly. Your vehicle is covered by the following warranties:

- ▶ New Vehicle Limited Warranty.
- ▶ Rust Perforation Limited Warranty.
- ▶ Federal Emissions System Defect Warranty.
- ▶ Federal Emissions Performance Warranty.
- ▶ California Emission Control System Limited Warranty.

Detailed information about these warranties is listed in the Service and Warranty Information Booklet for US models or in the Warranty and Service Guide Booklet for Canadian models.

Your vehicle has been specifically adapted and designed to meet the particular operating conditions and homologation requirements in your

country and continental region in order to deliver the full driving pleasure while the vehicle is operated under those conditions. If you wish to operate your vehicle in another country or region, you may be required to adapt your vehicle to meet different prevailing operating conditions and homologation requirements. You should also be aware of any applicable warranty limitations or exclusions for such country or region. In such case, please contact Customer Relations for further information.

Maintenance

Maintain the vehicle regularly to sustain the road safety, operational reliability and the New Vehicle Limited Warranty.

Specifications for required maintenance measures:

- ▶ BMW Maintenance system
- ▶ Service and Warranty Information Booklet for US models
- ▶ Warranty and Service Guide Booklet for Canadian models

If the vehicle is not maintained according to these specifications, this could result in serious damage to the vehicle. Such damage is not covered by the BMW New Vehicle Limited Warranty.

Data memory

Many electronic components on your vehicle are equipped with data memories that temporarily or permanently store technical information about the condition of the vehicle, events and faults. This technical information generally records the state of a component, a module, a system or the environment:

- ▶ Operating states of system components, e.g., fill levels.
- ▶ Status messages for the vehicle and from its individual components, e.g., wheel rota-

tion speed, wheel speed, deceleration, transverse acceleration.

- ▶ Malfunctions and faults in important system components, e.g., lights and brakes.
- ▶ Responses by the vehicle to special situations such as airbag deployment or engagement of the stability control systems.
- ▶ Ambient conditions, such as temperature.

This data is purely technical in nature and is used to detect and correct faults and to optimize vehicle functions. Motion profiles over routes traveled cannot be created from this data. When service offerings are used, e.g., repair services, service processes, warranty claims, quality assurance, this technical information can be read out from the event and fault memories by employees of a dealer's service center or another qualified service center or repair shop, including the manufacturer, using special diagnostic tools. You can obtain further information there if you need it. After an error is corrected, the information in the fault memory is deleted or overwritten on a continuous basis.

With the vehicle in use there are situations where you can associate this technical data with individuals if combined with other information, e.g., an accident report, damage to the vehicle, eye witness accounts — possibly with the assistance of an expert.

Additional functions that are contractually agreed with the customer — such as vehicle emergency locating — allow certain vehicle data to be transmitted from the vehicle.

Event Data Recorder EDR

This vehicle is equipped with an event data recorder EDR. The main purpose of an EDR is to record, in certain crash or near crash-like situations, such as an air bag deployment or hitting a road obstacle, data that will assist in understanding how a vehicle's systems performed. The EDR is designed to record data related to

vehicle dynamics and safety systems for a short period of time, typically 30 seconds or less.

The EDR in this vehicle is designed to record such data as:

- ▷ How various systems in your vehicle were operating.
- ▷ Whether or not the driver and passenger safety belts were fastened.
- ▷ How far, if at all, the driver was depressing the accelerator and/or brake pedal.
- ▷ How fast the vehicle was traveling.

This data can help provide a better understanding of the circumstances in which crashes and injuries occur.

EDR data is recorded by your vehicle only if a nontrivial crash situation occurs; no data is recorded by the EDR under normal driving conditions and no personal data, e.g., name, gender, age, and crash location, are recorded.

However, other parties, such as law enforcement, could combine the EDR data with the type of personally identifying data routinely acquired during a crash investigation.

To read data recorded by an EDR, special equipment is required, and access to the vehicle or the EDR is needed. In addition to the vehicle manufacturer, other parties, such as law enforcement, that have the special equipment, can read the information if they have access to the vehicle or the EDR.

Vehicle identification number

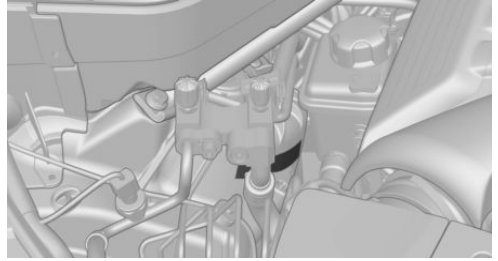

The vehicle identification number can be found in the engine compartment.

The vehicle identification number can also be found behind the windshield.

Reporting safety defects

For US customers

The following only applies to vehicles owned and operated in the US.

If you believe that your vehicle has a defect which could cause a crash or could cause injury or death, you should immediately inform the National Highway Traffic Safety Administration NHTSA, in addition to notifying BMW of North America, LLC, P.O. Box 1227, Westwood, New Jersey 07675-1227, Telephone 1-800-831-1117.

If NHTSA receives similar complaints, it may open an investigation, and if it finds that a safety defect exists in a group of vehicles, it may order a recall and remedy campaign.

However, NHTSA cannot become involved in individual problems between you, your dealer, or BMW of North America, LLC.

To contact NHTSA, you may call the Vehicle Safety Hotline toll-free at 1-888-327-4236 (TTY: 1-800-424-9153); go to <http://www.safercar.gov>; or write to: Administrator, NHTSA, 400 Seventh Street, SW., Washington, DC 20590. You can also obtain other in-

formation about motor vehicle safety from <http://www.safercar.gov>.

For Canadian customers

Canadian customers who wish to report a safety-related defect to Transport Canada, Defect Investigations and Recalls, may call the toll-free hotline 1-800-333-0510. You can also obtain other information about motor vehicle safety from <http://www.tc.gc.ca/roadsafety>.



At a glance

This chapter shows the arrangement of the buttons, switches and displays. Moreover, you will become familiar with the available control concepts and options quickly.

Cockpit

Vehicle features and options

This chapter describes all standard, country-specific and optional features offered with the series. It also describes features that are not necessarily available in your vehicle, e. g., due

to the selected options or country versions. This also applies to safety-related functions and systems. When using these functions and systems, the applicable laws and regulations must be observed.

In the vicinity of the steering wheel

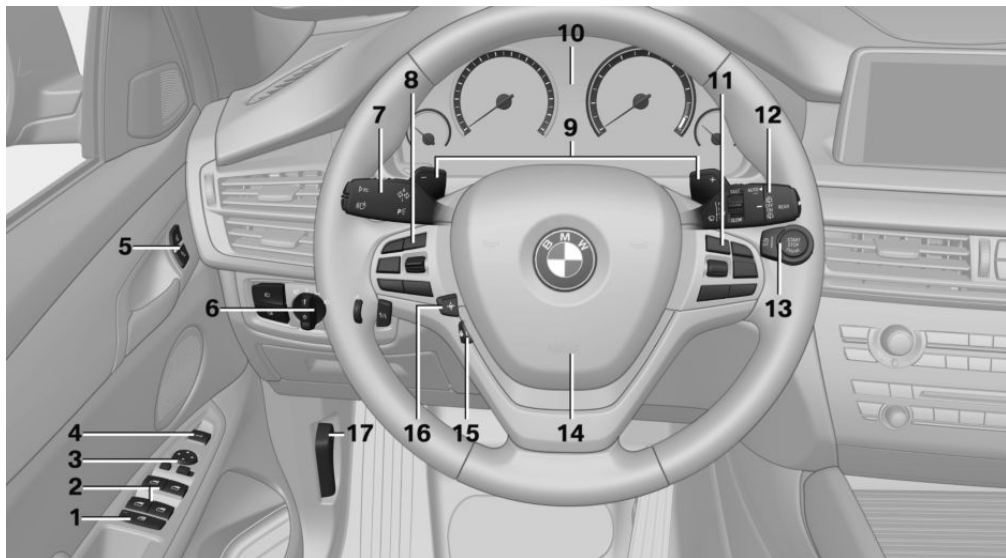

1 Rear window safety switch 50

2 Power windows 48

3 Exterior mirror operation 60

4  Opening and closing the tailgate 41

5  Unlock central locking system 38

 Locking central locking system 38

6 Lights



























 Front fog lights 109

 Light switch 106

 Lights off
Daytime running lights 108

 Parking lights 106

 Low beams 106

-  Automatic headlight control [107](#)
Adaptive Light Control [108](#)
High-beam Assistant [109](#)
-  Instrument lighting [110](#)
-  Night Vision, switch on/switch off heat image [130](#)
- 7** Steering column stalk, left
-  Turn signal [76](#)
-  High beams, headlight flasher [76](#)
-  High-beam Assistant [109](#)
-  Roadside parking lights [106](#)
-  Onboard computer [99](#)
- 8** Steering wheel buttons, left
-  Cruise control on/off, interrupt [155](#)
-  Active Cruise Control on/off, interrupt [149](#)
-  Cruise control: resume speed
-  Cruise control: store speed
-  Active Cruise Control, reduce distance
-  Active Cruise Control, increase distance
- Cruise control rocker switch
- 9** Shift paddles [83](#)
- 10** Instrument cluster [86](#)
- 11** Steering wheel buttons, right
-  Entertainment source
-  Volume
-  Voice activation [26](#)
-  Telephone, see Owner's Manual for Navigation, Entertainment and Communication
- Thumbwheel for selection lists [99](#)
- 12** Steering column stalk, right
-  Wiper [77](#)
-  Rain sensor [78](#)
-  Clean the windshield and headlights [77](#)
- 13**  Start/stop the engine and switch the ignition on/off [70](#)
-  Auto Start/Stop function [71](#)
- 14**  Horn, entire surface
- 15**  Steering wheel heating [62](#)
- 16**  Adjust steering wheel [62](#)

17 Unlock hood 232

All around the center console

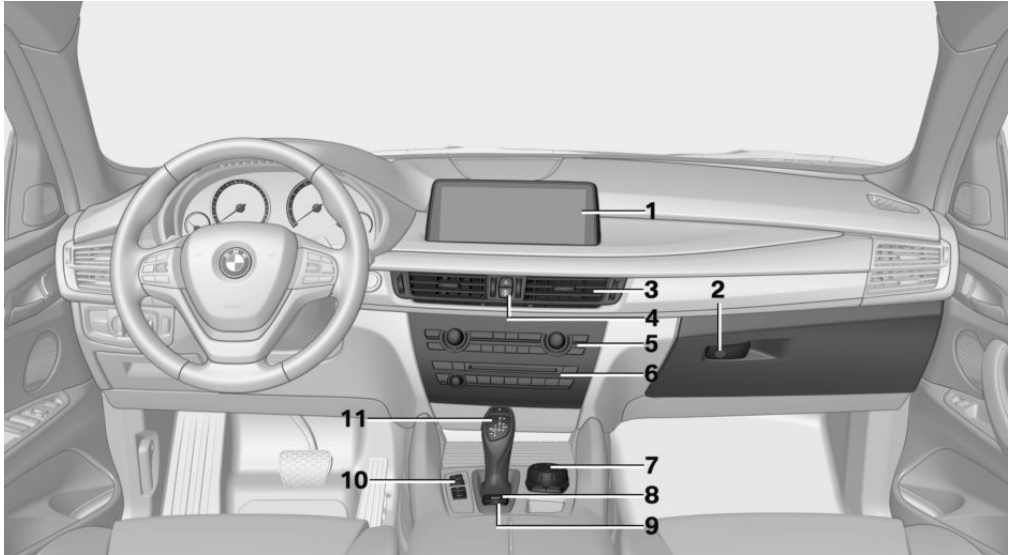

1 Control Display 18

2 Glove compartment 188

3 Ventilation 176

4  Hazard warning system 2495  Intelligent Safety button 120

5 Automatic climate control 172

6 Radio/CD/Multimedia, see Owner's Manual for Navigation, Entertainment and Communication

7 Controller with buttons 19

8  Parking brake 739  Automatic Hold 7410  DSC Dynamic Stability Control 142 Driving Dynamics Control 146 PDC Park Distance Control 158

Rearview camera 160

Top View 163





Parking assistant 167

 Side View 165 HDC Hill Descent Control 144

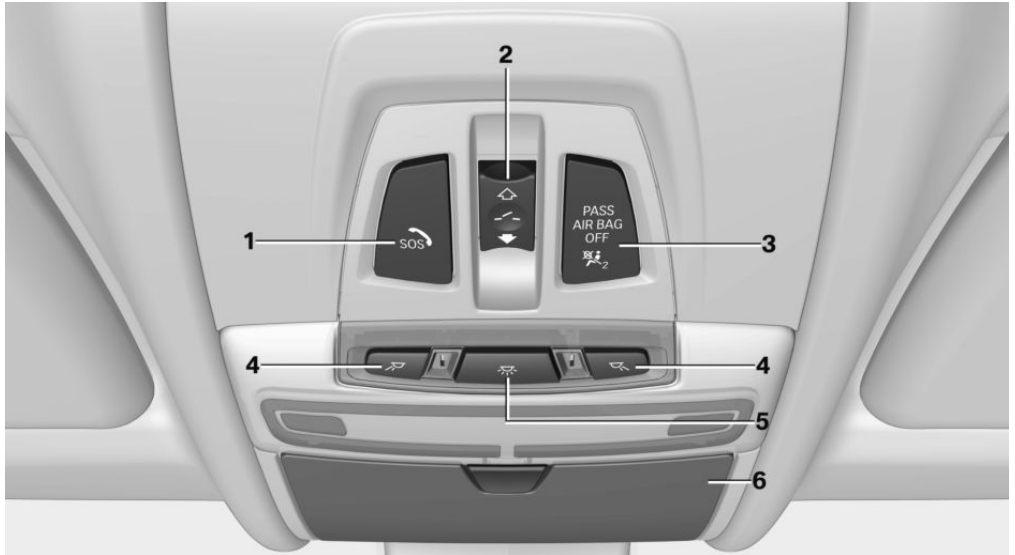
11 Transmission selector lever 80

In the vicinity of the roofliner



- | | | | | | |
|---|---|--|---|--|-------------------------|
| 1 |  | Emergency Request, SOS 249 | 4 |  | Reading lights 110 |
| 2 |  | Glass sunroof, electric 50 | 5 |  | Interior lights 110 |
| 3 |  | Indicator light, front-seat passenger airbag 114 | 6 | | Glasses compartment 190 |

iDrive

Vehicle features and options

This chapter describes all standard, country-specific and optional features offered with the series. It also describes features that are not necessarily available in your vehicle, e. g., due to the selected options or country versions. This also applies to safety-related functions and systems. When using these functions and systems, the applicable laws and regulations must be observed.

Concept

The iDrive combines the functions of many switches. Thus, these functions can be operated from a central location.

Safety information



WARNING

Operating the integrated information systems and communication devices while driving can distract from traffic. It is possible to lose control of the vehicle. There is a risk of an accident. Only use the systems or devices when the traffic situation allows. If necessary, stop and use the systems and devices while the vehicle is stationary. ◀

Overview of control elements

Operation

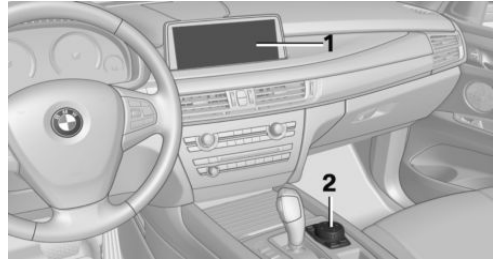

- 1 Control Display
- 2 Controller with buttons and, depending on the equipment version, with touchpad

Control Display

General information

To clean the Control Display, follow the care instructions.

Do not place objects close to the Control Display; otherwise, the Control Display can be damaged.

In the case of very high temperatures on the Control Display, e.g., due to intense solar radiation, the brightness may be reduced down to complete deactivation. Once the temperature is reduced, e.g., through shadow or climate control system, the normal functions are restored.

Switching on

1. Switch on the ignition.
2. Press the controller.

Switching off

1.  Press button.

2. "Turn off control display"

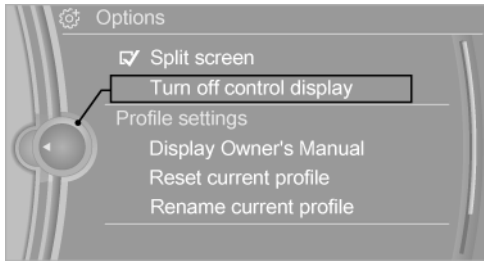

Controller with navigation system

The buttons can be used to open the menus directly. The controller can be used to select menu items and enter the settings.

Some iDrive functions can be operated using the touchpad on the controller.

1. Turn.

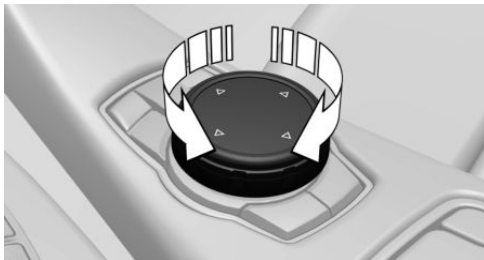

2. Press.



3. Move in four directions.

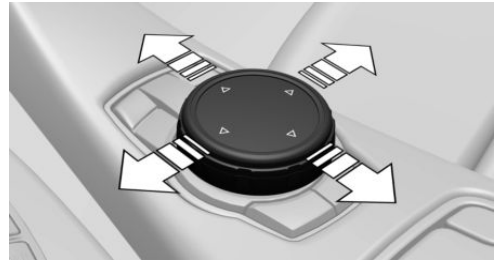

Buttons on the controller

Button	Function
MENU	Opens the main menu.
RADIO	Opens the Radio menu.
MEDIA	Opens the Multimedia menu.
NAV	Opens the Navigation menu.
TEL	Opens the Phone menu.
BACK	Displays the previous panel.
OPTION	Open the Options menu.

Controller without navigation system

The buttons can be used to open the menus directly. The controller can be used to select menu items and enter the settings.

1. Turn.

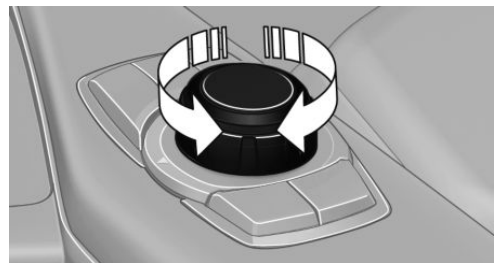

2. Press.

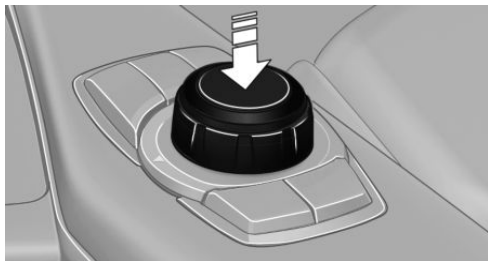

3. Move in two directions.

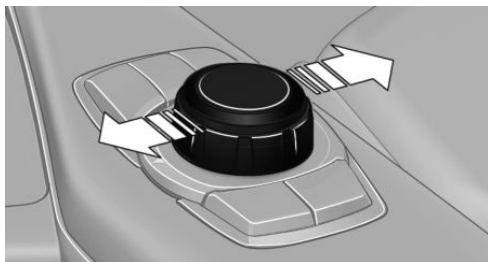

Buttons on the controller

Button	Function
MENU	Opens the main menu.
AUDIO	Open audio menu last listened to, switch between audio menus.
TEL	Opens the Phone menu.
BACK	Open previous panel.
OPTION	Open the Options menu.

Operating concept

Opening the main menu



Press button.

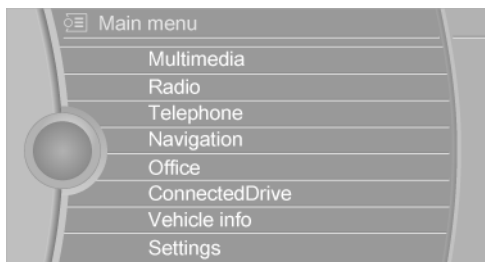

The main menu is displayed.

All iDrive functions can be called up via the main menu.

Selecting menu items

Highlighted menu items can be selected.

1. Turn the controller until the desired menu item is highlighted.

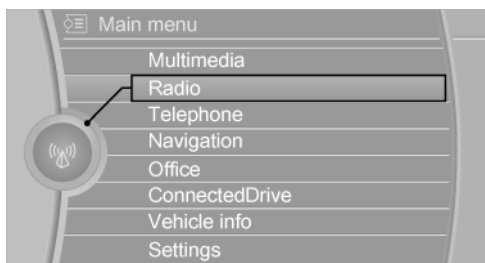

2. Press the controller.

Menu items in the Owner's Manual

In the Owner's Manual, menu items that can be selected are set in quotation marks, e.g., "Settings".

Changing between panels

After a menu item is selected, e.g., "Radio", a new panel is displayed. Panels can overlap.

- ▷ Move the controller to the left.
Closes current panel and shows previous display.
- Reopens previous display by pressing BACK button. In this case, the current panel is not closed.
- ▷ Move the controller to the right.

Opens new panel on top of previous screen.

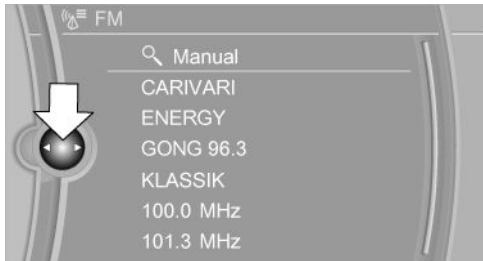

White arrows pointing to the left or right indicate that additional panels can be opened.

Opening the Options menu



Press button.

The "Options" menu is displayed.

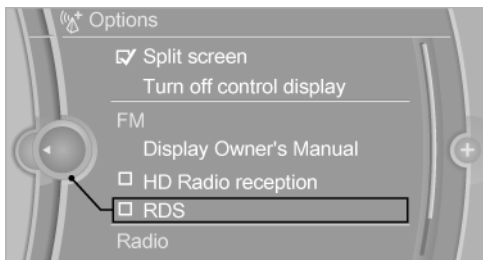

Additional options: move the controller to the right repeatedly until the "Options" menu is displayed.

Options menu

The "Options" menu consists of various areas:

- ▷ Screen settings, e.g., "Split screen".
- ▷ Control options for the selected main menu, e.g., for "Radio".
- ▷ If applicable, further operating options for the selected menu, e.g., "Store station".

Changing settings

1. Select a field.

2. Turn the controller until the desired setting is displayed.

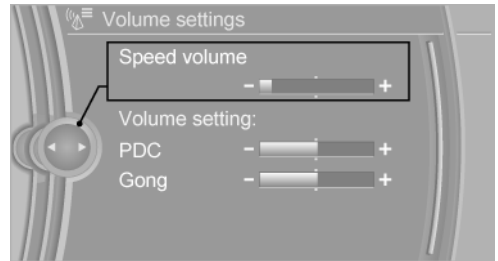

3. Press the controller.

Activating/deactivating the functions

Several menu items are preceded by a check-box. It indicates whether the function is activated or deactivated. Selecting the menu item activates or deactivates the function.

- Function is activated.
- Function is deactivated.

Touchpad

Some iDrive functions can be operated using the touchpad on the controller.

Selecting functions

1. "Settings"
2. "Touchpad"
3. Select the desired function.
 - ▷ "Speller": enter letters and numbers.
 - ▷ "Interactive map": use the interactive map.
 - ▷ "Browser": enter Internet addresses.
 - ▷ "Audio feedback": pronounces entered letters and numbers.

Entering letters and numbers

Entering letters requires some practice at the beginning. When entering, pay attention to the following:

- ▶ The system distinguishes between upper and lower-case letters and numbers. For entries, it may be necessary to change between upper and lower-case letters, numbers and characters, refer to page 25.
- ▶ Enter characters as they are displayed on the Control Display.
- ▶ Always enter associated characters, such as accents or periods so that the letter can be clearly recognized. The set language determines what input is possible. Where necessary, enter special characters via the controller.
- ▶ To delete a character, swipe to the left on the touchpad.
- ▶ To enter a blank space, swipe to the right in the center of the touchpad.
- ▶ To enter a hyphen, swipe to the right in the upper area of the touchpad.
- ▶ To enter an underscore, swipe to the right in the lower area of the touchpad.

Using the interactive map and Internet

The interactive map in the navigation system and Internet pages can be moved using the touchpad.

Function	Operation
Move interactive map or Internet pages.	Swipe into respective direction.
Enlarge/shrink interactive map or Internet pages.	Drag in or out on the touchpad with fingers.
Display the menu or open a link on the Internet.	Tap once.

Changing settings

You can use the touchpad to change Control Display settings, e.g., volume. Swipe left or right accordingly.

Example: setting the clock

Setting the clock

On the Control Display:

1.  Press button. The main menu is displayed.
2. Turn the controller until "Settings" is highlighted, and then press the controller.

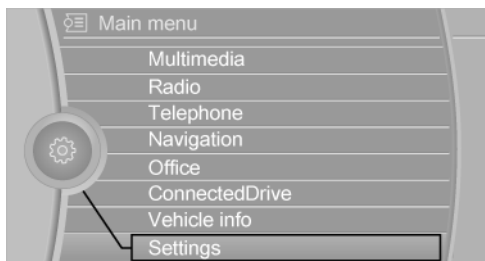

3. If necessary, move the controller to the left to display "Time/Date".
4. Turn the controller until "Time/Date" is highlighted, and then press the controller.



5. Turn the controller until "Time:" is highlighted, and then press the controller.



6. Turn the controller to set the hours, and then press the controller.
7. Turn the controller to set the minutes, and then press the controller.

Status information

Status field



The following information is displayed in the status field at the top right:

- ▷ Time.
- ▷ Current entertainment source.
- ▷ Sound output, on/off.
- ▷ Wireless network reception strength.
- ▷ Phone status.
- ▷ Traffic bulletin reception.







Status field symbols





The symbols are grouped as follows:

Radio symbols





Symbol	Meaning
	HD Radio station is being received.
	Satellite radio is switched on.

Telephone symbols



Symbol	Meaning
	Incoming or outgoing call.
	Missed call.
	Wireless network reception strength. Symbol flashes: network search.
	Wireless network is not available.
	Bluetooth is switched on.
	Roaming is active.

Symbol	Meaning
	Text message was received.
	Check the SIM card.
	SIM card is blocked.
	SIM card is missing.
	Enter PIN.

Entertainment symbols

Symbol	Meaning
	CD/DVD player.
	Music collection.
	Gracenote® database.
	AUX-IN port in the front or in the rear.
	USB audio interface.

Additional symbols

Symbol	Meaning
	Spoken instructions are turned off.
	Check the current vehicle position.

Split screen

General information

Additional information can be displayed on the right side of the split screen, e.g., information from the onboard computer.

In the divided screen view, the so-called split screen, this information remains visible even when switching to another menu.

Switching the split screen on/off

On the Control Display:

1.  Press button.
2. "Split screen"

Selecting the display

On the Control Display:

1.  Press button.
2. "Split screen"
3. Move the controller until the split screen is selected.
4. Press the controller or select "Split screen content".
5. Select the desired menu item.

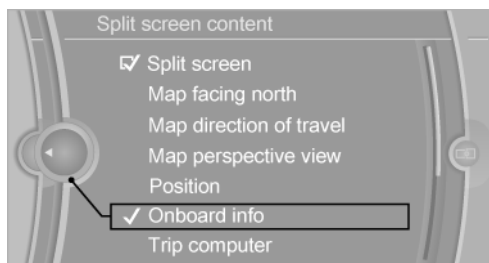

Programmable memory buttons



General information

The iDrive functions can be stored on the programmable memory buttons and called up directly, for instance radio stations, navigation destinations, phone numbers and menu entries.



Settings are stored for the profile currently used.

Saving a function

1. Highlight the function via iDrive.

2. ... Press and hold the desired button, until a signal sounds.

Running a function

1. ... Press button.
- The function will work immediately. This means, e.g., that the number is dialed when a phone number is selected.

Displaying the key assignment

Touch buttons with finger. Do not wear gloves or use objects.

The button assignment is displayed at the top edge of screen.

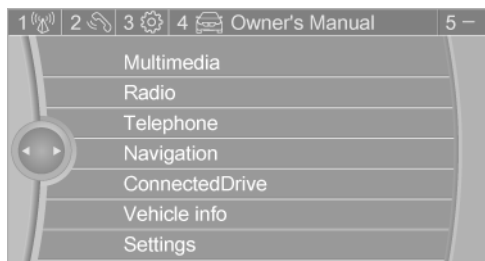

Deleting the button assignments

1. Press buttons 1 and 8 simultaneously for approx. 5 seconds.
2. "OK"

Deleting personal data in the vehicle

Concept

Depending on the usage, the vehicle saves personal data, such as stored radio stations. This personal data can be permanently deleted using iDrive.

General information

Depending on the equipment package, the following data can be deleted:

- ▷ Personal Profile settings.
- ▷ Stored radio stations.
- ▷ Stored Favorites buttons.
- ▷ Travel and onboard computer information.
- ▷ Music collection.
- ▷ Navigation, for instance stored destinations.
- ▷ Phone book.
- ▷ Online data, for instance Favorites, cookies.
- ▷ Voice notes.
- ▷ Login accounts.

Altogether, the deletion of the data can take up to 30 minutes.

Functional requirement

Data can only be deleted while stationary.

Deleting data

Heed and follow the instructions on the Control Display.



1. Switch on the ignition.
2. "Settings"
3. Open "Options".
4. "Delete personal data"
5. "Continue"
6. "OK"

Entering letters and numbers

General information

On the Control Display:

1. Turn the controller: select letters or numbers.
2. Select additional letters or numbers, if needed.
3. "OK": confirm the entry.

Symbol	Function
	Press the controller: delete letters or number.
	Press the controller for an extended period: delete all letters or numbers.

Switching between upper/lower case, numbers and characters

Depending on the menu, you can switch between entering upper and lower case letters and numbers:

Symbol	Function
A^BC	Enter the letters.
1@+	Enter the numbers.
abc or ABC	Tip the controller up.

Without navigation system

@^A A^a a[@] Select the symbol.

Entry comparison

When entering names and addresses, the choice is narrowed down with every letter entered and letters may be added automatically.

Entries are continuously compared with data stored in the vehicle.

- ▷ Only those letters are offered during entry for which data is available.
- ▷ Destination search: place names can be entered in all languages that are available on the Control Display.

Voice activation system

Vehicle features and options

This chapter describes all standard, country-specific and optional features offered with the series. It also describes features that are not necessarily available in your vehicle, e. g., due to the selected options or country versions. This also applies to safety-related functions and systems. When using these functions and systems, the applicable laws and regulations must be observed.

Concept

- ▷ Most functions displayed on the Control Display can be operated by voice commands via the voice activation system. The system supports you with announcements during input.
- ▷ Functions that can only be used when the vehicle is stationary cannot be used via the voice activation system.
- ▷ The system uses a special microphone on the driver's side.
- ▷ »...« in the Owner's Manual denotes verbal instructions to use with the voice activation system.

Requirements

Via the Control Display, set a language that is also supported by the voice activation system so that the spoken commands can be identified.

Set the language, refer to page 103.

Using the voice activation system

Activating the voice activation system

1.  Press button on the steering wheel.
2. Wait for the signal.
3. Say the command.

A command that is recognized by the voice activation system is announced and displayed in the instrument cluster.

 This symbol in the instrument cluster indicates that the voice activation system is active. If no other commands are possible, operate the function via iDrive.

Terminating the voice activation system

 Press the button on the steering wheel or »Cancel«.

Possible commands

Most menu items on the Control Display can be voiced as commands.

The available commands depend on the menu that is currently displayed on the Control Display.

There are short commands for many functions. You may select list entries such as phone list entries via voice activation. Read these list entries out loud exactly as they are shown in the respective list.

Having possible commands read aloud

You can have available commands read out loud for you: »Voice commands«.

E.g., if the "Settings" menu is displayed, the commands for the settings are read out loud.

Executing functions using short commands

Execute functions on the main menu via short commands. It almost doesn't matter which menu item is selected, e.g., ›Vehicle status‹.

List of short commands for the voice activation system, see Navigation, Entertainment, Communication Owner's Manual.

The list for short commands of the voice activation system can be called up via the Integrated Owner's Manual on the Control Display.

Help dialog for the voice activation system

Calling up help dialog: ›Help‹.

Additional commands for the help dialog:

- ▶ ›Help with examples‹: announces information about the current operating options and the most important commands for them.
- ▶ ›Help with voice activation‹: announces information about the principle of operation for the voice activation system.

Example: opening the tone settings

Via the main menu

The commands of the menu items are spoken just as they are selected via the controller.

1. Turn on the Entertainment sound output, if needed.
2.  Press button on the steering wheel.
3. ›Radio‹
4. ›Tone‹

Via short command

The desired tone settings can also be started via a short command.

1. Turn on the Entertainment sound output, if needed.
2.  Press button on the steering wheel.
3. ›Tone‹

Setting the voice dialog

You can set the system to use standard dialog or a short version.

The short version of the voice dialog plays back short messages in abbreviated form.

1. "Settings"
2. "Language/Units"
3. "Speech type:"
4. Select setting.

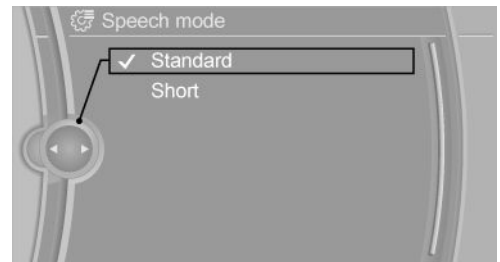

Adjusting the volume

Turn the volume button during the spoken instructions until the desired volume is set.

- ▶ The volume remains constant even if the volume of other audio sources is changed.
- ▶ The volume is stored for the profile currently used.

Information on Emergency Requests

Do not use the voice activation system to initiate an Emergency Request. In stressful situations, the voice and vocal pitch can change. This can unnecessarily delay the establishment of a phone connection.

Instead, use the SOS button, refer to page 249, close to the interior mirror.

Environmental conditions

- ▷ Say the commands, numbers, and letters smoothly and with normal volume, emphasis, and speed.
- ▷ Always say commands in the language of the voice activation system.
- ▷ Keep the doors, windows, and glass sunroof closed to prevent noise interference.
- ▷ Avoid making other noise in the vehicle while speaking.

Integrated Owner's Manual in the vehicle

Vehicle features and options

This chapter describes all standard, country-specific and optional features offered with the series. It also describes features that are not necessarily available in your vehicle, e. g., due to the selected options or country versions. This also applies to safety-related functions and systems. When using these functions and systems, the applicable laws and regulations must be observed.

Integrated Owner's Manual in the vehicle

Concept

The Integrated Owner's Manual specifically describes features and functions found in the vehicle. It can be displayed on the Control Display.

Components of the Integrated Owner's Manual

The Integrated Owner's Manual consists of three parts, which offer various levels of information or possible access.

Quick Reference Guide

The Quick Reference Guide provides information on how to operate the vehicle, how to use basic vehicle functions and what to do in case of a breakdown. This information can also be displayed while driving.

Search by images

Based on illustrations, image search provides information and descriptions. This is useful, e.g., when the terminology for a feature is not known.

Owner's Manual

Search for information and descriptions by entering terms selected from the index.

Select components

1.  Press button.
2. Turn the controller: open "Vehicle info".
3. Press the controller.
4. Selecting desired range:
 - ▷ "Quick reference"
 - ▷ "Search by pictures"
 - ▷ "Owner's Manual"

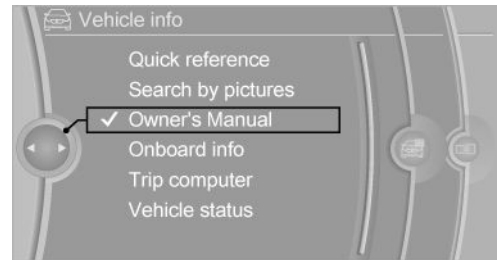

Leafing through the Owner's Manual

Page by page with link access

Turn the controller until the next or previous page is displayed.

Page by page without link access

Scroll through the pages directly while skipping the links.

Highlight the symbol once. Now simply press the controller to browse from page to page.



Scroll back.



Scroll forward.

Context help - operating instructions for the currently selected function

The relevant information can be opened directly.

Opening via iDrive

Change directly to the Options menu from the function on the Control Display:

1.  Press button or move the controller to the right repeatedly until the "Options" menu is displayed.
2. "Display Owner's Manual"



Opening when a Check Control message is displayed

Directly from the Check Control message on the Control Display:

"Display Owner's Manual"

Changing between a function and the operating instructions

To switch from a function, e.g., radio, to the Owner's Manual on the Control Display and to alternate between the two displays:

1.  Press button or move the controller to the right repeatedly until the "Options" menu is displayed.
2. "Display Owner's Manual"
3. Select the desired page in the Owner's Manual.
4.  Press button again to return to last displayed function.
5.  Press button to return to the page of the Owner's Manual displayed last.

To alternate permanently between the last displayed function and the Owner's Manual repeat steps 4 & 5. Opens a new display every time.

Programmable memory buttons

General information

The Owner's Manual can be stored on the programmable memory buttons and called up directly.

Storing

1. "Owner's Manual" Select via iDrive.
2.  Press selected button for more than 2 seconds.

Executing

1.  Press button.
The Owner's Manual is displayed immediately.



Controls

The information in this chapter helps you in confidently operating your vehicle. All features and accessories that are useful for driving and your safety, comfort and convenience are described here.

Opening and closing

Vehicle features and options

This chapter describes all standard, country-specific and optional features offered with the series. It also describes features that are not necessarily available in your vehicle, e. g., due to the selected options or country versions. This also applies to safety-related functions and systems. When using these functions and systems, the applicable laws and regulations must be observed.

Remote control

General information

The vehicle is supplied with two remote controls with integrated key.

Each remote control contains a replaceable battery. Replacing the battery, refer to page 36.

You may set the key functions depending on the optional features and country-specific version. Settings, refer to page 46.

The vehicle stores personal settings for every remote control. Personal Profile, refer to page 44.

The remote controls hold information about required maintenance. Service data in the remote control, refer to page 241.

Safety information

 **WARNING**

People or animals in the vehicle can lock the doors from the inside and lock themselves in. In this case, the vehicle cannot be opened from the outside. There is a risk of injury. Take the remote control with you so that the vehicle can be opened from the outside. ◀

 **WARNING**

Unlocking from the inside is only possible with special knowledge.

Persons who spend a lengthy time in the vehicle while being exposed to extreme temperatures are at risk of injury or death. Do not lock the vehicle from the outside when there are people in it. ◀

 **WARNING**

Unattended children or animals can cause the vehicle to move and endanger themselves and traffic, e.g., due to the following actions:

- ▷ Pressing the Start/Stop button.
- ▷ Releasing the parking brake.
- ▷ Opening and closing the doors or windows.
- ▷ Engaging selector lever position N.
- ▷ Using vehicle equipment.

There is a risk of accidents or injuries. Do not leave children or animals unattended in the vehicle. Take the remote control with you when exiting and lock the vehicle. ◀

Overview



- 1 Unlocking
- 2 Locking
- 3 Opening the tailgate
- 4 Panic mode

Unlocking



Press button on the remote control.

Depending on the settings, refer to page 46, the following access points are unlocked.

- ▷ Driver's door and fuel filler flap.
Press the button of the remote control again to unlock the other vehicle access points.

- ▷ All doors, tailgate, and fuel filler flap.

In addition, the following functions are executed:

- ▷ The settings saved in the driver profile, refer to page 44, are applied.
- ▷ The interior lights and courtesy lights are activated. This function is not available, if the interior lights were switched off manually.
- ▷ The welcome lights are switched on, if this function was activated.
- ▷ The alarm system, refer to page 47, is switched off.

The light functions may depend on the ambient brightness.

Convenient opening



Press and hold this button on the remote control after unlocking.

The windows and the glass sunroof are opened, as long as the button on the remote control is pressed.

Locking

1. Close the driver's door.



Press button on the remote control.

- ▷ All doors, the tailgate, and the fuel filler flap are being locked.
- ▷ The alarm system, refer to page 47, is switched on.

If the engine or ignition is still switched on when you lock the vehicle, the vehicle horn honks twice. In this case, the engine or ignition must be switched off by means of the Start/Stop button.

Lock



Press button on the remote control with the vehicle locked.

This function is not available, if the interior lamps were switched off manually.

The light functions may depend on the ambient brightness.

If the button is pressed again within 10 seconds after vehicle was locked, the interior motion sensor and tilt alarm sensor of the anti-theft warning system, refer to page 48, are turned off. After locking, wait 10 seconds before pressing the button again.

Tailgate

General information

To avoid locking it in the vehicle, do not place the remote control in the cargo area.

Depending on your vehicle's equipment and the country version, it is possible to specify whether the doors are also unlocked when unlocking with the remote control. Adjusting the settings, refer to page 46.

Safety information



WARNING

Body parts can be jammed when operating the tailgate. There is a risk of injury. Make sure that the area of movement of the tailgate is clear during opening and closing. ◀



NOTE

The tailgate swings back and up when it opens. There is a risk of property damage. Make sure that the area of movement of the tailgate is clear during opening and closing. ◀

**NOTE**

Sharp-edged or pointed objects can hit the rear window and heat conductors while driving. There is a risk of property damage. Cover the edges and ensure that pointed objects do not hit the rear window. ◀

Opening

Press button on the remote control for approx. 1 second.

The tailgate opens automatically.

The tailgate cannot be opened with the remote control while a trailer is being towed.

Panic mode

You can trigger the alarm system if you find yourself in a dangerous situation.



Press button on the remote control for at least 3 seconds.

To switch off the alarm: press any button.

Replacing the battery

1. Remove the integrated key from the remote control, refer to page 37.
2. Place the integrated key underneath the battery compartment cover, arrow 1, and lift the cover with a lever movement of the integrated key, arrow 2.

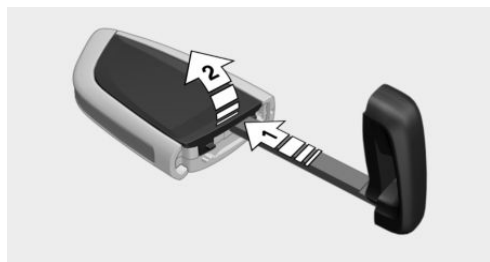

3. Push battery in the direction of the arrow using a pointed object and lift it out.

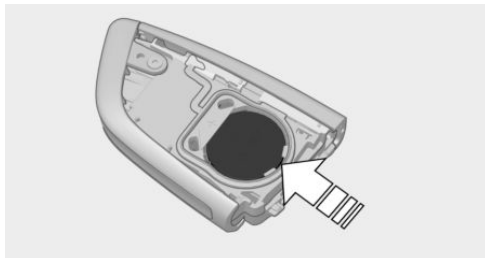

4. Insert a type CR 2032 battery with the positive side facing up.
5. Press the cover closed.
6. Push the integrated key into the remote control until it engages.



Have old batteries disposed of by a dealer's service center or another qualified service center or repair shop or take them to a collection point.

Additional remote controls

Additional remote controls are available from a dealer's service center or another qualified service center or repair shop.

Loss of the remote controls

A lost remote control can be blocked and replaced by a dealer's service center or another qualified service center or repair shop.

Malfunction**General information**

A Check Control message is displayed.

Remote control detection by the vehicle may malfunction under the following circumstances:

- ▶ The battery of the remote control is discharged. Replacing the battery, refer to page 36.

- ▶ Interference of the radio connection from transmission towers or other equipment with high transmitting power.
- ▶ Shielding of the remote control due to metal objects.
Do not transport the remote control together with metal objects.
- ▶ Interference of the radio connection from mobile phones or other electronic devices in direct proximity to the remote control.
Do not transport the remote control together with electronic devices.
- ▶ Interference of radio transmission by a charging process of mobile devices, for instance charging of a mobile phone.
- ▶ The remote control is in direct proximity of the wireless charging tray.
Place the remote control down at a different location.

In the case of interference, the vehicle can be unlocked and locked from the outside with the integrated key, refer to page 37.

Starting the engine via emergency detection of the remote control

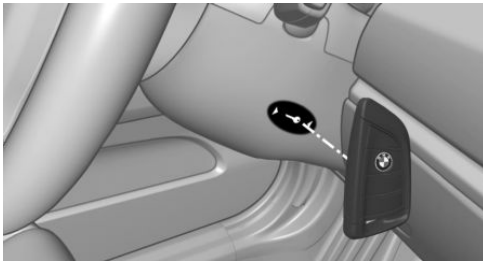

1. Hold the remote control with its back against the marked area on the steering column.
2. Start the engine within 10 seconds.

If the remote control is not detected, slightly change the position of the remote control and repeat the procedure.

Integrated key

General information

The driver's door can be locked and unlocked without remote control using the integrated key.

Safety information



WARNING

Unlocking from the inside is only possible with special knowledge.

Persons who spend a lengthy time in the vehicle while being exposed to extreme temperatures are at risk of injury or death. Do not lock the vehicle from the outside when there are people in it. ◀



NOTE

The door lock is permanently joined with the door. The door handle can be moved. When pulling the door handle with the integrated key inserted, paint or key can be damaged. There is a risk of property damage. Remove the integrated key before pulling the outside door handle. ◀

Removing

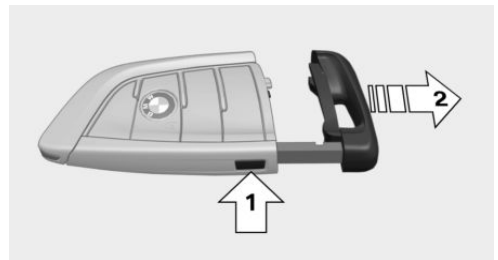

Press the button, arrow 1, and pull out the integrated key, arrow 2.

Locking/unlocking via the door lock

1. Remove lid on the door lock.

To do this, slide the integrated key into the opening from below and remove the lid.

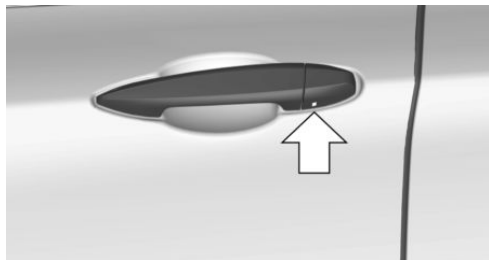

2. Unlock or lock the door lock using the integrated key.

The other doors must be unlocked or locked from the inside.

Alarm system

The alarm system is not switched on if the vehicle is locked with the integrated key.

The alarm system is triggered when the door is opened, if the vehicle has been unlocked via the door lock.

In order to stop the alarm, unlock the vehicle with the remote control or switch on the ignition, if needed, through emergency detection of the remote control, refer to page 37.

Buttons for the central locking system

General information

In the event of a severe accident, the vehicle is automatically unlocked. The hazard warning system and interior lights come on.

Overview



Buttons for the central locking system.

Locking



Press the button with the front doors closed.

The fuel filler flap remains unlocked.

The vehicle is not secured against theft when locking.

Unlocking



Press button.

Opening



- ▷ Press button to unlock the doors together, and then pull the door handle above the armrest.
- ▷ Front doors: pull the door handle on the door to open the door. The other doors remain locked.
- ▷ Back doors: pull twice on the door handle on the door to be opened; the first time unlocks the door, the second time opens it. The other doors remain locked.

Comfort Access

Concept

The vehicle can be accessed without activating the remote control.

All you need to do is to have the remote control with you, such as in your pants pocket.

The vehicle automatically detects the remote control when it is in close proximity or in the vehicle's interior.

General information

Comfort Access supports the following functions:

- ▶ Unlocking and locking the vehicle.
- ▶ Convenient closing.
- ▶ Open the tailgate.
- ▶ Opening/closing the tailgate with no-touch activation.

Functional requirements

- ▶ To lock the vehicle, the remote control must be located outside of the vehicle near the doors.
- ▶ The next unlocking and locking cycle is not possible until after approx. 2 seconds.

Unlocking

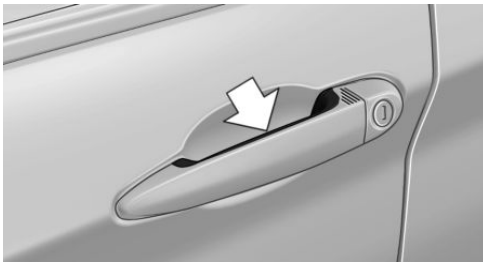

Grasp the handle of a vehicle door completely. This corresponds with pressing the button  on the remote control.

Locking

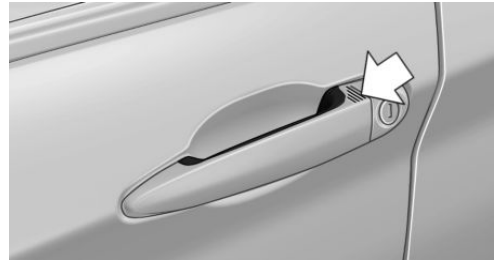

Touch the surface on the handle of a vehicle door with your finger for approx. 1 second without grasping the door handle.

This corresponds with pressing the button  on the remote control.

Convenient closing

Safety information



WARNING

With convenient closing, body parts can be jammed. There is a risk of injury. Make sure that the area of movement of the doors is clear during convenient closing. ◀

Closing

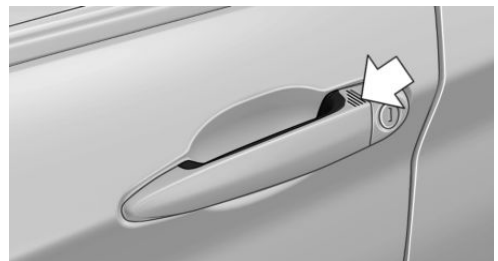

Touch the surface on the handle of a vehicle door, arrow, with your finger and hold it there without grasping the door handle.

This corresponds with pressing and holding the button  on the remote control.

In addition to locking, the windows and the glass sunroof close and the exterior mirrors fold in.

Opening the tailgate

General information

To avoid locking it in the vehicle, do not place the remote control in the cargo area.

If the remote control is in the sensor area, the tailgate may open or close inadvertently if you unintentionally move your foot or if something else moves in the detection area.

The sensor has an approximate range of 5 ft/1.50 m extending from the rear of the vehicle.

If the tailgate is opened via Comfort Access, locked doors are not unlocked.

Safety information



WARNING

Body parts can be jammed when operating the tailgate. There is a risk of injury. Make sure that the area of movement of the tailgate is clear during opening and closing. ◀



NOTE

The tailgate swings back and up when it opens. There is a risk of property damage. Make sure that the area of movement of the tailgate is clear during opening and closing. ◀



NOTE

Sharp-edged or pointed objects can hit the rear window and heat conductors while driving. There is a risk of property damage. Cover the edges and ensure that pointed objects do not hit the rear window. ◀

Opening



Press button next on tailgate.

The tailgate opens automatically.

Opening and closing the tailgate with no-touch activation

Concept

The tailgate can be opened and closed with no-touch activation using the remote control you are carrying. Two sensors detect a forward-directed foot motion in the center of the area at the rear of the vehicle and the tailgate is opened or closed.

General information

To avoid locking it in the vehicle, do not place the remote control in the cargo area.

If the remote control is in the sensor area, the tailgate can be opened or closed inadvertently by an unconscious or alleged recognized foot movement.

The sensor has an approximate range of 5 ft/1.50 m extending from the rear of the vehicle.

If the tailgate is opened with no-touch activation, locked doors are not unlocked.

Safety information



WARNING

During no-touch activation, vehicle parts may be touched, e.g., hot exhaust system. There is a risk of injury. When moving your

foot, make sure you have a firm stance and do not touch the vehicle. ◀



WARNING

Body parts can be jammed when operating the tailgate. There is a risk of injury. Make sure that the area of movement of the tailgate is clear during opening and closing. ◀



NOTE

The tailgate swings back and up when it opens. There is a risk of property damage. Make sure that the area of movement of the tailgate is clear during opening and closing. ◀

Performing the foot movement

1. Stand in the middle behind the vehicle at about an arm's length away from the rear of the vehicle.
2. Wave a foot under the vehicle in the direction of travel and immediately pull it back. With this movement, the leg must pass through the ranges of both sensors.

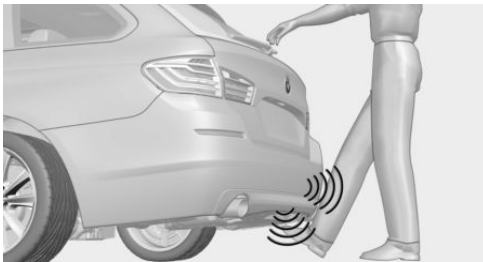

Opening

Perform the foot movement described earlier. The tailgate is opened.

Before the opening, the hazard warning system flashes.

Closing

Perform the foot movement described earlier. The hazard warning system flashes on and an acoustic signal sounds before the tailgate closes.

You can interrupt the closing operation by moving your foot again.

Malfunction

Remote control detection by the vehicle may malfunction under the following circumstances:

- ▷ The battery of the remote control is discharged. Replace the battery, refer to page 36.
- ▷ Interference of the radio connection from transmission towers or other equipment with high transmitting power.
- ▷ Shielding of the remote control due to metal objects.
 - Do not transport the remote control together with metal objects.
- ▷ Interference of the radio connection from mobile phones or other electronic devices in direct proximity to the remote control.
 - Do not transport the remote control together with electronic devices.

In the case of a malfunction, unlock and lock the vehicle using the buttons of the remote control or using the integrated key, refer to page 37.

Tailgate

General information

To avoid locking it in the vehicle, do not place the remote control in the cargo area.

Depending on your vehicle's equipment and the country version, it is possible to specify whether the doors are also unlocked when unlocking with the remote control. Adjusting the settings, refer to page 46.

Safety information



WARNING

Body parts can be jammed when operating the tailgate. There is a risk of injury. Make sure that the area of movement of the tailgate is clear during opening and closing. ◀



NOTE

The tailgate swings back and up when it opens. There is a risk of property damage. Make sure that the area of movement of the tailgate is clear during opening and closing. ◀



NOTE

Sharp-edged or pointed objects can hit the rear window and heat conductors while driving. There is a risk of property damage. Cover the edges and ensure that pointed objects do not hit the rear window. ◀

Opening and closing

Opening

General information

When towing a trailer, the tailgate cannot be opened with the remote control or with the button in the driver's door.

Adjusting the opening height

You can set how far the tailgate should open.

When adjusting the opening height, ensure that there is a clearance of at least 4 in/10 cm above the tailgate.

1. "Settings"
2. "Tailgate"
3. Turn the controller until the desired opening height is selected.
4. Press the controller.

From the outside



- ▷ Without Comfort Access: unlock vehicle.
With Comfort Access: unlock the vehicle or have the remote control with you.
Press the button on tailgate's exterior.
- ▷  Press button on the remote control for approx. 1 second.

If the vehicle is stationary, the tailgate opens automatically to the adjusted opening height.

From the inside



Press button in the driver's door.

If the vehicle is locked, selector lever position P must be engaged first.

If the vehicle is stationary, the tailgate opens automatically to the adjusted opening height.

Canceling the opening operation

The opening procedure is interrupted in the following situations:

- ▷ When the vehicle starts moving.
- ▷ By pressing the button on the outside of the tailgate.
- ▷ By pressing the button on the inside of the tailgate.
- ▷ By pressing the button on the remote control.
- ▷ By pressing or pulling the button in the driver's door.

Closing

From the outside

Press the button on tailgate's exterior.

From the inside



Pull and hold the button in the driver door.

The remote control must be located in the interior for this function.

From inside the tailgate

Without Comfort Access:

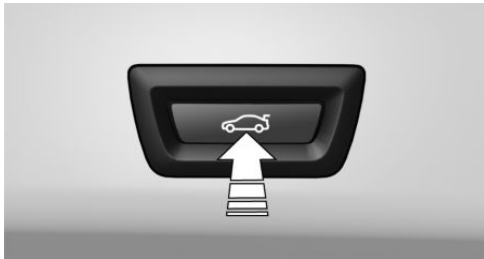

Press button on the inside of the tailgate.

With Comfort Access:



- Press button, arrow 1, on the inside of the tailgate.
- Press button, arrow 2.

The vehicle will be locked after closing the tailgate. The driver's door must be closed for this purpose and the remote control must be outside of the vehicle in the area of the tailgate.

Canceling the closing operation

The closing procedure is interrupted in the following situations:

- If the vehicle starts off with a jerky movement.
- By pressing the button on the outside of the tailgate.
- By pressing the button on the inside of the tailgate.
- By releasing the button in the driver's door.

Malfunction

Safety information



WARNING

With manual operation of a blocked tailgate, it can release itself unexpectedly from the blockage. There is a risk of injury or risk of property damage. Do not operate the tailgate manually if it is blocked. Have it checked by a dealer's service center or another qualified service center or repair shop. ◀

Manual operation

Operate the unlocked tailgate manually with a slow and smooth motion.

To close the tailgate fully, press down lightly only. Closing occurs automatically.

Automatic Soft Closing

Safety information



WARNING

Body parts can be jammed while operating the doors. There is a risk of injury. Make sure that the area of movement of the doors is clear during opening and closing. ◀

Closing

Push the doors and, if applicable, the tailgate lightly.

The closing happens automatically.

Personal Profile

Concept

Via Personal Profiles, individual settings for several drivers can be stored and called up again when required.

General information

There are three driver profiles with which personal vehicle settings can be stored. Every remote control has one of these driver profiles assigned.

If the vehicle is unlocked using a remote control, the assigned personal driver profile will be activated. All settings stored in the driver profile are automatically applied.

If several drivers use their own remote control, the vehicle will adjust the personal settings during unlocking. These settings are also re-stored, if the vehicle has been used in the meantime by a person with a different remote control.

Changes to the settings are automatically saved in the driver profile currently activated.

If another driver profile is selected via iDrive, the settings saved in it will be applied automatically. The new driver profile is assigned to the remote control currently used.

There is an additional guest profile available that is not assigned to any remote control: it can be used to apply settings in the vehicle without changing the personal driver profiles.

Functional requirements

For the system to be able to identify the driver profile associated to a particular driver, the detected remote control must be clearly allocated to the driver.

This is the case when:

- ▶ The driver is only carrying his or her own remote control.
- ▶ The driver unlocks the vehicle.
- ▶ The driver gets into the vehicle through the driver's door.

Settings

The settings for the following systems and functions are saved in the active profile. The scope of storable settings depends on country and equipment.

- ▶ Unlocking and locking.
- ▶ Lights.
- ▶ Climate control.
- ▶ Radio.
- ▶ Instrument cluster.
- ▶ Programmable memory buttons.
- ▶ Volumes, tone.
- ▶ Control Display.
- ▶ Navigation.
- ▶ Park Distance Control PDC.
- ▶ Rearview camera.
- ▶ Side View.
- ▶ Top View.
- ▶ Head-up Display.
- ▶ Driving Dynamics Control.
- ▶ Driver's seat position, exterior mirror position, steering wheel position.
- ▶ Intelligent Safety.
- ▶ Active Blind Spot Detection.
- ▶ Night vision.

Profile management

Opening profiles

Regardless of the remote control in use, a different profile may be activated. This allows you to call up personal vehicle settings if you did not unlock the vehicle with your own remote control.

Using iDrive:

1. "Settings"
2. "Profiles"
3. Select a profile.
 - ▷ All settings stored in the called-up profile are automatically applied.
 - ▷ The called-up profile is assigned to the remote control being used at the time.
 - ▷ If the profile is already assigned to a different remote control, this profile will apply to both remote controls.

Using a guest profile

The guest profile is for individual settings that are stored in none of the three personal profiles.

This can be useful for drivers who are using the vehicle temporarily and do not have their own profile.

Using iDrive:

1. "Settings"
2. "Profiles"
3. "Guest"

The guest profile cannot be renamed. It is not assigned to the current remote control.

Renaming profiles

A personal name can be assigned to every profile to avoid confusion between the profiles.

Using iDrive:

1. "Settings"
2. "Profiles"
 - The active profile is selected.
3. Open "Options".
4. "Rename current profile"

Reset profiles

The settings of the active profile are reset to their factory settings.

Using iDrive:

1. "Settings"
2. "Profiles"
3. Open "Options".
4. "Reset current profile"

Exporting profiles

Most settings of the active profile can be exported.

This can be helpful for saving and retrieving personal settings, for instance before delivering the vehicle to a workshop. Profiles can be taken to another vehicle equipped with the Personal Profile function.

Using iDrive:

1. "Settings"
2. "Profiles"
3. "Export profile"
4. BMW Online: "BMW Online"
USB interface: "USB device"

Importing profiles

Profiles exported via BMW Online can also be imported via BMW Online.

Profiles stored on a USB storage device can be imported via the USB interface.

Existing settings are overwritten with the imported profile.

Using iDrive:

1. "Settings"
2. "Profiles"
3. "Import profile"
4. BMW Online: "BMW Online"
USB interface: "USB device"

Display profile list during start

The profile list can be displayed during each start to select the desired profile.

Using iDrive:

1. "Settings"
2. "Profiles"
3. Open "Options".
4. "Display user list at startup"

System limits

A clear assignment between the remote control and driver may not be possible in the following cases, for example.

- ▷ The passenger unlocks the vehicle with his or her own remote control, but another person is driving.
- ▷ The driver unlocks the vehicle via Comfort Access and has multiple remote controls with him or her.
- ▷ The driver changes, but the vehicle is not locked and unlocked.
- ▷ Multiple remote controls are located outside of the vehicle.

Settings

General information

Depending on the equipment and country-specific variant of your vehicle, different opening and closing settings are available.

These settings are saved in the active driver profile, refer to page 44.

Unlocking

Doors

Using iDrive:

1. "Settings"
2. "Doors/key"
3.  Select the symbol.
4. Select the desired function:
 - ▷ "Driver's door only"

Only the driver's door and the fuel filler flap are unlocked. Pressing again unlocks the entire vehicle.

- ▷ "All doors"

The entire vehicle is unlocked.

Tailgate

Using iDrive:

1. "Settings"
2. "Doors/key"
3.  Select the symbol.
4. Select the desired function:
 - ▷ "Tailgate"
The tailgate is opened.
 - ▷ "Tailgate + door(s)"
The tailgate is opened and the doors unlocked.

Confirmation signals from the vehicle

Using iDrive:

1. "Settings"
2. "Doors/key"
3. Deactivate or activate the desired confirmation signals.
 - ▷ With alarm system:
 - "Acoustic sig. lock/unlock"
Unlocking is signaled by one honk of the horn.
 - ▷ "Flash when lock/unlock"
Unlocking is signaled by two flashes, locking by one.

Automatic locking

Using iDrive:

1. "Settings"
2. "Doors/key"
3. Select the desired function:
 - ▷ "Lock if no door is opened"

The vehicle locks automatically after a short period of time if no door is opened after unlocking.

- ▶ "Lock after start driving"

The vehicle locks automatically after you drive off.

Adjusting the last seat, mirror, and steering wheel position

Using iDrive:

1. "Settings"
2. "Doors/key"
3. "Last seat position autom."

When the vehicle is unlocked, the driver's seat, exterior mirrors and steering wheel resume their last set positions.

Alarm system

General information

When the vehicle is locked, the vehicle alarm system reacts to the following changes:

- ▶ Unauthorized opening of a door, the hood or the tailgate.
- ▶ Movements in the interior.
- ▶ Changes in the vehicle tilt, e. g., during attempts at stealing a wheel or when towing the vehicle.
- ▶ Disconnected battery voltage.
- ▶ Improper use of the socket for Onboard Diagnosis.

The alarm system signals these changes visually and acoustically:

- ▶ Acoustic alarm.
- ▶ By switching on the hazard warning system.
- ▶ By flashing the daytime running lights.

Switching on and off

When you lock and unlock the vehicle with the remote control or with Comfort Access, the alarm system is switched on and off at the same time.

Opening the doors with the alarm system switched on

The alarm system is triggered when a door is opened if the door was unlocked using the integrated key in the door lock.

Switching off the alarm, refer to page 48.

Opening the tailgate with the alarm system switched on

The tailgate can be opened even when the alarm system is switched on.

After the tailgate is closed, it is locked and monitored again provided the doors are locked. The hazard warning system flashes once.

Panic mode

You can trigger the alarm system if you find yourself in a dangerous situation.



Press button on the remote control for at least 3 seconds.

To switch off the alarm: press any button.

Indicator light on the interior mirror

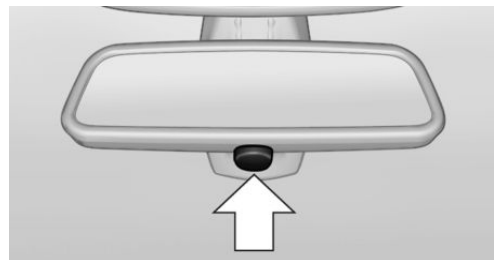

- ▶ The indicator light flashes briefly every 2 seconds:
The alarm system is switched on.

- ▷ Indicator light flashes for approx. 10 seconds, then it flashes briefly every 2 seconds:
Interior motion sensor and tilt alarm sensor are not active, as doors, hood, or tailgate are not correctly closed. Correctly closed access points are secured.
When the still open access points are closed, interior motion sensor and tilt alarm sensor will be switched on.
- ▷ The indicator light goes out after unlocking:
The vehicle has not been tampered with.
- ▷ The indicator light flashes after unlocking until the engine ignition is switched on, but no longer than approx. 5 minutes:
An alarm has been triggered.

Tilt alarm sensor

The tilt of the vehicle is monitored.

The alarm system responds in situations such as attempts to steal a wheel or when the vehicle is towed.

Interior motion sensor

The windows and the glass sunroof must be closed for the system to function properly.

Avoiding unintentional alarms

General information

The tilt alarm sensor and interior motion sensor can trigger an alarm, although no unauthorized action occurred.

Possible situations for an unwanted alarm:

- ▷ In automatic vehicle washes.
- ▷ In duplex garages.
- ▷ During transport on trains carrying vehicles, at sea or on a trailer.
- ▷ With animals in the vehicle.

The tilt alarm sensor and the interior motion sensor can be switched off in such situations.

Switching off the tilt alarm sensor and interior motion sensor



Press the remote control button again within 10 seconds as soon as the vehicle is locked.

The indicator lamp lights up for approx. 2 seconds and then continues to flash.

The tilt alarm sensor and interior motion sensor are turned off until the vehicle is locked again.

Switching off the alarm

- ▷ Unlock the vehicle with the remote control or switch on the ignition, if needed through emergency detection of remote control, refer to page 36.
- ▷ With Comfort Access:

If you are carrying the remote control on your person, grasp the door handle on the driver's or front passenger door completely.

Power windows

Safety information



WARNING

When operating the windows, body parts and objects can be jammed. There is a risk of injury or risk of property damage. Make sure that the area of movement of the windows is clear during opening and closing. ◀



WARNING

Unattended children or animals can cause the vehicle to move and endanger themselves and traffic, e.g., due to the following actions:

- ▷ Pressing the Start/Stop button.
- ▷ Releasing the parking brake.
- ▷ Opening and closing the doors or windows.

- ▷ Engaging selector lever position N.
- ▷ Using vehicle equipment.

There is a risk of accidents or injuries. Do not leave children or animals unattended in the vehicle. Take the remote control with you when exiting and lock the vehicle. ◀

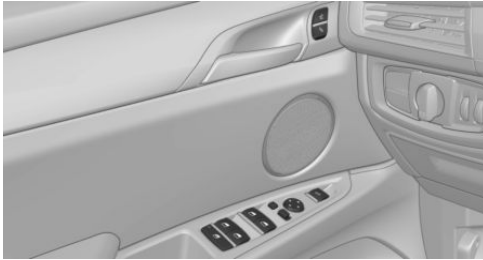

Overview



 Power windows

 Safety switch

Opening

- ▷  Press the button to the resistance point.
The window opens while the switch is being held.
- ▷  Press the switch beyond the resistance point.
The window opens automatically. Pressing the switch again stops the motion.

Convenient opening via the remote control, refer to page 35.

Closing

- ▷  Pull the switch to the resistance point.
The window closes while the switch is being held.

- ▷  Pull the switch beyond the resistance point.
The window closes automatically. Pulling again stops the motion.

Closing by means of Comfort Access, refer to page 39.

Pinch protection system

General information

If closing force exceeds a specific threshold as a window closes, closing is interrupted.



The window opens slightly.

Safety information

 **WARNING**
Accessories on the windows such as antennas can impact jam protection. There is a risk of injury. Do not install accessories in the area of movement of the windows. ◀

Closing without the jam protection system

In case of danger from the outside or if ice might prevent normal closing, proceed as follows:

1.  Pull the switch past the resistance point and hold it there.
The window closes with limited jam protection . If the closing force exceeds a specific threshold, closing is interrupted.
2.  Pull the switch past the resistance point again within approx. 4 seconds and hold it there.
The window closes without jam protection .

Safety switch

General information

The safety switch in the driver's door can be used to prevent children, for instance from opening and closing the rear windows using the switches in the rear.

If an accident of a certain severity occurs, the safety function is switched off automatically.

Switching on and off



Press button.

The LED lights up if the safety function is switched on.

Roller sunblinds

Roller sunblinds for the rear side windows

Pull out the roller sunblind at the loop and hook it onto the bracket.



WARNING

With closed roller sunblinds and open windows, the roller sunblinds can be loaded heavily while driving due to the wind. The roller sunblinds can be damaged and compromise the passengers. There is risk of injuries. Do not open the windows while driving if the roller sunblinds are closed. ◀

Glass sunroof, electric

General information

The glass sunroof and the sliding visor can be operated together or separately using the same switch.

The glass sunroof is operational when the ignition is switched on.

Safety information



WARNING

Body parts can be jammed when operating the glass sunroof. There is a risk of injury. Make sure that the area of movement of the glass sunroof is clear during opening and closing. ◀



WARNING

Unattended children or animals can cause the vehicle to move and endanger themselves and traffic, e.g., due to the following actions:

- ▷ Pressing the Start/Stop button.
- ▷ Releasing the parking brake.
- ▷ Opening and closing the doors or windows.
- ▷ Engaging selector lever position N.
- ▷ Using vehicle equipment.

There is a risk of accidents or injuries. Do not leave children or animals unattended in the vehicle. Take the remote control with you when exiting and lock the vehicle. ◀

Overview



Tilting up and closing the tilted glass sunroof



Push switch briefly upward.

- ▷ The closed glass sunroof tilts and the sliding visor opens slightly.

- ▶ The opened glass sunroof closes until it is in the tilted position. The sliding visor does not move.
- ▶ The tilted glass sunroof closes. The sliding visor does not move.

Opening/closing the glass sunroof and sliding visor separately

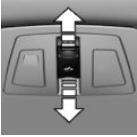

- ▶ Press the switch in the desired direction to the resistance point and hold it there.

The sliding visor opens while the switch is being held. If the sliding visor is already fully open, the glass sunroof opens.

The glass sunroof closes while the switch is being held. If the glass sunroof is already closed or in the tilted position, the sliding visor closes.

- ▶ Press the switch in the desired direction past the resistance point.

The sliding visor opens automatically. If the sliding visor is already fully open, the glass sunroof opens automatically.

The glass sunroof closes automatically. If the glass sunroof is already closed or in the tilted position, the sliding visor closes automatically.

Pressing the switch upward stops the motion.

Opening/closing the glass sunroof and sliding visor together



Briefly press the switch twice in succession in the desired direction past the resistance point.

The glass sunroof and sliding visor move together. Pressing the

switch upward stops the motion.

Convenient opening via the remote control, refer to page 35.

Closing by means of Comfort Access, refer to page 39.

Comfort position

If the glass sunroof is not completely opened automatically, the comfort position has been attained. In this position the wind noises in the interior are the least.

If desired, continue the movement by pressing the switch.

Jam protection system

General information

If the closing force when closing the glass sunroof exceeds a certain value, the closing movement is stopped, beginning at approximately the middle of the opening in the roof, or from the tilted position during closing. The glass sunroof opens slightly.

Closing from the open position without jam protection

If there is an external danger, proceed as follows:

1. Push the switch forward past the resistance point and hold.

The glass sunroof closes with limited jam protection. If the closing force exceeds a specific threshold, closing is interrupted.

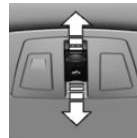

2. Push the switch forward again past the resistance point and hold until the glass sunroof closes without jam protection. Make sure that the closing area is clear.

Closing from the raised position without jam protection

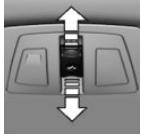

If there is an external danger, push the switch forward past the resistance point and hold it.

The glass sunroof closes without jam protection.

Initializing after a power interruption

General information

After a power failure during the opening or closing process, the glass sunroof can only be operated to a limited extent.

The system can be initialized under the following conditions.

- ▷ The vehicle is parked in a horizontal position.
- ▷ The engine is running.
- ▷ The external temperature is above 41 °F/5 °C.

During initialization, the glass sunroof closes without jam protection.

Make sure that the closing area is clear.

Initializing the system



Press the switch up and hold it until the initialization is complete:

Initialization begins within 15 seconds and is completed

when the glass sunroof and sliding visor are completely closed.

Settings

Vehicle features and options

This chapter describes all standard, country-specific and optional features offered with the series. It also describes features that are not necessarily available in your vehicle, e. g., due to the selected options or country versions. This also applies to safety-related functions and systems. When using these functions and systems, the applicable laws and regulations must be observed.

Sitting safely

An ideal seating position that meets the needs of the occupants can make a vital contribution to relaxed, fatigue-free driving.

In the event of an accident, the correct seating position plays an important role. Additionally, observe the following chapters for safe driving:

- ▷ Safety belts, refer to page 57.
- ▷ Head restraints, refer to page 58.
- ▷ Airbags, refer to page 111.

Front seats

Safety information

WARNING
Seat adjustments while driving can lead to unexpected movements of the seat. Vehicle control could be lost. There is a risk of an accident. Only adjust the seat on the driver's side when the vehicle is stationary. ◀

WARNING
With a backrest inclined too far to the rear, the protective effect of the safety belt cannot be ensured anymore. There is a risk of sliding under the safety belt in an accident. There is a risk of injuries or danger to life. Ad-

just the seat prior to starting the trip. Adjust the backrest so that it is in the most upright position as possible and do not adjust again while driving. ◀

WARNING
There is a risk of jamming when moving the seats. There is a risk of injury or risk of property damage. Make sure that the area of movement of the seat is clear prior to any adjustment. ◀

Electrically adjustable seats

Overview

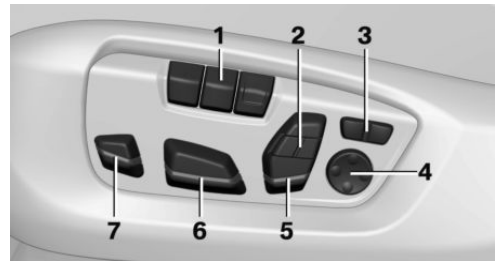

- 1 Memory function
- 2 Upper backrest adjustment
- 3 Backrest width
- 4 Lumbar support
- 5 Backrest tilt, head restraint
- 6 Forward/backward, height, seat tilt
- 7 Thigh support

General information

The seat setting for the driver's seat is stored for the profile currently used. When the vehicle is unlocked via the remote control, the position is automatically retrieved if the function, refer to page 47, is activated for this purpose.

Forward/backward

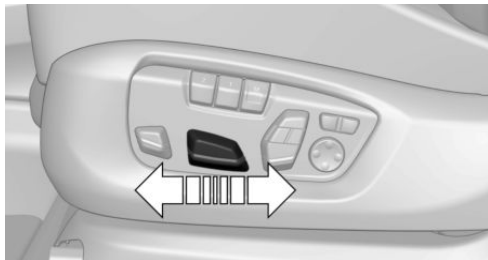

Push switch forward or backward.

Backrest tilt

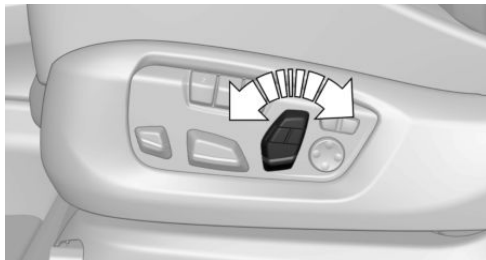

Move switch forward or backward.

Height

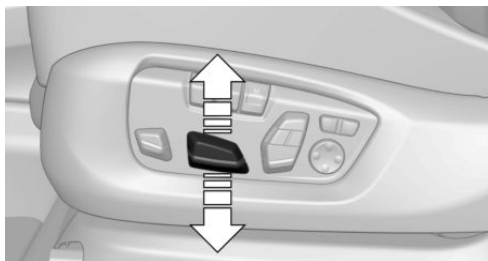

Push switch up or down.

Thigh support

Multifunctional seat

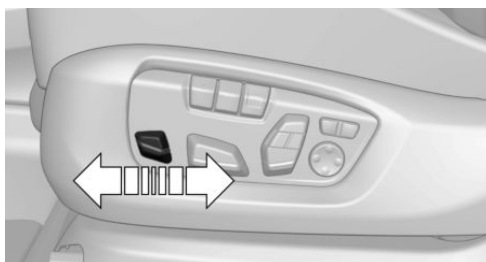

Push switch forward or backward.

Seat tilt



Move switch up or down.

Sport seat

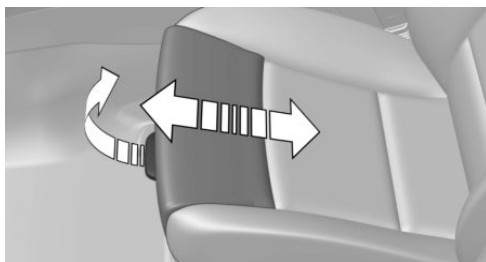

Pull the lever at the front of the seat and adjust the thigh support.

Lumbar support

The curvature of the seat backrest can be adjusted in a way that it supports the lumbar re-

gion of the spine. The lower back and the spine are supported for upright posture.



- ▶ Press the front/rear section of the switch:
The curvature is increased/decreased.
- ▶ Press the upper/lower section of the switch:
The curvature is shifted up/down.

Backrest width

To adjust the lateral support, the width of the backrest can be changed using the side wings.



Press button on the corresponding side

Upper backrest adjustment



The upper backrest additionally supports the back in the shoulder area:

- ▶ Results in a relaxed seating position.
- ▶ Reduces strain on the shoulder muscles.

Press button on the corresponding side.

Front seat heating

Overview



 Seat heating

Switching on

 Press button once for each temperature level.

The maximum temperature is reached when three LEDs are lit.

If the trip is continued within approx. 15 minutes after a stop, seat heating is activated automatically with the temperature selected last.

When ECO PRO is activated, the heater output is reduced.

Switching off

 Press and hold the button, until the LEDs go out.

Temperature distribution

The heating action in the seat cushion and backrest can be distributed in different ways.

About iDrive:

1. "Climate"
2. "Front seat heating"
3. Select desired seat.
4. Turn the Controller to set the temperature distribution.

Active seat ventilation, front

The concept

The seat cushion and backrest surfaces are cooled by means of integrated fans.

The ventilation cools the seat, e.g., if the vehicle interior is overheated or for continuous cooling at high temperatures.

Overview



Active seat ventilation

Switching on



Press button once for each ventilation level.

The highest level is active when three LEDs are lit.

The ventilation switches back by one level after a short time.

Switching off



Press and hold the button, until the LEDs go out.

Rear seats

Second row of seats

Safety information



WARNING

There is a risk of jamming when folding down the center armrest in the rear. There is a risk of injury. Make sure that the area of movement of the center armrest is clear during folding down. ◀

Rear seat heating

Overview



Seat heating

Switching on



Press button once for each temperature level.

The maximum temperature is reached when three LEDs are lit.

If the trip is continued within approx. 15 minutes after a stop, seat heating is activated automatically with the temperature selected last.

When ECO PRO is activated, the heater output is reduced.

Switching off



Press and hold the button, until the LEDs go out.

Safety belts

Number of safety belts

The vehicle is fitted with five safety belts to ensure occupant safety. However, they can only offer protection when adjusted correctly.

The two outer safety belt buckles of the rear seat are intended for the persons sitting on the left and right.

The center safety belt buckle of the rear seat is intended for the person sitting in the middle.

General information

Always make sure that safety belts are being worn by all occupants before driving off. Although airbags enhance safety by providing added protection, they are not a substitute for safety belts.

Slowly guide the safety belt out of the holder when fastening it.

The upper shoulder strap's anchorage point will be correct for adult seat occupants of every build if the seat is correctly adjusted.

Safety information



WARNING

If the safety belt is used to buckle more than one person, the protective effect of the safety belt can no longer be ensured. There is a risk of injuries or danger to life. Do not allow more than one person to wear a single safety belt. Infants and children are not allowed on an occupant's lap, but must be transported and secured in designated child restraint systems. ◀



WARNING

The protective effect of the safety belts can be limited or lost when safety belts are fastened incorrectly. An incorrectly fastened safety belt can cause additional injuries, e.g., in the event of an accident or during braking and evasive maneuvers. There is a risk of injuries or

danger to life. Make sure that all occupants are wearing safety belts correctly. ◀



WARNING

With a rear backrest that is not locked, the protective function of the middle safety belt is not guaranteed. There is a risk of injuries or danger to life. If you are using the middle safety belt, lock the wider rear backrest. ◀



WARNING

The protective effect of the safety belts may not be fully functional or fail in the following situations:

- ▷ Safety belts are damaged, soiled or changed in any other way.
- ▷ Safety belt buckle is damaged or heavily soiled.
- ▷ Belt tensioners or belt retractors were modified.

Safety belts can be imperceptibly damaged in the event of an accident. There is a risk of injuries or danger to life. Do not modify safety belts, safety belt buckles, belt tensioners, belt retractors or belt anchors and keep them clean. Have the safety belts checked after an accident at the dealer's service center or another qualified service center or repair shop. ◀

Correct use of safety belts

- ▷ Wear the safety belt twist-free and as tight to your body as possible over your lap and shoulders.
- ▷ Wear the safety belt deep on your hips over your lap. The safety belt may not press on your stomach.
- ▷ Do not rub the safety belt against sharp edges, or guide it or jam it in across hard or fragile objects.
- ▷ Avoid thick clothing.
- ▷ Re-tighten the safety belt frequently upward around your upper body.

Buckling the safety belt

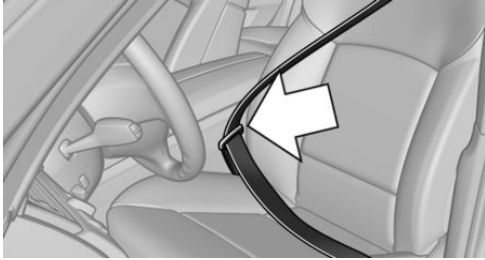

Make sure you hear the latch plate engage in the belt buckle.

To ease accessibility to the seat belt buckle, an adjustable slider is available on the belt to help position the buckle when not in use.

Tensioning the safety belt automatically

When the safety belt is buckled, the belt strap is automatically tightened once after the vehicle drove off.

Unbuckling the safety belt

1. Hold the safety belt firmly.
2. Press the red button in the belt buckle.
3. Guide the safety belt back into its roll-up mechanism.

Safety belt reminder for driver's and passenger's seat



The indicator lamp lights up and a signal sounds. Make sure that the safety belts are positioned correctly. The safety belt reminder is active at speeds above approx. 6 mph/10 km/h. It can also be activated if objects are placed on the front passenger seat.

Safety mode

In critical situations, for example during an emergency stop, the front safety belts tighten automatically.

If the situation passes without an accident occurring, the belt tension relaxes.

If the belt tension does not loosen automatically, stop the vehicle and unbuckle the safety belt using the red button in the buckle. Fasten the safety belt before continuing on your trip.

Front head restraints

Safety information



WARNING

A missing protective effect due to removed or not correctly adjusted head restraints can cause injuries in the head and neck area. There is a risk of injury. Before driving, install the head restraints on the occupied seats. Ensure that the middle of the head restraint supports the back of the head approximately at eye level. ◀



WARNING

Body parts can be jammed when moving the head restraint. There is a risk of injury. Make sure that the area of movement is clear when moving the head restraint. ◀



WARNING

Objects on the head restraint reduce the protective effect in the head and neck area. There is a risk of injury.

- ▷ Do not use seat or head restraint covers.
- ▷ Do not hang objects, e.g., clothes hangers, directly on the head restraint.
- ▷ Only use accessories that have been determined to be safe for attachment to a head restraint.
- ▷ Do not use any accessories, e.g., pillows, while driving. ◀

Correctly adjusted head restraint

General information

A correctly adjusted head restraint reduces the risk of injury to cervical vertebrae in the event of an accident.

Height

Adjust the head restraint so that its center is approximately at eye level.

Distance

Adjust the distance so that the head restraint is as close as possible to the back of the head.

Active head restraint

In the event of a rear-end collision with a certain severity, the active head restraint automatically reduces the distance from the head.

In the event of wear and tear due to an accident, or if otherwise damaged, have the active head restraint checked and if necessary replaced

Adjusting the height: electrical head restraints

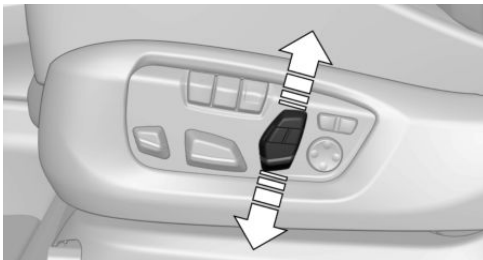

Push switch up or down.

Distance to the back of the head: electrical head restraints

The head restraint is automatically repositioned when the upper backrest is adjusted.

Adjusting the side extensions

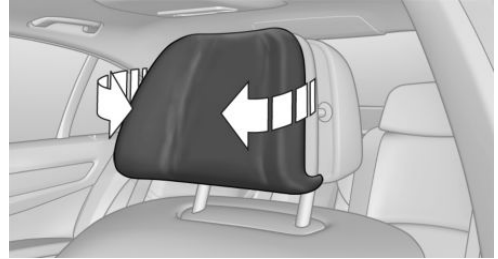

Fold the side extensions on the head restraint forward for increased lateral support in the resting position.

Removing

The head restraints cannot be removed.

Memory function

Concept

The following settings can be stored and, if necessary, retrieved using the memory function:

- ▷ Driver's seat position.
- ▷ Exterior mirror position.
- ▷ Steering wheel position.
- ▷ Height of the Head-up Display.

General information

Two memory locations with different settings can be set for each driver profile, refer to page 44.

Settings for the backrest width and lumbar support are not stored in memory.

Safety information



WARNING

Using the memory function while driving can lead to unexpected seat or steering wheel movements. Vehicle control could be lost. There is a risk of an accident. Only retrieve the

memory function when the vehicle is stationary. ◀



WARNING

There is a risk of jamming when moving the seats. There is a risk of injury or risk of property damage. Make sure that the area of movement of the seat is clear prior to any adjustment. ◀

Overview



Storing

1. Switch on the ignition.
2. Set the desired position.
3.  Press button. The LED in the button lights up.
4. Press selected button 1 or 2 while the LED is lit. The LED goes out.

 Button was pressed inadvertently:
Press button again.

The LED goes out.

Calling up settings

The stored position is called up automatically. Press selected button 1 or 2.

While driving, the seat position adjustment on the driver's side is interrupted after a short time.

The procedure stops when a switch for setting the seat or one of the memory buttons is pressed.

Calling up of a seat position deactivated

After a brief period, calling up stored seat positions is deactivated to save battery power.

To reactivate calling up of a seat position:

- ▷ Open or close the door or tailgate.
- ▷ Press a button on the remote control.
- ▷ Press the Start/Stop button.

Mirrors

Exterior mirrors

General information

The mirror on the passenger side is more curved than the driver's side mirror.

The mirror setting is stored for the driver profile currently in use. When the vehicle is unlocked via the remote control, the position is automatically retrieved if the function, refer to page 47, is activated for this purpose.

Safety information



WARNING

Objects reflected in the mirror are closer than they appear. The distance to the traffic behind could be incorrectly estimated, e.g., while changing lanes. There is a risk of an accident. Estimate the distance to the traffic behind by looking over your shoulder. ◀

Overview



- 1 Settings 61
- 2 Left/right, Automatic Curb Monitor
- 3 Folding in and out 61

Selecting a mirror



To change over to the other mirror:
Slide the switch.

Adjusting electrically



Press button.

The mirror movement follows the button movement.

Saving positions

The current exterior mirror position can be stored using the memory function, refer to page 59.

Adjusting manually

In case of an electrical malfunction, press the edges of the mirror.

Automatic Curb Monitor

Concept

If reverse gear is engaged, the mirror glass on the front passenger side is tilted downward. This improves your view of the curb and other low-lying obstacles when parking, e.g.

Activating

1.  Slide the switch to the driver's side mirror position.
2. Engage selector lever position R.

Deactivating

Slide the switch to the passenger side mirror position.

Folding in and out



NOTE

Depending on the vehicle width, the vehicle can be damaged in vehicle washes. There is a risk of property damage. Before washing, fold in the mirrors by hand or with the button. ◀



Press button.

Possible at speeds up to approx. 15 mph/20 km/h.

Fold the mirrors in and out is advantageous in the following situations:

- ▷ In vehicle washes.
- ▷ On narrow roads.
- ▷ For folding mirrors back out that were folded away manually.

Mirrors that were folded in are folded out automatically at a speed of approx. 25 mph/40 km/h.

Automatic heating

Both exterior mirrors are automatically heated whenever the engine is running.

Automatic dimming feature

The exterior mirror on the driver's side is automatically dimmed. Photocells in the interior mirror are used to control this.

Interior mirror, automatic dimming feature

Overview

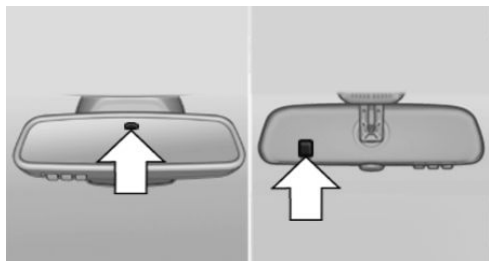

Photocells are used for control:

- ▷ In the mirror glass.
- ▷ On the back of the mirror.

Functional requirements

- ▷ Keep the photocells clean.
- ▷ Do not cover the area between the inside rearview mirror and the windshield.

Steering wheel

Safety information



WARNING

Steering wheel adjustments while driving can lead to unexpected steering wheel movements. Vehicle control could be lost. There is a risk of an accident. Adjust the steering wheel while the vehicle is stationary only. ◀

Electric steering wheel adjustment

Settings

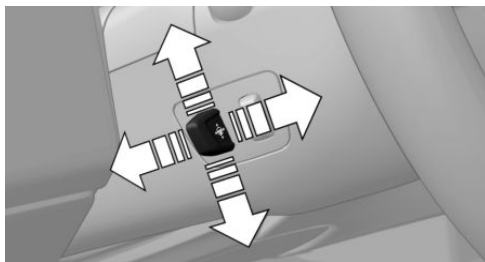

Move the steering wheel to the preferred height and angle to suit your seating position by pressing the switch.

Storing the position

The current steering wheel position can be stored using the memory function, refer to page 59.

Assistance getting in and out

The steering wheel temporarily moves into the highest position to make it easier to enter and exit the vehicle.

Heated steering wheel

Overview



Heated steering wheel

Switching on/off



Press button.

- ▷ On: the LED lights up.
- ▷ Off: the LED goes out.

Transporting children safely

Vehicle features and options

This chapter describes all standard, country-specific and optional features offered with the series. It also describes features that are not necessarily available in your vehicle, e. g., due

to the selected options or country versions. This also applies to safety-related functions and systems. When using these functions and systems, the applicable laws and regulations must be observed.

The right place for children

Safety information



WARNING

Unattended children or animals can cause the vehicle to move and endanger themselves and traffic, e.g., due to the following actions:

- ▶ Pressing the Start/Stop button.
- ▶ Releasing the parking brake.
- ▶ Opening and closing the doors or windows.
- ▶ Engaging selector lever position N.
- ▶ Using vehicle equipment.

There is a risk of accidents or injuries. Do not leave children or animals unattended in the vehicle. Take the remote control with you when exiting and lock the vehicle. ◀

Always transport children in the rear seat

General information

Accident research shows that the safest place for children is in the rear seat.

Transport children younger than 13 years of age or shorter than 5 ft/150 cm only in the rear seat in suitable child restraint systems designed for the age, weight and size of the child. Children 13 years of age or older must wear a safety belt as soon as a suitable child restraint

system can no longer be used due to their age, weight and size.

Safety information



WARNING

The safety belt cannot be fastened correctly on children shorter than 5 ft, 150 cm without suitable additional child restraint systems. The protective effect of the safety belts can be limited or lost when safety belts are fastened incorrectly. An incorrectly fastened safety belt can cause additional injuries, for instance in the event of an accident or during braking and evasive maneuvers. There is a risk of injuries or danger to life. Secure children shorter than 5 ft, 150 cm using suitable child restraint systems. ◀

Children on the front passenger seat

General information

Should it ever be necessary to use a child restraint system in the front passenger seat, make sure that the front, knee and side airbags on the front passenger side are deactivated. Automatic deactivation of front-seat passenger airbags, refer to page 113.

Safety information



WARNING

Active front-seat passenger airbags can injure a child in a child restraint system when the airbags are activated. There is a risk of injury. Make sure that the front-seat passenger airbags are deactivated and that the PASSENGER AIRBAG OFF indicator lamp lights up. ◀



WARNING

The stability of the child restraint system is limited or compromised with incorrect seat adjustment or improper installation of the child seat. There is a risk of injuries or danger to life. Make sure that the child restraint system fits securely against the backrest. If possible, adjust the backrest tilt for all affected backrests and correctly adjust the seats. Make sure that seats and backrests are securely engaged. If possible, adjust the height of the head restraints or remove them. ◀

Installing child restraint systems

General information

Pay attention to the specifications of the child restraint system manufacturer when selecting, installing, and using child restraint systems.

Safety information



WARNING

The stability of the child restraint system is limited or compromised with incorrect seat adjustment or improper installation of the child seat. There is a risk of injuries or danger to life. Make sure that the child restraint system fits securely against the backrest. If possible, adjust the backrest tilt for all affected backrests and correctly adjust the seats. Make sure that seats and backrests are securely engaged. If possible, adjust the height of the head restraints or remove them. ◀

On the front passenger seat

Deactivating airbags



WARNING

Active front-seat passenger airbags can injure a child in a child restraint system when the airbags are activated. There is a risk of injury. Make sure that the front-seat passenger airbags are deactivated and that the PASSENGER AIRBAG OFF indicator lamp lights up. ◀

After installing a child restraint system in the front passenger seat, make sure that the front, knee and side airbags on the front passenger side are deactivated.

Deactivate the front-seat passenger airbags automatically, refer to page 113.

Seat position and height

Before installing a child restraint system, move the front passenger seat as far back as possible and bring it as far up as possible to obtain the best possible position for the belt and to offer optimal protection in the event of an accident.

If the upper anchorage of the safety belt is located in front of the belt guide of the child seat, move the passenger seat carefully forward until the best possible belt guide position is reached.

Backrest width

Adjustable backrest width: before installing a child restraint system in the front passenger seat, open the backrest width completely. Do not change the backrest width again and do not call up a memory position.

Child seat security



The rear safety belts and the front passenger safety belt can be permanently locked to fasten child restraint systems.

LATCH child restraint fixing system

General information

LATCH: Lower Anchors and Tether for Children.

Pay attention to the operating and safety information of the child restraint system manufacturer when installing and using LATCH child restraint fixing systems.

Mounts for the lower LATCH anchors

The lower anchors may be used to attach the CRS to the vehicle seat up to a combined child and CRS weight of 65 lb/30 kg when the child is restrained by the internal harnesses.

Safety information



WARNING

If the LATCH child restraint fixing systems are not correctly engaged, the protective effect of the LATCH child restraint fixing system can be limited. There is a risk of injuries or danger to life. Make sure that the lower anchors are securely engaged and that the LATCH child restraint fixing system fits securely against the backrest. ◀

Locking the safety belt

1. Pull out the belt strap completely.
2. Secure the child restraint system with the safety belt.
3. Allow the belt strap to be pulled in and pull it tight against the child restraint system. The safety belt is locked.

Unlocking the safety belt

1. Unbuckle the belt buckle.
2. Remove the child restraint system.
3. Allow the belt strap to be pulled in completely.

Position



The corresponding symbol shows the mounts for the lower LATCH anchors. Seats equipped with lower anchors are marked with a pair, 2, of LATCH symbols. It is not recommended to use the inner lower anchors of standard outer

LATCH positions to fasten a child restraint system on the middle seat. Use the vehicle seat belt instead for the middle seat.

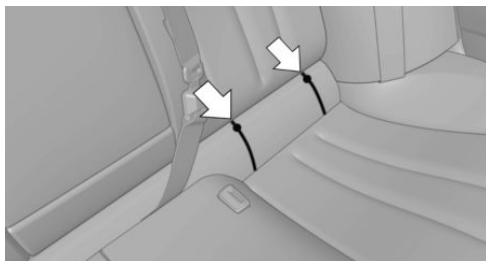

Mounts for the lower LATCH anchors are located behind the seat cover between the backrest and the seat cushion.

Open the zipper to access the anchors.

Before installing LATCH child restraint fixing systems

Pull the safety belt away from the area of the child restraint system.

Assembly of LATCH child restraint fixing systems

1. Install child restraint system, see manufacturer's information.
2. Ensure that both LATCH anchors are properly connected.

Child restraint system with a tether strap

Mounting points



The respective symbol shows the anchor for the upper retaining strap. Seats with an upper top tether are marked with this symbol. It can be found on the rear seat backrest or the rear window shelf.

Safety information



NOTE

The mounting points for the upper retaining straps of child restraint systems are only provided for these retaining straps. When other objects are mounted, the anchors can be damaged. There is a risk of property damage. Only mount child restraint systems to the upper retaining straps. ◀

Retaining strap guide



WARNING

If the upper retaining strap is incorrectly used for the child restraint system, the protective effect can be reduced. There is a risk of injury. Make sure that the upper retaining strap is not guided across sharp edges and without twisting to the upper retaining strap. ◀

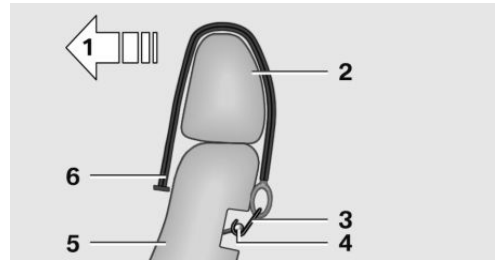

- 1 Direction of travel
- 2 Head restraint
- 3 Hook for upper retaining strap
- 4 Mounting point/eye
- 5 Seat backrest
- 6 Upper retaining strap

Attaching the upper retaining strap to the mounting point

1. Middle seat: raise the head restraint if needed.
2. Outer seats: guide the upper retaining strap over the head restraint.
Middle seat: guide the upper retaining strap between the supports of the head restraint.
3. If there is a retaining strap, run it between the backrest and the cargo cover.
4. Attach the hook of the retaining strap to the mounting eye.
5. Tighten the retaining strap by pulling it down.
6. Middle seat: lower and lock head restraints as needed.

Locking the doors and windows in the rear

Rear doors

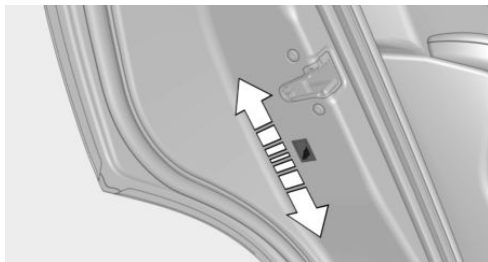

Push the locking lever on the rear doors up.

The door can now be opened from the outside only.

Safety switch for the rear



Press button on the driver's door.

The LED lights up if the safety function is switched on.

This locks various functions so that they cannot be operated from the rear.

Driving

Vehicle features and options

This chapter describes all standard, country-specific and optional features offered with the series. It also describes features that are not necessarily available in your vehicle, e. g., due to the selected options or country versions. This also applies to safety-related functions and systems. When using these functions and systems, the applicable laws and regulations must be observed.

Start/Stop button

Concept



Pressing the Start/Stop button switches the ignition on or off and starts the engine.

The engine starts with the brake pedal pressed when you press the Start/Stop button.

Ignition on

Press the Start/Stop button, and do not press on the brake pedal at the same time.

All vehicle systems are ready for operation.

Most of the indicator and warning lights in the instrument cluster light up for a varied length of time.

To save battery power when the engine is off, switch off the ignition and any unnecessary electronic systems/power consumers.

Ignition off

Press the Start/Stop button again without stepping on the brake.

All indicator lights in the instrument cluster go out.

To save battery power when the engine is off, switch off the ignition and any unnecessary electronic systems/power consumers.

Safety measures

When switching off the ignition, the selector lever position P is selected automatically if the selector lever position D or R is selected.

The ignition is switched off automatically in the following situations while the vehicle is stationary and the engine is off:

- ▷ When locking the vehicle, and when the low beams are activated.
- ▷ Shortly before the battery is discharged completely, so that the engine can still be started.
- ▷ When opening or closing the driver door, if the driver's safety belt is unbuckled and the low beams are switched off.
- ▷ While the driver's safety belt is unbuckled with driver's door open and low beams off.
- ▷ When the front doors are opened if there is no other person sitting in the front seats.

The low beams switch to parking lights after approx. 15 minutes of no use.

Radio ready state

General information

In the radio-ready state, certain power consumers remain ready for operation.

Activating

With the engine running, press the Start/Stop button.

If the engine is not running and the ignition is switched on, the system automatically activates the radio-ready state when the door is opened if the lights are switched off or the daytime running lights are activated.

The radio-ready state remains active if, for instance the ignition is automatically switched off for the following reasons:

- ▷ Opening or closing the driver's door.
- ▷ Unfastening of the driver's safety belt.
- ▷ When automatically switching from low beams to parking lights.

Switching off automatically

The radio-ready state is switched off automatically in the following situations:

- ▷ After approx. 8 minutes.
- ▷ When the vehicle is locked using the central locking system.
- ▷ Shortly before the battery is discharged completely, so that the engine can still be started.

Starting the engine

Safety information



DANGER

If the exhaust pipe is blocked or ventilation is insufficient, harmful exhaust gases can enter into the vehicle. The exhaust gases contain carbon monoxide, an odorless and colorless but highly toxic gas. In enclosed areas, exhaust gases can also accumulate outside of the vehicle. There is danger to life. Keep the exhaust pipe free and ensure sufficient ventilation. ◀



WARNING

An unsecured vehicle can begin to move and possibly roll away. There is a risk of an accident. Before exiting, secure the vehicle against rolling.

In order to ensure that the vehicle is secured against rolling away, observe the following:

- ▷ Set the parking brake.

- ▷ On uphill grades or on a downhill slope, turn the front wheels in the direction of the curb.
- ▷ On uphill grades or on a downhill slope, also secure the vehicle, e.g., with a wheel chock. ◀



NOTE

In the case of repeated starting attempts or repeated starting in quick succession, the fuel is not burned or is inadequately burned. The catalytic converter can overheat. There is a risk of property damage. Avoid repeated starting in quick succession. ◀

Steptronic transmission

Starting the engine

1. Depress the brake pedal.
2. Press the Start/Stop button.

The ignition is activated automatically for a brief time and is stopped as soon as the engine starts.

Engine stop

Safety information



WARNING

Unattended children or animals can cause the vehicle to move and endanger themselves and traffic, e.g., due to the following actions:

- ▷ Pressing the Start/Stop button.
- ▷ Releasing the parking brake.
- ▷ Opening and closing the doors or windows.
- ▷ Engaging selector lever position N.
- ▷ Using vehicle equipment.

There is a risk of accidents or injuries. Do not leave children or animals unattended in the vehicle. Take the remote control with you when exiting and lock the vehicle. ◀

**WARNING**

An unsecured vehicle can begin to move and possibly roll away. There is a risk of an accident. Before exiting, secure the vehicle against rolling.

In order to ensure that the vehicle is secured against rolling away, observe the following:

- ▷ Set the parking brake.
- ▷ On uphill grades or on a downhill slope, turn the front wheels in the direction of the curb.
- ▷ On uphill grades or on a downhill slope, also secure the vehicle, e.g., with a wheel chock. ◀

Before driving into a vehicle wash

So that the vehicle can roll into a vehicle wash, observe instructions for going into an automatic vehicle wash, refer to page 255.

Steptronic transmission**Switching off the engine**

1. Engage selector lever position P with the vehicle stopped.
2. Press the Start/Stop button.
The engine is switched off.
The radio-ready state is switched on.
3. Set the parking brake.

Auto Start/Stop function**Concept**

The Auto Start/Stop function helps save fuel. The system switches off the engine during a stop, e.g., in traffic congestion or at traffic lights. The ignition remains switched on. The engine starts again automatically for driving off.

General information

After every start of the engine using the Start/Stop button, the Auto Start/Stop function is in the last selected state. When the Auto Start/Stop function is active, it is available when the vehicle is traveling faster than about 3 mph/5 km/h.

Engine stop

The engine is switched off automatically during a stop under the following conditions:

Steptronic transmission:

- ▷ The selector lever is in selector lever position D.
- ▷ The brake pedal remains pressed while the vehicle is stationary or the vehicle is held by Automatic Hold.
- ▷ The driver's safety belt is buckled or the driver's door is closed.

The air flow from the air conditioner is reduced when the engine is switched off.

Displays in the instrument cluster

The display indicates that the Auto Start/Stop function is ready for an Automatic engine start.



The display indicates that the conditions for an automatic engine stop have not been met.

Functional limitations

The engine is not switched off automatically in the following situations:

- ▷ External temperature too low.
- ▷ The external temperature is high and automatic climate control is running.
- ▷ The vehicle's interior has not yet been heated or cooled to the required level.

- ▷ The engine is not yet at operating temperature.
- ▷ The wheels are at a sharp angle or the steering wheel is being turned.
- ▷ After driving in reverse.
- ▷ Fogging of the windows when the automatic climate control is switched on.
- ▷ Vehicle battery is heavily discharged.
- ▷ At higher elevations.
- ▷ The engine compartment lid is unlocked.
- ▷ HDC Hill Descent Control is activated.
- ▷ The parking assistant is activated.
- ▷ Stop-and-go traffic.
- ▷ Selector lever in selector lever position N, M/S or R.
- ▷ Use of fuel with high ethanol content.

Starting the engine

The engine starts automatically under the following conditions:

- ▷ Steptronic transmission: by releasing the brake pedal.

When Automatic Hold is activated: press the accelerator pedal.

After the engine starts, accelerate as usual.

Safety mode

After the engine switches off automatically, it will not start again automatically if any one of the following conditions are met:

- ▷ The driver's safety belt is unbuckled and the driver's door is open.
- ▷ The hood was unlocked.

Some indicator lights light up for a varied length of time.

The engine can only be started via the Start/Stop button.

Functional limitations

Even if driving off was not intended, the deactivated engine starts up automatically in the following situations:

- ▷ Excessive warming of the vehicle's interior when the cooling function is switched on.
- ▷ The steering wheel is turned.
- ▷ Steptronic transmission: change from selector lever position D to R, N or M/S.
- ▷ Steptronic transmission: change from selector lever position P to N, D, R or M/S.
- ▷ Fogging of the windows when the automatic climate control is switched on.
- ▷ Vehicle battery is heavily discharged.
- ▷ Excessive cooling of the vehicle's interior when the heating is switched on.

Activating/deactivating the system manually

Using the button



 Press button.

- ▷ LED comes on: auto Start/Stop function is deactivated.
The engine is started during an automatic engine stop.
The engine can only be stopped or started via the Start/Stop button.
- ▷ LED goes out: auto Start/Stop function is activated.

Switching off the vehicle during an automatic engine stop

During an automatic engine stop, the vehicle can be switched off permanently, for instance when leaving it.

Steptronic transmission:

1. Press the Start/Stop button. The ignition is switched off. The Auto Start/Stop function is deactivated.

Selector lever position P is engaged automatically.

2. Set the parking brake.

Engine start as usual via Start/Stop button.

Automatic deactivation

In certain situations, the Auto Start/Stop function is deactivated automatically for safety reasons, e.g., if no driver is detected.

Malfunction

The Auto Start/Stop function no longer switches off the engine automatically. A Check Control message is displayed. It is possible to continue driving. Have the system checked by a dealer's service center or another qualified service center or repair shop.

Parking brake

Concept

The parking brake is used to prevent the vehicle from rolling when it is parked.

Safety information



WARNING

An unsecured vehicle can begin to move and possibly roll away. There is a risk of an accident. Before exiting, secure the vehicle against rolling.

In order to ensure that the vehicle is secured against rolling away, observe the following:

- ▷ Set the parking brake.
- ▷ On uphill grades or on a downhill slope, turn the front wheels in the direction of the curb.
- ▷ On uphill grades or on a downhill slope, also secure the vehicle, e.g., with a wheel chock. ◀



WARNING

Unattended children or animals can cause the vehicle to move and endanger themselves and traffic, e.g., due to the following actions:

- ▷ Pressing the Start/Stop button.
- ▷ Releasing the parking brake.
- ▷ Opening and closing the doors or windows.
- ▷ Engaging selector lever position N.
- ▷ Using vehicle equipment.

There is a risk of accidents or injuries. Do not leave children or animals unattended in the vehicle. Take the remote control with you when exiting and lock the vehicle. ◀

Overview



Parking brake

Setting

With a stationary vehicle



Pull the switch.

The LED lights up.



The indicator light lights up red. The parking brake is set.

While driving

To use as emergency brake while driving:

Pull the switch and hold it. The vehicle brakes hard while the switch is being pulled.



The indicator light lights up red, a signal sounds and the brake lights light up.

A Check Control message is displayed.

If the vehicle is slowed down to a speed of approx. 2 mph/3 km/h the parking brake is set.

Releasing

Releasing manually

With the ignition switched on:



Steptronic transmission: press the switch while the brake is pressed or selector lever position P is set.

The LED and indicator light go out.

The parking brake is released.

Automatic release in cars with Steptronic transmission

For automatic release, step on the accelerator pedal.

The LED and indicator lamp go out.

The parking brake is automatically released when you step on the accelerator under the following conditions:

- ▷ Engine on.
- ▷ Drive mode engaged.
- ▷ Driver buckled in and doors closed.

Automatic Hold

Concept

This system assists the driver by automatically setting and releasing the brake, such as when moving in stop-and-go traffic.

The vehicle is automatically held in place when it is stationary.

On inclines, the system prevents the vehicle from rolling backward when driving off.

General information

Under the following conditions, Automatic Hold is automatically deactivated and the parking brake is set:

- ▷ The engine is switched off.
- ▷ A door is opened and driver's safety belt is unbuckled while the vehicle is stationary.
- ▷ The moving vehicle is brought to a standstill using the parking brake.



The indicator light switches from green to red and the letters AUTO H go out.

Safety information



WARNING

An unsecured vehicle can begin to move and possibly roll away. There is a risk of an accident. Before exiting, secure the vehicle against rolling.

In order to ensure that the vehicle is secured against rolling away, observe the following:

- ▷ Set the parking brake.
- ▷ On uphill grades or on a downhill slope, turn the front wheels in the direction of the curb.
- ▷ On uphill grades or on a downhill slope, also secure the vehicle, e.g., with a wheel chock. ◀



NOTE

If the vehicle is stationary, Automatic Hold engages the parking brake. It prevents the vehicle from rolling in a vehicle wash. There is a risk of property damage. Deactivate Automatic Hold prior to entering the vehicle wash. ◀



WARNING

Unattended children or animals can cause the vehicle to move and endanger themselves and traffic, e.g., due to the following actions:

- ▶ Pressing the Start/Stop button.
- ▶ Releasing the parking brake.
- ▶ Opening and closing the doors or windows.
- ▶ Engaging selector lever position N.
- ▶ Using vehicle equipment.

There is a risk of accidents or injuries. Do not leave children or animals unattended in the vehicle. Take the remote control with you when exiting and lock the vehicle. ◀

Overview



Automatic Hold

Activating

This function can be activated when the driver's door is closed, the safety belt is fastened and the engine is running.



Press button.

The LED and the letters AUTO H light up.



The indicator lamp lights up. Automatic Hold is activated.

Deactivating

When deactivating, additionally depress the brake pedal if the vehicle is being held by Automatic Hold.



Press button again. The LED and the letters AUTO H go out.

Automatic Hold is deactivated.

When the parking brake is set manually, Automatic Hold is deactivated automatically.

Driving

Automatic Hold is activated: the vehicle is automatically secured against rolling after braking to a standstill.



The indicator light lights up green. Step on the accelerator pedal to drive off.

The brake is released automatically.

The indicator light goes out.

Parking

The parking brake is automatically set if the engine is switched off while the vehicle is being held by Automatic Hold.



The indicator light changes from green to red.

The parking brake is not set if the engine is switched off while the vehicle is coasting to a halt. Automatic Hold is deactivated.

Automatic Hold remains activated during the engine stop brought about by the Auto Start/Stop function.

Malfunction

In the event of a failure or malfunction of the parking brake, secure the vehicle against rolling using a wheel chock, e.g., when leaving it.

After a power failure

Putting the parking brake into operation

1. Switch on the ignition.
2.  Press the switch while stepping on the brake pedal or selector lever position P is set.

It may take several seconds for the brake to be put into operation. Any sounds associated with this are normal.

 The indicator light in the instrument cluster goes out as soon as the parking brake is ready for operation.

Turn signal, high beams, headlight flasher

Turn signal

Turn signal in exterior mirror

When driving and during operation of the turn signals or hazard warning system, do not fold in the exterior mirrors, so that the signal lights on the exterior mirror are easy to see.

Using turn signals

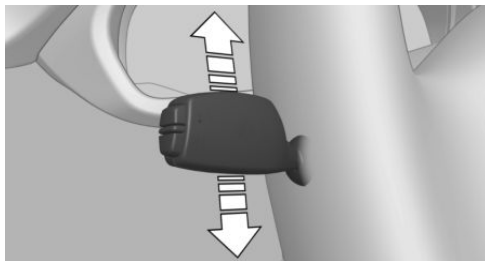

Press the lever beyond the resistance point.

The lever returns into its starting position after actuation.

To switch off manually, slightly tap the lever to the resistance point.

Triple turn signal activation

Lightly tap the lever up or down.

The turn signal flashes three times.

The function can be activated or deactivated.

Using iDrive:

1. "Settings"
2. "Lighting"
3. "Triple turn signal"

The setting is stored for the driver profile currently used.

Signaling briefly

Press the lever to the resistance point and hold it there for as long as you want the turn signal to flash.

Malfunction

Unusually rapid flashing of the indicator lamp indicates that a turn signal bulb has failed.

High beams, headlight flasher

Push the lever forward or pull it backward.

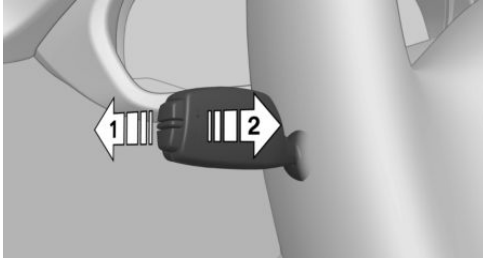

- ▷ High beams on, arrow 1.
- ▷ High beams off/headlight flasher, arrow 2.

Washer/wiper system

General information

Do not use the wipers if the windshield is dry, as this may damage the wiper blades or cause them to become worn more quickly.

Safety information

WARNING

If the wipers start moving in the folded away state, body parts can be jammed or damage may occur to parts of the vehicle. There is a risk of injury or risk of property damage. Make sure that the vehicle is switched off when the wipers are in the folded away state and the wipers are folded in when switching on. ◀

NOTE

If the wipers are frozen to the windshield, the wiper blades can be torn off and the wiper motor can overheat when switching on. There is a risk of property damage. Defrost the windshield prior to switching the wipers on. ◀

Switching on

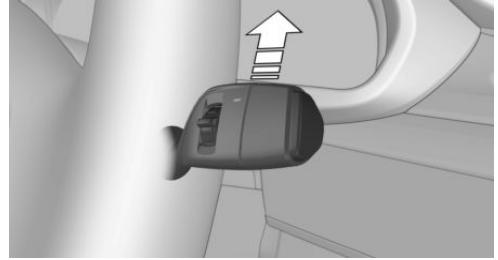

Tap up the lever or press it past the resistance point.

- ▷ Normal wiper speed: tap up once.
The wipers switch to intermittent operation when the vehicle is stationary.
- ▷ Fast wiper speed: tap up twice or tap once beyond the resistance point.
Wipers change to normal speed when vehicle comes to standstill.

The lever automatically returns to its initial position when released.

Switching off and brief wipe

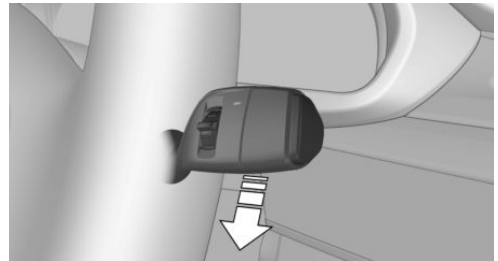

Press the lever down.

- ▷ To switch off from fast wiper speed: press down twice.
- ▷ To switch off from normal wiper speed: press down once.
- ▷ Brief wipe: press down once.

The lever automatically returns to its initial position when released.

Interval mode or rain sensor

Concept

The rain sensor automatically controls the time between wipes depending on the intensity of the rainfall.

General information

The sensor is located on the windshield, directly in front of the interior mirror. Without the rain sensor, the frequency of the wiper operation is preset.

Safety information

NOTE

If the rain sensor is activated, the wipers can accidentally start moving in vehicle washes. There is a risk of property damage. Deactivate the rain sensor in vehicle washes. ◀

Activating/deactivating

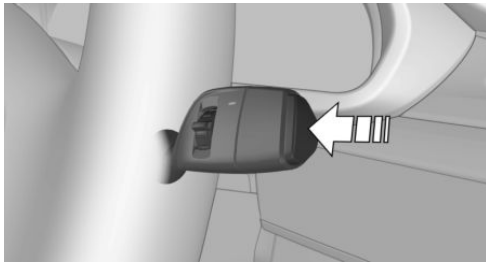

Press button on the wiper lever.

Wiping is started.

If the vehicle is equipped with a rain sensor: LED in wiper lever lights up.

If wipers are frozen to windshield, wiper operation is deactivated.

During trip interruption with the rain sensor switched on: if the trip is resumed within approx. 15 minutes, the rain sensor is automatically activated again.

Setting the frequency or sensitivity of the rain sensor

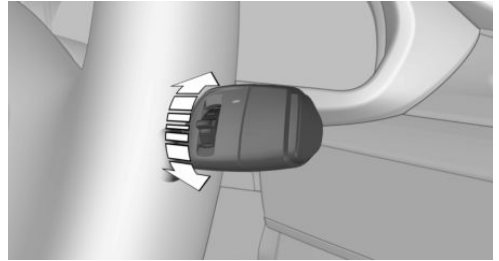

Turn the thumbwheel to adjust the frequency or sensitivity of the rain sensor.

Up: short interval or high sensitivity of the rain sensor.

Down: long interval or low sensitivity of the rain sensor.

Windshield and headlamp washer system

Safety information

WARNING

The washer fluid can freeze onto the window at low temperatures and obstruct the view. There is a risk of an accident. Only use the washer systems, if the washer fluid cannot freeze. Use antifreeze, if needed. ◀

NOTE

When the washer fluid reservoir is empty, the wash pump cannot work as intended. There is a risk of property damage. Do not use the washer system when the washer fluid reservoir is empty. ◀

Cleaning

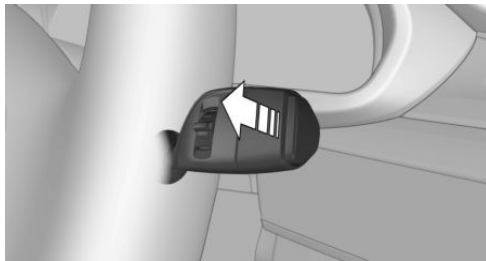

Pull the lever.

The system sprays washer fluid on the windshield and activates the wipers briefly.

In addition, the headlights are cleaned at regular intervals when the vehicle's lights are activated.

Windshield washer nozzles

The windshield washer nozzles are automatically heated while the ignition is switched on.

Fold-away position of the wipers

Concept

The wipers can be folded away from the windshield in the fold-away position.

General information

Important, e.g., when changing the wiper blades or when folding out under frosty conditions.

Safety information



WARNING

If the wipers start moving in the folded away state, body parts can be jammed or damage may occur to parts of the vehicle. There is a risk of injury or risk of property damage. Make sure that the vehicle is switched off when the wipers are in the folded away state and the wipers are folded in when switching on. ◀



NOTE

If the wipers are frozen to the windshield, the wiper blades can be torn off and the wiper motor can overheat when switching on. There is a risk of property damage. Defrost the windshield prior to switching the wipers on. ◀

Folding away the wipers

1. Switch the ignition on and off again.
2. With frosty conditions, make sure that the blades are not frozen to the windshield
3. Press the wiper lever up beyond the point of resistance and hold it for approx. 3 seconds, until the wipers remain in a nearly vertical position
4. Fold the wipers all the way away from the windshield.

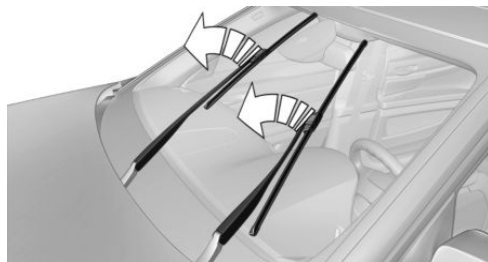

Folding down the wipers

After the wipers are folded back down, the wiper system must be reactivated.

1. Fold the wipers back down onto the windshield.
2. Switch on the ignition.
3. Push wiper lever down. Wipers return to their resting position and are ready again for operation.

Washer fluid

General information

All washer nozzles are supplied from one reservoir.

Use a mixture of tap water and windshield washer concentrate. If desired, a windshield washer concentrate containing antifreeze can be used.

Recommended minimum fill quantity:
0.2 US gal/1 liter.

Safety information

WARNING

Some antifreeze agents can contain harmful substances and are flammable. There is a risk of fire and a risk of injury. Observe the instructions on the containers. Keep antifreeze away from ignition sources. Do not refill operating materials into different bottles. Store operating materials out of reach of children.

United States: The washer fluid mixture ratio is regulated by the U.S. EPA and many individual states; do not exceed the allowable washer fluid dilution ratio limits that apply. Follow the usage instructions on the washer fluid container.

Use of BMW's Windshield Washer Concentrate or the equivalent is recommended. ◀

WARNING

Washer fluid can ignite and catch fire on contact with hot engine parts. There is a risk of injury or risk of property damage. Only add washer fluid when the engine is cooled down. Next, fully close the lid of the washer fluid reservoir. ◀

NOTE

Silicon-containing additives in the washer fluid for the water-repelling effect on the windows can lead to damage to the washing system. There is a risk of property damage.

Do not add silicon-containing additives to the washer fluid. ◀

NOTE

Mixing different windshield washer concentrates or antifreeze agents can damage the washing system. There is a risk of property damage. Do not mix different windshield washer concentrates or antifreeze agents. Observe the information and mixing ratios provided on the containers. ◀

Overview

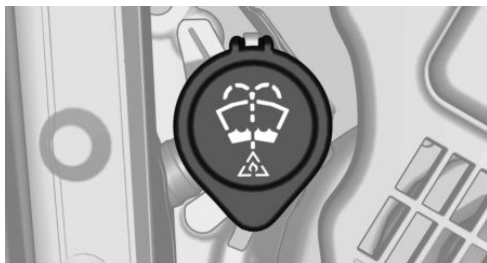

The washer fluid reservoir is located in the engine compartment.

Malfunction

The use of undiluted windshield washer concentrate or alcohol-based antifreeze can lead to incorrect readings at temperatures below +5 °F/-15 °C.

Steptronic transmission

Concept

The Steptronic transmission combines the functions of an automatic transmission with the possibility of manual shifting, if needed.

Safety information



WARNING

An unsecured vehicle can begin to move and possibly roll away. There is a risk of an accident. Before exiting, secure the vehicle against rolling.

In order to ensure that the vehicle is secured against rolling away, observe the following:

- ▶ Set the parking brake.
- ▶ On uphill grades or on a downhill slope, turn the front wheels in the direction of the curb.
- ▶ On uphill grades or on a downhill slope, also secure the vehicle, e.g., with a wheel chock. ◀

Selector lever positions

Drive mode D

Selector lever position for normal vehicle operation. All gears for forward travel are activated automatically.

Reverse R

Engage selector lever position R only when the vehicle is stationary.

Neutral N

In selector lever position N, the vehicle may be pushed or roll without engine power, for instance in vehicle washes; see the Care chapter.

Parking position P

Selector lever position, for instance for parking the vehicle.

The transmission blocks the drive wheels in selector lever position P.

Engage selector lever position P only when the vehicle is stationary.

Selector lever position P is engaged automatically in the following situations:

- ▶ After the engine is switched off when the vehicle is in radio-ready state, refer to page 69, or when the ignition is switched off, refer to page 69, and when selector lever position R or D is set.
- ▶ If, with the vehicle stationary and the selector lever in position D or R, the driver's safety belt unbuckled, the driver's door is opened, and the brake pedal is not depressed.

Engaging selector lever positions

General information

To prevent the vehicle from creeping after you select a drive mode, maintain pressure on the brake pedal until you are ready to start.

Functional requirements

Only when the engine is running and the brake pedal is depressed is it possible to change from selector lever position P to another selector lever position.

Engaging selector lever position D, N, R

A selector lever lock prevents the following faulty operation:

- ▶ Unintentional shifting into selector lever position R.
 - ▶ Unintentional shifting from selector lever position P into another selector lever position.
1. Press and hold the button to release the selector lever lock.

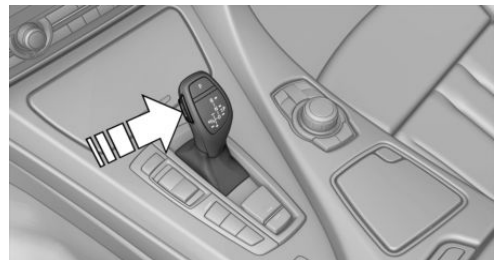

- With the driver's safety belt fastened, briefly push the selector lever in the desired direction, past a resistance point, if needed. The selector lever automatically returns to the center position when released.

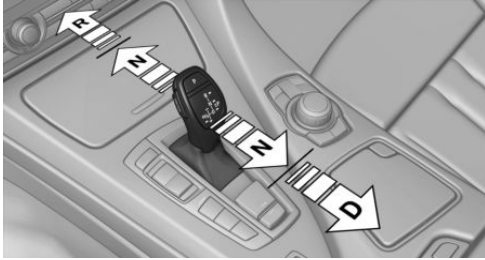

Engaging selector lever position P

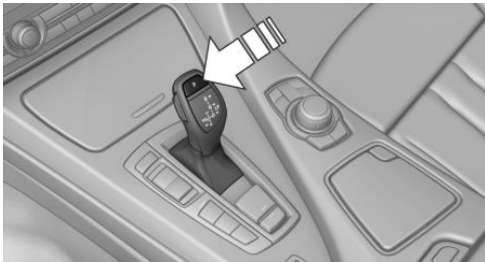

Press button P.

Kickdown

Kickdown is used to achieve maximum driving performance.

Step on the accelerator pedal beyond the resistance point at the full throttle position.

Sport program M/S

Concept

The shifting points and shifting times in the Sport program are designed for a sportier driving style. The transmission, for instance shifts up later and the shifting times are shorter.

Activating the sport program



Press the selector lever to the left out of selector lever position D.

The engaged gear is displayed in the instrument cluster, for instance S1.

The sport program of the transmission is activated.

Ending the Sport program

Push the selector lever to the right.

D is displayed in the instrument cluster.

Manual mode M/S

Concept

Manual gear-shifting is possible in manual mode.

Activating manual mode



Press the selector lever to the left out of selector lever position D, arrow 1. Next, push the selector lever forward or pull it backward, arrow 2.

Manual mode becomes active and the gear is changed.

The engaged gear is displayed in the instrument cluster, for instance M1.

Shifting

To shift down: press the selector lever forward.

To shift up: pull the selector lever rearwards.

The transmission continues shifting automatically in certain situations, for instance when speed limits are reached.

Steptronic Sport transmission: prevent automatic upshifting in M/S manual mode

The Steptronic Sport transmission does not automatically upshift in M/S manual mode once the maximum speed is reached, if one of the following conditions is met:

- ▷ DSC deactivated.
- ▷ TRACTION activated.
- ▷ SPORT+ activated.

Depending on the BMW M drive configuration, this function is active independently of the above-specified conditions.

In addition, there is no downshifting for kickdown.

With the respective transmission version, the lowest possible gear can be selected by simultaneously operating the kickdown and the left shift paddles. This is not possible by switching briefly via the shift paddles from selector lever position D to manual mode M/S.

Ending the manual mode

Push the selector lever to the right.

D is displayed in the instrument cluster.

Shift paddles

Concept

The shift paddles on the steering wheel allow you to shift gears quickly while keeping both hands on the steering wheel.

General information

Shifting

The vehicle only shifts at suitable engine and road speeds.

Switching into manual mode

In selector lever position S, actuating a shift paddle switches into manual mode permanently.

In selector lever position D, actuating a shift paddle switches into manual mode temporarily.

Switching into automatic mode

In selector lever position D, after conservative driving in manual mode without acceleration or shifting via the shift paddles for a certain amount of time, the transmission switches back to automatic mode.

If the selector lever is still in selector lever position D, it is possible to switch into automatic mode with some transmission versions:

- ▷ Pull and hold right shift paddle.
- ▷ In addition to the briefly pulled right shift paddle, briefly pull the left shift paddle.

Shifting



- ▷ To shift up: briefly pull right shift paddle.
- ▷ To shift down: briefly pull left shift paddle.
- ▷ With the respective transmission version, the lowest possible gear can be selected by pulling and holding the left shift paddle.

The selected gear is briefly displayed in the instrument cluster, followed by the current gear.

Displays in the instrument cluster



The selector lever position is displayed, for example P.

Electronic unlocking of the transmission lock

General information

Electronically unlock the transmission lock to maneuver vehicle from a danger area.

Unlocking is possible, if the starter can spin the engine.

Before unlocking the transmission lock, set the parking brake to prevent the vehicle from rolling away.

Engaging selector lever position N

1. Press and hold down brake pedal.
2. Press the Start/Stop button. The starter must audibly start.
3. Press the button on the selector lever, arrow 1, and press and hold the selector

lever into selector lever position N, arrow N, until selector lever position N is displayed in the instrument cluster.

A Check Control message is displayed.

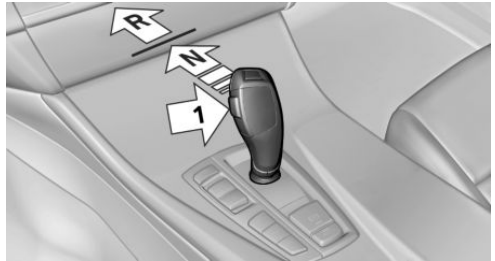

4. Release the selector lever.
5. Release brake, as soon as the starter stops.
6. Maneuver the vehicle from the danger area and secure it against moving on its own.

For additional information, see the chapter on tow-starting and towing.

Steptronic Sport transmission: Launch Control

Concept

Launch Control enables optimum acceleration on surfaces with good traction under dry surrounding conditions.

General information

The use of Launch Control causes premature component wear since this function represents a very heavy load for the vehicle.

Do not use Launch Control during the break-in, refer to page 196, period.

To start with Launch Control do not steer the steering wheel.

Functional requirements

Launch Control is available when the engine is warmed up, that is, after uninterrupted driving of at least 6 miles/10 km.

Start with launch control

While the engine is running:

-  Press button or select Sport+ with the Driving Dynamics Control.
TRACTION is displayed in the instrument cluster and the indicator light for DSC OFF lights up.
- Engage selector lever position S.
- With the left foot, forcefully press down on the brake.
- Press and hold down the accelerator pedal beyond the resistance point at the full throttle position, kickdown.
A flag symbol is displayed in the instrument cluster.
- The starting engine speed adjusts. Within 3 seconds, release the brake.

Repeated use during a trip

After Launch Control was used, the transmission must cool down for approx. 5 minutes, before Launch Control can be used again.

Launch Control adjusts to the surrounding conditions, when used again.

After using Launch Control

To increase vehicle stability, activate DSC Dynamic Stability Control again.

System limits

An experienced driver may be able to achieve better acceleration values in DSC OFF mode.

Displays

Vehicle features and options

This chapter describes all standard, country-specific and optional features offered with the series. It also describes features that are not necessarily available in your vehicle, e. g., due

to the selected options or country versions. This also applies to safety-related functions and systems. When using these functions and systems, the applicable laws and regulations must be observed.

Overview, instrument cluster

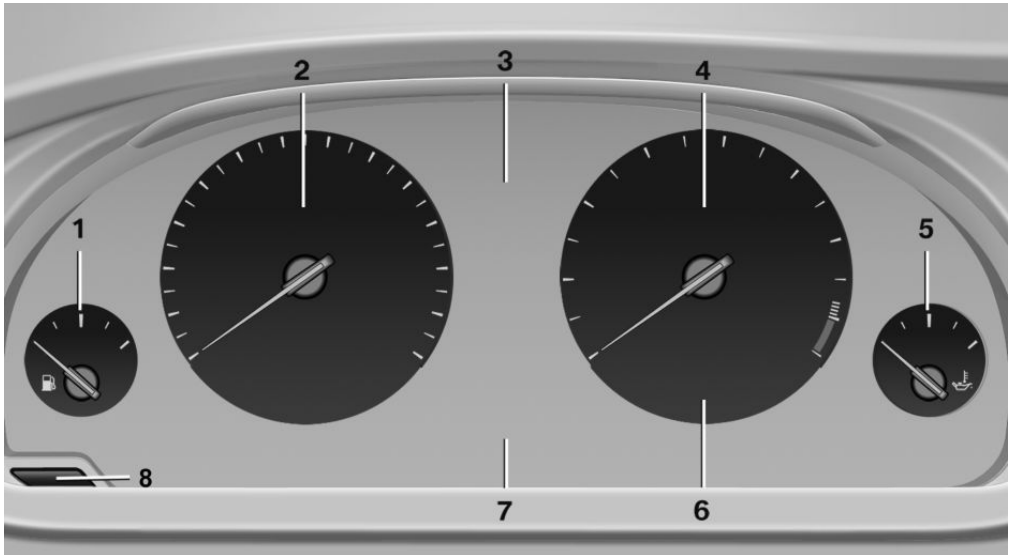

- | | |
|--|---|
| 1 Fuel gauge 94 | 5 Engine oil temperature 94 |
| 2 Speedometer | 6 Current fuel consumption |
| 3 Messages, for instance Check Control | 7 Electronic displays 86 |
| 4 Tachometer 94 | 8 Reset miles 95 |

Electronic displays

- ▷ Selection lists, refer to page [99](#).
- ▷ External temperature, refer to page [95](#).
- ▷ Auto Start/Stop function, refer to page [71](#).
- ▷ Onboard computer, refer to page [99](#).
- ▷ Date, refer to page [95](#).
- ▷ Energy recovery, refer to page [96](#).
- ▷ Transmission display, refer to page [84](#).
- ▷ Miles/trip miles, refer to page [95](#).

- ▷ Messages, e.g., Check Control, refer to page 90.
- ▷ Current fuel consumption, refer to page 96.
- ▷ Navigation display, see Owner's Manual for Navigation, Entertainment and Communication.
- ▷ Range, refer to page 95.
- ▷ Status, Driving Dynamics Control, refer to page 146.
- ▷ Service requirements, refer to page 96.
- ▷ Speed Limit Info, refer to page 97.
- ▷ Time, refer to page 95.

Multifunctional instrument display

Concept

The instrument display is a variable display. In the event of a program change, the display

rendition adapts to the respective program through the Driving Dynamics Control.

General information

The change of the display type can be deactivated via iDrive.

Some of the displays in the instrument display may differ from the way they are shown in this Owner's Manual.

Overview

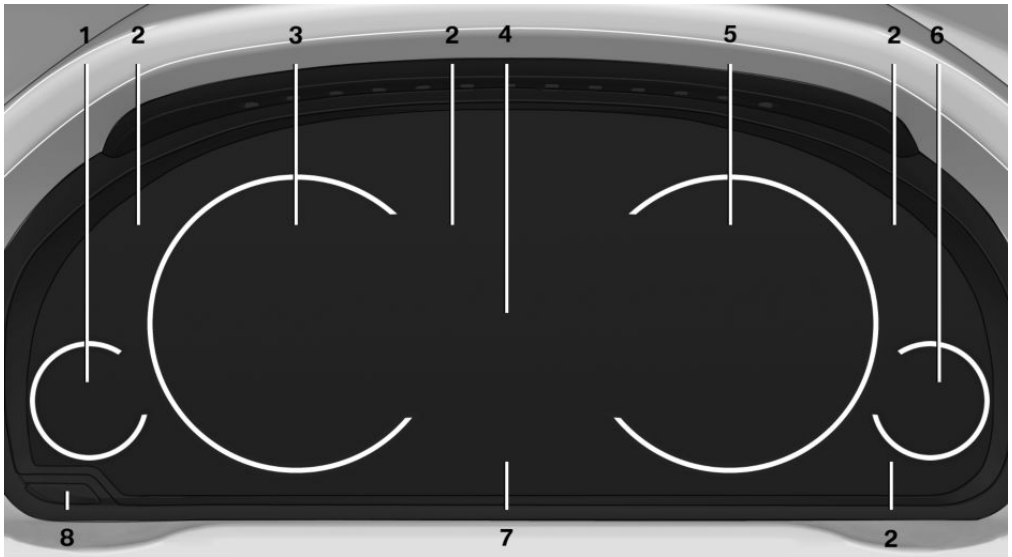

- | | |
|-------------------------------|---------------------|
| 1 Fuel gauge 94 | 4 Variable displays |
| 2 Indicator/warning lights 90 | 5 Tachometer 94 |
| 3 Speedometer | Selection lists 99 |

ECO PRO displays 204

6 Engine oil temperature 94

7 Onboard computer 99

8 Reset miles 95

Switching the change of display on and off

You can set whether the instrument display automatically changes to the ECO PRO or SPORT in the display when you switch driving modes.

On the Control Display:

1. "Settings"
2. "Instrument cluster"
3. "ECO PRO Info"

Or "Driving mode view"

With Professional Navigation System: switching zoom function on/off

You can program whether the current speed is to appear enlarged in the speedometer.

On the Control Display:

1. "Settings"
2. "Instrument cluster"
3. "Magnifier function"

ECO PRO displays

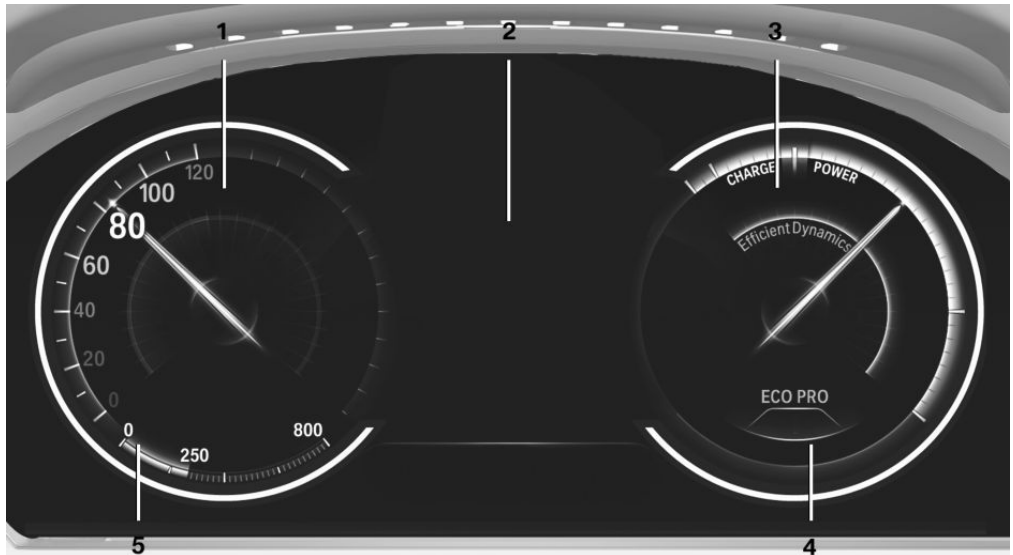

- 1 Speedometer
- 2 Variable displays: ECO PRO Tips, Deceleration assistant instructions, Driver assist system displays
- 3 Efficiency display 204
- 4 Transmission display
- 5
 - ▶ Blue: bonus range
 - ▶ Gray: range

In the ECO PRO program the instrument display switches to the ECO PRO displays. These displays support a driving style that saves on

fuel consumption with more prominent representation of the efficiency display and various ECO PRO tips.

Sport displays

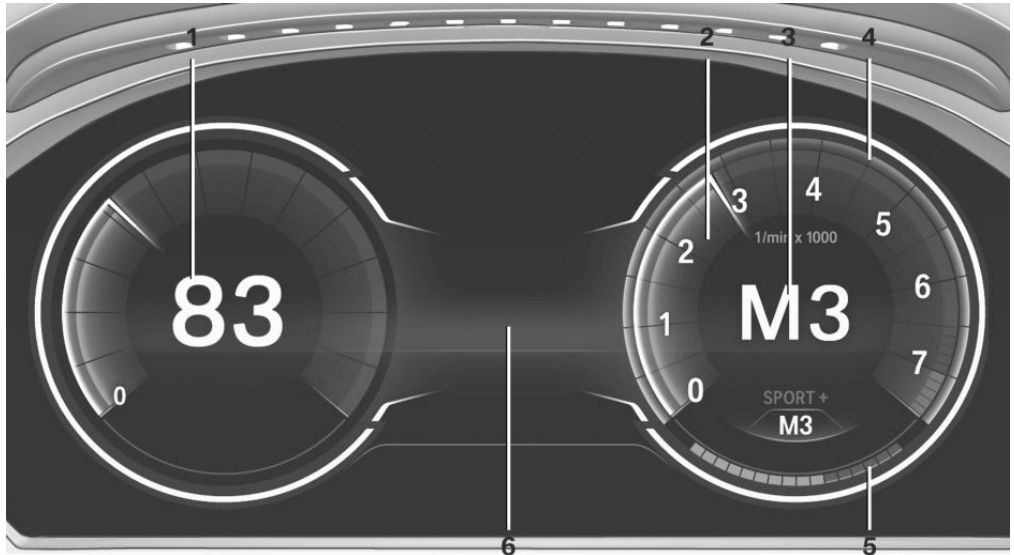

- | | |
|--|--|
| <ul style="list-style-type: none"> 1 Speedometer 2 Tachometer 94 3 Transmission display | <ul style="list-style-type: none"> 4 Shift lights, when respectively equipped 5 Performance display 6 Variable displays |
|--|--|

In the Sport and Sport+ programs the instrument display switches to the sport displays. These displays support a sporty driving style with more prominent representation of the tachometer, the transmission displays, and the vehicle speed.

Shift point indicator

The concept

The shift point indicator indicates the optimum shift moment in the tachometer. Thus, with a sporty driving style, the best possible vehicle acceleration is achieved.

General information

Steptronic Sport transmission: shift lights are shown, when the SPORT+ driving program is activated.

Switching on shift lights

Steptronic Sport transmission:

1. Select SPORT+ using the Driving Dynamics Control.
2. Activate the M/S manual mode of the transmission.

Display



- ▷ Current engine speed is displayed in the tachometer.
- ▷ Arrow 1: successive yellow illuminated fields indicate an increase in the speed.
- ▷ Arrow 2: successive orange illuminated fields indicate the upcoming shift moment.
- ▷ Arrow 3: fields are illuminated in red. Do not wait any further to shift.

When the maximum possible speed is reached, the entire display flashes. When the maximum speed is exceeded, the supply of fuel is interrupted in order to protect the engine.

Check Control

Concept

The Check Control system monitors functions in the vehicle and notifies you of malfunctions in the monitored systems.

General information

A Check Control message is displayed as a combination of indicator or warning lights and SMS text messages in the instrument cluster and in the Head-up Display.

In addition, an acoustic signal may sound and an SMS text message may appear on the Control Display.

Indicator/warning lights

General information

The indicator and warning lights in the instrument cluster can light up in a variety of combinations and colors.

Several of the lights are checked for proper functioning and light up temporarily when the engine is started or the ignition is switched on.

Red lights

Safety belt reminder



Safety belt on the driver's side is not buckled. For some country-specific models: passenger belt is not worn or objects are detected on the front passenger seat.

Indicator lamp flashes or is illuminated: safety belt on the driver or passenger side is not buckled. The safety belt reminder can also be activated if objects are placed on the front passenger seat.

Make sure that the safety belts are positioned correctly.

Airbag system



Airbag system and belt tensioner are not working.

Have the vehicle checked immediately by a dealer's service center or another qualified service center or repair shop.

Parking brake



The parking brake is set. Release the parking brake, refer to page 74.

Brake system





Braking system impaired. Continue to drive moderately.

Have the vehicle checked immediately by a dealer's service center or another qualified service center or repair shop.

Approach control warning



Indicator light illuminates: advance warning is issued, for example when there is the impending danger of a collision or the distance to the vehicle ahead is too small.

Increase distance.

Indicator light flashes: acute warning of the imminent danger of a collision when the vehicle approaches another vehicle at a relatively high differential speed.

Intervention by braking or make an evasive maneuver.

Person warning



Symbol in the instrument cluster.

If a collision with a person detected in this way is imminent, the symbol lights up and a signal sounds.



Symbol in the instrument display.

If a collision with a person detected in this way is imminent, the symbol lights up and a signal sounds.

Orange lights

Active Cruise Control



The number bars shows the selected distance from the vehicle driving ahead.

Active Cruise Control with Stop&Go function, ACC, refer to page [149](#).

Vehicle detection, Active Cruise Control



Indicator light illuminates: a vehicle has been detected ahead of you.

Indicator light flashes: the conditions are not adequate for the system to work.

The system was deactivated but applies the brakes until you actively resume control by pressing on the brake pedal or accelerator pedal.

Yellow lights

Anti-lock Braking System ABS



Braking force boost may not be working. Avoid abrupt braking. Take the longer braking distance into account.



Have the system immediately checked by a dealer's service center or another qualified service center or repair shop.

DSC Dynamic Stability Control



The indicator light flashes: DSC controls the drive and braking forces. The vehicle is stabilized. Reduce speed and adapt driving style to the driving circumstances.

The indicator light lights up: DSC has malfunctioned.

Have the system checked by a dealer's service center or another qualified service center or repair shop.

DSC Dynamic Stability Control, refer to page [142](#).

DSC Dynamic Stability Control is deactivated or DTC Dynamic Traction Control is activated



DSC Dynamic Stability Control is deactivated or DTC Dynamic Traction Control is activated.

DSC Dynamic Stability Control, refer to page [142](#), and DTC Dynamic Traction Control, refer to page [143](#).

Flat Tire Monitor FTM



The Flat Tire Monitor signals a loss of tire inflation pressure in a tire.

Reduce your speed and stop cautiously. Avoid sudden braking and steering maneuvers.

Flat Tire Monitor, refer to page [118](#).

Tire Pressure Monitor TPM



The indicator light illuminates.

The Tire Pressure Monitor reports a low tire inflation pressure or a flat tire.

Observe the information in the Check Control message.

The indicator light flashes and then illuminates continuously.

No flat tire or loss of tire inflation pressure can be detected.

- ▶ Interference caused by systems or devices with the same radio frequency: after leaving the area of the interference, the system automatically becomes active again.
- ▶ TPM was unable to complete the reset. Reset the system again.
- ▶ A wheel without TPM electronics is mounted: have it checked by a dealer's service center or another qualified service center or repair shop as needed.
- ▶ Malfunction: have the system checked by a dealer's service center or another qualified service center or repair shop.

Tire Pressure Monitor, refer to page [114](#).

Steering system



Steering system in some cases not working.

Have the steering system checked by a dealer's service center or another qualified service center or repair shop.

Emissions



▶ The warning light lights up: Emissions are deteriorating. Have the vehicle checked as soon as possible.

- ▶ The warning light flashes under certain circumstances:

This indicates that there is excessive misfiring in the engine.

Reduce the vehicle speed and have the system checked immediately; otherwise, serious engine misfiring within a brief period can seriously damage emission control components, in particular the catalytic converter.

Socket for Onboard Diagnosis, refer to page [242](#).

Lane departure warning



System is switched on and under certain circumstances warns if a detected lane is left without flashing beforehand.

Lane departure warning, refer to page [134](#).

Green lights

Turn signal



Turn signal switched on.

Unusually rapid flashing of the indicator light indicates that a turn signal bulb has failed.

Turn signal, refer to page [76](#).

Parking lights, headlight



Parking lights or headlights are activated.

Parking lights/low beams, headlight control, refer to page [106](#).

Front fog lights



Front fog lights are activated.

Front fog lights, refer to page [109](#).

High-beam Assistant



High-beam Assistant is switched on.

High beams are switched on and off automatically depending on the traffic situation.

High-beam Assistant, refer to page [109](#).

Cruise control



The system is switched on. It maintains the speed that was set using the control elements on the steering wheel.

Automatic Hold



Automatic Hold is activated. The vehicle is automatically held in place when it is stationary.

Automatic Hold, refer to page [74](#).

Blue lights

High beams



High beams are activated.

High beams, refer to page [76](#).

Hiding Check Control messages

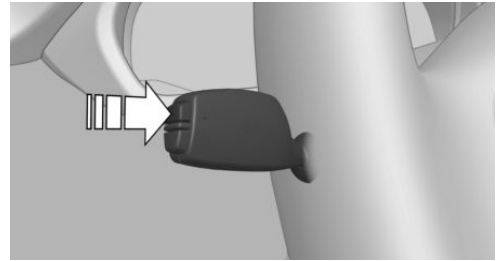

Press and hold button on signal lever.

Continuous display

Some Check Control messages are displayed continuously and are not cleared until the malfunction is eliminated. If several malfunctions occur at once, the messages are displayed consecutively.

These messages can be hidden for approx. 8 seconds. After this time, they are displayed again automatically.

Temporary display

Other Check Control messages are hidden automatically after approx. 20 seconds. They are stored and can be displayed again later.

Displaying stored Check Control messages

Using iDrive:

1. "Vehicle info"
2. "Vehicle status"
3.  "Check Control"
4. Select the SMS text message.

Display

Check Control



At least one Check Control message is displayed or is stored.

SMS text messages

SMS text messages in combination with a symbol in the instrument cluster explain a Check Control message and the meaning of the indicator and warning lights.



Supplementary SMS text messages

Additional information, such as on the cause of an error or the required action, can be called up via Check Control.

With urgent messages the added text will be automatically displayed on the Control Display.

Further help

Depending on the Check Control message, further help can be selected.

- ▷  "Owner's Manual"
Display additional information about the Check Control message in the Integrated Owner's Manual.
- ▷  "Service request"
Contact a dealer's service center or another qualified service center or repair shop.
- ▷  "Roadside Assistance"
Contact Roadside Assistance.

Messages after trip completion

Special messages displayed while driving are displayed again after the ignition is switched off.

Fuel gauge



Vehicle tilt position may cause the display to vary.

Depending on the equipment version, the arrow beside the fuel pump symbol shows which side of the vehicle the fuel filler flap is on.

Information on refueling, refer to page [212](#).



The yellow indicator light illuminates, once the fuel reserve is reached.

Tachometer

Always avoid engine speeds in the red warning field. In this range, the fuel supply is reduced to protect the engine.

Engine oil temperature



- ▷ Cold engine: the pointer is at the low temperature end. Drive at moderate engine and vehicle speeds.
- ▷ Normal operating temperature: the pointer is in the middle or in the left half of the temperature display.
- ▷ Hot engine: the pointer is at the high end of the temperature range. A Check Control message is also displayed.



When the engine oil temperature is too high, a red indicator lamp is displayed.

Coolant temperature

If the coolant along with the engine becomes too hot, a Check Control message is displayed.



A red indicator light is displayed.

Check the coolant level.

Odometer and trip odometer

Display



- ▷ Odometer, arrow 1.
- ▷ Trip odometer, arrow 2.

Show/reset miles



Press the button.

- ▷ When the ignition is switched off, the time, the external temperature and the odometer are displayed.
- ▷ When the ignition is switched on, the trip odometer is reset.

External temperature



WARNING

Even at temperatures above +37 °F/+3 °C there can be a risk of icy roads, e.g., on bridges or shady sections of road. There is a risk of an accident. Adjust your driving style to the weather conditions at low temperatures. ◀

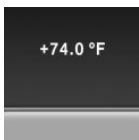

If the indicator drops to +37 °F/+3 °C or lower, a signal sounds.

A Check Control message is displayed.

There is an increased risk of ice on roads.

Time

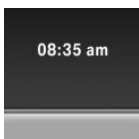

The time is displayed at the bottom of the instrument cluster.

The time can be set on the Control Display.

Date

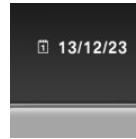

The date is displayed in the on-board computer.

The date and date format can be set on the Control Display.

Range

Display

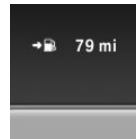

With a low remaining range:

- ▷ A Check Control message is displayed briefly.
- ▷ The remaining range is shown on the onboard computer.
- ▷ With a dynamic driving style, for instance taking curves aggressively, the engine function is not always ensured.

The Check Control message appears continuously below a range of approx. 30 miles/50 km.



NOTE

With a range of less than 30 miles/50 km it is possible that the engine will no longer have sufficient fuel. Engine functions are not ensured anymore. There is a risk of property damage. Refuel promptly. ◀

Displaying the cruising range

Depending on your vehicle's optional features, the range can also be displayed as bar in the instrument cluster.

Using iDrive:

1. "Settings"
2. "Instrument cluster"
3. "Additional indicators"

With navigation system: range with destination guidance active



If the vehicle is equipped accordingly, the estimated fuel consumption to the destination is displayed when destination guidance is active.

Current fuel consumption

Display

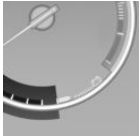

Depending on your vehicle's optional features, the current fuel consumption can be displayed in the instrument cluster. Check whether you are currently driving in an efficient and environmentally-friendly manner.

Displaying the current fuel consumption

Using iDrive:

1. "Settings"
2. "Instrument cluster"
3. "Additional indicators"

The bar display for the current fuel consumption is displayed in the instrument cluster.

Energy recovery

Display



The kinetic energy of the vehicle is converted to electrical energy while the vehicle is coasting. The vehicle battery is partially charged and fuel consumption

can be reduced.

Service requirements

Concept

The function displays the service requirements and the corresponding maintenance scopes.

General information

After the ignition is turned on the instrument cluster briefly displays available driving distance or time to the next scheduled maintenance.

A service advisor can read out the current service requirements from your remote control.

Display

Detailed information on service requirements

More information on the scope of service required can be displayed on the Control Display.



Using iDrive:

1. "Vehicle info"
2. "Vehicle status"
3.  "Service required"

Required maintenance procedures and legally mandated inspections are displayed.

4. Select an entry to call up detailed information.

Symbols

Symbols	Description
	No service is currently required.
	The deadline for scheduled maintenance or a legally mandated inspection is approaching.
	The service deadline has already passed.

Entering appointment dates

Enter the dates for the mandatory vehicle inspections.

Make sure that the vehicle's date and time are set correctly.

Using iDrive:

1. "Vehicle info"
2. "Vehicle status"
3.  "Service required"
4. "§ Vehicle inspection"
5. "Date:"
6. Adjust the settings.
7. Confirm.

The entered date is stored.

Automatic Service Request

Data regarding the service status or legally mandated vehicle inspections is automatically transmitted to your dealer's service center before a service due date.

You can check when your dealer's service center was notified.

Using iDrive:

1. "Vehicle info"
2. "Vehicle status"

3. Open "Options".
4. "Last Service Request"

Gear shift indicator

Concept

The system recommends the most fuel efficient gear for the current driving situation.



General information

Depending on the vehicle's features and country-specific version, the gear shift indicator is active in the manual mode of the Steptronic transmission.

Suggestions to shift gear up or down are displayed in the instrument cluster.

On vehicles without a gear shift indicator, the engaged gear is displayed.

Displaying

Example	Description
	Fuel efficient gear is set.
	Shift into fuel efficient gear.

Speed Limit Info

Speed Limit Info

Concept

Speed Limit Info shows the current maximum permitted speed in the instrument cluster.

General information

The camera in the area of the interior mirror detects traffic signs at the edge of the road as well as variable overhead sign posts. Traffic signs with extra symbols for wet road condi-

tions, etc., are also detected and compared with the vehicle's onboard data, such as from the rain sensor, and will be displayed depending on the situation. The system takes into account the information stored in the navigation system and also displays speed limits present on routes without signs.

Safety information



WARNING

The system does not release from the personal responsibility to correctly assess visibility and traffic situation. There is a risk of an accident. Adjust the driving style to the traffic conditions. Watch traffic closely and actively intervene in the respective situations. ◀

Overview

Camera

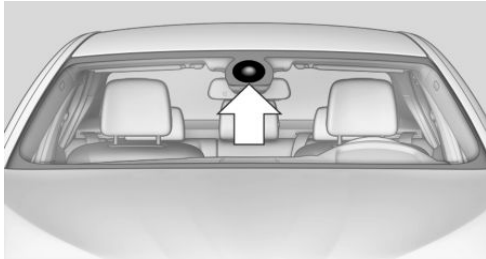

The camera is installed near the interior mirror. Keep the windshield in front of the interior mirror clean and clear.

Switching on/off

Using iDrive:

1. "Settings"
2. "Instrument cluster"
3. "Speed limit information"

If Speed Limit Info is switched on, it can be displayed on the CID (central information display) in the instrument cluster via the onboard computer.

Display

The following is displayed in the instrument cluster:

Speed Limit Info

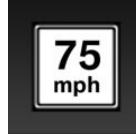

Current speed limit.



Speed Limit Info not available.

Speed Limit Info can also be displayed in the Head-up Display.

System limits

The system may not be fully functional and may provide incorrect information in the following situations:

- ▷ In heavy fog, rain or snowfall.
- ▷ When signs are fully or partially concealed by objects, stickers or paint.
- ▷ When driving very close to the vehicle in front of you.
- ▷ When driving toward bright lights or strong reflections.
- ▷ When the windshield in front of the interior mirror is fogged over, dirty or covered by a sticker, etc.
- ▷ In the event of incorrect detection by the camera.
- ▷ If the speed limits stored in the navigation system are incorrect.
- ▷ In areas not covered by the navigation system.
- ▷ When roads differ from the navigation, such as due to changes in road routing.
- ▷ When passing buses or trucks with a speed sticker.

- ▷ If the traffic signs are non-conforming.
- ▷ During calibration of the camera immediately after vehicle delivery.
- ▷ When signs that are valid for a parallel road are detected.

Selection lists

General information

Depending on your vehicle's equipment, the following can be displayed or operated using the buttons and the thumbwheel on the steering wheel as well as the displays in the instrument cluster and the Head-up Display:

- ▷ Current audio source.
- ▷ Redial phone feature.
- ▷ Turn on voice activation system.

Activating a list and adjusting the setting

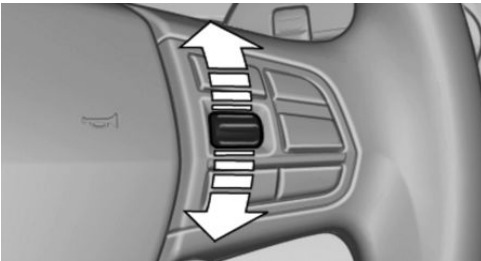

On the right side of the steering wheel, turn the thumbwheel to activate the corresponding list.

1. Turn the thumbwheel and select the desired setting.
2. Press the thumbwheel.

Display



Depending on your vehicle's optional features, the list in the instrument cluster can differ from the illustration shown.

Onboard computer

Concept

The onboard computer displays different vehicle data in the instrument cluster, such as average values.

Calling up information on the CID (central information display)

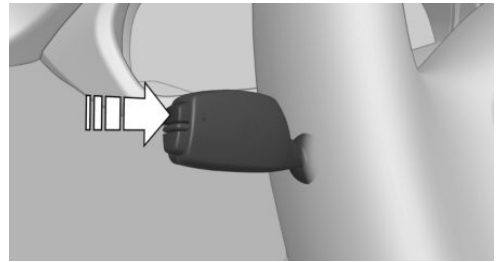

Press and hold button on signal lever.

Information is displayed in the CID (central information display) of the instrument cluster.

Information at a glance

Repeatedly pressing the button on the turn signal lever calls up the following information in the CID (central information display):

- ▷ Range.

- ▷ Average consumption, fuel.
- ▷ Current consumption, fuel.
- ▷ Average speed.
- ▷ Date.
- ▷ Speed Limit Info.
- ▷ Depending on the equipment, the time of arrival.
When destination guidance is activated in the navigation system.
- ▷ Depending on the equipment, the distance to destination.
When destination guidance is activated in the navigation system.
- ▷ Compass display in the navigation system.
- ▷ ECO PRO bonus range.

Selecting information

Depending on the vehicle equipment version, you can select what information from the on-board computer is to be displayed on the CID (central information display) of the instrument cluster.

Using iDrive:

1. "Settings"
2. "Instrument cluster"
3. Select the desired information.

Settings are stored for the profile currently used.

Indication in the info display

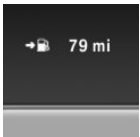

The information from the on-board computer is shown in the info display in the instrument cluster.

Information in detail

Range

Displays the estimated cruising range available with the remaining fuel.

It is calculated based on your driving style over the last 20 miles/30 km.

Average fuel consumption

The average fuel consumption is calculated for the period while the engine is running.

The average fuel consumption is calculated for the distance traveled since the last reset by the onboard computer.

Average speed

Periods in which the vehicle is parked with the engine manually stopped are not included in the calculation of the average speed.

Resetting average values

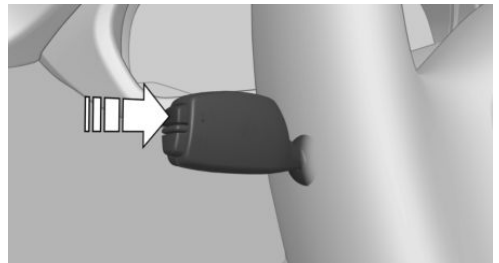

Press and hold button on turn signal lever.

Distance to destination

Depending on the vehicle equipment, the distance remaining to the destination is displayed if a destination is entered in the navigation system before the trip is started.

The distance to the destination is adopted automatically.

Time of arrival

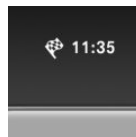

Depending on the vehicle equipment, the estimated time of arrival is displayed if a destination is entered in the navigation system before the trip is started.

The time must be correctly set.

Speed Limit Info

Further information, see chapter Speed Limit Info.

Compass

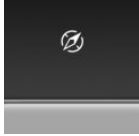

With a navigation system: compass display for the driving direction.

Onboard computer on the Control Display

Concept

The onboard computer displays different vehicle data on the Control Display, such as average values.

General information

The vehicle features two types of onboard computers.

- ▶ "Onboard info": average values, such as the fuel consumption, are displayed. The values can be reset individually.
- ▶ "Trip computer": the values deliver an overview of a certain distance and can be reset as often as necessary.

Calling up the onboard computer or trip computer

Using iDrive:

1. "Vehicle info"
2. "Onboard info" or "Trip computer"

Resetting the onboard computer

Using iDrive:

1. "Vehicle info"
2. "Onboard info"
3. "Consumpt." or "Speed"
4. "Yes"

Resetting the trip computer

Using iDrive:

1. "Vehicle info"
2. "Trip computer"
3. "Reset": all values are reset.
"Automatically reset": all values are reset approx. 4 hours after the vehicle has come to a standstill.

Sport displays

General information

On the Control Display, the current values for performance and torque can be displayed if the vehicle is appropriately equipped.

Displaying sport displays

Using iDrive:

1. "Vehicle info"
2. "Sport displays"

Speed warning

Concept

A speed limit can be set that when reached will cause a warning to be issued.

General information

The warning is repeated if the vehicle speed drops below the set speed limit once by at least 3 mph/5 km/h.

Displaying, setting or changing the speed warning

Using iDrive:

1. "Settings"
2. "Speed"
3. "Warning at:"

4. Turn the controller until the desired speed is displayed.
5. Press the controller.

Activating/deactivating the speed warning

Using iDrive:

1. "Settings"
2. "Speed"
3. "Warning"
4. Press the controller.

Setting your current speed as the speed warning

Using iDrive:

1. "Settings"
2. "Speed"
3. "Select current speed"
4. Press the controller.

Settings on the Control Display

Time

Setting the time zone

1. "Settings"
2. "Time/Date"
3. "Time zone:"
4. Select the desired time zone.

The time zone is stored.

Setting the time

1. "Settings"
2. "Time/Date"
3. "Time:"
4. Turn the controller until the desired hours are displayed.

5. Press the controller.
6. Turn the controller until the desired minutes are displayed.
7. Press the controller.

The time is stored.

Setting the time format

1. "Settings"
2. "Time/Date"
3. "Format:"
4. Select the desired format.

The time format is stored.

Automatic time setting

Depending on your vehicle's optional features, the time, date and, if needed, the time zone are updated automatically.

1. "Settings"
2. "Time/Date"
3. "Auto time set"

Date

Setting the date

1. "Settings"
2. "Time/Date"
3. "Date:"
4. Turn the controller until the desired day is displayed.
5. Press the controller.
6. Make the necessary settings for the month and year.

The date is stored.

Setting the date format

1. "Settings"
2. "Time/Date"
3. "Format:"
4. Select the desired format.

The date format is stored.

Language

Setting the language

1. "Settings"
2. "Language/Units"
3. "Language:"
4. Select the desired language.

Settings are stored for the profile currently used.

Setting the voice dialog

Voice dialog for the voice activation system, refer to page 27.

Units of measurement

Setting the units of measurement

To set the units for fuel consumption, route/distance and temperature:

1. "Settings"
2. "Language/Units"
3. Select the desired menu item.
4. Select the desired unit.

Settings are stored for the profile currently used.

Brightness

Setting the brightness

To set the brightness of the Control Display:

1. "Settings"
2. "Control display"
3. "Brightness"
4. Turn the controller until the desired brightness is set.
5. Press the controller.

Settings are stored for the profile currently used.

Depending on the light conditions, the brightness settings may not be clearly visible.

Activating/deactivating the display of the current vehicle position

If GPS geolocation has been activated, the current vehicle position can be displayed in the BMW ConnectedDrive app or in the ConnectedDrive customer portal.

Using iDrive:

1. "Settings"
2. "GPS tracking"
3. "GPS tracking"

Head-up Display

Concept

This system projects important information into the driver's field of vision, e.g., the speed.

The driver can get information without averting his or her eyes from the road.

Overview

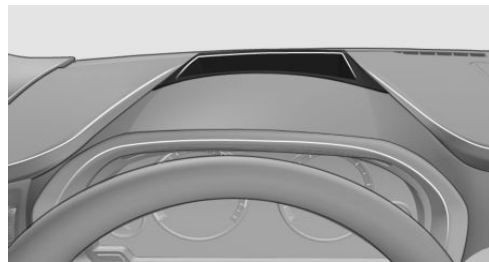

Switching on/off

1. "Settings"
2. "Head-Up Display"
3. "Head-Up Display"

Display

Overview

The following information is displayed on the Head-up Display:

- ▶ Speed.

- ▷ Navigation system.
- ▷ Check Control messages.
- ▷ Selection list from the instrument cluster.
- ▷ Driver assistance systems.

Some of this information is only displayed briefly as needed.

Selecting displays in the Head-up Display

Using iDrive:

1. "Settings"
2. "Head-Up Display"
3. "Displayed information"
4. Select the desired displays in the Head-up Display.

Settings are stored for the profile currently used.

Setting the brightness

The brightness is automatically adjusted to the ambient brightness.

The basic setting can be adjusted.

Using iDrive:

1. "Settings"
2. "Head-Up Display"
3. "Brightness"
4. Turn the controller until the desired brightness is set.
5. Press the controller.

When the low beams are activated, the brightness of the Head-up Display can be additionally influenced using the instrument lighting.

Settings are stored for the profile currently used.

Adjusting the height

Using iDrive:

1. "Settings"
2. "Head-Up Display"

3. "Height"

4. Turn the controller until the desired height is reached.

5. Press the controller.

Settings are stored for the profile currently used.

The height of the Head-up Display can also be stored using the memory function, refer to page 59.

Setting the rotation

The screen of the Head-up Display can be rotated around its own axis.

Using iDrive:

1. "Settings"
2. "Head-Up Display"
3. "Rotation"
4. Turn the controller until the desired setting is selected.
5. Press the controller.

Settings are stored for the profile currently used.

Display visibility

The visibility of the displays in the Head-up Display is influenced by the following factors:

- ▷ Certain sitting positions.
- ▷ Objects on the cover of the Head-up Display.
- ▷ Sunglasses with certain polarization filters.
- ▷ Wet roads.
- ▷ Unfavorable light conditions.

If the image is distorted, have the basic settings checked by a dealer's service center or another qualified service center or repair shop.

Follow the instructions for cleaning the Head-up Display, refer to page 258.

Special windshield

The windshield is part of the system.

The shape of the windshield makes it possible to display a precise image.

A film in the windshield prevents double images from being displayed.

For this reason, it is strongly suggested to have the special windshield replaced by a dealer's service center or another qualified service center or repair shop, if necessary.

Lights

Vehicle features and options





This chapter describes all standard, country-specific and optional features offered with the series. It also describes features that are not necessarily available in your vehicle, e. g., due to the selected options or country versions. This also applies to safety-related functions and systems. When using these functions and systems, the applicable laws and regulations must be observed.



Overview

Switches in the vehicle



The light switch element is located next to the steering wheel.

Symbol	Function
	Front fog lights
	Automatic headlight control Adaptive Light Control
	Lights off Daytime running lights
	Parking lights

Symbol	Function
	Low beams
	Instrument lighting

Parking lights, cornering lights and roadside parking lights

General information

Position of switch: 0 ,  , 

The exterior lighting is automatically switched off at these switch settings if the driver's door is opened when the ignition is switched off.

Parking lights

Position of switch:  

The vehicle is illuminated on all sides.

Do not use the parking lights for extended periods; otherwise, they might drain the battery and it would then be impossible to start the engine.

When parking, switch on the one-sided roadside parking lamp, refer to page 106.

Low beams

Position of switch: 

The low beams light up when the ignition is switched on.

Roadside parking lights

Concept

The vehicle can be illuminated on one side.

Switching on

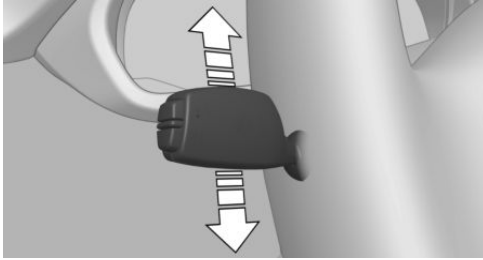

With the ignition switched off, press the lever either up or down past the resistance point for approx. 2 seconds.



Switching off

Briefly press the lever to the resistance point in the opposite direction.

Welcome lights and headlamp courtesy delay feature

Welcome lights

General information

Depending on the equipment, when switching off the vehicle, switch position  or .

Depending on the ambient brightness, individual light functions may be switched on briefly, when the vehicle is unlocked.

Activating/deactivating

Using iDrive:

1. "Settings"
2. "Lighting"
3. "Welcome lights"

Settings are stored for the profile currently used.

Headlamp courtesy delay feature

General information

The low beams stay lit for a short while if the headlight flasher is switched on after the radio-ready state is switched off.

Setting the duration

Using iDrive:

1. "Settings"
2. "Lighting"
3. "Pathway lighting:"
4. Set length of time.

The setting is stored for the driver profile currently used.

Automatic headlight control

Concept

The low beams are switched on and off automatically depending on the ambient brightness, for instance in tunnels, in twilight or if there is precipitation.

General information

A blue sky with the sun low on the horizon can cause the lights to be switched on.

When emerging from a tunnel during the day, the low beams are not switched off immediately but instead only after approx. 2 minutes.

The low beams always stay on when the fog light is switched on.

Activating

Position of switch: 

The indicator light in the instrument cluster is illuminated when the low beams are switched on.

System limits

The automatic headlight control cannot serve as a substitute for your personal judgment of lighting conditions.

For example, the sensors are unable to detect fog or hazy weather. To avoid safety risks under these conditions, you should always switch on the lights manually.

Daytime running lights

General information

Position of switch:  ,  , 

The daytime running lights light up when the ignition is switched on. After the ignition is switched off, the parking lights light up in position  .

Activating/deactivating

In some countries, daytime running lights are mandatory, so it may not be possible to deactivate the daytime running lights.

Using iDrive:

1. "Settings"
2. "Lighting"
3. "Daytime running lamps"

The setting is stored for the driver profile currently used.

Adaptive Light Control

The concept

Adaptive Light Control is a variable headlight control system that enables dynamic illumination of the road surface.

General information

Depending on the steering angle and other parameters, the light from the headlight follows the course of the road.

To avoid blinding oncoming traffic, the Adaptive Light Control does not swivel to the driver's side when the vehicle is at a standstill.

Depending on the equipment version, Adaptive Light Control consists of one or several systems:

- ▷ Cornering light, refer to page [108](#).

Activating

Position of switch  with the ignition switched on.

Cornering light

In tight curves, for instance on mountainous roads or when turning, a cornering light is switched on up to a certain speed. As a result the inside of the curve is better lighted.

The cornering light is automatically switched on depending on the steering angle or the use of turn signals.

When driving in reverse, the cornering lights may be automatically switched on regardless of the steering angle.

Malfunction

A Check Control message is displayed.

Adaptive Light Control is malfunctioning or has failed. Have the system immediately checked by a dealer's service center or another qualified service center or repair shop.

Self-leveling headlights

The self-leveling headlights compensate for acceleration and braking operations in order not to blind the oncoming traffic and to achieve optimum illumination of the roadway.

High-beam Assistant

Concept



The high-beam Assistant detects other traffic participants early on and automatically switches the high beams on or off depending on the traffic situation. The assistant ensures that the high beams are switched on, whenever the traffic situation allows. In the low speed range, the high beams are not switched on by the system.

General information

The system responds to light from oncoming traffic and traffic driving ahead of you, and to adequate illumination, for instance in towns and cities.

The high beams can be switched on and off at any time as usual.

Activating/deactivating

1. Depending on the equipment, turn the light switch into position  or .
2. Press button on the turn signal lever, arrow.

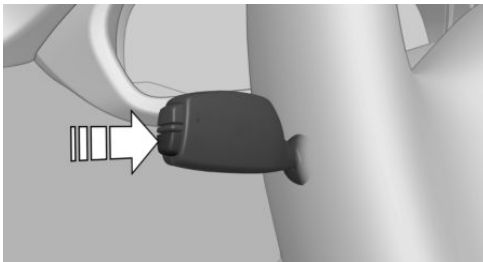

The indicator light in the instrument cluster is illuminated when the low beams are switched on.

The headlights are automatically switched between low beams and high beams.



The blue indicator light in the instrument cluster lights up when the system switches on the high beams.

The high-beam Assistant is deactivated when manually switching the high beams on and off, refer to page 76. To reactivate the high-beam Assistant, press the button on the turn signal lever.

System limits

The high-beam Assistant cannot serve as a substitute for the driver's personal judgment of when to use the high beams. Therefore, manually switch off the high beams in situations where required to avoid a safety risk.

The system is not fully functional in the following situations, and driver intervention may be necessary:

- ▷ In very unfavorable weather conditions, such as fog or heavy precipitation.
- ▷ When detecting poorly-lit road users such as pedestrians, cyclists, horseback riders and wagons; when driving close to train or ship traffic; and at animal crossings.
- ▷ In tight curves, on hilltops or in depressions, in cross traffic or half-obscured oncoming traffic on highways.
- ▷ In poorly-lit towns and cities and in the presence of highly reflective signs.
- ▷ When the windshield in front of the interior mirror is fogged over, dirty or covered with stickers, etc.

Fog lights

Front fog lights

Functional requirement

The low beams must be switched on.

Switching on/off



Press button. The green indicator light lights up if the front fog lights are switched on.

If the automatic headlight control, refer to page 107, is activated, the low beams will come on automatically when you switch on the front fog lights.

When the high beams or headlight flasher are activated, the front fog lights are not switched on.

Instrument lighting

Settings



The parking lights or low beams must be switched on to adjust the brightness.

Adjust the brightness with the thumbwheel.

Interior lights

General information

Depending on the equipment, the interior lights, footwell lights, entry lamps, and courtesy lamps are controlled automatically.

Thumb wheel for the instrument lighting controls brightness of some of these features.

Overview



- 1 Interior lights
- 2 Reading lights

Switching interior lights on/off manually



Press button.

To switch off permanently: press the button for approx. 3 seconds.

Switch back on: press button.

Switching the reading lights on and off manually



Press button.

Reading lights are located at the front and rear next to the interior lights.

Ambient light

General information

Depending on your optional features lighting can be adjusted for some lights in the interior.

Selecting color scheme

On the Control Display:

1. "Settings"
2. "Lighting"
3. "Lighting design"
4. Select the desired setting.

To deactivate the ambient light: "Off".

Setting the brightness

On the Control Display:

1. "Settings"
2. "Lighting"
3. "Brightness:"
4. Adjust the brightness.

Safety

Vehicle features and options

This chapter describes all standard, country-specific and optional features offered with the series. It also describes features that are not necessarily available in your vehicle, e. g., due

to the selected options or country versions. This also applies to safety-related functions and systems. When using these functions and systems, the applicable laws and regulations must be observed.

Airbags

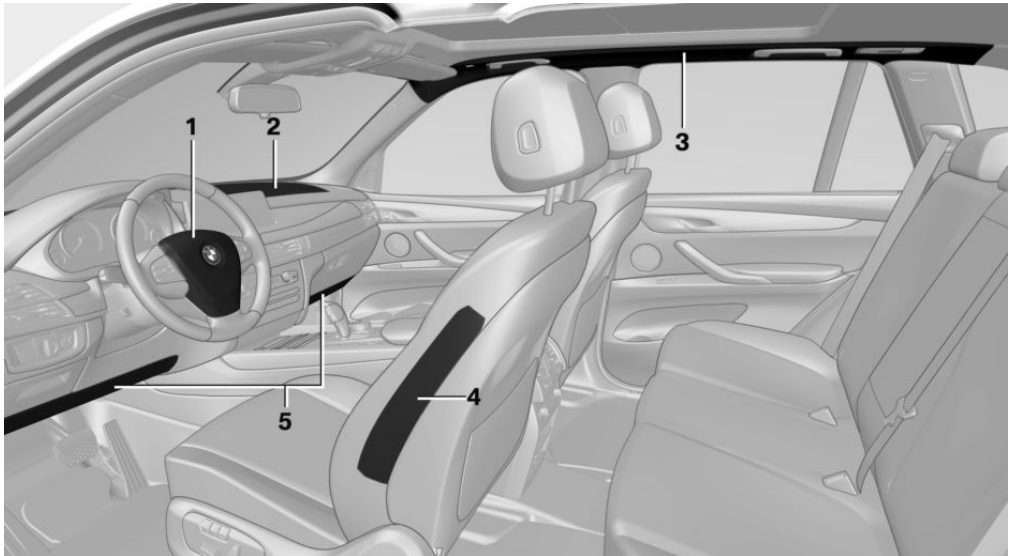

- 1 Front airbag, driver
- 2 Front airbag, front passenger
- 3 Head airbag
- 4 Side airbag
- 5 Knee airbag

Front airbags

Front airbags help protect the driver and the front passenger by responding to frontal impacts in which safety belts alone would not provide adequate protection.

Side airbag

In a lateral impact, the side airbag supports the side of the body in the chest and lap area.

Head airbag

In a lateral impact, the head airbag supports the head.

Ejection Mitigation

The head airbag system is designed as an ejection mitigation countermeasure to reduce the likelihood of ejections of vehicle occupants through side windows during rollovers or side impact events.

Knee airbag

The knee airbag supports the legs in a frontal impact.

Protective action

Airbags are not triggered in every impact situation, e.g., in less severe accidents or rear-end collisions.

Information on optimum effect of the airbags

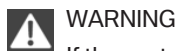

WARNING

If the seat position is incorrect or the deployment area of the airbags is impaired, the airbag system cannot provide protection as intended and may cause additional injuries due to triggering. There is a risk of injuries or danger to life. Follow the information on optimum protective effect of the airbag system. ◀

- ▷ Keep a distance from the airbags.
- ▷ Make sure that occupants keep their heads away from the side airbag.
- ▷ Always grasp the steering wheel on the steering wheel rim. Hold your hands at the 3 o'clock and 9 o'clock positions, to keep the risk of injury to your hands or arms as low as possible when the airbag is triggered.
- ▷ Make sure that the front passenger is sitting correctly, i.e., keeps his or her feet and legs in the floor area and does not support them on the dashboard.
- ▷ There should be no additional persons, animals or objects between an airbag and a person.

- ▷ Do not apply adhesive materials to the airbag cover panels, do not cover them or modify them in any way.
- ▷ Dashboard and windshield on the front passenger side must stay clear - do not attach adhesive labels or coverings and do not attach brackets or cables, for instance for GPS devices or mobile phones.
- ▷ Do not use the cover of the front airbag on the front passenger side as a storage area.
- ▷ Do not place slip covers, seat cushions or other objects on the front passenger seat that are not specifically suited for seats with integrated side airbags.
- ▷ Do not hang pieces of clothing, such as jackets, over the backrests.
- ▷ Never modify either the individual components or the wiring in the airbag system. This also applies to steering wheel covers, the dashboard, and the seats.
- ▷ Do not remove the airbag system.

Even when you follow all instructions very closely, injury from contact with the airbags cannot be fully ruled out in certain situations.

The ignition and inflation noise may lead to short-term and, in most cases, temporary hearing impairment in sensitive occupants.

Vehicle modifications for a person with disabilities may affect the air bag system; therefore, contact BMW Customer Relations or your authorized BMW service center.

Warnings and information on the airbags are also found on the sun visors.

Functional readiness of the airbag system

Safety information



WARNING

Individual components can be hot after triggering of the airbag system. There is a risk of injury. Do not touch individual components. ◀

**WARNING**

Improperly executed work can lead to failure, malfunction or unintentional triggering of the airbag system. In the case of a malfunction, the airbag system might not trigger as intended in the event of an accident despite respective accident severity. There is a risk of injuries or danger to life. Have the airbag system checked, repaired, dismantled and scrapped by a dealer's service center or another qualified service center or repair shop. ◀

Correct function

When the ignition is switched on, the warning lamp in the instrument cluster lights up briefly and thereby indicates the operational readiness of the entire airbag system and the belt tensioner.

Airbag system malfunctioning

- ▶ Warning lamp does not come on when the ignition is turned on.
- ▶ The warning lamp lights up continuously.

Automatic deactivation of the front-seat passenger airbags**Concept**

The system reads if the front passenger seat is occupied by measuring the human body's resistance.

Front, knee and side airbag on the front passenger's side are either activated or deactivated.

General information

Before transporting a child on the front passenger seat, refer to the safety notes and instructions for children on the front passenger seat, see Children.

Safety information**WARNING**

To ensure the front-seat passenger airbag function, the system must be able to detect whether a person is sitting in the front passenger seat. The entire seat cushion area must be used for this purpose. There is a risk of injuries or danger to life. Make sure that the front passenger keeps his or her feet in the floor area. ◀

Malfunction of the automatic deactivation system

When transporting older children and adults, the front-seat passenger airbags may be deactivated in certain sitting positions. In this case, the indicator lamp for the front-seat passenger airbags lights up.

In this case, change the sitting position so that the front-seat passenger airbags are activated and the indicator lamp goes out.

If it is not possible to activate the airbags, have the person sit in the rear.

To enable correct recognition of the occupied seat cushion

- ▶ Do not attach covers, cushions, ball mats or other items to the front passenger seat unless they are specifically determined to be safe for use on the front passenger seat.
- ▶ Do not place any electronic devices on the passenger seat if a child restraint system is to be installed on it.
- ▶ Do not place objects under the seat that could press against the seat from below.
- ▶ No moisture in or on the seat.

Indicator lamp for the front-seat passenger airbags



The indicator lamp for the front-seat passenger airbags indicates the operating state of the front-seat passenger airbags.

The lamp indicates whether the airbags are either activated or deactivated.



- ▶ The indicator lamp lights up when a child is properly seated in a child restraint fixing system or when the seat is empty. The airbags on the front passenger side are not activated.

- ▶ The indicator lamp does not light up when, e.g., a correctly seated person of sufficient size is detected on the seat. The airbags on the front passenger side are activated.

Detected child restraint systems

The system generally detects children seated in a child restraint system, particularly in child restraint systems required by NHTSA at the point in time when the vehicle was manufactured. After installing a child restraint system, make sure that the indicator light for the front-seat passenger airbags lights up. This indicates that the child restraint system has been detected and the front-seat passenger airbags are not activated.

Strength of the driver's and front-seat passenger airbag

The explosive power that activates driver's/ front passenger's airbags very much depends

on the positions of the driver's/front passenger's seat.

To maintain the accuracy of this function over the long term, calibrate the front seats as soon as a respective message appears on the Control Display.

Calibrating the front seats



WARNING

There is a risk of jamming when moving the seats. There is a risk of injury or risk of property damage. Make sure that the area of movement of the seat is clear prior to any adjustment. ◀

A corresponding message appears on the Control Display.

1. Press the switch and move the respective seat all the way forward.
2. Press the switch forward again. The seat still moves forward slightly.
3. Readjust the seat to the desired position.

The calibration procedure is completed when the message on the Control Display disappears.

If the message continues to be displayed, repeat the calibration.

If the message does not disappear after a repeat calibration, have the system checked as soon as possible.

Tire Pressure Monitor TPM

Concept

The system monitors tire inflation pressure in the four mounted tires. The system warns you if there is a significant loss of pressure in one or more tires. For this purpose, sensors in the tire valves measure the tire inflation pressure and tire temperature.

General information

With use of the system observe further information found under Tire inflation pressure, refer to page 216.

Functional requirements

The system must have been reset with the correct tire inflation pressure; otherwise, reliable signaling of tire inflation pressure loss is not assured.

Reset the system after each adjustment of the tire inflation pressure and after every tire or wheel change.

Always use wheels with TPM electronics to ensure that the system will operate properly.

Status display

The current status of the Tire Pressure Monitor TPM can be displayed, for instance whether or not the TPM is active.

Using iDrive:

1. "Vehicle info"
2. "Vehicle status"
3.  "Tire Pressure Monitor (TPM)"

The status is displayed.

Status control display

Tire and system status are indicated by the color of the wheels and a SMS text message on the Control Display.

All wheels green

System is active and will issue a warning related to the tire inflation pressures stored during the last reset.

One wheel is yellow

A flat tire or major drop in inflation pressure in the indicated tire.

All wheels are yellow

A flat tire or major drop in inflation pressure in several tires.

Gray wheels

The system cannot detect a flat tire. Reasons for this may be:

- ▷ The system is being reset.
- ▷ Malfunction.

Status information

The status control display additionally shows the current tire inflation pressures and, depending on the model, tire temperatures. It shows the actual values read; they may vary depending on driving style or weather conditions.

Resetting the system

Reset the system after each adjustment of the tire inflation pressure and after every tire or wheel change.

Using iDrive:

1. "Vehicle info"
2. "Vehicle status"
3.  "Perform reset"
4. Start the engine but do not drive off.
5. Reset tire inflation pressure: "Perform reset".
6. Drive away.

The wheels are displayed in gray and the status is displayed.

After driving faster than 19 mph/30 km/h for a short period, the set tire inflation pressures are accepted as reference values. The reset is completed automatically while driving.

The progress of the reset is displayed.

After a successfully completed Reset, the wheels on the Control Display are shown in green and "Tire Pressure Monitor (TPM) active" is displayed.

You may interrupt this trip at any time. When you continue the reset resumes automatically.

Messages

Required tire inflation pressure check message



A Check Control message is displayed.

- ▷ The system has detected a wheel change, but no reset was done.
- ▷ No reset was performed for the system. System will issue a warning related to the tire inflation pressures stored during the last reset.
- ▷ Inflation was not carried out according to specifications.



A Check Control message is displayed.

The tire inflation pressure has fallen below the level of the last reset.

In these cases:

1. Check the tire pressure and correct as needed.
2. Reset the system.

Message in case of low tire pressure



The yellow warning lamp lights up.



A Check Control message is displayed.

- ▷ There is a tire inflation pressure loss.
- ▷ No reset was performed for the system. System will issue a warning related to the tire inflation pressures stored during the last reset.

In these cases:

1. Reduce your speed and drive moderately. Do not exceed a speed of 80 mph/130 km/h.

2. At the next opportunity, e.g., gas station, check and correct the tire inflation pressure in all four tires, if necessary.
3. Reset the system.

Message in case of sharp tire inflation pressure loss



The yellow warning lamp lights up.

In addition, a symbol with the affected tires will be displayed in the Check Control message.

- ▷ There is a flat tire or a major loss in tire inflation pressure.
- ▷ No reset was performed for the system. The system issues a warning based on the tire inflation pressures stored during the last reset.

In these cases:

1. Reduce your speed and stop cautiously. Avoid sudden braking and steering maneuvers.
2. Check whether the vehicle is fitted with normal tires or run-flat tires.

Run-flat tires, refer to page 223, are labeled with a circular symbol containing the letters RSC marked on the tire's sidewall.



WARNING

A damaged regular tire with low or missing tire inflation pressure impacts handling, such as steering and braking response. Run-flat tires can maintain limited stability. There is a risk of an accident. Do not continue driving if the vehicle is equipped with normal tires. Follow the information on run-flat tires and continued driving with these tires. ◀

A low tire inflation pressure might turn on DSC Dynamic Stability Control.

Actions in the event of a flat tire

Normal tires

1. Identify the damaged tire.

Check the air pressure in all four tires, for instance using the tire pressure gage of a tire repair kit.

If the tire inflation pressure in all four tires is correct, the Tire Pressure Monitor may not have been reset. In this case, perform the reset.

If identification of flat tire damage is not possible, please contact a dealer's service center or another qualified service center or repair shop.

2. Repair the flat tire, for instance with a tire repair kit or by changing the tire.

Use of sealant, for instance from the tire repair kit, may damage the TPM wheel electronics. In this case, have the electronics checked and replaced at the next opportunity.

Run-flat tires

Maximum speed

You may continue driving with a damaged tire at speeds up to 50 mph/80 km/h.

Continued driving with a flat tire

If continuing to drive with a damaged tire:

1. Avoid sudden braking and steering maneuvers.
2. Do not exceed a speed of 50 mph/80 km/h.
3. Check the air pressure in all four tires at the next opportunity.

If the tire inflation pressure in all four tires is correct, the Tire Pressure Monitor may not have been reset. In this case, perform the reset.

Possible driving distance with complete loss of tire inflation pressure:

The possible driving range varies depending on the how the vehicle is loaded and used, e.g., speed, road conditions, external temperature. The driving range may be less but may also be more if an economical driving style is used.

If the vehicle is loaded with an average weight and used under favorable conditions, its possible driving range will be up to 50 miles/80 km.

A vehicle with a damaged tire reacts differently, for instance it has reduced lane stability during braking, a longer braking distance and different self-steering properties. Adjust your driving style accordingly. Avoid abrupt steering maneuvers or driving over obstacles, for instance curbs, potholes, etc.



WARNING

Your vehicle handles differently with a runflat with no or low inflation pressure; for instance, your lane stability when braking is reduced, braking distances are longer and the self-steering properties will change. There is a risk of an accident.

Drive moderately and do not exceed a speed of 50 mph/80 km/h. ◀

Final tire failure

Vibrations or loud noises while driving can indicate the final failure of a tire.

Reduce speed and stop; otherwise, pieces of the tire could come loose and cause an accident.

Do not continue driving. Contact a dealer's service center or another qualified service center or repair shop.

System limits

The system does not function properly if a reset has not been carried out, e.g., a flat tire is reported though tire inflation pressures are correct.

The tire inflation pressure depends on the tire's temperature. Driving or exposure to the sun will increase the tire's temperature, thus

increasing the tire inflation pressure. The tire inflation pressure is reduced when the tire temperature falls again. These circumstances may cause a warning when temperatures fall very sharply.

The system cannot indicate sudden serious tire damage caused by external circumstances.

Malfunction



The yellow warning lamp flashes and then lights up continuously. A Check Control message is displayed. No flat tire or loss of tire inflation pressure can be detected.

Examples and recommendations in the following situations:

- ▷ A wheel without TPM electronics is mounted: Have it checked by a dealer's service center or another qualified service center or repair shop as needed.
- ▷ Malfunction: Have system checked by a dealer's service center or another qualified service center or repair shop.
- ▷ TPM was unable to complete the reset. Reset the system again.
- ▷ Interference caused by systems or devices with the same radio frequency: After leaving the area of the interference, the system automatically becomes active again.

Declaration according to NHTSA/FMVSS 138 Tire Pressure Monitoring System

Each tire, including the spare (if provided) should be checked monthly when cold and inflated to the inflation pressure recommended by the vehicle manufacturer on the vehicle placard or tire inflation pressure label. (If your vehicle has tires of a different size than the size indicated on the vehicle placard or tire inflation pressure label, you should determine the proper tire inflation pressure for those tires.) As an added safety feature, your vehicle has been equipped with a tire pressure monitoring

system (TPMS) that illuminates a low tire pressure telltale when one or more of your tires is significantly under-inflated. Accordingly, when the low tire pressure telltale illuminates, you should stop and check your tires as soon as possible, and inflate them to the proper pressure. Driving on a significantly under-inflated tire causes the tire to overheat and can lead to tire failure. Under-inflation also reduces fuel efficiency and tire tread life, and may affect the vehicle's handling and stopping ability. Please note that the TPMS is not a substitute for proper tire maintenance, and it is the driver's responsibility to maintain correct tire pressure, even if under-inflation has not reached the level to trigger illumination of the TPMS low tire pressure telltale. Your vehicle has also been equipped with a TPMS malfunction indicator to indicate when the system is not operating properly. The TPMS malfunction indicator is combined with the low tire pressure telltale. When the system detects a malfunction, the telltale will flash for approximately one minute and then remain continuously illuminated. This sequence will continue upon subsequent vehicle start-ups as long as the malfunction exists. When the malfunction indicator is illuminated, the system may not be able to detect or signal low tire pressure as intended. TPMS malfunctions may occur for a variety of reasons, including the installation of replacement or alternate tires or wheels on the vehicle that prevent the TPMS from functioning properly. Always check the TPMS malfunction telltale after replacing one or more tires or wheels on your vehicle to ensure that the replacement or alternate tires and wheels allow the TPMS to continue to function properly.

FTM Flat Tire Monitor

Concept

The system detects tire inflation pressure loss on the basis of rotation speed differences between the individual wheels while driving.

In the event of a tire inflation pressure loss, the diameter and therefore the rotational speed of the corresponding wheel changes. This will be detected and reported as a flat tire.

The system does not measure the actual inflation pressure in the tires.

Functional requirements

The system must have been initialized when the tire inflation pressure was correct; otherwise, reliable flagging of a flat tire is not assured. Initialize the system after each correction of the tire inflation pressure and after every tire or wheel change.

Status display

The current status of the flat tire monitor can be displayed, for instance whether the RPA is active.

Using iDrive:

1. "Vehicle info"
2. "Vehicle status"
3.  "Flat Tire Monitor (FTM)"

The status is displayed.

Initialization

When initializing, the set tire inflation pressures serve as reference values in order to detect a flat tire. Initialization is started by confirming the tire inflation pressures.

Do not initialize the system when driving with snow chains.

Using iDrive:

1. "Vehicle info"
2. "Vehicle status"
3.  "Perform reset"
4. Start the engine but do not drive off.
5. Start the initialization with "Perform reset".
6. Drive away.

The initialization is completed while driving, which can be interrupted at any time.

The initialization automatically continues when driving resumes.

Indication of a flat tire



The yellow warning lamp lights up. A Check Control message is displayed.

There is a flat tire or a major loss in tire inflation pressure.

1. Reduce your speed and stop cautiously. Avoid sudden braking and steering maneuvers.
2. Check whether the vehicle is fitted with normal tires or run-flat tires.

Run-flat tires, refer to page 223, are labeled with a circular symbol containing the letters RSC marked on the tire's sidewall.



WARNING

A damaged regular tire with low or missing tire inflation pressure impacts handling, such as steering and braking response. Run-flat tires can maintain limited stability. There is a risk of an accident. Do not continue driving if the vehicle is equipped with normal tires. Follow the information on run-flat tires and continued driving with these tires. ◀

When a flat tire is indicated, DSC Dynamic Stability Control is switched on, if needed.

System limits

A natural, even tire inflation pressure loss in all four tires will not be recognized. Therefore, check the tire inflation pressure regularly.

Sudden serious tire damage caused by external circumstances cannot be recognized in advance.

The system could be delayed or malfunction in the following situations:

- ▶ When the system has not been initialized.
- ▶ When driving on a snowy or slippery road surface.

- ▷ Sporty driving style: spinning traction wheels, high lateral acceleration (drifting).
- ▷ When driving with snow chains.

Actions in the event of a flat tire

Normal tires

1. Identify the damaged tire.

Check the air pressure in all four tires, e.g., using the tire pressure gage of a tire repair kit.

If the tire inflation pressure in all four tires is correct, the Flat Tire Monitor may not have been initialized. In this case, initialize the system.

If identification of flat tire damage is not possible, please contact a dealer's service center or another qualified service center or repair shop.

2. Repair the flat tire, e.g., with a tire repair kit or by changing the tire.

Run-flat tires

Maximum speed

You may continue driving with a damaged tire at speeds up to 50 mph/80 km/h.

Continued driving with a flat tire

If continuing to drive with a damaged tire:

1. Avoid sudden braking and steering maneuvers.
2. Do not exceed a speed of 50 mph/80 km/h.
3. Check the air pressure in all four tires at the next opportunity.

If the tire inflation pressure in all four tires is correct, the Flat Tire Monitor may not have been initialized. In this case, initialize the system.

Possible driving distance with complete loss of tire inflation pressure:

The possible driving range varies depending on the how the vehicle is loaded and used, e.g., speed, road conditions, external temperature. The driving range may be less but may also be more if an economical driving style is used.

If the vehicle is loaded with an average weight and used under favorable conditions, its possible driving range will be up to 50 miles/80 km.

A vehicle with a damaged tire reacts differently, for instance it has reduced lane stability during braking, a longer braking distance and different self-steering properties. Adjust your driving style accordingly. Avoid abrupt steering maneuvers or driving over obstacles, for instance curbs, potholes, etc.



WARNING

Your vehicle handles differently with a runflat with no or low inflation pressure; for instance, your lane stability when braking is reduced, braking distances are longer and the self-steering properties will change. There is a risk of an accident.

Drive moderately and do not exceed a speed of 50 mph/80 km/h. ◀

Final tire failure

Vibrations or loud noises while driving can indicate the final failure of a tire.

Reduce speed and stop; otherwise, pieces of the tire could come loose and cause an accident.

Do not continue driving. Contact a dealer's service center or another qualified service center or repair shop.

Intelligent Safety

Concept

Intelligent Safety enables central operation of the driver assistance system. Depending on how the vehicle is equipped, Intelligent Safety

consists of one or more systems that can help prevent an imminent collision.

- ▷ City light braking function warning, refer to page 121.
- ▷ Pedestrian warning, refer to page 127.
- ▷ Lane departure warning, refer to page 134.
- ▷ Active Blind Spot Detection, refer to page 136.

Safety information



WARNING

Indicators and warnings do not relieve the driver from personal responsibility. Due to system limits, warnings or reactions of the system may not be output or they may be output too late or incorrectly. There is a risk of an accident. Adjust the driving style to the traffic conditions. Watch traffic closely and actively intervene in the respective situations. ◀



WARNING

Due to system limits, individual functions can malfunction during tow-starting/towing with the Intelligent Safety systems activated, e.g., approach control warning with light braking function. There is a risk of an accident. Switch all Intelligent Safety systems off prior to tow-starting/towing. ◀

Overview

Button in the vehicle



Intelligent Safety button

Switching on/off

Some Intelligent Safety systems are automatically active after every departure. Some Intelligent Safety systems activate according to the last setting.



Press button briefly:

- ▷ The menu for the intelligent safety system is displayed. The systems are individually switched off according to their respective settings.
- ▷ LED lights up orange or goes out respective to their individual settings.

Adjust as needed. Individual settings are stored for the profile currently used.



Press button again:

- ▷ All Intelligent Safety systems are activated.
- ▷ The LED lights up green.



Hold down button:

- ▷ All Intelligent Safety systems are switched off.
- ▷ The LED goes out.

Approach control warning

Depending on the equipment, the collision warning system consists of one of the following functions:

- ▷ Approach control warning with City light braking function, refer to page 122.
- ▷ Approach control warning with braking function, refer to page 124

Approach control warning with City light braking function

Concept

The system can help prevent accidents. If an accident cannot be prevented, the system will help reduce the collision speed.

The system sounds a warning before an imminent collision and actuates brakes independently, if needed.

The automatic braking intervention is done with limited force and duration.

A camera in the area of the rearview mirror controls the system.

The approach control warning is available even if cruise control has been deactivated.

With the vehicle approaching another vehicle intentionally, the approach control warning and braking are delayed in order to avoid false system reactions.

General information

The system warns at two levels of an imminent danger of collision at speeds from approx. 3 mph/5 km/h. Time of warnings may vary with the current driving situation.

Appropriate braking kicks in at speeds of up to 35 mph/60 km/h.

Detection range

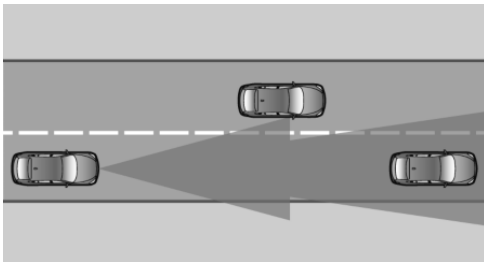

Objects that the system can detect are taken into account.

Safety information



WARNING

Indicators and warnings do not relieve the driver from personal responsibility. Due to system limits, warnings or reactions of the system may not be output or they may be output too late or incorrectly. There is a risk of an accident. Adjust the driving style to the traffic conditions. Watch traffic closely and actively intervene in the respective situations. ◀



WARNING

Due to system limits, individual functions can malfunction during tow-starting/towing with the Intelligent Safety systems activated, e.g., approach control warning with light braking function. There is a risk of an accident. Switch all Intelligent Safety systems off prior to tow-starting/towing. ◀

Overview

Button in the vehicle



Intelligent Safety button

Camera

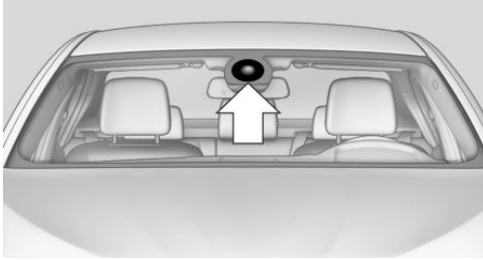

The camera is installed near the interior mirror. Keep the windshield in front of the interior mirror clean and clear.

Switching on/off

Switching on automatically

The system is automatically active after every driving off.

Switching on/off manually



Press button briefly:

- ▶ The menu for the intelligent safety system is displayed. The systems are individually switched off according to their respective settings.
- ▶ LED lights up orange or goes out respectively to their individual settings.

Adjust as needed. The individual settings are stored for the driver profile currently in use.



Press button again:

- ▶ All Intelligent Safety systems are activated.
- ▶ The LED lights up green.



Hold down button:

- ▶ All Intelligent Safety systems are switched off.
- ▶ The LED goes out.

Setting the warning time

The warning time can be set.
Using iDrive:



1. "Settings"
2. "Frontal Coll. Warning"
3. Activate the desired time on the Control Display.

The selected time is stored for the driver profile currently used.

Warning with braking function

Display

A warning symbol appears in the instrument cluster and in the Head-up Display if a collision with a detected vehicle is imminent.

Symbol	Measure
	Symbol lights up red: prewarning. Brake and increase distance.
	Symbol flashes red and an acoustic signal sounds: acute warning. You are requested to intervene by braking or make an evasive maneuver.

Prewarning

This warning is issued, e.g., when there is the impending danger of a collision or the distance to the vehicle ahead is too small.

The driver must intervene actively when there is a prewarning.

Acute warning with braking function

Acute warning is displayed in case of the imminent danger of a collision when the vehicle approaches another object at a high differential speed.

The driver must intervene actively when there is an acute warning. If necessary, the driver is

assisted by a minor automatic braking intervention in a possible risk of collision.

Acute warnings can also be triggered without previous forewarning.

Braking intervention

The warning prompts the driver himself/herself to react. During a warning, the maximum braking force is used. Prerequisite for the brake booster is sufficiently quick and hard stepping on the brake pedal. The system can assist with some braking intervention if there is a risk of a collision. At low speeds vehicles may thus come to a complete stop.

The braking intervention is executed only if vehicle stability has not been restricted, for instance by deactivating the DSC Dynamic Stability Control.

The braking intervention can be interrupted by stepping on the accelerator pedal or by actively moving the steering wheel.

Object detection can be restricted. Observe the limitations of the detection range and functional restrictions.

System limits

Safety information



WARNING

The system can react incorrectly or not at all due to the system limits. There is a risk of accidents or risk of property damage. Observe the information regarding the system limits and actively intervene, if needed. ◀

Detection range

The system's detection potential is limited.

Thus, a system reaction might not come or might come late.

E.g., the following situations may not be detected:

- ▷ Slow moving vehicles when you approach them at high speed.

- ▷ Vehicles that suddenly swerve in front of you, or sharply decelerating vehicles.
- ▷ Vehicles with an unusual rear appearance.
- ▷ Two-wheeled vehicles ahead of you.

Functional limitations

The system may not be fully functional in the following situations:

- ▷ In heavy fog, rain, sprayed water or snowfall.
- ▷ In tight curves.
- ▷ If the driving stability control systems are limited or deactivated, for instance DSC OFF.
- ▷ If, depending on the vehicle equipment version, the field of view of the camera in the mirror or the radar sensor is dirty or obscured.
- ▷ Up to 10 seconds after the start of the engine via the Start/Stop button.
- ▷ During calibration of the camera immediately after vehicle delivery.
- ▷ If there are constant blinding effects because of oncoming light, for instance from the sun low in the sky.

Warning sensitivity

The more sensitive the warning settings are, such as the warning time, the more warnings are displayed. However, there may also be an excess of false warnings.

Collision warning with braking function

The concept

The system can help prevent accidents. If an accident cannot be prevented, the system will help reduce the collision speed.

The system sounds a warning before an imminent collision and actuates brakes independently if needed.

The automatic braking intervention may be executed with maximum braking force and for a brief period only as necessary.

If the vehicle is equipped with Active Cruise Control with Stop&Go, the front-end collision warning is controlled via the cruise control radar sensor in conjunction with a camera.

The front-end collision warning is available even if cruise control has been deactivated.

With the vehicle approaching another vehicle intentionally, the collision warning and braking are delayed in order to avoid false system reactions.

General information

The system issues a two-phase warning of a possible danger of collision with vehicles at speeds above approx. 3 mph/5 km/h. Time of warnings may vary with the current driving situation.

Detection range

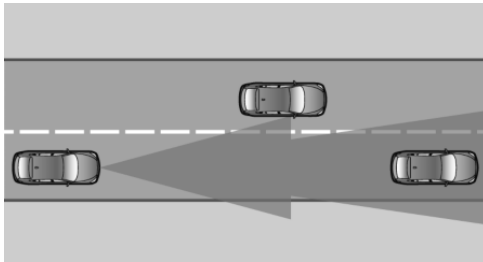

Objects that the system can detect are taken into account.

Safety information

WARNING
Indicators and warnings do not relieve the driver from personal responsibility. Due to system limits, warnings or reactions of the system may not be output or they may be output

too late or incorrectly. There is a risk of an accident. Adjust the driving style to the traffic conditions. Watch traffic closely and actively intervene in the respective situations. ◀



WARNING

Due to system limits, individual functions can malfunction during tow-starting/towing with the Intelligent Safety systems activated, e.g., approach control warning with light braking function. There is a risk of an accident. Switch all Intelligent Safety systems off prior to tow-starting/towing. ◀

Overview

Button in the vehicle



Intelligent Safety button

Radar sensor

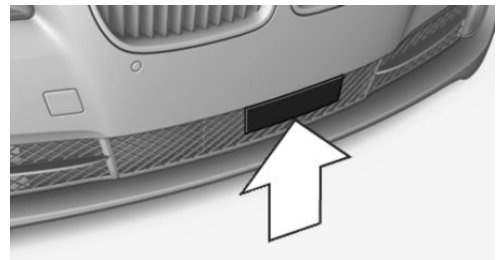

The radar sensor is located in the lower area of the front bumper.

Always keep radar sensor clean and unobstructed.

Camera

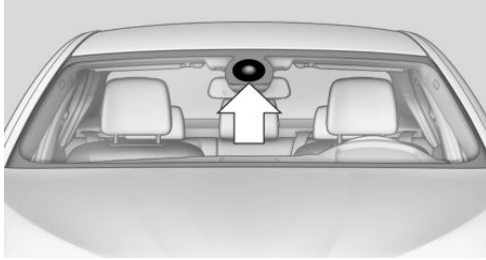

The camera is installed near the interior mirror. Keep the windshield in the area behind the interior mirror clean and clear.

Switching on/off

Switching on automatically

The system is automatically active after every driving off.

Switching on/off manually



Press button briefly:

- ▶ The menu for the intelligent safety system is displayed. The systems are individually switched off according to their respective settings.

- ▶ LED lights up orange or goes out respectively to their individual settings.

Adjust as needed. The individual settings are stored for the driver profile currently in use.



Press button again:

- ▶ All Intelligent Safety systems are activated.

- ▶ The LED lights up green.



Hold down button:

- ▶ All Intelligent Safety systems are switched off.

- ▶ The LED goes out.

Setting the warning time

The warning time can be set.

Using iDrive:

1. "Settings"
2. "Frontal Coll. Warning"
3. Activate the desired time on the Control Display.

The selected time is stored for the driver profile currently used.

Warning with braking function

Display

A warning symbol appears in the instrument cluster and in the Head-up Display if a collision with a detected vehicle is imminent.

Symbol	Measure
	Symbol lights up red: prewarning. Brake and increase distance.
	Symbol flashes red and an acoustic signal sounds: acute warning. You are requested to intervene by braking or make an evasive maneuver.



Symbol lights up red: prewarning. Brake and increase distance.



Symbol flashes red and an acoustic signal sounds: acute warning.

You are requested to intervene by braking or make an evasive maneuver.

Prewarning

This warning is issued, e.g., when there is the impending danger of a collision or the distance to the vehicle ahead is too small.

The driver must intervene actively when there is a prewarning.

Acute warning with braking function

Acute warning is displayed in case of the imminent danger of a collision when the vehicle approaches another object at a high differential speed.

The driver must intervene actively when there is an acute warning. If necessary, the driver is

assisted by an automatic braking intervention in a possible risk of collision.

Acute warnings can also be triggered without previous forewarning.

Braking intervention

The warning prompts the driver himself/herself to react. During a warning, the maximum braking force is used. Premise for the brake booster is sufficiently quick and hard stepping on the brake pedal. The system can assist with automatic braking intervention if there is risk of a collision. The intervention can bring the vehicle to a complete stop.

The braking intervention is executed only if vehicle stability has not been restricted, e.g. by deactivating the DSC Dynamic Stability Control.

Above approx. 130 mph/210 km/h the braking intervention occurs as a brief braking pressure. No automatic delay occurs.

The braking intervention can be interrupted by stepping on the accelerator pedal or by actively moving the steering wheel.

Object detection can be restricted. Limitations of the detection range and functional restrictions are to be considered.

System limits

Safety information



WARNING

The system can react incorrectly or not at all due to the system limits. There is a risk of accidents or risk of property damage. Observe the information regarding the system limits and actively intervene, if needed. ◀

Detection range

The system's detection potential is limited. Thus, a system reaction might not come or might come late.

E.g., the following situations may not be detected:

- ▷ Slow moving vehicles when you approach them at high speed.
- ▷ Vehicles that suddenly swerve in front of you, or sharply decelerating vehicles.
- ▷ Vehicles with an unusual rear appearance.
- ▷ Two-wheeled vehicles ahead of you.

Functional limitations

The system may not be fully functional in the following situations:

- ▷ In heavy fog, rain, sprayed water or snowfall.
- ▷ In tight curves.
- ▷ If the driving stability control systems are limited or deactivated, for instance DSC OFF.
- ▷ If, depending on the vehicle equipment version, the field of view of the camera in the mirror or the radar sensor is dirty or obscured.
- ▷ Up to 10 seconds after the start of the engine via the Start/Stop button.
- ▷ During calibration of the camera immediately after vehicle delivery.
- ▷ If there are constant blinding effects because of oncoming light, for instance from the sun low in the sky.

Warning sensitivity

The more sensitive the warning settings are, such as the warning time, the more warnings are displayed. However, there may also be an excess of false warnings.

Pedestrian warning

Depending on how the vehicle is equipped, the function warns of an imminent collision with pedestrians during daytime or nighttime.

The function is subdivided into the following systems:

- ▷ During daytime:
Pedestrian warning with city braking function, refer to page 128
- ▷ At night: Night vision, refer to page 130

Pedestrian warning with Approach control

Concept

The system can help prevent accidents with pedestrians.

When driving at city speeds, the system will issue a warning if there is imminent danger of a collision with pedestrians and includes a braking function.

The camera in the area of the rearview mirror controls the system.

General information

With sufficient brightness, the system warns about possible collision danger with pedestrians starting at approx. 6 mph/10 km/h to approx. 35 mph/60 km/h and assists with braking before a collision.

The system reacts to people who are within the detection range of the system.

Detection range

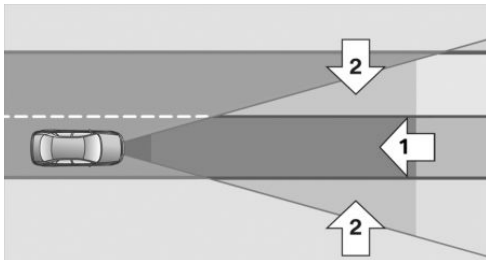

The detection area in front of the vehicle is divided into two areas:

- ▷ Central area, arrow 1, directly in front of the vehicle.
- ▷ Expanded area, arrow 2, to the right and left of the central area.

A collision is imminent if pedestrians are located within the central area. A warning is issued about pedestrians who are located within the extended area only if they are moving in the direction of the central area.

Safety information



WARNING

Indicators and warnings do not relieve the driver from personal responsibility. Due to system limits, warnings or reactions of the system may not be output or they may be output too late or incorrectly. There is a risk of an accident. Adjust the driving style to the traffic conditions. Watch traffic closely and actively intervene in the respective situations. ◀



WARNING

Due to system limits, individual functions can malfunction during tow-starting/towing with the Intelligent Safety systems activated, e.g., approach control warning with light braking function. There is a risk of an accident. Switch all Intelligent Safety systems off prior to tow-starting/towing. ◀

Overview

Button in the vehicle





Intelligent Safety button

Camera

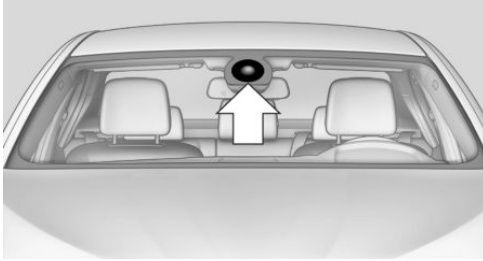

The camera is installed near the interior mirror. Keep the windshield in front of the interior mirror clean and clear.

Switching on/off

Switching on automatically

The system is automatically active after every driving off.

Switching on/off manually



Press button briefly:

- ▶ The menu for the intelligent safety system is displayed. The systems are individually switched off according to their respective settings.
- ▶ LED lights up orange or goes out respective to their individual settings.

Adjust as needed. The individual settings are stored for the driver profile currently in use.



Press button again:

- ▶ All Intelligent Safety systems are activated.
- ▶ The LED lights up green.



Hold down button:

- ▶ All Intelligent Safety systems are switched off.
- ▶ The LED goes out.

Warning with braking function

Display

If a collision with a person detected in this way is imminent, a warning symbol appears on the instrument cluster and in the Head-up Display.



The red symbol is displayed and a signal sounds.



With instrument display: the red symbol is displayed and a signal sounds.

Intervene immediately by braking or make an evasive maneuver.

Braking intervention

The warning prompts the driver himself/herself to react. During a warning, the maximum braking force is used. Prerequisite for the brake booster is sufficiently quick and hard stepping on the brake pedal. The system can assist with some braking intervention if there is a risk of a collision. At low speeds vehicles may thus come to a complete stop.

The braking intervention is executed only if vehicle stability has not been restricted, for instance by deactivating the DSC Dynamic Stability Control.

The braking intervention can be interrupted by stepping on the accelerator pedal or by actively moving the steering wheel.

Object detection can be restricted. Observe the limitations of the detection range and functional restrictions.

System limits

Safety information



WARNING

The system can react incorrectly or not at all due to the system limits. There is a risk of accidents or risk of property damage. Observe the information regarding the system limits and actively intervene, if needed. ◀

Detection range

The detection potential of the camera is limited.

Thus, a warning might not be issued or be issued late.

E.g., the following situations may not be detected:

- ▷ Partially covered pedestrians.
- ▷ Pedestrians that are not detected as such because of the viewing angle or contour.
- ▷ Pedestrians outside of the detection range.
- ▷ Pedestrians having a body size less than 32 in/80 cm.

Functional limitations

The system may not be fully functional or may not be available in the following situations:

- ▷ In heavy fog, rain, sprayed water or snowfall.
- ▷ In tight curves.
- ▷ If the driving stability control systems are deactivated, for instance DSC OFF.
- ▷ If the field of view of the camera or the windshield are dirty or covered.
- ▷ Up to 10 seconds after the start of the engine via the Start/Stop button.
- ▷ During calibration of the camera immediately after vehicle delivery.
- ▷ If there are constant blinding effects because of oncoming light, for instance from the sun low in the sky.

- ▷ When it is dark outside.

Night Vision with Pedestrian and Animal Detection

Concept

Night Vision with pedestrian and animal detection is a night vision system.

An infrared camera scans the area in front of the vehicle and issues a warning if it detects pedestrians and animals on the street. Warm objects that are similar in shape to human beings or animals are detected by the system. If necessary, the heat image can be displayed on the Control Display.

Thermal image



The image shows the heat radiated by objects in the field of view of the camera.

Warm objects have a light appearance and cold objects a dark appearance.

The ability to detect an object depends on the temperature difference between the object and the background and on the level of heat radiation emitted by the object. Objects that are similar in temperature to the environment or that radiate very little heat are difficult to detect.

For safety reasons, when driving at speeds above approx. 3 mph/5 km/h and in low ambient light, the image is only displayed when the low beams are activated.

A still image is displayed at regular intervals for a fraction of a second.

Pedestrian and animal detection



Object detection and object warning only function in darkness.

Objects whose form is similar to people with sufficient heat radiation are detected.

In addition, the system also detects animals above a certain minimum size, for example, deer.

Display on the Control Display with heat image activated:

- ▶ People detected by the system: in light yellow.
- ▶ Animals detected by the system: in dark yellow.

Range of object detection, with good ambient conditions:

- ▶ Pedestrian detection: up to approx. 330 ft/100 m
- ▶ Detection of large animals: up to approx. 490 ft/150 m
- ▶ Detection of medium animals: up to approx. 230 ft/70 m

Environmental influences can limit the availability of object detection.

If the vehicle systems detect that the vehicle is located in a residential area, the animal detection is temporarily switched off.

Safety information



WARNING

The system does not release from the personal responsibility to correctly assess visibility and traffic situation. There is a risk of an accident. Adjust the driving style to the traffic conditions. Watch traffic closely and actively intervene in the respective situations. ◀

Overview

Buttons in the vehicle



Intelligent Safety button



Switching on/switching off heat image

Camera

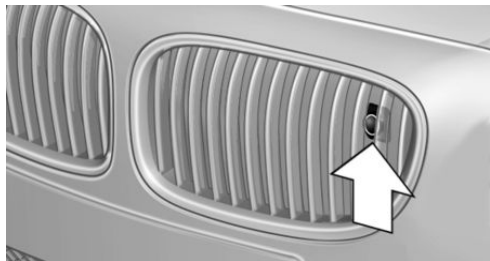

The camera is automatically heated when the external temperatures are low.

The camera lens is automatically cleaned together with the headlamps.

Switching on/off

Switching on automatically

When it is dark outside, the system is automatically active after every driving-off.

Switching on/off manually



Press button briefly:

- ▶ The menu for the intelligent safety system is displayed. The systems are individually switched off according to their respective settings.
- ▶ LED lights up orange or goes out respective to their individual settings.

Adjust as needed. The individual settings are stored for the driver profile currently in use.



Press button again:

- ▶ All Intelligent Safety systems are activated.
- ▶ The LED lights up green.



Hold down button:

- ▶ All Intelligent Safety systems are switched off.
- ▶ The LED goes out.

Switching on heat image additionally

The heat image from the Night Vision camera can also be displayed on the Control Display. This function has no effect on object detection.



Press button.

The image from the camera is displayed on the Control Display.

Adjustments via the iDrive

With heat image switched on:

1. Press the Controller.
2. Select brightness or contrast.
 - ▶ ☀ Select the symbol.
 - ▶ 🌑 Select the symbol.
3. Turn the Controller until the desired setting is selected.
4. Press the Controller.

Display

Warning of people or animals in danger

If a collision with a person or an animal detected in this way is imminent, a warning symbol appears on the instrument cluster and in the Head-up Display.

Although both the shape and the heat radiation are analyzed, false warnings cannot be ruled out.

Warning area in front of the vehicle

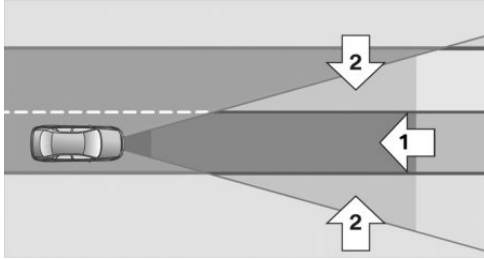

The warning area for the person warning consists of two parts:

- ▶ Central area, arrow 1, directly in front of the vehicle.
- ▶ Expanded area, arrow 2, to the right and left of the central area.

With animal warnings, no distinction is made between the central or expanded area.

The entire area moves along with the vehicle in the direction of the steering angle and changes with the vehicle speed. As the vehicle speed increases, the area becomes, for instance longer and wider.

Symbols

Symbol	Meaning
	Prewarning: pedestrian warning.
	Prewarning: animal warning.
	Acute warning: pedestrian warning in the instrument cluster.
	Acute warning: pedestrian warning in the instrument display.
	Acute warning: animal warning in the instrument cluster.

Symbol	Meaning
	Acute warning: animal warning in the instrument display.
Symbol lights up yellow.	Prewarning.
Symbol lights up red and a signal sounds.	Acute warning.

The displayed symbol may vary and shows the side of the road on which the person or animal was detected.

Display in the Head-up Display

The warning is displayed simultaneously in the Head-up Display and on the instrument cluster.

Prewarning

Prewarning for persons is displayed when a person is detected in the central area immediately in front of the vehicle as well as on the left or right side in the extended area.

Prewarning for animals is displayed when an animal is detected in the front of the vehicle.

The driver must intervene actively by braking or making an evasive maneuver when there is a prewarning.

Acute warning

Acute warning is displayed if a person or an animal is detected in direct proximity if front of the vehicle.

The driver must immediately intervene actively by braking or making an evasive maneuver when there is an acute warning.

System limits

Basic limits

The system may not be fully functional in the following situations:

- ▷ On steep hills, in steep depressions or in tight curves.
- ▷ If the camera is soiled or damaged.
- ▷ In heavy fog, rain or snowfall.
- ▷ At very high external temperatures.

Limits of pedestrian and animal detection

In some situations, it may occur that pedestrians are detected as animals or animals as pedestrians.

Small animals are not detected by the object detection function, even if they are clearly visible in the image.

Limited detection, for example in the following circumstances:

- ▷ People or animals who are fully or partially covered, especially when their heads are covered.
- ▷ People who are not in an upright position, for example, lying down.
- ▷ Cyclists on unconventional bicycles (for example, recumbent bicycles).
- ▷ After physical damage to the system, for example, after an accident.

No display on the rear screen

The image from Night Vision cannot be displayed on the rear screen.

Lane departure warning

Concept

Starting at a specific speed, this system alerts you when the vehicle on streets with lane markings is about to leave the lane. This

speed, depending on the country version, is between 35 mph/55 km/h and 45 mph/70 km/h.

The steering wheel begins vibrating gently in the event of warnings. The time of the warning may vary depending on the current driving situation.

The system does not provide a warning if the turn signal is set before leaving the lane.

Safety information



WARNING

The system does not release the driver from the personal responsibility to correctly assess route and traffic situation. There is a risk of an accident. Adjust the driving style to the traffic conditions. Watch traffic closely and actively intervene in the respective situations. In the event of a warning, do not unnecessarily jerk the steering wheel. ◀

Overview

Button in the vehicle



Intelligent Safety button

Camera

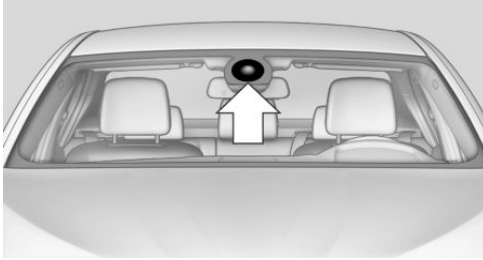

The camera is installed near the interior mirror. Keep the windshield in front of the interior mirror clean and clear.

Switching on/off

Switching on automatically

The lane departure warning is automatically activated after departure, if the function was switched on the last time the engine was stopped.

Switching on/off manually



Press button briefly:

- ▷ The menu for the intelligent safety system is displayed. The systems are individually switched off according to their respective settings.
- ▷ LED lights up orange or goes out respective to their individual settings.

Adjust as needed. The individual settings are stored for the driver profile currently in use.



Press button again:

- ▷ All Intelligent Safety systems are activated.
- ▷ The LED lights up green.



Hold down button:

- ▷ All Intelligent Safety systems are switched off.

- ▷ The LED goes out.

Display in the instrument cluster



- ▷ Lines: system is activated.
- ▷ Arrows: at least one lane marking was detected and warnings can be issued.

Display in the instrument display



- ▷ Symbol orange: system is activated.
- ▷ Green symbol: at least one lane marking was detected and warnings can be issued.

Issued warning

If you leave the lane and if a lane marking has been detected, the steering wheel begins vibrating.

If the turn signal is set before changing the lane, a warning is not issued.

End of warning

The warning is canceled in the following situations:

- ▷ Automatically after approx. 3 seconds.
- ▷ When returning to your own lane.
- ▷ When braking hard.
- ▷ When using the turn signal.

System limits

Safety information



WARNING

The system can react incorrectly or not at all due to the system limits. There is a risk of accidents or risk of property damage. Observe the information regarding the system limits and actively intervene, if needed. ◀

Functional limitations

The system may not be fully functional in the following situations:

- ▷ In heavy fog, rain or snowfall.
- ▷ In the event of missing, worn, poorly visible, merging, diverging, or multiple lane markings such as in construction areas.
- ▷ When lane markings are covered in snow, ice, dirt or water.
- ▷ In tight curves or on narrow lanes.
- ▷ When the lane markings are covered by objects.
- ▷ When driving very close to the vehicle in front of you.
- ▷ When driving toward bright lights.
- ▷ When the windshield in front of the interior mirror is fogged over, dirty or covered with stickers, etc.
- ▷ During calibration of the camera immediately after vehicle delivery.

Active Blind Spot Detection

The concept

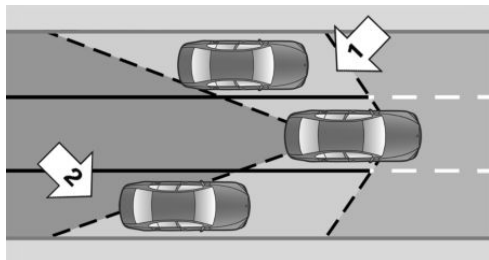

Two radar sensors in the rear bumper monitor the area behind and next to the vehicle at speeds above approx. 30 mph/50 km/h.

The system indicates whether there are vehicles in the blind spot, arrow 1, or approaching from behind on the adjacent lane, arrow 2.

The lamp in the exterior mirror housing is dimmed.

Before you change lanes after setting the turn signal, the system issues a warning in the situations described above.

The lamp in the exterior mirror housing flashes and the steering wheel vibrates.

Safety information



WARNING

The system does not release from the personal responsibility to correctly assess visibility and traffic situation. There is a risk of an accident. Adjust the driving style to the traffic conditions. Watch traffic closely and actively intervene in the respective situations. ◀

Overview

Button in the vehicle



Intelligent Safety button

Radar sensors



The radar sensors are located in the rear bumper.

Switching on/off

Switching on automatically

The Active Blind Spot Detection is automatically activated after departure, if the function was switched on the last time the engine was stopped.

Switching on/off manually



Press button briefly:

- ▶ The menu for the intelligent safety system is displayed. The systems are individually switched off according to their respective settings.
- ▶ LED lights up orange or goes out respective to their individual settings.

Adjust as needed. The individual settings are stored for the driver profile currently in use.



Press button again:

- ▶ All Intelligent Safety systems are activated.
- ▶ The LED lights up green.



Hold down button:

- ▶ All Intelligent Safety systems are switched off.
- ▶ The LED goes out.

Display

Lamp in the exterior mirror housing

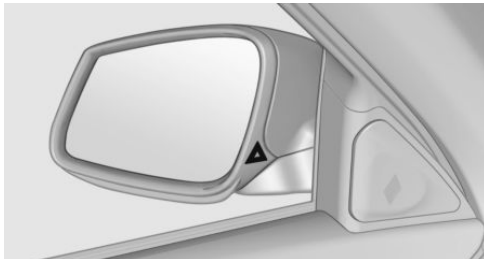

Prewarning

The dimmed lamp in the exterior mirror housing indicates when there are vehicles in the blind spot or approaching from behind.

Acute warning

If the turn signal is set while a vehicle is in the critical zone, the steering wheel vibrates briefly and the lamp in the exterior mirror housing flashes brightly.

The warning stops when the turn signal is switched off, or the other vehicle leaves the critical zone.

Brief flashing

A brief flashing of the lamp during vehicle unlocking serves as system self-test.

System limits

Safety information



WARNING

The system can react incorrectly or not at all due to the system limits. There is a risk of accidents or risk of property damage. Observe the information regarding the system limits and actively intervene, if needed. ◀

Functional limitations

The system may not be fully functional in the following situations:

- ▶ When a vehicle is approaching at a speed much faster than your own.
- ▶ In heavy fog, rain or snowfall.
- ▶ In tight curves or on narrow lanes.
- ▶ If the bumper is dirty or iced up, or covered with stickers.
- ▶ If cargo protrudes.

A Check Control message is displayed when the system is not fully functional.

Brake force display

Concept

Additional brake lamps indicate emergency braking to the traffic behind. This can reduce the risk of a rear-end collision.

General information



- ▷ During normal brake application, the bottom brake lights light up.
- ▷ During heavy brake application, the top brake lights additionally light up.

Active Protection

General information

The Active Protection safety package consists of systems that are independent of each other:

- ▷ Attentiveness assistant.
- ▷ PreCrash.
- ▷ PostCrash.

Attentiveness assistant

Concept

The system can detect decreasing alertness or fatigue of the driver during long, monotonous trips, e.g., on highways. In this situation, it is recommended that the driver takes a break.

Safety information



WARNING

The system does not release from the personal responsibility to correctly assess one's physical state. An increasing lack of alertness or fatigue may not be detected or not be detected in time. There is a risk of an accident. Make sure that the driver is rested and alert. Adjust the driving style to the traffic conditions. ◀

Function

The system is activated each time the engine is started and cannot be switched off.

After travel has begun, the system monitors certain aspects of the driver's behavior, so that decreasing alertness or fatigue can be detected.

This procedure takes the following criteria into account:

- ▷ Personal driving style, e.g., steering behavior.
- ▷ Driving conditions, e.g., length of trip.

Starting at approximately 43 mph/70 km/h, the system is active and can display a recommendation to take a break.

Break recommendation

If the driver becomes less alert or fatigued, a message is displayed in the Control Display with the recommendation to take a break.

A recommendation to take a break is displayed only once during an uninterrupted trip.

After a break, another recommendation to take a break cannot be displayed until after approximately 45 minutes.

System limits

The function may be limited in the following situations, e.g., and will either output an incorrect warning or no warning at all:

- ▷ When the clock is set incorrectly.

- ▷ When the vehicle speed is mainly below about 43 mph/70 km/h.
- ▷ With a sporty driving style, such as during rapid acceleration or when cornering fast.
- ▷ In active driving situations, such as when changing lanes frequently.
- ▷ When the road surface is poor.
- ▷ In the event of strong side winds.

The system is reset approx. 45 minutes after parking the vehicle, e.g., in the case of a break during longer trips on highways.

PreCrash

The concept

With this system critical driving situations that might result in an accident can be detected above a speed of approx. 20 mph/30 km/h. In these situations, preventive measures are automatically taken to minimize the risk of an accident as much as possible.

Critical driving situations may include:

- ▷ Emergency stop.
- ▷ Severe understeering.
- ▷ Severe oversteering.

If the vehicle includes the front-end collision warning or front-end collision warning with braking feature, impending collisions with vehicles driving ahead or stopped in front of you can also be detected within the system's range.

Safety information



WARNING

The system does not release from the personal responsibility. Due to the system limits, critical situation could not be detected reliably or in time. There is a risk of an accident. Adjust the driving style to the traffic conditions. Watch traffic closely and actively intervene in the respective situations. ◀

Function

After the safety belt is buckled, the front safety belts are automatically tightened once after the vehicle drove off.

In critical driving situations, the following individual functions become active as needed:

- ▷ The front safety belts are automatically pretensioned.
- ▷ Automatic closing of the windows.
- ▷ Automatic closing of the glass sunroof.
- ▷ For vehicles equipped with Comfort Seats: automatic positioning of the backrest for the front passenger seat.

After a critical driving situation without an accident, the front safety belts are loosened again. All other systems can be restored to the desired setting.

If the belt tension does not loosen automatically, stop the vehicle and unbuckle the safety belt using the red button in the buckle. Fasten the safety belt before continuing on your trip.

PostCrash

Concept

In the event of an accident, the system can bring the vehicle to a halt automatically without intervention by the driver in certain situations. This can reduce the risk of a further collision and the consequences thereof.

Harder vehicle braking

It can be necessary to bring the vehicle in certain situations to a halt quicker.

Here, a higher braking pressure must be generated for a short period when pressing the brake pedal than during automatic braking. This interrupts automatic braking.

Interrupting automatic braking

It can be necessary to interrupt automatic braking in certain situations, e.g., for an evasive maneuver.

Interrupt automatic braking:

- ▷ By pressing the brake pedal.
- ▷ By pressing the accelerator pedal.

At standstill

After coming to a halt, the brake is released automatically.

Driving stability control systems

Vehicle features and options

This chapter describes all standard, country-specific and optional features offered with the series. It also describes features that are not necessarily available in your vehicle, e. g., due to the selected options or country versions. This also applies to safety-related functions and systems. When using these functions and systems, the applicable laws and regulations must be observed.

Anti-lock Braking System ABS

ABS prevents locking of the wheels during braking.

The vehicle maintains its steering power even during full brake applications, thus increasing active safety.

ABS is operational every time you start the engine.

Brake assistant

When you apply the brakes rapidly, this system automatically produces the greatest possible braking force boost. It reduces the braking distance to a minimum during emergency stop. This system utilizes all of the benefits provided by ABS.

Do not reduce the pressure on the brake pedal for the duration of the emergency stop.

Adaptive brake assistant

In combination with Active Cruise Control, this system ensures that the brakes respond even more rapidly when braking in critical situations.

Drive-off assistant

Concept

This system supports driving off on inclines. The parking brake is not required.

Driving off with the drive-off assistant

1. Hold the vehicle in place with the foot brake.
2. Release the foot brake and drive off without delay.

After the foot brake is released, the vehicle is held in place for approx. 2 seconds.

Depending on the vehicle load, the vehicle may roll back slightly.

Automatic Differential Brake

The system controls the driving force by automatic braking intervention on individual wheels. The function corresponds to a differential lock: the system detects if a wheel begins to spin, because of loose road surface, e.g., and automatically brakes it.

The driving force is diverted to the wheel with better traction.

As a result, the engine force is transferred more efficiently to the wheels during accelerations.

Dynamic Performance Control DPC

The Dynamic Performance Control increases both the agility of the vehicle as well as the lane stability.

The system seamlessly handles the distribution of the drive torque between the two rear wheels.

Depending on the situation, the drive torque is shifted from the wheel on the inside of the curve to the wheel on the outside of the curve or vice-versa.

To increase the maneuverability, the rear wheel on the outside of the curve is accelerated when a sporty driving style is used.

The steering responds directly; simultaneously, the understeering tendency of the four-wheel drive is reduced.

With the oversteering tendency, the system exerts a stabilizing effect by accelerating the rear wheel on the inside of the curve.

The system noticeably improves the traction and simultaneously increases the driving safety, especially on road surfaces having fluctuating coefficients of friction.

DSC Dynamic Stability Control

Concept

Within the physical limits, the system helps to keep the vehicle on a steady course by reducing engine speed and by applying brakes to the individual wheels.

General information

Dynamic Stability Control detects, e.g., the following unstable driving conditions:

- ▷ Fishtailing, which can lead to oversteering.
- ▷ Loss of traction of the front wheels, which can lead to understeering.

Dynamic Traction Control DTC, refer to page 143, is a version of the DSC where forward momentum is optimized.

Safety information

 **WARNING**

The system does not release from the personal responsibility to correctly assess the traffic situation. Based on the limits of the sys-

tem, it cannot independently react to all traffic situations. There is a risk of an accident. Adjust the driving style to the traffic conditions. Watch traffic closely and actively intervene in the respective situations. ◀

 **WARNING**

When driving with roof load, e.g., with roof-mounted luggage rack, driving safety may not be ensured in driving-critical situations due to the elevated center of gravity. There is a risk of accidents or risk of property damage. Do not deactivate Dynamic Stability Control DSC when driving with roof load. ◀

Overview

Button in the vehicle



 DSC OFF button

Indicator/warning lights

 The indicator lamp flashes: DSC controls the drive and braking forces.

The indicator lamp lights up: DSC has malfunctioned.

Deactivating DSC: DSC OFF

When DSC is deactivated, driving stability is reduced during acceleration and when driving in curves.

To increase vehicle stability, activate DSC again as soon as possible.

Deactivating DSC



Press and hold this button but not longer than approx. 10 seconds, until the indicator light for DSC OFF lights up in the instrument cluster and displays DSC OFF.

DSC is switched off.

The steering and, depending on the equipment, suspension are tuned for sporty driving.

Activating DSC



Press button.

DSC OFF and the DSC OFF indicator lamp go out.

Indicator/warning lights

When DSC is deactivated, DSC OFF is displayed in the instrumented cluster.



The indicator lamp lights up: DSC is deactivated.

DTC Dynamic Traction Control

Concept

DTC is a version of the DSC where forward momentum is optimized.

The system ensures maximum headway on special road conditions or loose road surfaces, e.g., unplowed snowy roads, but with somewhat limited driving stability.

When DTC is activated, the vehicle has maximum traction. Driving stability is limited during acceleration and when driving in curves.

Therefore, drive with appropriate caution.

You may find it useful to briefly activate DTC under the following special circumstances:

- ▶ When driving in slush or on uncleared, snow-covered roads.

- ▶ When freeing vehicle from deep snow or driving off from loose ground.
- ▶ When driving with snow chains.

Deactivating/activating DTC Dynamic Traction Control

Activating DTC



Press button.

TRACTION is displayed in the instrument cluster and the indicator light for DSC OFF lights up.

Deactivating DTC



Press button again.

TRACTION and the DSC OFF indicator light go out.

Indicator/warning lights

If DTC is activated, TRACTION is displayed in the instrument cluster.



The indicator lamp lights up: DTC Dynamic Traction Control is activated.

xDrive

xDrive is the all-wheel-drive system of your vehicle. Concerted action by the xDrive and DSC further optimize traction and driving dynamics. The xDrive all-wheel-drive system variably distributes the drive forces to the front and rear axles as demanded by the driving situation and road surface.

Display on the Control Display

Displaying xDrive view

1. "Vehicle info"
2. "xDrive status"
3.  "xDrive view"

The following information is displayed:

- ▷ With a navigation system: compass display for the driving direction
- ▷ Pitch attitude with degree and percentage.
- ▷ Transverse gradient with degree indication.
- ▷ Graphic display for the steering.

Displaying distribution of the drive torque

1. "Vehicle info"
2. "xDrive status"
3.  "Torque distribution"

HDC Hill Descent Control

Concept

HDC is a downhill driving assistant that automatically controls vehicle speed on steep downhill gradients. Without applying the brakes, the vehicle moves at slightly more than walking speed. If the brakes are actively applied, the system distributes force according to the traction.

Vehicle stability and maneuverability are improved on downhill gradients.

Hill Descent Control can be activated at speeds below approx. 22 mph/35 km/h. When driving downhill, the vehicle reduces its speed and then keeps its speed constant.

Only use HDC in low gears or in selector lever position D or R.

Increasing or decreasing vehicle speed

Specify desired speed in the range from approx. 4 mph/6 km/h to approx. 15 mph/25 km/h using the rocker switch of the cruise control on the steering wheel. Vehicle speed can be changed by lightly accelerating.

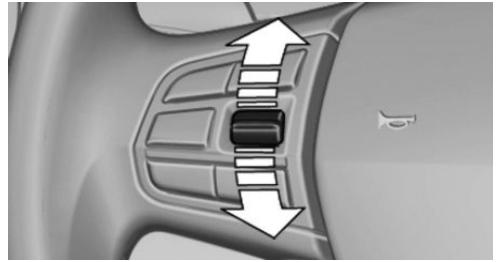

- ▷ Press the rocker switch up to the point of resistance: the speed increases gradually.
- ▷ Press up the rocker switch past the point of resistance: the speed increases while the rocker switch is pressed.
- ▷ Press the rocker switch down to the point of resistance: the speed decreases gradually.
- ▷ Press the rocker switch down past the point of resistance: when driving forward, the speed decreases to approx. 6 mph/10 km/h; when reversing, the speed decreases to approx. 4 mph/6 km/h.

Activating HDC



-  Press button; the LED above the button lights up.

Deactivating HDC

-  Press button again. The LED goes out.
HDC is automatically deactivated above approx. 37 mph/60 km/h.

Display in the instrument cluster



The selected speed is displayed in the speedometer.

- ▷ Green: the system is actively braking the vehicle.
- ▷ Orange: the system is on standby.

Malfunction

A message is displayed in the instrument cluster. HDC is not available, for instance, at elevated brake temperatures.

Active roll stabilization

Concept

The system reduces the lateral tilt of the vehicle that occurs during rapid driving in curves or during quick evasive maneuvers.

Driving stability and driving comfort are increased under all driving conditions. The system utilizes active stabilizer bars on the front and rear axles that react immediately to all driving situations.

Programs

The system offers two different programs.

Select the programs via the Driving Dynamics Control.

SPORT

Sporty tuning for greater driving agility.

COMFORT

Comfort-oriented tuning for optimal comfort.

Vertical Dynamic Control

Concept

This system reduces undesirable vehicle motion when using a dynamic driving style or traveling on uneven road surfaces.

This enhances the driving dynamics and driving comfort depending on the road surface condition and driving style.

Programs

The system offers several different programs. Select the programs via the Driving Dynamics Control.

SPORT/SPORT+

Consistently sporty control of the shock absorbers for greater driving agility.

COMFORT/ECO PRO

Balanced tuning.

Self-leveling suspension

The concept

The self-leveling suspension keeps the vehicle height and ground clearance constant. The height of the vehicle at the rear axle is maintained at a predefined level under all load conditions.

The system ensures consistent comfort by keeping spring travel constant in all driving situations.

Malfunction

A Check Control message is displayed. The system is disrupted. Vehicle handling may be altered and driving comfort may be noticeably reduced. Visit the nearest dealer's service center or another qualified service center or repair shop.

Driving Dynamics Control

The concept



The Driving Dynamics Control can be used to adjust the driving dynamics of the vehicle. For this purpose various programs are available for selection that are activated via the two buttons of the Driving Dynamics Control and the DSC OFF-button.

Overview

Button in the vehicle



Operating the programs

Press button	Program
	DSC OFF TRACTION
	SPORT+ SPORT COMFORT ECO PRO

Automatic program change

The system may automatically switch to COMFORT in the following situations:

- ▷ Failure of DSC Dynamic Stability Control.
- ▷ The vehicle has a flat tire.
- ▷ When activating cruise control in TRACTION or DSC OFF mode.

DSC OFF

Driving stability is limited during acceleration and when driving in curves.

To increase vehicle stability, activate DSC again as soon as possible.

Deactivating DSC: DSC OFF



Press and hold this button but not longer than approx. 10 seconds, until the indicator lamp for DSC OFF lights up in the instrument cluster and displays DSC OFF.

The DSC system is switched off.

Activating DSC



Press button.

DSC OFF and the DSC OFF indicator lamp go out.

Indicator/warning lights

When DSC OFF is activated, DSC OFF is displayed in the instrument cluster.



The indicator lamp lights up: DSC OFF is activated.

TRACTION

Maximum traction on loose road surfaces. DTC Dynamic Traction Control is switched on. Driving stability is limited during acceleration and when driving in curves.

Activating TRACTION



Press button.

TRACTION is displayed in the instrument cluster and the indicator lamp for DSC OFF lights up.

Deactivating TRACTION



Press button again.

TRACTION and the DSC OFF indicator lamp go out.

Indicator/warning lights

If TRACTION is activated, TRACTION is displayed in the instrument cluster.



The indicator lamp lights up: TRACTION is activated.

SPORT+

Concept

Sporty driving with optimized chassis and suspension and adjusted drivetrain with limited driving stabilization.

General information

Dynamic Traction Control is switched on.

The driver handles several of the stabilization tasks.

Activating SPORT+



Press button repeatedly until SPORT+ appears in the instrument cluster and the DSC OFF indicator light lights up.

Automatic program change

When switching on the manual speed limiter or activating cruise control, the program automatically switches to SPORT mode.

Indicator/warning lights

SPORT+ is displayed in the instrument cluster.



The DSC OFF indicator lamp lights up: Dynamic Traction Control is activated.

SPORT

Consistently sporty tuning of the suspension and drivetrain for greater driving agility with maximum driving stabilization.

Activating SPORT



Press button repeatedly until SPORT is displayed in the instrument cluster.

Configuring SPORT

When the display is activated on the Control Display, refer to page 148, the SPORT driving mode can be set.

After the SPORT driving mode is activated, select "Configure SPORT" on the displayed panel and configure the program.

SPORT can also be configured before it is activated.

Using iDrive:

1. "Settings"
2. "SPORT mode" or: "Driving mode"
3. Configure driving mode.

The configuration is stored for the profile currently used.

This configuration is retrieved when the SPORT driving mode is activated.

COMFORT

Concept

For a balanced tuning with maximum driving stabilization.

Activating COMFORT



Press button repeatedly until COMFORT is displayed in the instrument cluster.

In certain situations, the system automatically changes to the NORMAL program, automatic program change, refer to page 146.

ECO PRO

ECO PRO, refer to page 204, provides consistent tuning to minimize fuel consumption for maximum range with maximum driving stabilization.

Comfort functions and the engine controller are adjusted.

The program can be configured to individual specifications.

Activating ECO PRO



Press button repeatedly until ECO PRO is displayed in the instrument cluster.

Configuring ECO PRO

1. Activate ECO PRO.
2. "Configure ECO PRO"

Make the desired settings.

Displays in the instrument cluster

Selected program

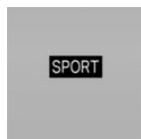

The instrument cluster displays the selected program.

Program selection

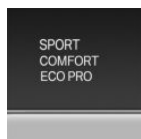

Pressing the button displays a list of the selectable programs. Depending on your vehicle's optional features, the list in the instrument cluster can differ from the illustration shown.

Display on the Control Display

Program changes can be displayed briefly on the Control Display.

To do so, make the following settings:

1. "Settings"
2. "Driving mode"
3. "Driving mode info"

Driving comfort

Vehicle features and options

This chapter describes all standard, country-specific and optional features offered with the series. It also describes features that are not necessarily available in your vehicle, e. g., due to the selected options or country versions. This also applies to safety-related functions and systems. When using these functions and systems, the applicable laws and regulations must be observed.

Active Cruise Control with Stop&Go function, ACC

Concept

Using this system, a desired speed and a distance to a vehicle ahead can be adjusted using the buttons on the steering wheel.

The system maintains the desired speed on clear roads. For this purpose, the vehicle accelerates or brakes automatically.

If a vehicle is driving ahead of you, the system adjusts the speed of your vehicle within the given system limits so that the set distance to the vehicle ahead is maintained.

The distance can be adjusted in several steps. For safety reasons, it depends on the respective speed.

If the vehicle ahead of you brakes to a halt, and then proceeds to drive again within a brief period, the system is able to detect this within the given system limits.

General information

Depending on the driving settings, the features of the cruise control can change in certain areas.

Safety information



WARNING

The system does not release from the personal responsibility to correctly assess the traffic situation. Based on the limits of the system, it cannot independently react to all traffic situations. There is a risk of an accident. Adjust the driving style to the traffic conditions. Watch traffic closely and actively intervene in the respective situations. ◀



WARNING

An unsecured vehicle can begin to move and possibly roll away. There is a risk of an accident. Before exiting, secure the vehicle against rolling.

In order to ensure that the vehicle is secured against rolling away, observe the following:

- ▷ Set the parking brake.
- ▷ On uphill grades or on a downhill slope, turn the front wheels in the direction of the curb.
- ▷ On uphill grades or on a downhill slope, also secure the vehicle, e.g., with a wheel chock. ◀



WARNING

The desired speed can be incorrectly adjusted or called up by mistake. There is a risk of an accident. Adjust the desired speed to the traffic conditions. Watch traffic closely and actively intervene in the respective situations. ◀



WARNING

Risk of accident due to too high speed differences to other vehicles, e.g., in the following situations:







- ▷ When fast approaching a slowly moving vehicle.
- ▷ Suddenly swerving vehicle onto the own lane.

- ▷ When fast approaching standing vehicles.

There is a risk of injuries or danger to life. Watch traffic closely and actively intervene in the respective situations. ◀

Overview

Buttons on the steering wheel

Button	Function
	Cruise control on/off, interrupt, refer to page 150
	Store/maintain speed, refer to page 151
	Resume speed, continue cruise control, refer to page 152
	Reduce distance, refer to page 152
	Increase distance, refer to page 152
	Rocker switch: Set speed, refer to page 151

Radar sensor

A radar sensor is located in the front bumper for detecting vehicles on the road ahead of the vehicle.

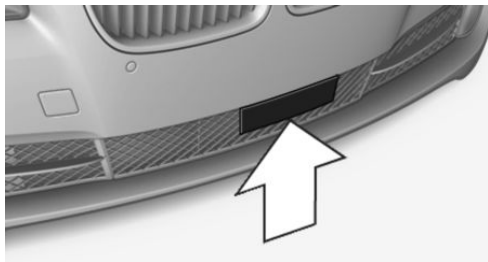

Always keep radar sensor clean and unobstructed.

Camera

A camera in the area of the interior mirror serves to detect vehicles.

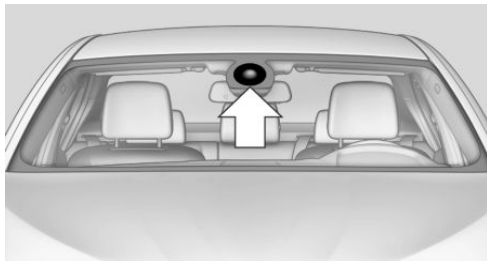

Keep the windshield in front of the interior mirror clean and clear.

Functional requirements

Speed range

The system is best used on well-constructed roads.

The minimum speed that can be set is 20 mph/30 km/h. The maximum speed that can be set depends on the vehicle.

The system can also be activated when stationary.

Switching on/off and interrupting cruise control

Switching on

 Press button on the steering wheel.

The indicator lights in the instrument cluster light up and the mark in the speedometer is set to the current speed.

Cruise control can be used.

DSC will be switched on, if needed.

Switching off

To switch off the system while standing, step on brake pedal at the same time.



Press button on the steering wheel.

- ▶ If active: press twice.
- ▶ If interrupted: press once.

The displays go out. The stored desired speed is deleted.

Interrupting manually



Press button on the steering wheel.

If interrupting the system while stationary, press on the brake pedal at the same time.

Interrupting automatically

The system is automatically interrupted in the following situations:

- ▶ When the driver applies the brakes.
- ▶ When selector lever position D is disengaged.
- ▶ When DTC is activated or DSC is deactivated.
- ▶ When DSC is actively controlling stability.
- ▶ When SPORT+ is activated with Driving Dynamics Control.
- ▶ If the safety belt is unbuckled and the driver's door is opened while the vehicle is standing still.
- ▶ If the system has not detected objects for an extended period, for instance on a road with very little traffic without curb or shoulder markings.
- ▶ If the detection range of the radar is impaired, for instance by dirt or heavy fog.
- ▶ After a longer stationary period when the vehicle has been braked to a stop by the system.

Setting the speed

Maintaining/storing the speed

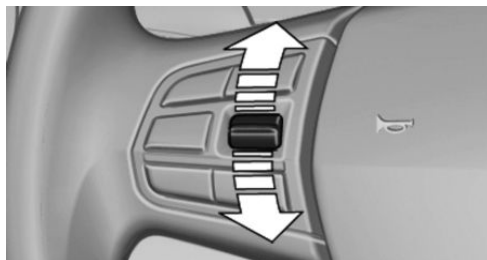

Press the rocker switch while the system is interrupted.

When the system is switched on, the current speed is maintained and stored as the desired speed.

The stored speed is displayed in the speedometer and briefly in the instrument cluster, refer to page 152.

DSC will be switched on, if needed.



The speed can also be stored by pressing a button.

Press button.

Changing the speed

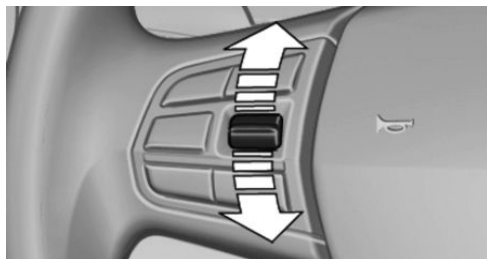

Press the rocker switch up or down repeatedly until the desired speed is set.

If active, the displayed speed is stored and the vehicle reaches the stored speed when the road is clear.

- ▷ Each time the rocker switch is pressed to the point of resistance, the desired speed increases or decreases by approx. 1 mph/1 km/h.
- ▷ Each time the rocker switch is pressed past the point of resistance, the desired speed increases or decreases by a maximum of 5 mph/10 km/h.

Hold the rocker switch in position to repeat the action.

Adjusting distance

Safety information



WARNING

The system does not release from the personal responsibility. Due to the system limits, braking can be late. There is a risk of accidents or risk of property damage. Be aware to the traffic situation at all times. Adjust the distance to the traffic and weather conditions and maintain the prescribed safety distance, possibly by braking. ◀

Reduce distance



Press button repeatedly until the desired distance is set.

Instrument cluster will display selected distance, refer to page 152.

Increase distance



Press button repeatedly until the desired distance is set.

Instrument cluster will display selected distance, refer to page 152.

Continuing cruise control

General information

An interrupted cruise control can be continued by calling up the stored speed.

Make sure that the difference between current speed and stored speed is not too large before calling up the stored speed. Otherwise, unintentional braking or accelerating may occur.

In the following cases, the stored speed value is deleted and cannot be called up again:

- ▷ When the system is switched off.
- ▷ When the ignition is switched off.

Calling up stored speed and distance



Press button with the system switched on.

Displays in the instrument cluster

Desired speed and stored speed

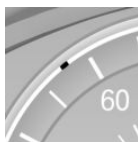

- ▷ Marking lights up green: system is active, the marking indicates the desired speed.
- ▷ Marking lights up orange: system is interrupted, the marking indicates the stored speed.

- ▷ The marking does not light up: the system is switched off.



With instrument display: the symbol is displayed in the speedometer similarly to the mark for the desired speed.

Brief status display



Selected desired speed.

If no speed is indicated, it is possible that the conditions necessary for operation are not currently fulfilled.

Distance to vehicle ahead of you

Selected distance to the vehicle ahead of you is shown.

Distance display



Distance 1



Distance 2



Distance 3



Distance 4

This value is set automatically after the system is switched on.



The system has been interrupted or distance control is temporarily suppressed because the accelerator pedal is being pressed; a vehicle was not detected.



Distance control is temporarily suppressed because the accelerator pedal is being pressed; a vehicle was detected.

Detected vehicle



Symbol lights up orange:

A vehicle has been detected ahead of you.

Rolling bars: the detected vehicle has driven away.

ACC does not accelerate. To accelerate, activate ACC by briefly stepping on the accelerator pedal, pressing the RES button or rocker switch.

Indicator/warning lights



Symbol flashes orange:

The conditions are not adequate for the system to work.

The system was deactivated but applies the brakes until you actively resume control by

pressing on the brake pedal or accelerator pedal.



Symbol flashes red and a signal sounds:

You are requested to intervene by braking or make an evasive maneuver.

Displays in the Head-up Display

Some system information can also be displayed in the Head-up Display.

Distance information



The symbol is displayed when the distance from the vehicle traveling ahead is too short.

The distance information is active under the following circumstances:

- ▷ Active Cruise Control switched off.
- ▷ Display in the Head-up Display selected, refer to page 103.
- ▷ Distance too short.
- ▷ Speed greater than approx. 40 mph/70 km/h.

System limits

Detection range

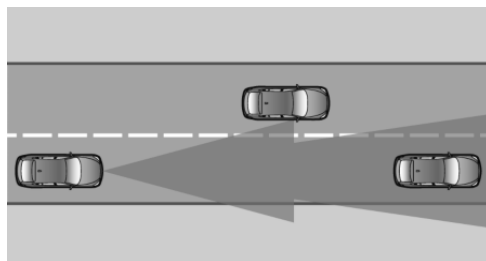

The detection capacity of the system and the automatic braking capacity are limited.

Two-wheeled vehicles for instance might not be detected.

Deceleration

The system also does not decelerate in the following situations:

- ▷ For pedestrians or similarly slow-moving road users.
- ▷ For red traffic lights.
- ▷ For cross traffic.
- ▷ For oncoming traffic.

Swerving vehicles

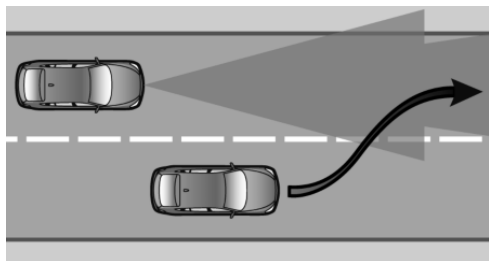

A vehicle driving in front of you is not detected until it is completely within the same lane as your vehicle.

If a vehicle driving ahead of you suddenly swerves into your lane, the system may not be able to automatically restore the selected distance. This also applies to major speed differences to vehicles driving ahead of you, e.g., when rapidly approaching a truck. When a vehicle driving ahead of you is reliably detected, the system requests that the driver intervene by braking and carrying out evasive maneuvers, if needed.

Cornering



If the desired speed is too high for a curve, the speed is reduced slightly, although curves cannot be anticipated in advance. Therefore, drive into a curve at an appropriate speed.

In tight curves the system offers only restricted detection where a vehicle ahead of you might be detected late or not at all.

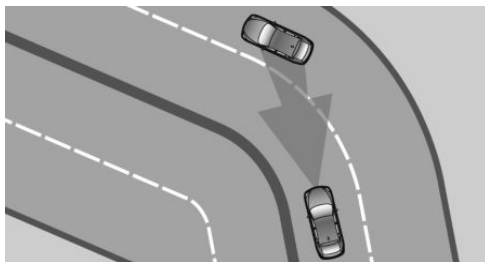

When you approach a curve the system may briefly report vehicles in the next lane due to the bend of the curve. If the system decelerates you may compensate it by briefly accelerating.

After releasing the accelerator pedal the system is reactivated and controls speed independently.

Driving away

In some situations, the vehicle cannot drive off automatically; for example:

- ▷ On steep inclines.
- ▷ From bumps in the road.

In these cases, step on the accelerator pedal.

Weather

In the event of unfavorable weather and light conditions, e.g., if there is rain, snowfall, slush, fog or glare, this may result in poorer recognition of vehicles as well as short-term interruptions for vehicles that are already detected. Drive attentively, and react to the current traffic situation. If necessary, intervene actively, e.g., by braking, steering or evading.

Engine power

The desired speed is also maintained downhill, but may not be maintained on uphill grades if engine power is insufficient.

Malfunction

The system cannot be activated if the radar sensor is not aligned correctly. This may be caused by damage incurred, e.g., during parking.

A Check Control message is displayed if the system fails.

The function for detecting and responding when approaching stationary vehicles may be limited in the following situations:

- ▶ During calibration of the camera immediately after vehicle delivery.
- ▶ If the camera is malfunctioning or dirty. A Check Control message is displayed.

Cruise control

The concept

Using this system, a desired speed can be adjusted using the buttons on the steering wheel. The system maintains the desired speed. The system accelerates and brakes automatically as needed.

General information

Depending on the driving settings, the features of the cruise control can change in certain areas.

Safety information



WARNING

The system does not release from the personal responsibility to correctly assess the traffic situation. Based on the limits of the system, it cannot independently react to all traffic situations. There is a risk of an accident. Adjust the driving style to the traffic conditions. Watch traffic closely and actively intervene in the respective situations. ◀



WARNING

The use of the system can lead to an increased risk of accidents in the following situations:

- ▶ On winding roads.
- ▶ In heavy traffic.
- ▶ On slippery roads, in fog, snow or rain, or on a loose road surface.

There is a risk of accidents or risk of property damage. Only use the system if driving at constant speed is possible. ◀







WARNING

The desired speed can be incorrectly adjusted or called up by mistake. There is a risk of an accident. Adjust the desired speed to the traffic conditions. Watch traffic closely and actively intervene in the respective situations. ◀

Overview

Buttons on the steering wheel

Press button	Function
	Cruise control on/off, interrupting, refer to page 156.
	Store/maintain speed, refer to page 156.

Press button	Function
	Resume speed, continue cruise control, refer to page 157.
	Rocker switch: Set speed, refer to page 156.

Switching on/off and interrupting cruise control

Switching on

 Press button on the steering wheel.

The marking in the speedometer is set to the current speed.

The cruise control can be used.

DSC will be switched on if needed.

Switching off

 Press button on the steering wheel.

▷ If active: press twice.

▷ If interrupted: press once.

The displays go out. The stored desired speed is deleted.

Interrupting manually

 When active, press the button.

Interrupting automatically

The system is automatically interrupted in the following situations:

- ▷ When the driver applies the brakes.
- ▷ When selector lever position D is disengaged.
- ▷ When DTC is activated or DSC is deactivated.
- ▷ When DSC is actively controlling stability.
- ▷ If HDC is activated.

- ▷ When SPORT+ is activated with Driving Dynamics Control.

Setting the speed

Maintaining/storing the speed

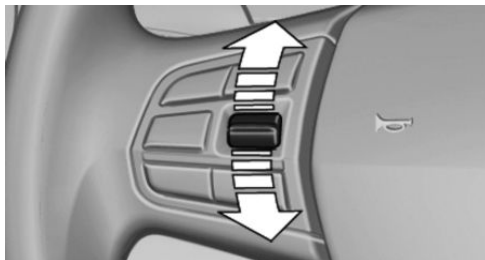

Press the rocker switch while the system is interrupted.

When the system is switched on, the current speed is maintained and stored as the desired speed.

This is displayed in the speedometer and briefly in the instrument cluster, refer to page 157.

DSC will be switched on, if needed.

 The speed can also be stored by pressing a button.

Press button.

Changing the speed

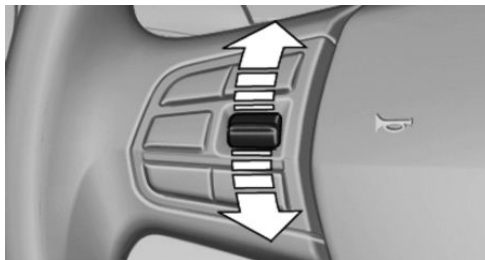

Press the rocker switch up or down repeatedly until the desired speed is set.

If active, the displayed speed is stored and the vehicle reaches the stored speed when the road is clear.

- ▷ Each time the rocker switch is pressed to the point of resistance, the desired speed increases or decreases by approx. 1 mph/1 km/h.
- ▷ Each time the rocker switch is pressed past the point of resistance, the desired speed increases or decreases by a maximum of 5 mph/10 km/h.
The maximum speed that can be set depends on the vehicle.
- ▷ Pressing the rocker switch to the resistance point and holding it accelerates or decelerates the vehicle without requiring pressure on the accelerator pedal.

After the rocker switch is released, the vehicle maintains its final speed. Pressing the switch beyond the resistance point causes the vehicle to accelerate more rapidly.

Continuing cruise control

General information

An interrupted cruise control can be continued by calling up the stored speed.

Make sure that the difference between current speed and stored speed is not too large before calling up the stored speed. Otherwise, unintentional braking or accelerating may occur.

In the following cases, the stored speed value is deleted and cannot be called up again:

- ▷ When the system is switched off.
- ▷ When the ignition is switched off.

Calling up stored speed

 Press button.

The stored speed is reached and maintained.

Displays in the instrument cluster

Indicator lamp



Depending on how the vehicle is equipped, the indicator lamp in the instrument cluster indicates whether the system is switched on.

Desired speed and stored speed



- ▷ Marking lights up green: system is active, the marking indicates the desired speed.
- ▷ Marking lights up orange: system is interrupted, the marking indicates the stored speed.
- ▷ The marking does not light up: the system is switched off.



With instrument display: the symbol is displayed in the speedometer similarly to the mark for the desired speed.

Brief status display



Selected desired speed.

If no speed is indicated, it is possible that the conditions necessary for operation are not currently fulfilled.

Displays in the Head-up Display

Some system information can also be displayed in the Head-up Display.

System limits

Engine power

The desired speed is also maintained downhill, but may not be maintained on uphill grades if engine power is insufficient.

PDC Park Distance Control

Concept

PDC is a support when parking. When you slowly approach an object in the rear - or also in the front of the vehicle if the feature is available - then the object is reported through:

- ▷ Signal tones.
- ▷ Visual display.

General information

The ultrasound sensors for measuring the distances are located in the bumpers.

The maneuvering range, depending on the obstacle and environmental conditions, is approx. 6 ft/2 m.

An acoustic warning is first given in the following situations:

- ▷ By the front sensors and the two rear corner sensors at approx. 24 in/60 cm from the object.
- ▷ By the rear middle sensors at a distance to the object of approx. 5 ft/1.50 m.
- ▷ When a collision is imminent.

Safety information



WARNING

The system does not release from the personal responsibility to correctly assess the traffic situation. Based on the limits of the system, it cannot independently react to all traffic situations. There is a risk of an accident. Adjust the driving style to the traffic conditions. Watch traffic closely and actively intervene in the respective situations. ◀



WARNING

Due to high speeds when PDC is activated, the warning can be delayed due to physical circumstances. There is a risk of injury or risk of property damage. Avoid approaching an object too fast. Avoid driving off fast while PDC is not yet active. ◀

Overview

With front PDC: button in vehicle



Park assistance button

Ultrasound sensors



Ultrasound sensors of the PDC, e.g., in the bumpers.

Functional requirements

Ensure full functionality:

- ▷ Do not cover sensors, for instance with stickers, bicycle racks.
- ▷ Keep the sensors clean and unobstructed.

Switching on/off

Switching on automatically

The system switches on automatically in the following situations:

- ▷ If selector lever position R is engaged when the engine is running.
The rearview camera also switches on.
- ▷ If equipped with front PDC: when obstacles are detected behind or in front of the vehicle by PDC and the speed is slower than approx. 2.5 mph/4 km/h.

You may turn off automatic activation when obstacles are detected. Using iDrive:

1. "Settings"
2. "Parking"
3. Select setting.

The setting is stored for the driver profile currently used.

If necessary, switch off automatic PDC activation on obstacle detection, for instance in vehicle washes, to reduce false alarms.

Automatic deactivation during forward travel

The system switches off when a certain driving distance or speed is exceeded.

Switch the system back on, if needed.

With front PDC: switching on/off manually



Press park assistance button.

- ▷ On: the LED lights up.
- ▷ Off: the LED goes out.

The rearview camera image is displayed if the reverse gear is engaged when pressing the park assistance button.

WARNING

Signal tones

When approaching an object, an intermittent sound indicates the position of the object. E.g., if an object is detected to the left rear of the vehicle, a signal tone sounds from the left rear speaker.

The shorter the distance to the object, the shorter the intervals.

If the distance to a detected object is less than approx. 10 inches/25 cm, a continuous tone is sounded.

With front PDC: if objects are simultaneously located both in front of and behind the vehicle, an alternating continuous signal is sounded.

The signal tone is switched off, when selector lever position P is engaged on vehicles with Steptronic transmission.

Volume

The ratio of the PDC signal tone volume to the entertainment volume can be adjusted.

Using iDrive:

1. "Multimedia", "Radio" or "Settings"
2. "Tone"
3. "Volume settings"
4. "PDC"
5. Turn the controller until the desired setting is selected.
6. Press the controller.

Settings are stored for the profile currently used.

Visual warning

The approach of the vehicle to an object can be shown on the Control Display. Objects that are farther away are already displayed on the Control Display before a signal sounds.

A display appears as soon as Park Distance Control (PDC) is activated.

The range of the sensors is represented in the colors green, yellow and red.

When the image of the rearview camera is displayed, the switch can be made to PDC:

 "Rear view camera"

System limits

Safety information



WARNING

The system can react incorrectly or not at all due to the system limits. There is a risk of accidents or risk of property damage. Observe

the information regarding the system limits and actively intervene, if needed. ◀

Limits of ultrasonic measurement

Ultrasonic measurements might not function in the following situations:

- ▷ For small children and animals.
- ▷ For persons with certain clothing, e.g., coats.
- ▷ With external interference of the ultrasound, e.g., from passing vehicles or loud machines.
- ▷ When sensors are dirty, iced over, damaged or out of position.
- ▷ Under certain weather conditions such as high relative humidity, rain, snowfall, extreme heat or strong wind.
- ▷ With tow bars and trailer couplings of other vehicles.
- ▷ With thin or wedge-shaped objects.
- ▷ With moving objects.
- ▷ With elevated, protruding objects such as ledges or cargo.
- ▷ With objects with corners and sharp edges.
- ▷ With objects with a fine surface structure such as fences.
- ▷ For objects with porous surfaces.
- ▷ If cargo protrudes.
- ▷ Low objects already displayed, e.g., curbs, can move into the blind area of the sensors before or after a continuous tone sounds.

False warnings

The system may issue a warning under the following conditions even though there is no obstacle within the detection range:

- ▷ In heavy rain.
- ▷ When sensors are very dirty or covered with ice.
- ▷ When sensors are covered in snow.

- ▷ On rough road surfaces.
- ▷ On uneven surfaces, such as speed bumps.
- ▷ In large buildings with right angles and smooth walls, for instance in underground garages.
- ▷ In automatic vehicle washes.
- ▷ Due to heavy exhaust.
- ▷ Due to other ultrasound sources, for instance sweeping machines, high pressure steam cleaners or neon lights.

If necessary, switch off automatic PDC activation on obstacle detection, for instance in vehicle washes, to reduce false alarms.

Malfunction

A Check Control message is displayed.

The range of the sensors is shown as a shaded area on the Control Display.

PDC has failed. Have the system checked by a dealer's service center or another qualified service center or repair shop.

Surround View

Concept

Surround View comprises various camera assistance systems that help the driver when parking, maneuvering, and at complex exits and intersections.

- ▷ Rearview camera, refer to page 160
- ▷ Top View, refer to page 163.
- ▷ Side View, refer to page 165.

Rearview camera

Concept

The rearview camera provides assistance in parking and maneuvering backwards. The area

behind the vehicle is shown on the Control Display.

Safety information



WARNING

The system does not relieve from the personal responsibility to correctly assess the traffic situation. There is a risk of an accident. Adjust the driving style to the traffic conditions. Watch traffic and vehicle surroundings closely and actively intervene in the respective situations. ◀

Overview

Button in the vehicle



Park assistance button

Camera

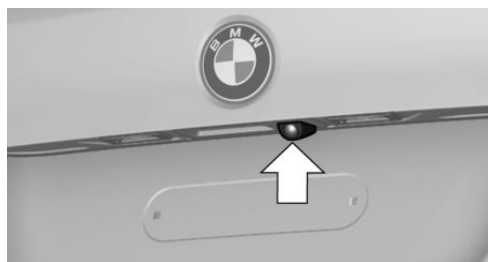

The camera lens is located in the handle of the tailgate. The image quality may be impaired by dirt.

Clean the camera lens if necessary.

Switching on/off

Switching on automatically

The system is switched on automatically if selector lever position R is engaged when the engine is running.

Automatic deactivation during forward travel

The system switches off when a certain driving distance or speed is exceeded.

Switch the system back on, if needed.

Switching on/off manually



Press park assistance button.

- ▷ On: the LED lights up.
- ▷ Off: the LED goes out.

The PDC is shown on the Control Display.

The rearview camera image is displayed when the reverse gear is engaged when pressing the park assistance button.

Switching the view via iDrive

With PDC activated or Top View switched on:

"Rear view camera"

The rearview camera image is displayed.

Display on the Control Display

Functional requirement

- ▷ The rearview camera is switched on.
- ▷ The tailgate is fully closed.
- ▷ Keep the recording range of the camera clear. Protruding cargo or carrier systems and trailers that are not connected to a trailer power socket can lead to malfunctions.

Activating assistance functions

More than one assistance function can be active at the same time.

- ▷ Parking aid lines
 - 🅑 "Parking aid lines"
 - Lanes and turning radius are indicated.
- ▷ Obstacle marking
 - 🅑 "Obstacle marking"
 - Spatially-shaped markings are displayed.

Pathway lines

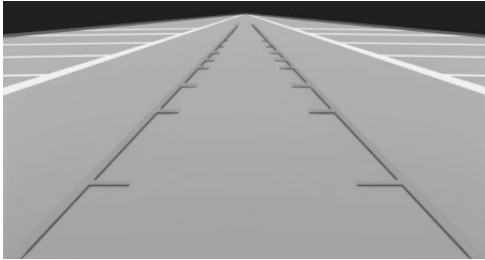

Pathway lines can be superimposed on the image of the rearview camera.

Pathway lines help you to estimate the space required when parking and maneuvering on level roads.

Pathway lines depend on the current steering angle and are continuously adjusted to the steering wheel movements.

Turning radius lines

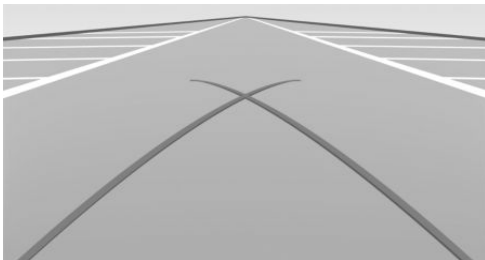

Turning radius lines can only be superimposed on the rearview camera image together with pathway lines.

Turning radius lines show the course of the smallest possible turning radius on a level road.

Only one turning radius line is displayed after the steering wheel is turned past a certain angle.

Obstacle marking

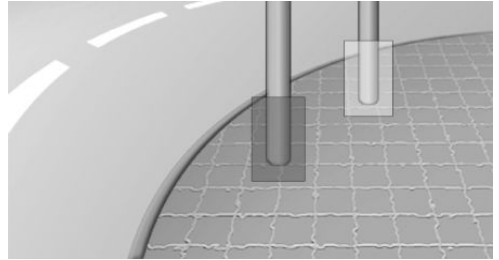

Obstacles behind the vehicle are detected by the PDC sensors and, when respectively equipped, detected by the rearview camera.

Obstacle markings can be faded into the image of the rearview camera.

The colored thresholds of the obstacle markings match the markings of the PDC.

Parking using pathway and turning radius lines

1. Position the vehicle so that the turning radius lines lead to within the limits of the parking space.

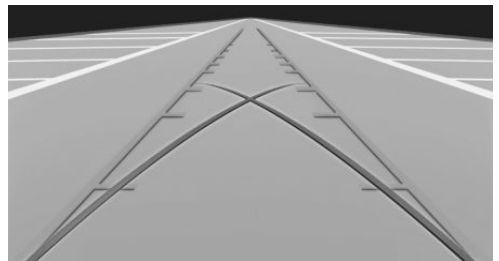

- Turn the steering wheel to the point where the pathway line covers the corresponding turning radius line.

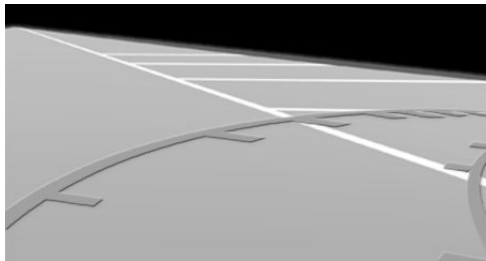

Display settings

Brightness

With the rearview camera switched on:

-  Select the symbol.
- Turn the controller until the desired setting is reached, and press the controller.

Contrast

With the rearview camera switched on:

-  Select the symbol.
- Turn the controller until the desired setting is reached, and press the controller.

System limits

Detection of objects

Very low obstacles as well as high, protruding objects such as ledges may not be detected by the system.

Assistance functions also take into account data of the PDC.

Follow instructions in the PDC chapter.

The objects displayed on the Control Display may be closer than they appear. Do not estimate the distance from the objects on the display.

Top View

Concept

Top View provides assistance in parking and maneuvering. The area around the vehicle is shown on the Control Display.

General information

The image is captured by two cameras integrated in the exterior mirrors, by the rearview camera and a camera on the front of the vehicle.

The range is no more than approx. 6.5 ft/2 m to the side, front and rear.

Obstacles within this range are thus displayed early on the Control Display.

Safety information



WARNING

The system does not relieve from the personal responsibility to correctly assess the traffic situation. There is a risk of an accident. Adjust the driving style to the traffic conditions. Watch traffic and vehicle surroundings closely and actively intervene in the respective situations. ◀

Overview

Button in the vehicle



Park assistance button

Cameras

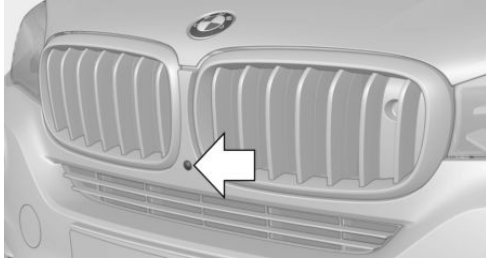

Front camera

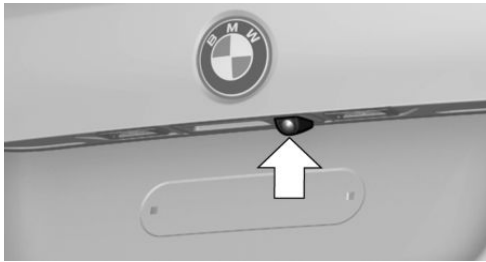

Rearview camera

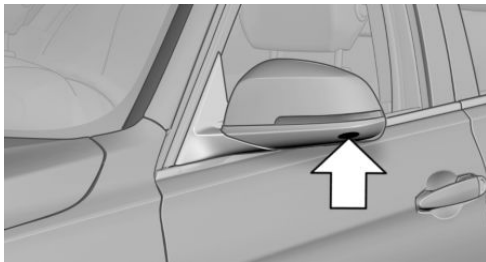

Cameras at the bottom in the mirror housings.

The image quality may be impaired by dirt.
Clean the camera lenses if necessary.

Functional requirements

Top View can be used only to a limited extent in the following situations:

- ▷ With a door open.
- ▷ With the tailgate open.
- ▷ With an exterior mirror folded in.
- ▷ In poor light.

The unavailable camera range is depicted by shading.

Switching on/off

Switching on automatically

The system is switched on automatically if selector lever position R is engaged when the engine is running.

The rearview camera image is displayed. To switch to the Top View:

 "Rear view camera"

Automatic deactivation during forward travel

The system switches off when a certain driving distance or speed is exceeded.

Switch the system back on, if needed.

Switching on/off manually



Press park assistance button.

- ▷ On: the LED lights up.
- ▷ Off: the LED goes out.

Top View is displayed.

The rearview camera image is displayed when the reverse gear is engaged when pressing the park assistance button.

Display

Display on the Control Display

The area surrounding the vehicle can be displayed on the Control Display.

The display appears as soon as Top View is activated.

When the image of the rearview camera is displayed, it is possible to switch to top view:

 "Rear view camera"

Brightness

With Top View switched on:

1. ☀ Select the symbol.
2. Turn the controller until the desired setting is reached, and press the controller.

Contrast

With Top View switched on:

1. ● Select the symbol.
2. Turn the controller until the desired setting is reached, and press the controller.

Displaying the turning radius and pathway lines

- ▶ The static, red turning radius line shows the space needed to the side of the vehicle when the steering wheel is turned all the way.
- ▶ The variable, green pathway line assists you in assessing the amount of space actually needed to the side of the vehicle.

The lane line depends on the engaged gear and the current steering angle. The track line is continuously adjusted for the steering wheel movement.

🔊 "Parking aid lines"

Turning circle and pathway lines are displayed.

System limits

A Check Control message is displayed when a camera is not working.

Side View

Concept

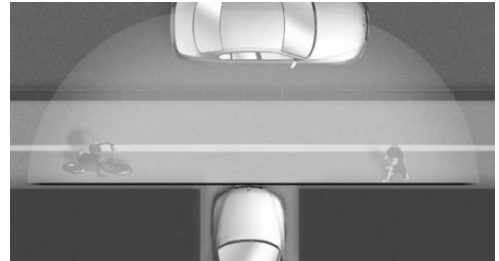

Side View provides an early look at cross traffic at blind driveways and intersections. Road users concealed by obstacles to the left and right of the vehicle can only be detected relatively late from the driver's seat. To improve the viewing, each camera, front and rear on the vehicle, detects the traffic area on the side.

Which camera is active is shown on the top edge of the screen.

Safety information



WARNING

The system does not relieve from the personal responsibility to correctly assess the traffic situation. There is a risk of an accident. Adjust the driving style to the traffic conditions. Watch traffic and vehicle surroundings closely and actively intervene in the respective situations. ◀

Overview

Button in the vehicle



 Side View

Cameras

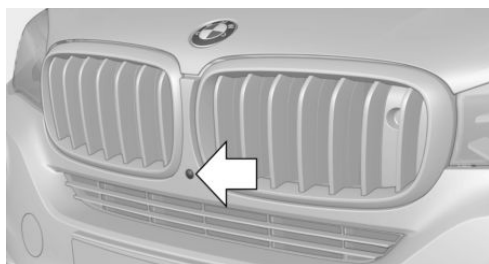

Front camera

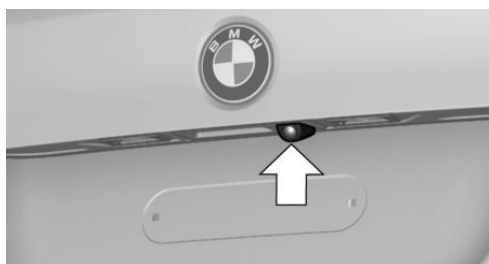

Rear camera

Two cameras are used for the detection.
The image quality may be impaired by dirt.
Clean the camera lenses, refer to page [258](#).

Switching on/off

Switching on/off manually

 Press button.

Depending on the transmission position, the picture of the front or rear camera is displayed.

Switching off automatically

By switching into a different function or when changing gears.

Front Side View: when a certain driving distance or speed is exceeded.

Display

General information

The traffic area in front of or behind the vehicle is displayed on the Control Display.

Brightness

With the Side View switched on:

1.  Select the symbol.
2. Turn the controller until the desired setting is reached, and press the controller.

Contrast

With the Side View switched on:

1.  Select the symbol.
2. Turn the controller until the desired setting is reached, and press the controller.

Warning of crossing traffic

Concept

When an object approaching from the side is detected by the front or rear camera, this is depicted by a symbol in the Side View display.

Requirements

- ▷ Side View switched on.

- ▷ Your vehicle moves no faster than walking speed.
- ▷ To detect approaching objects, sufficient brightness, e.g., daylight is necessary.

Display



The yellow symbol is displayed if an approaching vehicle is detected by the camera.



A gray symbol is displayed if crossing traffic cannot be detected.

System limits

In the following situations, the warning about crossing traffic may be limited:

- ▷ In poor lighting or visibility conditions.
- ▷ If the camera is soiled or covered.

System limits

The objects displayed on the Control Display under certain circumstances are closer than they appear. Therefore, do not estimate the distance from the objects on the display.

The viewing angle is approx. 180°.

Parking assistant

Concept

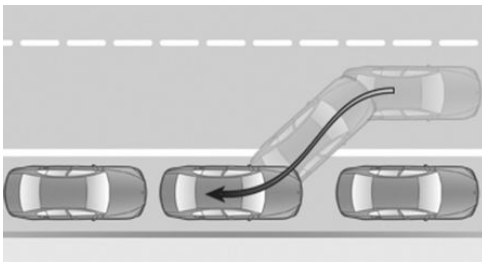

This system assists the driver in parking parallel to the road.

General information

Parking assistant handling is divided into three steps:

- ▷ Switching on and activating.
- ▷ Parking space search.
- ▷ Parking.

Ultrasound sensors measure parking spaces on both sides of the vehicle.

The parking assistant calculates the best possible parking line and during the parking procedure takes control of steering, the acceleration and braking, and if needed, changes the gears. Press and hold the park assistance button for the duration of the parking procedure.

System status and instructions on required actions are displayed on the Control Display.

The parking assistant uses the sensors of PDC Park Distance Control.

Safety information



WARNING

The system does not release from the personal responsibility to correctly assess the traffic situation. Based on the limits of the system, it cannot independently react to all traffic situations. There is a risk of an accident. Adjust the driving style to the traffic conditions. Watch traffic closely and actively intervene in the respective situations. ◀



NOTE

The parking assistant can steer the vehicle over or onto curbs. There is a risk of property damage. Watch traffic closely and actively intervene in the respective situations. ◀

Also observe the safety information for PDC Park Distance Control.

Overview

Button in the vehicle



 Park assistance button

Ultrasound sensors

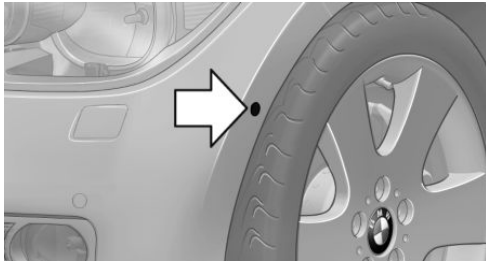

The ultrasound sensors for measuring parking spaces are located on the side of the vehicle.

Functional requirements

Ultrasound sensors

Ensure full functionality:

- ▷ Do not cover sensors, for instance with stickers.
- ▷ Keep the sensors clean and unobstructed.

For measuring parking spaces

- ▷ Maximum speed while driving forward approx. 22 mph/35 km/h.
- ▷ Maximum distance to row of parked vehicles: 5 ft/1.5 m.

Suitable parking space

- ▷ Gap between two objects with a minimum length of approx. 5 ft/1.5 m.
- ▷ Min. length of gap between two objects: your vehicle's length plus approx. 4 ft/1.2 m.
- ▷ Minimum depth: approx. 5 ft/1.5 m.

For parking

- ▷ Doors and tailgate are closed.
- ▷ The parking brake is released.
- ▷ Driver's safety belt is fastened.

Switching on and activating

Switching on with the button

-  Press park assistance button.
The LED lights up.

The current status of the parking space search is indicated on the Control Display.

 Parking assistant is activated automatically.

Switching on with reverse gear



Shift into reverse.

The current status of the parking space search is indicated on the Control Display.

To activate:  "Parking Assistant"

Display on the Control Display

System activated/deactivated

Symbol	Meaning
	Gray: the system is not available. White: the system is available but not activated.
	The system is activated.

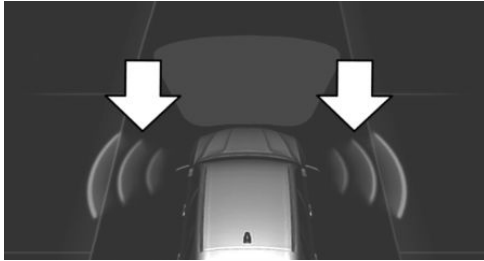

Parking space search and system status



- ▷ Colored symbols, see arrows, on the side of the vehicle image; the parking assistant is activated and the parking space search is active.
- ▷ Control Display shows suitable parking spaces at the edge of the road next to the vehicle symbol. When the parking assistant is active, suitable parking spaces are highlighted.
- ▷  The parking procedure is active. Steering control has been taken over by system.
- ▷ Parking space search is always active whenever the vehicle is moving forward slow and straight, even if the system is deactivated. When the system is deactivated, the displays on the Control Display are shown in gray.

Parking using the parking assistant

Parking



1.  Press park assistance button or shift into reverse gear to switch the parking assistant on, refer to page 168. Activate the parking assistant, if needed.
 Parking assistant is activated.
2. Pass the row of parked vehicles at a speed of up to approx. 22 mph/35 km/h and at a distance of maximum 5 ft/1.5 m.

The status of the parking space search and possible parking spaces are displayed on the Control Display, refer to page 168.

3. Follow the instructions on the Control Display.
 Press and hold the park assistance button for the duration of the parking procedure. At the end of the parking procedure, the P selector lever position is set.
 The end of the parking procedure is indicated on the Control Display.
4. Adjust the parking position yourself, if needed.

Interrupting manually

The parking assistant can be interrupted at any time:

- ▷  Press park assistance button.
- ▷  "Parking Assistant" Select the symbol on the Control Display.

Interrupting automatically

The system is interrupted automatically in the following situations:

- ▷ If the driver grasps the steering wheel or takes over steering.
- ▷ Possibly on snow-covered or slippery road surfaces.
- ▷ When there are obstacles that are hard to overcome, such as curbs.
- ▷ When there are obstacles that suddenly appear.
- ▷ If the Park Distance Control PDC displays clearances that are too small.
- ▷ If a maximum number of parking attempts or the time taken for parking is exceeded.
- ▷ When switching to another function on the Control Display.
- ▷ When the park assistance button is released.
- ▷ If the tailgate is open.

- ▷ If doors are open.
- ▷ When setting the parking brake.
- ▷ During acceleration.
- ▷ When braking.
- ▷ When unfastening the driver's safety belt.

A Check Control message is displayed.

Resuming

An interrupted parking procedure can be continued, if needed.

Reactivate the parking assistant, refer to page 168, and follow the instructions on the Control Display.

Switching off

The system can be switched off as follows:

- ▷  Press park assistance button.

System limits

Safety information



WARNING

The system can react incorrectly or not at all due to the system limits. There is a risk of accidents or risk of property damage. Observe the information regarding the system limits and actively intervene, if needed. ◀

No parking assistance

The parking assistant does not offer assistance in the following situations:

- ▷ In tight curves.

Functional limitations

The system may not be fully functional in the following situations:

- ▷ On bumpy road surfaces such as gravel roads.
- ▷ On slippery ground.
- ▷ On steep uphill or downhill grades.

- ▷ With accumulations of leaves/snow in the parking space.
- ▷ With ditches or edges, for instance an edge of a port.

Limits of ultrasonic measurement

Ultrasonic measurements might not function in the following situations:

- ▷ For small children and animals.
- ▷ For persons with certain clothing, e.g., coats.
- ▷ With external interference of the ultrasound, e.g., from passing vehicles or loud machines.
- ▷ When sensors are dirty, iced over, damaged or out of position.
- ▷ Under certain weather conditions such as high relative humidity, rain, snowfall, extreme heat or strong wind.
- ▷ With tow bars and trailer couplings of other vehicles.
- ▷ With thin or wedge-shaped objects.
- ▷ With moving objects.
- ▷ With elevated, protruding objects such as ledges or cargo.
- ▷ With objects with corners and sharp edges.
- ▷ With objects with a fine surface structure such as fences.
- ▷ For objects with porous surfaces.
- ▷ If cargo protrudes.
- ▷ Low objects already displayed, e.g., curbs, can move into the blind area of the sensors before or after a continuous tone sounds.

Parking spaces that are not suitable may be detected or suitable parking spaces may not be detected at all.

Malfunction

A Check Control message is displayed.

The parking assistant failed. Have the system checked by a dealer's service center or another qualified service center or repair shop.

Climate control

Vehicle features and options

This chapter describes all standard, country-specific and optional features offered with the series. It also describes features that are not necessarily available in your vehicle, e. g., due

to the selected options or country versions. This also applies to safety-related functions and systems. When using these functions and systems, the applicable laws and regulations must be observed.

Automatic climate control

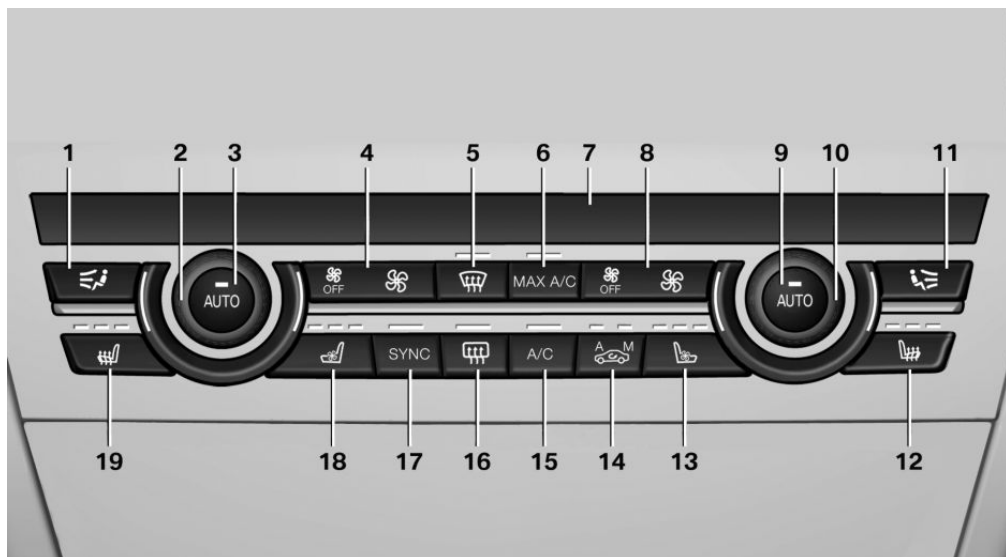

- | | |
|---|---|
| 1 Air distribution, left | 11 Air distribution, right |
| 2 Temperature, left | 12 Seat heating, right 55 |
| 3 AUTO program, left | 13 Active seat ventilation, right 56 |
| 4 Air flow, AUTO intensity, left, residual heat | 14 Automatic recirculated-air control/recirculated-air mode |
| 5 Remove ice and condensation | 15 Air conditioning |
| 6 Maximum cooling | 16 Rear window defroster |
| 7 Display | 17 SYNC program |
| 8 Air flow, AUTO intensity, right | 18 Active seat ventilation, left 56 |
| 9 AUTO program, right | 19 Seat heating, left 55 |
| 10 Temperature, right | |

Climate control functions in detail

Switching the system on/off

Switching on

Press any button except for the following:

- ▷ Rear window defroster.
- ▷ Left side of air flow button.
- ▷ Seat heating.
- ▷ Seat ventilation.
- ▷ If necessary, SYNC program.

Switching off

- ▷ Complete system:



Press and hold the left button on the driver's side until the control panel switches off.

- ▷ On the front passenger side:



Press and hold the left button on the front passenger side.

Temperature

Concept

The automatic climate control achieves the set temperature as quickly as possible, if needed, by using the maximum cooling or heating capacity, and then keeps it constant.

Settings



Turn the ring to set the desired temperature.

Do not rapidly switch between different temperature settings. Otherwise, the automatic climate control will not have sufficient time to adjust the set temperature.

Air conditioning

Concept

The air in the vehicle's interior will be cooled and dehumidified and, depending on the temperature setting, warmed again.

The vehicle's interior can only be cooled with the engine running.

Switching on/off



Press button.

Air conditioning is switched on or off.

Depending on the weather, the windshield and side windows may fog up briefly when the engine is started.

The cooling function is switched on automatically with the AUTO program.

When using the automatic climate control, condensation water, refer to page 198, develops and drains underneath the vehicle. This is normal.

Maximum cooling

Concept

The system is set to the lowest temperature, optimum air flow and recirculated-air mode.

General information

The function is available above an external temperature of approx. 32 °F/0 °C and with the engine running is indicated.

Switching on/off



Press button.

Air flows out of the vents to the upper body region. The vents need to be open for this.

The air flow can be adjusted with the air flow active.

AUTO program

Concept

Depending on the selected temperature, the intensity of the AUTO program, and outside influences, the air is directed to the windshield, side windows, upper body, and into the floor area.

Switching on/off

 Press button. Air flow, air distribution and temperature are controlled automatically.

The cooling function, refer to page 173, is switched on automatically with the AUTO program.

At the same time, a condensation sensor controls the program so as to prevent window condensation as much as possible.

Intensity

With the AUTO program activated, the automatic intensity control can be changed.

 Press the left or right side of the button: decrease or increase intensity.

The selected intensity is shown on the display of the automatic climate control.

Automatic recirculated-air control/ recirculated-air mode

Concept

The automatic recirculated-air control AUC detects odors or pollutants in the outside air. The outside air supply is shut off and the interior air is recirculated.

General information

If the system is activated, a sensor detects pollutants in the outside air and controls the shut-off automatically.

If the system is deactivated, outside air continuously flows into the vehicle's interior.

With constant recirculated-air mode, the air quality in the vehicle's interior deteriorates and the fogging of the windows increases.

Switching on/off

 Press button repeatedly to select an operating mode:

- ▷ LEDs off: outside air flows in continuously.
- ▷ Left LED on, automatic recirculated-air control: a sensor detects pollutants in the outside air and shuts off automatically.
- ▷ Right LED on, recirculated-air mode: the supply of outside air into the vehicle is permanently blocked.

If the windows are fogged over, switch off the recirculated-air mode and press the AUTO button on the driver's side to utilize the condensation sensor. Make sure that air can flow to the windshield.

Controlling the air flow manually

Concept

The air flow for climate control can be adjusted manually.

General information

To manually adjust air flow turn off AUTO program first.

Operation

 Press the left or right side of the button: decrease or increase air flow.

The selected air flow is shown on the display of the automatic climate control.

The air flow of the automatic climate control may be reduced automatically to save battery power.

Controlling the air distribution manually

Concept

The air distribution for climate control can be adjusted manually.

Operation



Press button repeatedly to select a program:

- ▷ Upper body region.
- ▷ Upper body region and floor area.
- ▷ Floor area.
- ▷ Windows and floor area.
- ▷ Windows, upper body region, and floor area.
- ▷ Windows: driver's side only.
- ▷ Windows and upper body region.

If the windows are fogged over, press the AUTO button on the driver's side to utilize the condensation sensor.

SYNC program

Concept

The system enables the transfer of current settings on the driver's side for temperature, air flow, air distribution, and the AUTO program to the front passenger side and to the left and right rear.

Switching on/off



The program is also switched off if the settings on the front passenger side or in the rear are changed.

Residual heat

The heat stored in the engine is used to heat the interior. This is possible up to 15 minutes after switching off the engine.

Functional requirement

- ▷ Warm engine.
- ▷ The battery is sufficiently charged.
- ▷ External temperature below 77 °F/25 °C.

The availability of the function is shown on the display of the automatic climate control.

Switching on

1. Switching off the ignition.



2. Press the right side of the button on the driver's side.

}} The symbol appears on the automatic climate Control Display.

The interior temperature, air flow and air distribution can be adjusted with the ignition switched on.

Switching off

At the lowest fan speed, press the left side of the button on the driver's side.

}} The symbol on the display of the automatic climate control flashes.

Defrosting windows and removing condensation

Concept

Ice and condensation are quickly removed from the windshield and the front side windows.

Switching on/off



Press button.

The LED is illuminated with the system switched on.

For this purpose, point the side vents towards the side windows as needed.

The air flow can be adjusted with the air flow active.

If the windows are fogged over, you can also switch on the cooling function or press the

AUTO button to utilize the condensation sensor.

Rear window defroster



Press button. The LED lights up.

The rear window defroster switches off automatically after a certain period of time.

Microfilter/activated-charcoal filter

The microfilter removes dust and pollen from the incoming air.

The activated-charcoal filter removes gaseous pollutants from the outside air that enters the vehicle.

Have this combined filter changed during vehicle maintenance, refer to page 241.

Ventilation

Front ventilation

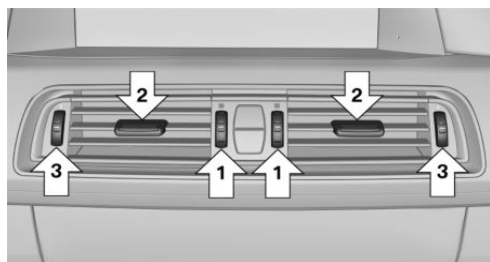

- ▷ Thumbwheels to vary the ventilation temperature in the upper body region, arrow 1.
Toward blue: colder.
Toward red: warmer.
This does not change the set interior temperature for the driver and front passenger.
- ▷ Lever for changing the air flow direction, arrow 2.
- ▷ Thumbwheels for opening and closing the vents continuously, arrows 3.

Settings

- ▷ Ventilation for cooling:
Direct vent in your direction when vehicle's interior is too hot.
- ▷ Draft-free ventilation:
Adjust the vent to let the air flow past you.

Ventilation in rear, center

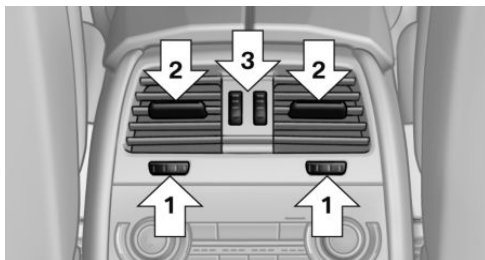

- ▷ Thumbwheels to vary the temperature, arrow 1.
Toward blue: colder.
Toward red: warmer.
- ▷ Lever for changing the air flow direction, arrow 2.
- ▷ Thumbwheels for continuous opening and closing of the vents, arrow 3.

Rear automatic climate control

Overview



- 1 Temperature
- 2 AUTO program
- 3 Air distribution settings
- 4 Air flow, AUTO intensity
- 5 Display
- 6 Maximum cooling
- 7 Seat heating [56](#)

Switching the rear automatic climate control on/off

1. "Settings"
2. "Climate"
3. "Rear climate"

The rear automatic climate control is not operational if the automatic climate control is switched off or if the function for defrosting or defogging the windows is active.

Switching the system on/off

Switching on

Press any button except for the following:

- ▷ Left side of air flow button.
- ▷ Seat heating.

Switching off



Press and hold the left button.

Temperature



Turn the ring to set the desired temperature.

The automatic climate control achieves this temperature as quickly as possible, if needed, by using the maximum cooling or heating capacity, and then keeps it constant.

Do not rapidly switch between different temperature settings. The automatic climate control will not have sufficient time to adjust the set temperature.

Maximum cooling

Concept

The system is set to the lowest temperature, maximum air flow and recirculated-air mode.

General information

Air is cooled as quickly as possible:

- ▷ Above an external temperature of approx. 32 °F/0 °C.
- ▷ When the engine is running.

Switching on/off



Press button.

Air flows out of the vents to the upper body region. The vents need to be open for this.

AUTO program

Concept

Depending on the selected temperature, the AUTO intensity, and outside influences, the air is directed to the upper body and into the floor area.

Switching on/off



Press button.

Air flow, air distribution, and temperature are controlled automatically:

The cooling function is switched on automatically with the AUTO program.

Intensity

With the AUTO program activated, the automatic intensity control can be changed:



Press the left or right side of the button: decrease or increase intensity.

The selected intensity is shown on the display of the automatic climate control.

Controlling the air flow manually

Concept

The air flow for climate control can be adjusted manually.

General information

To manually adjust air flow turn off AUTO program first.

Operation



Press the left or right side of the button: decrease or increase air flow.

The selected air flow is shown on the display of the automatic climate control.

Controlling the air distribution manually

Concept

The air distribution for climate control can be adjusted manually.

Operation



Press button repeatedly to select a program:

- ▷ Upper body region.
- ▷ Upper body region and floor area.
- ▷ Floor area.

Parked-vehicle ventilation

Concept

The parked-vehicle ventilation ventilates the vehicle interior and lowers its temperature, if needed.

General information

The system can be switched on and off directly or by using two preset departure times.

The activation time is automatically determined based on the temperature. The system promptly switches on before the selected departure time.

Operation can be performed via iDrive.

Functional requirements

Parked-car ventilation

- ▷ When the departure time is preselected: depends on internal, external and set temperature.
 - ▷ Direct operation: any external temperature.
 - ▷ Battery is sufficiently charged.
- If parked-car ventilation is switched on, the vehicle battery will be discharged. Thus, limit the maximum activation time to save the vehicle battery. The system will be available again after engine starting and/or a short trip.
- ▷ Make sure that the vehicle's date and time are set correctly.

Open the vents to allow air to flow out.

Switching on/off directly

On the Control Display:

1. "Settings"

2. "Climate"
3. "Activate now"

 The symbol on the automatic climate control flashes if the system is switched on.

The system continues to run for some time after being switched off.

Setting the departure time

On the Control Display:

1. "Settings"
2. "Climate"
3. Select the departure time.
Turn the controller until the desired departure time field has been selected and press controller.
4. Set the time.
Turn the controller until the desired time is set and press the controller.

Activating the departure time

On the Control Display:

1. "Settings"
2. If necessary, "Climate"
3. Activating the desired departure time:
"for departure at"

 The symbol on the automatic climate control lights up when the departure time is activated.

 The symbol on the automatic climate control flashes when the system has been switched on.

The system will only be switched on within the next 24 hours. After that, it needs to be reactivated.

Interior equipment

Vehicle features and options

This chapter describes all standard, country-specific and optional features offered with the series. It also describes features that are not necessarily available in your vehicle, e. g., due to the selected options or country versions. This also applies to safety-related functions and systems. When using these functions and systems, the applicable laws and regulations must be observed.

Universal Integrated Remote Control

Concept

The integrated Universal Remote Control in the interior mirror can operate up to 3 functions of remote-controlled systems, such as garage door drives or lighting systems. The Universal Integrated Remote Control replaces up to 3 different hand-held transmitters. To operate the remote control, the buttons on the interior mirror must be programmed with the desired functions. The hand-held transmitter for the particular system is required in order to program the remote control.

Before selling the vehicle, delete the stored functions for the sake of security.

Safety information



WARNING

Body parts can be jammed when operating remote-controlled systems, e.g., the garage door, using the integrated universal remote control. There is a risk of injury or risk of property damage. Make sure that the area of movement of the respective system is clear during programming and operation. Also follow

the safety instructions of the hand-held transmitter. ◀

Compatibility



If this symbol is printed on the packaging or in the owner's manual of the system to be controlled, the system is generally compatible with the Universal Integrated Remote Control.

If you have any questions, please contact:

- ▷ A dealer's service center or another qualified service center or repair shop.
- ▷ www.homelink.com on the Internet.

HomeLink is a registered trademark of Gentex Corporation.

Control elements on the interior mirror

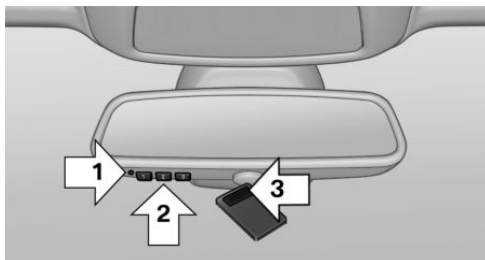

- ▷ LED, arrow 1.
- ▷ Buttons, arrow 2.
- ▷ The hand-held transmitter, arrow 3, is required for programming.

Programming

General information

1. Switch on the ignition.
2. Initial setup:

Press and hold the two outer buttons on the interior mirror simultaneously for ap-

proximately 20 seconds until the LED on the interior mirror flashes. This erases all programming of the buttons on the interior mirror.

3. Hold the hand-held transmitter for the system to be controlled approx. 1 to 3 inches/2.5 to 8 cm away from the buttons of the interior mirror. The required distance depends on the hand-held transmitter.
4. Simultaneously press and hold the button of the desired function on the hand-held transmitter and the button to be programmed on the interior mirror. The LED on the interior mirror will begin flashing slowly.
5. Release both buttons as soon as the LED flashes more rapidly. The LED flashing faster indicates that the button on the interior mirror has been programmed.

If the LED does not flash faster after at least 60 seconds, change the distance between the interior mirror and the hand-held transmitter and repeat the step. Several more attempts at different distances may be necessary. Wait at least 15 seconds between attempts.

Canada: if programming with the hand-held transmitter was interrupted, hold down the interior mirror button and repeatedly press and release the hand-held transmitter button for 2 seconds.

6. To program other functions on other buttons, repeat steps 3 to 5.

The systems can be controlled using the interior mirror buttons.

Special feature of the rolling code wireless system

If you are unable to operate the system after repeated programming, please check if the system to be controlled features a rolling code radio system.

Read the system's owner's manual, or press the programmed button on the interior mirror longer. If the LED on the interior mirror starts

flashing rapidly and then stays lit constantly for 2 seconds, the system features a rolling code radio system. Flashing and continuous illumination of the LED will repeat for approximately 20 seconds.

For systems with a rolling code radio system, the Universal Integrated Remote Control and the system also have to be synchronized.

Please read the owner's manual to find out how to synchronize the system.

Synchronizing is easier with the aid of a second person.

Synchronizing the universal remote control with the system:

1. Park the vehicle within range of the remote-controlled system.
2. Program the desired button on the interior mirror as described.
3. Locate and press the synchronizing button on the system being programmed. You have approx. 30 seconds for the next step.
4. Hold down the programmed button on the interior mirror for approximately 3 seconds and then release it. If necessary, repeat this step up to three times in order to finish synchronization. Once synchronization is complete, the programmed function will be carried out.

Reprogramming individual buttons

1. Switch on the ignition.
2. Press and hold the interior mirror button to be programmed.
3. As soon as the interior mirror LED starts flashing slowly, hold the hand-held transmitter for the system to be controlled approx. 1 to 3 inches/2.5 to 8 cm away from the buttons of the interior mirror. The required distance depends on the hand-held transmitter.

4. Likewise, press and hold the button of the desired function on the hand-held transmitter.
5. Release both buttons as soon as the interior mirror LED flashes more rapidly. The LED flashing faster indicates that the button on the interior mirror has been programmed. The system can then be controlled by the button on the interior mirror. If the LED does not flash faster after at most 60 seconds, change the distance and repeat the programming starting with step 4. Several more attempts at different distances may be necessary. Wait at least 15 seconds between attempts.

Canada: if programming with the hand-held transmitter was interrupted, hold down the interior mirror button and repeatedly press and release the hand-held transmitter button for 2 seconds.

Operation

WARNING

Body parts can be jammed when operating remote-controlled systems, e.g., the garage door, using the integrated universal remote control. There is a risk of injury or risk of property damage. Make sure that the area of movement of the respective system is clear during programming and operation. Also follow the safety instructions of the hand-held transmitter. ◀

The system, such as the garage door, can be operated using the button on the interior mirror while the engine is running or when the ignition is started. To do this, hold down the button within receiving range of the system until the function is activated. The interior mirror LED stays lit while the wireless signal is being transmitted.

Deleting stored functions

All stored functions will be deleted. The functions cannot be deleted individually. Press and

hold the two outer buttons on the interior mirror simultaneously for approximately 20 seconds until the LED on the interior mirror flashes rapidly.

Sun visor

Glare shield

Fold the sun visor down or up.

Glare shield from the side

Folding out

1. Fold the sun visor down.
2. Unhook it from the holder and swing it to the side.
3. Move it back to the desired position.

Folding up

Proceed in the reverse order to close the sun visor.

Vanity mirror

A vanity mirror is located in the sun visor behind a cover. When the cover is opened, the mirror lighting switches on.

Ashtray

Opening

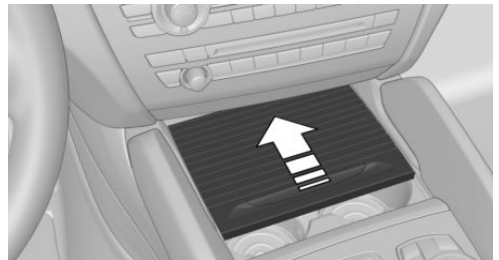

Slide the cover forward.

Emptying

Take out the insert.

Lighter

Safety information



WARNING

Contact with hot heating elements or the hot socket of the cigarette lighter can cause burns. Flammable materials can ignite if the cigarette lighter falls down or is held against the respective objects. There is a risk of fire and injuries. Hold the cigarette lighter by its handle. Make sure that children do not use the lighter and burn themselves. ◀



NOTE

If metal objects fall into the socket, they can cause a short circuit. There is a risk of property damage. Replace the cigarette lighter or socket cover again after using the socket. ◀

Front

Overview



The lighter is located next to the ashtray.

Controls



Push in the lighter.

The lighter can be removed as soon as it pops back out.

Rear

Overview



The cigarette lighter is located in the rear center console.

Controls



Push in the lighter.

The lighter can be removed as soon as it pops back out.

Sockets

General information

The lighter socket can be used as a socket for electrical equipment while the engine is running or when the ignition is switched on.

The total load of all sockets must not exceed 140 watts at 12 volts.

Do not damage the socket by using non-compatible connectors.

Safety information



NOTE

Battery chargers for the vehicle battery can work with high voltages and currents, which means that the 12 volt on-board network can be overloaded or damaged. There is a risk of property damage. Only connect battery chargers for the vehicle battery to the

starting aid terminals in the engine compartment. ◀



NOTE

If metal objects fall into the socket, they can cause a short circuit. There is a risk of property damage. Replace the cigarette lighter or socket cover again after using the socket. ◀

Front center console



Slide the cover forward.

Remove the cover or cigarette lighter.

Center armrest



Remove the cover.

Rear center console



Remove the cover or cigarette lighter.

In the cargo area



Fold open the cover.

USB interface/AUX-IN port

Concept

Mobile devices with USB port can be connected to the USB interface.

A mobile audio device, e.g., a MP3 player, can be connected using the AUX-IN port.

General information

The following devices can be connected:

- ▷ Mobile phones supported by the USB interface.
- ▷ Audio devices with USB port, e.g., MP3 player.
- ▷ USB storage devices.

Common file systems are supported. FAT32 and exFAT are the recommended formats.

Information about compatible USB media can be found at www.bmwusa.com/bluetooth.

The following applications are possible:

- ▷ Exporting and importing driver profiles, refer to page 44.
- ▷ Playing music files via USB audio.
- ▷ Adding music files to the music collection and saving the music collection.
- ▷ Playing videos via USB video.
- ▷ Loading of software updates.

Overview

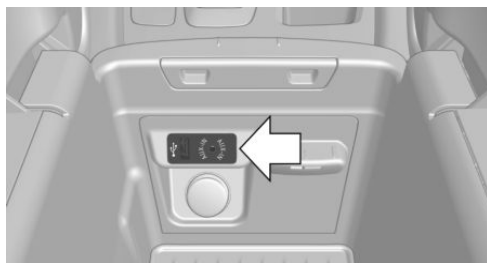

The USB interface and the AUX-IN port are located in the center armrest.

Connecting an external device

Observe the following when connecting:

- ▷ Do not use force when plugging the connector into the USB interface.
- ▷ Use a flexible adapter cable.
- ▷ Protect the USB storage device against mechanical damage.
- ▷ Due to the large number of USB media available on the market, it cannot be guaranteed that every device is operable on the vehicle.
- ▷ Do not expose USB media to extreme environmental conditions, such as very high

temperatures; refer to the owner's manual of the device.

- ▷ Due to the many different compression techniques, proper playback of the media stored on the USB storage device cannot be guaranteed in all cases.
- ▷ A connected USB storage device will be supplied with charging current via the USB interface if the device supports this. At higher temperatures, the USB storage device may cause a reduction in the charging current.
- ▷ To ensure proper transmission of the stored data, do not charge a USB storage device via the onboard socket, when it is connected to the USB interface.
- ▷ Depending on how the USB storage device should be used, settings may be required on the USB storage device, refer to the owner's manual of the device.

Non-compatible USB media:

- ▷ USB hard drives.
- ▷ USB hubs.
- ▷ USB memory card readers with multiple inserts.
- ▷ HFS-formatted USB media.
- ▷ MTP devices.
- ▷ Devices such as fans or lights.

Cargo area

Cargo cover

Safety information



WARNING

Loose objects or devices with a cable connection to the vehicle, e.g., mobile phones, can be thrown into the vehicle's interior while driving, e.g., in the event of an accident or during braking and evasive maneuvers. There is a risk of injury. Secure loose objects or devices

with a cable connection to the vehicle in the vehicle's interior. ◀

General information

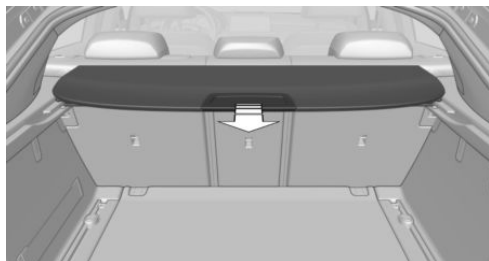

Unfold cargo cover out towards the rear.

Removing

The cover can be removed to load bulky luggage.

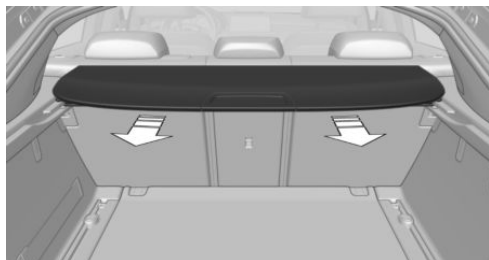

1. Grasp folded-up cargo cover under the top fold on both sides.
2. Pull the cover rearward out of the two side brackets.

Stowing

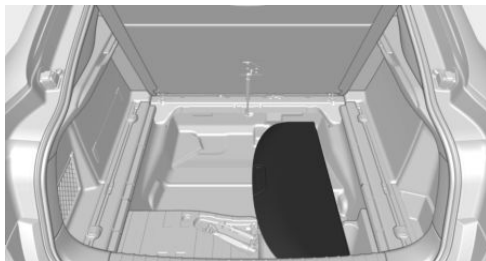

Depending on the equipment of your vehicle, you can stow the cover under the cargo floor panel.

Installing

When installing, follow the reverse procedure.

1. Put the cargo cover in place left and right.
2. Lift the cover slightly to the rear and push toward the front until it engages on both side brackets.

Enlarging the cargo area

Concept

The cargo area can be enlarged by folding down the rear seat backrest.

General information

The rear seat backrest is divided at a ratio of 40–20–40. The side rear seat backrests and the center section can be folded down separately.

The rear seat backrests can be folded down from the rear.

Safety information



WARNING

Danger of jamming with folding down the backrests. There is a risk of injury or risk of property damage. Make sure that the area of movement of the rear backrest and the of the head restraint is clear prior to folding down. ◀

**WARNING**

With an unlocked backrest, an unsecured load can be thrown into the vehicle's interior, e.g., in case of an accident, braking or evasive maneuver. There is a risk of injury. Make sure that the backrest engages into the locking after folding it back. ◀

**WARNING**

With a rear backrest that is not locked, the protective function of the middle safety belt is not guaranteed. There is a risk of injuries or danger to life. If you are using the middle safety belt, lock the wider rear backrest. ◀

**WARNING**

The stability of the child restraint system is limited or compromised with incorrect seat adjustment or improper installation of the child seat. There is a risk of injuries or danger to life. Make sure that the child restraint system fits securely against the backrest. If possible, adjust the backrest tilt for all affected backrests and correctly adjust the seats. Make sure that seats and backrests are securely engaged. If possible, adjust the height of the head restraints or remove them. ◀

**NOTE**

Vehicle parts can be damaged when folding down the rear backrest. There is a risk of property damage. Make sure that the area of movement of the rear backrest including head restraint is clear when folding down. ◀

Folding down the rear seat backrest from the rear



Reach into the recess and pull the rear seat backrest forward.

Fold down the middle section

1. Push the center head restraint down if necessary.
2. Reach into the recess and pull the center section forward.

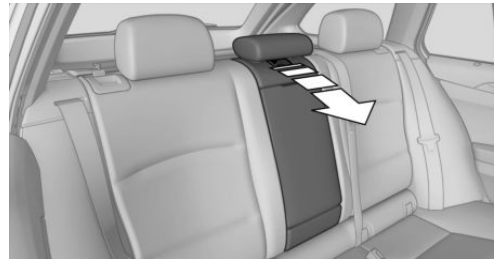

Ski and snowboard bag

The ski and snowboard bag is contained in a protective jacket in the cargo area.

Follow the installation and owner's manual included in the protective jacket.

Storage compartments

Vehicle features and options

This chapter describes all standard, country-specific and optional features offered with the series. It also describes features that are not necessarily available in your vehicle, e. g., due to the selected options or country versions. This also applies to safety-related functions and systems. When using these functions and systems, the applicable laws and regulations must be observed.

Safety information



WARNING

Loose objects or devices with a cable connection to the vehicle, e.g., mobile phones, can be thrown into the vehicle's interior while driving, e.g., in the event of an accident or during braking and evasive maneuvers. There is a risk of injury. Secure loose objects or devices with a cable connection to the vehicle in the vehicle's interior. ◀



NOTE

Anti-slip pads such as anti-slip mats can damage the dashboard. There is a risk of property damage. Do not use anti-slip pads. ◀

Storage compartments

The following storage compartments are available in the vehicle interior:

- ▷ Glove compartment on the front passenger side, refer to page 188.
- ▷ Glove compartment on the driver's side, refer to page 189.
- ▷ Compartments in the doors, refer to page 189.

- ▷ Storage compartment on the center console, refer to page 189.
- ▷ Center armrest, refer to page 189.
- ▷ Glasses compartment, refer to page 190.

Glove compartment

Front passenger side

Safety information



WARNING

Folded open, the glove compartment protrudes in the vehicle's interior. Objects in the glove compartment can be thrown into the vehicle's interior while driving, e.g., in the event of an accident or during braking and evasive maneuvers. There is a risk of injury. Always close the glove compartment immediately after using it. ◀

Opening

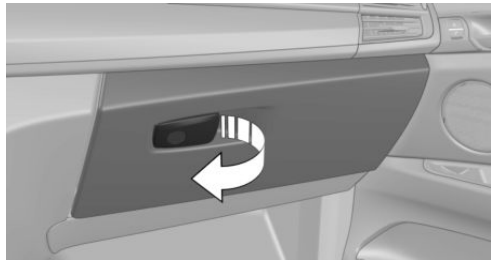

Pull the handle.

The light in the glove compartment switches on.

The retaining strap in the glove compartment is used to store small objects.

Closing

Fold cover closed.

Locking

The glove compartment can be locked with an integrated key. This prevents access to the glove compartment.

After the glove compartment is locked, the remote control can be handed over, such as at a hotel, without the integrated key.

Driver's side

Safety information

WARNING

Folded open, the glove compartment protrudes in the vehicle's interior. Objects in the glove compartment can be thrown into the vehicle's interior while driving, e.g., in the event of an accident or during braking and evasive maneuvers. There is a risk of injury. Always close the glove compartment immediately after using it. ◀

Opening

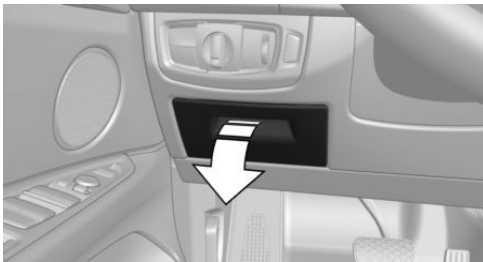

Pull the handle.

Closing

Fold cover closed.

Compartments in the doors

WARNING

Breakable objects, e.g., glass bottles, can break in the event of an accident. Broken glass can be scattered in the vehicle's interior. There

is a risk of injury. Do not stow any breakable objects in the vehicle's interior. ◀

Storage compartment on the center console

Opening



Slide the cover forward.

Closing

Slide the cover rearward.

Small storage compartment

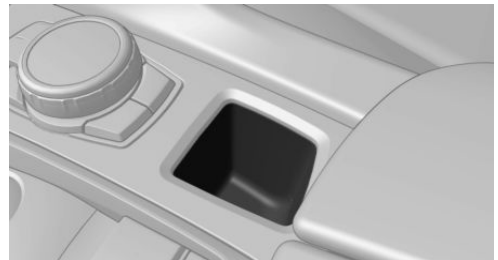

Storage possibility for small objects, for example, coins.

Center armrest

Front

Overview

Located in the center armrest between the front seats is a storage compartment and de-

pending on how the vehicle is equipped also an elastic band on the left side and a cover for the snap-in adapter.

Opening

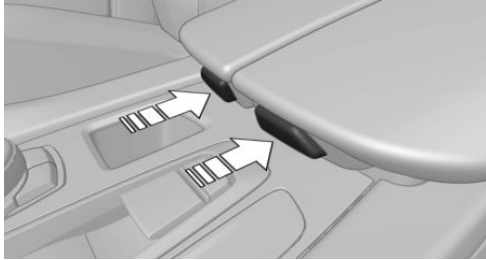

Push the cover down slightly and press the button, see arrow. The respective cover folds up.

Closing

Fold the respective cover down until it latches.

Connection for an external audio device



An external audio device, for instance an MP3 player, can be connected via the AUX-IN port or the USB audio interface in the center armrest.

Rear

Overview

A storage compartment is located in the center armrest between the seats.

Opening

1. Pull the loop and fold down the center armrest.

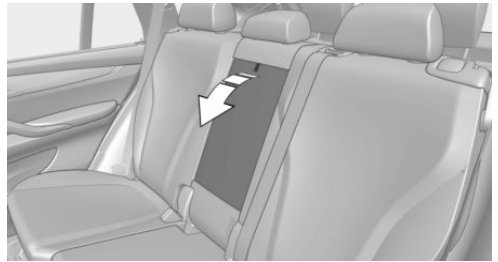

2. Pull the handle.

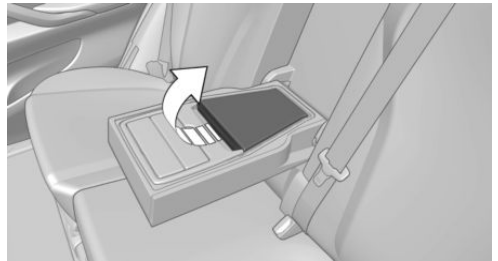

Closing

Press cover down until it latches.

Glasses compartment

Overview

The compartment for eye glasses is located between the interior mirror and interior lights.

Opening

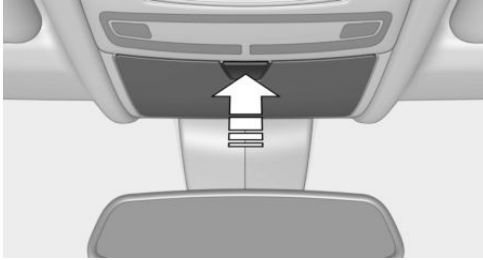

Press button.

Closing

Press the cover up until it latches.

Cup holders

Safety information



WARNING

Unsuitable containers in the cup holder and hot beverages can damage the cup holder and increase the risk of injury in the event of an accident. There is a risk of injury or risk of property damage. Use light-weight, unbreakable, and sealable containers. Do not transport hot beverages. Do not force objects into the cup holder. ◀

Front

Overview

In the center console.

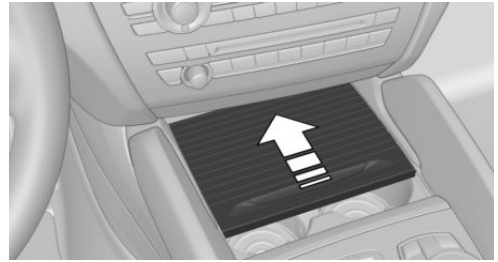

Slide the cover forward.



Two cup holders are located in the center console.

Rear

Safety information



NOTE

With an open cup holder, the center armrest cannot be folded back up. There is a risk of property damage. Press back the covers before the center armrest is folded up. ◀

Overview

In the center armrest.

Opening

1. Pull the loop and fold down the center armrest.

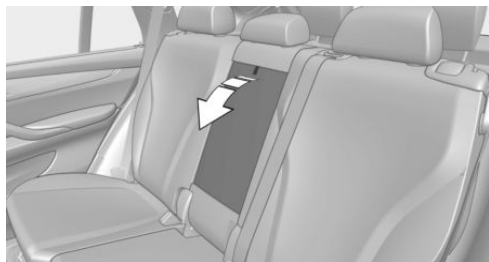

2. Press button.

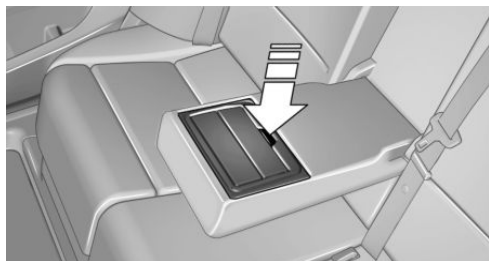

Closing

Press both covers inward back against each other.

Clothes hooks

Safety information



WARNING

Clothing articles on the clothes hooks can obstruct the view while driving. There is a risk of an accident. When suspending clothing articles from the hooks, ensure that they will not obstruct the driver's view. ◀



WARNING

Improper use of the clothes hooks can lead to a risk of objects flying about during braking and evasive maneuvers. There is a risk of injury and risk of property damage. Only

hang lightweight objects, e.g., clothing articles, from the clothes hooks. ◀

General information

Two folding clothes hooks are provided in the rear of the vehicle. Press sideways onto the edge to fold open.

Storage compartments in the cargo area

Storage space under cargo floor panel

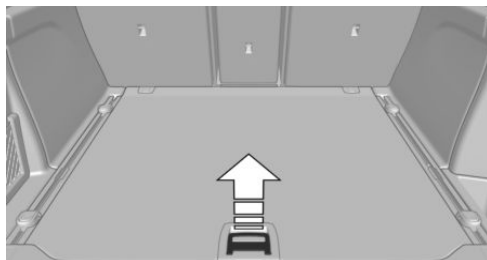

Fold up the cargo floor panel. The storage space under the cargo floor panel is subdivided.

Multi-function hook



WARNING

Improper use of the multi-function hooks can lead to a risk of objects flying about during braking and evasive maneuvers. There is a risk of injury and risk of property damage. Only hang lightweight objects, e.g., shopping bags, from the multi-function hooks. Only transport heavy luggage in the cargo area if it has been appropriately secured. ◀

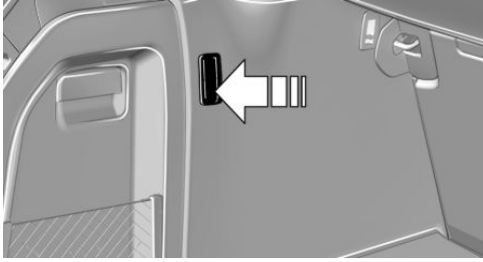

Depending on the installed equipment version, there are one or two multi-function hooks in the cargo area.

Retaining strap

A retaining strap is available on the left side trim for fastening small objects.

Net

Smaller objects can be stored in the net on the left side of the cargo area.

Storage compartment on the right side

A waterproof storage compartment is available on the right side of the cargo area.

Left side storage compartment

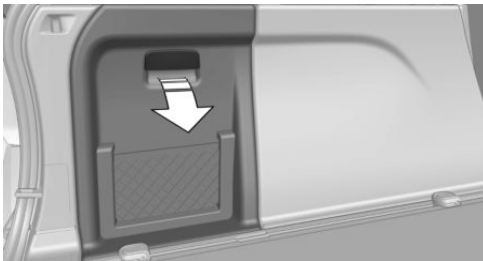

Pull the handle.

Lashing eyes in the cargo area with rail

To secure the cargo, refer to page 201, there are lashing eyes in the cargo area.

Cargo net, FlexNet

To secure the cargo, refer to page 201, the flexible cargo net can also be used.



Driving tips

This chapter provides you with information useful in dealing with specific driving and operating modes.

Things to remember when driving

Vehicle features and options

This chapter describes all standard, country-specific and optional features offered with the series. It also describes features that are not necessarily available in your vehicle, e. g., due to the selected options or country versions.

This also applies to safety-related functions and systems. When using these functions and systems, the applicable laws and regulations must be observed.

Breaking-in period

General information

Moving parts need to begin working together smoothly.

The following instructions will help you to achieve a long vehicle life and good efficiency.

During break-in, do not use the Launch Control.

Safety information



WARNING

Due to new parts and components, safety and driver assistance systems can react with a delay. There is a risk of an accident. After installing new parts or with a new vehicle, drive conservatively and intervene early if necessary. Observe the break-in procedures of the respective parts and components. ◀

Engine, transmission, and axle drive

Up to 1,200 miles/2,000 km

Do not exceed the maximum engine and road speed:

- ▷ For gasoline engine 4,500 rpm and 100 mph/160 km/h.

Avoid full load or kickdown under all circumstances.

From 1,200 miles/2,000 km

The engine and vehicle speed can gradually be increased.

Tires

Tire traction is not optimal due to manufacturing circumstances when tires are brand-new; they achieve their full traction potential after a break-in time.

Drive conservatively for the first 200 miles/300 km.

Brake system

Brake discs and brake pads only reach their full effectiveness after approx. 300 miles/500 km. Drive moderately during this break-in period.

Following part replacement

The same break-in procedures should be observed if any of the components above-mentioned have to be renewed in the course of the vehicle's operating life.

General driving notes

Closing the tailgate



WARNING

An open tailgate protrudes from the vehicle and can endanger occupants and other traffic participants or damage the vehicle in the event of an accident, braking or evasive maneuvers. In addition, exhaust fumes may enter the vehicle interior. There is a risk of injury or risk of damage to property. Do not drive with the tailgate open. ◀

If driving with the tailgate open cannot be avoided:

- ▷ Close all windows and the glass sunroof.
- ▷ Greatly increase the air flow from the vents.
- ▷ Drive moderately.

Hot exhaust system

WARNING

During driving operation, high temperatures can occur underneath the vehicle body, e.g., caused by the exhaust gas system. If combustible materials, such as leaves or grass, come in contact with hot parts of the exhaust gas system, these materials can ignite. There is a risk of injury or risk of property damage. Do not remove the heat shields installed and never apply undercoating to them. Make sure that no combustible materials can come in contact with hot vehicle parts in driving operation, idle or during parking. Do not touch the hot exhaust system. ◀

Climate control windshield

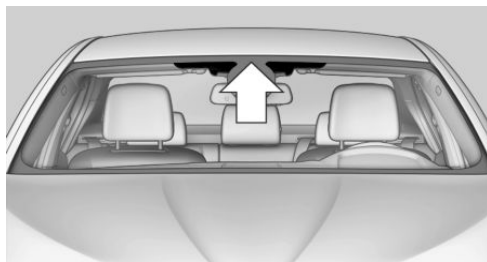

The marked area is not covered with heat reflective coating.

Use this area for garage door openers, devices for electronic toll collection, etc.

Mobile communication devices in the vehicle

WARNING

Vehicle electronics and mobile phones can influence one another. There is radiation due to the transmission operations of mobile phones. There is a risk of injury or risk of property damage. If possible, in the vehicle's interior use only mobile phones with direct connections to an exterior antenna in order to exclude mutual interference and deflect the radiation from the vehicle's interior. ◀

Hydroplaning

On wet or slushy roads, a wedge of water can form between the tires and road surface.

This phenomenon is referred to as hydroplaning. It is characterized by a partial or complete loss of contact between the tires and the road surface, ultimately undermining your ability to steer and brake the vehicle.

Driving through water

Safety information

NOTE

When driving too quickly through too deep water, water can enter into the engine compartment, the electrical system or the transmission. There is a risk of property damage. When driving through water, do not exceed the maximum indicated water level and the maximum speed for driving through water. ◀

When driving through water, observe the following:

- ▷ Drive through calm water only.
- ▷ Drive through water only if it is not deeper than maximum 17.6 inches/45 cm.
- ▷ Drive through water no faster than walking speed, up to 3 mph/5 km/h.

Braking safely

The vehicle is equipped with ABS as a standard feature.

Perform an emergency stop in situations that require such.

Steering is still responsive. You can still avoid any obstacles with a minimum of steering effort.

Pulsation of the brake pedal and sounds from the hydraulic circuits indicate that ABS is in its active mode.

In certain braking situations, the perforated brake discs can emit functional noises. However, this has no effect on the performance and operational reliability of the brake.

Objects in the movement area around pedals and floor area

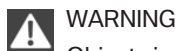

WARNING

Objects in the driver's floor area can limit the pedal distance or block a depressed pedal. There is a risk of an accident. Stow objects in the vehicle such that they are secured and cannot enter into the driver's floor area. Use floor mats that are suitable for the vehicle and can be safely attached to the floor. Do not use loose floor mats and do not layer several floor mats. Make sure that there is sufficient clearance for the pedals. Ensure that the floor mats are securely fastened again after they were removed, e.g., for cleaning. ◀

Driving in wet conditions

When roads are wet, salted, or in heavy rain, gently press the brake pedal every few miles.

Ensure that this action does not endanger other traffic.

The heat generated during braking dries brake discs and brake pads and protects them against corrosion.

In this way braking efficiency will be available when you need it.

Hills



WARNING

Light but consistent brake pressure can lead to high temperatures, brakes wearing out and possibly even brake failure. There is a risk of an accident. Avoid placing excessive stress on the brake system. ◀



WARNING

In idle state or with the engine switched off, safety-relevant functions, e.g., engine braking effect, braking force boost and steering assistance, are restricted or not available at all. There is a risk of an accident. Do not drive in idle state or with the engine switched off. ◀

Drive long or steep downhill gradients in the gear that requires least braking effort. Otherwise, the brakes may overheat and reduce brake efficiency.

You can increase the engine's braking effect by shifting down, going all the way to first gear, if needed.

Brake disc corrosion

Corrosion on the brake discs and contamination on the brake pads are increased by the following circumstances:

- ▷ Low mileage.
- ▷ Extended periods when the vehicle is not used at all.
- ▷ Infrequent use of the brakes.
- ▷ Aggressive, acidic, or alkaline cleaning agents.

Corrosion buildup on the brake discs will cause a pulsating effect on the brakes in their response - generally this cannot be corrected.

Condensation water under the parked vehicle

When using the automatic climate control, condensation water develops and collects underneath the vehicle.

Driving on poor roads

Concept

Because of its greater ground clearance, the vehicle can be driven on a variety of road types and qualities.

All-wheel drive can help improve forward momentum.

Safety information



NOTE

Objects in unpaved areas, e.g., stones or branches, can damage the vehicle. There is a risk of property damage. Do not drive on unpaved terrain. ◀

When driving on poor roads

For your own safety, for the safety of passengers and of the vehicle, heed the following points:

- ▷ Become familiar with the vehicle before starting a trip; do not take risks while driving.
- ▷ Adjust the speed to the road surface conditions. The steeper and more uneven the road surface, the slower the speed should be.
- ▷ When driving on steep uphill or downhill grades: add engine oil and coolant up to near the MAX mark. Uphill and downhill grades can be traveled up to no more than 50 %.
- ▷ On steep downhill grades, use Hill Descent Control HDC.

Starting out is possible on uphill grades up to 32 %. The permissible side tilt is 50 %.

- ▷ Avoid that the chassis bottom coming in contact with the ground.

The ground clearance is no more than 7.8 inches/20 cm and can vary according to the vehicle's load.

- ▷ When wheels continue to spin, depress the accelerator so that driving stability control systems can distribute the driving force to the wheels. Activate DTC Dynamic Traction Control if available.

After a trip on poor roads

After a trip on poor roads, check wheels and tires for damage to maintain driving safety. Clear heavy soiling from the body.

Driving on racetracks

Higher mechanical and thermal loads during racetrack operation lead to increased wear. This wear is not covered by the warranty. The vehicle is not designed for use in motor sports competition.

Loading

Vehicle features and options

This chapter describes all standard, country-specific and optional features offered with the series. It also describes features that are not necessarily available in your vehicle, e. g., due to the selected options or country versions. This also applies to safety-related functions and systems. When using these functions and systems, the applicable laws and regulations must be observed.

Safety information



WARNING

High gross weight can overheat the tires, damage them internally and cause a sudden drop in tire inflation pressure. Driving characteristics may be negatively impacted, reducing lane stability, lengthening the braking distances and changing the steering response. There is a risk of an accident. Pay attention to the permitted load capacity of the tires and never exceed the permitted gross weight. ◀



WARNING

Loose objects or devices with a cable connection to the vehicle, e.g., mobile phones, can be thrown into the vehicle's interior while driving, e.g., in the event of an accident or during braking and evasive maneuvers. There is a risk of injury. Secure loose objects or devices with a cable connection to the vehicle in the vehicle's interior. ◀



WARNING

Improperly stowed objects can shift and be thrown into the vehicle's interior, e.g., in the event of an accident or during braking and evasive maneuvers. Vehicle occupants can be hit and injured. There is a risk of injury. Stow and secure objects and cargo properly. ◀



NOTE

Fluids in the cargo area can cause damage. There is a risk of property damage. Make sure that no fluids leak in the cargo area. ◀

Steps for Determining Correct Load Limit

1. Locate the statement "The combined weight of occupants and cargo should never exceed XXX kg or XXX lbs." on your vehicle's placard.
2. Determine the combined weight of the driver and passengers that will be riding in your vehicle.
3. Subtract the combined weight of the driver and passengers from XXX kg or XXX lbs.
4. The resulting figure equals the available amount of cargo and luggage load capacity. For example, if the "XXX" amount equals 1,400 lbs. and there will be five 150 lb passengers in your vehicle, the amount of available cargo and luggage load capacity is 650 lbs. (1,400-750 (5 x 150) = 650 lbs.)
5. Determine the combined weight of luggage and cargo being loaded on the vehicle. That weight may not safely exceed the available cargo and luggage load capacity calculated in Step 4.
6. If your vehicle will be towing a trailer, load from your trailer will be transferred to your vehicle. Consult this manual to determine how this reduces the available cargo and luggage load capacity of your vehicle.

Load

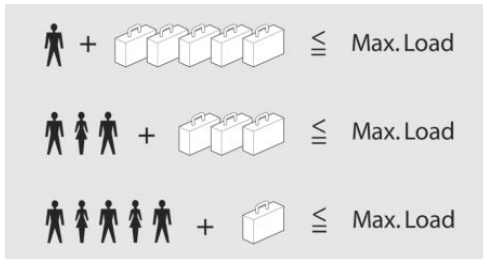

The maximum load is the sum of the weight of the occupants and the cargo.

The greater the weight of the occupants, the less cargo that can be transported.

Stowing and securing cargo

- ▶ Cover sharp edges and corners on the cargo.
- ▶ Heavy cargo: stow as far forward as possible, directly behind and at the bottom of the rear passenger seat backrests.
- ▶ Very heavy cargo: when the rear seat is not occupied, secure each of the outer safety belts in the opposite buckle.
- ▶ If necessary, fold down the rear backrests to stow cargo.
- ▶ Do not stack cargo above the top edge of the backrests.
- ▶ Smaller and lighter cargo: secure with ratchet straps or with a cargo net or draw straps.
- ▶ Larger and heavy cargo: secure with cargo straps.

Lashing eyes in the cargo area with rails

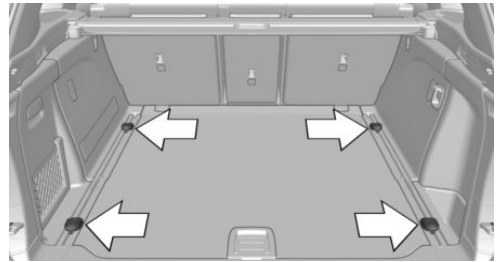

To secure the cargo there are four movable lashing eyes in the cargo area.

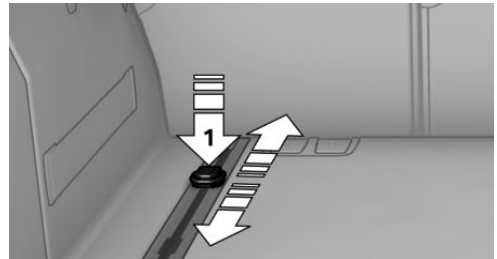

To slide the lashing eyes, press the button, arrow 1. Make sure that the lashing eyes latch at the new position.

The lashing eyes at the openings in the rails can be removed.

Attach load securing aids, such as lashing straps, retaining straps, draw straps or cargo nets, to the lashing eyes in the cargo area.

Cargo net, FlexNet

The flexible cargo net is hooked into eyes and offers a stowage option in the cargo area. The storage net can be attached to the following eyes:

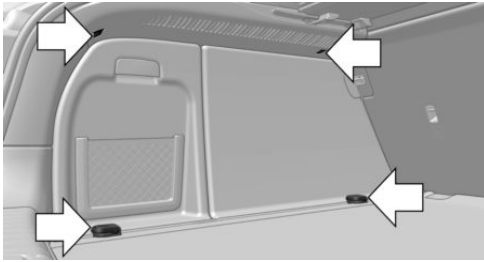

- ▷ Lashing eyes in the rails.
- ▷ Eyes on the cargo area wall.

The eyes are located on both sides of the cargo area.

Attach load securing aids, such as cargo straps, lashing straps, retaining straps, draw straps or cargo nets, to the lashing eyes in the cargo area.

Roof-mounted luggage rack

General information

Installation only possible with roof rack.

Roof racks are available as special accessories.

Safety information



WARNING

When driving with roof load, e.g., with roof-mounted luggage rack, driving safety may not be ensured in driving-critical situations due to the elevated center of gravity. There is a risk of accidents or risk of property damage. Do not deactivate Dynamic Stability Control DSC when driving with roof load. ◀

Securing

Follow the installation instructions of the roof rack.

Loading

Because roof-mounted luggage racks raise the vehicle's center of gravity when loaded, they

have a major effect on vehicle handling and steering response.

Therefore, note the following when loading and driving:

- ▷ Do not exceed the approved roof/axle loads and the approved gross vehicle weight.
- ▷ Be sure that adequate clearance is maintained for tilting and opening the glass sunroof.
- ▷ Distribute the roof load uniformly.
- ▷ The roof load should not extend past the loading area.
- ▷ Always place the heaviest pieces on the bottom.
- ▷ Secure the roof luggage firmly, e.g., using ratchet straps.
- ▷ Do not let objects project into the opening path of the tailgate.
- ▷ Drive cautiously and avoid sudden acceleration and braking maneuvers. Take corners gently.

Saving fuel

Vehicle features and options

This chapter describes all standard, country-specific and optional features offered with the series. It also describes features that are not necessarily available in your vehicle, e. g., due to the selected options or country versions. This also applies to safety-related functions and systems. When using these functions and systems, the applicable laws and regulations must be observed.

General information

The vehicle contains advanced technologies for the reduction of fuel consumption and emission values.

Fuel consumption depends on a number of different factors.

Carrying out certain measures, such as a moderate driving style and regular maintenance, can influence fuel consumption and the environmental impact.

Remove unnecessary cargo

Additional weight increases fuel consumption.

Remove attached parts following use

Remove roof-mounted luggage racks which are no longer required following use.

Attached parts on the vehicle impair the aerodynamics and increase the fuel consumption.

Close the windows and glass sunroof

Driving with the glass sunroof and windows open results in increased air resistance and thereby reduces the range.

Tires

General information

Tires can affect fuel consumption in various ways, e.g., tire size may influence fuel consumption.

Check the tire inflation pressure regularly

Check and, if needed, correct the tire inflation pressure at least twice a month and before starting on a long trip.

Low tire inflation pressure increases rolling resistance and thus raises fuel consumption and tire wear.

Drive away immediately

Do not wait for the engine to warm-up while the vehicle remains stationary. Start driving right away, but at moderate engine speeds.

This is the quickest way of warming the cold engine up to operating temperature.

Look well ahead when driving

Driving smoothly and proactively reduces fuel consumption.

Avoid unnecessary acceleration and braking.

By maintaining a suitable distance to the vehicle driving ahead of you.

Avoid high engine speeds

As a rule: driving at low engine speeds lowers fuel consumption and reduces wear.

Use 1st gear to get the vehicle moving. Starting with the 2nd gear, accelerate rapidly. When accelerating, shift up before reaching high engine speeds.

When you reach the desired speed, shift into the highest applicable gear and drive with low engine speed and at a constant speed.

If necessary, observe the vehicle's gear shift indicator, refer to page [97](#).

Use coasting

When approaching a red light, take your foot off the accelerator and let the vehicle coast to a halt.

For going downhill take your foot off the accelerator and let the vehicle roll.

The flow of fuel is interrupted while coasting.

Switch off the engine during longer stops

Switch off the engine during longer stops, e.g., at traffic lights, railroad crossings or in traffic congestion.

Auto Start/Stop function

The Auto Start/Stop function of the vehicle automatically switches off the engine during a stop.

If the engine is switched off and then restarted rather than leaving the engine running constantly, fuel consumption and emissions are reduced. Savings can begin within a few seconds of switching off the engine.

In addition, fuel consumption is also determined by other factors, such as driving style, road conditions, maintenance or environmental factors.

Switch off any functions that are not currently needed

Functions such as seat heating and the rear window defroster require a lot of energy and reduce the range, especially in city and stop-and-go traffic.

Switch off these functions if they are not needed.

The ECO PRO driving program supports the energy conserving use of comfort features. These functions are automatically deactivated partially or completely.

Have maintenance carried out

Have the vehicle maintained regularly to achieve optimal vehicle efficiency and service life. BMW recommends that maintenance work be performed by a BMW dealer's service center.

For information on the BMW Maintenance System, refer to page [241](#).

ECO PRO

Concept

ECO PRO supports a driving style that saves on fuel consumption. For this purpose, the engine control and comfort features, for instance the climate control output, are adjusted.

In addition, context-sensitive instructions are displayed to assist with an optimized fuel consumption driving style.

The achieved extended range is displayed in the instrument cluster as bonus range.

General information

The system includes the following EfficientDynamics functions and displays:

- ▷ ECO PRO bonus range, refer to page [205](#).

- ▷ ECO PRO tips driving instruction, refer to page 206.
- ▷ ECO PRO climate control, refer to page 205.
- ▷ ECO PRO coasting driving condition, refer to page 207.

Overview



Driving Dynamics Control

Activating ECO PRO



Press button repeatedly until ECO PRO is displayed in the instrument cluster.

Configuring ECO PRO

Via the Driving Dynamics Control

1. Activate ECO PRO.
2. "Configure ECO PRO"

Using iDrive

1. "Settings"
2. "Driving mode"
3. "Configure ECO PRO"

ECO PRO limit

- ▷ "ECO PRO speed warning":
An ECO PRO tip is displayed if the speed of the set ECO PRO limit is exceeded.
- ▷ "Tip at:":
Set the desired ECO PRO speed.

ECO PRO climate control

To activate ECO PRO climate control:

"ECO PRO climate control"

Climate control is set to be fuel-efficient.

By making a slight change to the set temperature, or slowly adjusting the rate of heating or cooling of the vehicle's interior, fuel consumption can be economized.

The mirror heating is made available when outside temperatures are very cold.

ECO PRO potential savings

Shows potential savings with the current settings in percentages.

Display in the instrument cluster

Display in the instrument display

When ECO PRO mode is activated, the display switches to a special configuration.

Some of the displays may differ from the display in the instrument cluster.

Blue bar segments symbolize the gained bonus range in stages.

In addition, the bonus range is highlighted in blue in the total range display.

ECO PRO bonus range

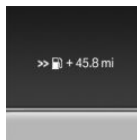

An adjusted driving style helps you extend your driving range.

This may be displayed as the bonus range in the instrument cluster.

The bonus range is shown in the range display.

The bonus range is automatically reset every time the vehicle is refueled.

ECO PRO efficiency display

Display in the instrument cluster

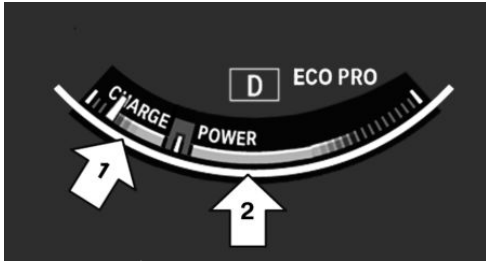

Display in the instrument display



A mark in the efficiency display informs about the current driving style.

Mark in the area of arrow 1: display of the energy recovered by coasting or when braking.

Mark in the area of arrow 2: display when accelerating.

Your driving style's efficiency is shown by the bar's color:

- ▶ Blue display: efficient driving style as long as the mark moves within the blue range.
- ▶ Gray display: adjust driving style, for instance by backing off the accelerator pedal.

The display switches to blue as soon as all conditions for driving with optimized fuel efficiency are met.

ECO PRO tip, driving tip



The arrow indicates that the driving style can be adjusted to be more fuel efficient, for instance by backing off the accelerator.

Activating the driving style indicator and ECO PRO tips

The efficiency display and ECO PRO tips in the instrument cluster appear when the ECO PRO display is activated.

Activate the display via iDrive:

1. "Settings"
2. "Instrument cluster"
3. "ECO PRO Info"

In the instrument display:

1. "Settings"
2. "Instrument cluster"
3. "Driving mode view"

ECO PRO tip, symbols

An additional symbol and text instructions are displayed.

Symbol	Measure
	For efficient driving back off the accelerator or delay accelerating to allow time to assess road conditions.
	Reduce speed to the selected ECO PRO speed.
	Steptronic transmission: shift from M/S to D.

Indications on the Control Display

Displaying EfficientDynamics info

Information on fuel consumption and technology can be displayed while driving.

Using iDrive:

1. "Vehicle info"
2. "EfficientDynamics"

Displaying EfficientDynamics info

The current efficiency can be displayed.

 "EfficientDynamics info"

The following systems are displayed:

- ▶ Auto Start/Stop function.
- ▶ Energy recovery.
- ▶ Climate control output.

Display ECO PRO tips

 "ECO PRO tips"

Settings are stored for the profile currently used.

Coasting

Concept

The function helps to conserve fuel.

To do this, under certain conditions the engine is automatically decoupled from the transmission when selector lever position D is set. The vehicle continues traveling with the engine idling to reduce fuel consumption. Selector lever position D remains engaged.

This driving condition is referred to as coasting.

As soon as you step on the brake or accelerator pedal, the engine is automatically coupled again.

General information

Coasting is a component of the ECO PRO driving mode.

Coasting is automatically activated when ECO PRO mode is called via the Driving Dynamics Control.

The function is available in a certain speed range.

A proactive driving style helps the driver to use the function often and supports the fuel-conserving effect of coasting.

Functional requirements

In ECO PRO mode, this function is available in a speed range from approximately 30 mph/50 km/h to 100 mph/160 km/h if the following conditions are met:

- ▶ Accelerator pedal and brake pedal are not operated.
- ▶ The selector lever is in selector lever position D.
- ▶ Engine and transmission are at operating temperature.

Operation via shift paddles

Concept

Depending on your vehicle's equipment, the coasting mode can be influenced with the shift paddles.

Activating/deactivating coasting via shift paddles

1. Shift to the highest gear by pulling the right shift paddle.
2. Actuate the right shift paddle again to enter coasting mode.

To deactivate, actuate the left shift paddle.

Display

Display in the instrument cluster

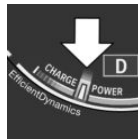

The mark in the efficiency display below the tachometer is backlit in blue and is located at the zero point. The tachometer approximately indicates idle

speed.

The coasting point indicator is illuminated at the zero point during coasting.

Display in the instrument display

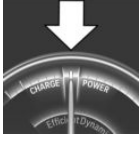

The mark in the efficiency display is backlit in blue and is located at the zero point.

The coasting point indicator is illuminated at the zero point during coasting.

during coasting.

- ▷ If driving on steep uphill or downhill grades.
- ▷ If the battery charge state is temporarily too low.
- ▷ If the vehicle electrical system is drawing excessive current.

Indications on the Control Display

The coasting driving condition is displayed in EfficientDynamics Info while this driving mode is active.

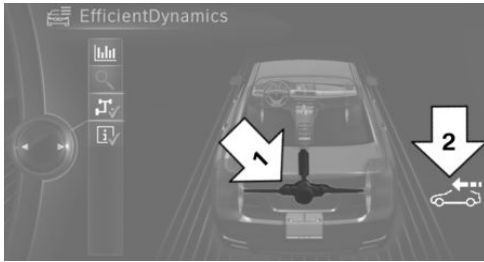

Color code blue, arrow 1, and symbol, arrow 2: driving condition coasting.

Displaying EfficientDynamics info

1. "Vehicle info"
2. "EfficientDynamics"
3.  "EfficientDynamics info"

Deactivating the function manually

The function can be deactivated in the Configure ECO PRO menu, e.g., to use the braking effect of the engine when traveling downhill.

Settings are stored for the profile currently used.

System limits

The function is not available if one of the following conditions applies:

- ▷ DSC OFF or TRACTION activated.
- ▷ If cruise control is activated.
- ▷ If driving in the dynamic limit range.





Mobility

In order to always ensure your mobility, you will find important information on operating fluids, wheels and tires, maintenance and Roadside Assistance in the following.

Refueling

Vehicle features and options

This chapter describes all standard, country-specific and optional features offered with the series. It also describes features that are not necessarily available in your vehicle, e. g., due to the selected options or country versions. This also applies to safety-related functions and systems. When using these functions and systems, the applicable laws and regulations must be observed.

General information

Observe the fuel recommendation, refer to page 214, prior to refueling.

Safety information



NOTE

With a range of less than 30 miles/50 km it is possible that the engine will no longer have sufficient fuel. Engine functions are not ensured anymore. There is a risk of property damage. Refuel promptly. ◀

Fuel cap

Opening

1. Briefly press the rear edge of the fuel filler flap.



2. Turn the fuel cap counterclockwise.

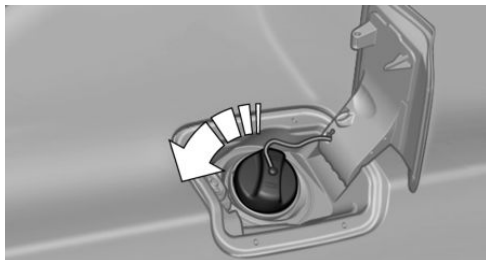

3. Place the fuel cap in the bracket attached to the fuel filler flap.

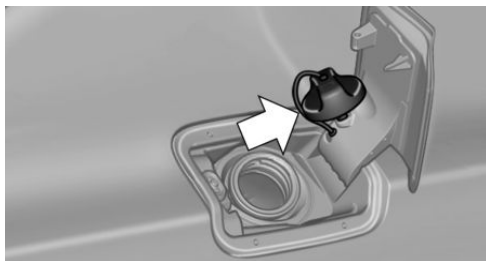

Closing



WARNING

The retaining strap of the fuel cap can be jammed and crushed during closing. The cap cannot be correctly closed. Fuel or fuel vapors can escape. There is a risk of injury or risk of property damage. Pay attention that the retaining strap is not jammed or crushed when closing the lid. ◀

1. Fit the cap and turn it clockwise until you clearly hear a click.
2. Close the fuel filler flap.

Manually unlocking fuel filler flap

E.g., in the event of an electrical malfunction.

Have fuel filler flap unlocked by a dealer's service center or another qualified service center or repair shop.

Observe the following when refueling

General information

The fuel tank is full when the filler nozzle clicks off the first time.

Observe safety regulations posted at the gas station.

Safety information



NOTE

Fuels are toxic and aggressive. Overfilling of the fuel tank can damage the fuel system. Painted surfaces may be damaged by contact with fuel. Escaping fuel can harm the environment. There is a risk of property damage. Avoid overfilling. ◀

Fuel

Vehicle features and options

This chapter describes all standard, country-specific and optional features offered with the series. It also describes features that are not necessarily available in your vehicle, e. g., due to the selected options or country versions. This also applies to safety-related functions and systems. When using these functions and systems, the applicable laws and regulations must be observed.

Fuel recommendation

General information

Depending on the region, many gas stations sell fuel that has been customized to winter or summer conditions. Fuel that is available in winter, e.g., helps make a cold start easier.

Gasoline

General information

For the best fuel efficiency, the gasoline should be sulfur-free or very low in sulfur content.

Fuels that are marked on the gas pump as containing metal must not be used.

Fuels with a maximum ethanol content of 10 %, i. e., E10, may be used for refueling.

Ethanol should meet the following quality standards:

US: ASTM 4806–xx

CAN: CGSB-3.511–xx

xx: comply with the current standard in each case.

Safety information



NOTE

Do not press the Start/Stop button after refueling with the wrong fuel. Furthermore, the catalytic converter is permanently damaged. There is a risk of property damage. Do not refuel or add the following in the case of gasoline engines:

- ▷ Leaded gasoline.
- ▷ Metallic additives, e.g., manganese or iron.

Do not press the Start/Stop button after refueling with the wrong fuel. Contact a dealer's service center or another qualified service center or repair shop. ◀



NOTE

Incorrect fuels can damage the fuel system and the engine. There is a risk of damage to property. Do not use fuels with a higher percentage of ethanol than recommended. Do not refuel with fuels containing methanol, e.g. M5 to M100. ◀



NOTE

Fuel that does not comply with the minimum quality can compromise engine function or cause engine damage. There is a risk of property damage. Do not fill with fuel that does not comply with the minimum quality. ◀



CAUTION

The use of poor-quality fuels may result in harmful engine deposits or damage. Additionally, problems relating to drivability, starting and stalling, especially under certain environmental conditions such as high ambient temperature and high altitude, may occur.

If drivability problems are encountered, we recommend switching to a high quality gasoline brand and a higher octane grade — AKI number — for a few tank fills. To avoid harmful en-

gine deposits, it is highly recommended to purchase gasoline from Top Tier retailers.

Failure to comply with these recommendations may result in the need for unscheduled maintenance.◀

Recommended fuel grade

BMW recommends AKI 91.

Minimum fuel grade

BMW recommends AKI 89.

If you use gasoline with this minimum AKI Rating, the engine may produce knocking sounds when starting at high outside temperatures.

This has no effect on the engine life.

BMW recommends
Shell Quality Fuels 

Wheels and tires

Vehicle features and options

This chapter describes all standard, country-specific and optional features offered with the series. It also describes features that are not necessarily available in your vehicle, e. g., due to the selected options or country versions. This also applies to safety-related functions and systems. When using these functions and systems, the applicable laws and regulations must be observed.

Tire inflation pressure

General information

The tire characteristics and tire inflation pressure influence the following:

- ▷ The service life of the tires.
- ▷ Road safety.
- ▷ Driving comfort.

Safety information



WARNING

A tire with low or missing tire inflation pressure impacts handling, such as steering and braking response. There is a risk of an accident. Regularly check the tire inflation pressure, and correct it as needed, e.g., twice a month and before a long trip. ◀

Checking the tire inflation pressure

Only check the tire inflation pressure when the tires are cold. This means after driving no more than 1.25 miles/2 km or when the vehicle has been parked for at least 2 hours.

Tires heat up while driving, and the tire inflation pressure increases along with the tire's temperature. The tire inflation pressure specifications relate to cold tires or tires at ambient temperature.

The displays of inflation devices may under-read by up to 0.1 bar/2 psi.

Tires have a natural, consistent loss of tire inflation pressure.

For Flat Tire Monitor: after correcting the tire inflation pressure, reinitialize the Flat Tire Monitor.

For Tire Pressure Monitor: perform a reset of the Tire Pressure Monitor after adjusting tire pressure to a new value.

Also check the tire inflation pressure of the emergency wheel in the cargo area regularly, and correct it as needed.

Tire inflation pressure specifications

The tire inflation pressure table, refer to page 217, contains all tire inflation pressure specifications for the specified tire sizes at the ambient temperature. The tire inflation pressure values apply to tire sizes approved by the manufacturer of the vehicle for the vehicle type.

To identify the correct tire inflation pressure, please note the following:

- ▷ Tire sizes of your vehicle.
- ▷ Maximum permitted driving speed.

Tire inflation pressures up to 100 mph/160 km/h

For speeds of up to 100 mph/160 km/h and for optimum driving comfort, note the pressure values in the tire inflation pressure table, refer to page 217, and adjust as necessary.



These pressure values can also be found on the tire inflation pressure label on the driver's door pillar.

Do not exceed a speed of 100 mph/160 km/h.

Tire inflation pressure values up to 100 mph/160 km/h

X6 sDrive35i, X6 xDrive35i

Tire size	Pressure specifications in bar/PSI	
Specifications in bar/PSI with cold tires		
255/50 R 19 107 H M+S XL A/S RSC	2.2 / 32	2.6 / 38
255/50 R 19 107 H M+S XL RSC		
Front: 255/50 R 19 107 W XL RSC	2.2 / 32	-
Rear: 285/45 R 19 111 W XL RSC	-	2.4 / 35
Front: 275/40 R 20 106 W XL RSC	2.2 / 32	-
Rear: 315/35 R 20 110 W XL RSC	-	2.4 / 35

Tire size	Pressure specifications in bar/PSI	
Front: 275/40 R 20 106 V M+S XL RSC	2.2 / 32	-
Rear: 315/35 R 20 110 V M+S XL RSC	-	2.4 / 35
Front: 285/35 R 21 105 Y XL RSC	2.4 / 35	-
Rear: 325/30 R 21 108 Y XL RSC	-	2.6 / 38
Emergency wheel: T 155/90 D 18 113 M	Speed up to a max. of 50 mph / 80 km/h	
T 155/90 R 18 113 M	4.2 / 60	

X6 xDrive50i

Tire size	Pressure specifications in bar/PSI	
Specifications in bar/PSI with cold tires		
255/50 R 19 107 H M+S XL A/S RSC	2.3 / 33	2.8 / 41
255/50 R 19 107 H M+S XL RSC		
Front: 255/50 R 19 107 W XL RSC	2.3 / 33	-
Rear: 285/45 R 19 111 W XL RSC	-	2.6 / 38

Tire size	Pressure specifications in bar/PSI	
Front: 275/40 R 20 106 W XL RSC	2.3 / 33	-
Rear: 315/35 R 20 110 W XL RSC	-	2.6 / 38
Front: 275/40 R 20 106 V M+S XL RSC	2.3 / 33	-
Rear: 315/35 R 20 110 V M+S XL RSC	-	2.6 / 38
Front: 285/35 R 21 105 Y XL RSC	2.5 / 36	-
Rear: 325/30 R 21 108 Y XL RSC	-	2.8 / 41
Emergency wheel: T 155/90 D 18 113 M	Speed up to a max. of 50 mph / 80 km/h	
T 155/90 R 18 113 M	4.2 / 60	

Tire inflation pressures at max. speeds above 100 mph/160 km/h



WARNING

In order to drive at maximum speeds in excess of 100 mph/160 km/h, please observe, and, if necessary, adjust tire pressures for speeds exceeding 100 mph/160 km/h from the relevant table on the following pages. Otherwise, tire damage and accidents could occur. ◀

For speeds over 100 mph/160 km/h and for optimum driving comfort, note the pressure values in the tire inflation pressure table, refer to page 218, and adjust as necessary.

Tire inflation pressure values over 100 mph/160 km/h

X6 sDrive35i, X6 xDrive35i

Tire size	Pressure specifications in bar/PSI	
Specifications in bar/PSI with cold tires		
255/50 R 19 107 H M+S XL A/S RSC	2.5 / 36	2.9 / 42
255/50 R 19 107 H M+S XL RSC		
Front: 255/50 R 19 107 W XL RSC	2.5 / 36	-
Rear: 285/45 R 19 111 W XL RSC	-	2.8 / 41
Front: 275/40 R 20 106 W XL RSC	2.7 / 39	-
Rear: 315/35 R 20 110 W XL RSC	-	3.0 / 44
Front: 275/40 R 20 106 V M+S XL RSC	2.7 / 39	-
Rear: 315/35 R 20 110 V M+S XL RSC	-	3.0 / 44
Front: 285/35 R 21 105 Y XL RSC	2.7 / 39	-

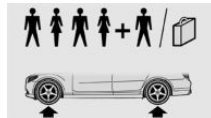

Tire size	Pressure specifications in bar/PSI
Rear: 325/30 R 21 108 Y XL RSC	- 3.1 / 45
Emergency wheel:	Speed up to a max. of
T 155/90 D 18	50 mph / 80 km/h
113 M	4.2 / 60
T 155/90 R 18	
113 M	

X6 xDrive50i

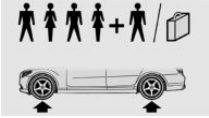
Tire size	Pressure specifications in bar/PSI
Specifications in bar/PSI with cold tires	
255/50 R 19 107 H M+S XL A/S RSC	2.8 / 41 3.2 / 46
255/50 R 19 107 H M+S XL RSC	
Front:	2.8 / 41 -
255/50 R 19 107 W XL RSC	
Rear: 285/45 R 19 111 W XL RSC	- 3.1 / 45
Front:	3.0 / 44 -
275/40 R 20 106 W XL RSC	
Rear: 315/35 R 20 110 W XL RSC	- 3.2 / 46
Front:	3.0 / 44 -
275/40 R 20 106 V M+S XL RSC	

Tire size	Pressure specifications in bar/PSI
Rear: 315/35 R 20 110 V M+S XL RSC	- 3.2 / 46
Front:	3.0 / 44 -
285/35 R 21 105 Y XL RSC	
Rear: 325/30 R 21 108 Y XL RSC	- 3.4 / 49
Emergency wheel:	Speed up to a max. of
T 155/90 D 18	50 mph / 80 km/h
113 M	4.2 / 60
T 155/90 R 18	
113 M	

Tire identification marks

Tire size

245/45 R 18 96 Y

245: nominal width in mm

45: aspect ratio in %

R: radial tire code

18: rim diameter in inches

96: load rating, not for ZR tires

Y: speed rating, before the R on ZR tires

Maximum tire load

Maximum tire load is the maximum permissible weight for which the tire is approved.

Locate the maximum tire load on the tire side-wall and the Gross Axle Weight Rating – GAWR – on the certification label on the driver's door pillar.

Divide the tire load by 1.1. It must be greater than one-half of the vehicle's Gross Axle Weight Rating – GAWR. Note, front vs. rear GAWR and tire loads, respectively.

Speed letter

Q = up to 100 mph, 160 km/h

R = up to 106 mph, 170 km/h

S = up to 112 mph, 180 km/h

T = up to 118 mph, 190 km/h

H = up to 131 mph, 210 km/h

V = up to 150 mph, 240 km/h

W = up to 167 mph, 270 km/h

Y = up to 186 mph, 300 km/h

Tire Identification Number

DOT code: DOT xxxx xxx 3816

xxxx: manufacturer code for the tire brand

xxx: tire size and tire design

3816: tire age

Tires with DOT codes meet the guidelines of the U.S. Department of Transportation.

Tire age

DOT ... 3816: the tire was manufactured in the 38th week of 2016.

Recommendation

Regardless of wear and tear, replace tires at least every 6 years.

Uniform Tire Quality Grading

Quality grades can be found where applicable on the tire sidewall between tread shoulder and maximum section width.

E.g.: Treadwear 200; Traction AA; Temperature A

DOT Quality Grades

Treadwear

Traction AA A B C

Temperature A B C

All passenger vehicle tires must conform to Federal Safety Requirements in addition to these grades.

Treadwear

The treadwear grade is a comparative rating based on the wear rate of the tire when tested under controlled conditions on a specified government test course. E.g., a tire graded 150 would wear one and one-half, 1 g, times as well on the government course as a tire graded 100. The relative performance of tires depends upon the actual conditions of their use, however, and may depart significantly from the norm due to variations in driving habits, service practices and differences in road characteristics and climate.

Traction

The traction grades, from highest to lowest, are AA, A, B, and C.

Those grades represent the tire's ability to stop on wet pavement as measured under controlled conditions on specified government test surfaces of asphalt and concrete. A tire marked C may have poor traction performance.

The traction grade assigned to this tire is based on straight-ahead braking traction tests, and does not include acceleration, cornering, hydroplaning, or peak traction characteristics.

Temperature

The temperature grades are A, the highest, B, and C, representing the tire's resistance to the generation of heat and its ability to dissipate heat when tested under controlled conditions on a specified indoor laboratory test wheel. Sustained high temperature can cause the material of the tire to degenerate and reduce tire life, and excessive temperature can lead to sudden tire failure. The grade C corresponds to a level of performance which all passenger vehicle tires must meet under the Federal Motor Vehicle Safety Standard No. 109. Grades Band A represent higher levels of performance on the laboratory test wheel than the minimum required by law.

**WARNING**

The temperature grade for this tire is established for a tire that is properly inflated and not overloaded. Excessive speed, underinflation, or excessive loading, either separately or in combination, can cause heat buildup and possible tire failure. ◀

RSC – Run-flat tires

Run-flat tires, refer to page 223, are labeled with a circular symbol containing the letters RSC marked on the sidewall.

M+S

Winter and all-season tires with better cold weather performance than summer tires.

Tire tread**Summer tires**

Do not drive with a tire tread depth of less than 0.12 inches/3 mm.

There is an increased risk of hydroplaning if the tire tread depth is less than 0.12 inches/3 mm.

Winter tires

Do not drive with a tire tread depth of less than 0.16 inches/4 mm.

Below a tread depth of 0.16 inches/4 mm, tires are less suitable for winter operation.

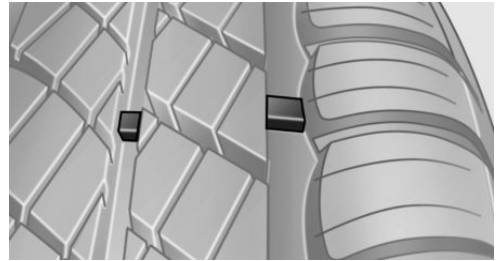
Minimum tread depth

Wear indicators are distributed around the tire's circumference and have the legally required minimum height of 0.063 inches/1.6 mm.

They are marked on the side of the tire with TWI, Tread Wear Indicator.

Tire damage**General information**

Inspect your tires regularly for damage, foreign objects lodged in the tread, and tread wear.

Driving over rough or damaged road surfaces, as well as debris, curbs and other obstacles can cause serious damage to wheels, tires and suspension parts. This is more likely to occur with low-profile tires, which provide less cushioning between the wheel and the road. Be careful to avoid road hazards and reduce your speed, especially if your vehicle is equipped with low-profile tires.

Indications of tire damage or other vehicle malfunctions:

- ▷ Unusual vibrations while driving.
- ▷ Unusual handling such as a strong tendency to pull to the left or right.

Damage can, e.g., be caused by driving over curbs, road damage, or similar things.

Safety information



WARNING

Damaged tires can lose tire inflation pressure, which can lead to loss of vehicle control. There is a risk of an accident. If tire damage is suspected while driving, immediately reduce speed and stop. Have wheels and tires checked. For this purpose, drive carefully to the nearest dealer's service center or another qualified service center or repair shop. Have vehicle towed or transported as needed. ◀



WARNING

Damaged tires can lose tire inflation pressure, which can lead to loss of vehicle control. There is a risk of an accident. Do not repair damaged tires, but have them replaced. ◀

Changing wheels and tires

Mounting

Have mounting and wheel balancing carried out by a dealer's service center or another qualified service center or repair shop.

Wheel and tire combination

General information

You can ask the dealer's service center or another qualified service center or repair shop about the correct wheel/tire combination and wheel rim versions for the vehicle.

Incorrect wheel and tire combinations impair the function of a variety of systems such as ABS or DSC.

To maintain good handling and vehicle response, use only tires with a single tread configuration from a single manufacturer.

Following tire damage, have the original wheel and tire combination remounted on the vehicle as soon as possible.

Safety information



WARNING

Wheels and tires which are not suitable for your vehicle can damage parts of the vehicle, for instance due to contact with the body due to tolerances despite the same official size rating. There is a risk of an accident. The manufacturer of your vehicle strongly suggests that you use wheels and tires that have been recommended by the vehicle manufacturer for your vehicle type. ◀

Recommended tire brands



For each tire size, BMW recommends certain tire brands. These can be identified by a star on the tire sidewall.

New tires

Tire traction is not optimal due to manufacturing circumstances when tires are brand-new; they achieve their full traction potential after a break-in time.

Drive conservatively for the first 200 miles/300 km.

Retreaded tires

The manufacturer of your vehicle does not recommend the use of retreaded tires.



WARNING

Retreaded tires can have different tire casing structures. With advanced age the service life can be limited. There is a risk of an acci-

dent. The manufacturer of your vehicle does not recommend the use of retreaded tires. ◀

Winter tires

Winter tires are recommended for operating on winter roads.

Although so-called all-season M+S tires provide better winter traction than summer tires, they do not provide the same level of performance as winter tires.

Maximum speed of winter tires

If the maximum speed of the vehicle is higher than the permissible speed for the winter tires, then attach a corresponding information label/sticker in the field of view. The label is available from a dealer's service center or another qualified service center or repair shop.

With mounted winter tires, observe and adhere to the permissible maximum speed.

Run-flat tires

If you are already using run-flat tires, for your own safety you should replace them only with the same kind. No spare tire is available in the case of a flat tire. Further information is available from a dealer's service center or another qualified service center or repair shop.

Rotating wheels between axles

Different wear patterns can occur on the front and rear axles depending on individual driving conditions. The tires can be rotated between the axles to achieve even wear. Further information is available from a dealer's service center or another qualified service center or repair shop. After rotating, check the tire pressure and correct, if needed.

Rotating the tires between the axes is not permissible on vehicles with different tire sizes or rim sizes on the front and rear axles.

Storage

Store wheels and tires in a cool, dry and dark place.

Always protect tires against all contact with oil, grease and fuels.

Do not exceed the maximum tire inflation pressure indicated on the side wall of the tire.

Run-flat tires

Concept

Runflat tires permit continued driving under restricted conditions even in the event of a complete loss of tire inflation pressure.

General information

The wheels consist of tires that are self-supporting, to a limited degree, and possibly special rims.

The support of the sidewall allows the tire to remain drivable to a restricted degree in the event of a tire inflation pressure loss.

Follow the instructions for continued driving with a flat tire.

Label

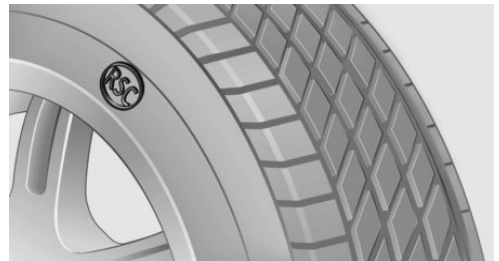

RSC label on the tire sidewall.

Changing run-flat tires

For your own safety, only use run-flat tires. No spare tire is available in the case of a flat tire.

A dealer's service center will be glad to answer additional questions at any time.

Repairing a flat tire

Safety measures

- ▷ Park the vehicle as far away as possible from passing traffic and on solid ground.
- ▷ Switch on the hazard warning system.
- ▷ Secure the vehicle against rolling away by setting the parking brake.
- ▷ Have all vehicle occupants get out of the vehicle and ensure that they remain outside the immediate area in a safe place, such as behind a guardrail.
- ▷ If necessary, set up a warning triangle or portable hazard warning light at a sufficient distance.
- ▷ Change wheels only on a flat, solid and slip-resistant surface. On soft or slippery ground, for example snow, ice, tiles, etc., the vehicle or the vehicle jack may slip away sideways.
- ▷ Do not place wood blocks or similar items under the vehicle jack; otherwise, it cannot reach its carrying capacity because of the restricted height.
- ▷ If the vehicle is raised, do not lie under the vehicle and do not start the engine, or else there is a danger to life.

Mobility System

Concept

With the Mobility System, minor tire damage can be sealed temporarily to enable continued travel. To accomplish this, sealant is pumped into the tires, which seals the damage from the inside.

The compressor can be used to check the tire inflation pressure.

General information

- ▷ Follow the instructions on using the Mobility System found on the compressor and sealant container.
- ▷ Use of the Mobility System may be ineffective if the tire puncture measures approx. 1/8 inches/4 mm or more.
- ▷ Contact a dealer's service center or another qualified service center or repair shop if the tire cannot be made drivable.
- ▷ If possible, do not remove foreign bodies that have penetrated the tire.
- ▷ Pull the speed limit sticker off the sealant container and apply it to the steering wheel.
- ▷ The use of a sealant can damage the TPM wheel electronics. In this case, have the electronics checked and replaced at the next opportunity.

Storage

The Mobility System is located under the cargo floor panel.

Sealant container



- ▷ Sealant container, arrow 1.
- ▷ Filling hose, arrow 2.

Observe use-by date on the sealant container.

Compressor

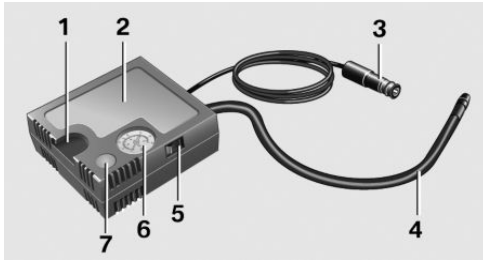

- 1 Holder for sealant container
- 2 Compressor
- 3 Connector/cable for socket
- 4 Connection hose
- 5 On/off switch
- 6 Inflation pressure dial
- 7 Reduce inflation pressure

Filling the tire with sealant

1. Shake the sealant container.



2. Pull the connection hose fully out of the compressor housing. Do not kink the hose.

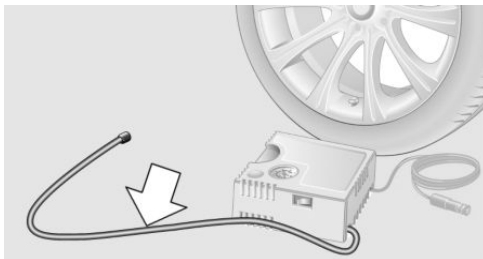

3. Screw the connection hose onto the connector of the sealant container.

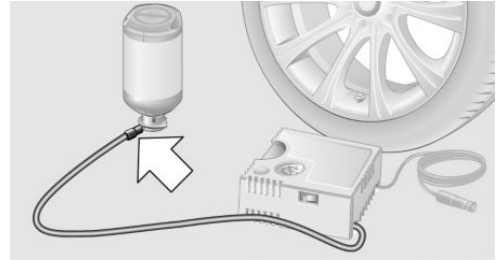

4. Insert the sealant container on the compressor housing in an upright position.

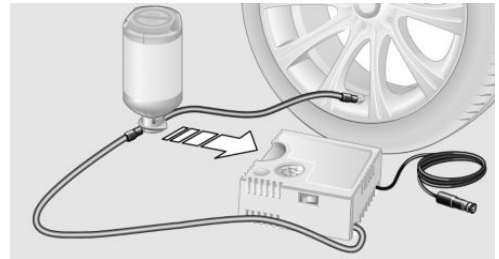

5. Screw the filling hose of the sealant container onto the tire valve of the nonworking wheel.

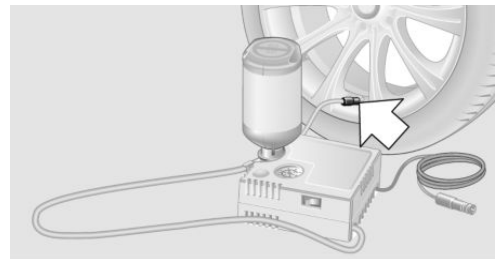

- With the compressor switched off, insert the plug into the power socket inside the vehicle.

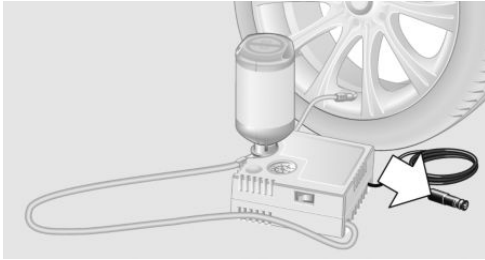

- With the ignition turned on or the engine running, switch on the compressor.

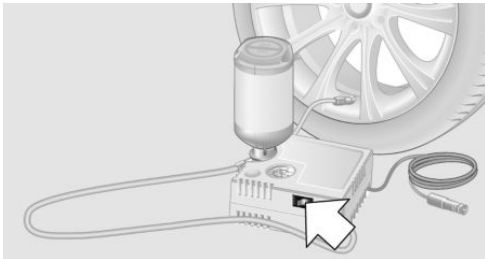

⚠ DANGER

If the exhaust pipe is blocked or ventilation is insufficient, harmful exhaust gases can enter into the vehicle. The exhaust gases contain carbon monoxide, an odorless and colorless but highly toxic gas. In enclosed areas, exhaust gases can also accumulate outside of the vehicle. There is danger to life. Keep the exhaust pipe free and ensure sufficient ventilation. ◀

⚠ NOTE

The compressor can overheat during extended operation. There is a risk of property damage. Do not run the compressor for more than 10 min. ◀

Let the compressor run for approx. 3 to 8 minutes to fill the tire with sealant and achieve a tire inflation pressure of approx. 2.5 bar.

While the tire is being filled with sealant, the tire inflation pressure may sporadically reach approx. 5 bar. Do not switch off the compressor at this point.

If a tire inflation pressure of 2 bar is not reached:

- Switch off the compressor.
- Unscrew the filling hose from the wheel.
- Drive 33 ft/10 m forward and back to distribute the sealant in the tire.
- Inflate the tire again using the compressor.

If a tire inflation pressure of 2 bar cannot be reached, contact your dealer's service center or another qualified service center or repair shop.

Stowing the Mobility System

- Unscrew the filling hose of the sealant container from the wheel.
- Unscrew the connection hose of the compressor from the sealant container.
- Connect the filling hose of the sealant container previously connected to the tire valve with the available connector on the sealant container.

This prevents leftover sealant from escaping from the container.

- Wrap the empty sealant container in suitable material to avoid dirtying the cargo area.
- Stow the Mobility System back in the vehicle.

Distributing the sealant

Immediately drive approx. 5 miles/10 km to ensure that the sealant is evenly distributed in the tire.

Do not exceed a speed of 50 mph/80 km/h.

If possible, do not drive at speeds less than 12 mph/20 km/h.

Correcting the tire inflation pressure

1. Stop at a suitable location.
2. Screw the connection hose of the compressor directly onto the tire valve stem.
3. Insert the connector into the power socket inside the vehicle.
4. Correct the tire inflation pressure to 2.5 bar.
 - ▷ Increase pressure: with the ignition turned on or the engine running, switch on the compressor.
 - ▷ To reduce the pressure: press the button on the compressor.

Continuing the trip

Do not exceed the maximum permissible speed of 50 mph/80 km/h.

Reinitialize the Flat Tire Monitor.

Reinitialize the Tire Pressure Monitor.

Replace the nonworking tire and the sealant container of the Mobility System promptly.

Snow chains

Fine-link snow chains

The manufacturer of your vehicle recommends use of fine-link snow chains. Certain types of fine-link snow chains have been tested by the manufacturer of the vehicle and recommended as road-safe and suitable.

Information regarding suitable snow chains is available from a dealer's service center or another qualified service center or repair shop.

Use



WARNING

With the mounting of snow chains on unsuitable tires, the snow chains can come into contact with vehicle parts. There is a risk of accidents or risk of property damage. Only mount snow chains on tires that are designated by

their manufacturer as suitable for the use of snow chains. ◀

Use only in pairs on the rear wheels, equipped with the tires of the following size:

- ▷ 255/50 R 19.

Follow the snow chain manufacturer's instructions.

Make sure that the snow chains are always sufficiently tight. Re-tighten as needed according to the snow chain manufacturer's instructions.

Do not initialize the Flat Tire Monitor after mounting snow chains, as doing so may result in incorrect readings.

Do not initialize the Tire Pressure Monitor after mounting snow chains, as doing so may result in incorrect readings.

When driving with snow chains, briefly activate Dynamic Traction Control, if needed.

Maximum speed with snow chains

Do not exceed a speed of 30 mph/50 km/h when using snow chains.

Changing wheels/tires

General information

When using run-flat tires or tire sealants, a tire does not always need to be changed immediately in the event of pressure loss due to a flat tire.

If needed, the tools for changing wheels are available as accessories from a dealer's service center or another qualified service center or repair shop.

Safety information



WARNING

The jack, issued by the vehicle manufacturer, is provided in order to perform a wheel change in the event of a breakdown. The jack is not designed for frequent use; for example,

changing from summer to winter tires.. Using the jack frequently may cause it to become jammed or damaged. There is a risk of injury and risk of damage to property. Only use the jack to attach an emergency or spare wheel in the event of a breakdown. ◀

**WARNING**

On soft or slippery ground, e.g., snow, ice, tiles, etc., the vehicle jack can slip away. There is a risk of injury. If possible, change the tire/wheel on a flat, solid and slip-resistant surface. ◀

**WARNING**

The vehicle jack is only provided for short-term lifting of the vehicle for wheel changes. Even if all safety measures are observed, there is a risk of the raised vehicle falling, if the vehicle jack tilts over. There is a risk of injuries or danger to life. If the vehicle is raised, do not lie under the vehicle and do not start the engine. ◀

**WARNING**

The vehicle jack is optimized for lifting the vehicle and for the jacking points on the vehicle only. There is a risk of injury. Do not lift any other vehicle or cargo using the vehicle jack. ◀

**WARNING**

If the vehicle jack is not inserted into the jacking point provided for this purpose, the vehicle may be damaged or the vehicle jack may slip when it is being cranked up. There is a risk of injury or risk of damage to property. When cranking up the vehicle jack, ensure that it is inserted in the jacking point next to the wheel housing. ◀

**WARNING**

A vehicle that is raised on a vehicle jack may fall off of the jack if lateral forces are exerted on it. There is a risk of injury and risk of damage to property. While the vehicle is

raised, do not exert lateral forces on the vehicle or pull abruptly on the vehicle. Have a stuck wheel removed by a dealer's service center or another qualified service center or repair shop. ◀

Securing the vehicle against rolling

General information

The vehicle manufacturer recommends to additionally secure the vehicle against rolling away when changing a wheel.

On a level surface



Place chocks or other suitable objects, for example a rock, in front of and behind the wheel that is diagonally opposite to the wheel that you wish to change.

On a slight downhill gradient

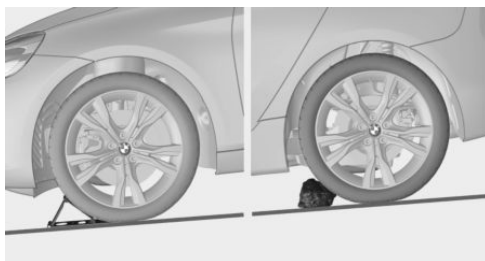

If you need to change a wheel on a slight downhill gradient, place chocks and other suitable objects, for example a rock, under the wheels of both the front and rear axles against the rolling direction.

Preparing the vehicle

- ▷ Change the wheel as far away as possible from passing traffic.
- ▷ Park the vehicle on solid, non-slip and level ground.
- ▷ Switch on the hazard warning system.
- ▷ Set the parking brake.
- ▷ Engage a gear or selector lever position P.
- ▷ As soon as permitted by the traffic flow, have all vehicle occupants get out of the vehicle and ensure that they remain outside the immediate area in a safe place, such as behind a guardrail.
- ▷ Depending on the equipment version, get tools and the emergency wheel from the vehicle.
- ▷ If necessary, set up a warning triangle or portable hazard warning lamp at an appropriate distance.
- ▷ Do not place wood blocks or similar items under the vehicle jack; otherwise, it cannot reach its carrying capacity because of the restricted height.
- ▷ Secure the vehicle additionally against rolling.
- ▷ Loosen the lug bolts a half turn.

Jacking points for the vehicle jack

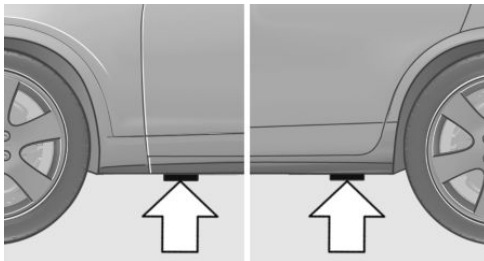

The jacking points for the vehicle jack are located at the indicated positions.

Jacking up the vehicle



WARNING

Hands and fingers can be jammed when using the vehicle jack. There is a risk of injury. Comply with the described hand position and do not change this position while using the vehicle jack. ◀

1. Hold the vehicle jack with one hand, arrow 1, and grasp the crank with your other hand, arrow 2.

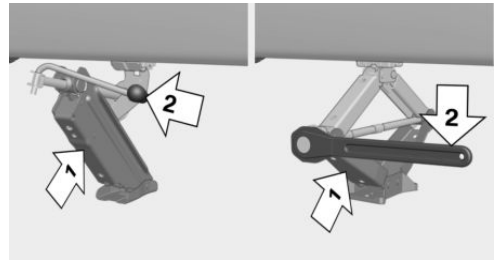

2. Insert the vehicle jack into the rectangular recess of the jacking point closest to the wheel to be changed.

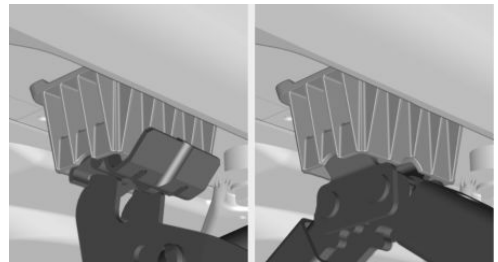

3. Extend the vehicle jack by turning the crank or lever clockwise.

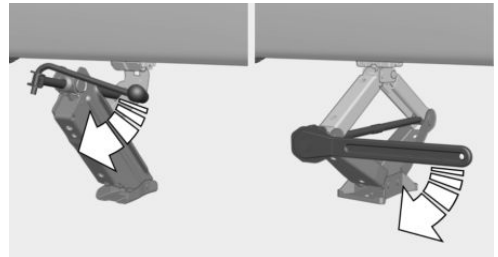

4. Take your hand away from the jack as soon as the vehicle jack is under load and continue turning the crank or lever with one hand.
5. Make sure that the vehicle jack foot is extended vertically.

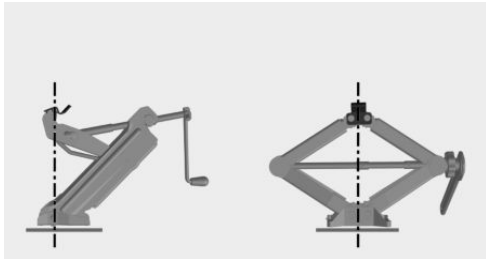

6. Make sure that the vehicle jack foot stands vertically and perpendicularly beneath the jacking point after extending the vehicle jack.

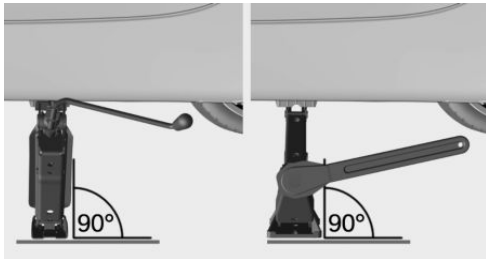

7. Crank up the vehicle jack until the entire surface of the jack is in contact with the ground and the wheel in question is raised a maximum of 1.2 inches/3 cm off the ground.

Mounting a wheel

Mount one emergency wheel only.

1. Unscrew the lug bolts and remove the wheel.
2. Put the new wheel or emergency wheel on and screw in at least two bolts in a crosswise pattern until hand-tight.

If non-original light-alloy wheels of the vehicle manufacturer are mounted, the accompanying lug bolts may have to be used as well.

3. Hand-tighten the remaining lug bolts and tighten all bolts well in a crosswise pattern.
4. Turn the crank on the vehicle jack counterclockwise to retract the jack and lower the vehicle.
5. Remove the vehicle jack.

After the wheel change

1. Tighten the lug bolts crosswise. The tightening torque is 101 lb ft/140 Nm.
2. Stow the nonworking wheel in the cargo area.
The nonworking wheel cannot be stored under the cargo floor panel because of its size.
3. Check tire inflation pressure at the next opportunity and correct as needed.
4. Reinitialize the Flat Tire Monitor.
Reset the Tire Pressure Monitor.
5. Check to make sure the lug bolts are tight with a calibrated torque wrench.
6. Drive to the nearest dealer's service center or another qualified service center or repair shop to have the damaged tire replaced.

emergency wheel

General information

In the event of a flat tire, the emergency wheel can be used in place of the wheel with the defective tire. The emergency wheel is only intended for temporary use to allow you to get the defective tire/wheel replaced.

Safety information



WARNING

The emergency wheel has particular dimensions. When driving with an emergency wheel, changed driving properties may occur

at higher speeds, e.g., reduced lane stability when braking, longer braking distance and changed self-steering properties in the limit area. There is a risk of an accident. Drive moderately and do not exceed a speed of 50 mph/80 km/h. ◀

Overview

The emergency wheel and the tools are located in the cargo area under the cargo floor panel.

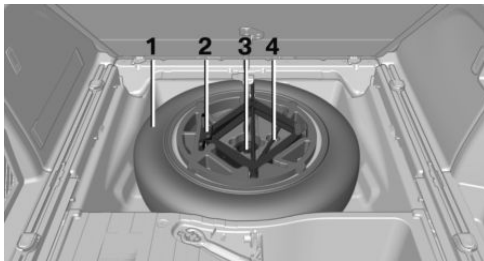

- 1 Emergency wheel
- 2 Vehicle jack
- 3 Vehicle jack crank
- 4 Lug bolt wrench

Removing the emergency wheel

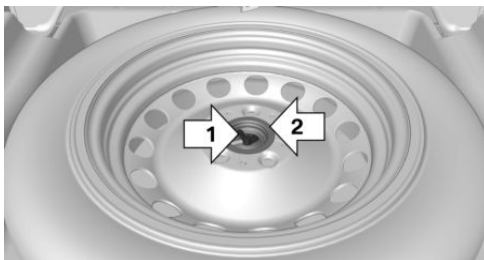

1. Remove the tool holder.
2. Unscrew the wing nut, arrow 1.
3. Remove the washer, arrow 2 to the side.
4. Remove the emergency wheel.

Engine compartment

Vehicle features and options

This chapter describes all standard, country-specific and optional features offered with the series. It also describes features that are not necessarily available in your vehicle, e. g., due

to the selected options or country versions. This also applies to safety-related functions and systems. When using these functions and systems, the applicable laws and regulations must be observed.

Important features in the engine compartment

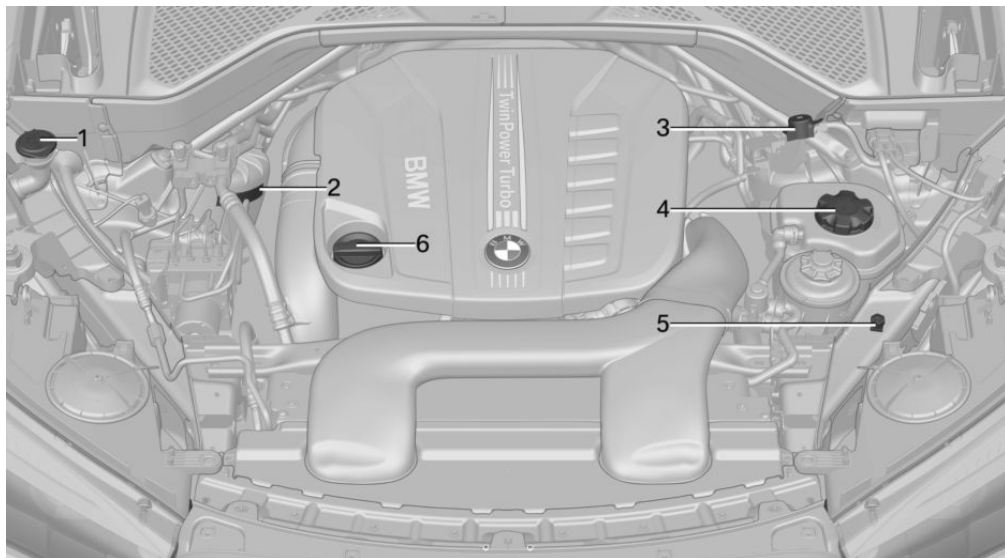

- | | | | |
|---|--|---|--|
| 1 | Washer fluid reservoir | 4 | Coolant reservoir |
| 2 | Vehicle identification number | 5 | Jump-starting, negative battery terminal |
| 3 | Jump-starting, positive battery terminal | 6 | Oil filler neck |

Hood

Safety information



WARNING

Improperly executed work in the engine compartment can damage vehicle components and impair vehicle functions. There is a risk of personal and property damage. The

manufacturer of your vehicle recommends that, in the effort to avoid such risks, work in the engine compartment be performed by a dealer's service center or another qualified service center or repair shop. ◀

**WARNING**

The engine compartment accommodates moving components. Certain components in the engine compartment can also move with the vehicle switched off, e.g., the radiator fan. There is a risk of injury. Do not reach into the area of moving parts. Keep articles of clothing and hair away from moving parts. ◀

**WARNING**

There are protruding parts, for instance locking hook, on the inside of the hood. There is a risk of injury. If the hood is open, pay attention to protruding parts and keep clear of these areas. ◀

**WARNING**

An incorrectly locked hood can open while driving and restrict visibility. There is a risk of an accident. Stop immediately and correctly close the hood. ◀

**WARNING**

Body parts can be jammed when opening and closing the hood. There is a risk of injury. Make sure that the area of movement of the hood is clear during opening and closing. ◀

**NOTE**

Folded-away wipers can be jammed when the hood is opened. There is a risk of property damage. Make sure that the wipers with the wiper blades mounted are folded down onto the windshield before opening the hood. ◀

Opening the hood

1. Pull the lever.

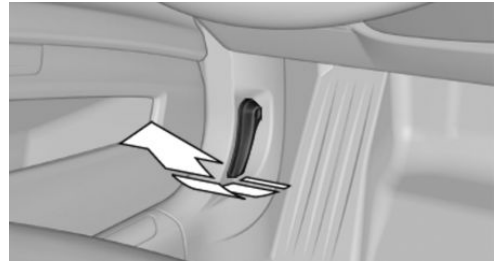

2. Press the release handle and open the hood.

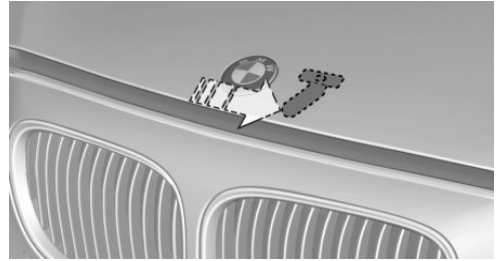

3. Be careful of protruding parts on the hood.

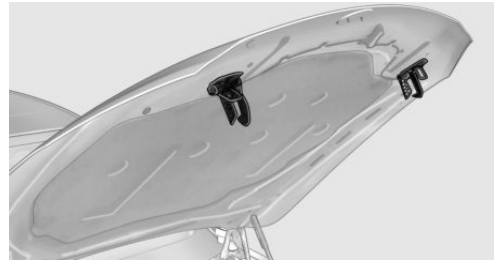

Closing the hood

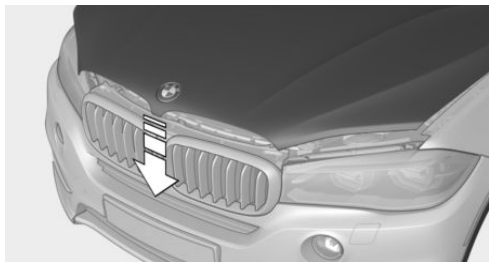

Let the hood drop from a height of approx. 16 inches/40 cm and push down on it to lock it fully.

The hood must engage on both sides.

Engine oil

Vehicle features and options

This chapter describes all standard, country-specific and optional features offered with the series. It also describes features that are not necessarily available in your vehicle, e. g., due to the selected options or country versions. This also applies to safety-related functions and systems. When using these functions and systems, the applicable laws and regulations must be observed.

General information

The engine oil consumption is dependent on the driving style and driving conditions.

The engine oil consumption can increase in the following situations, for example:

- ▶ Sporty driving style.
- ▶ Break-in of the engine.
- ▶ Idling of the engine.
- ▶ With use of engine oil types that are classified as not suitable.

Therefore, regularly check the engine oil level after refueling.

The vehicle is equipped with electronic oil measurement.

The electronic oil measurement has two measuring principles:

- ▶ Status display.
- ▶ Detailed measurement.

Electronic oil measurement

Status display

Concept

The engine oil level is monitored electronically while driving and shown on the Control Display.

If the engine oil level reaches the minimum level, a Check Control message is displayed.

Functional requirements

A current measured value is available after approx. 30 minutes of driving. During a shorter trip, the status of the last, sufficiently long trip is displayed.

With frequent short-distance trips, regularly perform a detailed measurement.

Displaying the engine oil level

Via iDrive:

1. "Vehicle info"
2. "Vehicle status"
3.  "Engine oil level"

The engine oil level is displayed.

Engine oil level display messages

Different messages appear on the display depending on the engine oil level. Pay attention to these messages.

If the engine oil level is too low within the next 125 miles/200 km, add engine oil.



A red indicator light indicates that the engine oil pressure is too low.



NOTE

An engine oil level that is too low causes engine damage. There is a risk of property damage. Immediately add engine oil. ◀

Take care not to add too much engine oil.

NOTE

Too much engine oil can damage the engine or the catalytic converter. There is a risk of property damage. Do not add too much engine oil. When too much engine oil is added, have oil level corrected by a dealer's service center or another qualified service center or repair shop. ◀

Detailed measurement

Concept

In the detailed measurement the engine oil level is checked when the vehicle is stationary, and displayed via a scale.

Gasoline engine:

If the engine oil level reaches the minimum level, a Check Control message is displayed.

During the measurement, the idle speed is increased somewhat.

Functional requirements

- ▶ Vehicle is parked in a horizontal position.
- ▶ Steptronic transmission: selector lever in selector lever position N or P and accelerator pedal not depressed.
- ▶ Engine is running and is at operating temperature.

Performing a detailed measurement

Using iDrive:

1. "Vehicle info"
2. "Vehicle status"
3.  "Measure engine oil level"
4. "Start measurement"

The engine oil level is checked and displayed via a scale.

Time: approx. 1 minute.

Adding engine oil

General information

Only add engine oil when the message is displayed in the instrument cluster. The quantity to be added is indicated in the message displayed in the instrument cluster.

Switch off the ignition and safely park the vehicle before engine oil is added.

Take care not to add too much engine oil.

Safety information

WARNING

Operating materials, e.g., oils, greases, coolants, fuels, can contain harmful ingredients. There is a risk of injuries or danger to life. Observe the instructions on the containers. Avoid the contact of articles of clothing, skin or eyes with operating materials. Do not refill operating materials into different bottles. Store operating materials out of reach of children. ◀

NOTE

An engine oil level that is too low causes engine damage. There is a risk of property damage.

Add engine oil within the next 125 miles/200 km. ◀

NOTE

Too much engine oil can damage the engine or the catalytic converter. There is a risk of property damage. Do not add too much engine oil. When too much engine oil is added, have oil level corrected by a dealer's service center or another qualified service center or repair shop. ◀

Overview

The oil filler neck is located in the engine compartment, refer to page 232.

Opening the oil filler neck

1. Opening the hood, refer to page 233
2. Open the lid counterclockwise.

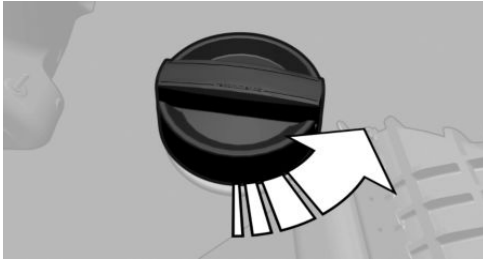

3. Add engine oil.

Engine oil types to add

General information

The engine oil quality is critical for the life of the engine.

Safety information



NOTE

Oil additives can damage the engine. There is a risk of property damage. Do not use oil additives. ◀



NOTE

Incorrect engine oil can cause malfunctions in the engine or damage it. There is a risk of property damage. When selecting an engine oil, make sure that the engine oil has the correct oil rating. ◀

Suitable engine oil types

You can add engine oils that meet the following oil rating standards:

Gasoline engine

BMW Longlife-01 FE.

BMW Longlife-14 FE+.

The oil rating BMW Longlife-14 FE+ is only suitable for particular gasoline engines.

More information about suitable engine oil ratings and viscosities of engine oils is available at a dealer's service center or another qualified service center or repair shop.

Alternative engine oil types

If an engine oil suitable for continuous use is not available, up to 1 US quart/liter of an engine oil with the following oil rating can be added:

Gasoline engine

BMW Longlife-01.

API SL or superior oil rating.

Viscosity grades

Gasoline engine:

When selecting an engine oil, make sure that the engine oil has the viscosity grade SAE 0W-30 or SAE 0W-20. Alternatively, also engine oils with viscosity grades SAE 5W-20, SAE 5W-30, SAE 0W-40 or SAE 5W-40 can be used.

The viscosity grades SAE 0W-20 or SAE 5W-20 are only suitable for particular engines.

More information about suitable engine oil ratings and viscosities of engine oils can be requested from a dealer's service center or another qualified service center or repair shop.

Engine oil change



NOTE

Engine oil that is not changed in timely fashion can cause increased engine wear and thus engine damage. There is a risk of property damage. Do not exceed the service data indicated in the vehicle. ◀

The vehicle manufacturer recommends that you have a dealer's service center or another

qualified service center or repair shop change the engine oil.

BMW recommends
Original BMW Engine Oil.

Coolant

Vehicle features and options

This chapter describes all standard, country-specific and optional features offered with the series. It also describes features that are not necessarily available in your vehicle, e. g., due to the selected options or country versions. This also applies to safety-related functions and systems. When using these functions and systems, the applicable laws and regulations must be observed.

General information

Not all commercially available additives are suitable for the vehicle. Information about suitable additives is available from a dealer's service center or another qualified service center or repair shop.

Safety information



WARNING

With the engine hot and the cooling system open, coolant can escape and lead to scalding. There is a risk of injury. Only open the cooling system with the engine cooled down. ◀



WARNING

Additives are harmful and incorrect additives can damage the engine. There is a risk of injury and risk of property damage. Do not allow additives to come into contact with skin, eyes or articles of clothing. Use suitable additives only. ◀

Coolant level

General information

If there is no Min. and Max. mark in the filler neck of the coolant reservoir, have the coolant level checked, if needed, by a dealer's service center or another qualified service center or repair shop and add coolant as needed.

Concept

Depending on the engine installation, the coolant reservoir is located on the right side or the left side of the engine compartment.

Checking

1. Let the engine cool.
2. Turn the lid of the coolant reservoir slightly counterclockwise to allow any excess pressure to dissipate, then open it.

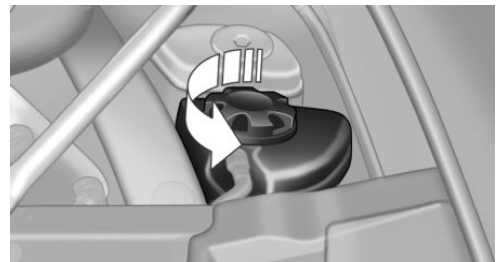

3. Open the coolant reservoir lid.
4. The coolant level is correct if it lies between the minimum and maximum marks in the filler neck.



Adding

1. Let the engine cool.
2. Turn the lid of the coolant reservoir slightly counterclockwise to allow any excess pressure to dissipate, then open it.

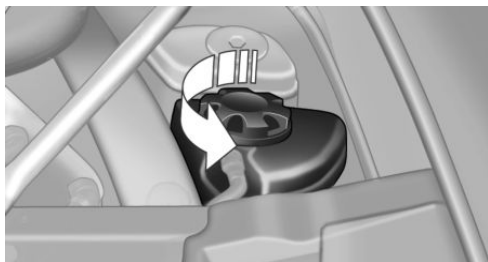

3. If the coolant is low, slowly add coolant up to the specified level; do not overfill.
4. Turn the lid until there is an audible click. The arrows on the coolant reservoir and the lid must point towards one another.
5. Have the cause of the coolant loss eliminated as soon as possible.

Disposal



Comply with the relevant environmental protection regulations when disposing of coolant and coolant additives.

Maintenance

Vehicle features and options

This chapter describes all standard, country-specific and optional features offered with the series. It also describes features that are not necessarily available in your vehicle, e. g., due to the selected options or country versions. This also applies to safety-related functions and systems. When using these functions and systems, the applicable laws and regulations must be observed.

BMW maintenance system

The maintenance system indicates required maintenance measures, and thereby provides support in maintaining road safety and the operational reliability of the vehicle.

In some cases, scopes and intervals may vary according to the country-specific version. Replacement work, spare parts, fuels and lubricants, and wear materials are calculated separately. Further information is available from a dealer's service center or another qualified service center or repair shop.

Condition Based Service CBS

Concept

Sensors and special algorithms take into account the driving conditions of the vehicle. CBS uses these to calculate the need for maintenance.

The system makes it possible to adapt the amount of maintenance corresponding to your user profile.

General information

Information on service requirements, refer to page 96, can be displayed on the Control Display.

Service data in the remote control

Information on the required maintenance is continuously stored in the remote control. The dealer's service center can read this data out and suggest a maintenance scope for the vehicle.

Therefore, hand the service advisor the remote control with which the vehicle was driven most recently.

Storage periods

Storage periods during which the vehicle battery was disconnected are not taken into account.

If this occurs, have a dealer's service center or another qualified service center or repair shop update the time-dependent maintenance procedures, such as checking brake fluid and, if necessary, changing the engine oil and the microfilter/activated-charcoal filter.

Service and Warranty Information Booklet for US models and Warranty and Service Guide Booklet for Canadian models

Please consult your Service and Warranty Information Booklet for US models and Warranty and Service Guide Booklet for Canadian models for additional information on service requirements.

The manufacturer of your vehicle recommends that maintenance and repair be performed by a dealer's service center or another qualified

service center or repair shop. Records of regular maintenance and repair work should be retained.

Socket for OBD Onboard Diagnosis

Safety information



NOTE

The socket for Onboard Diagnosis is an intricate component intended to be used in conjunction with specialized equipment to check the vehicle's primary emissions system. Improper use of the socket for Onboard Diagnosis, or contact with the socket for Onboard Diagnosis for other than its intended purpose, can cause vehicle malfunctions and creates risks of personal and property damage. Given the foregoing, the manufacture of your vehicle strongly recommends that access to the socket for Onboard Diagnosis be limited to a dealer's service center or another qualified service center or repair shop or other persons that have the specialized training and equipment for purposes of properly utilizing the socket for Onboard Diagnosis. ◀

Position

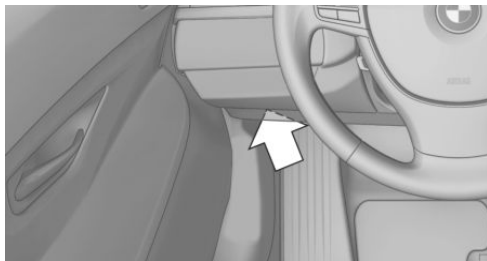

There is an OBD socket on the driver's side for checking the primary components in the vehicle's emissions.

Emissions



- ▶ The warning lamp lights up: Emissions are deteriorating. Have the vehicle checked as soon as possible.
- ▶ The warning lamp flashes under certain circumstances: This indicates that there is excessive misfiring in the engine.

Reduce the vehicle speed and have the system checked immediately; otherwise, serious engine misfiring within a brief period can seriously damage emission control components, in particular the catalytic converter.

Replacing components

Vehicle features and options

This chapter describes all standard, country-specific and optional features offered with the series. It also describes features that are not necessarily available in your vehicle, e. g., due to the selected options or country versions. This also applies to safety-related functions and systems. When using these functions and systems, the applicable laws and regulations must be observed.

Onboard vehicle tool kit

1. Fold up the cargo floor panel.

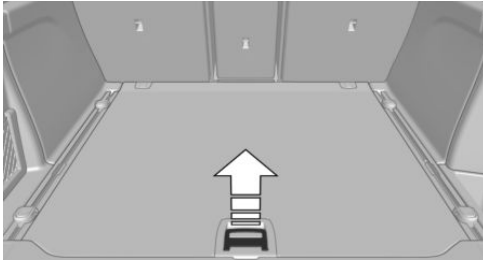

2. Remove the onboard vehicle tool kit.

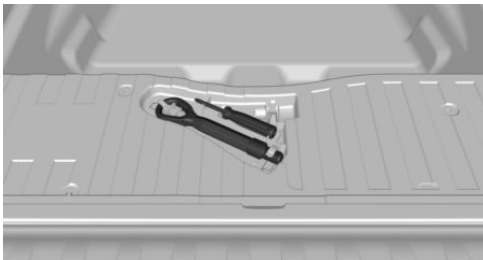

Wiper blade replacement

Safety information



NOTE

If the wiper arm falls onto the windshield without the wiper blades installed, the windshield can be damaged. There is a risk of property damage. Secure the wiper arm when replacing the wiper blades and do not fold down the wipers without the wiper blades installed. ◀



NOTE

Folded-away wipers can be jammed when the hood is opened. There is a risk of property damage. Make sure that the wipers with the wiper blades mounted are folded down onto the windshield before opening the hood. ◀

Front

1. To change the wiper blades, fold up the wiper arms, refer to page 79.
2. Lift the wiper all the way off of the windshield.

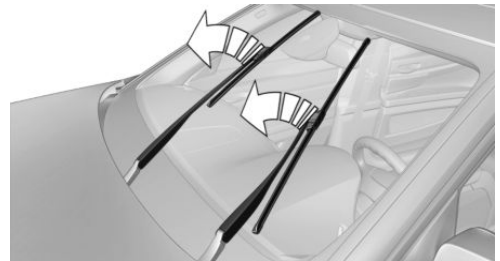

3. Fold open the holder.

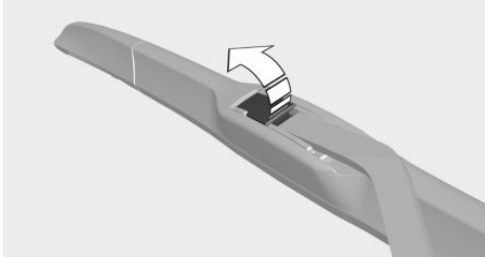

4. Slide wiper blade out of the wiper arm.

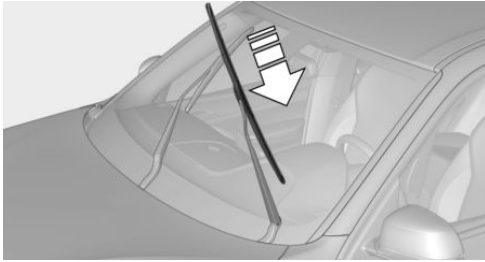

5. Insert the new wiper blade and press it on until you hear it snap into the holder.
6. Fold down the wipers.

Light/bulb replacement

General information

Lights and bulbs

Lights and bulbs make an essential contribution to vehicle safety.

The vehicle manufacturer recommends that you have the relevant work carried out at a dealer's service center or another qualified service center or repair shop.

A spare light box is available from a dealer's service center or another qualified service center or repair shop.

Observe the safety information, refer to page 244.

Light-emitting diodes (LEDs)

Some items of equipment use light-emitting diodes installed behind a cover as a light source. These light-emitting diodes, which are related to conventional lasers, are officially designated as Class 1 light-emitting diodes.

Observe the safety information, refer to page 244.

Safety information

Lights and bulbs



WARNING

Bulbs can get hot during operation. Contact with the bulbs can cause burns. There is a risk of injury. Only change bulbs after they have cooled off. ◀



WARNING

Work on switched-on lighting systems can cause short circuits. There is a risk of injury or risk of property damage. When working on the lighting system, switch off the lamps in question. If necessary, heed the bulb manufacturer's instructions. ◀



NOTE

Dirty bulbs have a reduced service life. There is a risk of property damage. Do not hold new bulbs with your bare hands. Use a clean cloth or something similar, or hold the bulb by its base. ◀

Xenon headlights



DANGER

There can be high voltage in the lighting system. There is danger to life. The manufacturer of your vehicle recommends that the work on the lighting system including bulb replacement be performed by a dealer's service center or another qualified service center or repair shop. ◀

Light-emitting diodes (LEDs)



WARNING

Too intensive brightness can irritate or damage the retina of the eye. There is a risk of injury. Do not look directly into the headlights or other light sources. Do not remove the LED covers. ◀

Headlight glass

Condensation can form on the inside of the external lights in cool or humid weather. When driving with the lights switched on, the condensation evaporates after a short time. The headlight glass does not need to be changed.

If despite driving with the lights switched on, increasing humidity forms, e.g., water droplets in the lamp, the manufacturer of your vehicle recommends having it checked by a dealer's service center or another qualified service center or repair shop.

Headlight setting

The headlight adjustments can be affected by changing lights and bulbs. After the headlight adjustment was changed, have it checked and, if necessary, corrected by a dealer's service center or another qualified service center or repair shop.

Front lights, bulb replacement

Xenon headlights

General information

Because of the long life of these bulbs, the likelihood of failure is very low. Switching the lights on and off frequently shortens their life.

For checking and adjusting headlight aim, contact a dealer's service center or another qualified service center or repair shop.

Safety information



DANGER

There can be high voltage in the lighting system. There is danger to life. The manufacturer of your vehicle recommends that the work on the lighting system including bulb replacement be performed by a dealer's service center or another qualified service center or repair shop. ◀

Overview

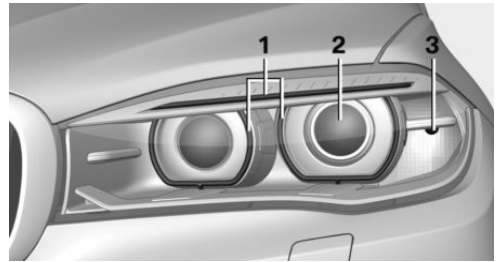

- 1 Parking lights / daytime running lights
- 2 Low beams/high beams/headlight flasher
- 3 Turn signal

Xenon headlights

Low beams and high beams are designed with xenon technology.

The parking lights and daylight running lights are made using LED technology.

In the case of a malfunction, contact a dealer's service center or another qualified service center or repair shop.

LED headlights

With LED headlights, all front lights and side indicators are designed with LED technology.

In the case of a malfunction, contact a dealer's service center or another qualified service center or repair shop.

Turn signal

Safety information

Observe the safety information, refer to page 244.

Replacement

21-watt bulb, PY 21W.

1. Opening the hood, refer to page 233
2. Unscrew the lid counterclockwise and remove it carefully.

The bulb is attached to the lid.

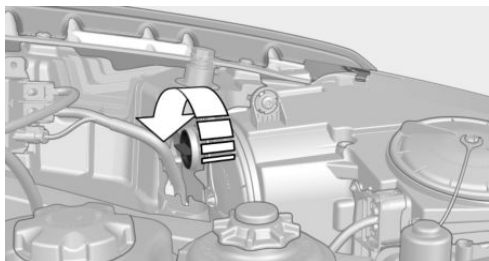

3. Turn the bulb clockwise to remove it.
4. Insert the new bulb and attach the cover in the reverse order.

Turn signal in exterior mirror

The turn signals in the exterior mirrors feature LED technology. In the case of a malfunction, contact a dealer's service center or another qualified service center or repair shop.

Front fog lights/cornering lights

Safety information

Observe the safety information, refer to page 244.

Replacement

55-watt bulb, H11.

1. Insert the screwdriver from the onboard vehicle tool kit, with the flat side on the clip, arrow 1.

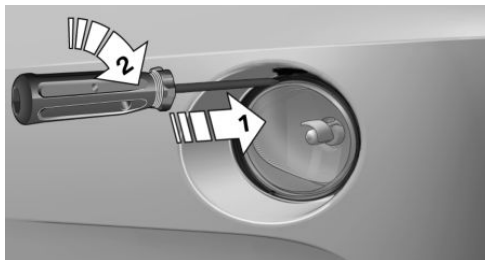

2. Turn the screwdriver by 90°, arrow 2.
3. Remove the front fog lamp toward the front.
4. Detach the connector.

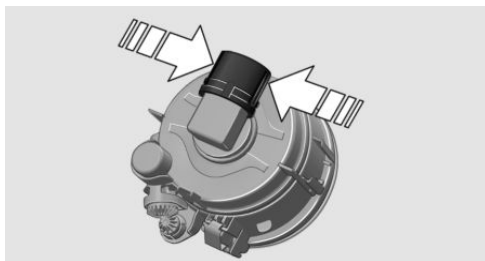

5. Turn the bulb bracket and remove it.

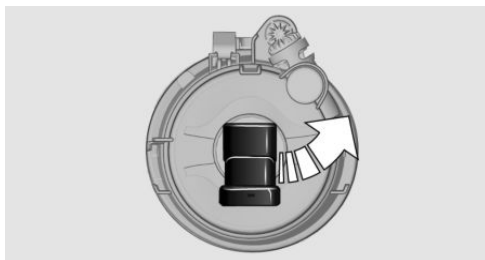

6. Remove the bulb and replace it.
7. Proceed in reverse order to insert the front fog lamp. Note the guide rails in doing so.

LED front fog lights

These front fog lights are made using LED technology. In the case of a malfunction, contact a dealer's service center or another qualified service center or repair shop.

Tail lights, bulb replacement

LED tail lights

These tail lamps are made using LED technology. In the case of a malfunction, contact a dealer's service center or another qualified service center or repair shop.

Vehicle battery

Maintenance

The battery is maintenance-free.

The added amount of acid is sufficient for the service life of the battery.

More information about the battery can be requested from a dealer's service center or another qualified service center or repair shop.

Replacing the vehicle battery

General information

After a battery replacement, the manufacturer of your vehicle recommends that the vehicle battery be registered on the vehicle by a dealer's service center or another qualified service center or repair shop to ensure that all comfort features are fully available and that any Check Control messages of these comfort features are no longer displayed.

Safety information



NOTE

Vehicle batteries that are not compatible can damage vehicle systems and impair vehicle functions. There is a risk of personal and property damage. Only vehicle batteries that are compatible with your vehicle type should

be installed in your vehicle. Information on compatible vehicle batteries is available at your dealer's service center. ◀

Charging the battery

General information

Make sure that the battery is always sufficiently charged to guarantee that the battery remains usable for its full service life.



A discharged battery is indicated by a red indicator light.

The battery may need to be charged in the following cases:

- ▷ When making frequent short-distance drives.
- ▷ If the vehicle is not used for more than a month.

Safety information



NOTE

Battery chargers for the vehicle battery can work with high voltages and currents, which means that the 12 volt on-board network can be overloaded or damaged. There is a risk of property damage. Only connect battery chargers for the vehicle battery to the starting aid terminals in the engine compartment. ◀

Starting aid terminals

In the vehicle, only charge the battery via the starting aid terminals, refer to page 251, in the engine compartment with the engine off.

Power failure

After a power loss, some equipment needs to be newly initialized or individual settings updated, for example:

- ▷ Seat, mirror, and steering wheel memory: store the positions again.
- ▷ Time: update.

- ▷ Date: update.
- ▷ Glass sunroof: initialize the system.

Disposing of old batteries



Have old batteries disposed of by a dealer's service center or another qualified service center or repair shop or take them to a collection point.

Maintain the battery in an upright position for transport and storage. Secure the battery so that it does not tip over during transport.

Fuses

Safety information



WARNING

Incorrect and repaired fuses can overload electrical lines and components. There is a risk of fire. Never attempt to repair a blown fuse. Do not replace a nonworking fuse with a substitute of another color or amperage rating. ◀

Replacing a fuse

The fuses are located in two different places in the vehicle.

Plastic tweezers and information on the fuse types and locations are stored in the fuse box in the cargo area.

In the vehicle's interior

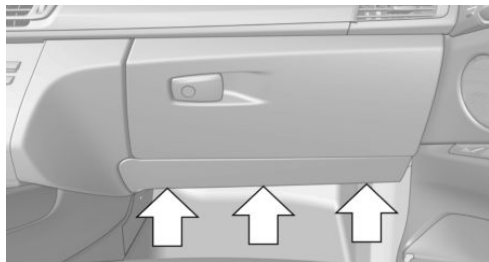

Loosen fasteners, arrows, and open cover.

In the cargo area

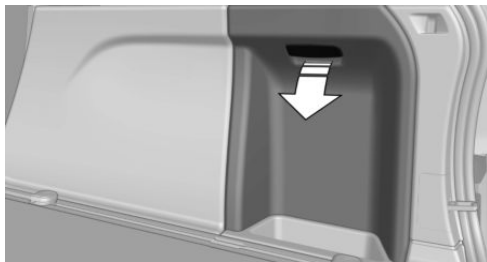

Open the cover on the right side trim, arrow.

The fuse box is located behind the sound insulation.

Information on the fuse types and locations is found on a separate sheet on the bottom of the fuse box.

Breakdown assistance

Vehicle features and options

This chapter describes all standard, country-specific and optional features offered with the series. It also describes features that are not necessarily available in your vehicle, e. g., due to the selected options or country versions. This also applies to safety-related functions and systems. When using these functions and systems, the applicable laws and regulations must be observed.

Hazard warning flashers

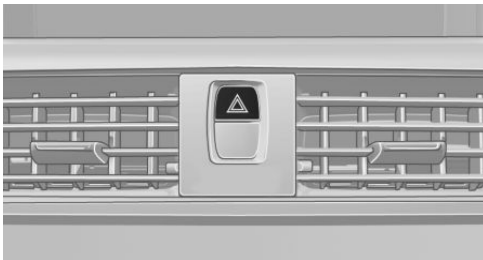

The button is located in the center console. The red light in the button flashes when the hazard warning flashers are activated.

Intelligent emergency call

Concept

In case of an emergency, an Emergency Request can be made through the system.

General information

Only press the SOS button in an emergency. For technical reasons, the Emergency Request cannot be guaranteed under unfavorable conditions.

Overview



SOS button in the roofliner

Functional requirements

- ▷ The SIM card integrated in the vehicle has been activated.
- ▷ The radio-ready state is switched on.
- ▷ The Assist system is functional.

Initiating an Emergency Request automatically

Under certain conditions, such as if the airbags trigger, an Emergency Request is automatically initiated immediately after a severe accident. Automatic Collision Notification is not affected by pressing the SOS button.

Initiating an Emergency Request manually

1. Press the cover briefly to open it.
 2. Press the SOS button until the LED at the button lights up green.
- ▷ The LED flashes green when a connection to the BMW Response Center has been established.

If the LED is flashing green, but the BMW Response Center cannot be heard on the hands-free system, the hands-free system may possibly be malfunctioning. However, the BMW Response Center may still be able to hear you.

When the Emergency Request is received at the BMW Response Center, the BMW Response Center contacts you and takes further steps to help you.

Even if you are unable to respond, the BMW Response Center can take further steps to help you under certain circumstances.

For this, data is transmitted to the BMW Response Center which serves to determine the necessary rescue measures. E.g., the current position of the vehicle, if it can be established.

Roadside Assistance

Service availability

Roadside Assistance can be reached around the clock in many countries. You can obtain assistance there in the event of a vehicle breakdown.

Roadside Assistance

The Roadside Assistance phone number can be viewed via iDrive or a connection to Roadside Assistance can be established directly.

Warning triangle

1. Open the cover on the left side trim.

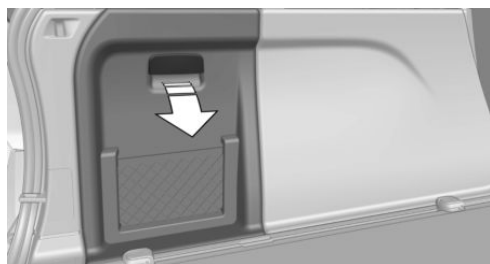

2. Lift the warning triangle slightly and remove in the direction of the interior.

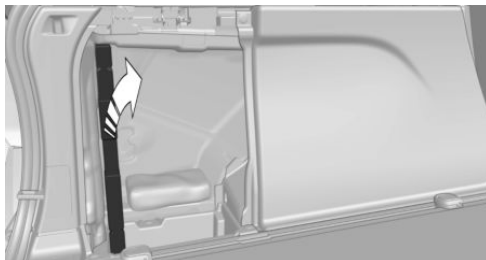

First-aid kit

General information

Some of the articles have a limited service life.

Check the expiration dates of the contents regularly and replace any expired items promptly.

Storage

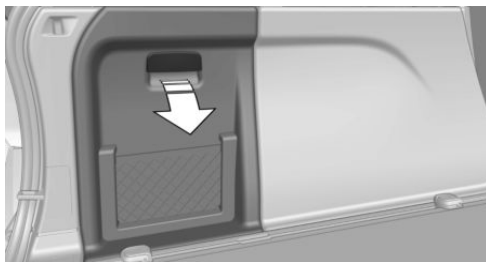

The first-aid kit is located behind the left-hand cover in the cargo area.

To open, pull on the handle.

Jump-starting

General information

If the battery is discharged, the engine can be started using the battery of another vehicle and two jumper cables. Only use jumper cables with fully insulated clamp handles.

Safety information



DANGER

Contact with live components can lead to an electric shock. There is a risk of injuries or danger to life. Do not touch any components that are under voltage. ◀

To prevent personal injury or damage to both vehicles, adhere strictly to the following procedure.

Preparation



NOTE

In the case of body contact between the two vehicles, a short circuit can occur during jump-starting. There is a risk of property damage. Make sure that no body contact occurs. ◀

1. Check whether the battery of the other vehicle has a voltage of 12 volts. The voltage information can be found on the battery.
2. Switch off the engine of the assisting vehicle.
3. Switch off any electronic systems/power consumers in both vehicles.

Starting aid terminals



WARNING

If the jumper cables are connected in the incorrect order, sparking may occur. There is a risk of injury. Pay attention to the correct order during connection. ◀

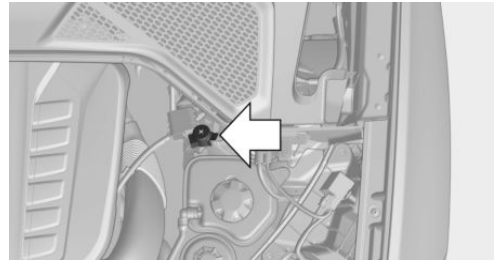

The starting aid terminal in the engine compartment acts as the battery's positive terminal.

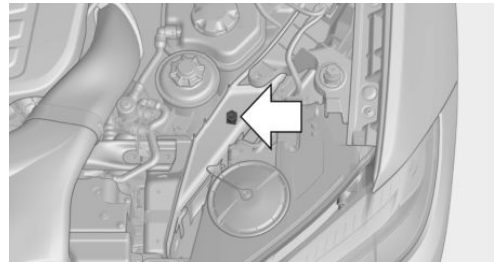

The body ground or a special nut acts as the battery negative terminal.

Connecting the cables

1. Open the cover of the BMW starting aid terminal.
2. Attach one terminal clamp of the positive jumper cable to the positive terminal of the battery, or to the corresponding starting aid terminal of the vehicle providing assistance.
3. Attach the terminal clamp on the other end of the cable to the positive terminal of the battery, or to the corresponding starting aid terminal of the vehicle to be started.
4. Attach one terminal clamp of the negative jumper cable to the negative terminal of the battery, or to the corresponding engine or body ground of assisting vehicle.
5. Attach the second terminal clamp to the negative terminal of the battery, or to the

corresponding engine or body ground of the vehicle to be started.

Starting the engine

Never use spray fluids to start the engine.

1. Start the engine of the assisting vehicle and let it run for several minutes at an increased idle speed.
2. Start the engine of the vehicle that is to be started in the usual way.

If the first starting attempt is not successful, wait a few minutes before making another attempt in order to allow the discharged battery to recharge.

3. Let both engines run for several minutes.
4. Disconnect the jumper cables in the reverse order.

Check the battery and recharge, if needed.

Tow-starting and towing

Safety information

WARNING

Due to system limits, individual functions can malfunction during tow-starting/towing with the Intelligent Safety systems activated, e.g., approach control warning with light braking function. There is a risk of an accident. Switch all Intelligent Safety systems off prior to tow-starting/towing. ◀

Transporting the vehicle

General information

The vehicle is not permitted to be towed.

Safety information

NOTE

The vehicle can be damaged when towing the vehicle with a single lifted axle. There is a risk of property damage. The vehicle should only be transported on a loading platform. ◀

Tow truck

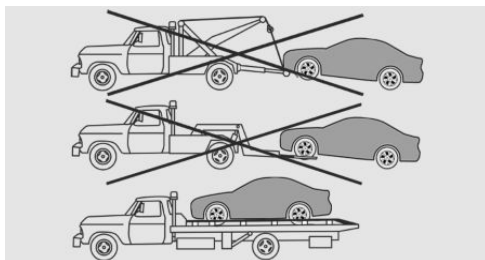

The vehicle should only be transported on a loading platform.

NOTE

When lifting the vehicle by the tow fitting or body and chassis parts; damage can occur on vehicle parts. There is a risk of property damage. Lift vehicle using suitable means. ◀

Pushing the vehicle

To remove a disabled vehicle from the danger area, it can be pushed for a short distance. The vehicle can only be pushed in selector lever position N.

In order to ensure that the vehicle can roll, proceed as follows:

1. Switch on the ignition.
2. Depress brake pedal.
3. Engage selector lever position N.

If there is a malfunction, you may not be able to change the selector lever position.

Electronically unlock the transmission lock, refer to page 84, if needed.

Towing other vehicles

General information

Switch on the hazard warning system, depending on local regulations.

If the electrical system has failed, clearly identify the vehicle being towed by placing a sign or a warning triangle in the rear window.

Safety information

WARNING

If the approved gross vehicle weight of the towing vehicle is lighter than the vehicle to be towed, the tow fitting can tear off or it will not be possible to control the vehicle's response. There is a risk of an accident! Make sure that the gross vehicle weight of the towing vehicle is heavier than the vehicle to be towed. ◀

NOTE

If the tow bar or tow rope is attached incorrectly, damage to other vehicle parts can occur. There is a risk of property damage. Correctly attach the tow bar or tow rope to the tow fitting. ◀

Tow bar

The tow fittings used should be on the same side on both vehicles.

Should it prove impossible to avoid mounting the tow bar at an offset angle, please observe the following:

- ▶ Maneuvering capability is limited going around corners.
- ▶ The tow bar will generate lateral forces if it is secured with an offset.

Tow rope

When starting to tow the vehicle, make sure that the tow rope is taut.

To avoid jerking and the associated stresses on the vehicle components when towing, always use nylon ropes or nylon straps.

Tow fitting

General information

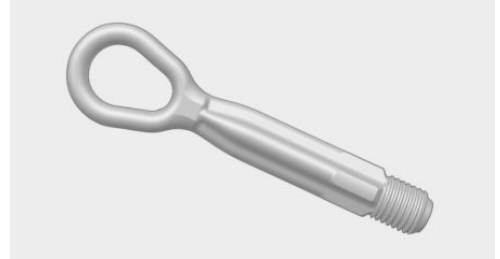

The screw-in tow fitting should always be carried in the vehicle.

The tow fitting can be screwed in at the front or rear of the vehicle.

The tow fitting and the onboard vehicle tool kit, refer to page 243, are together in the cargo area.

Use of the tow fitting:

- ▶ Use only the tow fitting provided with the vehicle and screw it all the way in.
- ▶ Use the tow fitting for towing on paved roads only.
- ▶ Avoid lateral loading of the tow fitting, for instance do not lift the vehicle by the tow fitting.

Safety information

NOTE

If the tow fitting is not used as intended, there can be damage to the vehicle or to the tow fitting. There is a risk of property damage. Observe the notes on using the tow fitting. ◀

Screw thread for tow fitting

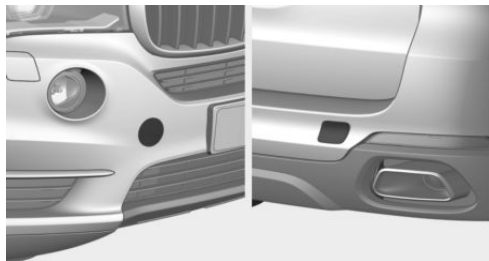

Press on the mark on the edge of the cover to push it out.

Tow-starting

Steptronic transmission

Do not tow-start the vehicle.

Tow-starting the engine is not possible due to the transmission.

Have the reasons for the starting difficulties corrected by a dealer's service center or another qualified service center or repair shop.

Care

Vehicle features and options

This chapter describes all standard, country-specific and optional features offered with the series. It also describes features that are not necessarily available in your vehicle, e. g., due to the selected options or country versions. This also applies to safety-related functions and systems. When using these functions and systems, the applicable laws and regulations must be observed.

Vehicle washes

General information

Regularly remove foreign objects such as leaves in the area below the windshield when the hood is raised.

Wash your vehicle frequently, particularly in winter. Intense soiling and road salt can damage the vehicle.

Steam blaster and high-pressure washer

Safety information



NOTE

When cleaning with high-pressure washers, components can be damaged due to the pressure or temperatures being too high. There is a risk of property damage. Maintain sufficient distance and do not spray too long continuously. Follow the operating instructions for the high-pressure washer. ◀

Distances and temperature

- ▶ Maximum temperature: 140 °F/60 °C.
- ▶ Minimum distance from sensors, cameras, seals: 12 inches/30 cm.

- ▶ Minimum distance from glass sunroof: 31.5 in/80 cm.

Automatic vehicle washes

Safety information



NOTE

Improper use of automatic vehicle washes can cause damage to the vehicle. There is a risk of damage to property. Follow the following instructions:

- ▶ Give preference to cloth vehicle washes or those that use soft brushes in order to avoid paint damage.
- ▶ Before driving into the vehicle wash, make sure that the vehicle is not too large.
- ▶ Avoid vehicle washes with guide rails higher than 4 in/10 cm to avoid damage to the chassis.
- ▶ Observe the tire width of the guide rail to avoid damage to tires and rims.
- ▶ Fold in exterior mirrors to avoid damage to the exterior mirrors.
- ▶ Deactivate the wiper and, if necessary, rain sensor to avoid damage to the wiper system. ◀

Before driving into a vehicle wash

In order to ensure that the vehicle can roll in a vehicle wash, take the following steps:

1. Drive into the vehicle wash.
2. Engage selector lever position N.
3. Deactivate Automatic Hold, refer to page 75.
4. Release the parking brake.
5. Switch the engine off.

In this way, the ignition remains switched on, and a Check-Control message is displayed.



NOTE

Selector lever position P is automatically engaged when the ignition is switched off. There is a risk of property damage. Do not switch drive-ready state off in vehicle washes. ◀

Some vehicle washes do not permit persons in the vehicle. The vehicle cannot be locked from the outside when in selector lever position N. A signal sounds when an attempt is made to lock the vehicle.

Driving out of a vehicle wash

To start the engine:

1. Ensure that the vehicle key is in the car.
2. Depress the brake pedal.
3. Press the Start/Stop button.

Pressing the Start/Stop button without stepping on the brake turns the ignition off.

Selector lever position

Selector lever position P is engaged automatically:

- ▷ When the ignition is switched off.
- ▷ After approx. 15 minutes.

Headlights

Do not rub the headlights dry and do not use abrasive or acidic cleaning agents.

Soak areas that have been dirtied, for instance from insects, with shampoo and wash off with water.

Thaw ice with de-icing spray; do not use an ice scraper.

After washing the vehicle

After washing the vehicle, apply the brakes briefly to dry them; otherwise, braking action can be reduced. The heat generated during braking dries brake discs and brake pads and protects them against corrosion.

Completely remove all residues on the windows, to minimize loss of visibility due to smearing and to reduce wiper noises and wiper blade wear.

Vehicle care

Vehicle care products

General information

BMW recommends using vehicle care and cleaning products from BMW. Suitable care products are available from a dealer's service center or another qualified service center or repair shop.

Safety information



WARNING

Cleaners can contain substances that are dangerous and harmful to your health. There is a risk of injury. When cleaning the interior, open the doors or windows. Only use products intended for cleaning vehicles. Follow the instructions on the container. ◀

Vehicle paint

General information

Regular care contributes to driving safety and value retention. Environmental influences in areas with elevated air pollution or natural contaminants, such as tree resin or pollen can affect the vehicle's paintwork. Tailor the frequency and extent of your vehicle care to these influences.

Aggressive substances such as spilled fuel, oil, grease or bird droppings, must be removed immediately to prevent the finish from being altered or discolored.

Leather care

Remove dust from the leather regularly, using a cloth or vacuum cleaner.

Otherwise, particles of dust and road grime chafe in pores and folds, and lead to increased wear and premature degradation of the leather surface.

To guard against discoloration, such as from clothing, clean leather and provide leather care roughly every two months.

Clean light-colored leather more frequently because soiling on such surfaces is substantially more visible.

Use leather care products; otherwise, dirt and grease will gradually break down the protective layer of the leather surface.

Upholstery material care

General information

Vacuum the upholstery regularly with a vacuum cleaner.

If upholstery is very dirty, for instance with beverage stains, use a soft sponge or microfiber cloth with a suitable interior cleaner.

Clean the upholstery down to the seams using large sweeping motions. Avoid rubbing the material vigorously.

Safety information



NOTE

Open Velcro® fasteners on articles of clothing can damage the seat covers. There is a risk of property damage. Ensure that any Velcro® fasteners are closed. ◀

Caring for special components

Light-alloy wheels

When cleaning the vehicle, use only neutral wheel cleaners having a pH value from 5 to 9. Do not use abrasive cleaning agents or steam jets above 140 °F/60 °C. Follow the manufacturer's instructions.

Aggressive, acidic or alkaline cleaning agents can destroy the protective layer of adjacent components, such as the brake disk.

After cleaning, apply the brakes briefly to dry them. The heat generated during braking dries brake discs and brake pads and protects them against corrosion.

Chrome surfaces

Carefully clean components such as the radiator grille or door handles with an ample supply of water, possibly with shampoo added, particularly when they have been exposed to road salt.

Rubber components

Environmental influences can cause surface soiling of rubber parts and a loss of gloss. Use only water and suitable cleaning agents for cleaning.

Treat especially worn rubber parts with rubber care agents at regular intervals. When cleaning rubber seals, do not use any silicon-containing vehicle care products in order to avoid damage or noises.

Fine wood parts

Clean fine wood facing and fine wood components only with a moist rag. Then dry with a soft cloth.

Plastic components



NOTE

Cleansers that contain alcohol or solvents, such as lacquer thinners, heavy-duty grease removers, fuel, or such, can damage plastic parts. There is a risk of property damage. Clean with a microfiber cloth. Dampen cloth lightly with water. ◀

Plastic components are e.g.:

- ▷ Imitation leather surfaces.
- ▷ Roofliner.
- ▷ Lamp lenses.

- ▷ Instrument cluster cover.
- ▷ Matt black spray-coated components.
- ▷ Painted parts in the interior.

Clean with a microfiber cloth.

Dampen cloth lightly with water.

Do not soak the roofliner.

Safety belts

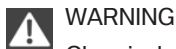

WARNING

Chemical cleansers can destroy the safety belt webbing. Missing protective effect of the safety belts. There is a risk of injuries or danger to life. Use only a mild soapy solution for cleaning the safety belts. ◀

Dirty belt straps impede the reeling action and thus have a negative impact on safety.

Use only a mild soapy solution, with the safety belts clipped into their buckles.

Do not allow the switches to retract the safety belts until they are dry.

Carpets and floor mats

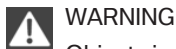

WARNING

Objects in the driver's floor area can limit the pedal distance or block a depressed pedal. There is a risk of an accident. Stow objects in the vehicle such that they are secured and cannot enter into the driver's floor area. Use floor mats that are suitable for the vehicle and can be safely attached to the floor. Do not use loose floor mats and do not layer several floor mats. Make sure that there is sufficient clearance for the pedals. Ensure that the floor mats are securely fastened again after they were removed, e.g., for cleaning. ◀

Floor mats can be removed from the vehicle's interior for cleaning.

If the floor carpets are very dirty, clean with a microfiber cloth and water or a textile cleaner. To prevent matting of the carpet, rub back and forth in the direction of travel only.

Sensor/camera lenses

To clean sensors and camera lenses, use a cloth moistened with a small amount of glass detergent.

Displays/Screens/protective glass of the Head-up Display



NOTE

Chemical cleansers, moisture or fluids of any kind can damage the surface of displays and screens. There is a risk of property damage. Clean with a clean, antistatic microfiber cloth. ◀



NOTE

The surface of displays can be damaged with improper cleaning. There is a risk of property damage. Avoid pressure that is too high and do not use any scratching materials. ◀

Clean with a clean, antistatic microfiber cloth.

Clean the protective glass of the Head-up Display using a microfiber cloth and commercially available dish-washing soap.

Long-term vehicle storage

When the vehicle is shut down for longer than three months, special measures must be taken. Further information is available from a dealer's service center or another qualified service center or repair shop.



Reference

This chapter contains the technical data and an index that will quickly take you to the information you need.

Technical data

Vehicle features and options

This chapter describes all standard, country-specific and optional features offered with the series. It also describes features that are not necessarily available in your vehicle, e. g., due

to the selected options or country versions. This also applies to safety-related functions and systems. When using these functions and systems, the applicable laws and regulations must be observed.

General information

The technical data and specifications in this Owner's Manual are used as guidance values. The vehicle-specific data can deviate from this, e.g., due to the selected special equipment, country version or country-specific measurement method. Detailed values can be found in the approval documents, on labels on the vehi-

cle or can be obtained from a dealer's service center or another qualified service center or repair shop.

The information in the vehicle documents always has priority over the information in this Owner's Manual.

Dimensions

The dimensions can vary depending on the model version, equipment or country-specific measurement method.

The specified heights do not take into account attached parts, e.g., a roof antenna, roof racks

or spoiler. The heights can deviate, e.g., due to the selected special equipment, tires, load and chassis version.

BMW X6

Width with mirrors	inches/mm	85.4/2,170
Width without mirrors	inches/mm	78.3/1,989
Height	inches/mm	67/1,702
Length	inches/mm	193.8/4,923
Wheelbase	inches/mm	115.5/2,933
Smallest turning radius diam.	ft/m	42.0/12.8

Weights

X6 sDrive35i		
Approved gross vehicle weight	lbs/kg	6,010/2,726
Load	lbs/kg	1,110/503
Approved front axle load	lbs/kg	2,730/1,238
Approved rear axle load	lbs/kg	3,380/1,533
Approved roof load capacity	lbs/kg	220/100
Cargo area capacity	cu ft	26.6-59.7
Canada: cargo area capacity	cu ft/l	20.4-53.8/580-1,525
X6 xDrive35i		
Approved gross vehicle weight	lbs/kg	6,030/2,735
Load	lbs/kg	1,110/503
Approved front axle load	lbs/kg	2,750/1,247
Approved rear axle load	lbs/kg	3,420/1,551
Approved roof load capacity	lbs/kg	220/100
Cargo area capacity	cu ft	26.6-59.7
Canada: cargo area capacity	cu ft/l	20.4-53.8/580-1,525
X6 xDrive50i		
Approved gross vehicle weight	lbs/kg	6,430/2,917
Load	lbs/kg	1,110/503
Approved front axle load	lbs/kg	2,980/1,352
Approved rear axle load	lbs/kg	3,520/1,597
Approved roof load capacity	lbs/kg	220/100
Cargo area capacity	cu ft	26.6-59.7
Canada: cargo area capacity	cu ft/l	20.4-53.8/580-1,525

Capacities

	US gal/liters	Notes
Fuel tank, approx.	22.4/85.0	Fuel quality, refer to page 214

Appendix

Any updates to the Owner's Manual of the vehicle are listed here.

Updates made after the editorial deadline

These chapters of the printed Owner's Manual contain updates made after the editorial deadline.

- ▷ Overview: General settings: Data protection.
- ▷ Wheels and tires: Wheel change: Safety information, refer to page 227, .

License Texts and Certifications

The following applies in addition to the radio transmission license texts of the Integrated Owner's Manual in the vehicle.

Remote Control

Argentine Republic

CNC Aprobado No.: H-12092

Brazil



(01) 7898949603 610

Este equipamento opera em caráter secundário, isto é, não tem direito a proteção contra interferência prejudicial, mesmo de estações

do mesmo tipo, e não pode causar interferência a sistemas operando em caráter primário.

Canada

Le présent appareil est conforme aux CNR d'Industrie Canada applicables aux appareils radio exempts de licence. L'exploitation est autorisée aux deux conditions suivantes :

- (1) l'appareil ne doit pas produire de brouillage, et
- (2) l'utilisateur de l'appareil doit accepter tout brouillage radioélectrique subi, même si le brouillage est susceptible d'en compromettre le fonctionnement.

FCC § 15.19 Labelling requirements

This device complies with Part 15 of the FCC Rules and with Industry Canada licence-exempt RSS. Operation is subject to the following two conditions:

- (1) This device may not cause harmful interference, and
- (2) this device must accept any interference received, including interference that may cause undesired operation.

FCC § 15.21 Information to user

Changes or modifications not expressly approved by the party responsible for compliance could void the user's authority to operate the equipment.

Indonesia

29311/SDPPI/2013

2181

Japan



201-135124

Mexico

COFETEL: RLVBHEID13-0912

Marca: Hella

Modelo (s): IDGNG1

La operación de este equipo está sujeta a las siguientes dos condiciones:

- (1) es posible que este equipo o dispositivo no cause interferencia perjudicial y
- (2) este equipo o dispositivo debe aceptar cualquier interferencia, incluyendo la que pueda causar su operación no deseada.

Oman

OMAN TRA

TRA/TA-R/1037/13

D090258

Philippines



NTC

Type Approved

No.: ESD-1307076C

Singapore

Complies with

IDA Standards

DA101586

South Africa



TA-2013/004

APPROVED

Taiwan

本產品符合低功率電波輻射性電機管理辦法 第十二條、第十四條等條文規定

1. 經型式認證合格之低功率射頻電機，非經許可，公司、商號或使用者均不得擅自變更頻率、加大功率或變更原設計之特性及功能。

2. 低功率射頻電機之使用不得影響飛航安全及干擾合法通信；經發現有干擾現象時，應立即停用，並改善至無干擾時方得繼續使用。

前項合法通信，指依電信法規定作業之無線電通信。

低功率射頻電機須忍受合法通信或工業、科學及醫療用電波輻射性電機設備之干擾。

UAE

TRA REGISTERED No: ER0107463/13

DEALER No: DA0053436/10

USA

FCC § 15.19 Labelling requirements

This device complies with Part 15 of the FCC Rules and with Industry Canada licence-exempt RSS. Operation is subject to the following two conditions:

- (1) This device may not cause harmful interference, and
- (2) this device must accept any interference received, including interference that may cause undesired operation.

FCC § 15.21 Information to user

Changes or modifications not expressly approved by the party responsible for compliance could void the user's authority to operate the equipment.

Wireless Charging

Canada

FCC/INDUSTRY CANADA NOTICE

This device complies with part 15 of the FCC rules and with Industry Canada license-exempt RSS standard(s).

Operation is subject to the following two conditions:

1. This device may not cause harmful interference, and
2. this device must accept any interference received, including interference that may cause undesired operation.

FCC ID: RK7184-00

IC: 4774A-18400

Any changes or modifications not expressly approved by Novero could void the user's authority to operate this equipment.

This device complies with RF exposure guidelines of the FCC rules and with Industry Canada license-exempt RSS standard(s) at a distance of 2 in/5 cm under normal use case conditions.

NOTE: This device has been tested for human exposure limits and found compliant at a minimum distance of 4 in/10 cm during operation.

FCC/Notice d'industrie du Canada

Cet équipement est considéré comme conforme aux conditions de la section 15 de la réglementation de la FCC. Il répond aux deux conditions suivantes:

1. Ce dispositif ne causera aucune interférence nuisible;
2. Ce dispositif peut accepter toute interférence reçue, notamment l'interférence entraînant un fonctionnement indésirable.

FCC ID: RK7184-00

IC: 4774A-18400

Les changements ou modifications non approuvés expressément par novero peuvent entraîner la caducité de l'autorisation d'utiliser l'équipement.

Europe



European Union: Declaration of Conformity

Hereby, Novero Dabendorf GmbH declares that the radio equipment type WCH-184 is in compliance with Directive 2014/53/EU. The full text of the EU declaration of conformity is available at the following internet address:

http://www.novero.com/declaration_of_conformity

Technical information:

Frequency Band: 111kHz

Maximum Magnetic Field Strength: 42dBµA/m

Manufacturer: Novero Dabendorf GmbH

Address: Märkische Strasse 72, 15806 Zossen, Germany

Phone: + 49 3377 316-0

Instructions and Safety information (to be defined for the Wireless Charger)

Manufacturers shall ensure that the radio equipment is accompanied by instructions and safety information in a language which can be easily understood by consumers and other end-users, as determined by the Member State concerned.

Instructions shall include the information required to use radio equipment in accordance with its intended use.

Such information shall include, where applicable, a description of accessories and components, including software, which allow the radio equipment to operate as intended.

Such instructions and safety information, as well as any labelling, shall be clear, understandable and intelligible.

Bulgarian

С настоящото [име на производителя] декларира, че този тип радиосъоръжение [обозначение на типа радиосъоръжение] е в съответствие с Директива 2014/53/ЕС. Цялостният текст на ЕС декларацията за съответствие може да се намери на следния интернет адрес: http://www.novero.com/declaration_of_conformity

Čeština

Tímto [jméno výrobce] prohlašuje, že typ rádiového zařízení [označení typu rádiového zařízení] je v souladu se směrnicí 2014/53/EU. Úplné znění EU prohlášení o shodě je k dispozici na této internetové adrese: http://www.novero.com/declaration_of_conformity

Dansk

Hermed erklærer [fabrikantens navn], at radioudstyrstypen [betegnelse for typen af radioudstyr] er i overensstemmelse med direktiv 2014/53/EU. EU-overensstemmelseserklæringens

fulde tekst kan findes på følgende internetadresse: http://www.novero.com/declaration_of_conformity

Deutsch

Hiermit erklärt Novero Dabendorf GmbH, dass der Funkanlagentyp WCH-184 der Richtlinie 2014/53/EU entspricht. Der vollständige Text der EU-Konformitätserklärung ist unter der folgenden Internetadresse verfügbar: http://www.novero.com/declaration_of_conformity

Eesti

Käesolevaga deklareerib [tootja nimi], et käesolev raadioseadme tüüp [raadioseadme tüübi nimetus] vastab direktiivi 2014/53/EL nõuetele. ELi vastavusdeklaratsiooni täielik tekst on kättesaadav järgmisel internetiaadressil: http://www.novero.com/declaration_of_conformity

English

Hereby, Novero Dabendorf GmbH declares that the radio equipment type WCH-184 is in compliance with Directive 2014/53/EU. The full text of the EU declaration of conformity is available at the following internet address: http://www.novero.com/declaration_of_conformity

Español

Por la presente, [nombre del fabricante] declara que el tipo de equipo radioeléctrico designación del tipo de equipo radioeléctrico] es conforme con la Directiva 2014/53/UE. El texto completo de la declaración UE de conformidad está disponible en la dirección Internet siguiente: http://www.novero.com/declaration_of_conformity

Ελληνικά

Με την παρούσα ο/η [επωνυμία του κατασκευαστή], δηλώνει ότι ο ραδιοεξοπλισμός [ονομασία του τύπου ραδιοεξοπλισμού] πληροί την οδηγία 2014/53/ΕΕ. Το πλήρες κείμενο της δήλωσης

συμμόρφωσης ΕΕ διατίθεται στην ακόλουθη ιστοσελίδα στο διαδίκτυο: http://www.novero.com/declaration_of_conformity

Français

Le soussigné, [nom du fabricant], déclare que l'équipement radioélectrique du type [désignation du type] est conforme à la directive 2014/53/UE. Le texte complet de la déclaration UE de conformité est disponible à l'adresse internet suivante: http://www.novero.com/declaration_of_conformity

Hrvatski

Ime proizvođača] ovime izjavljuje da je radijska oprema tipa [oznaka tipa radijske opreme] u skladu s Direktivom 2014/53/EU. Cjeloviti tekst EU izjave o sukladnosti dostupan je na sljedećoj internetskoj adresi: http://www.novero.com/declaration_of_conformity

Italiano

Il fabbricante, [nome del fabbricante], dichiara che il tipo di apparecchiatura radio [designazione del tipo di apparecchiatura radio] è conforme alla direttiva 2014/53/UE. Il testo completo della dichiarazione di conformità UE è disponibile al seguente indirizzo Internet: http://www.novero.com/declaration_of_conformity

Latviešu

Ar šo [ražotāja nosaukums] deklarē, ka radioiekārta [radioiekārtas tipa apzīmējums] atbilst Direktīvai 2014/53/ES. Pilns ES atbilstības deklarācijas teksts ir pieejams šādā interneta vietnē: http://www.novero.com/declaration_of_conformity

Lietuvių

Aš, [gamintojo vardas, pavardė/pavadinimas], patvirtinu, kad radijo įrenginių tipas [radijo įrenginių tipo pavadinimas] atitinka Direktyvą 2014/53/ES. Visas ES atitikties deklaracijos tekstas prieinamas šiuo interneto adresu:

http://www.novero.com/declaration_of_conformity

Magyar

A gyártó neve] igazolja, hogy a [a rádióberendezés típusa] típusú rádióberendezés megfelel a 2014/53/EU irányelvnek. Az EU-megfelelőségi nyilatkozat teljes szövege elérhető a következő internetes címen: http://www.novero.com/declaration_of_conformity

Malti

B'dan, [Isem il-manifattur], niddikjara li dan it-tip ta' tagħmir tar-radju [deskrizzjoni tat-tip ta' tagħmir ta' radju] huwa konformi mad-Direttiva 2014/53/UE. It-test kollu tad-dikjarazzjoni ta' konformità tal-UE huwa disponibbli f'dan l-in-dirizz tal-Internet li ġej: http://www.novero.com/declaration_of_conformity

Nederlands

Hierbij verklaar ik, [naam van de fabrikant], dat het type radioapparatuur [aanduiding van het type radioapparatuur] conform is met Richtlijn 2014/53/EU. De volledige tekst van de EU-conformiteitsverklaring kan worden geraadpleegd op het volgende internetadres: http://www.novero.com/declaration_of_conformity

Polski

Nazwa producenta] niniejszym oświadcza, że typ urządzenia radiowego [określenie typu urządzenia radiowego] jest zgodny z dyrektywą 2014/53/UE. Pełny tekst deklaracji zgodności UE jest dostępny pod następującym adresem internetowym: http://www.novero.com/declaration_of_conformity

Português

O(a) abaixo assinado(a) [nome do fabricante] declara que o presente tipo de equipamento de rádio [designação do tipo de equipamento de rádio] está em conformidade com a Diretiva 2014/53/UE. O texto integral da declaração de conformidade está disponível no seguinte en-

dereço de Internet: http://www.novero.com/declaration_of_conformity

Slovensko

Ime proizvajalca] potrjuje, da je tip radijske opreme [označba tipa radijske opreme] skladen z irektivo 2014/53/EU. Celotno besedilo izjave EU o skladnosti je na voljo na naslednjem spletnem naslovu: http://www.novero.com/declaration_of_conformity

Slovensky

Meno výrobcu] týmto vyhlasuje, že rádiové zariadenie typu [označenie typu rádiového zariadenia] je v súlade so smernicou 2014/53/EÚ. Úplné EÚ vyhlásenie o zhode je k dispozícii na tejto internetovej adrese: http://www.novero.com/declaration_of_conformity

Suomi

Valmistajan nimi] vakuuttaa, että radiolaitetyyppi [radiolaitteen tyyppimerkintä] on direktiivin 2014/53/EU mukainen. EU-vaatimusten mukaisuusvakuutuksen täysimittainen teksti on saatavilla seuraavassa internetosoitteessa: http://www.novero.com/declaration_of_conformity

Svenska

Härmed försäkrar [tillverkarens namn] att denna typ av radioutrustning [ange typ av radioutrustning] överensstämmer med direktiv 2014/53/EU. Den fullständiga texten till EU-försäkran om verensstämelse finns på följande webbadress: http://www.novero.com/declaration_of_conformity

Serbia

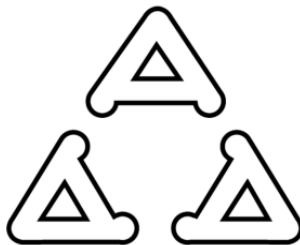

I005 16

South Africa



TA-2016/1263

APPROVED

South Korea



MSIP-CMM-N7V-WCH-184

인증 받은 자의 상호 Novero Dabendorf GmbH
제조사/제조국가 Germany

기자재의 명칭/ 모델명 WCH-184

기자재의 명칭/ 모델명 MSIP-CMM-N7V-WCH-184

USA

FCC/INDUSTRY CANADA NOTICE

This device complies with part 15 of the FCC rules and with Industry Canada license-exempt RSS standard(s).

Operation is subject to the following two conditions:

1. This device may not cause harmful interference, and
2. this device must accept all interference received, including interference that may cause undesired operation.

FCC ID: RK7184-00

IC: 4774A-18400

Any changes or modifications not expressly approved by Novero could void the user's authority to operate this equipment.

This device complies with RF exposure guidelines of the FCC rules and with Industry Canada license-exempt RSS standard(s) at a distance of 2 in/5 cm under normal use case conditions.

NOTE: This device has been tested for human exposure limits and found compliant at a minimum distance of 4 in/10 cm during operation.

Note

This device has been tested for human exposure limits and found compliant at a minimum distance of 4 in/10 cm during operation.

Therefore, a distance of 4 in/10 cm must be maintained in every direction when operating the device.

Wireless charging tray

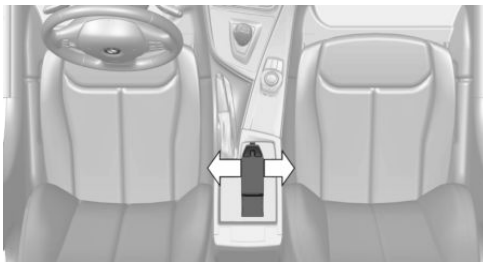

Mounting position of the product.

Everything from A to Z

Index

A

- ABS, Antilock Brake System 141
- ACC, Active Cruise Control with Stop&Go function 149
- Acceleration Assistant, see Launch Control 84
- Accessories and parts 8
- Activated-charcoal filter 176
- Active Blind Spot Detection 136
- Active Cruise Control with Stop&Go function, ACC 149
- Active Guard, see Intelligent Safety 120
- Active Protection 138
- Active roll stabilization 145
- Active seat ventilation, front 56
- Adaptive brake assistant 141
- Adaptive brake lights, see Brake force display 138
- Adaptive Light Control 108
- Additives, oil 237
- After washing vehicle 256
- Airbags 111
- Airbags, indicator/warning light 112
- Air circulation, see Recirculated-air mode 174
- Air, dehumidifying, see Cooling function 173
- Air distribution, manual 175
- Air flow, automatic climate control 174
- Air outlets, see Ventilation 176
- Air pressure, tires 216
- Alarm system 47
- Alarm, unintentional 48
- All around the center console 16
- All-season tires, see Winter tires 223
- All-wheel-drive 143
- Alternative oil types 237
- Ambient light 110
- Animal detection, see Night Vision 130
- Antifreeze, washer fluid 80
- Antilock Brake System, ABS 141
- Anti-slip control, see DSC 142
- App, BMW Driver's Guide 6
- Approach control warning with City light braking function 122
- Approved axle load 263
- Arrival time 100
- Ashtray 182
- Assistance, Roadside Assistance 250
- Assistance when driving off 141
- Attentiveness assistant 138
- AUTO H button 74
- AUTO H button, see Automatic Hold 74
- AUTO intensity 174
- Automatic climate control 172
- Automatic cruise control with Stop&Go function 149
- Automatic Curb Monitor 61
- Automatic deactivation, Front-seat passenger airbags 113
- Automatic headlight control 107
- Automatic Hold 74
- Automatic locking 46
- Automatic recirculated-air control 174
- Automatic tailgate 42
- Automatic transmission, see Steptronic transmission 80
- Automatic vehicle wash 255
- AUTO program, automatic climate control 174
- AUTO program, intensity 174
- Auto Start/Stop function 71
- Auto washing 255
- AUX-IN port, general information 184
- Average fuel consumption 100
- Average speed 100
- Axle loads, weights 263

B

- Backrest curvature, see Lumbar support 54
- Backrest, seats 53
- Backrest, width 55
- Bad road trips 199
- Band-aids, see First-aid kit 250
- Battery replacement, vehicle battery 247
- Battery replacement, vehicle remote control 36
- Battery, vehicle 247
- Being towed, see Tow-starting and towing 252
- Belts, safety belts 57
- Beverage holder, cup holder 191
- Blinds, sun protection 50
- Blocking, power window 50

- BMW Assist, see Owner's Manual for Navigation, Entertainment and Communication
- BMW Driver's Guide app 6
- BMW Homepage 6
- BMW Internet page 6
- BMW maintenance system 241
- Bonus range, ECO PRO 205
- Bottle holder, see Cup holder 191
- Brake assistant 141
- Brake assistant, adaptive 141
- Brake discs, break-in 196
- Brake force display 138
- Brake lights, adaptive 138
- Brake lights, brake force display 138
- Brake pads, break-in 196
- Braking, information 198
- Breakdown assistance 249, 250
- Break-in 196
- Brightness of Control Display 103
- Bulb replacement 244
- Bulb replacement, front 245
- Bulb replacement, rear 247
- Bulbs and lights 244
- Button, RES 152
- Button, Start/Stop 69
- Bypassing, see Jump-starting 250
- C**
- California Proposition 65 Warning 8
- Calling up mirror adjustment 47
- Calling up seat adjustment 47
- Calling up steering wheel adjustment 47
- Camera-based assistance systems, see Intelligent Safety 120
- Camera lenses, care 258
- Camera, rearview camera 161
- Camera, Side View 166
- Camera, Top View 164
- Can holder, see Cup holder 191
- Care, displays 258
- Care, vehicle 256
- Care, washing the vehicle 255
- Cargo 200
- Cargo area 185
- Cargo area, enlarging 186
- Cargo area, loading 201
- Cargo area, storage compartments 192
- Cargo cover 185
- Cargo, stowing and securing 201
- Cargo straps 201
- Carpet, care 258
- Catalytic converter, see Hot exhaust system 197
- CBS Condition Based Service 241
- CD/multimedia, see Owner's Manual for Navigation, Entertainment and Communication
- Center armrest 189
- Center console 16
- Central locking system 38
- Central screen, see Control Display 18
- Changes, technical, see For Your Own Safety 7
- Changing parts 243
- Changing wheels 227
- Changing wheels/tires 222
- Chassis number, see Vehicle identification number 10
- Check Control 90
- Checking the engine oil level electronically 235
- Checking the oil level electronically 235
- Children, seating position 64
- Children, transporting safely 64
- Child restraint fixing system LATCH 66
- Child restraint system 64
- Child restraint systems, mounting 65
- Child safety locks 68
- Child seat, mounting 65
- Child seats 64
- Chrome parts, care 257
- CID (central information display), refer to On-Board computer 99
- Cigarette lighter 183
- City light braking function warning with braking function 124
- Cleaning, displays 258
- Climate control 172
- Climate control windshield 197
- Closing the tailgate with no-touch activation 40
- Clothes hooks 192
- Coasting 207
- Coasting with engine decoupled, coasting 207
- Coasting with idling engine 207
- Cockpit 14
- Combination switch, see Turn signals 76
- Combination switch, see Wiper system 77
- Comfort Access 38
- COMFORT program, Driving Dynamics Control 147
- Compact wheel, see Emergency wheel 230

- Compartments in the doors [189](#)
- Compass [101](#)
- Compressor [224](#)
- Condensation on windows [175](#)
- Condensation under the vehicle [198](#)
- Condition Based Service CBS [241](#)
- Confirmation signal [46](#)
- ConnectedDrive, see Owner's Manual for Navigation, Entertainment and Communication
- ConnectedDrive Services
- Container for washer fluid [80](#)
- Continued driving with a flat tire [117](#), [120](#)
- Control Display [18](#)
- Control Display, settings [102](#)
- Controller [19](#)
- Control systems, driving stability [141](#)
- Convenient opening with the remote control [35](#)
- Coolant [239](#)
- Coolant level [239](#)
- Coolant temperature [94](#)
- Cooling function [173](#)
- Cooling, maximum [173](#)
- Cooling system [239](#)
- Cornering light [108](#)
- Corrosion on brake discs [198](#)
- Cosmetic mirror [182](#)
- Courtesy lamps with the vehicle locked [35](#)
- Courtesy lights during unlocking [35](#)
- Cruise control [155](#)
- Cruise control, active with Stop&Go function [149](#)
- Cruise control with distance control, see active cruise control, ACC [149](#)
- Cruise control without distance control, see cruise control [155](#)
- Cruising range [95](#)
- Cup holder [191](#)
- Current fuel consumption [96](#)
- ## D
- Damage, tires [221](#)
- Data, technical [262](#)
- Date [102](#)
- Date display [95](#)
- Daytime running lights [108](#)
- Defrosting, see Windows, defrosting [175](#)
- Dehumidifying, air [173](#)
- Deleting personal data [24](#)
- Deletion of personal data [24](#)
- Departure time, parked-vehicle ventilation [179](#)
- Destination distance [100](#)
- Digital clock [95](#)
- Dimensions [262](#)
- Dimmable exterior mirrors [61](#)
- Dimmable interior mirror [62](#)
- Direction indicator, see Turn signals [76](#)
- Display, electronic, instrument cluster [86](#)
- Display in windshield [103](#)
- Display lighting, see Instrument lighting [110](#)
- Displays [87](#)
- Displays, care [258](#)
- Disposal, coolant [240](#)
- Disposal, vehicle battery [248](#)
- Distance control, see PDC [158](#)
- Distance to destination [100](#)
- Divided screen view, split screen [23](#)
- Door key, see Remote control [37](#)
- Downhill control [144](#)
- DPC, see Dynamic Performance Control [141](#)
- Drive mode [146](#)
- Drive-off assistant [141](#)
- Drive-off assistant, see DSC [142](#)
- Driver assistance, see Intelligent Safety [120](#)
- Driving Dynamics Control [146](#)
- Driving instructions, break-in [196](#)
- Driving instructions, ECO PRO [206](#)
- Driving notes, general [196](#)
- Driving on bad roads [199](#)
- Driving on racetracks [199](#)
- Driving stability control systems [141](#)
- Driving tips [196](#)
- DSC Dynamic Stability Control [142](#)
- DTC Dynamic Traction Control [143](#)
- Dynamic Performance Control DPC [141](#)
- Dynamic Stability Control DSC [142](#)
- Dynamic Traction Control DTC [143](#)
- ## E
- ECO PRO [204](#)
- ECO PRO, bonus range [205](#)
- ECO PRO display [204](#)
- ECO PRO displays [88](#)
- ECO PRO driving mode [204](#)
- ECO PRO mode [204](#)
- ECO PRO tips [206](#)
- Efficiency display, ECO PRO [206](#)
- EfficientDynamics info [206](#)
- Electronic displays, instrument cluster [86](#)

Electronic oil measurement [235](#)
Electronic Stability Program ESP, see DSC [142](#)
Emergency release, fuel filler flap [213](#)
Emergency Request [249](#)
Emergency service, see Roadside Assistance [250](#)
Emergency unlocking, transmission lock [84](#)
Emergency wheel [230](#)
Energy Control [96](#)
Energy recovery [96](#)
Engine, automatic Start/Stop function [71](#)
Engine, automatic switch-off [71](#)
Engine compartment [232](#)
Engine compartment, working in [232](#)
Engine coolant [239](#)
Engine idling when driving, coasting [207](#)
Engine oil [235](#)
Engine oil, adding [236](#)
Engine oil additives [237](#)
Engine oil change [237](#)
Engine oil filler neck [236](#)
Engine oil temperature [94](#)
Engine oil types, alternative [237](#)
Engine oil types, suitable [237](#)
Engine start, jump-starting [250](#)
Engine start, see Starting the engine [70](#)
Engine stop [70](#)
Engine temperature [94](#)
Entering a vehicle wash [255](#)
Equipment, interior [180](#)
Error displays, see Check Control [90](#)
ESP Electronic Stability Program, see DSC [142](#)
Exchanging wheels/tires [222](#)

Exhaust system [197](#)
Exiting a vehicle wash [255](#)
Exterior mirror, automatic dimming feature [61](#)
Exterior mirrors [60](#)
External start [250](#)
External temperature display [95](#)
External temperature warning [95](#)
Eyes for securing cargo [201](#)

F

Failure message, see Check Control [90](#)
False alarm, see Unintentional alarm [48](#)
Fan, see Air flow [174](#)
Filler neck for engine oil [236](#)
Fine wood, care [257](#)
First-aid kit [250](#)
Flat tire, changing wheels [227](#)
Flat Tire Monitor FTM [118](#)
Flat tire, repairing [224](#)
Flat tire, Tire Pressure Monitor TPM [114](#)
Flat tire, warning lamp [116](#), [119](#)
Flooding [197](#)
Floor carpet, care [258](#)
Floor mats, care [258](#)
Fold-away position, wiper [79](#)
Fold back rear seat backrests [186](#)
Foot brake [198](#)
For Your Own Safety [7](#)
Front airbags [111](#)
Front center armrest [189](#)
Front cup holder [191](#)
Front fog lamps, , LED, bulb replacement [247](#)
Front fog lights [109](#)

Front fog lights/cornering lights, bulb replacement [246](#)
Front lights [245](#)
Front-seat passenger airbags, automatic deactivation [113](#)
Front-seat passenger airbags, indicator lamp [114](#)
Front seats [53](#)
FTM Flat Tire Monitor [118](#)
Fuel [214](#)
Fuel cap [212](#)
Fuel consumption, see Average fuel consumption [100](#)
Fuel filler flap [212](#)
Fuel gauge [94](#)
Fuel quality [214](#)
Fuel recommendation [214](#)
Fuel, tank capacity [264](#)
Fuse [248](#)

G

Garage door opener, see Universal Integrated Remote Control [180](#)
Gasoline [214](#)
Gear shift indicator [97](#)
General driving notes [196](#)
Glare shield [182](#)
Glasses compartment [190](#)
Glass sunroof, electric [50](#)
Glass sunroof, initialize the system [52](#)
Glove compartment [188](#)
GPS location, vehicle position [103](#)
Gross vehicle weight, approved [263](#)

H

Handbrake, see Parking brake [73](#)
Hand-held transmitter, alternating code [181](#)

Hazard warning flashers [249](#)
HDC Hill Descent Control [144](#)
Head airbags [111](#)
Headlamp courtesy delay feature [107](#)
Headlight control, automatic [107](#)
Headlight flasher [76](#)
Headlight glass [245](#)
Headlights [245](#)
Headlights, care [256](#)
Head restraints, front [58](#)
Head-up Display [103](#)
Head-up Display, care [258](#)
Head-up Display, see Memory function [59](#)
Heavy cargo, stowing cargo [201](#)
High-beam Assistant [109](#)
High beams [76](#)
High beams/low beams, see High-beam Assistant [109](#)
Hill Descent Control
HDC [144](#)
Hills [198](#)
Hill start assistant, see Drive-off assistant [141](#)
Holder for beverages [191](#)
Homepage [6](#)
Hood [232](#)
Horn [14](#)
Hot exhaust system [197](#)
HUD Head-up Display [103](#)
Hydroplaning [197](#)

I

Ice warning, see External temperature warning [95](#)
icy roads, see External temperature warning [95](#)
Identification marks, tires [219](#)
Identification number, see Vehicle identification number [10](#)

iDrive [18](#)
Ignition key, see Remote control [37](#)
Ignition off [69](#)
Ignition on [69](#)
Indication of a flat tire [116](#), [119](#)
Indicator and warning lights, see Check Control [90](#)
Indicator light, see Check Control [90](#)
Individual air distribution [175](#)
Individual settings, see Personal Profile [44](#)
Inflation pressure, tires [216](#)
Inflation pressure warning FTM, tires [118](#)
Information [6](#)
Initialize, Tire Pressure Monitor TPM [115](#)
Initializing, Flat Tire Monitor FTM [119](#)
Instrument cluster [86](#)
Instrument cluster, electronic displays [86](#)
Instrument display, multifunctional [87](#)
Instrument lighting [110](#)
Integrated key [37](#)
Integrated Owner's Manual in the vehicle [29](#)
Intelligent emergency call [249](#)
Intelligent Safety [120](#)
Intended use [7](#)
Intensity, AUTO program [174](#)
Interior equipment [180](#)
Interior lights [110](#)
Interior lights during unlocking [35](#)
Interior lights with the vehicle locked [35](#)
Interior mirror, automatic dimming feature [62](#)
Interior motion sensor [48](#)

Internet page [6](#)
Interval display, service requirements [96](#)
Interval mode [78](#)
In the vicinity of the roof-liner [17](#)
In the vicinity of the steering wheel [14](#)

J

Jacking points for the vehicle jack [229](#)
Jam protection system, glass sunroof [51](#)
Jump-starting [250](#)

K

Key/remote control [37](#)
Keyless Go, see Comfort Access [38](#)
Key Memory, see Personal Profile [44](#)
Key, see Remote control [34](#)
Kickdown, Steptronic transmission [82](#)
Knee airbag [112](#)

L

Label on recommended tires [222](#)
Lane departure warning [134](#)
Lane threshold, warning [134](#)
Language on Control Display [103](#)
Lashing eyes [201](#)
LATCH child restraint fixing system [66](#)
Launch Control [84](#)
Leather, care [256](#)
LED headlights, bulb replacement [245](#)
LEDs, light-emitting diodes [244](#)

Letters and numbers, entering 25
Light 106
Light-alloy wheels, care 257
Light control 108
Light-emitting diodes, LEDs 244
Lighting 106
Light in the exterior mirror, see Active Blind Spot Detection 136
Light replacement 244
Light replacement, front 245
Light replacement, rear 247
Lights and bulbs 244
Light switch 106
Load 201
Loading 200
Locking, automatic 46
Locking, settings 46
Low beams 106
Low beams, automatic, see High-beam Assistant 109
Lower back support 54
Luggage rack, see Roof-mounted luggage rack 202
Lumbar support 54

M

Maintenance 241
Maintenance requirements 241
Maintenance, service requirements 96
Maintenance system, BMW 241
Make-up mirror 182
Malfunction displays, see Check Control 90
Malfunction, self-leveling suspension 145
Manual air distribution 175
Manual air flow 174
Manual brake, see Parking brake 73
Manual operation, exterior mirrors 61
Manual operation, fuel filler flap 213
Manual operation, Park Distance Control PDC 159
Manual operation, rearview camera 161
Manual operation, Top View 164
Marking, run-flat tires 223
Master key, see Remote control 37
Maximum cooling 173
Maximum speed, display 97
Maximum speed, winter tires 223
Measurement, units of 103
Medical kit 250
Memory function 59
Menu in instrument cluster 99
Menus, operating, iDrive 18
Menus, see iDrive operating concept 20
Messages, see Check Control 90
Microfilter 176
Minimum tread, tires 221
Mirror 60
Mirror, see Memory function 59
Mobile communication devices in the vehicle 197
Mobility System 224
Modifications, technical, see For Your Own Safety 7
Moisture in headlight 245
Monitor, see Control Display 18
Mounting of child restraint systems 65
Moving sun visor 182
Multifunctional instrument display 87

Multifunction steering wheel, buttons 14

N

Navigation, see Owner's Manual for Navigation, Entertainment and Communication
Neck restraints, front, see Head restraints 58
Neutral cleaner, see Wheel cleaner 257
New wheels and tires 222
Night Vision 130
Night Vision device, see Night Vision 130

O

OBD Onboard Diagnosis 242
OBD, see OBD Onboard Diagnosis 242
Object detection, see Night Vision 130
Obstacle marking, rearview camera 162
Octane rating, see Recommended fuel grade 215
Odometer 95
Office, see Owner's Manual for Navigation, Entertainment and Communication
Offroad trips 199
Oil 235
Oil, adding 236
Oil additives 237
Oil change 237
Oil change interval, service requirements 96
Oil filler neck 236
Oil types, alternative 237
Oil types, suitable 237
Old batteries, disposal 248
Onboard computer 99

- Onboard computer, Control Display [101](#)
- Onboard computer, refer to Onboard computer [99](#)
- Onboard monitor, see Control Display [18](#)
- Onboard vehicle tool kit [243](#)
- Opening and closing [34](#)
- Opening the tailgate with no-touch activation [40](#)
- Operating concept, iDrive [18](#)
- Optional equipment [7](#)
- Outside air, see Automatic recirculated-air control [174](#)
- Overheating of engine, see Coolant temperature [94](#)
- ## P
- Paint, vehicle [256](#)
- Parallel parking assistant [167](#)
- Park Distance Control PDC [158](#)
- Parked vehicle, condensation [198](#)
- Parked-vehicle ventilation [178](#)
- Parking aid, see PDC [158](#)
- Parking assistant [167](#)
- Parking brake [73](#)
- Parking lights [106](#)
- Parking with Automatic Hold [74](#)
- Parts and accessories [8](#)
- Passenger side mirror, tilting downward [61](#)
- Pathway lines, rearview camera [162](#)
- PDC Park Distance Control [158](#)
- Pedestrian detection, see Night Vision [130](#)
- Pedestrian warning with Approach control [128](#)
- Personal Profile [44](#)
- Personal Profile, exporting profiles [45](#)
- Pinch protection system, windows [49](#)
- Plastic, care [257](#)
- PostCrash [139](#)
- Power failure [247](#)
- Power sunroof, glass [50](#)
- Power windows [48](#)
- Prescribed engine oil types [237](#)
- Pressure, tire air pressure [216](#)
- Pressure warning FTM, tires [118](#)
- Profile, see Personal Profile [44](#)
- Programmable memory buttons, iDrive [24](#)
- Protective function, glass sunroof [51](#)
- Protective function, windows [49](#)
- Push-and-turn reel, refer to controller [19](#)
- ## R
- Racetrack operation [199](#)
- Radiator fluid [239](#)
- Radio-operated key, see Remote control [37](#)
- Radio-operated remote control, opening/closing [34](#)
- Radio ready state [69](#)
- Radio, see Owner's Manual for Navigation, Entertainment and Communication
- Rain sensor [78](#)
- Ratchet straps [201](#)
- Rear automatic climate control [177](#)
- Rear center armrest [190](#)
- Rear drink holder [191](#)
- Rear lights [247](#)
- Rear seats [56](#)
- Rearview camera [160](#)
- Rearview mirror [60](#)
- Rear window defroster [176](#)
- Recirculated-air mode [174](#)
- Recommended fuel grade [215](#)
- Recommended tire brands [222](#)
- Refueling [212](#)
- Remaining range [95](#)
- Remote control/key [37](#)
- Remote control, additional [36](#)
- Remote control, loss [36](#)
- Remote control, malfunction [36](#)
- Remote control, opening/closing [34](#)
- Remote control, universal [180](#)
- Replacing parts [243](#)
- Replacing wheels/tires [222](#)
- Reporting safety malfunctions [10](#)
- RES button [152](#)
- RES button, see Active Cruise Control, ACC [149](#)
- RES button, see Cruise control [155](#)
- Reserve warning, see Range [95](#)
- Reset, Tire Pressure Monitor TPM [115](#)
- Residual heat, automatic climate control [175](#)
- Retreaded tires [222](#)
- Roadside parking lights [106](#)
- Roller sunblinds [50](#)
- Rolling code hand-held transmitter [181](#)
- RON recommended fuel grade [215](#)
- Roofliner [17](#)
- Roof load capacity [263](#)
- Roof-mounted luggage rack [202](#)

RSC Run Flat System Component, see Run-flat tires [223](#)
Rubber components, care [257](#)
Run-flat tires [223](#)

S

Safe braking [198](#)
Safety belt reminder for driver's seat and front passenger seat [58](#)
Safety belts [57](#)
Safety belts, care [258](#)
Safety locks, doors, and windows [68](#)
Safety Package, see Active Protection [138](#)
Safety switch, windows [50](#)
Safety systems, airbags [111](#)
Saving fuel [203](#)
Screen, see Control Display [18](#)
Screwdriver, see Onboard vehicle tool kit [243](#)
Sealant [224](#)
Seat belts, see Safety belts [57](#)
Seat heating, front [55](#)
Seat heating, rear [56](#)
Seating position for children [64](#)
Seat, see Memory function [59](#)
Seats, front [53](#)
Seats, rear [56](#)
Seat ventilation, front [56](#)
Securing cargo [201](#)
Selection list in instrument cluster [99](#)
Selector lever, see Steptronic transmission [80](#)
Self-leveling suspension, air suspension [145](#)

Self-leveling suspension, malfunction [145](#)
Sensors, care [258](#)
Service and warranty [8](#)
Service requirements, Condition Based Service CBS [241](#)
Service requirements, display [96](#)
Service, Roadside Assistance [250](#)
Services, ConnectedDrive
SET button, see Active Cruise Control, ACC [149](#)
SET button, see Cruise control [155](#)
Settings, locking/unlocking [46](#)
Settings on Control Display [102](#)
Shifting, Steptronic transmission [80](#)
Shift paddles on the steering wheel [83](#)
Shift point indicator [89](#)
Side airbags [111](#)
Side View [165](#)
Signaling, horn [14](#)
Signals when unlocking [46](#)
Sitting safely [53](#)
Size [262](#)
Ski and snowboard bag [187](#)
Slide/tilt glass roof [50](#)
Smoker's package [182](#)
SMS text message, supplementary [94](#)
Snow chains [227](#)
Socket [183](#)
Socket, OBD Onboard Diagnostics [242](#)
SOS button [249](#)
Spare tire, see Emergency wheel [230](#)
Speed, average [100](#)
Speed Limit Info [97](#)

Speed Limit Info, onboard computer [101](#)
Speed limits, display [97](#)
Speed warning [101](#)
Split screen [23](#)
SPORT+ - program, driving dynamics [147](#)
Sport displays, torque display, performance display [101](#)
SPORT program, driving dynamics [147](#)
Stability control systems [141](#)
Standard equipment [7](#)
Start/stop, automatic function [71](#)
Start/Stop button [69](#)
Starting the engine [70](#)
Status control display, tires [115](#)
Status information, iDrive [23](#)
Status of Owner's Manual [7](#)
Steering wheel, adjusting [62](#)
Steering wheel heating [62](#)
Steering wheel, see Memory function [59](#)
Steptronic Sport transmission, see Steptronic transmission [80](#)
Steptronic transmission [80](#)
Stopping the engine [70](#)
Storage compartment on the center console [189](#)
Storage compartments [188](#)
Storage compartments, locations [188](#)
Storage, tires [223](#)
Storing the vehicle [258](#)
Stowing and securing cargo [201](#)
Suitable engine oil types [237](#)
Summer tires, tread [221](#)
Sun visor [182](#)
Supplementary SMS [94](#)
Surround View [160](#)
Suspension settings [146](#)

Switch for Dynamic Driving Control [146](#)
Switch, see Cockpit [14](#)
Symbols [6](#)
Symbols in the status field [23](#)
SYNC program, automatic climate control [175](#)

T

Tachometer [94](#)
Tailgate, automatic [42](#)
Tailgate, closing with no-touch activation [40](#)
Tailgate, opening with no-touch activation [40](#)
Tailgate via remote control [35](#)
Tail lights [247](#)
Technical changes, see For Your Own Safety [7](#)
Technical data [262](#)
Telephone, see Owner's Manual for Navigation, Entertainment and Communication
Temperature, automatic climate control [173](#)
Temperature display for external temperature [95](#)
Temperature, engine oil [94](#)
Terminal, starting aid [251](#)
Theft alarm system, see Alarm system [47](#)
Thermal camera, see Night Vision [130](#)
Thigh support [54](#)
Tilt alarm sensor [48](#)
Time [102](#)
Time of arrival [100](#)
Tire damage [221](#)
Tire identification marks [219](#)
Tire inflation pressure [216](#)
Tire inflation pressure monitor, see FTM [118](#)
Tire Pressure Monitor TPM [114](#)
Tire repair kit, see Mobility System [224](#)
Tires, changing [222](#)
Tire sealant, see Mobility System [224](#)
Tires, everything on wheels and tires [216](#)
Tires, run-flat tires [223](#)
Tire tread [221](#)
Tone, see Owner's Manual for Navigation, Entertainment and Communication
Tool [243](#)
Top View [163](#)
Total vehicle weight [263](#)
Touchpad [21](#)
Towing [252](#)
Tow-starting [252](#)
TPM Tire Pressure Monitor [114](#)
Traction control [143](#)
TRACTION, driving dynamics [143](#)
TRACTION program, driving dynamics [146](#)
Transmission lock, electronic unlocking [84](#)
Transmission, Steptronic transmission [80](#)
Transporting children safely [64](#)
Tread, tires [221](#)
Trip computer [101](#)
Triple turn signal activation [76](#)
Trip odometer [95](#)
Trip recorder, see Trip odometer [95](#)
Turning radius lines, rearview camera [162](#)
Turn signals, operation [76](#)

U

Unintentional alarm [48](#)
Units of measurement [103](#)
Universal remote control [180](#)
Unlock button, see Steptronic transmission [80](#)
Unlocking, settings [46](#)
Unpaved roads, cross-country trips [199](#)
Updates made after the editorial deadline [7](#)
Upholstery care [257](#)
Upper backrest adjustment [55](#)
USB interface, general information [184](#)
USB port, see USB interface [184](#)
Use, intended [7](#)

V

Vanity mirror [182](#)
Vehicle battery [247](#)
Vehicle battery, replacing [247](#)
Vehicle, break-in [196](#)
Vehicle care [256](#)
Vehicle care products [256](#)
Vehicle features and options [7](#)
Vehicle identification number [10](#)
Vehicle jack [229](#)
Vehicle key, see Remote control [37](#)
Vehicle paint [256](#)
Vehicle position, GPS location [103](#)
Vehicle storage [258](#)
Vehicle wash [255](#)
Vehicle, washing [255](#)
Ventilation [176](#)
Ventilation, see Parked-vehicle ventilation [178](#)

Venting, see Ventilation [176](#)
Vent, see Ventilation [176](#)
Vertical Dynamic Control [145](#)
VIN, see Vehicle identification number [10](#)
Voice activation system [26](#)

W

Warning and indicator lights, see Check Control [90](#)
Warning displays, see Check Control [90](#)
Warning light in the exterior mirror, see Active Blind Spot Detection [136](#)
Warning messages, see Check Control [90](#)
Warning triangle [250](#)
Warranty [7](#)
Washer fluid [80](#)
Washer nozzles, windshield [79](#)
Washer system [77](#)
Washing the vehicle [255](#)
Water on roads [197](#)
Weights [263](#)
Welcome lights [107](#)
Welcome lights during unlocking [35](#)
Wheel cleaner [257](#)
Wheels, changing [222](#)
Wheels, everything on wheels and tires [216](#)
Wheels, Flat Tire Monitor FTM [118](#)
Wheels, Tire Pressure Monitor TPM [114](#)
Window defroster, rear [176](#)
Windows, powered [48](#)
Windshield, climate control [197](#)
Windshield washer fluid [80](#)
Windshield washer nozzles [79](#)

Windshield washer system [77](#)
Windshield washer system, see washer/wiper system [77](#)
Windshield wiper [77](#)
Winter storage, care [258](#)
Winter tires, suitable tires [223](#)
Winter tires, tread [221](#)
Wiper [77](#)
Wiper blades, replacing [243](#)
Wiper fluid [80](#)
Wiper, fold-away position [79](#)
Wiper system [77](#)
Wood, care [257](#)
Word match concept [25](#)
Wrench, see Onboard vehicle tool kit [243](#)

X

xDrive [143](#)
xDrive, display [143](#)
Xenon headlights, bulb replacement [245](#)

More about BMW



The Ultimate
Driving Machine®

bmwusa.com

01 40 2 915 604 ue



Online Edition for Part no. 01 40 2 915 604 - X/16