




Owner's manual
Owner's Manual
Edition: 12.2016
ID: 5GM012723AL

Signs and symbols



Indicates a reference to a section with important information and safety warnings  that should always be heeded.



Arrow indicating that the section continues on the next page.



Arrow marking the end of a section.



The symbol indicates situations in which the vehicle must be stopped as quickly as possible.



The symbol indicates registered trademarks. However, the absence of this symbol does not constitute a waiver of any rights associated with intellectual property.



Cross-reference to a red, orange, or yellow warning in the same section or on the stated page, pointing out possible risks that can cause serious personal injuries and how to help prevent them.



the stated page.



Used on vehicle labels and indicates the availability of additional important information and warnings in this Owner's Manual.

DANGER!

Texts with this symbol contain information regarding hazardous situations which will cause death or severe injuries if not avoided.

WARNING

Texts with this symbol contain information regarding hazardous situations which could cause death or severe injuries if not avoided.

CAUTION

Texts with this symbol contain information regarding hazardous situations which could cause minor or moderate injuries if not avoided.

NOTE

Texts with this symbol contain information regarding situations which could cause vehicle damage if not avoided.



Texts with this symbol contain information about the environment and how you can help to protect it.



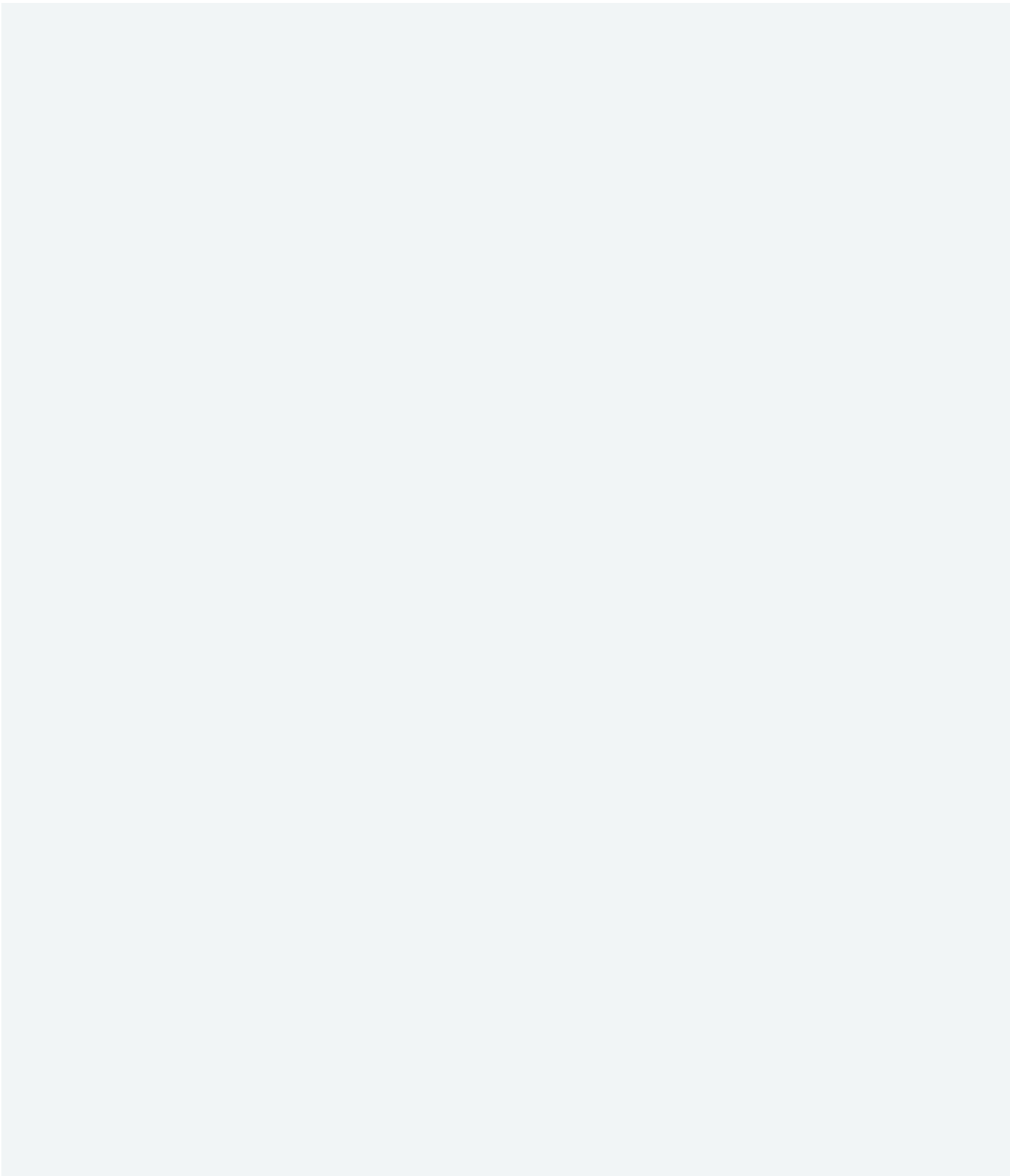
[Purchase Owner's Literature](#) | [Terms](#) | [Privacy](#)

* This Online Owner's Manual may not include Supplements issued after the publication of the



Owner's literature controls.

"Volkswagen" and the Volkswagen logo are registered trademarks of Volkswagen AG. © 2018
Volkswagen of America, Inc.





Owner's manual
Owner's Manual
Edition: 12.2016
ID: 5GM012723AL

Via this Owner's Manual

- At the end of this Manual, you will find an [alphabetical index](#).
- The list of [Abbreviations](#) at the end of the Manual explains the technical abbreviations and designations.
- [Directions](#) (left, right, front, back) refer to the driving direction unless noted otherwise.
- [Illustrations](#) are only for orientation and are merely used to help explain the text descriptions and instructions.
- Any technical modifications to the vehicle that were introduced after the editorial deadline can be found in a [supplement](#) to this Manual.

All options and models are described without identification as optional equipment or model versions. Some of the described equipment may not be installed on your vehicle or may be available at a later time or only in certain markets. Please consult the sales documents regarding your vehicle's equipment and options and contact your authorized Volkswagen dealer or authorized Volkswagen Service Facility for more information.

All information in this Manual corresponds to information available as of the editorial deadline. Due to ongoing vehicle development, there may be differences between your vehicle and the information in this Manual. No legal obligations or commitments can be derived from the information, illustrations, or descriptions in this Manual.

If you sell or lend your vehicle, please make sure that the complete Manual set is in the vehicle.

Standard Manual set includes:

- Warranty and Maintenance booklet
- Owner's Manual



- Supplement
- Infotainment System
- *Other inserts*



[Purchase Owner's Literature](#) | [Terms](#) | [Privacy](#)

* This Online Owner's Manual may not include Supplements issued after the publication of the physical Owner's Manual. Please consult your physical Owner's literature. In the event of a discrepancy between the Online Owner's Manual and physical Owner's literature, the physical Owner's literature controls.

"Volkswagen" and the Volkswagen logo are registered trademarks of Volkswagen AG. © 2018 Volkswagen of America, Inc.

Owner's manual
Owner's Manual
Edition: 12.2016
ID: 5GM012723AL

Vehicle overview

Exterior views

Side view

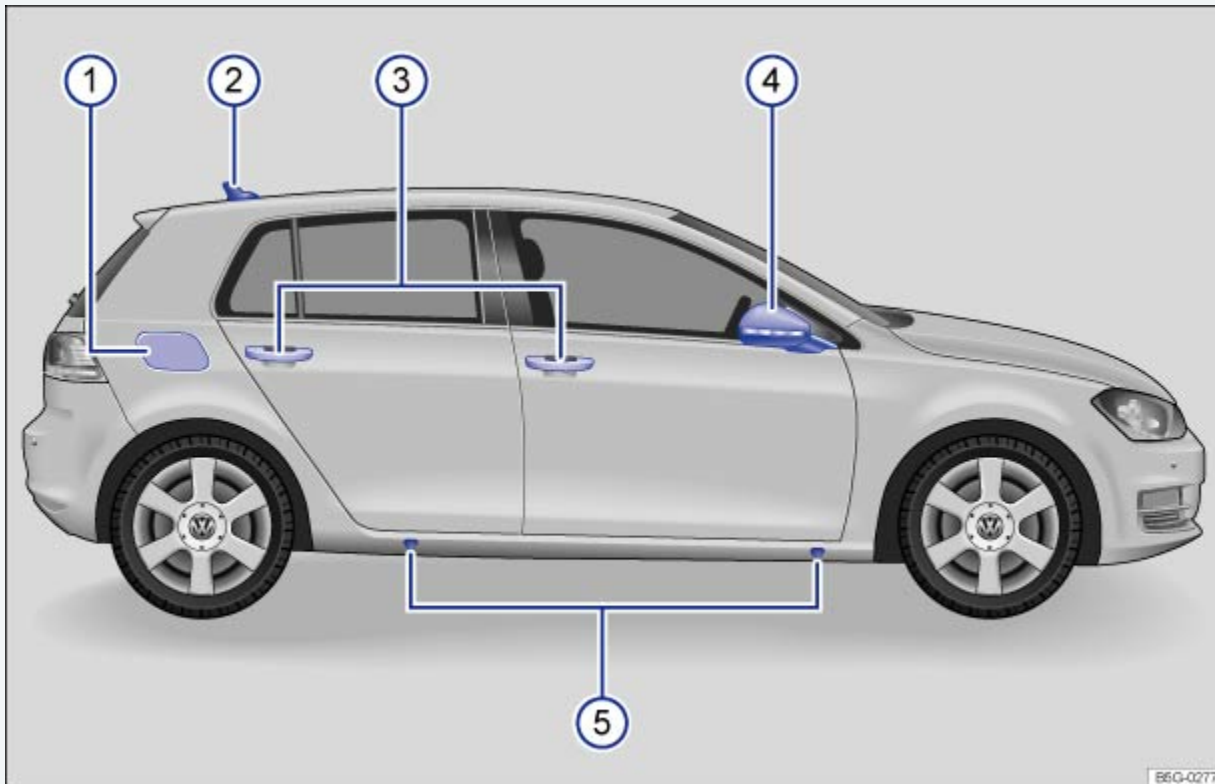


Fig. 1 Vehicle side overview.

Key to ⇒ *Fig. 1* :

- ① Fuel filler flap ⇒ *Refueling*
- ② Roof antenna ⇒ *Consumer information*
- ③ Outside door handles ⇒ *Doors*
- ④ Outside mirror ⇒ *Mirrors*

5 Lift points for the jack ⇒ *Changing a wheel*

Front view

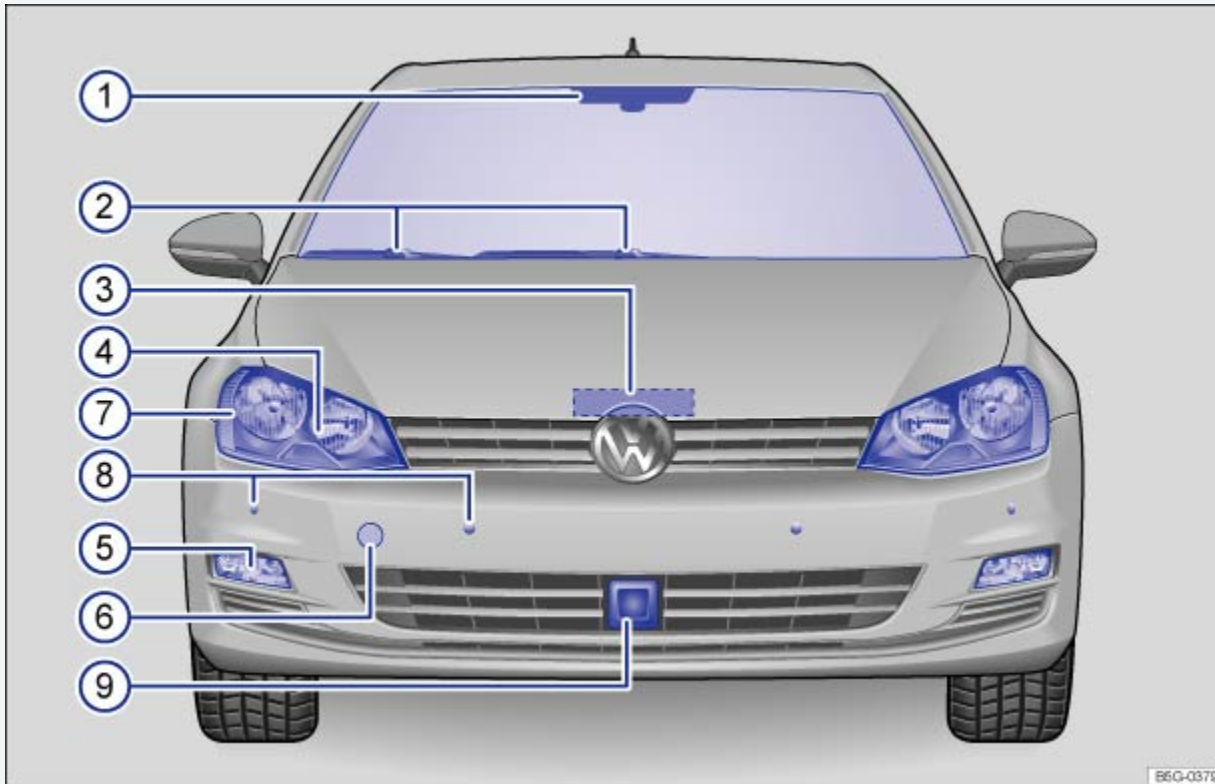


Fig. 2 Vehicle front overview.

Key to ⇒ *Fig. 2* :

- 1 Inside mirror with sensor or camera on the mirror base for:
 - Rain sensor (if equipped) ⇒ *Windshield wipers and washer*
 - Low-light sensor (if equipped) ⇒ *Lights*
 - Lane Assist (if equipped) ⇒ *Lane Keeping System (Lane Assist)*
 - Light Assist (if equipped) ⇒ *Light Assist*
- 2 Windshield wipers ⇒ *Windshield wipers and washer*
- 3 Engine hood release ⇒ *Working in the engine compartment*
- 4 Headlights (on left and right) ⇒ *Lights*
- 5 Fog lights/static cornering lights (on left and right, if equipped) ⇒ *Lights*

- ⑦ Side marker lights (on left and right) ⇒ *Lights*
- ⑧ Sensors for:
 - Park Distance Control (PDC) (if equipped) ⇒ *Park Distance Control (PDC)*
- ⑨ Sensor for:
 - Adaptive Cruise Control System (if equipped) ⇒ *Adaptive Cruise Control (ACC)*
 - Front Assist (if equipped) ⇒ *Forward Collision Warning (Front Assist)*

Rear view

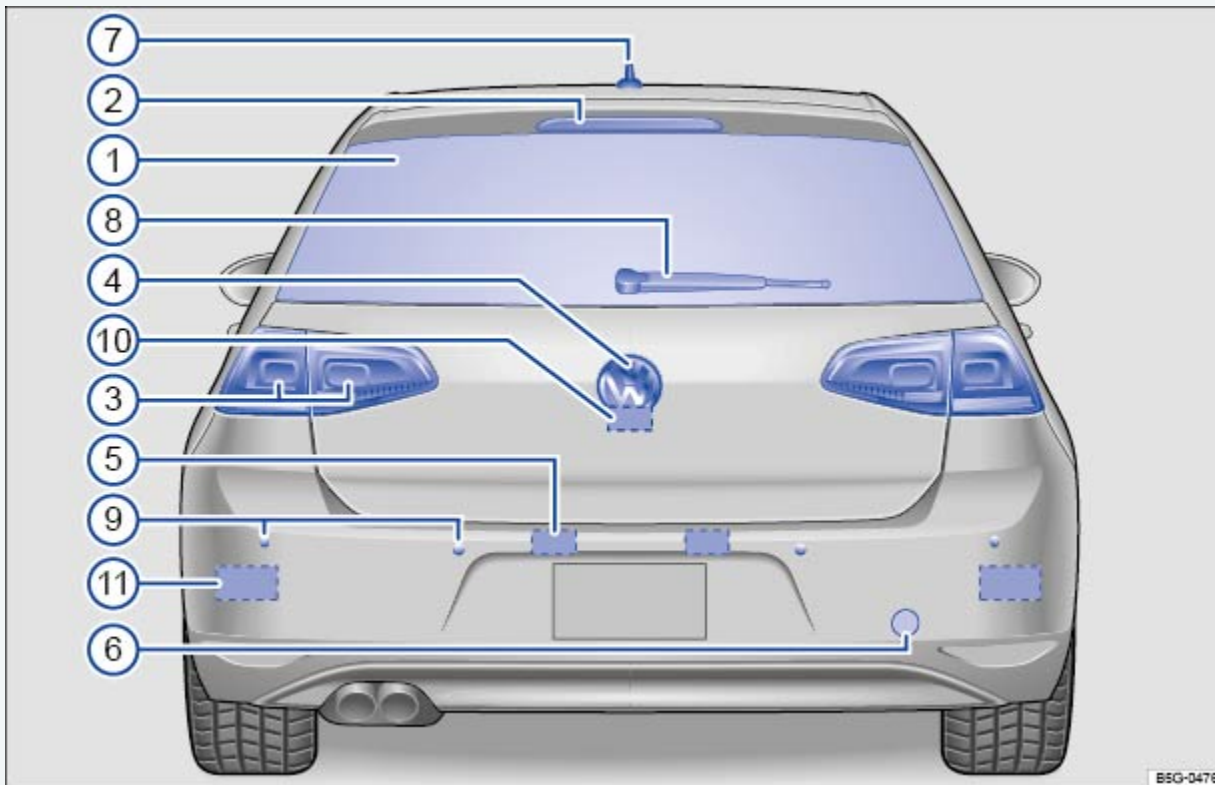


Fig. 3 Vehicle rear overview.

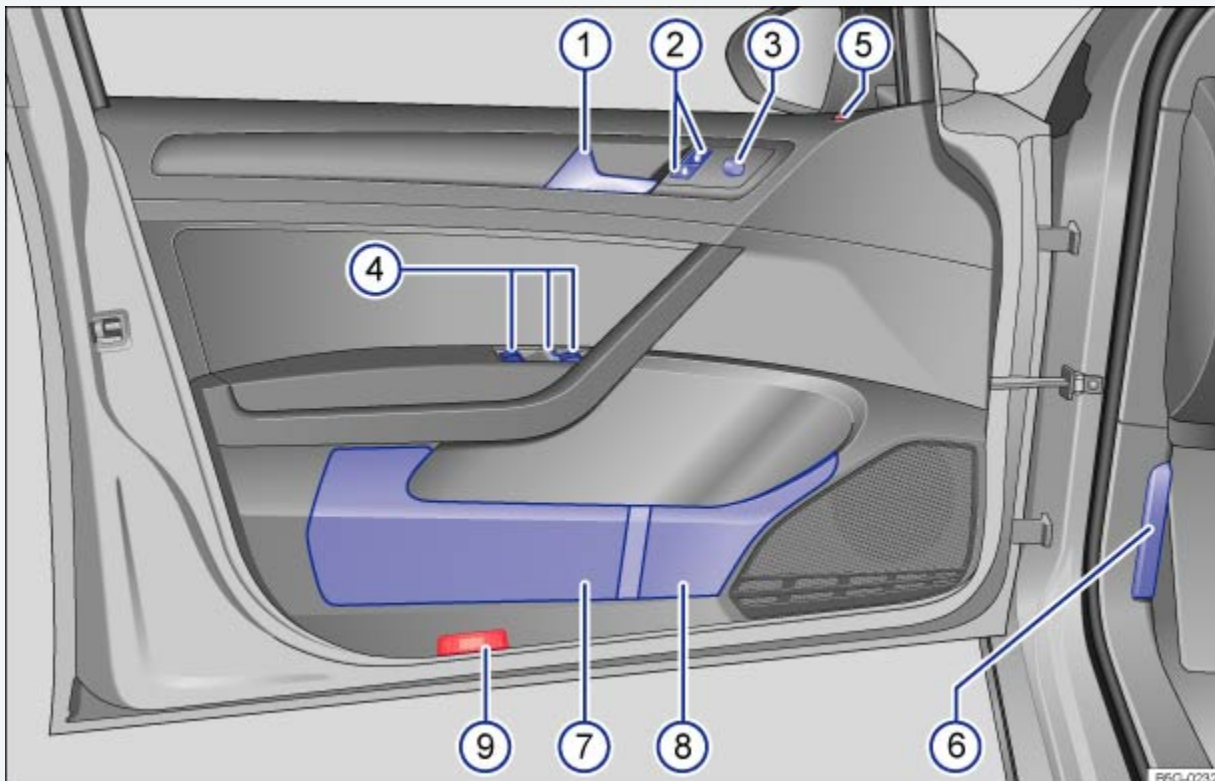
Key to ⇒ *Fig. 3* :

- ① Rear window:
 - Rear window defroster ⇒ *Heating and air conditioning*
- ② High-mounted brake light ⇒ *Braking and parking*

- ④ Volkswagen emblem for opening the trunk lid ⇒ *Trunk lid*
- ⑤ License plate lights ⇒ *Lights* , ⇒ *Replacing light bulbs*
- ⑥ Threaded hole for the rear towing eye (behind cover) ⇒ *Towing*
- ⑦ Roof antenna ⇒ *Consumer information*
- ⑧ Rear windshield wiper ⇒ *Windshield wipers and washer*
- ⑨ Sensors for:
 - Park Distance Control (PDC) (if equipped) ⇒ *Park Distance Control (PDC)*
 - Park Assist (if equipped) ⇒ *Park Assist*
- ⑩ Area for the Rear View Camera system (if equipped) ⇒ *Rear View Camera system*
- ⑪ Sensors for the Blind Spot Monitor with Rear Traffic Alert (approximate location on left and right, if equipped) ⇒ *Blind Spot Monitor with Rear Traffic Alert*



Passenger compartment



Driver door overview






Key to ⇒ *Fig. 4* :

- ① Door handle ⇒ *Doors*
- ② Power locking button for locking and unlocking the vehicle  -  ⇒ *Power locking system*
- ③ Knob for adjusting the outside mirrors ⇒ *Mirrors*
 - Adjusting outside mirrors **L - 0 - R**

 - Outside mirror heating 
- ④ Switches for operating the power windows ⇒ *Power windows*
 - Power windows 

 - Safety switch for rear power windows (4-door models only) 
- ⑤ Indicator light for the power locking system ⇒ *Power locking system*
- ⑥ Lever for releasing the engine hood ⇒ *Working in the engine compartment*
- ⑦ Storage compartment ⇒ *Storage areas*
- ⑧ Bottle holder ⇒ *Cup holders*
- ⑨ Reflector

Driver side overview

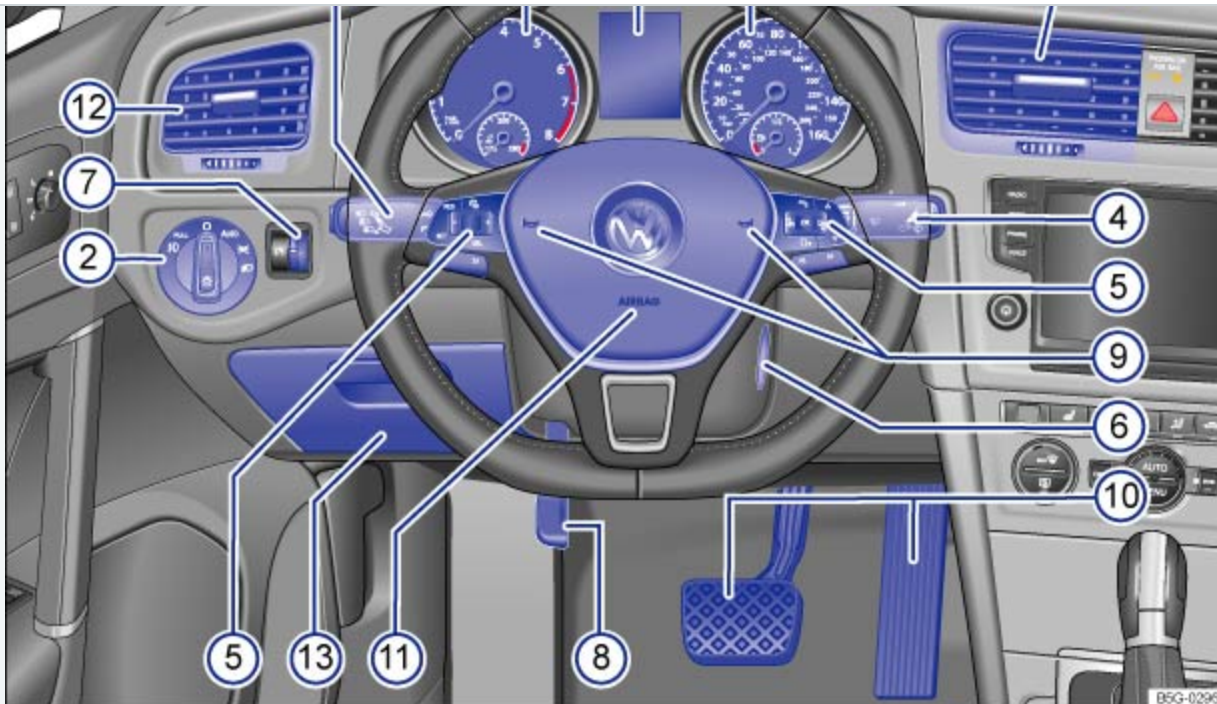


Fig. 5 Driver side overview.

Key to ⇒ Fig. 5 :

① Instrument cluster:

- Instruments ⇒ *Instrument cluster*
- Display ⇒ *Instrument cluster*
- Warning and indicator lights ⇒ *Warning and indicator lights*

② Headlight switch ☀ ⇒ *Lights*

- Off position **0**
- Automatic headlights **AUTO** (if equipped)
- Parking lights (if equipped)
- Low beams
- Fog lights **PULL** (if equipped)

③ Lever for ⇒ *Lights*

- Turning high beams on or off -



- Turn signals

- Cruise control (if equipped) **ON - CANCEL - OFF, RES/+ - - SET/-** ⇒ *Cruise control*

④ Windshield wiper and washer lever ⇒ *Windshield wipers and washer*

- Windshield wiper **HIGH - LOW**

- Intermittent operation for the front windshield wipers **INT**

- Interval settings for the wipers or sensitivity for the rain sensor

- Windshield wiper **OFF**

- One-tap wiping **1x**

- Windshield wiper

- Automatic wipe/wash for windshield

- Rear window wiper

- Rear window automatic wipe/wash

- Buttons for the Volkswagen Information System (vehicles without multi-function steering wheel) **TRIP, OK/RESET** ⇒ *Volkswagen Information System*

⑤

Multi-function steering wheel controls (if equipped) ⇒ *Volkswagen Information System*, ⇒ *Cruise control*

- Volume setting for radio, navigation system notifications (if applicable), or telephone calls -

- Voice control activation

- Display Phone main menu or accept telephone calls

- Audio, navigation -

- Control buttons for the Volkswagen Information System - **OK** - , ,

- Cruise control buttons , **SET, CNL, RES, + -** ,

the Keyless Access system ⇒ *Starting and stopping the engine*

- 7 Dimmer control for the instrument and switch illumination ⇒ *Lights*
- 8 Lever for the adjustable steering wheel ⇒ *Adjusting the seating position*
- 9 Horn
- 10 Pedals ⇒ *Shifting*
- 11 Driver front airbag ⇒ *Airbag system*
- 12 Air vents ⇒ *Heating and air conditioning*
- 13 Storage compartment ⇒ *Storage areas*

Center console overview

Upper center console

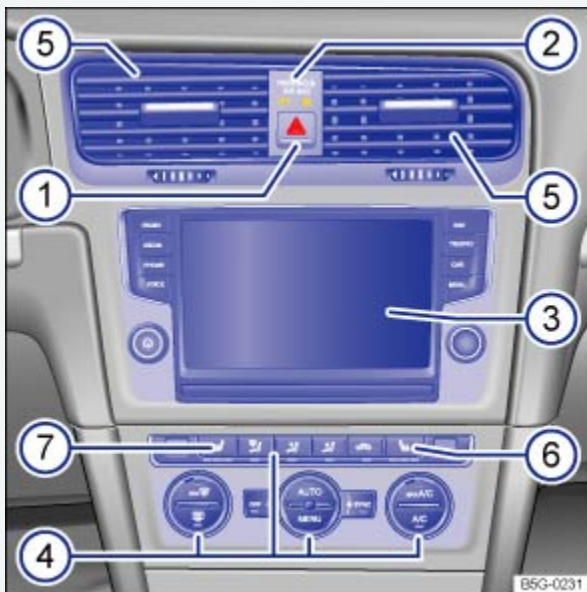


Fig. 6 Overview of the upper center console.

Key to ⇒ *Fig. 6* :

- 1 Button for the emergency flashers ⇒ *In an emergency*
- 2 PASSENGER AIR BAG **OFF** light (front airbag for front seat passenger) ⇒ *Airbag system*
- 3 Infotainment system ⇒ *Infotainment system*
 - User information display ⇒ *Infotainment system*

- Navigation system ⇒ *Booklet Infotainment System*,

④ Controls for:

- Manual air conditioning ⇒ *Heating and air conditioning*

- Climatronic ⇒ *Heating and air conditioning*

⑤ Air vents ◀ - ||| - ▶ ⇒ *Heating and air conditioning*

⑥ Passenger seat heating button ⇒ *Seat functions*

⑦ Driver seat heating button ⇒ *Seat functions*

Lower center console

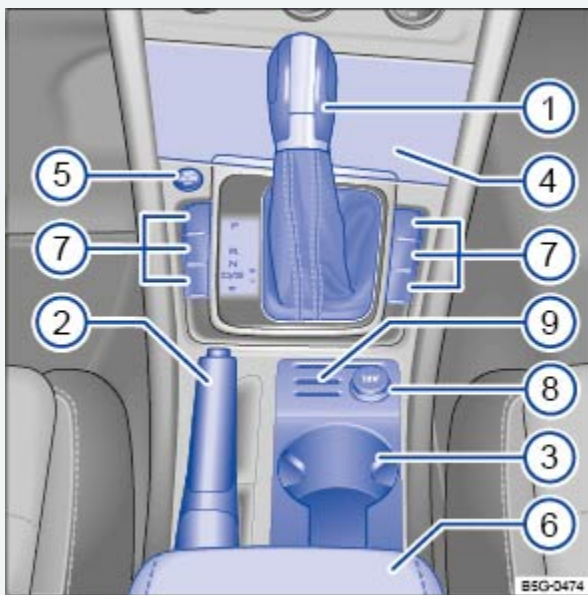


Fig. 7 Overview of the lower center console (Golf and Golf GTI models).

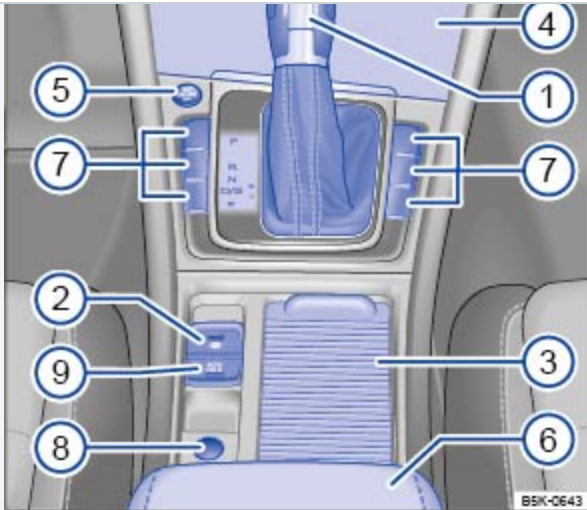


Fig. 8 Overview of the lower center console (Golf R models).

Key to ⇒ [Fig. 7](#) (Golf and Golf GTI models only):

① Lever for:

- Manual transmission ⇒ [Shifting](#)
- Automatic transmission ⇒ [Shifting](#)

② Parking brake lever ⇒ [Braking and parking](#)

③ Storage compartment with cup holders ⇒ [Cup holders](#)

④ Storage compartment ⇒ [Storage areas](#)

- With AUX-in jack and/or USB port ⇒ [Booklet Infotainment System](#),

⑤ Starter button (for vehicles with Keyless Access) **START - ENGINE - STOP** ⇒ [Starting and stopping the engine](#)


⑥ Center armrest ⇒ [Center armrest \(Golf, Golf GTI\)](#)

- With storage compartment ⇒ [Storage areas](#)
- With 12 Volt socket ⇒ [Power outlets](#)

⑦ Buttons for:

- Driving Mode Selection (if equipped) ⇒ [Driving Mode Selection](#)
- Anti-slip regulation (ASR) (if equipped) ⇒ [Braking and parking](#)



- Park Distance Control (if equipped)  ⇒ *Park Distance Control (PDC)*

⑧ 12 Volt socket ⇒ *Power outlets*


⑨ Coin holders ⇒ *Coin holders in the front center console (Golf, Golf GTI)*

Key to ⇒ *Fig. 8* (Golf R models only):

① Lever for:


- Manual transmission ⇒ *Shifting*

- Automatic transmission ⇒ *Shifting*

② Electronic parking brake  ⇒ *Braking and parking*

③ Storage compartment with cup holders ⇒ *Cup holders*


④ Storage compartment ⇒ *Storage areas*


- With AUX-in jack  and/or USB port  ⇒ *Booklet Infotainment System,*


⑤ Starter button (for vehicles with Keyless Access) **START - ENGINE - STOP** ⇒ *Starting and stopping the engine*


⑥ Center armrest ⇒ *Center armrest (Golf R)*

⑦ Buttons for:

- Driving Mode Selection (if equipped)  ⇒ *Driving Mode Selection*

- Anti-slip regulation (ASR)  ⇒ *Braking and parking*

- Park Assist (if equipped)  ⇒ *Park Assist*

- Park Distance Control (if equipped)  ⇒ *Park Distance Control (PDC)*

⑧ 12 Volt socket ⇒ *Power outlets*

⑨ Auto Hold button **AUTO HOLD** ⇒ *Starting assistance systems*

Front passenger side overview



Fig. 9 Overview of the front passenger side.

Key to ⇒ Fig. 9 :

- ① Passenger front airbag location in the instrument panel (approximate) ⇒ *Airbag system*
- ② Air vent ◀ - ||| - ▶ ⇒ *Heating and air conditioning*
- ③ Opening handle for the glove compartment ⇒ *Storage areas*

Symbols on the roof console

Symbol	Meaning
	Interior and reading lights ⇒ <i>Lights</i> .
	Power sunroof ⇒ <i>Power sunroof</i> .
<p>OR: </p>	3-button module for vehicles with Car-Net® ⇒ <i>VW Car-Net®</i> .

Instrument cluster and instrument panel

Warning and indicator lights

Warning and indicator lights notify you of warnings ⇒ , malfunctions ⇒ , or certain functions.










the engine is running or when the vehicle is moving.










Additional text messages appear in the instrument cluster of appropriately equipped vehicles to give more information or prompt you to take certain actions ⇒ [Instrument cluster](#).

Depending on the vehicle options, a symbol may appear in the instrument cluster instead of a warning light.









In addition, a warning chime or other acoustic warning sounds when certain warning and indicator lights go on.

Symbol	Meaning ⇒  , ⇒ 
	Central warning light: Read and follow the text messages in the instrument cluster display.
	 Stop! Parking brake engaged ⇒ Braking and parking .
	 Stop! Brake fluid level too low or brake system malfunction ⇒ Braking and parking .










	<p> Stop!</p> <p>Engine coolant level too low, engine coolant temperature too high, or engine coolant system malfunction^{a)} ⇒ <i>Engine coolant</i>.</p>
	<p> Stop!</p> <p>Engine oil pressure too low^{a)} ⇒ <i>Engine oil</i>.</p>
	<p> Stop!</p> <p>Lights up: Steering system malfunction ⇒ <i>Steering</i>.</p>
	<p> Stop!</p> <p>Flashes: Electronic steering column lock malfunction ⇒ <i>Steering</i>.</p>
	<p>Driver and/or passenger safety belts not buckled ⇒ <i>Safety belts</i>.</p>
	<p>Alternator malfunction^{a)} ⇒ <i>Vehicle battery</i>.</p>













	Brake or take action to avoid the vehicle ahead! Front Assist Forward Collision Warning (if equipped) ^{a)} ⇒ <i>Forward Collision Warning (Front Assist)</i> .
	Brake! Depress brake pedal. ACC driver intervention warning ⇒ <i>Adaptive Cruise Control (ACC)</i> .
	Lights up: ESC malfunction or ESC switched off by the system ⇒ <i>Braking and parking</i> .
	OR: the vehicle battery has been reconnected ⇒ <i>Braking and parking</i> .
	Flashes: ESC or ASR is working ⇒ <i>Braking and parking</i> .
	ASR manually deactivated ⇒ <i>Braking and parking</i> .
	OR: ESC Sport mode manually activated ⇒ <i>Braking and parking</i> .
	ABS malfunction ⇒ <i>Braking and parking</i> .
	Electronic parking brake malfunction (if equipped) ^{a)} ⇒ <i>Braking and parking</i> .
	Central caution light: Read and follow the text messages in the instrument cluster display.










	One or more driving lights burned out ^{a)} ⇒ <i>Replacing light bulbs</i> .
	Light malfunction, excluding AFS ^{b)} ⇒ <i>Lights</i> .
	Not enough windshield washer fluid ^{a)} ⇒ <i>Windshield wipers and washer</i> .
	Lights up: Engine control malfunction ⇒ <i>Engine control and emission control system</i> .
	Flashes: Misfire ⇒ <i>Engine control and emission control system</i> .
EPC	Engine control malfunction ⇒ <i>Engine control and emission control system</i> .
	Engine speed (rpm) limited (if equipped, to help prevent overheating) ^{a)} ⇒ <i>Engine control and emission control system</i> .
	Problem with the steering ⇒ <i>Steering</i> .
	Lights up: Tire pressure too low ⇒ <i>Tires and wheels</i> .
	Flashes: Tire Pressure Monitoring System (TPMS) malfunction ⇒ <i>Tire Pressure Monitoring System (TPMS)</i> .
	Fuel tank almost empty ⇒ <i>Refueling</i> .








	Fuel filler cap not properly closed ^{a)} ⇒ <i>Refueling</i> .
	Lights up: Engine oil level too low ^{a)} ⇒ <i>Engine oil</i> .
	Flashes: Engine oil system malfunction ^{a)} ⇒ <i>Engine oil</i> .
	Airbag and safety belt pretensioner system malfunction ⇒ <i>Airbag system</i> .
	Passenger front airbag turned off (PASSENGER AIR BAG OFF  light) ⇒ <i>Airbag system</i> .
	Transmission malfunction ^{a)} ⇒ <i>Shifting</i> .
	Front Assist switched off (if equipped) ^{a)} ⇒ <i>Forward Collision Warning (Front Assist)</i> .
	Blind Spot Monitor malfunction ⇒ <i>Blind Spot Monitor with Rear Traffic Alert</i> .
	Adaptive cruise control (ACC) currently not available ^{a)} ⇒ <i>Adaptive Cruise Control (ACC)</i> .
	Lane Assist switched on, not active ⇒ <i>Lane Keeping System (Lane Assist)</i> .



	Adaptive chassis control DCC system malfunction (if equipped) ^{a)} ⇒ <i>Driving Mode Selection</i> .
	Turn signals, left or right ⇒ <i>Lights</i> .
	Emergency flashers switched on ⇒ <i>In an emergency</i> .
	Lights up: Brake pedal not depressed ⇒ <i>Starting and stopping the engine</i> , ⇒ <i>Shifting</i> , ⇒ <i>Braking and parking</i> .
	Flashes: The release button in the selector lever is not engaged ⇒ <i>Shifting</i> .
	Cruise control is regulating the vehicle speed ⇒ <i>Cruise control</i> .
CRUISE	OR: Adaptive Cruise Control (ACC) switched on ⇒ <i>Adaptive Cruise Control (ACC)</i> .
	Lane Assist is switched on and active ⇒ <i>Lane Keeping System (Lane Assist)</i> .
	The vehicle is being held by the Auto Hold feature (if equipped) ⇒ <i>Starting assistance systems</i> .
	High beams switched on or headlight flashers in use ⇒ <i>Lights</i> .



	Light Assist high beam control switched on (if equipped) ⇒ <i>Light Assist</i> .
	Service reminder display ⇒ <i>Service reminder display</i> .
	Charge level of the mobile phone battery. Applies only to models with a factory-installed mobile phone package ⇒ <i>Booklet Infotainment System</i> .
	Outside temperature colder than +39 °F (+4 °C) ⇒ <i>Displays</i> .
	Refer to the Owner's Manual.

WARNING

Failure to heed warning lights and instrument cluster text messages can cause the vehicle to break down in traffic and result in a collision and serious personal injury.

- Never ignore warning lights or text WARNINGS.
- Always stop the vehicle as soon as it is safe to do so.
- Park the vehicle at a safe distance from moving traffic and where no part of the hot catalytic converter and exhaust system can come into contact with flammable materials under the vehicle, such as dry grass, brush, spilled fuel, etc.
- A broken down vehicle presents a high accident risk for itself and others. Switch on emergency flashers and set up a warning triangle to warn oncoming traffic.
- Before opening the engine hood, always switch off the engine and let the engine cool down.
- Always be very careful when working in the engine compartment, which is a potentially dangerous area in any motor vehicle and can cause serious personal injury ⇒ *Working in the engine compartment*.

NOTE

- a) Displayed in color on an instrument cluster with color display.
- b) A separate display appears in the instrument cluster if there is an AFS malfunction.

Instrument cluster

Introduction to the subject

In this chapter you will find information on the following subjects:

⇒ *Instrument overview*

⇒ *Displays*

⇒ *Service reminder display*

WARNING

Driving on today's roads demands the full attention of the driver at all times. Driver distraction causes accidents, collisions and serious personal injury!

- Never use the buttons in the instrument cluster while driving.

Instrument overview



Fig. 10 Instrument cluster in the instrument panel (Golf models).



Fig. 11 Instrument cluster in the instrument panel (Golf GTI, Golf R models).



Read and follow the introductory information and safety information first ⇒ [Introduction to the subject](#)

Instrument explanations ⇒ [Fig. 10](#) or ⇒ [Fig. 11](#) :

- ① Speedometer .
- ② Tachometer (thousands of revolutions per minute when the engine is running).
The red zone at the end of the scale indicates maximum permissible engine rpm (revolutions per minute) for all gears after the break-in period. Before reaching the red zone, select the next higher gear or selector lever position D/S, or ease your foot off the accelerator ⇒ .
- ③ Displays ⇒ [Displays](#) .
- ④ Reset, set, and display button ⇒ [Displays](#) .
- ⑤ Fuel gauge ⇒ [Refueling](#) .
- ⑥ Engine coolant temperature gauge ⇒ [Engine coolant](#) .

NOTE

- To help prevent engine damage, always avoid high engine speeds, full throttle acceleration, and heavy engine loads when the engine is cold.
- To help prevent engine damage, the tachometer needle should only enter the red zone (warning zone) briefly, for example, when accelerating rapidly.



Upshifting early into the next higher gear saves fuel and reduces engine noise.

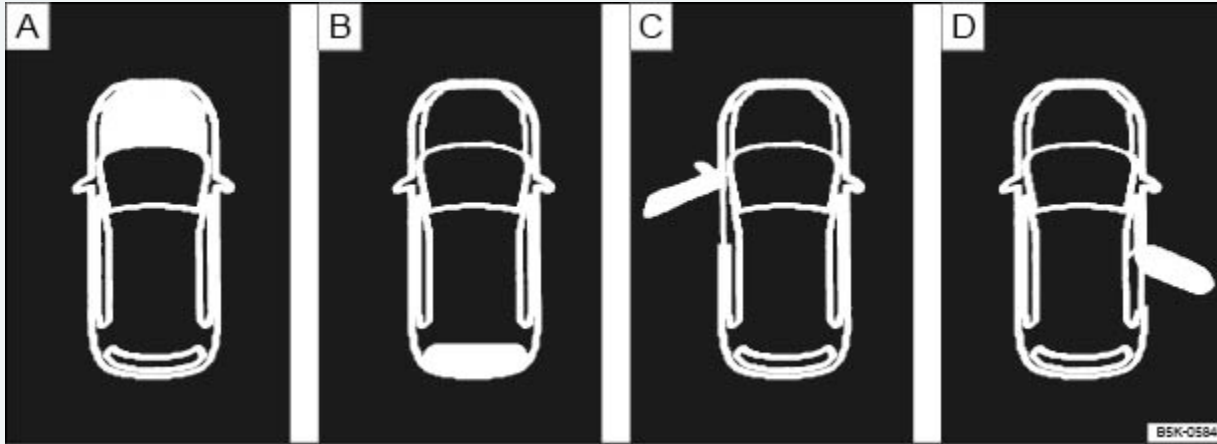


Fig. 12 In the instrument cluster display (black and white version): : Open engine hood, : Open trunk lid, : Open front driver side door, : Open rear passenger side door.

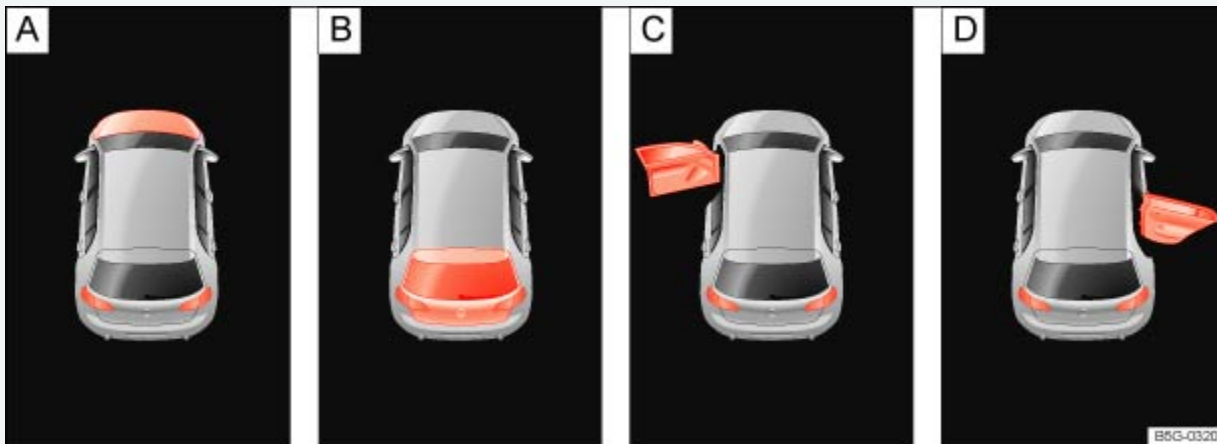


Fig. 13 In the instrument cluster display (color version): : Open engine hood, : Open trunk lid, : Open front driver side door, : Open rear passenger side door.



Read and follow the introductory information and safety information first ⇒ [Introduction to the subject](#)

Depending on vehicle equipment, different information may be shown in the instrument cluster display.



- Open doors, engine hood, or trunk lid ⇒ [Fig. 12](#) or ⇒ [Fig. 13](#)
- Warning and information texts
- Odometer displays
- Time
- Outside temperature

- Selector lever position ⇒ *Shifting*
- Gear recommendation ⇒ *Shifting*
- Driving data and menus for different settings ⇒ *Volkswagen Information System*
- Service reminder display ⇒ *Service reminder display*
- Engine code
- Radio and navigation information ⇒ *Booklet/Infotainment System,*
- Telephone information ⇒ *Booklet/Infotainment System,*

Open doors, hood, or trunk lid

The instrument cluster display indicates if any doors, the engine hood, or trunk lid are open once the vehicle has been unlocked, and while the vehicle is in motion. There may also be an audible warning chime. Different models and equipment versions may have different displays.

Key to ⇒ *Fig. 12*

<p>A</p>	<p> Stop!</p> <p>The engine hood is open or not properly closed ⇒ <i>Working in the engine compartment.</i></p>
<p>B</p>	<p> Stop!</p> <p>The trunk lid is open or not properly closed ⇒ <i>Trunk lid.</i></p>



C, D

 Stop!



One or more vehicle doors open or not properly closed ⇒ *Doors*.

Warning and information texts


The status of various vehicle functions and components is monitored when the ignition is switched on and while driving. Malfunctions are indicated by red and yellow warning symbols with text messages in the instrument cluster display (⇒ *Warning and indicator lights*). In some cases, they may also be signaled acoustically. The display can vary depending on the instrument cluster model.

Type of notification	Symbol color ^{a)}	Explanation
----------------------	----------------------------	-------------



Icon	Color	
Priority 1 warning message	Red	<p>Symbol flashing or lit – sometimes with acoustic warnings.</p> <p> Stop! ⇒ .</p> <p>Check malfunction and take corrective action. Contact an authorized Volkswagen dealer or an authorized Volkswagen Service Facility for assistance if necessary.</p> <p>Menus cannot be accessed when a priority 1 warning message is displayed. The warning message will turn off automatically after a few seconds. You can confirm and turn off some warning messages by pressing the OK/RESET button on the windshield wiper lever or the OK button on the multi-function steering wheel.</p>



Icon	Color	Description
Priority 2 warning message	Yellow	<p>Symbol flashing or continuously lit – sometimes with acoustic warnings.</p> <p>Malfunctions or low operating fluid levels may cause vehicle damage and vehicle breakdown ⇒ .</p> <p>Check malfunction as soon as possible. Contact an authorized Volkswagen dealer or an authorized Volkswagen Service Facility for assistance if necessary.</p>
Information text	-	Information about various vehicle situations.

Odometer displays

The *odometer* at the bottom left corner of the instrument cluster display indicates the total distance driven by the vehicle.

The *trip odometer* (trip) shows the distance driven since the last time the trip odometer was reset. The last digit indicates 1/10 mile (or 100 meters, depending on the units selected).

Press the **0.0** button in the instrument cluster briefly ⇒ [Instrument overview](#) to reset the trip odometer to 0.


Time

- If a vehicle status message or the vehicle icon is displayed, push the **OK/RESET** button on the windshield wiper lever or the **OK** button on the right side of the multi-function steering wheel.





until the word Time appears in the display. If the ignition is switched off, the doors must be closed.

- Release the button. The time is shown in the instrument cluster display and the hour setting is highlighted.
- Press the **0.0** button repeatedly until the correct hour is displayed. Press and hold the button to scroll through quickly.
- Once you have set the hour, release the button and wait a few seconds until the minutes display is highlighted.
- Press the **0.0** button repeatedly until the correct minutes are displayed. Press and hold the button to scroll through quickly.
- Release the button to finish setting the clock.

You can also set the time in the Infotainment system when the ignition is switched on by pressing the **CAR** button followed by the  and Time and date function keys ⇒ [Menu and system settings](#).

Outside temperature display

At outside temperatures below about +39 °F (+4 °C), a snowflake symbol  appears in the display. The symbol remains on until the outside temperature rises above +43 °F (+6 °C) ⇒ .

When the vehicle is not moving or when you are driving at very low speeds, the temperature displayed may be slightly higher than the actual outside temperature.

The measurement range is from -49 °F (-45 °C) to +169 °F (+76 °C).

Compass display

On vehicles equipped with a compass display, the current compass direction is indicated in the instrument cluster display when the ignition (or the navigation system, if equipped) is switched on.

Selector lever position (automatic transmission)

The selector lever position is shown both on the side of the selector lever and in the instrument cluster display. The respective gear may be shown in the instrument cluster display in Tiptronic® mode ⇒ [Shifting](#).


Gear recommendation



cluster display ⇒ [Shifting](#) .

Speed warning

A display in the instrument cluster indicates when the set maximum speed has been exceeded ⇒ [Volkswagen Information System](#) .

The speed warning can also be set and changed in the Infotainment system when the ignition is switched on by pressing the **CAR** button followed by the  and Tires function keys ⇒ [Menu and system settings](#) .

Engine identification code

Press and hold the **0.0** button in the instrument cluster ⇒ [Instrument overview](#) for about 15 seconds to display the vehicle's engine identification code. You must do this when the doors are closed, the ignition is on, but the engine is not running.

WARNING

Failure to heed warning lights and instrument cluster text messages can cause the vehicle to break down in traffic and result in a collision and serious personal injury.

- Never ignore warning lights or text WARNINGS.
- Always stop the vehicle as soon as it is safe to do so.
- Park the vehicle at a safe distance from moving traffic and where no part of the hot catalytic converter and exhaust system can come into contact with flammable materials under the vehicle, such as dry grass, brush, spilled fuel, etc.
- A broken down vehicle presents a high accident risk for itself and others. Switch on emergency flashers and set up a warning triangle to warn oncoming traffic.

WARNING

Roads and bridges may be dangerously icy even if the outside air temperature is above freezing.

- If you use the outside temperature display to tell you about frost conditions, remember that roads can even ice over at temperatures above +39 °F (+4 °C). Always remember: even if the snowflake symbol is not displayed, there could still be black ice on the road.



NOTE

Failure to heed warning lights or text WARNINGS can result in vehicle damage.



The instrument cluster displays and their arrangement may vary depending on the vehicle model and engine. For displays without warning and information messages, malfunctions are only signaled with indicator lights.



Depending on vehicle equipment, some settings and displays may also appear in the Infotainment system.



If there are multiple warning messages, the symbols are displayed for several seconds in order of importance. The symbols are displayed until the cause has been corrected.



If warning messages are displayed when the ignition is switched on, it may not be possible to adjust some settings as described, or the information display may appear differently. If this happens, take the vehicle to an authorized Volkswagen dealer or an authorized Volkswagen Service Facility for assistance.

^{a)} Displayed in color on an instrument cluster with color display.

Service reminder display

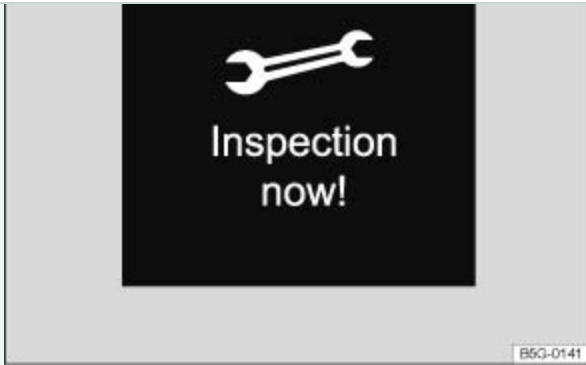


Fig. 14 In the instrument cluster display: Example of the service reminder when a service is due.

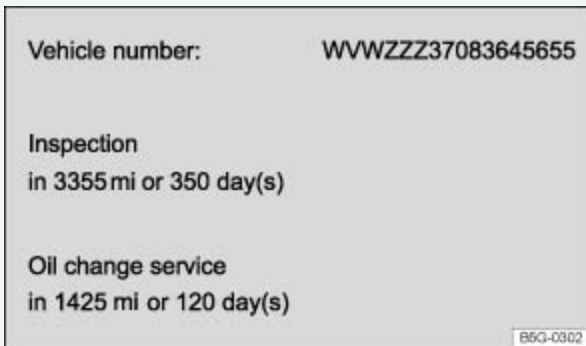


Fig. 15 In the Infotainment system display: Example of the service reminder.



Read and follow the introductory information and safety information first ⇒ [Introduction to the subject](#)

The maintenance service reminder is shown in the instrument cluster display ⇒ [Fig. 14](#) and in the Infotainment system ⇒ [Fig. 15](#). Versions and displays can vary depending on the instrument cluster or the Infotainment system version equipped with the vehicle.

For information on maintenance intervals, please see the ⇒ [Booklet Warranty and Maintenance](#).


For vehicles with time- or distance driven-dependent service , only fixed service intervals are displayed.

Service reminder

If service is due in the near future, a service reminder is displayed when the ignition is switched on.

The number of miles (km) and amount of time shown correspond to the maximum number of miles (km) or maximum time that can still be driven before the next service.




For a scheduled oil service or a scheduled inspection there is an audible chime when the ignition is switched on. The wrench symbol  also appears for several seconds in the instrument cluster display along with one of the following messages ⇒ [Fig. 14](#):

Oil service now!

Inspection now!

Oil service and inspection now!

Viewing service message

You can view service information ⇒ [Fig. 15](#) in the Infotainment system by pressing the **CAR** button followed by the  and Service function keys ⇒ [Menu and system settings](#).

The current service message can also be accessed in the instrument cluster display when the ignition is switched on and the vehicle is stopped:

- Press and hold the **0.0** button in the instrument cluster ⇒ [Instrument overview](#) until the word Service appears in the display.
- Release the button. The current service message appears in the display for a few seconds.

Resetting the service reminder display

If the service was not performed by an authorized Volkswagen dealer or an authorized Volkswagen Service Facility, the service reminder can be reset as follows:

- Switch off the ignition.
- Press and hold the **0.0** button in the instrument cluster ⇒ [Instrument overview](#).
- Switch on the ignition.
- Release the **0.0** button.
- One after the other, the following messages appear in the display:



Reset inspection interval?

- When you see the message for the interval you want to reset (either oil change or inspection), confirm the request by pressing the **0.0** button in the instrument cluster. A confirmation message appears in the display when the service reminder has been reset.



Do not reset the service reminder between service intervals; otherwise, incorrect information will be displayed.

Volkswagen Information System



Introduction to the subject

In this chapter you will find information on the following subjects:

⇒ *Using the instrument cluster menus*

⇒ *Driver assistance systems button*

⇒ *Menu structure – overview*

⇒ *Main menu*

⇒ *Driving data*

⇒ *Assist systems menu*

⇒ *Lap timer*

When the ignition is switched on, you can display different types of information in the instrument cluster and control certain vehicle features.

Your vehicle is equipped with controls either on the windshield wiper lever ⇒ [Fig. 16](#) or steering wheel ⇒ [Fig. 17](#). Vehicles equipped with a multi-function steering wheel do not have buttons on the

wiper lever are not equipped with controls on the steering wheel.

The number of menus and information in the instrument cluster display depends on the electronics and equipment on the vehicle.

An authorized Volkswagen dealer or an authorized Volkswagen Service Facility may be able to add or modify functions depending on your vehicle's equipment.

As long as a priority 1 warning message is displayed, no menus can be accessed. To display menus, acknowledge the warning by pressing the **OK/RESET** button on the windshield wiper lever ⇒ [Fig. 16](#) or the **OK** button on the multi-function steering wheel ⇒ [Fig. 17](#).

WARNING

Driving on today's roads demands the full attention of the driver at all times. Driver distraction causes accidents, collisions and serious personal injury!

- Never access menus when the vehicle is moving.



Emergency starting and starting the engine with a very weak vehicle battery or after the vehicle battery has been replaced may change or delete system settings (including time, date, and programming). Check the settings and correct as necessary once the vehicle battery has built up a sufficient charge.

Using the instrument cluster menus

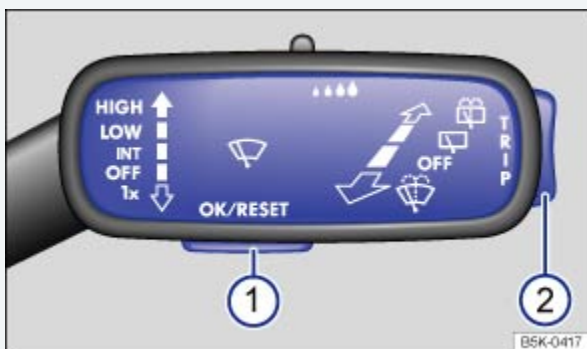


Fig. 16 On the right side of the steering column (vehicles without a multi-function steering wheel): Windshield wiper lever with controls for instrument cluster menus and displays.



Fig. 17 Right side of the multi-function steering wheel (if equipped): Controls for the menus and information in the instrument cluster display.

Read and follow the introductory information and safety information first ⇒ [Introduction to the subject](#)

If your vehicle does not have a multi-function steering wheel with menu controls, the instrument cluster menus are controlled with buttons on the windshield wiper lever (⇒ [Fig. 16](#)). On vehicles with a multi-function steering wheel, the instrument cluster menus are controlled with buttons on the right side of the steering wheel (⇒ [Fig. 17](#)).

Accessing the instrument cluster menus and information displays

- Switch on the ignition.
- If a message or the vehicle icon is displayed, push the **OK/RESET** button (⇒ [Fig. 16](#)) on the windshield wiper lever or the **OK** button (⇒ [Fig. 17](#)) on the right side of the multi-function steering wheel until a main menu appears in the instrument cluster display. For a list of main menus, see ⇒ [Menu structure - overview](#).
- *For operation with windshield wiper lever:* To show the main menu or to go back to the main menu from another menu, press and hold the rocker switch ⇒ [Fig. 16](#).
- *For operation with multi-function steering wheel:* Push buttons or to move to another main menu, and push the arrow up and down buttons and to navigate within the current main menu.

To open the menu or information display shown in the selection menu, press the **OK/RESET** button on the windshield wiper lever or the **OK** button on the multi-function steering wheel, or wait until the menu or information display opens automatically after a few seconds.

Selecting a setting

through the available options, then press the **OK/RESET** button ① to select a setting.

- *Multi-function steering wheel:* Use the arrow up and down buttons Δ or ∇ on the multi-function steering wheel \Rightarrow [Fig. 17](#) to navigate through the available options. A frame may appear around the selected option. Push the **OK** button to select a setting.

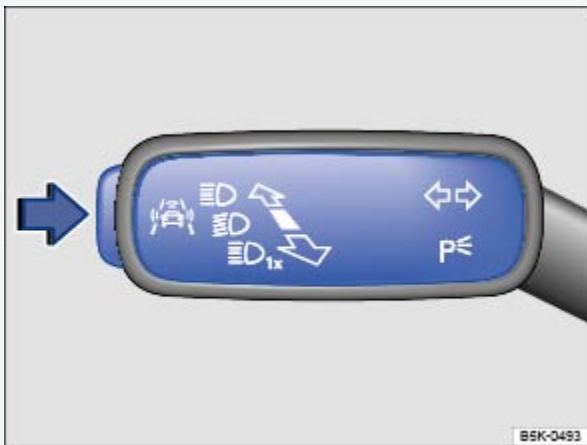
Returning to the main menu

- *Windshield wiper lever:* Use the rocker switch \Rightarrow [Fig. 16](#) to select Back.
- *Multi-function steering wheel:* Press the or button \Rightarrow [Fig. 17](#).



If warning messages are displayed when the ignition is switched on, it may not be possible to adjust some settings as described, or the information display may appear differently. If this is the case, take the vehicle to an authorized Volkswagen dealer or an authorized Volkswagen Service Facility for assistance.

Driver assistance systems button



[Fig. 18](#) On the turn signal and high beam lever: Driver assistance systems button.






Read and follow the introductory information and safety information first \Rightarrow [Introduction to the subject](#)

Your vehicle may have a driver assistance systems button, which allows you to switch the driver assistance systems on or off in the Assist systems menu using the button on the turn signal lever.

Switching individual driver assistance systems on or off




- Using the arrow up and down buttons  or  on the multi-function steering wheel, select the driver assistance system (for example, Lane Assist, if equipped). A check mark indicates if the selected driver assistance system is switched on.
- Confirm the selection by pressing the **OK** button on the multi-function steering wheel.

On appropriately equipped vehicles, you can switch driver assist systems on and off in the infotainment system by pressing the **CAR** button followed by the  and Driver Assist function keys ⇒ [Menu and system settings](#).

Menu structure – overview



Read and follow the introductory information and safety information first ⇒  [Introduction to the subject](#)

The following list shows how the Volkswagen information system menus in the instrument cluster display are structured. The size and layout of the Volkswagen information system menu depends on the vehicle electronics and the vehicle equipment.

- Driving data ⇒ [Driving data](#)
 - Travel time
 - Energy consumers
 - Range
 - \emptyset economy (average fuel consumption)
 - Economy (fuel consumption)
 - Oil temperature
 - Warning at
 - Speed (digital)
 - \emptyset speed (average speed)
 - Distance
- Assist systems ⇒ [Assist systems menu](#)
 - Lane Assist



- Rear Traffic
- Front Assist
- Back
- Navigation ⇒ Booklet *Infotainment System*,
- Audio ⇒ Booklet *Infotainment System*,
- Telephone ⇒ Booklet *Infotainment System*,
- Vehicle ⇒ [Main menu](#)
- Lap timer (if equipped) ⇒ [Lap timer](#)

Main menu



Read and follow the introductory information and safety information first ⇒ [Introduction to the subject](#)

Main menu	Function	See
Driving data	Multifunction Display (MFD) information and settings.	⇒ Driving data
	Display of current warning or information messages and other system components depending on the equipment level.	⇒ Menu and system settings
Assist systems	Turn selected driver assistance systems on or off, or view current status for active driver assistance systems.	⇒ Assist systems menu
Compass	Current driving direction (vehicles without navigation system).	⇒ Displays





Navigation	Information displays for the navigation system (if equipped).	⇒Booklet <i>Infotainment System</i> ,
	When route guidance is active, turn arrows and proximity bars similar to the symbols shown in the navigation system are displayed.	
	If route guidance is turned off, the direction of travel (compass) and the current street name are displayed.	
Audio	Station display or station list in radio mode.	⇒Booklet <i>Infotainment System</i> ,
	Track display in media mode.	
Telephone	Information about the connected telephone.	⇒Booklet <i>Infotainment System</i> ,
	Settings and information when using the telephone.	
Vehicle	Current warning and information messages.	⇒ <i>Instrument cluster</i>
	This menu item only appears when warning or information messages are available.	





Lap timer	Time your own laps on a track, store the data, and compare with previous best times.	⇒ <i>Lap timer</i>
-----------	--	--------------------

Driving data

 Read and follow the introductory information and safety information first ⇒  *Introduction to the subject*

When the ignition is on, the Driving data menu provides a variety of travel and fuel consumption data. Navigate through the data as described on ⇒ *Using the instrument cluster menus*.

Switching between the displays

- *Vehicles without a multi-function steering wheel:* Press the rocker switch **TRIP** on the windshield wiper lever ⇒ *Fig. 16*.
- *Vehicles with a multi-function steering wheel:* Use the arrow up and down buttons ( and ) on the right side of the steering wheel ⇒ *Fig. 17*.

Trip memories

The display has 3 automatic memories:

- Since start
- Extend. period
- Since refuel

The currently selected memory is shown in the display.

The trip memories are in addition to the trip odometer, which is displayed in the bottom part of the instrument cluster and controlled using the **0.0** button ⇒ *Fig. 10* or ⇒ *Fig. 11*.

Press the **OK/RESET** button on the windshield wiper lever or the **OK** button on the multi-function steering wheel to toggle between the 3 memories when the ignition is on.

The driving data for the trip memories can also be viewed in the Infotainment system by pressing the




1	Since start	<p>The memory accumulates and stores information about distance driven and fuel used from the time the ignition was switched on until the time it was switched off.</p>
		<p>If the ignition stays off for 2 hours or more, stored information is automatically deleted. If the trip is continued within 2 hours after the ignition was switched off, the new values are added.</p>
2	Extend. period	<p>Depending on the instrument cluster version, the memory displays and stores the accumulated driving and fuel consumption data of any number of single trips up to a total driving time of either 19 hours and 59 minutes or 99 hours and 59 minutes, and up to a total distance of either 1,999 km or 9,999 km. If one of the maximum values^{a)} is exceeded, then the memory is automatically cleared and starts again from 0.</p>
3	Since re-fuel	<p>The memory accumulates and stores information about distance driven and fuel used from the time the vehicle is refueled. The memory is deleted automatically during refueling.</p>

Manually erasing a trip memory

- Select the memory to be erased.
- Press and hold the **OK/RESET** button on the windshield wiper lever or the **OK** button on the multi-



Enabling and disabling displays

You can set which displays should appear in the instrument cluster by pressing the **CAR** button followed by the  and Instrument cluster function keys in the Infotainment system ⇒ [Menu and system settings](#). The units in which data is displayed can also be changed.

Possible driving data menu displays

Display	Function
Travel time	Driving time in hours (h) and minutes (min) corresponding to trip memories 1, 2, and 3 (toggle).
Energy consumers	Displays any convenience equipment in the vehicle that is currently affecting fuel consumption in gallons per hour (or liters per hour).
Eco tips	Displays tips for better fuel economy.
Range  -- mi	Estimated distance in miles (km) that the vehicle can go with the fuel left in the tank the way you are currently driving. Takes account of the current fuel consumption, among other things.
Range  -- km	
 economy --.- mpg	Average fuel consumption in miles per gallon (l/100 km) on trips per trip memories 1, 2, and 3 (toggle). For the since start trip memory, the value is displayed once the vehicle has been driven about 330 feet (100 m). Until then, dashes ap-



<p>Ø economy</p> <p>--- l/100km</p>	<p>pear instead of a number. The value displayed is updated every second.</p>
<p>Economy</p> <p>--- mpg</p>	<p>Current fuel consumption in miles per gallon (l/100 km) while driving.</p> <p><i>When units are set to miles, dashes appear instead of a number when the engine is running and the vehicle is standing still.</i></p>
<p>Economy</p> <p>--- l/100km</p>	<p><i>When units are set to kilometers, the display shows liters consumed per hour when the engine is running and the vehicle is standing still.</i></p>
<p>Oil temperature</p> <p>--- °F</p>	<p>Digital display of the current engine oil temperature.</p>
<p>Oil temperature</p> <p>--- °C</p>	
<p>Warning at</p> <p>--- mph</p>	<p>When the set speed (from 20–160 mph or 30–250 km/h) is exceeded, an acoustic warning sounds and a visual message may also appear in the instrument cluster display.</p>



Warning at --- km/h	
Speed --- mph	Digital display of the current vehicle speed.
Speed --- km/h	
∅ speed -- mph	
∅ speed -- km/h	Average speed on trips per trip memories 1, 2, and 3 (toggle). For the since start trip memory, the value is displayed once the vehicle has been driven about 300 feet (100 m). The value displayed is updated every 5 seconds.
Distance --- mi	Distance driven in miles (km) per trip memories 1, 2, and 3 (toggle).



Distance --- km	
-----------------	--


Storing speed for the speed warning

- Select the Warning at display.
- Press the **OK/RESET** button on the windshield wiper lever or the **OK** button on the multi-function steering wheel to save the current speed and to activate the warning.
- If necessary, set the desired speed within about 5 seconds with the **TRIP** rocker switch on the windshield wiper lever or the **△** or **▽** buttons on the multi-function steering wheel. Then press the **OK/RESET** button on the windshield wiper lever or the **OK** button on the multi-function steering wheel a second time or just wait a few seconds. The speed is saved and the warning is activated.
- *To deactivate*, press the **OK/RESET** button on the windshield wiper lever or the **OK** button on the multi-function steering wheel. The set speed is deleted.

a) May differ depending on the instrument cluster version.

Assist systems menu



Read and follow the introductory information and safety information first ⇒  *Introduction to the subject*


Assist systems menu	Function
Lane Assist	Switch the Lane Assist system on or off (if equipped) ⇒ <i>Lane Keeping System (Lane Assist)</i> .
Blind Spot	Switch the Blind Spot monitor on or off (if equipped) ⇒ <i>Blind Spot Monitor with Rear Traffic Alert</i> .



Rear Traffic	Switch the Rear Traffic Alert on or off (if equipped) ⇒ <i>Blind Spot Monitor with Rear Traffic Alert</i> .
Front Assist	Switch the Front Assist system on or off (if equipped) ⇒ <i>Forward Collision Warning (Front Assist)</i> .

Lap timer



Read and follow the introductory information and safety information first ⇒  *Introduction to the subject*



Your vehicle may be equipped with a lap timer that you can control via the main menu in the instrument cluster ⇒ *Using the instrument cluster menus*.

With the lap timer, you can time your own laps manually, store lap times, and compare the times to one another.

The following menus can be displayed:

- Lap timer
- Lap 1 (or current lap number)
- Statistics

Switching between the menus

- Press the  or  button on the multi-function steering wheel ⇒ *Fig. 17*.

Menu	Submenu	Function
------	---------	----------



Lap timer	Start	<p>Timing starts.</p> <p>If laps have already been completed and are recorded in the statistics, timing will start from the next lap.</p> <p>A new first lap can only be started if the statistics are reset in the Statistics menu.</p>
	Since start	<p>Timing starts when the vehicle begins driving.</p> <p>If the vehicle is already in motion, timing will begin after the vehicle has come to a temporary stop.</p>
	Statistics	<p>Statistics display in the menu.</p>
Lap 1 (or current lap number)	Stop	<p>Active timing is interrupted. This will not end the lap.</p>
	New lap	<p>Timing of the current lap is interrupted and a new lap begins. The time of the completed lap is carried over to the statistics.</p>



	Split time	A split time displays for about 5 seconds. Active timing continues in parallel.
	Resume	Paused timing resumes.
	Stop lap	Timing of the active lap ends and the lap is deleted. It is not entered into the statistics.
	End	Active timing stops. The lap is automatically entered into the statistics.
Statistics	-	Overview of lap times most recently recorded: - Fastest time - Slowest time - Average - Total time



	-	<p>A maximum of 99 laps and a maximum overall duration of 99 hours, 59 minutes, and 59 seconds can be recorded.</p> <p>If one of the two limits is reached, timing can only start again after the statistics are reset.</p>
	Back	Go back to the previous menu.
	Reset	All stored statistics data is reset.

WARNING

Driving on today's roads demands the full attention of the driver at all times. Driver distraction causes accidents, collisions and serious personal injury!

- Never set the lap timer when the vehicle is moving.

WARNING

Rapid acceleration can cause skidding and loss of traction, especially on slippery roads, resulting in a loss of vehicle control, collisions, and serious personal injury.

- Only use the lap timer or fast acceleration if visibility, weather, road, and traffic conditions permit and other drivers will not be endangered by your driving and the vehicle's acceleration.

NOTE

To help prevent engine damage, always avoid high engine speeds, full throttle acceleration, and heavy engine loads when the engine is cold.



Menu and system settings



Introduction to the subject

In this chapter you will find information on the following subjects:


⇒ *Vehicle settings menu*

General information on operating the unit

The following section contains information on the settings that can be adjusted in the Vehicle settings menu. You can find information on operating the Infotainment system as well as warning and safety instructions in a separate manual. See ⇒ Booklet *Infotainment System*,

Vehicle settings and information

After pressing the **CAR** Infotainment button, you can tap the corresponding function key on the Infotainment screen to display information or adjust the following settings:

- Selection (Vehicle information)
 - Sport (Performance Monitor) ⇒ *Performance Monitor*
 - Energy consumers ⇒ *Driving data*
 - Driving data (Since start, extend. period, since refuel) ⇒ *Driving data*
 - Think Blue. Trainer. ⇒ *Think Blue. Trainer.*
 - Vehicle status (Current warning and information messages) ⇒ *Main menu*
- Radio or Media (Radio station or media selection) ⇒ Booklet *Infotainment System*,
-  (Vehicle settings) ⇒ *Vehicle settings menu*

WARNING

Driving on today's roads demands the full attention of the driver at all times. Driver distraction causes accidents, collisions and serious personal injury!

- Never let yourself be distracted when setting, adjusting, or using the Infotainment system.
- Always drive attentively and responsibly. Use the Infotainment system only if road, traffic, and




After starting the engine with a discharged vehicle battery, or after the battery has been changed, system settings (time, date, and programming) may have been changed or deleted. Check and correct the settings as necessary once the vehicle battery has been sufficiently charged.

Vehicle settings menu




Read and follow the introductory information and safety information first ⇒ [Introduction to the subject](#)

Opening the Vehicle settings menu

- Switch on the ignition.
- If necessary, switch on the Infotainment system.
- Press the **CAR** Infotainment button.
- Tap the  function key to open the Vehicle settings menu.
- Tap the corresponding function key to open additional menus in the Vehicle settings menu, or to adjust settings in the menu points.

If the box in the function key is checked , the function is switched on.

Changes made in settings menus are automatically applied immediately after entry.

Tapping the  function key takes you back to the previous menu.

Menu overview

The following menu overview is an example of the Infotainment system menu structure. The size and layout of the Volkswagen information system menu depends on the vehicle electronics and the level of vehicle equipment.

Menu	Submenu	Setting options	See
------	---------	-----------------	-----



ESC system	-	Turn the following systems on or off: - Anti-slip regulation (ASR) - ESC sport mode (ESC Sport) - ESC off (Golf R only)	⇒ <i>Braking and park- ing</i>
Tires	Tire Pressure Monitoring System	Store the tire pressures (SET)	⇒ <i>Tire Pressure Monitoring System (TPMS)</i>
	Winter tires	Turn the speed warning on or off Set the speed warning	⇒ <i>Tires and wheels</i>



Lights	Light Assist	<p>Turn the following systems on or off (if equipped):</p> <ul style="list-style-type: none">- Light Assist- Adaptive front lighting (AFS)- Automatic headlights during rain (headlights turn on with the rain sensor when the headlight switch is in AUTO position)- Convenience indicating (lane change feature)	⇒ <i>Lights</i>
		<p>Adjust the following feature (if equipped):</p> <ul style="list-style-type: none">- Turn-on time for automatic headlights (AUTO)	



	Interior lighting	Adjust the following features (if equipped): - Door ambient lighting - Footwell lighting	
	Coming/Leaving home function	Set the following (if equipped): - Duration that the Coming Home feature is switched on - Duration that the Leaving Home feature is switched on	
Assistance systems	ACC (adaptive cruise control)	Select the drive program (Eco, Comfort, Normal, Sport).	<i>⇒ Adaptive Cruise Control (ACC)</i>



	<p>Front Assist (Forward Collision Warning)</p>	<p>Turn the following features on or off (if equipped):</p> <ul style="list-style-type: none">- Front Assist- Advance warning- Display distance warning	<p>⇒ <i>Forward Collision Warning (Front Assist)</i></p>
		<p>Adjust the warning period for the advance warning (Early, Medium, Late)</p>	
	<p>Lane Assist</p>	<p>Turn Lane Assist on or off (if equipped)</p>	<p>⇒ <i>Lane Keeping System (Lane Assist)</i></p>



	Blind Spot Monitor	Turn the Blind Spot Monitor on or off (if equipped)	<i>⇒ Blind Spot Monitor with Rear Traffic Alert</i>
Parking and maneuvering	ParkPilot	Turn automatic ParkPilot (PDC) activation on or off (if equipped)	<i>⇒ Park Distance</i>



		<p>Adjust the following:</p> <ul style="list-style-type: none">- Front volume- Front pitch- Rear volume- Rear pitch- Audio volume lowering	<p><i>Control (PDC)</i></p>
	Rear Traffic Alert	<p>Turn the Rear Traffic Alert on or off (if equipped)</p>	<p><i>⇒ Blind Spot Monitor with Rear Traffic Alert</i></p>



Mirrors and wipers	Mirrors	Turn the following features on or off: – Synchronous mirror adjustment (if equipped) – Passenger side mirror lowering in reverse gear (if equipped)	⇒ <i>Mirrors</i>
	Windshield wipers	Turn the following features on or off: – Automatic wiping during rain (rain sensor) – Wipe rear window in reverse gear	⇒ <i>Windshield wipers and washer</i>
Opening and closing	Window operation	Turn the convenience opening feature for the power windows on or off (if equipped)	⇒ <i>Power windows</i>
	Central locking	Set door unlocking	⇒ <i>Power</i>



Turn the following features on or off:

- Lock automatically (Auto lock feature)

- Acoustic confirmation (horn beep after the vehicle is locked from outside)

locking

system



Instrument cluster	-	<p>Display or hide the following data in the Multifunction display:</p> <ul style="list-style-type: none">- Current economy (fuel consumption)- Average economy (fuel consumption)- Energy consumers- Eco tips- Travel time- Distance traveled- Average speed- Digital speed display	<p>⇒ Volkswagen Information System</p>
--------------------	---	---	--



		<ul style="list-style-type: none">- Speed warning- Oil temperature	
	<ul style="list-style-type: none">-	<p>Reset the following data in the Multifunction display:</p> <ul style="list-style-type: none">- Driving data for Since start trip memory- Driving data for Extended period trip memory	



Time and date	-	<p>Select and set the following data:</p> <ul style="list-style-type: none">- Clock time source (manual, GPS) - Time - Daylight savings time - Time zone - Time format (12 hour, 24 hour) - Date - Date format	-
---------------	---	--	---



Units	-	Set the units for the following: - Distance - Speed - Temperature - Volume - Economy (fuel consumption) - Pressure	-
-------	---	--	---



Service	-	<p>Display the following data:</p> <ul style="list-style-type: none">- Vehicle identification number (VIN)- Number of miles (km) and days until next inspection service is due- Number of miles (km) and days until next oil change service is due	<p>⇒ <i>Instrument cluster</i></p>
---------	---	--	------------------------------------



Factory settings	-	Reset the following features: - All settings - Lights - Assistance systems - Parking and maneuvering - Mirrors and wipers - Opening and closing - Instrument cluster	-
------------------	---	---	---

VW Car-Net®

VW Car-Net: Connecting you and your vehicle



[Introduction to the subject](#)



⇒ *VW Car-Net Security & Service*

⇒ *Features*

⇒ *Application software (“apps”)*

⇒ *3-button module*

VW Car-Net[®] services are provided by Verizon Telematics, Inc. (VzT) and are available only on select models. Automatic Crash Notification (ACN) may be engaged for up to 6 months without activating a trial or paid subscription; Manual Emergency Call service and all other VW Car-Net services require a trial or paid subscription. VW Car-Net may collect location information. See applicable Terms of Service and Privacy Policy available at www.vw.com/carnet for details.

Data Collection and Privacy

Vehicle location information is transmitted to Volkswagen and our VW Car-Net service provider, Verizon Telematics, Inc. (VzT), anytime you press a VW Car-Net in-car button, when an ACN event occurs or periodically in connection with the operation of VW Car-Net.

Unless VW Car-Net equipment is disabled in the vehicle, it is possible for Volkswagen and VzT to determine the car’s location if required to do so by law, court order, subpoena or other legal requirement. For more information, please contact the VW Car-Net Response Center at 1-877-820-2290.

Calls may be monitored or recorded.

Volkswagen collects, processes, transmits, uses, and shares information about you and your vehicle in accordance with the VW Car-Net Terms of Service and Privacy Policy. See the VW Car-Net Terms of Service and Privacy Policy at (<http://www.vw.com/carnet>) for more details.

WARNING

Application software and VW Car-Net services that are unsuitable or improperly used can cause accidents, serious personal injury and vehicle damage.

- VW Car-Net services can be used only where adequate cellular and GPS signals are available.
- Volkswagen recommends using only services and application software that are provided by Volkswagen or Verizon Telematics, Inc. (VzT) specifically for your vehicle.



- Never modify application software and VW Car-Net services.
- Always read and heed the operating instructions for the mobile device.


WARNING

Driver distraction causes accidents, collisions and serious personal injury! Using application software and VW Car-Net services while driving can distract the driver from traffic.

- Always drive attentively and responsibly.

VW Car-Net Security & Service



Read and follow the introductory information and safety information first ⇒  [Introduction to the subject](#)

Your vehicle has equipment to enable VW Car-Net, a suite of connected vehicle services that makes driving and owning a Volkswagen vehicle more convenient. VW Car-Net allows you to seamlessly connect your car and your life by offering the following services:

- Safe & Secure – Receive support and assistance in the moment of need.
- Family Guardian – Keep track of family members driving your vehicle.
- Remote Vehicle Access – Interact with your vehicle through your VW Car-Net iPhone® or Android® app, computer or a VW Car-Net Customer Specialist (text and data rates apply).
- Diagnostics & Maintenance – Manage your vehicle health with diagnostic checks and service scheduling.

You can access VW Car-Net Security & Service via your VW Car-Net iPhone® or Android® app (text and data rates apply) and the VW Car-Net Security & Service website (<http://www.vw.com/carnet>). If you have a question or would like to subscribe, please either press the ⇒ [Fig. 21](#) or ⇒ [Fig. 22](#) button in your vehicle or contact the VW Car-Net Response Center at 1-877-820-2290. For more information or to log on to your VW Car-Net Security & Service account, visit <http://www.vw.com/carnet>.

Note: Please review the VW Car-Net Security & Service Terms of Service and Privacy Policy at <http://www.vw.com/carnet>.



Automatic Crash Notification (ACN) may be engaged for up to 6 months, starting from the date of new vehicle sale, without activating a trial or paid subscription.

The Manual Emergency Call service and all other VW Car-Net Security & Service features require a trial or paid subscription. To begin your trial or paid subscription, authentication and activation are required. For more information, please visit the website (<http://www.vw.com/carnet>), press the ⇒ [Fig. 21](#) or ⇒ [Fig. 22](#) button in the 3-button module in your vehicle or contact the VW Car-Net Response Center at 1-877-820-2290.

The LED light in the 3-button module will be green during the trial period and whenever you have an active subscription. The LED light will go off if the trial period is over and the customer has not subscribed to the VW Car-Net services. The LED light will be red only during a VW Car-Net hardware malfunction or fault ⇒ [3-button module](#).

Once a trial or paid VW Car-Net Security & Service subscription has been activated, please advise all who use the vehicle that different kinds of data can be sent and received automatically by the vehicle, including speed, location and more.

WARNING

Vehicle health reports do not replace the information provided by the vehicle warning and indicator lights. Failure to heed warning lights and instrument cluster text messages can cause the vehicle to break down in traffic and result in a collision and serious personal injury.

- Never ignore warning lights or text WARNINGS.
- Always stop the vehicle as soon as it is safe to do so.
- Park the vehicle at a safe distance from moving traffic and where no part of the hot catalytic converter and exhaust system can come into contact with flammable materials under the vehicle, such as dry grass, brush, spilled fuel, etc.
- A broken down vehicle presents a high accident risk for itself and others. Switch on emergency flashers and set up a warning triangle to warn oncoming traffic.
- Before opening the engine hood, always switch off the engine and let the engine cool down.
- Always be very careful when working in the engine compartment, which is a potentially dangerous area in any motor vehicle and can cause serious personal injury.

Failure to heed warning lights or text WARNINGS can result in vehicle damage.



Volkswagen collects, processes, transmits, uses and shares information about you and your vehicle in accordance with the VW Car-Net Terms of Service and Privacy Policy. See the VW Car-Net Security & Service Terms of Service and Privacy Policy at <http://www.vw.com/carnet> for more details.



VW Car-Net Security & Service services use a system based on a wireless communication network. If all technical and other conditions are met and VW Car-Net Security & Service still does not work properly, please try using the service again later.

Features

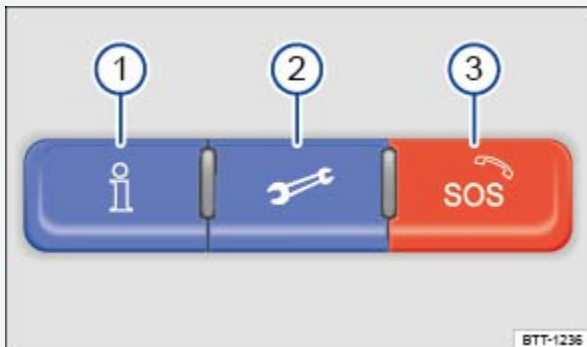


Fig. 19 In the roof console: 3-button module to access VW Car-Net service operators (Version 1).

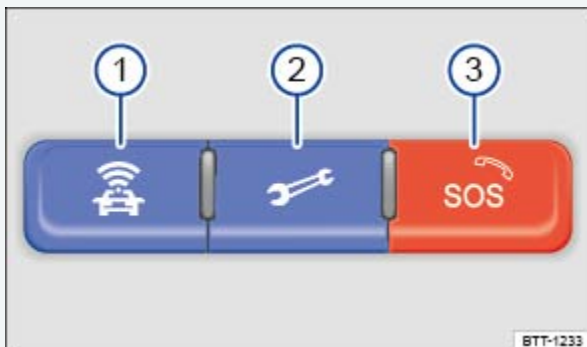


Fig. 20 In the roof console: 3-button module to access VW Car-Net service operators (Version 2).



Read and follow the introductory information and safety information first ⇒ *Introduction to the subject*



through the 3-button module ⇒ *3-button module*, a mobile device ⇒ *Application software ("apps")*, the VW Car-Net Security & Service website (<http://www.vw.com/carnet>) or by contacting the VW Car-Net Response Center at 1-877-820-2290. They are divided into 4 categories: Safe & Secure, Family Guardian, Remote Vehicle Access and Diagnostics & Maintenance Services. Always refer to the VW Car-Net Security & Service website for the most up-to-date information regarding VW Car-Net Security & Service services.

Safe & Secure:

Feature	Description
Automatic Crash Notification (ACN)	Automatic Crash Notification is initiated in the event of airbag deployment or rollover. When the feature is activated the VW Car-Net Response Center is notified of your location and contacts your vehicle to determine the risk of injury and to dispatch help. Help is dispatched even if the VW Car-Net Response Center does not connect to the vehicle's occupants. Automatic Crash Notification may



[Purchase Owner's Literature](#) | [Terms](#) | [Privacy](#)

* This Online Owner's Manual may not include Supplements issued after the publication of the physical Owner's Manual. Please consult your physical Owner's literature. In the event of a discrepancy between the Online Owner's Manual and physical Owner's literature, the physical Owner's literature controls.

"Volkswagen" and the Volkswagen logo are registered trademarks of Volkswagen AG. © 2018 Volkswagen of America, Inc.

Press the button ② in the 3-button module: The vehicle will connect directly to Roadside Assistance the Volkswagen Roadside Assistance Call Center. The vehicle's location is also transmitted in order to more quickly provide assistance.



Feature	Description
Stolen Vehicle	
Location Assistance	
<i>For use by law enforcement authorities only. See Terms of Service at</i>	After you have reported your vehicle as stolen to law enforcement, you may provide the case information to the VW Car-Net Response Center. Once the information has been verified, the VW Car-Net Customer Specialist will be able to provide law enforcement with vehicle location data sent by the VW Car-Net module.
<i>www.vw.com/car-net for details.</i>	

Family Guardian:

Feature	Description
Boundary Alert	By logging on to your VW Car-Net Security & Service account, you can designate an area on a map as a "virtual fence." The vehicle owner can then choose notification channels (text message or email) for receiving alerts when the vehicle crosses the defined boundary (texts and data rates apply).



Feature	Description
Speed Alert	VW Car-Net Security & Service can be configured to inform the vehicle owner whenever the vehicle exceeds a speed set by the owner. The owner can select to be informed through multiple channels, including text messages and email (text and data rates apply).

Remote Vehicle Access:

Feature	Description
Remote Door Unlock	You can send a request to unlock the vehicle doors through your VW Car-Net iPhone [®] or Android [®] app, the VW Car-Net Security & Service website or by calling the VW Car-Net Response Center (text and data rates apply). If none of the vehicle doors are opened within about 30 seconds, the car will lock again.
Remote Door Lock	You can send a request to lock the vehicle doors through your VW Car-Net iPhone [®] or Android [®] mobile application, the VW Car-Net Security & Service website or by calling the VW Car-Net Response Center (text and data rates apply).
Remote Honk and Flash	You can send a honk and flash signal to the car using the VW Car-Net Security & Service website or the VW Car-Net iPhone [®] or Android [®] app (text and data rates apply). The car will honk the horn and blink the headlights and emergency flashers for up to 10 seconds.



Feature	Description
Last Parked Location	You can locate your last parked location using your VW Car-Net iPhone [®] or Android [®] app (text and data rates apply).
Destinations	Points of Interest (POIs) or other destinations can be imported remotely into the factory-installed navigation system (if equipped) from a computer or the VW Car-Net iPhone [®] or Android [®] app (text and data rates apply). These destinations can be called up and used by the navigation system.
<i>Only applicable for vehicles equipped with a factory-installed navigation system.</i>	
Destination Download	<i>Press the button ① in the 3-button module:</i> The vehicle will connect directly to the VW Car-Net [®] Response Center where a VW Car-Net Customer Specialist will assist with destinations. The address of a dealer's location can also be sent by the Customer Specialist to your factory-installed navigation system (if equipped).
<i>Only applicable for vehicles equipped with a factory-installed navigation system.</i>	



Feature	Description
Remote Status Check	Current information about the vehicle can be viewed through a computer or your VW Car-Net iPhone® or Android® app (text and data rates apply). You can find out if the doors, luggage compartment and engine hood are open or closed, whether the car lights are on or off, the level of fuel in the tank, when the vehicle needs to be serviced next and more.

Diagnostics & Maintenance:

Feature	Description
Dealer Scheduling	<i>Press the button ① in the 3-button module:</i> The vehicle will initiate a call to the VW Car-Net Response Center where a VW Car-Net Customer Specialist will connect you with an authorized Volkswagen dealer to schedule your service appointment. The address of the dealer's location can also be sent by the Customer Specialist to your factory-installed navigation system (if equipped).
Vehicle Health Report	View a vehicle health report to proactively manage maintenance and other services and to receive up-to-date diagnostics in a monthly email report or by immediate request.

WARNING

Refer to your vehicle's warning and indicator lights for the most current diagnostic information.



ment cluster text messages can cause the vehicle to break down in traffic and result in a collision and serious personal injury.

- Never ignore warning lights or text WARNINGS.
- Always stop the vehicle as soon as it is safe to do so.
- Park the vehicle at a safe distance from moving traffic and where no part of the hot catalytic converter and exhaust system can come into contact with flammable materials under the vehicle, such as dry grass, brush, spilled fuel, etc.
- A broken down vehicle presents a high accident risk for itself and others. Switch on emergency flashers and set up a warning triangle to warn oncoming traffic.




The VW Car-Net Security & Service website ([http:// www.vw.com/carnet](http://www.vw.com/carnet)) contains the most up-to-date information and instructions about VW Car-Net Security & Service services.

- Please regularly visit the website to learn about changes to services and new features.
- VW Car-Net Security & Service features can be modified, discontinued, deactivated, reactivated or expanded without any further notice.


Application software (“apps”)



Read and follow the introductory information and safety information first ⇒  [Introduction to the subject](#)

Many mobile devices are equipped to load application software (apps) into the device. Apps can make it possible to display additional information on the factory-installed Radio or Navigation system or activate, control or deactivate specific vehicle features.

Application software, its usage and the wireless connection required to use application software may be billable services. Apps may be provided by third parties. Therefore you should refer to the terms of use and privacy statements associated with the apps for information about how the apps collect, use and share information about you, your vehicle or your mobile device.

The application software provided may be designed to be used for a variety of purposes and be specific to your vehicle and country ⇒  . The content, range of software provided and application

provided by third parties. In order for some application software to work, wireless service reception must be strong enough to handle the data exchange involved (text and data rates apply).

Application software descriptions may be provided by the service provider.

Due to the multitude of mobile devices and fast pace of software development, the application software provided may not run on all mobile devices and their operating systems. This may even apply for the same model of a mobile device. For example, application software may run on version 2 of the device's operating system but not on version 3.

Application software can be modified, discontinued, deactivated, reactivated or expanded without any further notice.

In order for some application software to work, the wireless or cable connection between the factory-installed Radio or Navigation system and a compatible, functioning mobile device must be strong enough and uninterrupted.

NOTE

Volkswagen is not responsible for vehicle damage caused by inferior-quality or malicious application software, poorly programmed application software, insufficient wireless service reception, data loss during transmission or misuse of mobile devices.

3-button module

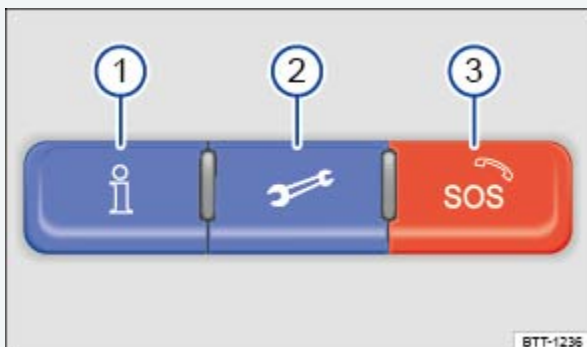


Fig. 21 In the roof console: 3-button module to access VW Car-Net service operators (Version 1).

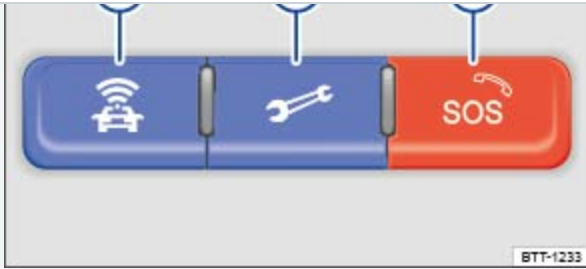


Fig. 22 In the roof console: 3-button module to access VW Car-Net service operators (Version 2).



Read and follow the introductory information and safety information first ⇒ [Introduction to the subject](#)

The buttons in the 3-button module provide access to several VW Car-Net[®] Security & Service features and pressing a button will initiate a connection to the VW Car-Net Response Center. Calls may be monitored or recorded. In general, the VW Car-Net Customer Specialist will end the call.

⇒ Fig. 21 or ⇒ Fig. 22

Function

Press and hold for longer than 2 seconds: Connects to the VW Car-Net[®] Response Center and a VW Car-Net Customer Specialist.

①

Press again: End the call.

Press and hold for longer than 2 seconds: Assistance in the event of a breakdown by connecting to the Volkswagen Roadside Provider.

②

Press again: End the call.



Press and hold for longer than 2 seconds: Activate emergency call.

③

Press again: End the call.

LED light in the 3-button module

The LED light in the 3-button module will be green during the trial period and whenever you have an active subscription. The LED light will go off if the trial period is over and the customer has not subscribed to the VW Car-Net Security & Service. The LED light will be red only during a VW Car-Net hardware malfunction or fault.

WARNING

Application software and VW Car-Net Security & Service services that are unsuitable or improperly used can cause accidents, serious personal injury and vehicle damage.

- VW Car-Net Security & Service can be used only where adequate cellular and GPS signals are available
- Volkswagen recommends using only services and application software that are provided by Volkswagen or Verizon Telematics, Inc. (VzT) specifically for your vehicle.
- Protect the mobile device and its application software from misuse.
- Never modify application software and VW Car-Net services.
- Always read and heed the operating instructions for the mobile device.

WARNING

Driver distraction causes accidents, collisions and serious personal injury! Using application software and VW Car-Net services while driving can distract the driver from traffic.

- Always drive attentively and responsibly.

NOTE



via the mobile phone package.

- When a VW Car-Net service is accessed through the 3-button module call buttons any calls on a mobile device connected to the vehicle's mobile phone package will be automatically disconnected.
- Initiating or accepting a call on a mobile device connected to the vehicle's mobile phone package could end any connection to the VW Car-Net Response Center made through the 3-button module.
- Calls on a mobile device connected to the vehicle's mobile phone package cannot be accepted or initiated during an automated emergency connection to the VW Car-Net Response Center; for example, because an airbag has deployed.



Owner's manual
Owner's Manual
Edition: 12.2016
ID: 5GM012723AL

Before driving

Some basics

Driving checklists and warnings



Introduction to the subject

In this chapter you will find information on the following subjects:

⇒ *Getting ready and driving safely*

⇒ *Driving in other countries*

⇒ *Driving through water on roads*


WARNING

Driving under the influence of alcohol, illegal drugs, narcotics and some medications may cause collisions and other accidents, severe personal injuries and even death.

- Alcohol, illegal drugs, narcotics and some medications may severely affect perception, reaction times and safe driving, which may result in the loss of vehicle control.

Getting ready and driving safely



Read and follow the introductory information and safety information first ⇒  *Introduction to the subject*

Checklist



passengers and others → 🚗 .

- ✓ Check proper function of lights and turn signals.
- ✓ Check tire pressure (Tires and wheels) and fuel level (Refueling).
- ✓ Make sure that all windows are clean.
- ✓ Make sure that the engine is not covered by blankets or other materials and that the engine air intake is free of obstacles.
- ✓ Store items and all luggage safely in the storage compartments, in the luggage compartment and, where applicable, on the roof Transporting.
- ✓ Always make sure that nothing keeps the pedals from moving freely.
- ✓ Make sure that children are properly secured by a restraint system appropriate for their size and weight Child safety and child restraints.
- ✓ Properly adjust front seats, all head restraints and mirrors to the correct height Adjusting the seating position.
- ✓ Wear shoes that give your feet a good grip and that give you a feel for the pedals.
- ✓ Make sure that the floormat on the driver side is properly fastened and cannot interfere with the pedals.
- ✓ Assume a proper seating position before the vehicle starts to move and keep this position while driving. Make sure that all passengers do the same Adjusting the seating position.
- ✓ Properly fasten your safety belt before driving the vehicle and wear your safety belt properly at all times while driving. Make sure that all passengers do the same Safety belts.
- ✓ Only transport as many passengers as there are seats and safety belts available.
- ✓ Never drive if your driving ability has been impaired, for example, by medication, alcohol, or illegal drugs.
- ✓ Never let passengers or phone calls distract you while driving and never take your attention off the road while using vehicle software or adjusting vehicle equipment or accessories.
- ✓ Always adapt your speed and driving style to visibility, weather, road, and traffic conditions.
- ✓ Always obey traffic laws and speed limits.
- ✓ On long trips make frequent rest stops – at least once every 2 hours.
- ✓ Secure animals in the vehicle with a system that corresponds to their weight and size.



Always observe traffic rules and posted speed limits and use common sense. Your good judgment can mean the difference between arriving safely at your destination and being seriously injured in a crash or other kind of accident.



Regular service and maintenance of your vehicle is important both for operational and driving safety and to help prolong your vehicle's service life. Always follow the scheduled maintenance intervals in the ⇒Booklet *Warranty and Maintenance*, especially for changing the brake fluid. Hard use, frequent stop-and-go driving, driving in very dusty areas, trailer towing, and other factors may make it necessary to have the vehicle serviced more frequently. Ask an authorized Volkswagen dealer or an authorized Volkswagen Service Facility for more information.

Driving in other countries



Read and follow the introductory information and safety information first ⇒ [Introduction to the subject](#)

Checklist

Some countries have special safety standards and emissions requirements that your vehicle may not meet. Before taking your vehicle to another country, Volkswagen therefore recommends that you ask your authorized Volkswagen dealer or authorized Volkswagen Service Facility about the following issues with regard to the country to which you would like to travel:

- ✓ Should the vehicle be technically prepared for the trip abroad, such as masking or adjusting headlights?
- ✓ Are maintenance, repair facilities, necessary tools, and testing equipment as well as spare parts readily available for your vehicle?
- ✓ Are there authorized Volkswagen dealers and authorized Volkswagen Service Facilities in the countries where you will be driving?
- ✓ Is fuel with the appropriate rating for your vehicle's engine requirements readily available Fuel?
- ✓ Are engine oil (Engine oil) and other operating fluids that meet Volkswagen quality and performance requirements available where you will be driving? For more information, please see



- ✓ Does the factory-installed navigation system work in the countries where you will be driving, and is navigation data available?
- ✓ Are special or heavy-duty tires necessary for the kind of driving expected?

NOTE

Volkswagen is not responsible for mechanical damage that may result from substandard fuel or service or the unavailability of Genuine Volkswagen parts.

Driving through water on roads



Read and follow the introductory information and safety information first ⇒ [Introduction to the subject](#)

Note the following to help prevent vehicle damage when driving through water, for example on flooded roads:

- Check the depth of the water before driving through it. The water must not be any higher than the bottom of the vehicle body ⇒ .
- Do not drive faster than walking speed.
- Never stop the vehicle, and do not drive in reverse or switch the engine off when driving through water.
- Oncoming vehicles may create waves that raise the water level and make it too deep for your vehicle to drive through safely.

WARNING

After driving through water, mud, sludge, etc., the brakes react slower and need longer stopping distances.

- Always dry the brakes and clean off any ice coatings with a few careful applications of the brake. Make sure not to endanger other motorists or cyclists or disobey legal requirements.
- Avoid abrupt or sudden braking maneuvers immediately after driving through water.



- Vehicle components such as the engine, transmission, suspension or electrical system may be severely damaged by driving through water.
- Never drive through salt water. Salt causes vehicle corrosion. Thoroughly rinse with fresh water all vehicle parts that were exposed to salt water.

Technical data



Introduction to the subject

In this chapter you will find information on the following subjects:

⇒ *Important vehicle labels*

⇒ *Engine data*

⇒ *Dimensions*

Your vehicle's engine type is shown on the vehicle identification label.


The specifications in this Manual refer to the base model. The stated values may vary, depending upon different equipment or models, as well as with respect to special vehicles and vehicles exported to different countries.


WARNING

Disregarding or exceeding stated values for weights, loads, dimensions and maximum speed may result in accidents and serious personal injuries.

Important vehicle labels



at the bottom of the windshield. The vehicle identification number is also stamped into the top of the right drip channel in the engine compartment. The drip channel is between the spring strut tower and the right fender. Open the engine hood to read the vehicle identification number  ⇒ [Working in the engine compartment](#).

The vehicle identification number can be displayed in the Infotainment system by pressing the **CAR** button followed by the  and Service function keys ⇒ [Menu and system settings](#).

Vehicle identification label

The vehicle identification label ⇒ [Fig. 23](#) is affixed to the area of the spare wheel well underneath the luggage compartment floor panel and contains the following information:

- ① Vehicle identification number (VIN)
- ② Vehicle type, engine output, and transmission
- ③ Engine and transmission identification codes, paint number, and interior type. In the example, the engine identification code is CBFA ⇒ [Fig. 23](#).
- ④ Optional equipment and part numbers

Safety Compliance Certification Label

A safety certificate affixed to the door jamb in the driver door confirms that at time of production all necessary safety standards and requirements of the traffic safety agency of the respective country were met. The month and year of production as well as the vehicle identification number may be listed as well.

Radiator fan and high voltage warning sticker

A warning sticker about the radiator fan and the high voltage of the electrical system is located in the engine compartment next to the engine hood release. The vehicle ignition system complies with the Canadian standard ICES-002.

Tire inflation pressure label

A tire inflation pressure label is on the driver door jamb ⇒ [Tires and wheels](#).

Fuel grade sticker

An information sticker listing the correct fuel grade for your vehicle ⇒ [Refueling](#).



Read and follow the introductory information and safety information first ⇒ [Introduction to the subject](#)

Golf models

Maximum power output ^{a)}	Injection technology	Engine ID code	Maximum torque ^{a)}	No. of cylinders Displacement
170 hp at 4800–6200 rpm		CXBA	184 lb-ft at 1500–4700 rpm	4 cylinders
(125 kW at 4800–6200 rpm)	TSI [®]	CXBB	(250 Nm at 1500–4700 rpm)	110 CID
		1.8L		(1798 ccm)

Golf GTI models

Maximum power output ^{a)}	Injection technology	Engine ID code	Maximum torque ^{a)}	No. of cylinders Displacement
210 hp at 4300–6200 rpm		CNTA	258 lb-ft at 1600–4200 rpm	4 cylinder
(155 kW at 4300–6200 rpm)	TSI [®]	CXCA	(350 Nm at 1600–4200 rpm)	121 CID
		2.0T		(1984 ccm)



Maximum power output	Injection technology	Engine ID code	Maximum torque	Displacement
220 hp at 4500–6200 rpm	TSI®	CXCB	258 lb-ft at 1600–4400 rpm	4 cylinder
(162 kW at 4500–6200 rpm)		2.0T	(350 Nm at 1600–4400 rpm)	121 CID (1984 ccm)

Golf R models

Maximum power output ^{a)}	Injection technology	Engine ID code	Maximum torque ^{a)}	No. of cylinders	Displacement
292 hp at 5400–6200 rpm	TSI®	CYFB	280 lb-ft at 1900–5300 rpm	4 cylinder	
(215 kW at 5400–6200 rpm)		2.0T	(380 Nm at 1900–5300 rpm)	121 CID (1984 ccm)	

Fuel recommendations for gasoline engines

Using gasoline that does not meet minimum octane requirements can cause loss of engine performance, while the use of poor quality gasoline or octane levels below 87 can also cause engine damage. If Regular gasoline is recommended for your engine, you may be able to enhance engine performance by using Premium gasoline.

^{a)} Engine performance data using Premium grade gasoline ⇒ [Fuel](#)



Read and follow the introductory information and safety information first ⇒ [Introduction to the subject](#)

Length	167.5–168.3 inches (4255–4276 mm)
Width (2-door)	70.5 inches (1790 mm)
Width (4-door)	70.8 inches (1799 mm)
Height (unloaded)	56.5–58.1 inches (1436–1477 mm)
Wheelbase	103.5–104.3 inches (2631–2651 mm)
Minimum turning circle diameter (wall to wall) ^{a)}	about 36.4 feet (11.1 m)
Track ^{a)} , front	60.1–70 inches (1527–1549 mm)
Track ^{a)} , rear	58.9–59.8 inches (1498–1520 mm)
Ground clearance (unloaded) ^{a)}	about 4.8–5.6 inches (122–142 mm)

NOTE

- Please be careful when parking your vehicle in areas with parking barriers or curbs. These vary in height and could damage your bumper and related parts if the front of your vehicle hits a barrier or curb that is too high while you are getting into or out of a parking spot.



other obstacles. Parts of the vehicle close to the ground may be damaged (such as bumper covers, spoilers, and parts of the engine, suspension, and exhaust systems).

a) Slight differences to these figures are possible, depending on wheel and tire size fitted, tire inflation pressure, equipment level, driving situation, and other factors.

Opening and closing

Vehicle key set



Introduction to the subject

In this chapter you will find information on the following subjects:

⇒ *Remote control vehicle keys*

⇒ *Indicator light in the remote control vehicle key*

⇒ *Replacing the remote control vehicle key battery*

⇒ *Synchronizing the remote control vehicle key*

DANGER!

20 mm button cells and other lithium batteries will cause serious personal injury and even death within a short time if swallowed.

- Always keep remote control vehicle key fobs with batteries, spare batteries, as well as dead button cell and larger 20 mm batteries out of the reach of children.
- Get medical attention immediately if you suspect that a battery has been swallowed.

WARNING

Improper use of vehicle keys can result in serious personal injury.

- Always switch off the engine and the ignition and take the key with you when you leave the vehicle. It can be used to start the engine and operate vehicle systems such as the power win-

lock the doors and the trunk lid.

- Never leave children, disabled persons, or anyone who cannot help themselves in the vehicle. The doors can be locked with the remote control vehicle key. This could leave people trapped in the vehicle in an emergency. Depending on the time of year, people trapped in the vehicle can be exposed to very high or very low temperatures.
- A closed vehicle can become very hot or very cold, depending on the season. Particularly in the summer, heat buildup in the passenger and luggage compartment of a parked vehicle can result in temperatures in the vehicle that are much higher than the outside temperatures. Temperatures can quickly reach levels that can cause unconsciousness and death, particularly to small children.
- Never remove the key from the ignition switch or turn off the ignition with the starter button while the vehicle is moving or rolling to a stop. The electronic steering column could suddenly lock, you would not be able to steer, and you could lose control of the vehicle, crash, and seriously injure yourself and others.

Remote control vehicle keys



Fig. 25 Remote control vehicle key with panic button.



Read and follow the introductory information and safety information first ⇒ [Introduction to the subject](#)

Remote control vehicle key

The remote control vehicle key can unlock and lock the vehicle from a distance ⇒ [Power locking system](#).

The remote transmitter and battery are inside the remote control vehicle key. The receiver is inside the passenger compartment. The operating range of the remote control vehicle key for a fresh battery




If the remote control vehicle key will not lock or unlock your vehicle, you probably need to replace the battery in the remote control vehicle key ⇒ [Replacing the remote control vehicle key battery](#). If this is not the problem, the key should be resynchronized by an authorized Volkswagen dealer, an authorized Volkswagen Service Facility, or another qualified workshop. See also ⇒ [Synchronizing the remote control vehicle key](#).

Folding the key bit in or out

Pressing button ⇒ [Fig. 25①](#) releases the key bit and folds it out.

To *fold the key bit in* press button ① while pressing the key bit back until it clicks.

Panic button

Press the panic button ⇒ [Fig. 25②](#) only in emergencies! After pushing the panic button, the horn will sound and the turn signals will flash. Press the panic button again or press the  button on the remote control vehicle key to switch off the panic feature.

Replacement vehicle keys

The vehicle identification number is required to get a replacement key or an additional remote control vehicle key.

Each new vehicle key contains a microchip and must be coded with the data from the vehicle's electronic immobilizer. A vehicle key will not work if it does not contain a microchip or contains a chip that is not coded, even if the key bit was cut correctly.

You can obtain additional or duplicate remote control vehicle keys from authorized Volkswagen dealers, authorized Volkswagen Service Facilities, and from certain independent repair facilities and locksmiths which are qualified to make remote control vehicle keys.

Each vehicle key must be programmed by an authorized Volkswagen dealer or an authorized Volkswagen Service Facility in order for it to work with your vehicle.

To find the nearest qualified independent repair facility, locksmith, or Volkswagen dealer which can cut and code replacement vehicle keys, call the VW Customer Care Hotline at 1-800-822-8987 or visit <http://www.vw.com> and search for replacement keys.

Canadian customers can contact an authorized Volkswagen dealer or Volkswagen Service Facility or

NOTE

The remote control vehicle keys contain electrical components. Protect them from damage, moisture and rough handling.



Do not press the buttons on the remote control vehicle key unless you actually want to use the function in question. Since terrain and conditions vary, pressing a button on the remote control vehicle key when it is not necessary may unlock the vehicle or set off the panic alarm, even if you think you are out of range.



Remote control vehicle key functions can be temporarily disrupted by interference from transmitters near the vehicle that use the same frequency range (such as radio equipment or mobile phones).



Things between the remote control vehicle key and vehicle, bad weather, as well as a weak battery can reduce the operating range.



If the vehicle key buttons ⇒ *Unlocking or locking the vehicle from the outside* or the power locking buttons ⇒ *Unlocking or locking the vehicle from the inside* are pushed repeatedly in quick succession, the power locking system is switched off for a brief period to help keep it from being overloaded. The vehicle is then unlocked for about 30 seconds. Unless a door or the trunk lid is opened during this time, the vehicle is automatically locked afterwards.

Indicator light in the remote control vehicle key



Fig. 26 Indicator light in the remote control vehicle key.

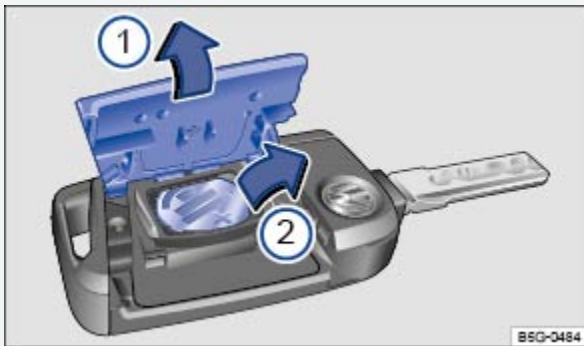
subject

If a button on the remote control vehicle key is pressed briefly, the indicator light \Rightarrow [Fig. 26](#) (arrow) will flash once briefly. If you push and hold a button, it flashes repeatedly.

If the indicator light in the remote control vehicle key does not come on when the button is pressed, the battery inside the key must be replaced \Rightarrow [Replacing the remote control vehicle key battery](#).

A Declaration of Compliance with United States FCC and Industry Canada regulations is found in the Consumer information section of this Manual \Rightarrow [Consumer information](#).

Replacing the remote control vehicle key battery



[Fig. 27 Remote control vehicle key: Opening the battery compartment cover and removing the old battery.](#)



Read and follow the introductory information and safety information first \Rightarrow [Introduction to the subject](#)

Volkswagen recommends having the battery in the remote control vehicle key changed by an authorized Volkswagen dealer or an authorized Volkswagen Service Facility.


The battery is on the back of the remote control vehicle key under a cover \Rightarrow [Fig. 27](#).



When changing the battery, pay attention to the correct polarity and use the same type of battery \Rightarrow [!](#).

Replacing the battery

- Unfold the key bit on the remote control vehicle key \Rightarrow [Remote control vehicle keys](#).



the arrow using a suitable object such as a coin ⇒ .

- Use a thin object to pry the battery out of the battery compartment ⇒ [Fig. 27](#) .
- Position the new battery in as shown and press it into the battery compartment (opposite direction of the arrow) ⇒ .
- Position the cover as shown and press it down (opposite direction of the arrow) until you hear it click into place.

NOTE

- Changing the battery improperly can damage the remote control vehicle key.
- Using the wrong battery can damage the remote control vehicle key. Replace a dead battery with a new one that has the same voltage, size, and specifications.
- Make sure the plus and minus poles of the battery are correctly positioned.




Dispose of old batteries in an environmentally responsible manner and keep them out of the reach of children.




Batteries of the type used in your remote control vehicle key may contain Perchlorate Material . Special handling may apply – see <http://www.dtsc.ca.gov/hazardouswaste/perchlorate>. Obey all legal requirements regarding handling and disposal of these batteries. Authorized Volkswagen dealers and authorized Volkswagen Service Facilities are familiar with the requirements, and we recommend that you have them perform this service for you.

Synchronizing the remote control vehicle key



Read and follow the introductory information and safety information first ⇒  [Introduction to the subject](#)

If the  button is pressed often while outside the operating range, it is possible that the vehicle cannot be locked or unlocked anymore with the remote control vehicle key. Synchronize the vehicle key as follows:

- Unfold the key bit on the remote control vehicle key ⇒ [Remote control vehicle keys](#).
- Remove the cap from the door handle on the driver door ⇒ [Emergency closing and opening](#).



ing so.

- Manually unlock the vehicle using the key bit within 1 minute. The synchronization is complete.
- Reinstall the cap.

Power locking system



Introduction to the subject

In this chapter you will find information on the following subjects:

⇒ *Indicator light in the driver door*

⇒ *Description of the power locking system*

⇒ *Unlocking or locking the vehicle from the outside*

⇒ *Unlocking or locking the vehicle from the inside*

⇒ *Unlocking or locking the vehicle with Keyless Access*

⇒ *Anti-theft alarm system*

The power locking system works properly only when all doors and the trunk lid are completely closed. When the driver door is open, the vehicle *cannot* be locked with the remote control vehicle key.

For vehicles equipped with Keyless Access with push-button start, the vehicle can be locked *only* if the ignition is switched off and the driver door is closed.

Leaving the vehicle unlocked for longer periods of non-use (for example, in your garage) can cause the vehicle battery to drain so that the engine can no longer be started.

WARNING

Improper use of power locks can result in serious personal injury.

- The power locking button locks all doors. Locking the doors from the inside can help prevent unintended door opening during a collision and can also prevent unwanted entry from the outside. Locked doors can, however, delay assistance to vehicle occupants and rescue from the



- Never leave children or anyone who cannot help themselves behind in the vehicle. All doors can be locked from the inside with the power lock button. This could leave people trapped in the vehicle in an emergency. Depending on the time of year, people trapped in the vehicle can be exposed to very high or very low temperatures.
- A closed vehicle can become very hot or very cold, depending on the season. Particularly in the summer, heat buildup in the passenger and luggage compartment of a parked vehicle can result in temperatures in the vehicle that are much higher than the outside temperatures. Temperatures can quickly reach levels that can cause unconsciousness and death, particularly to small children.
- Never allow passengers to remain in a locked vehicle. In an emergency any person still inside the vehicle might not be able to get out.

Indicator light in the driver door



Read and follow the introductory information and safety information first ⇒ [Introduction to the subject](#)

The indicator light for the power locking system is in the driver door ⇒ [Passenger compartment](#).

After the vehicle is locked	Meaning
The red LED light flashes for about 2 seconds in short intervals, then slower.	The vehicle is locked.
Red LED light flashes for about 2 seconds in short intervals, then lights up continuously for about 30 seconds.	Locking system malfunction. See an authorized Volkswagen dealer or an authorized Volkswagen Service Facility.

NOTE

Description of the power locking system



Read and follow the introductory information and safety information first ⇒ [Introduction to the subject](#)

The power locking system lets you unlock and lock all doors and the trunk lid:

- From the outside with the vehicle key ⇒ [Unlocking or locking the vehicle from the outside](#).
- From the outside with Keyless Access (if equipped) ⇒ [Unlocking or locking the vehicle with Keyless Access](#).
- From the inside with the power locking button ⇒ [Unlocking or locking the vehicle from the inside](#).

When the vehicle is locked from the outside, the fuel filler flap is also locked.

Certain central locking functions can be turned on and off in the Infotainment system by pressing the **CAR** button followed by the and Opening and closing function keys ⇒ [Menu and system settings](#), or by an authorized Volkswagen dealer or authorized Volkswagen Service Facility.

The doors and the trunk lid can be locked manually if the remote control vehicle key or the power locking system is not working ⇒ [Emergency closing and opening](#).

Automatic locking (Auto lock)

The vehicle locks automatically when it reaches a speed of about 10 mph (15 km/h). When the vehicle is locked, the indicator light comes on in the power locking button ⇒ [Fig. 29](#).


Automatic unlocking (Auto unlock)

All doors automatically unlock when you switch off the ignition or open a door from inside the vehicle. On vehicles with automatic transmission, the doors will also unlock when the selector lever is in Park (P). Auto unlock works only if the vehicle has been automatically locked with the Auto lock feature. The indicator light goes out in the power locking button when the doors unlock ⇒ [Fig. 29](#).

Locking the vehicle after airbag inflation

If the airbags are activated during a collision, the entire vehicle is unlocked. Depending on the severity of the damage, the vehicle can be locked after a collision when the airbags have deployed as follows:



Locking the vehicle with the power locking button :	<ul style="list-style-type: none">- Switch the ignition off.- Open and close a door once.- Press the power locking button .
Locking the vehicle with the remote control vehicle key :	<ul style="list-style-type: none">- Switch the ignition off. <p>OR: Remove the vehicle key from the ignition.</p> <ul style="list-style-type: none">- Open a door once.- Lock the vehicle with the remote control vehicle key.



If the vehicle key buttons ⇒ *Unlocking or locking the vehicle from the outside* or the power locking buttons ⇒ *Unlocking or locking the vehicle from the inside* are pushed repeatedly in quick succession, the power locking system is switched off for a brief period to help keep it from being overloaded. The vehicle is then unlocked for about 30 seconds. Unless a door or the trunk lid is opened during this time, the vehicle is automatically locked afterwards.

Unlocking or locking the vehicle from the outside



Fig. 28 Remote control vehicle key with panic button.



Read and follow the introductory information and safety information first ⇒ [Introduction to the subject](#)

Function	Using the buttons on the remote control vehicle key ⇒ Fig. 28
Unlock the vehicle:	Press the button.
Lock the vehicle:	Press the button.
Unlock the trunk lid:	Press the button ⇒ Trunk lid .

Note: Depending on the settings for the power locking system that have been set in the Infotainment system, it may be necessary to press the button on the remote control vehicle key twice to unlock all doors and the trunk lid ⇒ [Volkswagen Information System](#).

The vehicle key unlocks or locks the vehicle only when the battery in the remote control vehicle key has enough power, and the remote control vehicle key is within a few yards/meters of the vehicle.

- All turn signals flash *once* and the horn beeps once to confirm that the vehicle has been locked. The horn beep can be disabled in the Infotainment system by pressing the **CAR** button followed by the and Opening and closing function keys ⇒ [Menu and system settings](#).
- All turn signals flash *twice* to confirm that the vehicle has been unlocked.

If the turn signals *do not* flash to confirm locking, one or more doors or the trunk lid is not locked.

If the driver door is open, the vehicle cannot be locked with the remote control vehicle key.

been opened within several seconds, the vehicle is automatically locked again. This feature helps prevent you from leaving the vehicle unlocked unintentionally.

Unlocking or locking the vehicle from the inside



Fig. 29 In the driver and front passenger doors: Power locking button.

Read and follow the introductory information and safety information first ⇒ [Introduction to the subject](#)

Press button ⇒ Fig. 29 :	
	Unlock the vehicle.
	Lock the vehicle.

The power locking button works whether the ignition is switched on or off but only when *all* doors are closed.

If the vehicle is locked with the vehicle key, the power locking button is deactivated.

If the vehicle is locked with the power locking button:

- The yellow indicator light in the power locking button comes on to indicate that all doors are locked ⇒ [Fig. 29](#).
- If the vehicle is equipped with an anti-theft alarm, the system is not turned on.
- Opening doors or the trunk lid from the *outside* is not possible, at a traffic light, for example.

to open the door. The indicator light goes out. The unopened doors and trunk lid remain locked and cannot be opened from the outside.

- An open driver door will not be locked. This helps keep the driver from being locked out of the vehicle.

The vehicle is unlocked if you push the button while the vehicle is standing still. It also unlocks when you switch off the ignition or open a door from inside the vehicle (Auto unlock). On vehicles with automatic transmission, the doors will also unlock when the selector lever is in Park (P). Auto unlock works only if the vehicle has been automatically locked with the Auto lock feature.

Unlocking or locking the vehicle with Keyless Access

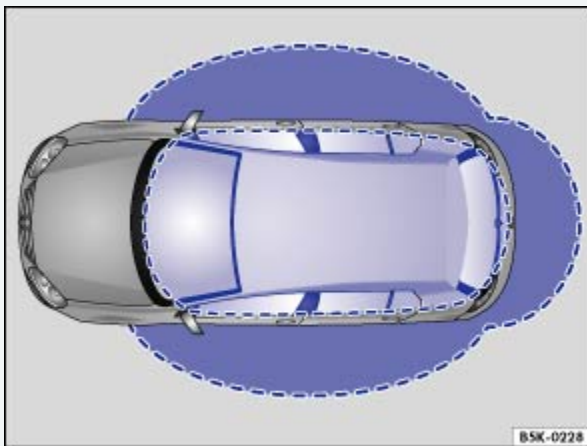


Fig. 30 Ranges of the Keyless Access system. Outside the vehicle: Unlocking range. Inside the vehicle: Starting range.

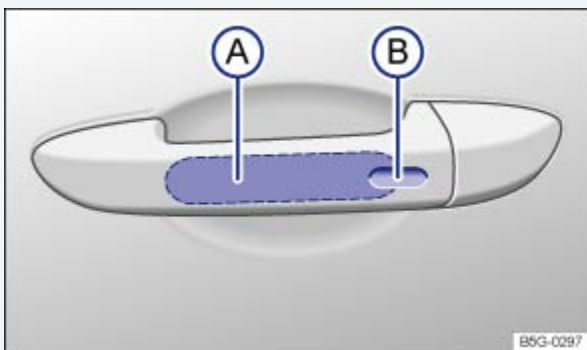



Fig. 31 Keyless Access system: Sensor for unlocking on the inside of the front door handles. Sensor for locking on the outside of the front door handles.



Read and follow the introductory information and safety information first \Rightarrow *Introduction to the subject*



ing system that unlocks and locks the vehicle without active use of a remote control vehicle key. All you have to do is touch a sensor surface on one of the front outside door handles ⇒ [Fig. 31](#) or push the Volkswagen emblem on the trunk lid ⇒ [Opening the trunk lid](#) when a valid remote control vehicle key is within range ⇒ .

General information

When a valid vehicle key comes within range ⇒ [Fig. 30](#), the Keyless Access system recognizes a valid vehicle entry request as soon as a door handle sensor is touched on the driver or front passenger door or the Volkswagen emblem on the trunk lid is pressed. The following functions are then enabled without active use of the remote control vehicle key:

- Keyless Entry: Unlocking the vehicle with the sensor surfaces on the outside door handles of the driver or front passenger door ⇒ [Fig. 31](#)[Ⓐ] or by using the Volkswagen emblem on the trunk lid.
- Keyless Go: Start the engine and drive. For this, press the brake pedal (and clutch pedal, if equipped) and the starter button when a valid remote control vehicle key is inside the vehicle ⇒ [Starting and stopping the engine](#).
- Keyless Exit: Locking the vehicle via the door handle sensor on the driver or front passenger door ⇒ [Fig. 31](#)[Ⓑ].

The power locking system works like the *standard* unlocking and locking system. Only the way that the systems are operated is different.

All turn signals flash *twice* to confirm that the vehicle has been unlocked and *once* to confirm that it has been locked.

If the vehicle is unlocked and within the next several seconds no door or the trunk lid has been opened, the vehicle is automatically locked again.

To help prevent you from locking yourself out, the vehicle will not lock immediately in the following situation:

- When you press the lock button on the remote control vehicle key when a passenger door or the trunk lid is still open, and
- You leave the remote control vehicle key you just used inside the vehicle when you close all doors and the trunk lid.

The vehicle does not fully lock. All turn signals flash *four* times. Take the remote control vehicle key



The vehicle will lock again after a short time if you do not open one of the doors or the trunk lid.

Unlocking and opening doors (Keyless Entry)

- Grasp the door handle of the driver or front passenger door so that you touch the unlocking sensor surface ⇒ [Fig. 31](#) [Ⓐ].
- Open the door.

Closing and locking doors (Keyless Exit)

Always switch off the engine and ignition and take the vehicle key with you.

- Close the driver door.
- Touch the sensor surface in the door handle on the driver or front passenger door ⇒ [Fig. 31](#) [Ⓑ] *one time*. The vehicle is locked. The door being locked must be closed.

Unlocking and locking the trunk lid


If the vehicle is locked and a valid remote control vehicle key is within range ⇒ [Fig. 30](#) of the trunk lid, it unlocks automatically when opened.

Open and close the trunk lid as you would a *standard* trunk lid ⇒ [Trunk lid](#).

The trunk lid locks automatically when it is closed except in the following situations:

- The vehicle is completely unlocked.
- The most recently used vehicle key is inside the vehicle. All turn signals flash *four times*.

Locking with a second vehicle key

If the vehicle is locked from the outside with a second valid vehicle key, any key located inside the vehicle cannot start the engine ⇒ [Starting and stopping the engine](#). A key that was inside the vehicle when it was locked from the outside can be reactivated by pressing the  button on the deactivated key ⇒ [Fig. 28](#).


Automatic deactivation of sensors

If the vehicle has not been unlocked or locked for a longer period of time, the sensors in the door handles are automatically deactivated.



hedge that rubs against the vehicle, that sensor may be switched off for a short time.

The door handle sensors become active again if one of the following events occurs:

- A short time has passed.
- OR: The vehicle is unlocked using the  button on the remote control vehicle key.
- OR: The trunk lid is opened.
- OR: The vehicle is mechanically unlocked with the vehicle key.

Convenience features

Your vehicle may be equipped with the convenience closing feature.

To use the convenience closing feature to close all power windows and the sunroof, hold your finger on the lock sensor surface on the outside of the door handle ⇒ [Fig. 31](#)® for a few seconds until the windows and sunroof close.

Remove your finger from the lock sensor surface to stop the function.

Pinch protection is active during convenience closing of the windows and the power sunroof.

NOTE

The door handle sensor surfaces can be activated by a strong stream of water or steam if a valid vehicle key is within range of the vehicle.

- All windows may open if you turn the spray of water or steam away from and then back onto the door handle sensor surface in quick succession. If at least one power window is opened and the sensor is continuously activated, convenience closing is started.



The door may not open if the outside and inside door handles are used at the same time.



If the vehicle battery or the battery in the remote control vehicle key is weak or dead, it might not be possible to unlock and lock the vehicle using Keyless Access. The vehicle can still be manually locked or unlocked with the key bit ⇒ [Manually unlocking and locking the driver door](#).



To help make sure that the vehicle stays locked after you press the locking sensor on the door handle, the unlocking function on that door handle is deactivated for about 2 seconds after locking the vehicle.



A driver information message may appear in the instrument cluster display if there is a Keyless Access system malfunction. See an authorized Volkswagen dealer or an authorized Volkswagen Service Facility for assistance.



A driver information message appears in the instrument cluster display if there is no remote control vehicle key inside the vehicle or if the system does not recognize the remote control vehicle key. The key may not be recognized, for example, if it is covered by something that interferes with the signal (such as a briefcase), or if the remote control vehicle key battery is weak. Electronic devices such as mobile phones can also interfere with the signal.



Dirt on the door handles that contains a lot of salt (especially in winter) can affect the way the door handle sensors work. Cleaning the door handles can help with this problem ⇒ [Exterior care and cleaning](#).



If the automatic transmission is not in Park (P) position, the electronic steering column lock will not lock and the vehicle will not lock via sensors in the front door handles or the remote control vehicle key.



By touching the unlocking sensor surface twice in a row, the entire vehicle will unlock, even if a single door was already unlocked.

Anti-theft alarm system



Read and follow the introductory information and safety information first ⇒ [Introduction to the subject](#)

Your vehicle may be equipped with an anti-theft alarm system or pre-equipped for anti-theft alarm system installation. If the vehicle is pre-equipped for installation of the anti-theft alarm system, the



Service Facility.

The anti-theft alarm system makes it more difficult for someone to break into or steal the vehicle.

The anti-theft alarm system is automatically activated when the vehicle is locked by pressing the lock button on the remote control vehicle key.

When is the alarm triggered?

The anti-theft alarm system sounds and the turn signals flash for up to 5 minutes if the following occurs with respect to the locked vehicle:

- *In vehicles with an open lock cylinder:* A door unlocked mechanically with the vehicle key bit is opened and the ignition is not switched on within about 15 seconds.
- *In vehicles with a covered lock cylinder:* A door unlocked mechanically with the vehicle key bit is opened.
- Forcibly opening a door.
- Forcibly opening the engine hood.
- Forcibly opening the trunk lid.
- Switching on the ignition with an invalid key.
- Disconnecting the vehicle battery.

Deactivating the alarm


Unlock the vehicle with the unlock button on the remote control vehicle key or switch on the ignition with a valid remote control vehicle key.

For vehicles with Keyless Access, the alarm can also be deactivated by grasping one of the front door handles when a valid vehicle key is in range ⇒ [Unlocking or locking the vehicle with Keyless Access](#) or by holding the remote control vehicle key to the right of the steering column trim and pressing the starter button ⇒ [Starter button](#).



After the alarm has stopped and the vehicle is opened again in the same or a different area that is protected by the alarm, the alarm is triggered again. For example, the alarm will sound again if the trunk lid is opened after one of the doors has been opened.



The anti-theft alarm system is not activated when the vehicle is locked with the power lock switch  on the inside of the driver or front passenger doors.



If the driver door is mechanically unlocked using the vehicle key bit, only the driver door is unlocked, not the entire vehicle. Switching on the ignition deactivates the anti-theft alarm system and activates the central locking button. To unlock the doors, use the central locking button or remote control vehicle key.



If the vehicle battery is dead or weak, the anti-theft alarm system will not work properly.

Doors



Introduction to the subject

In this chapter you will find information on the following subjects:

⇒ *Display*

⇒ *Child safety lock*

WARNING

A door that is not closed properly may open suddenly when the vehicle is moving and cause severe injuries.

- Stop immediately and close the door.
- Make sure that the door is safely and completely latched when closed. The closed door must be flush with the surrounding auto body parts.
- Open or close doors only if no one is in the way.


WARNING

A door kept open with the door stop may close in strong winds or on inclines and cause injuries.

- Always hold doors by the door handle while opening and closing.



Read and follow the introductory information and safety information first ⇒ [Introduction to the subject](#)

Lights up	Proper response
Icon appears in the display ⇒ Displays	At least one vehicle door is open or improperly closed.  Stop! Open and close the door again.

When the ignition is switched on, several warning and indicator lights come on briefly for a function check. They go out after a few seconds.

If a door is not closed properly, the vehicle icon appears in the instrument cluster display showing an open door ⇒ [Fig. 12](#).

Depending on your vehicle's equipment and options, the icon may still be displayed even after the ignition is switched off as long as the key has not been taken out of the ignition. The instrument cluster display goes out a short period of time after the vehicle has been locked.

Child safety lock

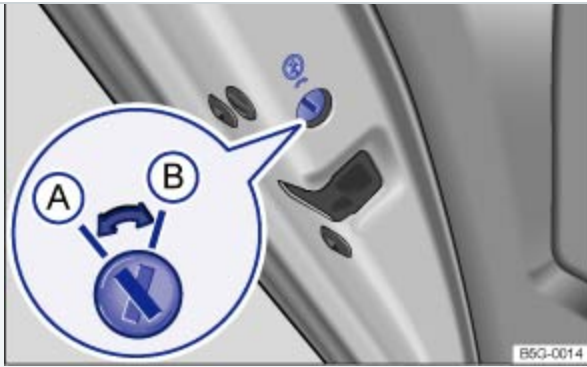


Fig. 32 In the driver side rear door: Child safety lock Ⓐ deactivated, Ⓑ activated.

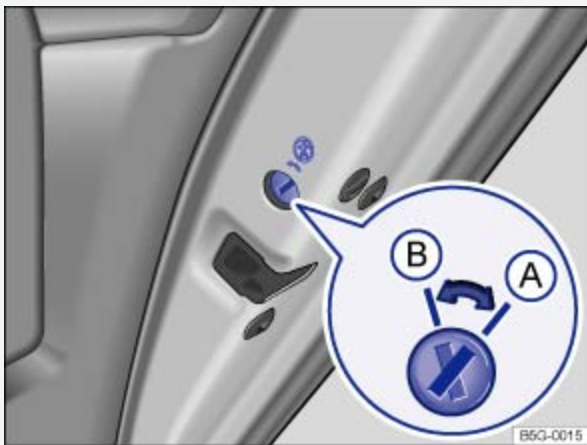


Fig. 33 In the passenger side rear door: Child safety lock Ⓐ deactivated, Ⓑ activated.



Read and follow the introductory information and safety information first ⇒ *Introduction to the subject*

Slot position ⇒ *Fig. 32* or ⇒ *Fig. 33* :

- Ⓐ Child safety lock disengaged.
- Ⓑ Child safety lock engaged.

The child safety lock keeps the rear doors from being opened from the inside, so that children cannot open them accidentally. When the child safety lock is engaged, the rear doors can only be opened from the outside.

Engaging or disengaging child safety lock

- Unlock the vehicle and open the respective rear door.
- Unfold the key bit from the remote control vehicle key.



WARNING

When the child safety lock is engaged, that rear door cannot be opened from the inside.

- Never leave children, disabled persons, or anyone who cannot help themselves, in the vehicle when locking the doors. This could result in people being locked in the vehicle. This could result in people being trapped in the vehicle in an emergency. Depending on the time of year, people trapped in the vehicle can be exposed to very high or very low temperatures.
- A closed vehicle can become very hot or very cold, depending on the season. Particularly in the summer, heat buildup in the passenger and luggage compartment of a parked vehicle can result in temperatures in the vehicle that are much higher than the outside temperatures. Temperatures can quickly reach levels that can cause unconsciousness and death, particularly to small children.

Trunk lid



Introduction to the subject

In this chapter you will find information on the following subjects:

⇒ *Display*

⇒ *Opening the trunk lid*

⇒ *Closing the trunk lid*

WARNING

Accidents and severe personal injuries can result if you unlock, open, or close the trunk lid when someone is in the way.

- Only open or close the trunk lid if no one is in the way.
- Never close the trunk lid by pushing on the rear window with your hand. The rear window could break and cause injuries.
- After closing the trunk lid, always make sure that it is properly closed and locked so that it cannot open suddenly when the vehicle is moving. The closed trunk lid must be flush with the sur-



- Always keep the trunk lid closed while driving to help keep poisonous exhaust gas from being drawn into the vehicle.
- Never open the trunk lid when a luggage rack is installed and loaded. If, for example, there are bicycles on a carrier on the trunk lid, it is possible that the trunk lid will be difficult to open. An open trunk lid may fall on its own because of the additional weight. If necessary, prop open the trunk lid. Remove the weight from the luggage rack first.
- Close and lock the trunk lid and all doors when the vehicle is not in use. First, make sure that no one is left inside the vehicle.
- Never leave your vehicle unattended or let children play around your vehicle, especially when the trunk lid is open. A child could crawl into the vehicle and pull the trunk lid shut, becoming trapped and unable to get out. A closed vehicle can become very hot or very cold, depending on the season. Particularly in the summer, heat buildup in the passenger and luggage compartment of a parked vehicle can result in temperatures in the vehicle that are much higher than the outside temperatures. Temperatures can quickly reach levels that can cause unconsciousness and death, particularly to small children.
- Never leave children or anyone who cannot help themselves behind in the vehicle. They may lock the vehicle with the vehicle key or the power locking button and lock themselves in.

NOTE


Before opening or closing the trunk lid, make sure there is enough room to do so, for example, when the vehicle has a trailer or is in a garage.

NOTE


Never use the gas strut to hold or clamp a load in place. This can damage the trunk lid and make it impossible to close.

Display



Read and follow the introductory information and safety information first ⇒  [Introduction to the subject](#)



<p>Icon appears in the display</p> <p>⇒ <i>Displays</i></p>	<p>Trunk lid open or improperly closed.</p> <p> Stop!</p> <p>Open the trunk lid and then close it again.</p>
---	---

When the ignition is switched on, several warning and indicator lights come on briefly for a function check. They go out after a few seconds.

If the trunk lid is not closed properly, the vehicle icon appears in the instrument cluster display showing an open trunk lid ⇒ [Fig. 12](#).

Depending on your vehicle's equipment and options, the icon may still be displayed even after the ignition is switched off as long as the key has not been taken out of the ignition. The instrument cluster display goes out a short period of time after the vehicle has been locked.

WARNING

If the trunk lid is not closed properly, it may open suddenly when the vehicle is moving and cause severe injuries.

- Stop immediately and close the trunk lid.
- Always make sure the trunk lid is securely latched after you close it.

Opening the trunk lid



Fig. 34 On the remote control vehicle key: Button to unlock the trunk lid.

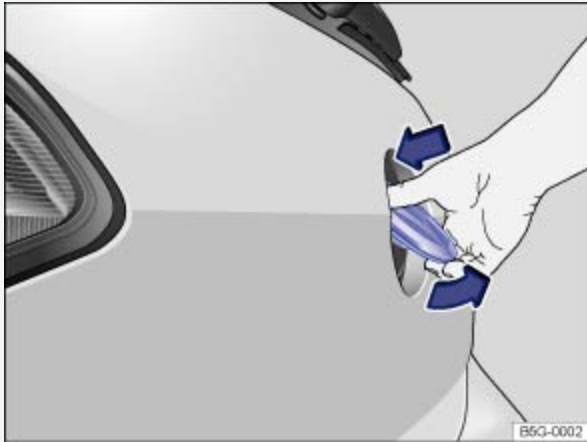


Fig. 35 Opening the trunk lid from the outside.



Read and follow the introductory information and safety information first ⇒ [Introduction to the subject](#)

Always remove any item(s) being transported on the trunk lid before opening it ⇒ .

Unlocking with the vehicle key

Press and hold the button on the remote control vehicle key ⇒ [Fig. 34](#) to unlock the trunk lid. Then open the trunk lid using the Volkswagen emblem.

Opening with the Volkswagen emblem

- Unlock the vehicle or the trunk lid, or open a door.
- Using your thumb, press the top of the Volkswagen emblem ⇒ [Fig. 35](#) and move the top of the emblem down. Grasp the bottom part of the emblem and pull to lift the trunk lid.

WARNING

Improper or unsupervised unlocking or opening of the trunk lid can cause severe injuries. Never

- If a bicycle or luggage rack is installed on the trunk lid, it may be hard to see that the trunk lid is unlatched. An unlatched trunk lid may open suddenly when the vehicle is moving.

NOTE

Before opening or closing the trunk lid, make sure there is enough room to do so, for example, when the vehicle has a trailer or is in a garage.



At temperatures below +32 °F (0 °C), the trunk lid may be difficult to open after you unlock it.

Closing the trunk lid

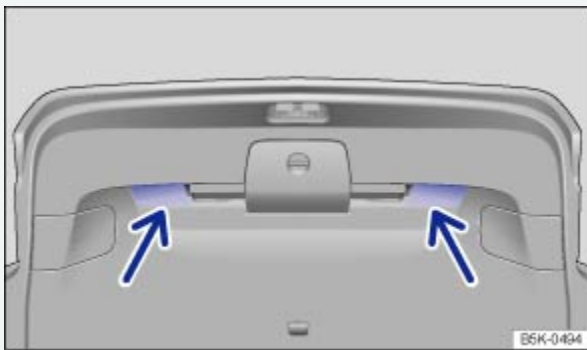


Fig. 36 Opened trunk lid: Recessed grips for closing.



Read and follow the introductory information and safety information first ⇒ [Introduction to the subject](#)


Closing the trunk lid

- Grasp one of the recessed grips in the trunk lid trim ⇒ [Fig. 36](#) (arrows).
- Pull the trunk lid down and close it securely so that the latch engages.
- Check the trunk lid to make sure it is securely latched.

Locking the trunk lid

If you unlock the vehicle with the vehicle key, but do not open either a door or the trunk lid within several seconds, the vehicle is automatically locked again. This feature helps prevent you from leaving the vehicle unlocked unintentionally.



- The power locking system also locks the trunk lid.
- If the trunk lid of a locked vehicle is unlocked with the  button ⇒ [Fig. 34](#) on the remote control vehicle key, it will lock again immediately after it is closed. The anti-theft alarm system, if equipped, is activated after the vehicle is locked ⇒ [Power locking system](#).
- A closed but unlocked trunk lid automatically locks at speeds above about 5 mph (10 km/h).

WARNING

Improper or unsupervised closing of the trunk lid can cause severe injuries. Never close the trunk lid when someone is in the way.

- Never leave your vehicle unattended or let children play around your vehicle, especially with the trunk lid left open. A child could crawl into the vehicle and pull the trunk lid shut, becoming trapped and unable to get out. A closed vehicle can become very hot or very cold depending on the season. Temperatures can quickly reach levels that can cause unconsciousness or death, particularly to small children.



Make sure that the remote control vehicle key is not in the luggage compartment before closing the trunk lid.

Power windows

Introduction to the subject

In this chapter you will find information on the following subjects:

⇒ [Opening or closing power windows](#)

⇒ [Power windows – features](#)

⇒ [Power window pinch protection](#)

WARNING

- Never let anyone get in the way of a power window when closing it.
- When locking the vehicle from the outside, make sure that no one, especially children, remains in the vehicle. The windows will not open in case of an emergency.
- Always switch off the engine and the ignition and take the key with you when you leave the vehicle. You can still use the power windows for several minutes after the ignition is switched off as long as the driver or front passenger door has not been opened.
- Always use the safety switch when children are in the back seat to disable the rear power windows and keep them from being opened and closed.

NOTE

If you leave the windows open, rain or other precipitation may enter the vehicle from outside and can damage the vehicle interior.

Opening or closing power windows

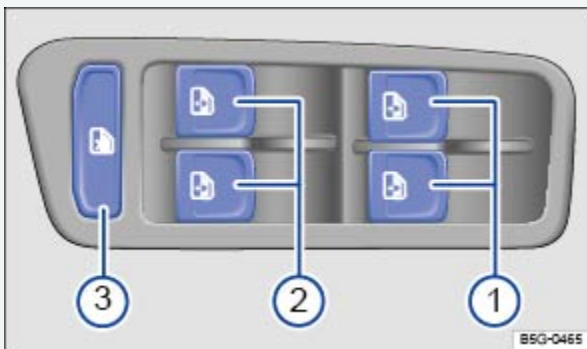


Fig. 37 In the driver door: Switches for the front and rear power windows (4-door version shown).






Read and follow the introductory information and safety information first ⇒ [Introduction to the subject](#)

Switches in the driver door

Key to ⇒ [Fig. 37](#) :

- ① For the windows in the front doors.
- ② For the windows in the rear doors.
- ③ Safety switch.



Function	Action
Opening:	Press the  switch.
Closing:	Pull the  switch.
Stopping automatic movement:	Press/pull the respective switch again.
	The safety switch \Rightarrow Fig. 37 [Ⓢ] deactivates the power windows in the rear doors. The yellow indicator light in the switch comes on (4-door models only).

The power windows function only when the ignition is switched on.

You can still use the power windows for several minutes after the ignition is switched off as long as the driver or front passenger door has not been opened. When the vehicle key has been removed from the ignition and the driver door has been opened, the power windows cannot be opened or closed.



A separate switch for controlling the passenger side window is located in the front passenger door.

Power windows – features



Read and follow the introductory information and safety information first \Rightarrow [Introduction to the subject](#)

One-touch opening and closing

The one-touch feature automatically opens/closes a power window all the way. The window switch



For one-touch opening: Press the switch for the window down briefly as far as it goes.

For one-touch closing: Pull the switch for the window up briefly as far as it goes.

Stopping automatic movement: Pull/press the switch again.

Reactivating the one-touch feature

If the vehicle battery is disconnected or dead and the windows are not completely closed, the one-touch feature will not work and must be reactivated:


- Switch on the ignition.
- Close all windows and doors.
- Pull the switch for the respective window up and hold it for at least 2 seconds in this position.
- Release the switch, pull up and hold again. The one-touch feature is now reactivated.

The one-touch feature can be reactivated for one or more windows at the same time.

Convenience opening and closing

Your vehicle may be equipped with the convenience opening and closing feature.

The convenience opening and closing feature lets you open and close the windows and the power sunroof when the ignition is switched off:

You can configure settings for the convenience opening feature in the Infotainment system by pressing the **CAR** button followed by the  and Opening and closing function keys ⇒ [Menu and system settings](#).

- *Convenience opening from inside the vehicle:* Push down and hold the switch for the driver window until all windows open and the sunroof tilts.
- *Convenience closing for vehicles with Keyless Access:* Hold your finger on the lock sensor surface on the outside of the door handle for a few seconds until the windows and power sunroof close ⇒ [Unlocking or locking the vehicle with Keyless Access](#).

 **WARNING**



- Never let anyone get in the way of a power window when closing it.
- When locking the vehicle from the outside, make sure that no one, especially children, remains in the vehicle. The windows will not open in case of an emergency.
- Always switch off the engine and the ignition and take the key with you when you leave the vehicle. You can still use the power windows for several minutes after the ignition is switched off as long as the driver or front passenger door has not been opened.
- Always use the safety switch when children are in the back seat to disable the rear power windows and keep them from being opened and closed.



If the power windows malfunction, the one-touch feature, as well as pinch protection may not work properly. See an authorized Volkswagen dealer or authorized Volkswagen Service Facility right away.



Convenience closing only works when the one-touch feature is active.

Power window pinch protection



Read and follow the introductory information and safety information first ⇒ [Introduction to the subject](#)

Pinch protection can help reduce the risk of pinching injuries when closing a power window ⇒ ⚠️. If one-touch window closing meets resistance or there is something in the way, the window will stop and go down again.

- Check why the window did not close.
- Try one-touch window closing again.
- If the window meets resistance a second time, so that it stops and goes back down, one-touch closing is deactivated for about 10 seconds.
- If you pull the power window button up all the way and hold it during this 10 second interval, the window will close without pinch protection ⇒ ⚠️.



- Try to close the window again within 10 seconds by holding the switch. Pinch protection is turned off for a short distance in the window track!
- If closing takes longer than about 10 seconds, pinch protection is turned on again. The window stops again if there is resistance.
- If the window still will not close, please see an authorized Volkswagen dealer or an authorized Volkswagen Service Facility.

WARNING

Without pinch protection, power windows will close with enough force to cause serious personal injury.

- Always be careful when closing power windows.
- Always make sure that no one is in the way when overriding pinch protection to close power windows!
- Pinch protection cannot prevent fingers or other parts of the body from being pressed against the window frame; injuries may result.



Pinch protection is also active during convenience closing of the windows and the power sunroof
⇒ [Power windows - features](#).

Power sunroof

Introduction to the subject

In this chapter you will find information on the following subjects:

⇒ [Opening or closing the power sunroof](#)

⇒ [Power sunroof – features](#)

⇒ [Pinch protection for the power sunroof](#)

Depending on equipment, your vehicle may be equipped with a Panoramic sliding and tilting sunroof.



Improper use of the power sunroof can result in serious personal injury.

- Always make sure that no one is in the way of the power sunroof when it is closing.
- Always switch off the engine and the ignition and take the key with you when you leave the vehicle.
- Never leave children or disabled persons in the vehicle – particularly if they have access to the vehicle key. Unsupervised use of the remote control vehicle key makes it possible to lock the vehicle, start the engine, turn on the ignition and operate the sunroof.
- You can still open or close the power sunroof for several minutes after you switch off the ignition, as long as the driver or front passenger door has not been opened.

NOTE

- To help prevent damage, remove ice and snow from the sunroof before opening or tilting it in winter weather.
- Always close the sunroof before leaving the vehicle or if it begins raining. If the sunroof is open or tilted, rain could enter the vehicle interior and cause extensive damage to the electrical system. This could result in further vehicle damage.



Remove leaves and other objects from the sunroof guiderails regularly either by hand or using a vacuum cleaner.



If the power sunroof malfunctions, pinch protection may not function properly. See an authorized Volkswagen dealer or an authorized Volkswagen Service Facility.

Opening or closing the power sunroof



Fig. 38 In the headliner: Power sunroof switch.



Read and follow the introductory information and safety information first ⇒ [Introduction to the subject](#)

You must switch on the ignition to operate the power sunroof. After switching off the ignition, you can still open or close the power sunroof for several minutes as long as the driver or front passenger door has not been opened.

The switch ⇒ [Fig. 38](#) has 2 detents for each switch position (A, B, C, and D), which are described in the following table.

Press the switch to the first detent to completely or partially tilt, open, or close the sunroof. Press the switch briefly to the second detent to activate the one-touch feature (automatic operation). Press the switch again to stop the one-touch feature.

Tilting, opening, and closing the power sunroof

Function	Action ⇒ Fig. 38
Tilt the power sunroof	<p>Press the rear area of the switch B upward to the first detent.</p> <p>Briefly press the switch to the second detent to activate the one-touch feature.</p>



<p>Close the tilted sunroof</p>	<p>Press the front area of the switch Ⓐ upward to the first detent.</p> <p>Briefly press the switch to the second detent to activate the one-touch feature.</p>
<p>Stop the one-touch feature during tilting/closing</p>	<p>Press the button again at position Ⓐ or Ⓑ.</p>
<p>Open the power sunroof</p>	<p>Press the switch rearward Ⓒ to the first detent.</p> <p>Briefly press the switch to the second detent to open the roof to the comfort position with the one-touch feature.</p>
<p>Close the power sunroof</p>	<p>Press the switch forward Ⓓ to the first detent.</p> <p>Briefly press the switch to the second detent to activate the one-touch feature.</p>
<p>Stop the one-touch feature during opening/closing</p>	<p>Press the switch again at Ⓒ or Ⓓ.</p>

Opening and closing the sunshade



to slide it to the required position. It does not open or close automatically with the power sunroof.

Emergency closing of the power sunroof

If your power sunroof will not close properly, do not try to close it yourself, doing so can cause serious and expensive damage that will not be covered by any Volkswagen Limited Warranty. Special knowledge and tools are required to close the power sunroof if it will not close on its own. To help prevent damage to the sunroof, have an authorized Volkswagen dealer or an authorized Volkswagen Service Facility help you close and repair the power sunroof.



The comfort position provides sufficient ventilation without loud wind noise.


Power sunroof – features



Read and follow the introductory information and safety information first ⇒ [Introduction to the subject](#)

Convenience opening and closing

Your vehicle may be equipped with the convenience opening and closing feature.

You can configure settings for the convenience opening feature in the Infotainment system by pressing the **CAR** button followed by the  and Opening and closing function keys ⇒ [Menu and system settings](#).


The convenience opening and closing feature lets you open and close the windows and the power sunroof when the ignition is switched off:

- *Convenience opening from inside the vehicle:* Push down and hold the switch for the driver window until all windows open and the sunroof tilts.
- *Convenience closing for vehicles with Keyless Access:* Hold your finger on the lock sensor surface on the outside of the door handle for a few seconds until the windows and power sunroof close ⇒ [Unlocking or locking the vehicle with Keyless Access](#).

Pinch protection for the power sunroof





subject

Pinch protection can help reduce the risk of pinching injuries when closing the power sunroof ⇒  . If the power sunroof closing meets resistance or there is something in the way, the power sunroof opens again immediately.

- Check why the power sunroof did not close.
- Try to close the power sunroof again.
- If the power sunroof still cannot close, the power sunroof will stop where the resistance is located. The power sunroof will close the next time without pinch protection.

Closing the power sunroof without pinch protection

- Press the  button ⇒ [Fig. 38](#) within about 5 seconds after the sunroof has stopped and hold it in the direction of the arrow  at the second detent until the power sunroof closes completely.
- The power sunroof will now close without pinch protection!
- If the power sunroof still will not close, please see an authorized Volkswagen dealer or an authorized Volkswagen Service Facility.

WARNING

Without pinch protection, the power sunroof will close with enough force to cause serious personal injury.

- Always be careful when closing the power sunroof.
- Always make sure that no one is in the way when overriding the pinch protection to close the power sunroof!
- Pinch protection cannot prevent fingers or other parts of the body from being pressed against the edge of the roof; injuries may result.



Pinch protection is also active during convenience closing of the windows and the power sunroof ⇒ [Power sunroof - features](#) .





Volkswagen dealer or an authorized Volkswagen service facility for assistance.

Sitting properly and safely

Adjusting the seating position



Introduction to the subject

In this chapter you will find information on the following subjects:

⇒ *Examples of improper seating positions*

⇒ *Proper seating position*

⇒ *Manual controls on the driver and front passenger seats*

⇒ *Electrical controls on the driver and front passenger seats*

⇒ *Adjusting the front and rear head restraints*

⇒ *Removing and reinstalling the front head restraints*

⇒ *Removing and reinstalling the rear head restraints*

⇒ *Adjusting the steering wheel position*

⇒ *Center armrest (Golf, Golf GTI)*

⇒ *Center armrest (Golf R)*

Number of seats

The vehicle has a total of 5 seating positions: 2 in front and 3 in the rear. Each seating position has a safety belt.



WARNING



dents, especially when the airbag deploys.

- All occupants must sit properly and be properly restrained at all times.
- Never let more people ride in the vehicle than there are seating positions with safety belts available.
- Always secure children in the vehicle with an approved and suitable restraint system appropriate for their age, weight, and height ⇒ *Child safety and child restraints* , ⇒ *Airbag system* .
- Always keep your feet on the floor in front of the seat. Never rest them on the seat, instrument panel, out of the window, etc. The airbag system and safety belt will not be able to protect you properly and can even increase the risk of injury in a crash.

WARNING

Always adjust seat, safety belts, and head restraints properly before driving and make sure that all passengers are properly restrained.

- Push the passenger seat as far back as possible. Always be sure that there are at least 10 inches (25 cm) between the front passenger's breastbone and the instrument panel.
- Always adjust the driver's seat and the steering wheel so that there are at least 10 inches (25 cm) between your breastbone and the steering wheel.
- Adjust the driver's seat so that you can easily push the pedals all the way to the floor while keeping your knee(s) slightly bent.
- If these requirements cannot be met for physical reasons, contact an authorized Volkswagen dealer or an authorized Volkswagen Service Facility to see whether adaptive equipment is available.
- Always hold the steering wheel on the outside of the steering wheel rim with your hands at the 9 o'clock and 3 o'clock positions to help reduce the risk of personal injury if the driver's airbag inflates.
- Never hold the steering wheel at the 12 o'clock position or with your hands at other places inside the steering wheel rim or on the steering wheel hub. Holding the steering wheel the wrong way can cause serious injuries to the hands, arms, and head if the driver's airbag inflates.
- Pointing the steering wheel toward your face decreases the ability of the driver's airbag to



- Never drive with backrests reclined or tilted back farther than necessary to drive comfortably. The farther back the backrests are tilted, the greater the risk of injury caused by incorrect positioning of the safety belts and improper seating position.
- Never drive with the front seat passenger backrest tilted forward. If the front airbag deploys, the front backrest can be forced backward and injure passengers on the rear seat.
- Sit as far back as possible from the steering wheel and the instrument panel.
- Always sit upright with your back against the backrest with the front seats properly adjusted. Never lean against or place any part of your body too close to the area where the airbags are located.
- Rear seat passengers who are not properly seated and restrained are more likely to be seriously injured in a crash.

WARNING

Improper adjustment of the seats can cause accidents and severe injuries.

- Never adjust the seats while the vehicle is moving. Your seat may move unexpectedly and you could lose control of the vehicle. In addition, you will not be in the correct seating position while adjusting the seats.
- Adjust the front seat height, angle and longitudinal direction only if the seat adjustment area is clear.
- The adjustment of the front seats must not be restricted by things in the footwell in front or behind the seats.

WARNING

Some kinds of cigarette lighters can be lit unintentionally, or crushed causing a fire that can result in serious burns and vehicle damage.


- Always make sure that there are no lighters in the seat tracks or near other moving parts before adjusting the seats.
- Before closing a storage compartment, always make sure that no cigarette lighter can be activated, crushed, or otherwise damaged.
- Never leave a cigarette lighter in a storage compartment, on the instrument panel, or in other



... can result in temperatures in the vehicle that are much higher than the outside temperatures, particularly in summer. High temperatures could cause the cigarette lighter to catch fire.

Examples of improper seating positions



Read and follow the introductory information and safety information first ⇒  [Introduction to the subject](#)

Not wearing or improperly fastening safety belts increases the risk of severe or fatal injuries. Safety belts can work only when they are properly positioned on the body. An improper seating position significantly impairs the protection provided by safety belts. This can cause severe or even fatal injuries. Improper seating positions also increase the risk of serious injury or death when an airbag deploys and strikes an occupant who is not in the proper seating position. The driver is responsible for all passengers and especially children riding in the vehicle.

The following are only some examples of seating positions that will increase the risk of serious injury or death.

Therefore, whenever the vehicle is moving:

- Never stand up in the vehicle.
- Never stand on the seats.
- Never kneel on the seats.
- Never ride with the seat backrest reclined.
- Never lean up against the instrument panel.
- Never lie down on the rear seat.
- Never sit on the edge of the seat.
- Never sit sideways.
- Never lean out the window.
- Never put your feet out the window.
- Never put feet on the instrument panel.
- Never rest your feet on the seat cushion or back of the seat.

- Never sit or stand on an armrest.
- Never ride without your safety belt properly fastened.
- Never ride in the luggage compartment.

WARNING

Contact with parts of the vehicle interior can cause serious personal injury in a crash.

- Always make sure that all vehicle occupants stay in a proper seating position and are properly restrained whenever the vehicle is moving.
- Improper seating positions increase the risk of serious and fatal injury, especially when an airbag deploys and strikes a passenger in an improper seating position.

Proper seating position

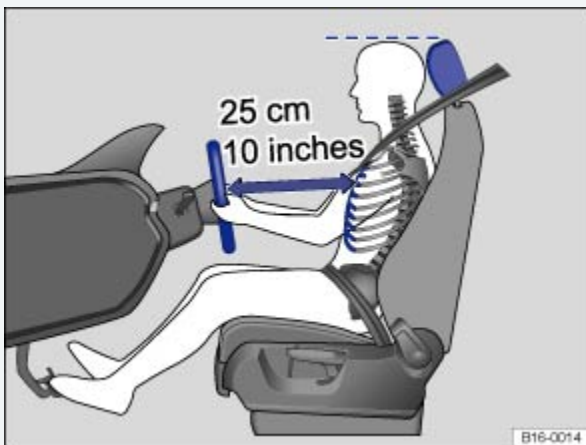


Fig. 39 The driver should never sit closer than 10 inches (25 cm) from the steering wheel.

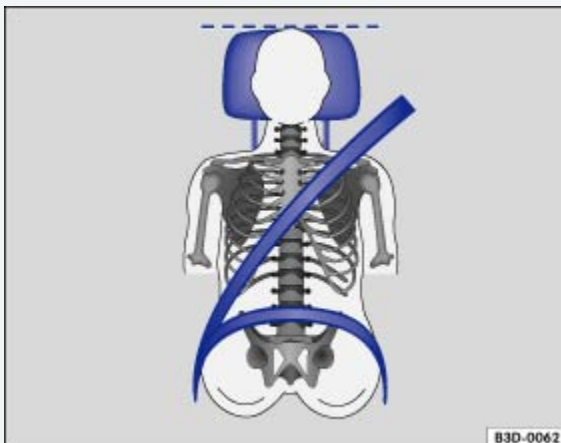


Fig. 40 Proper safety belt positioning and head restraint adjustment.



subject

The following describes the proper seating positions for the driver and passengers.

If you have a physical impairment or condition that prevents you from sitting properly on the driver seat with the safety belt properly fastened and reaching the pedals, special modifications to your vehicle may be necessary. Only the proper seating position ensures optimum protection by the safety belt and airbag.

Contact your authorized Volkswagen dealer or authorized Volkswagen Service Facility or call the Volkswagen Customer CARE Center at 1-800-822-8987 for information about possible modifications to your vehicle.

For your own safety and to reduce injuries in the event of sudden braking maneuvers or accidents, Volkswagen recommends the following seating positions:

Applies to all vehicle occupants:

- Adjust head restraints so that the upper edge of the head restraint is at least at eye level or higher. Position the back of your head as close as possible to the head restraint ⇒ [Fig. 39](#) and ⇒ [Fig. 40](#).
- Push the head restraint completely down for short people, even if the top of the head is then below the upper edge of the head restraint.
- Tall people should pull the head restraint all the way up.
- Adjust the seat backrest angle to an upright position so that your back is in full contact with it when the vehicle is moving.
- Always keep both feet on the floor and in the footwell whenever the vehicle is moving.
- Always adjust and fasten safety belts properly ⇒ [Safety belts](#).

Driver - seat and steering wheel adjustment:

- Adjust the steering wheel so that there are at least 10 inches (25 cm) between the steering wheel and your breast bone ⇒ [Fig. 39](#). When adjusting the proper distance to the steering wheel, grasp the top of the steering wheel with your elbows slightly bent.
- Always hold the steering wheel on the outside of the steering wheel rim with your hands at the 9 o'clock and 3 o'clock positions to help reduce the risk of personal injury if the driver's airbag in-

- Never hold the steering wheel at the 12 o'clock position or with your hands at other places inside the steering wheel rim or on the steering wheel hub. Holding the steering wheel the wrong way can cause serious injuries to the hands, arms, and head if the driver's airbag inflates.
- Adjust the steering wheel so that the steering wheel cover points at your chest and not at your face. Pointing the steering wheel toward your face decreases the ability of the driver's airbag to help protect you in a collision.
- Adjust the driver's seat so that you can easily push the pedals all the way to the floor while keeping your knee(s) slightly bent.
- Adjust the seat height so that the top point of the steering wheel can be reached.
- Always keep both feet in the footwell so that you are in control of the vehicle at all times.

Passenger - front seat adjustment:

- Push the passenger seat as far back as possible in order to ensure optimum protection if the airbag is deployed.

Manual controls on the driver and front passenger seats

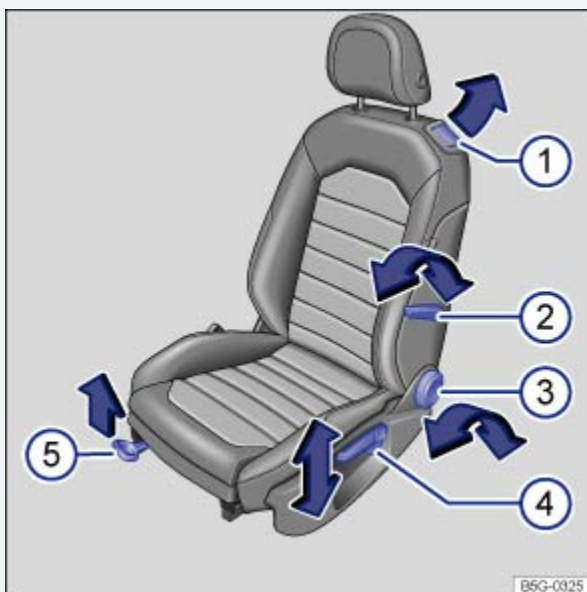


Fig. 41 Driver seat: Manual seat adjustment controls.



Read and follow the introductory information and safety information first ⇒ [Introduction to the subject](#)



be different combinations of manual and electrical controls, depending on vehicle equipment.

The illustration and information in this section describes all possible seat controls. The number of controls may vary depending on the version of the seat.

There may be manual and electrical controls on the same seat.

⇒ Fig. 4 1	Function	Action
①	Fold the seat backrest forward or back into place (2-door vehicles only).	<p><i>Folding forward:</i> Pull lever and fold seat backrest forward. Push the seat forward at the same time.</p> <p><i>Folding back into place:</i> Slide the seat back as far as it will go until it clicks into place. The backrest releases automatically and can be folded backwards. Engage the seat backrest in an upright position.</p>
②	Adjust the lumbar support.	Push the lever forward or pull it backward.
③	Adjust the backrest angle.	<p>Lean forward and turn the adjuster wheel forward or backward.</p> <p>If the vehicle has an electrical control for adjusting the backrest angle, see ⇒ Fig. 42②.</p>

④	Adjust the seat height.	Move the lever several times up or down.
⑤	Move the front seat forward or back.	Pull the lever up and move the front seat. The front seat must lock in place after the lever is released!

Electrical controls on the driver and front passenger seats

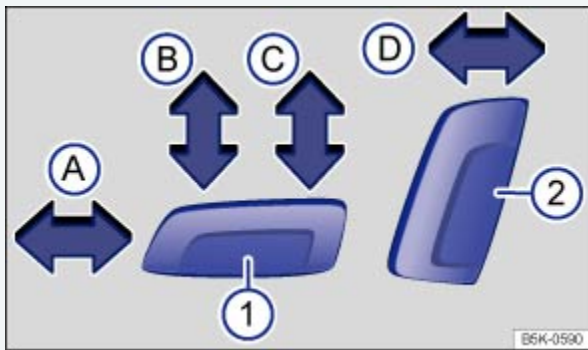


Fig. 42 Driver seat: Electrical controls to move the seat backward or forward, and adjust seat cushion height and backrest angle (if equipped).

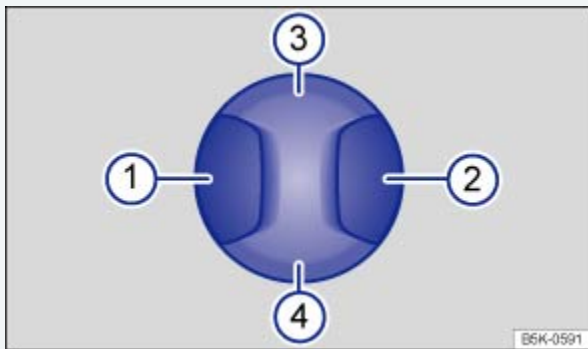


Fig. 43 Lumbar support control (if equipped).

Read and follow the introductory information and safety information first ⇒ [Introduction to the subject](#)

If your vehicle is equipped with electrical controls for the front seats, the controls on the front passenger seat either mirror those on the driver seat or there may be different combinations of electrical



There may be manual and electrical controls on the same seat.

Press the switch in the direction of the arrow ⇒ *Fig. 42*:

①	Ⓐ	Slide the seat forward or back.
	Ⓑ	Adjust the seat cushion angle.
	Ⓒ	Raise or lower the seat cushion.
②	Ⓓ	Adjust the backrest angle.

Press the switch in the corresponding area ⇒ *Fig. 43*:

① or ②	Adjust the curve of the lumbar support.
③ or ④	Adjust the height of the lumbar support.

WARNING

Improper use of electrical seat controls can cause serious personal injuries.

- The front seats in your vehicle can be electrically adjusted even when the vehicle key has been removed from the ignition or, on a vehicle with Keyless Access, even if there is no key in the vehicle.
- Never leave children and persons who need help in the vehicle alone because the unsupervised use of the electric seat adjustments can result in serious personal injury.
- Always make sure that no one is in the way while the front seats are being adjusted, or while calling up the stored memory settings for the front seats. In an emergency, stop automatic seat adjustment by pressing a seat adjustment switch.

To help prevent damage to electrical parts in the seat, do not kneel on the front seats or apply concentrated pressure to a small area of the seat or backrest.



If the vehicle battery is too weak, the electrical seat adjustment controls may not work.



When entering and exiting the vehicle, be careful not to come into contact with any switches that could change the seat adjustment.

Adjusting the front and rear head restraints

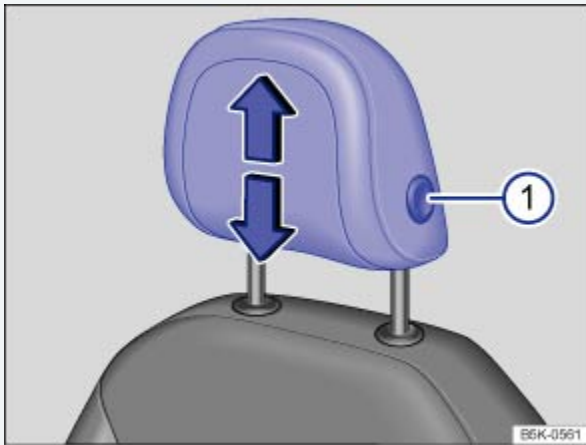


Fig. 44 Adjusting the front head restraints.

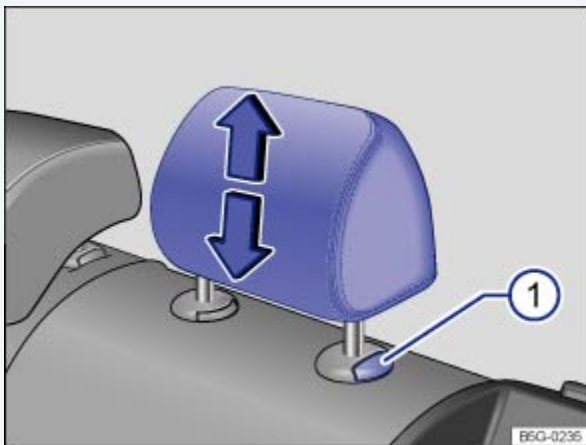


Fig. 45 Adjusting the rear head restraints.




Read and follow the introductory information and safety information first ⇒ [Introduction to the subject](#)



center seat on the rear bench. Therefore, only install the center head restraint in the center position.

There are notches in the head restraint guide rods so that the head restraint can lock into place. Only properly installed head restraints can lock into place at the adjustment range notches. In order to prevent inadvertent removal of the head restraints after installation, there are stops at the top and bottom of the adjustment range.

Adjusting the height

- Pull the head restraint up in the direction of the arrow, or push it down while pressing the button ⇒ Fig. 44① or ⇒ Fig. 45① ⇒  .
- The head restraint must lock securely in the position selected.

Proper head restraint adjustment

Adjust head restraints so that the upper edge of the head restraint is at least at eye level or higher. Position the back of the head as close as possible to the head restraint.

Adjusting the head restraint for shorter people

Push the head restraint down as far as it will go, even if this means the person's head is still below the top edge of the head restraint. A small gap may remain between the head restraint and the backrest when the head restraint is all the way down.

Adjusting the head restraint for taller people

Pull the head restraint up as far as it will go.

WARNING

Driving without head restraints or with improperly adjusted head restraints increases the risk of serious injuries in a collision.

- Always drive with the head restraints in place and properly adjusted to help minimize the risk of neck injury in a crash.
- Every person in the vehicle must have a properly adjusted head restraint to minimize the risk of neck injury in a crash. Each head restraint must be adjusted according to the occupants' size so that the upper edge is even with the top of the person's head, but no lower than eye level. Always sit so that the back of your head is as close as possible to the head restraint.

Removing and reinstalling the front head restraints

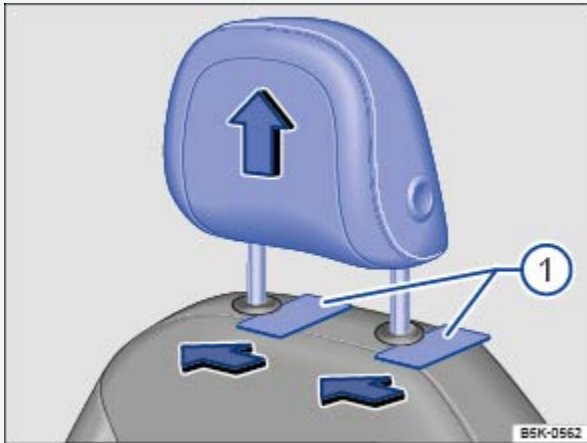


Fig. 46 Removing the front head restraints.



Read and follow the introductory information and safety information first ⇒ [Introduction to the subject](#)

All seats are equipped with head restraints. For instructions on removing and reinstalling the rear head restraints, see ⇒ [Removing and reinstalling the rear head restraints](#).

Removing the front head restraints

- Sit in the back seat behind the head restraint you want to remove. Pull the head restraint all the way up ⇒ . Recline the backrest with the head restraint so that there is enough overhead clearance to remove it.
- Slide a flat object, such as a plastic credit card, underneath the right side of the cap (left side if sitting behind the head restraint) on the right-hand seat guide rod ⇒ [Fig. 46](#) to unlock the head restraint.
- Push the flat object (plastic card) in against the guide rod to depress a release button located under the cap (not visible).
- Use one hand to hold the release button in with the flat object. With your other hand, lift the same guide rod slightly to expose a notch in the rod at the bottom (can be seen and felt with fingers). The right-hand guide rod is now released.
- To release the left-hand guide rod, press the flat object in (towards guide rod) and hold.
- Pull the head restraint out completely.

- Position head restraint properly over the head restraint guides of the respective seat backrest and insert the head restraint into the guides.
- Push the head restraint down ⇒ *Fig. 46*.
- Adjust the head restraint according to the occupant's size ⇒ *Adjusting the front and rear head restraints*.

WARNING

Driving without head restraints or with improperly adjusted head restraints increases the risk of serious injuries in a collision.

- Always drive with the head restraints in place and properly adjusted to help minimize the risk of neck injury in a crash.
- Always reinstall head restraints as soon as possible so that vehicle occupants are properly protected.

NOTE

When removing or reinstalling the head restraint, take care that the head restraint does not strike the headliner or other parts of the vehicle. The headliner or other parts of the vehicle could otherwise be damaged.

Removing and reinstalling the rear head restraints

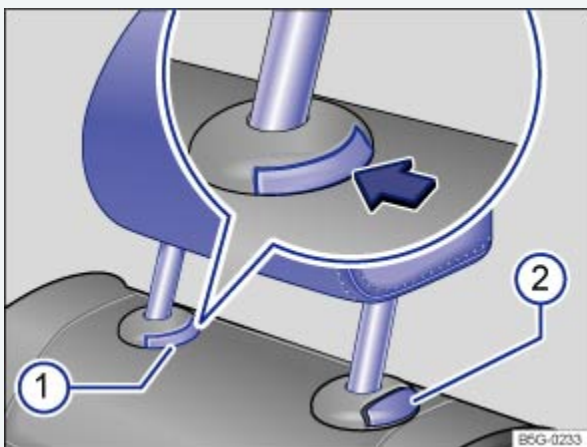


Fig. 47 Removing the rear head restraint (version A).

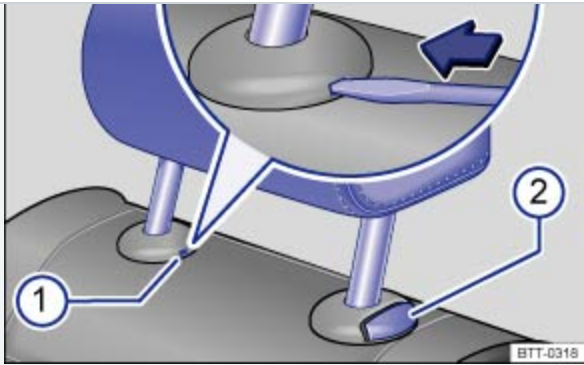



Fig. 48 Removing the rear head restraint (version B).




Read and follow the introductory information and safety information first ⇒ [Introduction to the subject](#)

All seats are equipped with head restraints. The rear center head restraint is designed only for the center seat on the rear bench. Therefore, only install the center head restraint in the center position. For instructions on removing and reinstalling the front head restraints, see ⇒ [Removing and reinstalling the front head restraints](#)

Removing the rear head restraints (Version A)

- Unlock the backrest of the rear seat bench and fold it forward ⇒ [Luggage compartment](#).
- Pull the head restraint all the way up ⇒ .
- Push button ⇒ [Fig. 47](#) in the direction of the arrow and hold it in this position.
- At the same time press button ② while a second person pulls out the head restraint completely.
- Fold the backrest of the rear seat bench back so that it locks securely.

Removing the rear head restraints (Version B)

- Unlock the backrest of the rear seat bench and fold it forward ⇒ [Luggage compartment](#).
- Pull the head restraint all the way up ⇒ .
- If necessary, press the flat blade of the screwdriver from the vehicle tool kit into the slit of the trim cap ⇒ [Fig. 48](#) in the direction of the arrow and hold it in this position.
- At the same time press button ② while a second person pulls out the head restraint completely.
- Fold the backrest of the rear seat bench back so that it locks securely.

- Unlock the backrest of the rear seat bench and fold it forward ⇒ *Luggage compartment*.
- Position head restraint properly over the head restraint guides of the respective seat backrest and insert the head restraint into the guides.
- Push the head restraint down while pressing button ⇒ *Fig. 47* or ⇒ *Fig. 48*.
- Fold the backrest of the rear seat bench back so that it locks securely.
- Adjust the head restraint according to the occupant's size ⇒ *Adjusting the front and rear head restraints*.

WARNING

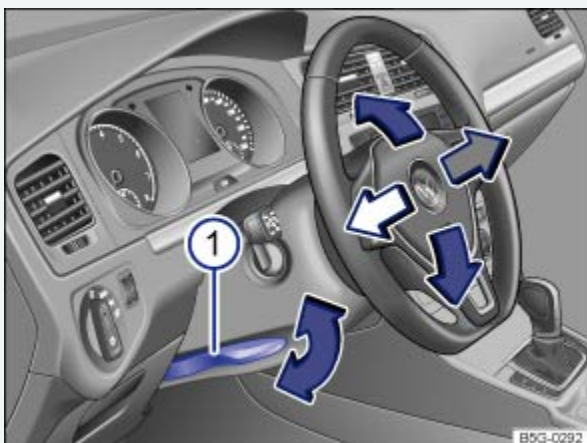
Driving without head restraints or with improperly adjusted head restraints increases the risk of serious injuries in a collision.

- Always drive with the head restraints in place and properly adjusted to help minimize the risk of neck injury in a crash.
- Always reinstall head restraints as soon as possible so that vehicle occupants are properly protected.

NOTE

When removing or reinstalling the head restraint, take care that the head restraint does not strike the headliner or other parts of the vehicle. The headliner or other parts of the vehicle could otherwise be damaged.

Adjusting the steering wheel position



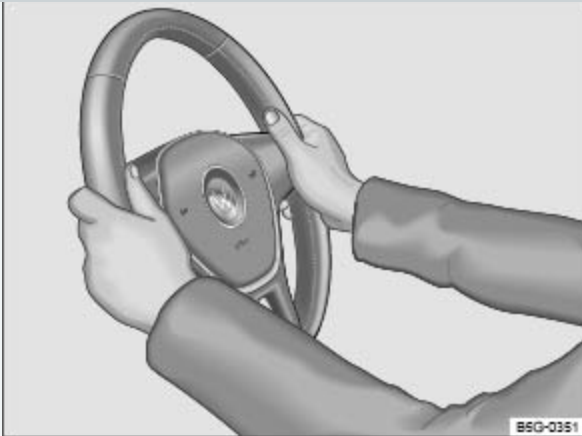


Fig. 50 Steering wheel: 9 o'clock and 3 o'clock positions.



Read and follow the introductory information and safety information first ⇒ [Introduction to the subject](#)

Adjust the steering wheel only when the vehicle is not moving.

- Push down on the lever ⇒ [Fig. 49](#).
- Adjust the steering wheel so that it can be held with hands at the 9 o'clock and 3 o'clock positions on the outside of the steering wheel rim and with the arms slightly bent at the elbow ⇒ [Fig. 50](#).
- Pull the lever up firmly until it is flush with the steering column ⇒

WARNING

Improper use of the steering column adjustment feature can result in serious personal injury and even death.

- Always pull the lever ⇒ [Fig. 49](#) firmly upward after adjusting the steering column so that the steering wheel does not change position suddenly while the vehicle is moving.
- Never adjust the steering column while the vehicle is moving. If you find that you need to adjust the steering wheel while driving, stop the vehicle in a safe place and make the proper adjustment.
- Never adjust the steering wheel so that it points toward your face. Always make sure that the steering wheel points toward your chest. Otherwise, the airbag system cannot protect you properly in the event of a crash.
- Always hold the steering wheel on the outside of the steering wheel rim with your hands at

jury if the driver's airbag inflates.

- Never hold the steering wheel at the 12 o'clock position or with your hands anywhere inside the steering wheel or on the steering wheel hub. Holding the steering wheel the wrong way increases the risk of severe injury to the arms, hands, and head if the driver airbag deploys.

Center armrest (Golf, Golf GTI)

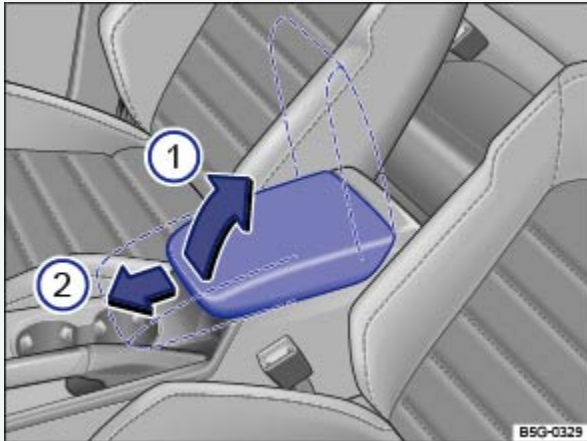


Fig. 51 Front center armrest.

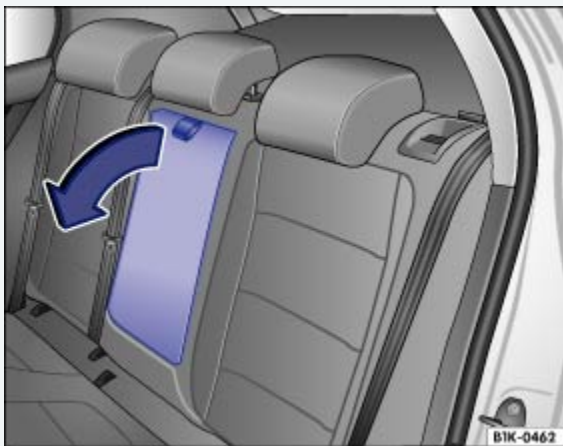


Fig. 52 Folding down the rear center armrest (arrow).



Read and follow the introductory information and safety information first ⇒ [Introduction to the subject](#)

Front center armrest

There may be a storage compartment under the front center armrest ⇒ [Storage areas](#).

To *raise* the center armrest, push the release button, pull the armrest up, and latch upward in the di-



To *lower* the center armrest, first lift it all the way up. Then you can push the center armrest down until it latches in place.

To *move* the center armrest forward and backward, pull it forward in the direction of the arrow ②, or slide it backward until it clicks into place.

Rear center armrest

There may be a fold-down armrest in the backrest of the center rear seat ⇒ [Fig. 52](#).

To *fold down*, pull the loop in the direction of the arrow ⇒ [Fig. 52](#).

To *fold up*, push the center armrest up as far as it will go.

⚠ WARNING

The center armrest can restrict the driver's arm movement and cause crashes and serious personal injury.

- Always keep storage compartments in the center armrest closed while driving.
- Never let a passenger, especially a child, ride on the center armrest. Improper seating position can increase the risk of serious personal injury in a crash.
- Never put hot drinks or other liquids in the cup holders. Hot liquids can spill when the vehicle is moving as well as during braking or other sudden maneuvers.

Center armrest (Golf R)

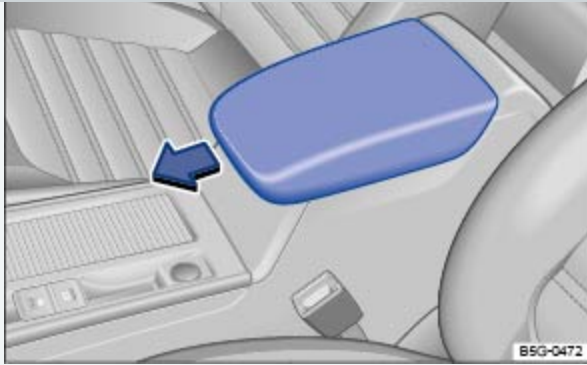


Fig. 53 Front center armrest.

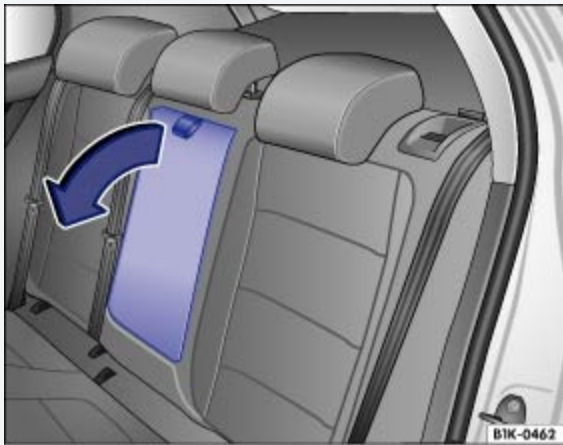


Fig. 54 Folding down the rear center armrest (arrow).



Read and follow the introductory information and safety information first ⇒ [Introduction to the subject](#)

Front center armrest

There is a front center armrest between the driver and front passenger seats ⇒ [Fig. 53](#).

To *move* the center armrest forward and backward, pull it forward in the direction of the arrow or slide it backward until it clicks into place.

Rear center armrest

There may be a fold-down armrest in the backrest of the center rear seat ⇒ [Fig. 54](#).

To *fold down*, pull the loop in the direction of the arrow ⇒ [Fig. 54](#).

To *fold up*, push the center armrest up as far as it will go.

The center armrest can restrict the driver's arm movement and cause crashes and serious personal injury.

- Always keep storage compartments in the center armrest closed while driving.
- Never let a passenger, especially a child, ride on the center armrest. Improper seating position can increase the risk of serious personal injury in a crash.
- Never put hot drinks or other liquids in the cup holders. Hot liquids can spill when the vehicle is moving as well as during braking or other sudden maneuvers.

Seat functions

Introduction to the subject

In this chapter you will find information on the following subjects:

⇒ *Seat heating*

WARNING

Improper use of seat adjustment controls can cause severe personal injuries.

- Always sit properly at all times before starting to drive and while the vehicle is moving. Make sure all passengers, especially children, are properly seated whenever the vehicle is moving.
- Keep hands, fingers, feet and other body parts away from moving parts and adjustment areas of the seats.

Seat heating



Fig. 55 In the center console: Seat heating buttons for the front seats.



subject







Your vehicle may be equipped with a seat heating feature.

When the ignition is switched on, the front seats can be electrically heated by heating elements that warm the seat backrest and cushion.

Depending on vehicle equipment, the seat heating on the driver and passenger side may automatically resume at the setting that was set when the ignition was last switched off.

Do not use the seat heating if any of the following conditions apply:

- If the seat is not being used.
- If there is a child restraint installed on the front passenger seat.
- If there is a blanket or seat cover on the front passenger seat.
- If the seat is damp or wet.
- If the outside temperature or the temperature inside the passenger compartment is +77 °F (+25 °C) or more.

Function	Action for seat heating ⇒ Fig. 55
Switch on:	Press the  or  button. Seat heating is switched on to maximum.
Adjust the heating level:	Press the  or  button repeatedly until the desired heating level is set.
Switch off:	Press the  or  button repeatedly until all indicator lights in the button are off.



tion, paralysis, or chronic illness (e.g. diabetes) should NEVER use the seat heating feature ⇒ ⚠ !

The use of seat heating by persons with these conditions could result in burns to the back, buttocks, and legs that may take a long time to heal and may never heal completely. If you have any of these conditions, you should take regular breaks and get out of the vehicle, particularly on long trips. Consult your doctor for advice regarding your specific condition.

WARNING

Certain medical conditions, such as paralysis and diabetes, and certain medications can increase the risk of serious burns when the seat heating feature is switched on.

- Vehicle occupants who have a low level of perceived pain or a lowered awareness of pain can receive serious burns to the back, buttocks, and legs that take a long time to heal or may never heal completely.
- Never use the seat heating feature if you or your passengers are at risk of being burned because of a medical condition. Take regular breaks and get out of the vehicle, particularly on long trips. Consult your doctor for advice regarding your specific condition.
- Never let exposed skin remain in contact with the seat upholstery when the seat heating is being used.

WARNING

A wet seat can cause the seat heating to malfunction and increase the risk of serious burns.

- Always make sure the seats are dry before using the seat heating.
- Never sit on the seat with wet clothes.
- Never put damp or wet things including clothes on the seat.
- Never spill liquids on the seats.

NOTE

- To help prevent damage to electrical and other parts in the seat, do not kneel on the front seats or apply concentrated pressure to a small area of the seat or backrest.
- Liquids, sharp objects and things that do not let the heat in the seat escape into the air, includ-

ing.

- If you smell an odor, immediately shut off seat heating and have it checked by an authorized Volkswagen dealer or authorized Volkswagen Service Facility.
- Never install leather upholstery on a vehicle with seat heating that originally had cloth upholstery. The seat heating elements for seats with cloth seats will overheat if the cloth upholstery is replaced with leather upholstery.



Switch off seat heating when it is not needed to help reduce unnecessary fuel consumption.

Safety belts



Introduction to the subject

In this chapter you will find information on the following subjects:

⇒ *Warning light*

⇒ *Frontal collisions and laws of physics*

⇒ *What happens to passengers not wearing a safety belt*

⇒ *Safety belts protect*

⇒ *Using safety belts*

⇒ *Fastening and unfastening safety belts*

⇒ *Safety belt position*

⇒ *Safety belt height adjusters*

⇒ *Safety belt extender*


⇒ *Safety belt retractor, pretensioner, load limiter*



Properly worn safety belts are the single most effective means of reducing the risk of serious injury and death in a collision or other accident.

Damage to safety belts reduces their overall effectiveness and increases the risk of serious personal injury and death whenever the vehicle is being used.

Check the condition of all safety belts regularly.

If a safety belt shows damage to webbing, bindings, retractors or buckles, have the safety belt replaced by an authorized Volkswagen dealer or an authorized Volkswagen Service Facility ⇒ .

WARNING

Not wearing a safety belt or wearing an improperly positioned safety belt increases the risk of severe personal injury or death. Safety belts offer optimum protection only when they are used properly.

- Properly worn safety belts are the single most effective means of reducing the risk of serious injury and death in a collision or other accident. For this reason, always wear your safety belt properly and make sure all passengers wear their safety belts properly as well whenever the vehicle is moving.
- The driver must always make sure that every person in the vehicle is properly seated on a seat of his or her own, properly fastens the safety belts belonging to that seat before the vehicle starts to move, and keeps the belts properly fastened while riding in the vehicle. This applies even when just driving around town. Therefore, always wear your safety belts and make sure that everybody in your vehicle is properly restrained.
- Always secure children in the vehicle with a restraint system appropriate for their age, weight and height ⇒ [Child safety and child restraints](#).
- Always fasten safety belts correctly before driving off and make sure that all passengers are properly restrained.
- Never attach the safety belt to the buckle of another seat. Attaching the safety belt to the wrong buckle will reduce safety belt effectiveness and can cause serious personal injury.
- Never let any objects or liquids get into the safety belt latch and prevent it from working properly.



ing injured or killed.

- Never strap more than one person, including small children, into any single safety belt.
- Never let children or babies ride sitting on your lap, and never place a safety belt over a child sitting on your lap.
- Never wear belts over rigid or breakable objects in or on your clothing, such as eyeglasses, pens, keys, etc., as these may cause injury.
- Several layers of heavy clothing (such as a coat worn over top of a sports jacket) may interfere with proper positioning of the safety belt and reduce the overall effectiveness of the system.
- Never use comfort clips or devices that create slack in the shoulder belt. However, special clips may be required for the correct use of some child restraint systems.
- Safety belts offer optimum protection only when the seat backrest is upright and belts are correctly positioned on the body.

WARNING

Damage to safety belts reduces their overall effectiveness and increases the risk of serious personal injury and death whenever the vehicle is being used.

- Never let safety belts become damaged by being caught in the door or seat hardware.
- Torn or frayed safety belts can tear, and damaged safety belt hardware can break in an accident.
- Inspect belts regularly for damage. If webbing, bindings, buckles, or retractors are damaged, have the belts replaced immediately with the correct replacement belts approved by Volkswagen for your vehicle, model, and model year.
- Safety belts that were subject to stress in an accident and stretched must be replaced with a correct, new safety belt, preferably by an authorized Volkswagen dealer or authorized Volkswagen Service Facility.
- Replacement after a crash may be necessary even if a safety belt shows no visible damage. Anchorages that have been loaded must also be inspected.
- Damaged safety belts must be replaced; they cannot be repaired.
- Never try to repair a damaged safety belt yourself. Never remove or modify the safety belts in any way.

dealer or authorized Volkswagen service facility.

- Always keep the belts clean. Dirty belts may not work correctly and can impair the function of the inertia reel.

Warning light



Fig. 56 Warning light in the instrument cluster.



Read and follow the introductory information and safety information first ⇒ [Introduction to the subject](#)

Lights up or flashes

Possible cause

Proper response

Driver and front passenger have not fas-



tened their safety belts, if front passenger


Fasten safety belts.


seat is occupied.

When the ignition is switched on, several warning and indicator lights come on briefly for a function check. They go out after a few seconds.

A warning chime also sounds.

The safety belt warning light comes on for 6 seconds when the ignition is switched on. A warning chime also sounds for up to 6 seconds if the driver's safety belt is not buckled. The chime stops sooner if the driver buckles his or her safety belt. The warning light and the chime go out when both driver and front passenger have buckled their safety belts.

after the chime stops and the vehicle is moving at a speed of more than about 15 mph (25 km/h), the chime will again sound for about 6 seconds, then go off for about 24 seconds, then sound again for about another 6 seconds. The same thing happens if one of the safety belts is fastened and then unfastened while the vehicle is moving. The safety belt warning light  also flashes. The warning chime continues to sound at 24 second intervals for up to 2 minutes. No chime sounds at speeds of less than about 5 mph (8 km/h).

If the ignition is switched on, the safety belt warning light  stays on until the driver and front passenger have both buckled their safety belts.

WARNING

Not wearing a safety belt or wearing an improperly positioned safety belt increases the risk of severe personal injury or death. Safety belts offer optimum protection only when used correctly.

Frontal collisions and laws of physics

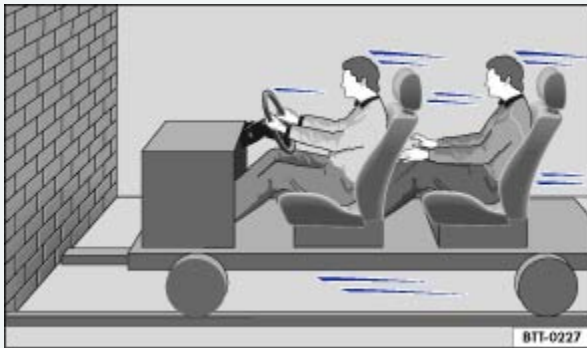


Fig. 57 A vehicle with passengers not wearing safety belts approaches a wall.

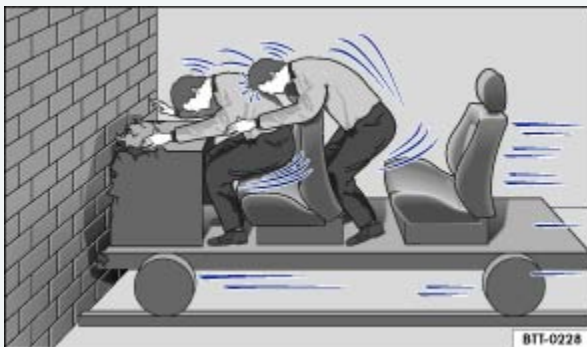




Fig. 58 A vehicle with passengers not wearing safety belts hits a wall.

 Read and follow the introductory information and safety information first \Rightarrow  [Introduction to the subject](#)

possess energy \Rightarrow Fig. 57, which varies with vehicle speed and body weight. Engineers call this energy kinetic energy.

The higher the speed of the vehicle and the greater the vehicle's weight, the more energy has to be absorbed in a crash.

Vehicle speed is the most significant factor. If your speed doubles (for example, from 15 mph to 30 mph – 25 km/h to 50 km/h), the energy increases 4 times!

Because the occupants of the vehicle in the above example are not using safety belts, they are not attached to the vehicle. In a frontal collision, they will keep moving at the same speed the vehicle was moving just before the crash, until something stops them - here, the inside of the passenger compartment. Because the occupants of the vehicle in the example are not wearing safety belts, their entire kinetic energy will be absorbed by impact with the wall \Rightarrow Fig. 58.

The same principles apply to people in a vehicle that is in a frontal collision on the highway. Even at city speeds of 20–30 mph (30–50 km/h), the forces acting on the body can reach one ton (2,000 lbs or 1,000 kg) or more. At greater speeds, these forces are even higher.

Of course, the laws of physics don't apply just to frontal collisions; they determine what happens in all kinds of accidents and collisions.

What happens to passengers not wearing a safety belt



Fig. 59 The unbelted driver is thrown forward.



Fig. 60 Unbelted passengers in the rear seats are thrown forward on top of the belted driver.



Read and follow the introductory information and safety information first ⇒ [Introduction to the subject](#)

Many people believe that it is possible to resist the forces of an impact by holding tight or bracing themselves. That is simply not true!

Even at low collision speeds, the forces acting on the body are too much for the body to be held in the seat with the arms and hands. In a frontal collision, unrestrained occupants will slam violently into the steering wheel, instrument panel, windshield or anything else in the way ⇒ [Fig. 59](#).

Never rely on airbags alone for protection. Even when they deploy, airbags provide only additional protection. Airbags are not supposed to deploy in all kinds of accidents. Even if your vehicle is equipped with airbags, all vehicle occupants, including the driver, must wear safety belts correctly in order to minimize the risk of severe injury or death in a crash, regardless of whether a seating position has an airbag or not.

An airbag will deploy only once. Safety belts are always there to offer protection in those accidents in which airbags are not supposed to deploy or when they have already deployed. Unbelted occupants can also be thrown out of the vehicle, causing even more severe injuries or death.

It is also important for occupants in the rear seats to wear their safety belts properly since they can be thrown violently forward through the vehicle in the event of an accident. Unbelted passengers in the rear seats endanger not only themselves but also the driver and other passengers in the vehicle

⇒ [Fig. 60](#).

Safety belts protect



Fig. 61 Belted driver secured by the correctly worn safety belt in the event of a sudden braking maneuver.



Read and follow the introductory information and safety information first ⇒ ⚠ *Introduction to the subject*

Used properly, safety belts can make a big difference. Safety belts help to keep passengers in their seats, gradually reduce energy levels applied to the body in a collision, and help prevent the uncontrolled movement that can cause serious injuries. In addition, safety belts reduce the danger of being thrown out of the vehicle ⇒ *Fig. 61*.

Safety belts attach passengers to the car and give them the benefit of being slowed down more gently or softly through the give in the safety belts, crumple zones, and other safety features (such as airbags) engineered into today's vehicles. The front crumple zones and other passive safety features (such as the airbag system) are also designed to absorb kinetic energy. By absorbing the kinetic energy over a longer period of time, the forces on the body become more tolerable and less likely to cause injury.

Although these examples are based on a frontal collision, safety belts can also substantially reduce the risk of injury in other kinds of crashes. So, whether you're on a long trip or just going to the corner store, always buckle up and make sure that others do, too.

Accident statistics show that vehicle occupants properly wearing safety belts have a lower risk of being injured and a much better chance of surviving a collision. Properly using safety belts also greatly increases the ability of the supplemental airbags to do their job in a collision. For this reason, wearing a safety belt is required by law in most countries including the United States and Canada.

Although your Volkswagen is equipped with airbags, you still have to wear the safety belts provided. Front airbags, for example, are activated only in some frontal collisions. The front airbags are not acti-



for deployment stored in the electronic control unit are not met. The same goes for the other airbag systems on your Volkswagen.

So always wear your safety belt and make sure that everybody in your vehicle is properly restrained!

Using safety belts



Read and follow the introductory information and safety information first ⇒ [Introduction to the subject](#)

Checklist

Using safety belts ⇒ ⚠

- ✓ Damage to safety belts reduces their overall effectiveness and increases the risk of serious personal injury and death whenever the vehicle is being used.
- ✓ Check the condition of all safety belts regularly.
- ✓ Keep safety belts clean.
- ✓ Keep objects and liquids away from safety belt webbing, the safety belt buckle tongue, and the safety belt buckle latch and opening.
- ✓ Do not pinch or damage the safety belt or buckle tongue (for instance, when closing a door).
- ✓ Never modify, disassemble or try to repair safety belts and safety belt anchorages.
- ✓ Always fasten your safety belt properly before driving and keep it fastened whenever the vehicle is moving.

Twisted safety belt

If it is difficult to pull the safety belt out of the belt guide, the belt may be twisted inside the side trim because the belt retracted too quickly when it was taken off.

- Hold the safety belt tongue, slowly and carefully pull safety belt all the way out.
- Untwist the safety belt and slowly return the belt by hand.

If you cannot untwist the safety belt, wear it anyway. Make sure that the safety belt is twisted in a spot where it does not come in direct contact with your body. Have the safety belt untwisted immediately by an authorized Volkswagen dealer or authorized Volkswagen Service Facility.

The retractors for the rear seat safety belts and the front passenger safety belt have a switchable locking feature for child restraints in addition to the emergency locking feature. Whenever a child restraint is installed with a safety belt, the safety belt must be locked so that the safety belt webbing cannot unreel. The switchable locking feature lets you lock the belt so that a child restraint can be properly installed and, for example, so that it can't tip to the side when the vehicle goes around a corner ⇒ [Child safety and child restraints](#).

To see whether a safety belt is lockable, pull the safety belt *all the way* out of the safety belt retractor. You should then hear a clicking sound as the belt winds back into the retractor reel. Test the switchable locking feature by pulling on the belt. When the switchable locking feature is active, you should no longer be able to pull the belt out of the retractor.

The locking feature must be deactivated when a vehicle occupant uses the safety belt.

WARNING

Improper use and care of safety belts increases the risk of severe personal injury or death.

- Regularly check safety belts and related parts for damage.
- Damaged safety belts must be replaced; they cannot be repaired.
- Always keep safety belts clean.
- Never catch, damage or chafe safety belt webbing on sharp edges.
- Always keep objects and liquids away from the belt buckle and buckle opening.

Fastening and unfastening safety belts



Fig. 62 Inserting the buckle tongue into the belt buckle.



Fig. 63 Releasing the buckle tongue from the belt buckle.



Read and follow the introductory information and safety information first ⇒ [Introduction to the subject](#)

Properly worn safety belts help to hold occupants in their seats and provide optimum protection during braking or in a collision or other accident ⇒ .

The switchable locking feature makes a clicking sound when the safety belt is winding back onto the safety belt retractor wheel after being pulled *all the way* out. Whenever a child restraint is installed with a safety belt, the safety belt must be locked so that the safety belt webbing cannot unreele ⇒ [Child safety and child restraints](#) . If active, deactivate the locking feature before using the safety belt to restrain a person without a child restraint system.

Fastening safety belts

Always buckle your safety belt before driving.

- Adjust the front seat and head restraint correctly ⇒ [Adjusting the seating position](#) .
- Make sure the seat backrest of the rear seat bench is in an upright position and securely latched in place before using the safety belt ⇒ .
- Hold the safety belt by the tongue and pull it slowly and evenly across the chest and pelvis. Do not twist the safety belt webbing ⇒ .
- Insert the tongue into the correct buckle for your seat until you hear it latch securely ⇒ [Fig. 62](#) .
- Pull on the safety belt to make sure that it is securely latched in the buckle.

Unfastening safety belts

Unfasten safety belts only when the vehicle is not moving ⇒ .

- Let the belt wind up on the retractor as you guide the belt tongue to its stowed position to help prevent the safety belt from twisting and to help avoid damage to the interior trim.

WARNING

Improperly positioned safety belts can cause serious personal injury or death in an accident.

- Safety belts offer optimum protection only when the seat backrest is upright and belts are correctly positioned on the body.
- A person who is not properly restrained can be seriously injured by the safety belt itself if it slips from the stronger parts of the body into sensitive areas like the abdomen.
- Unfastening safety belts while the vehicle is in motion can cause severe personal injury or death in the event of an accident or braking maneuver!

Safety belt position

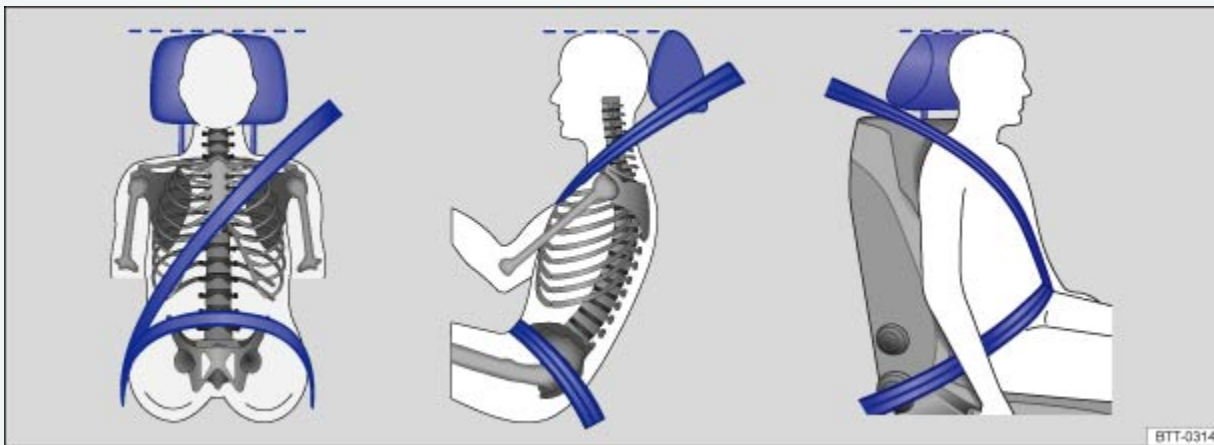


Fig. 64 Proper safety belt positioning and head restraint adjustment.





Read and follow the introductory information and safety information first ⇒ [Introduction to the subject](#)

Wearing safety belts improperly can cause serious injury or death. Safety belts can only work when they are correctly positioned on the body. A properly worn safety belt also helps to position the occupant so that an airbag can provide maximum protection when deployed. Therefore, always fasten your safety belt and make sure that it is properly positioned over your body.

Improper seating positions reduce the effectiveness of safety belts and even increase the risk of injury or death by moving the safety belt to critical areas of the body. Improper seating positions also increase the risk of severe injury or death when an airbag deploys and strikes an occupant who is not seated properly ⇒ [Adjusting the seating position](#).

Proper safety belt position

- The shoulder portion of the safety belt must always run over the center of the shoulder and never over the throat, over the arm, under the arm or behind the back.
- The lap portion of the safety belt must always run as low as possible over the pelvis and never over the abdomen.
- Always wear the safety belt flat and snug against the body. Pull on the safety belt to tighten if necessary.

Expectant mothers must always wear the lap portion of the safety belt as low as possible across the pelvis and below the rounding of the abdomen – throughout the pregnancy. The safety belt must lie flat against the body to avoid pressure against the abdomen ⇒ [Fig. 65](#).

Adjusting safety belt height

The safety belt position can be adjusted using the following features:

- Safety belt height adjusters for the front seats.
- Front seats with height adjustment.

WARNING



braking maneuver.

- Always make sure that all vehicle occupants are correctly restrained and stay in a correct seating position whenever the vehicle is being used.
- Safety belts offer optimum protection only when the seat backrest is upright and belts are correctly positioned on the body.
- A loose-fitting safety belt can cause serious injuries by shifting its position on your body from the strong bones to more vulnerable soft tissue and cause serious injury.
- The shoulder belt portion of the safety belt must be positioned over the middle of the occupant's shoulder and never across the neck or throat.
- The safety belt must lie flat and snug on the occupant's upper body.
- Never wear the shoulder part of the safety belt under your arm or otherwise out of position.
- The lap portion of the safety belt must be positioned as low as possible across the pelvis and never over the abdomen. Make sure the belt lies flat and snug against the pelvis. Pull on the safety belt to tighten if necessary.
- Expectant mothers must always wear the lap portion of the safety belt as low as possible across the pelvis and below the rounding of the abdomen.
- Do not twist the belt when attaching it. If you cannot untwist a twisted safety belt, wear it anyway, but make sure the twisted part is not in contact with your body. Have the problem corrected right away by an authorized Volkswagen dealer or authorized Volkswagen Service Facility.
- Never hold the safety belt away from your body with your hand.
- Never wear belts over rigid or breakable objects, such as eyeglasses, pens or keys.
- Never modify the position of the belt using comfort clips, loops or similar devices.



If you have a physical impairment or condition that prevents you from sitting properly on the seat with the safety belt properly fastened, special modifications to your vehicle may be necessary. Contact your authorized Volkswagen dealer or authorized Volkswagen Service Facility or call the Volkswagen Customer CARE Center at 1-800-822-8987 for information about possible modifications to your vehicle.

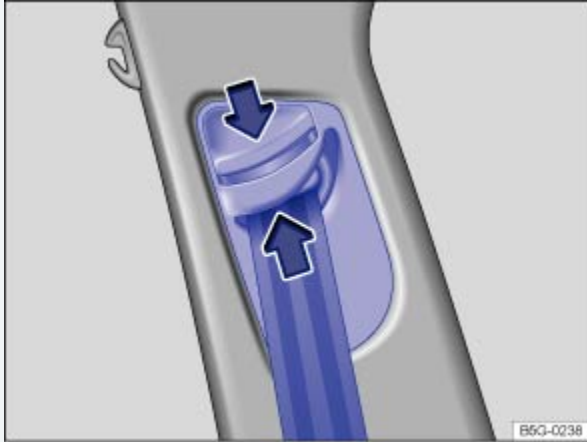



Fig. 66 Next to the front seats: Safety belt height adjuster.



Read and follow the introductory information and safety information first ⇒  [Introduction to the subject](#)

Safety belt height adjusters for the front seats can be used to adjust the height of the shoulder portion of the safety belt so that it is positioned correctly:

- Pinch the safety belt attachment together as indicated by the arrows and hold ⇒ [Fig. 66](#).
- Slide the belt and upper attachment up or down until the safety belt is positioned over the center of the shoulder ⇒ [Safety belt position](#).
- Release the safety belt attachment.
- Pull on the safety belt to make sure that the upper attachment is securely locked in place.

WARNING

Never adjust the height of the safety belt while driving.

Safety belt extender



Fig. 67 A safety belt extender properly attached to the factory-installed safety belt.

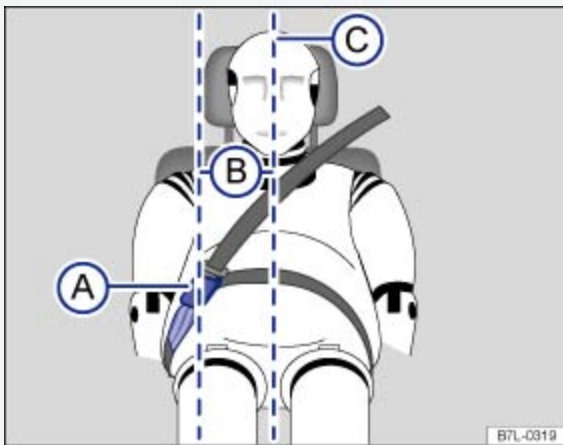


Fig. 68 Positioning of the safety belt extender.



Read and follow the introductory information and safety information first ⇒ [Introduction to the subject](#)

If a safety belt is too short to correctly fit you or one of your passengers, even when the safety belt is pulled out all the way, you can use a safety belt extender.

Never use the safety belt extender for any other purpose – including the attachment of a child restraint.

The extender adds about 8 inches (20 cm) to the safety belt. Always remove the safety belt extender when it is not needed and stow it safely. Contact an authorized Volkswagen dealer or authorized Volkswagen Service Facility if you believe you may need an extender.

Key to ⇒ [Fig. 67](#) :

- ① Vehicle safety belt buckle.
- ② Buckle tongue on the safety belt extender.

④ Safety belt buckle tongue on the factory-installed safety belt.

Key to ⇒ *Fig. 68* :

Ⓐ Safety belt buckle on the safety belt extender.

Ⓑ Distance between the safety belt buckle on the safety belt extender and the centerline of the person using the safety belt extender. The distance must be more than 6 inches (15 cm)!

Ⓒ Centerline of the person using the safety belt extender.

Using a safety belt extender

- Adjust both the seat and the head restraint properly ⇒ *Adjusting the seating position* .
- Insert the buckle tongue on the safety belt extender ⇒ *Fig. 67②* into the vehicle belt buckle for the seat where the safety belt extender is being used ⇒ *Fig. 67①* .
- Fastening or unfastening the vehicle safety belt ⇒ *Fastening and unfastening safety belts* .
- Pull the belt to make sure that the tongues are securely locked in the buckles.
- Make sure that the safety belt is positioned properly ⇒ *Safety belt position* .

Properly using safety belt extenders:

- Use a safety belt extender only when the factory installed safety belt is too short when worn properly by a person in proper seating position.
- Only use 1 safety belt extender per seat and vehicle safety belt.
- Always remove the safety belt extender when it is not needed.
- Never leave a safety belt extender attached to the vehicle safety belt buckle when the extender is not needed and being used with the safety belt. Otherwise, the airbag control module will receive an incorrect signal from the safety belt buckle and this will prevent the airbag from working properly for a person who is not using the safety belt. Leaving the extender attached to the safety belt buckle when the front seat is occupied and the safety belt is not being used will signal the airbag control unit during a collision that the front passenger seat is occupied and that the safety belt is being used. The electronic control unit for the airbag system will then receive incorrect information that will cause the safety belt pretensioner to deploy unnecessarily and the front passenger airbag to deploy later in collisions that would normally trigger the front airbag earlier in the collision to help protect an unrestrained front seat occupant. The airbag will not be able to provide enough protection for an occupant not wearing a safety belt.

WARNING

Improper use or positioning of a safety belt extender increases the risk of serious personal injury and death.

- A driver or passenger who is not properly restrained can be seriously injured by striking the interior of the passenger compartment or by the safety belt itself, which can be displaced from stronger parts of the body into sensitive areas like the abdomen.
- Safety belt extenders offer optimum protection only when they are properly used.
- Only use the extender when the belt is not long enough to be worn low and snug and the person is in the correct seating position. Remove and stow extender safely when not needed.
- Always make sure the safety belt tongue of the safety belt extender is securely inserted into the buckle for the seating position that belongs to the seat where the safety belt extender is being used. Attaching the safety belt to the wrong buckle will reduce safety belt effectiveness and can cause serious personal injury.
- Never use the safety belt extender if you can properly attach the safety belt without it. Using a safety belt extender when not needed can increase the risk of injury, especially in a collision.
- Never use a safety belt extender if the distance (B) between the front edge of the safety belt extender buckle (A) and the centerline of the person using the safety belt extender \Rightarrow Fig. 68© is less than 6 inches (15 cm).
- Never leave a safety belt extender attached to the vehicle safety belt buckle when the extender is not needed and being used with the safety belt. Otherwise, the airbag control module will receive an incorrect signal from the safety belt buckle and this will prevent the airbag from working properly for a person who is not using the safety belt.
- Never use more than 1 extender with a safety belt. Using more than 1 extender can change the way the safety belt passes over the body and can cause serious injury.
- Never use the safety belt extender to secure a child restraint.
- Never use a safety belt extender on your Volkswagen that you got from another automobile manufacturer or from an automotive parts store.
- Never use the safety belt extender you got for your vehicle for any other vehicle, regardless of make, model, or model year.



- Leaving the extender attached to the safety belt buckle when the front seat is occupied and the safety belt is not being used will signal to the airbag control unit that the front passenger seat is occupied and that the safety belt is being used. The electronic control unit for the airbag system will then receive incorrect information that will
 - cause the safety belt pretensioner to deploy unnecessarily in collisions.
 - cause the front passenger airbag to deploy later in collisions in which the front airbag would otherwise be triggered earlier to help protect an unrestrained front seat passenger.
- A pretensioner that has deployed cannot be repaired. The entire safety belt must be replaced.

NOTE

If the safety belt extender is left attached to the safety belt buckle, the safety belt warning system will sense that the safety belt for that seat is being used. The warning light will not come on and the warning chime will not sound even though the seat is occupied and the safety belt is not being used.

Safety belt retractor, pretensioner, load limiter



Read and follow the introductory information and safety information first ⇒ [Introduction to the subject](#)

The safety belts in the vehicle are part of the vehicle's safety concept ⇒ [Safety equipment](#) and consist of the following important features:

Automatic safety belt retractors

Every safety belt is equipped with an automatic safety belt retractor on the shoulder belt. As long as the safety belt is pulled out slowly, the shoulder belt will extend to let you move freely under normal driving conditions. The automatic safety belt retractor locks the belt when the belt is pulled out fast, during hard braking and in a collision. The belt may also lock when you drive up or down a steep hill or through a sharp curve.

Safety belt pretensioner



the slack out of the safety belt and tighten it when the pretensioner is activated.

The pretensioners are activated by the electronic control unit for the airbag system in front, side, and rear collisions. By tightening the safety belt, the pretensioner helps to reduce the occupant's forward movement. The belt pretensioner works together with the airbag system; its function is monitored by the airbag system indicator light. The belt pretensioner will not deploy in a rollover if the side airbags are not activated.

A fine dust may be released upon activation. This is normal and is not caused by a fire in the vehicle.

Safety belt load limiter

The front and rear outboard safety belts also have load limiters to help reduce the forces applied to the body in a crash.



Heed all safety regulations if the vehicle or individual components of the system have to be scrapped. Your authorized Volkswagen dealer and authorized Volkswagen Service Facility are familiar with these regulations ⇒ [Service and disposal of belt pretensioners](#).

Service and disposal of belt pretensioners



Read and follow the introductory information and safety information first ⇒ [Introduction to the subject](#)

The pretensioners are part of the safety belts installed at the front seats in your vehicle. Installing, removing, servicing, or repairing of safety belt pretensioners can damage the safety belt system and prevent it from working correctly in a collision. The pretensioners themselves may then also not work in the event of an accident, or not work properly.

There are some important things you have to know to make sure that the effectiveness of the system will not be impaired and that discarded components do not cause injury or pollute the environment. Undeployed safety belt pretensioners and airbag modules contain explosive materials that can cause serious injuries to the general public and to people who work at dealerships and workshops, scrap yards, and recycling facilities. For this reason, the systems must be properly handled when they or the vehicles they are installed in are scrapped.



abandon vehicles or vehicle parts. If your vehicle must be scrapped, please make sure that it is done safely, responsibly, and in compliance with all applicable environmental regulations. Take it to a licensed facility that has the knowledge and experience to properly dispose of the vehicle and its safety belt system. Your authorized Volkswagen dealer and authorized Volkswagen Service Facility are familiar with these regulations.

WARNING

Improper handling, care, servicing, and repair procedures can increase the risk of personal injury and death by preventing a belt pretensioner from activating when needed or by causing it to activate unexpectedly.

- The pretensioner can be activated only once. If a pretensioner has been activated, the safety belt must be replaced.
- Safety belt systems including the pretensioners cannot be repaired. Special procedures are required to remove, install, and dispose of this system.
- Never repair, adjust, or change pretensioners or any other part of the safety belt system yourself. We strongly recommend that you have any work on the safety belt system performed by an authorized Volkswagen dealer or authorized Volkswagen Service Facility. They have the necessary technical information, training, and special equipment ⇒ [Parts, accessories, repairs, and modifications](#).

WARNING

Undeployed safety belt pretensioners and airbag modules contain explosive materials that can cause serious personal injuries if they are not properly handled when they or the vehicles they are installed in are scrapped.

- Never abandon vehicles or vehicle parts.
- Always scrap vehicles and vehicle parts, especially those containing undeployed airbag modules and undeployed safety belt pretensioners, at a licensed facility that has the knowledge and experience to properly dispose of the vehicle and its safety belt and airbag systems.



Undeployed airbag modules and safety belt pretensioners are classified as Perchlorate Material . Special handling may apply – see <http://www.dtsc.ca.gov/hazardouswaste/perchlorate>. Obey all applicable legal requirements regarding handling and disposal of the vehicle or parts of its re-



Volkswagen dealers and authorized Volkswagen service facilities are familiar with the requirements, and we recommend that you have them perform this service for you.

Airbag system



Introduction to the subject

In this chapter you will find information on the following subjects:

⇒ *Advanced Airbag System, infants, child restraints and children on the front seat*

⇒ *Monitoring the Advanced Airbag System*

⇒ *PASSENGER AIR BAG light*

⇒ *Airbags and how they work*

⇒ *The dangers of using child restraints on the front seat*

⇒ *Front airbags*

⇒ *Advanced Airbag System components*

⇒ *How to tell if the front passenger front airbag is on or off*

⇒ *Side airbags*

⇒ *Side Curtain Protection® airbags for 2-door vehicles*

⇒ *Side Curtain Protection® airbags for 4-door vehicles*

Your vehicle is equipped with a front airbag for the driver and front seat passenger. The front airbags can provide additional protection for the chest and head of the driver and the front seat passenger when seats, safety belts, head restraints and, for the driver, the steering wheel, are properly used and have been properly adjusted. Airbags are only supplemental restraints. They are not a substitute for safety belts that must be worn even though the front seating positions are equipped with front airbags.



Never rely on airbags alone for protection.

- Even when they deploy, airbags provide only supplemental protection.
- Airbags work most effectively when used with properly worn safety belts ⇒ *Safety belts*.
- The driver must always make sure that every person in the vehicle is properly seated on a seat of his or her own, properly fastens the safety belts belonging to that seat before the vehicle starts to move, and keeps the belts properly fastened while riding in the vehicle. This applies even when just driving around town. Therefore, always wear your safety belts and make sure that everybody in your vehicle is properly restrained.

WARNING

Sitting too close to the steering wheel or instrument panel will decrease the effectiveness of the airbags and will increase the risk of personal injury in a collision.

- Never sit closer than 10 inches (25 cm) to the steering wheel or instrument panel.
- If you cannot sit upright more than 10 inches (25 cm) from the steering wheel and with your back against the backrest, investigate whether adaptive equipment may be available to help you reach the pedals and increase your seating distance from the steering wheel.
- If you are unrestrained, leaning forward, sitting sideways or out of position in any way, your risk of injury is much higher.
- You will also receive serious injuries and could even be killed if you are up against the airbag or too close to it when it inflates.
- To reduce the risk of injury when an airbag inflates, always wear safety belts properly. See ⇒ *Safety belts*.
- An infant in a rearward-facing child restraint installed on the front passenger seat will be seriously injured and can be killed if the front airbag inflates.
- Always make certain that children age 12 or younger always ride in the rear seat. If children are not properly restrained, they may be severely injured or killed when an airbag inflates.
- Never let children ride unrestrained or improperly restrained in the vehicle.
- Never put your feet on the instrument panel or on the seat. Always keep both feet on the floor in front of the seat to help prevent serious injuries to the head, legs and hips if the airbag in-



WARNING

Objects between you and the airbag will increase the risk of injury in a crash by interfering with the way the airbag unfolds or by being pushed into you as the airbag inflates.

- Never hold things in your hands or on your lap when the vehicle is in use.
- Never transport items on or in the area of the front passenger seat. Objects could move into the area of the front airbags during braking or other sudden maneuvers and fly dangerously through the passenger compartment when an airbag inflates.
- Always make sure that the airbag deployment zones are clear at all times. Never let any thing or object, a pet, or a person, including an infant or small child, be in the space between any vehicle occupant and any airbag at any time.

WARNING

An airbag works only once. Airbags that have deployed in a crash must be replaced.

- Deployed airbags and the related system parts must be replaced immediately with new parts approved by Volkswagen for the vehicle model and model year.
- Have repairs and vehicle modifications performed by an authorized Volkswagen dealer or authorized Volkswagen Service Facility. Authorized Volkswagen dealers and authorized Volkswagen Service Facilities have the required tools, diagnostic equipment, repair information, and trained personnel to properly replace any airbag in your vehicle and assure system effectiveness in a crash.
- Never permit salvaged or recycled airbags to be installed in your vehicle.
- Never modify any components of the airbag system.

WARNING

Fine dust released when airbags deploy can irritate the skin, eyes, and mucous membranes as well as cause breathing problems for people who suffer from asthma or other respiratory conditions.

- The fine dust can irritate the skin and eye mucous membranes and cause breathing problems for people who suffer from asthma or other breathing conditions. To reduce the risk of breath-



by getting out of the vehicle or opening windows or doors.

- If you are in a collision in which airbags deploy, wash your hands and face with mild soap and water before eating.
- Be careful not to get the dust into your eyes or into any cuts, scratches, or open wounds.
- If the residue should get into your eyes, flush them with water.


WARNING

Using solvents or other improper cleaning products on surfaces where airbags are located can change the way airbags deploy in a crash.

- Products containing solvents will change the properties of the plastics and may cause plastic parts to break and fly around when the airbag deploys in a crash, causing injury.
- Never use solvents or cleaners on the steering wheel horn pad or on the instrument panel because they can damage the airbag cover or change the stiffness or strength of the material so that the airbag cannot deploy and protect properly.
- When cleaning the horn pad and instrument panel, use only a soft, dry cloth or a cloth moistened with plain water.

Advanced Airbag System, infants, child restraints and children on the front seat



Read and follow the introductory information and safety information first ⇒  [Introduction to the subject](#)

Be sure to read the important information and the WARNINGS for important details about children and Advanced Airbags ⇒ [Child safety and child restraints](#).

The Advanced Airbag System in your vehicle has been certified to comply with the requirements of the United States Federal Motor Vehicle Safety Standard (FMVSS) 208, as well as Canada Motor Vehicle Safety Standard (CMVSS) 208 as applicable at the time your vehicle was manufactured. According to requirements, the front Advanced Airbag System on the passenger side has been certified for suppression for infants of about 12 months old and younger and for low risk deployment for children aged 3 to 6 years old (as defined in the standard).



especially 12 years and younger, always ride on the back seat properly restrained for their age and size. The airbag on the front passenger side makes the front seat a potentially dangerous place for a child to ride. The front seat is not the safest place for a child in a forward-facing child restraint. It is a very dangerous place for an infant or a child in a rearward-facing seat.


DANGER!


The front seat of any vehicle can be a dangerous place for a child - even with an Advanced Airbag System.

- If the front airbag inflates, a child or infant who
 - is unrestrained on the front seat,
 - is in an improperly installed forward-facing child restraint on the front seat, or
 - is in any rearward-facing child restraint on the front seat will be seriously injured and can be killed.
- Even though your vehicle is equipped with an Advanced Airbag System, make certain that all children, especially 12 years and younger, always ride on the back seat properly restrained for their age and size.
- Always properly install rearward-facing child restraints or infant carriers and forward-facing child restraints on the rear seat - even with an Advanced Airbag System.

Monitoring the Advanced Airbag System





Read and follow the introductory information and safety information first ⇒  [Introduction to the subject](#)

The Advanced Airbag System (including the electronic control unit, sensors and system wiring) is monitored continuously to make sure that it is functioning properly whenever the ignition is on. Every time you turn on the ignition, the airbag system indicator light  will come on for a few seconds (function check).

The airbag system must be inspected if the airbag indicator light 

- does not light up when the ignition is switched on,

- goes out and then lights up again or blinks after the ignition is switched on,
- or if it lights up or blinks while driving.

If an airbag system malfunction is detected, the airbag indicator light comes on and stays on to alert the driver to the problem. It also reminds you to have the airbag system checked immediately by an authorized Volkswagen dealer or an authorized Volkswagen Service Facility. If a malfunction occurs that turns the front airbag on the passenger side off, the PASSENGER AIR BAG **OFF**  light ⇒ **PASSENGER AIR BAG OFF**  *light* will come on and stay on whenever the ignition is on.

WARNING

An airbag system and safety belt pretensioner that are not working properly cannot provide supplemental protection in a frontal crash.

- If the airbag indicator light comes on, it means that there may be something wrong with the Advanced Airbag System. It is possible that the airbag will inflate when it is not supposed to, or will not inflate when it should.
- Have the airbag system inspected immediately by your authorized Volkswagen dealer or authorized Volkswagen Service Facility.

PASSENGER AIR BAG OFF **light**



Fig. 69 In the instrument panel: **PASSENGER AIR BAG** light.




subject

On	Location	Possible cause	Solution
	Instrument cluster	Airbag and safety belt pretensioner system malfunction.	See your authorized Volkswagen dealer or authorized Volkswagen Service Facility immediately to have the system checked.
OFF	Instrument panel ⇒ Fig. 69	Airbag system malfunction. Front passenger airbag turned off by Advanced Airbag System.	See your authorized Volkswagen dealer or authorized Volkswagen Service Facility immediately to have the system checked. Check if the airbag must stay turned off.



The PASSENGER AIR BAG **OFF** light ⇒ Fig. 69 will come on and stay on to tell you when the front Advanced Airbag System on the passenger side has been turned off by the electronic control unit.



If the bulb for the PASSENGER AIR BAG **OFF** light burns out, the airbag indicator light ⇒ [Monitoring the Advanced Airbag System](#) will come on and signal a malfunction in the Advanced Airbag System. Although the burned-out bulb will not change the way the front airbag on the passenger side works, it will no longer be possible to use the PASSENGER AIR BAG **OFF** light to make sure that the airbag on/off status is correct for the occupant on the front passenger seat. Have the airbag system inspected immediately by your authorized Volkswagen dealer or authorized Volkswagen



The PASSENGER AIR BAG **OFF**  light will blink for about 5 seconds when:

- the ignition is switched on and
- the capacitive passenger detection system, which switches the front seat passenger's front Advanced Airbag on and off, detects a change in the status of the front passenger seat.

After the PASSENGER AIR BAG **OFF**  light stops blinking, always make sure that the airbag status (on or off) as shown by the PASSENGER AIR BAG **OFF**  light is proper for the size, age, and weight (electrical capacitance) of the occupant on the front passenger seat. Always make sure that the safety belt for the front passenger seat is properly fastened.

The PASSENGER AIR BAG **OFF**  light will show the status of the front seat passenger's front Advanced Airbag System a few seconds after the ignition has been switched on and the airbag monitoring light goes off. The PASSENGER AIR BAG **OFF**  light:

- will stay on if the front passenger seat is not occupied;
- will stay on if the electrical capacitance measured by the capacitive passenger detection system for the front passenger seat equals the combined capacitance of an infant up to about 1 year of age and one of the rearward-facing or forward-facing child restraints listed in Federal Motor Vehicle Safety Standard 208 with which the Advanced Airbag System in your vehicle was certified. For a listing of the child restraints that were used to certify your vehicle's compliance with the U.S. Safety Standard ⇒ [Child safety and child restraints](#);
- will go out if the front passenger seat is occupied by an adult as registered by the capacitive passenger detection system.

The PASSENGER AIR BAG **OFF  light must come on and stay on if the ignition is on and...**




- a car bed has been installed on the front passenger seat, or
- a rearward-facing child restraint has been installed on the front passenger seat, or
- a forward-facing child restraint has been installed on the front passenger seat,
- and if the electrical capacitance registered on the front passenger seat is equal to or less than the combined capacitance of a typical 1 year-old infant and one of the rearward-facing or forward-facing child restraints listed in Federal Motor Vehicle Safety Standard 208 with which the Advanced Airbag System in your vehicle was certified.



PASSENGER AIR BAG **OFF**  light will stay on.


Never install a rearward-facing child restraint on the front passenger seat. The safest place for a child in any kind of child restraint is on the rear seat ⇒ [Advanced Airbag System, infants, child restraints and children on the front seat](#), and ⇒ [Child safety and child restraints](#).

If the PASSENGER AIR BAG **OFF light comes on...**

If the PASSENGER AIR BAG **OFF**  light comes on when one of the conditions listed above is met, be sure to check the light regularly to make certain that the PASSENGER AIR BAG **OFF**  light stays on continuously whenever the ignition is on. If the PASSENGER AIR BAG **OFF**  light does not come on and stay on all the time, stop as soon as it is safe to do so AND



- reactivate the airbag system by turning the ignition off for more than 4 seconds and then turning it on again;
- remove and reinstall the child restraint. Make sure that the child restraint is properly installed and that the safety belt for the front passenger seat has been correctly routed around or through the child restraint as described in the child restraint manufacturer's instructions;
- make sure that the switchable locking feature on the safety belt for the front passenger seat has been activated and that the safety belt has been pulled tight;
- make sure that no electrical device (such as a laptop, CD player, or electronic games device) is placed or used on the front passenger seat if the device is connected to the 12 Volt socket ⇒ [Power outlets](#);
- make sure that no seat heater has been retrofitted or otherwise added to the front passenger seat;
- make sure that nothing can interfere with the safety belt buckles and that they are not obstructed;
- make sure that there are no wet objects (such as a wet towel) and no water or other liquids on the front passenger seat cushion.

If the PASSENGER AIR BAG **OFF light still does not come on...**

If the PASSENGER AIR BAG **OFF**  light still does not come on and does not stay on continuously (when the ignition is switched on), take the child restraint off the front passenger seat and install it properly at one of the rear seat positions. Have the airbag system inspected immediately by your au-




The PASSENGER AIR BAG OFF light should NOT come on...


The PASSENGER AIR BAG OFF  light should NOT come on when the ignition is on and an adult is sitting in a proper seating position on the front passenger seat. If the PASSENGER AIR BAG OFF  light comes on and stays on under these circumstances, make sure that:

- the adult on the front passenger seat is properly seated on the center of the seat cushion with his or her back up against the backrest and the backrest is not reclined;
- the safety belt is being properly worn and that there is not a lot of slack in the safety belt webbing;
- there are no aftermarket seat covers or cushions or other things (such as blankets) on the front passenger seat that might cause the capacitive passenger detection system to miscalculate electrical capacitance.
- the optional safety belt extender has not been left in the safety belt latch for the front passenger seat.

WARNING


If the status of the Advanced Airbag System has changed while the vehicle is moving, the PASSENGER AIR BAG OFF  light blinks for about 5 seconds to catch the driver's attention. If this happens, always stop as soon as it is safe to do so and check the steps described above.

WARNING


If the PASSENGER AIR BAG OFF  light does not go off when an adult who is not very small is sitting on the front passenger seat after taking the steps described above, make sure the adult is properly seated and restrained at one of the rear seating positions.

- Have the airbag system inspected by your authorized Volkswagen dealer or authorized Volkswagen Service Facility before transporting anyone on the front passenger seat.




If the capacitive passenger detection system determines that the front passenger seat is empty, the front airbag on the passenger side will be turned off, and the PASSENGER AIR BAG OFF  light will stay on.



If the optional safety belt extender is left in the buckle for the front safety belt, or the front passenger safety belt itself is buckled and the front passenger seat is not occupied, the PASSENGER AIR BAG **OFF**  light will come on.

Airbags and how they work



Read and follow the introductory information and safety information first ⇒  [Introduction to the subject](#)

Front airbags and how they work

Airbags are only supplemental restraints. They are not a substitute for safety belts that must be worn even though the front seating positions are equipped with front airbags. The front airbags can provide additional protection for the chest and head of the driver and the front seat passenger when seats, safety belts, head restraints and, for the driver, the steering wheel, are properly used and have been properly adjusted.

When the airbag system deploys in a collision, a gas generator fills the airbags that break open the padded covers on the steering wheel and the instrument panel. The front airbags inflate between the steering wheel and the driver and between the instrument panel and the front passenger.

Front airbags in combination with properly worn safety belts slow down and limit the occupant's forward movement. Together they help to prevent the driver and front seat passenger from hitting parts of the vehicle interior, thereby reducing the forces acting on the occupants during a crash. In this way, they help to reduce the risk of injury to the head and upper body during a crash. Airbags do not provide protection for the arms and lower body parts. It is important to remember that the supplemental airbag system is designed to reduce the likelihood of serious injuries. However, it is possible that a deployed airbag may cause other injuries such as swelling, bruising, friction burns, and abrasions.

Airbags inflate in the blink of an eye, so fast that many people don't even realize that the airbags have deployed. The airbags will deflate immediately after deployment so that the front occupants can see through the windshield again without interruption.

Airbags inflate with a great deal of force. Airbags can cause serious injuries when they inflate and hit those who are sitting too close, are out of position, or are not properly restrained. By keeping room between your body and the steering wheel and the front of the passenger compartment, the airbag



→ *Safety belts.*

Make sure that nothing is in the way of the airbags when they deploy. For example, things on your lap or on the seat could be pushed into your body or fly dangerously through the passenger compartment when the airbag inflates and cause serious personal injury.

The areas outlined in red (dotted lines) ⇒ *Fig. 70* and ⇒ *Fig. 71* indicate the airbag deployment zone. Never place or attach accessories or other objects (such as cup holders, telephone brackets, note pads, large, heavy or bulky objects) on the doors, on the windshield, over or near the area marked in red (dotted lines).

Physical impairments and airbags

If you have a physical impairment or condition that prevents you from sitting properly on the driver seat with the safety belt properly fastened and reaching the pedals, special modifications to your vehicle may be necessary. The safety belt and airbag can only provide optimum protection if you are seated correctly and can reach the pedals.

Contact your authorized Volkswagen dealer or authorized Volkswagen Service Facility or call the Volkswagen Customer CARE Center at 1-800-822-8987 for information about possible modifications to your vehicle.

When airbags deploy

Deployment of the front airbags and the activation of the safety belt pretensioners depend on the deceleration measured by the crash sensors and registered by the electronic control unit. Crash severity depends on speed and deceleration as well as the mass and stiffness of the vehicle or object involved in the crash.

The front airbags will not inflate in side or rear collisions, in rollovers or if the ignition is switched off. The front airbags will not inflate in all frontal collisions. The triggering of the airbag system depends on the vehicle deceleration rate caused by the collision and registered by the electronic control unit. If this rate is below the reference value programmed into the control unit, the airbags will not be triggered, even though the vehicle may be badly damaged as a result of the collision. Vehicle damage, repair costs or even the lack of vehicle damage is not necessarily an indication of whether an airbag should inflate or not. It is not possible to define a range of vehicle speeds that will cover every possible kind and angle of impact that will always trigger the airbags, since the circumstances will vary considerably between one collision and another. Important factors include, for example, the nature



When an airbag deploys, fine dust is released. This is normal and is not caused by a fire in the vehicle. This dust is made up mostly of a powder used to lubricate the airbags as they deploy. This dust could irritate skin and eyes and cause breathing problems for people with asthma or other respiratory conditions.

Always remember: Front airbags only supplement the 3 point safety belts in some frontal collisions only when the vehicle deceleration is high enough to deploy the airbags. Airbags only deploy once, and only in certain kinds of collisions. The safety belts are always there to offer protection in situations in which airbags should not deploy or when they have already deployed, for example, when your vehicle strikes or is struck by another vehicle after an initial collision.

This is just one of the reasons why an airbag is a supplementary restraint and is not a substitute for a safety belt. The airbag system works most effectively when used with the safety belts. Therefore, always buckle up properly and wear your safety belts.


The airbags are part of the overall passive vehicle safety system. The airbag system works most efficiently when used with properly worn safety belts and a proper seating position ⇒ ⚠️ .

Safety equipment

Your safety and the safety of your passengers shouldn't be left to chance. Advances in technology have made a number of features available to help reduce the risk of injury in a collision. The following are just a few of the safety features for your Volkswagen:


- Sophisticated safety belts for all seating positions.
- Safety belt pretensioners for the driver and front passenger.
- Safety belt load limiters for the front and rear outboard seating positions.
- Safety belt height adjusters for the front seats.
- Safety belt warning light.
- Advanced front airbag system for the driver and front passenger.
- Sensors for the capacitive front seat passenger detection system.
- Side airbags for the driver and front passenger.
- Side Curtain Protection[®] airbags.



- PASSENGER AIR BAG **OFF**  light.
- Electronic control unit and associated sensors.
- Head restraints with height adjustment optimized for rear-end collisions.
- Adjustable steering column.
- LATCH/UCRA lower universal and top tether anchorages for child safety seats at the rear outboard seating positions.

These individual safety features can work together as a system to help protect you and your passengers in a wide range of collisions. These features can't work as a system if they are not always correctly adjusted and properly used!

How the **Advanced Airbag System components work together...**

On the passenger side, regardless of safety belt use, the front passenger front airbag will be turned off if the electrical capacitance measured by the capacitive passenger detection system on the front passenger seat is less than the amount programmed in the electronic control unit. The front airbag on the passenger side will also be turned off if the capacitance measured by the system for the front passenger seat equals that of an infant of about 1 year of age in one of the child restraints that was used to certify the Advanced Airbag System under Federal Motor Vehicle Safety Standard 208. The PASSENGER AIR BAG **OFF**  light comes on and stays on to tell you when the front Advanced Airbag System on the passenger side has been turned off ⇒ [PASSENGER AIR BAG **OFF** !\[\]\(f5c463b8c1554ac5049d611bd8e33a51_img.jpg\) light](#).

WARNING

Never rely on airbags alone for protection.

- Even when they deploy, airbags provide only supplemental protection.
- Airbags work most effectively when used with properly worn safety belts ⇒ [Safety belts](#).
- The driver must always make sure that every person in the vehicle is properly seated on a seat of his or her own, properly fastens the safety belts belonging to that seat before the vehicle starts to move, and keeps the belts properly fastened while riding in the vehicle. This applies even when just driving around town. Therefore, always wear your safety belts and make sure that everybody in your vehicle is properly restrained.




Sitting too close to the steering wheel or instrument panel will decrease the effectiveness of the airbags and will increase the risk of personal injury in a collision.

- Never sit less than 10 inches (25 cm) from the steering wheel or instrument panel.
- If you cannot sit upright more than 10 inches (25 cm) from the steering wheel, investigate whether adaptive equipment may be available to help you reach the pedals and increase your seating distance from the steering wheel.
- If you are unrestrained, leaning forward, sitting sideways, or out of position in any way, your risk of injury is much higher.
- You can also be seriously injured and even be killed if you are sitting too close to the airbag when it inflates.
- To reduce the risk of injury when an airbag inflates, always wear safety belts properly.
- An infant in a rearward-facing child restraint installed on the front passenger seat will be seriously injured and can be killed if the front airbag inflates – even with an Advanced Airbag System.
- Always make certain that children age 12 or younger always ride in the rear seat. If children are not properly restrained, they may be severely injured or killed when the airbag inflates.
- Never let children ride unrestrained or improperly restrained in the vehicle.
- Adjust the front seats properly.
- Never ride with the backrest reclined.
- Always sit as far as possible from the steering wheel or the instrument panel.
- Always sit upright with your back against the backrest of your seat.
- Never put your feet on the instrument panel or on the seat.
- Always keep both feet on the floor in front of the seat to help prevent serious injuries to the head, legs and hips if the airbag inflates.

 **WARNING**

Objects between you and the airbag will increase the risk of injury in a crash by interfering with the way the airbag unfolds and/or by being pushed into you as the airbag inflates.




- Never place accessories or other objects (such as cup holders, telephone brackets, or things that are large, heavy, or bulky) on the doors or attach them to the doors; never place them over or near the area marked AIRBAG on the steering wheel, instrument panel, or seat backrests or between those areas and someone in the vehicle. These objects could cause injury in a crash, especially if an airbag inflates.
- Never recline the front passenger seat to transport objects. Items can also move into the deployment area of the side airbags or the front airbag during braking or in a sudden maneuver. Objects near the airbags can fly dangerously through the passenger compartment and cause injury, particularly when the seat is reclined and the airbags inflate.
- Never place or transport objects on the front passenger seat. Always make sure that there is nothing on the front passenger seat that will cause the capacitive sensor in the seat to signal to the airbag system that the seat is occupied by a person when it in fact is not, or that the person on the seat is heavier than he or she actually is. The change in electric capacitance because of such objects can cause the passenger front airbag to be turned on when it should be off, or can cause the airbag to work in a way that is different from the way it would have worked without objects on the seat.
- Always make sure that the status signaled by the PASSENGER AIR BAG **OFF**  light is correct for the way that the front passenger seat is being used.

WARNING

The fine dust created when airbags deploy can cause breathing problems for people with asthma or other breathing conditions.



- To reduce the risk of breathing problems, those with asthma or other respiratory conditions should get fresh air right away by getting out of the vehicle or opening windows or doors.
- If you are in a collision in which airbags deploy, wash your hands and face with mild soap and water before eating.
- Be careful not to get the dust into your eyes, or into any cuts, scratches, or open wounds.
- If the residue should get into your eyes, flush them with water.

WARNING

To reduce the risk of serious injury, make sure that the PASSENGER AIR BAG **OFF**  light is on and



switched on.

- If the PASSENGER AIR BAG **OFF**  light does not stay on, take the child restraint off the front passenger seat and install it properly at one of the rear seating positions.
- Always make sure that the child restraint is correctly registered by the capacitive passenger detection system.
- Have the airbag system inspected immediately by your authorized Volkswagen dealer or authorized Volkswagen Service Facility if the PASSENGER AIR BAG **OFF**  light does not come on and stay on whenever a child restraint is installed on the front passenger seat and the ignition is switched on.


WARNING

Airbags that have deployed in a crash must be replaced.

- Use only original equipment airbags approved by Volkswagen and installed by a trained technician who has the necessary tools and diagnostic equipment to properly replace any airbag on your vehicle and assure system effectiveness in a crash.
- Never permit salvaged or recycled airbags to be installed in your vehicle.

The dangers of using child restraints on the front seat



Read and follow the introductory information and safety information first ⇒  [Introduction to the subject](#)

The airbag on the front passenger side makes the front seat a potentially dangerous place for a child to ride, even if the vehicle is equipped with an Advanced Airbag System. The front seat is a very dangerous place for an infant or small child in a rearward facing child restraint. The front seat is also not the safest place for a child in a forward-facing child restraint. All children, especially 12 years and younger, must always ride on the back seat and be properly restrained for their age and size.

During a frontal collision, a child restraint or infant carrier on the front seat could be hit and knocked out of position by the inflating front passenger airbag. The airbag could significantly reduce the effectiveness of the child restraint and even seriously injure a child while deploying.

Because of this danger, and because children are generally better protected on the rear seat when



on the rear seat → [Child Safety and Child Restraints](#), and → [Advanced Airbag System, Infants, Child Restraints and Children on the Front Seat](#).

DANGER!


A front seat passenger, especially an infant or small child, will be seriously injured and can even be killed if too close to the airbag when it deploys – even an Advanced Airbag.

- All vehicle occupants and especially children must be restrained properly whenever riding in a vehicle. An unrestrained or improperly restrained child could be injured by striking the interior or by being ejected from the vehicle during a sudden maneuver or impact. An unrestrained or improperly restrained child is also at greater risk of injury or death through contact with an inflating airbag.
- Accident statistics show that children are safer on the rear seat than on the front seat.
- A suitable child restraint properly installed and used at one of the rear seating positions provides the highest degree of protection for infants and small children in most accident situations.
- Although the Advanced Airbag System has been designed to switch off when an infant or small child is on the front passenger seat in a child restraint that was used during the certification process for the Advanced Airbag System, no one can guarantee with absolute certainty that the airbag will never deploy under these particular conditions in all conceivable situations for the duration of your vehicle's use.
- The Advanced Airbag System can deploy in accordance with the low risk option for 3 to 6 year-old children under the U.S. Federal Standard if a child with electrical capacitance greater than the combined capacitance of a typical 1 year-old infant restrained in one of the forward facing or rearward-facing child restraints with which your vehicle was certified is on the front passenger seat and the other conditions for airbag deployment are met.
- For their own safety, all children, especially 12 years and younger, must always ride on the back seat properly restrained for their age and size.
- When installing a child restraint, always carefully follow the manufacturer's instructions.

DANGER!



jured or even killed when an airbag inflates.

- A child in a rearward-facing child restraint installed on the front passenger seat will be seriously injured and can be killed if the front airbag inflates.
- The inflating airbag will hit the child restraint or infant carrier with great force and will smash the child restraint and the child against the seat backrest, center armrest, door, or roof.
- Always install rearward-facing child restraints on the rear seat.
- Although the Advanced Airbag System in your vehicle is designed to turn off the front airbag when a rearward-facing child restraint has been installed on the front passenger seat, nobody can absolutely guarantee that deployment is impossible in all conceivable situations that may happen during the useful life of your vehicle.
- If you have, in exceptional circumstances, nevertheless decided to install a rearward-facing child restraint on the front passenger seat and the PASSENGER AIR BAG **OFF**  light does not come on and stay on whenever the ignition is on, immediately install the rearward-facing seat in a rear seating position and have the airbag system inspected immediately by an authorized Volkswagen dealer or an authorized Volkswagen Service Facility.



WARNING

Forward-facing child restraints installed on the front passenger seat may interfere with the deployment of the airbag and cause serious personal injury to the child.

- If exceptional circumstances require the use of a forward-facing child restraint on the front passenger seat, the following special precautions must be taken for the safety and well-being of the child:
 - Always make sure that the forward-facing child restraint has been designed and certified for use on a front passenger seat with a front airbag and a side airbag.
 - Always carefully follow the manufacturer's instructions provided for the child restraint or infant carrier.
 - Never install a child safety seat without a properly attached top tether strap if the child restraint manufacturer's instructions require the top tether strap to be used.



panel.

- Always set the safety belt upper anchorage to the adjustment position that permits proper installation in accordance with the child restraint manufacturer's instructions.
- Always move the front passenger seat to the highest position in the up and down adjustment range and move it back to the rearmost position in the seat's fore and aft adjustment range, as far away from the airbag as possible, before installing the forward-facing child restraint.
- Always make sure that the safety belt upper anchorage is behind the child restraint and not next to or in front of the child restraint so that the safety belt will be properly positioned.
- Always make sure that nothing is in the way that prevents the front passenger seat from being moved all the way back to the rearmost position in its fore and aft adjustment range.
- Always make sure that the backrest is in the upright position.
- Never place additional items on the seat that can influence the electrical capacitance measured by the capacitive passenger detection system.
- Always make sure that the PASSENGER AIR BAG **OFF**  light comes on and stays on all the time whenever the ignition is switched on.
- If the PASSENGER AIR BAG **OFF**  light does not come on and stay on, immediately install the forward-facing child restraint in a seating position on the rear seat and have the airbag system inspected by an authorized Volkswagen dealer or an authorized Volkswagen Service Facility.
- Always buckle the child restraint firmly in place even when no child is sitting in it. A loose child restraint can fly around the vehicle during a sudden stop or in a collision.
- Always read and heed all WARNINGS whenever using a child restraint in the vehicle: ⇒ [Safety belts](#), ⇒ [Airbag system](#), and ⇒ [Child safety and child restraints](#).

Front airbags

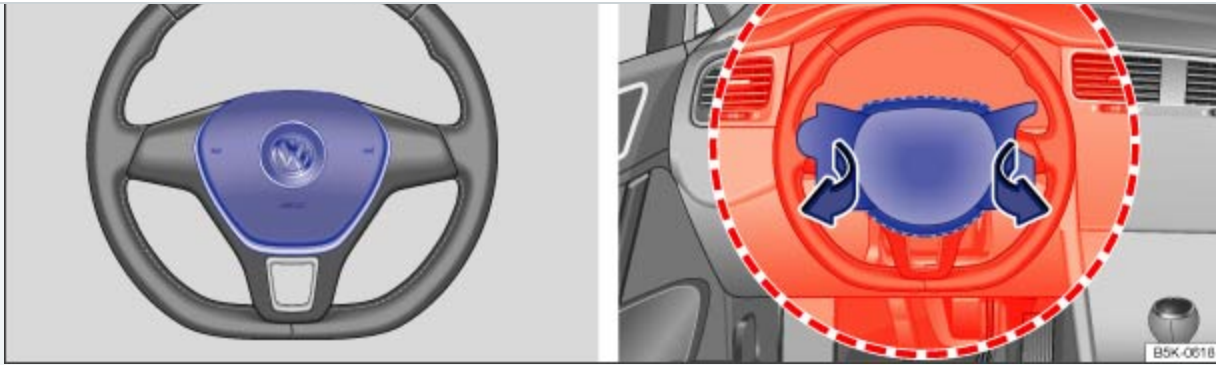


Fig. 70 Location and deployment zone of the driver front airbag.

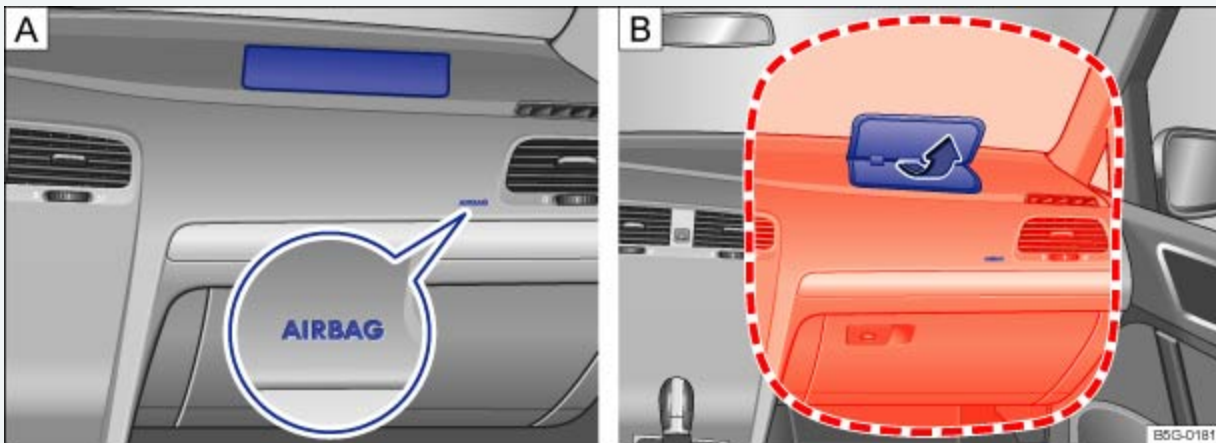


Fig. 71 Location and deployment zone of the front passenger front airbag.



Read and follow the introductory information and safety information first ⇒ [Introduction to the subject](#)

The vehicle is equipped with an Advanced Airbag System in compliance with the United States Federal Motor Vehicle Safety Standard (FMVSS) 208 or the Canada Motor Vehicle Safety Standard (CMVSS) 208 applicable at the time your vehicle was manufactured. The airbag for the driver is in the steering wheel hub ⇒ [Fig. 70](#) and the airbag for the front passenger is in the instrument panel ⇒ [Fig. 71](#) . The general location of the airbags is marked AIRBAG.

The safety belts for the front seating positions have safety belt pretensioners which help take up slack in the belts. The airbag control unit also activates the belt pretensioners ⇒ [Airbags and how they work](#).

The safety belts for the front and rear outboard seating positions also have belt load limiters to reduce the forces acting on a body during an accident.




zone. Never place or attach accessories or other objects (such as cup holders, telephone brackets, note pads, navigation systems, large, heavy or bulky objects) on the doors, on the windshield, over or near the area marked in red (dotted lines).

Front airbags will not deploy:

- if the ignition is switched off when a crash occurs,
- in side collisions,
- in rear-end collisions,
- in rollovers,
- when the crash deceleration measured by the airbag system is less than the minimum threshold needed for airbag deployment as registered by the electronic control unit.

The front passenger front airbag will also not deploy:


- when the front passenger seat is not occupied,
- when the electrical capacitance measured by the capacitive passenger detection system for the front passenger seat indicates that the passenger side front airbag must be switched off by the electronic control unit (the PASSENGER AIR BAG **OFF**  light comes on and stays on ⇒ [Airbags and how they work](#)).

DANGER!

Children on the front seat of any vehicle, even one with Advanced Airbags, can be seriously injured or even killed when an airbag inflates.


- A child in a rearward-facing child restraint installed on the front passenger seat will be seriously injured and can be killed if the front airbag inflates.
- The inflating airbag will hit the child restraint or infant carrier with great force and will smash the child restraint and the child against the seat backrest, center armrest, door, or roof.
- Always install rearward-facing child restraints on the rear seat.
- Although the Advanced Airbag System in your vehicle is designed to turn off the front airbag when a rearward-facing child restraint has been installed on the front passenger seat, nobody can absolutely guarantee that deployment is impossible in all conceivable situations that may happen during the useful life of your vehicle.



child restraint on the front passenger seat and the PASSENGER AIR BAG  light does not come on and stay on whenever the ignition is on, immediately install the rearward-facing seat in a rear seating position and have the airbag system inspected immediately by an authorized Volkswagen dealer or an authorized Volkswagen Service Facility.


DANGER!

A front seat passenger, especially an infant or small child, will be seriously injured and can even be killed if too close to the airbag when it deploys – even an Advanced Airbag.

- All vehicle occupants and especially children must be restrained properly whenever riding in a vehicle. An unrestrained or improperly restrained child could be injured by striking the interior or by being ejected from the vehicle during a sudden maneuver or impact. An unrestrained or improperly restrained child is also at greater risk of injury or death through contact with an inflating airbag.
- Accident statistics show that children are safer on the rear seat than on the front seat.
- A suitable child restraint properly installed and used at one of the rear seating positions provides the highest degree of protection for infants and small children in most accident situations.
- An Advanced Airbag System can deploy with the low risk option for 3 to 6 year-old children when a child who is heavier than the combined capacitance of a typical 1 year-old child plus child restraint is secured on the passenger seat in a forward-facing or rear-facing child restraint that was used to certify your vehicle, and when the other conditions for airbag deployment are met.
- For their own safety, all children, especially those 12 years and younger, must always sit on the back seat, properly restrained for their age and size.
- When installing a child restraint, always carefully follow the manufacturer's instructions.
- If the airbag indicator light goes on while driving, have the system inspected immediately by your authorized Volkswagen dealer or authorized Volkswagen Service Facility. A lit indicator light means the airbags may not work properly if activated in a crash.
- Always make sure that the status signaled by the PASSENGER AIR BAG **OFF**  light is correct for the way that the front passenger seat is being used.



Objects between you and the airbag will increase the risk of injury in a crash by interfering with the way the airbag unfolds and/or by being pushed into you as the airbag inflates.

- Never hold things in your hands or on your lap when the vehicle is in use.
- Never place accessories or other objects (such as cup holders, telephone brackets, notepads, navigation systems, or things that are large, heavy, or bulky) on the doors or attach them to the doors; never place them over or near the area marked AIRBAG on the steering wheel, instrument panel, or seat backrests, or between those areas and someone in the vehicle ⇒ *Fig. 70* and ⇒ *Fig. 71* . Such objects could cause serious injury in a collision, especially if an airbag inflates.
- Never attach accessories to the windshield above the passenger front airbag, such as GPS navigation units or music players. Such objects could cause serious injury in a collision, especially if an airbag inflates.
- Never recline the front passenger seat to transport objects. Items can also move into the deployment area of the side airbags or the front airbag during braking or in a sudden maneuver. Objects near the airbags can fly dangerously through the passenger compartment and cause injury, particularly when the seat is reclined and the airbags inflate.
- Always make sure that there is nothing on the front passenger seat that will cause the capacitive passenger detection system in the seat to signal to the Airbag System that the seat is occupied by a person when it is not, or to signal that it is occupied by someone who is heavier than the person actually sitting on the seat. The presence of an object could cause the passenger front airbag to be turned on when it should be off, or could cause the airbag to work in a way that is different from the way it would have worked without the object on the seat.
- Always make sure that nothing is on the front passenger seat when the backrest is folded forward.
- Always make sure that the status signaled by the PASSENGER AIR BAG **OFF**  light is correct for the way that the front passenger seat is being used.

WARNING

Holding the steering wheel the wrong way can cause serious injuries to the hands, arms, and head if the driver's airbag inflates.

- Always hold the steering wheel with both hands on the outside of the steering wheel rim at



airbag inflates.

- Never hold the steering wheel at the 12 o'clock position or with your hands anywhere inside the steering wheel or on the steering wheel hub. Holding the steering wheel the wrong way increases the risk of severe injury to the arms, hands, and head if the driver airbag deploys.

WARNING

The fine dust created when airbags deploy can cause breathing problems for people with asthma or other breathing conditions.

- To reduce the risk of breathing problems, those with asthma or other respiratory conditions should get fresh air right away by getting out of the vehicle or opening windows or doors.
- If you are in a collision in which airbags deploy, wash your hands and face with mild soap and water before eating.
- Be careful not to get the dust into your eyes, or into any cuts, scratches, or open wounds.
- If the residue should get into your eyes, flush them with water.

WARNING

Airbags that have deployed in a crash must be replaced.


- Use only original equipment airbags approved by Volkswagen and installed by a trained technician who has the necessary tools and diagnostic equipment to properly replace any airbag on your vehicle and assure system effectiveness in a crash.
- Never permit salvaged or recycled airbags to be installed in your vehicle.





Undeployed airbag modules and safety belt pretensioners are classified as Perchlorate Material . Special handling may apply – see <http://www.dtsc.ca.gov/hazardouswaste/perchlorate>. Obey all applicable legal requirements regarding handling and disposal of the vehicle or parts of its restraint system, including airbag modules and safety belts with pretensioners. Authorized Volkswagen dealers and authorized Volkswagen Service Facilities are familiar with the requirements, and we recommend that you have them perform this service for you.

Advanced Airbag System components

subject

The front passenger seat in your vehicle has a lot of very important parts of the Advanced Airbag System in it ⇒ [Airbags and how they work](#). These parts include the capacitive passenger detection system, wiring, brackets, and more. The control unit monitors the system in the front passenger seat when the ignition is switched on and turns the airbag indicator light on when a malfunction in the one of the system components is detected ⇒ **PASSENGER AIR BAG OFF**  [light](#). Because the front passenger seat contains important parts of the Advanced Airbag System, you must take care to prevent it from being damaged. Damage to the seat may prevent the Advanced Airbag System for the front passenger seat from doing its job in a crash.

The front Advanced Airbag System also includes:

- Crash sensors in the front of the vehicle that measure vehicle acceleration/deceleration to provide information to the Advanced Airbag System about the severity of the crash.
- An electronic control unit, with integrated crash sensors for front and side impacts. The control unit decides whether to fire just the front airbags based on the information received from the crash sensors. The control unit also decides whether the safety belt pretensioners should be activated.
- An Advanced Airbag with gas generator for the driver inside the steering wheel hub.
- An Advanced Airbag with gas generator inside the instrument panel for the front passenger.
- A capacitive passenger detection system underneath the front passenger seat cover. This system measures the electrical capacitance of the person in the seat. The information registered is sent continuously to the electronic control unit to regulate deployment of the front Advanced Airbag on the passenger side.
- An airbag system indicator light in the instrument cluster ⇒ [Monitoring the Advanced Airbag System](#).
- The **PASSENGER AIR BAG OFF**  light in the center of the instrument panel that tells you when the front Advanced Airbag System on the passenger side has been turned off ⇒ **PASSENGER AIR BAG OFF**  [light](#).
- A switch in the safety belt buckle for the driver and for the front seat passenger that senses whether that safety belt is latched or not and transmits this information to the electronic control unit.



An airbag system and safety belt pretensioner that are not working properly cannot provide supplemental protection in a frontal crash.

- If the airbag indicator light comes on, it means that there may be something wrong with the airbag system. It is possible that the airbag will inflate when it is not supposed to, or will not inflate when it should.
- Have the airbag system inspected immediately by your authorized Volkswagen dealer or authorized Volkswagen Service Facility.
- Use only original equipment airbags approved by Volkswagen. Have them installed by a trained technician who has the necessary tools and diagnostic equipment to properly replace any airbag in your vehicle and assure system effectiveness in a crash.
- Never permit salvaged or recycled airbags to be installed in your vehicle.



WARNING

Damage to the front passenger seat can prevent the front airbag from working properly.

- Improper repair or disassembly of the front passenger and driver seat can prevent the Advanced Airbag System from working properly.
- Repairs to the front passenger seat should be performed by an authorized Volkswagen dealer or an authorized Volkswagen Service Facility.
- Never remove the front passenger seat or driver seat from the vehicle.
- Never remove the upholstery from the front passenger seat.
- Never disassemble or take parts off the seat or disconnect wires from it.
- Never carry sharp objects in your pockets or put them on the seat. If the capacitive passenger detection system in the front passenger seat is punctured it cannot work properly.
- Never carry things on your lap or carry objects on the front passenger seat. Such objects can influence the capacitance registered by the capacitive passenger detection system, so that incorrect information is provided to the airbag control unit. These things can also cause serious personal injury if the airbag inflates.
- Never store items under the front seats. Parts of the Advanced Airbag System under the front seats could be damaged, preventing them and the airbag system from working properly.






proved by Volkswagen for your specific vehicle.

- Seat covers can prevent the Advanced Airbag System from recognizing child restraints or occupants on the passenger seat and prevent the side airbag in the seat backrest from deploying properly.
- Never use cushions, pillows, blankets, or similar items on the front passenger seat. The additional layers prevent the capacitive passenger detection system from accurately measuring the capacitance of the child safety seat and/or the person on the seat and thus keep the Advanced Airbag System from working properly.
- Never place or use any electrical device (such as a laptop, CD player, or electronic games device) on the front passenger seat if the device is connected to the 12 Volt socket. Such devices can influence the capacitance registered by the capacitive passenger detection system, so that incorrect information is provided to the airbag control unit.
- If a seat heater has been retrofitted or otherwise added to the front passenger seat, never install any child restraint system on this seat.
- If you must use a child restraint on the front passenger seat and the child restraint manufacturer's instructions require the use of a towel, foam cushion or something similar to properly position the child restraint, make certain that the PASSENGER AIR BAG **OFF**  light comes on and stays on whenever the child restraint is installed on the front passenger seat.
- If the PASSENGER AIR BAG **OFF**  light does not come on and stay on, immediately install the child the restraint at a seating position on the rear seat and have the airbag system inspected by your authorized Volkswagen dealer or authorized Volkswagen Service Facility.

WARNING

If the front passenger seat gets wet, dry it immediately.

- If liquid soaks into the front passenger seat, this can keep the airbag system from working properly and may, for instance, deactivate the passenger front airbag. If this happens, the PASSENGER AIR BAG **OFF**  light will come on and stay on together with the airbag indicator light  in the instrument cluster.
- If liquid is pooled on the seat, but has not soaked in, this may also keep the airbag system from working properly and cause the front passenger front airbag to be enabled (turned on), even though there is a properly installed child restraint system on the seat. Wet towels or other wet things on the seat cushion can have the same effect. The PASSENGER AIR BAG **OFF**  light

NOTE

- To help prevent damage to electrical and other parts in the seat, do not kneel on the front seats or apply concentrated pressure to a small area of the seat or backrest.
- Never install leather upholstery on a vehicle that originally had cloth upholstery. Never install cloth upholstery on a vehicle that originally had leather upholstery. The capacitive passenger detection system for the Advanced Airbag system will not work properly if different upholstery is installed on the passenger seat than the upholstery originally installed on the vehicle when it was originally manufactured.

How to tell if the front passenger front airbag is on or off



Read and follow the introductory information and safety information first ⇒ [Introduction to the subject](#)

Passenger front airbag

Regardless of safety belt use, the airbag in front of the front passenger seat will be switched off if the electrical capacitance measured on this seat is less than the value programmed in the electronic control unit.

The front airbag on the passenger side of the front seat will also be turned off if the electrical capacitance measured on the seat (by the capacitive passenger detection system) is less than or equal to the combined capacitance of:

- a typical 1 year-old infant and
- any of the child restraints listed in Federal Motor Vehicle Safety Standard 208 for which the Advanced Airbag System in your vehicle is certified.



For a listing of the child restraints that were used to certify your vehicle's compliance with U.S. Safety Standard 208, see ⇒ [Child restraints and the Advanced Airbag System](#). The PASSENGER AIR BAG **OFF** light comes on and stays on to tell you when the front Advanced Airbag on the passenger side has been turned off.

Passenger front airbag active

- Switch on the ignition.



senger seat. If that capacitance is above the reference value, the passenger front airbag will be switched on by the Advanced Airbag control unit.




- If the ignition is on, and the PASSENGER AIR BAG **OFF**  light in the instrument panel *does not* come on, the passenger front airbag is generally active. If the **OFF**  light has burned out (see below), you will be unable to tell whether the passenger front airbag is active or not.





Using child restraints on the front passenger seat

The airbag on the front passenger side makes the front seat a potentially dangerous place for a child to ride. Because of this danger, and because children are generally better protected on the rear seat when properly restrained for their age and size, we strongly advise that you always place children on the rear seat ⇒ [The dangers of using child restraints on the front seat](#). For a list of the child restraints used to certify compliance of the Advanced Airbag System in your vehicle with the suppression requirements of FMVSS 208, see ⇒ [Child restraints and the Advanced Airbag System](#).

For more information, see ⇒ [Child safety and child restraints](#); note ⇒  below!

How do I know when the passenger front airbag has been turned off by the control unit?

The PASSENGER AIR BAG **OFF**  light in the instrument panel will come on and stay on to tell you when the front Advanced Airbag on the passenger side has been turned off by the electronic control unit. Unless the yellow **OFF**  light comes on and stays on, the passenger front airbag is still active ⇒ [PASSENGER AIR BAG OFF](#)  light.

For safety reasons, you must never use a child restraint system on the front passenger seat unless the PASSENGER AIR BAG **OFF**  light comes on and stays on, perhaps in combination with the  indicator light in the instrument cluster. If the passenger front airbag deployed in an accident, it would severely injure and possibly kill the child in the restraint system. If the bulb for the PASSENGER AIR BAG **OFF**  light burns out, the airbag indicator light will come on and signal a malfunction of the Advanced Airbag System. Although the burned-out bulb will not change the way the front airbag on the passenger side works, it will no longer be possible to use the PASSENGER AIR BAG **OFF**  light to make sure that the airbag on/off status is correct for the occupant on the front passenger seat. Have the airbag system inspected immediately by your authorized Volkswagen dealer or authorized Volkswagen Service Facility.



 **DANGER!**




be killed if sitting too close to the airbag when it deploys.


- All vehicle occupants and especially children must be restrained properly whenever riding in a vehicle. An unrestrained or improperly restrained child could be injured by striking the interior or by being ejected from the vehicle during a sudden maneuver or impact. An unrestrained or improperly restrained child is also at greater risk of injury or death through contact with an inflating airbag.
- A child in a rearward-facing child restraint installed on the front passenger seat will be seriously injured and can be killed if the front airbag inflates.
- The inflating airbag will hit the child restraint or infant carrier with great force and will smash the child restraint and the child against the seat backrest, center armrest, door, or roof.
- Accident statistics show that children are safer on the rear seat than on the front seat.
- A suitable child restraint properly installed and used at one of the rear seating positions provides the highest degree of protection for infants and small children in most accident situations.
- For their own safety, all children, especially 12 years and younger, must always ride on the back seat properly restrained for their age and size.
- When installing a child restraint, always carefully follow the manufacturer's instructions.

WARNING

To reduce the risk of serious injury, make sure that the **PASSENGER AIR BAG OFF**  light comes on and stays on whenever a child restraint is installed on the front passenger seat and the ignition is switched on. Take the child restraint off the front passenger seat and install it properly at one of the seating positions on the rear seat if the **PASSENGER AIR BAG OFF**  light does not stay on. Have the airbag system inspected immediately by an authorized Volkswagen dealer or an authorized Volkswagen Service Facility.

- If you must use a child restraint on the front passenger seat and the child restraint manufacturer's instructions require the use of a towel, foam cushion or something similar to properly position the child restraint, make certain that the **PASSENGER AIR BAG OFF**  light comes on and stays on whenever the child restraint is installed on the front passenger seat.
- Otherwise, install the child restraint system on the rear seat!

Changes in the electrical capacitance of the passenger seat while driving can switch the passenger front airbag on or off so that it does not deploy when it should or deploys when it should not, resulting in an increased risk of serious personal injury.

- Do not carry anything on your lap or transport things on the passenger seat. Things on the passenger seat can influence the capacitance registered by the capacitive passenger detection system, sending the wrong information to the airbag control unit. These objects can also cause serious personal injury if the airbag inflates.
- Always make sure that a child restraint has been correctly registered by the capacitive passenger detection system. If the status of the Advanced Airbag System changes while the vehicle is moving, the PASSENGER AIR BAG **OFF**  light blinks for about 5 seconds to catch the driver's attention. If this happens, always stop as soon as it is safe to do so and check to make sure that the airbag on/off status is correct for the passenger riding on the front passenger seat.

Side airbags

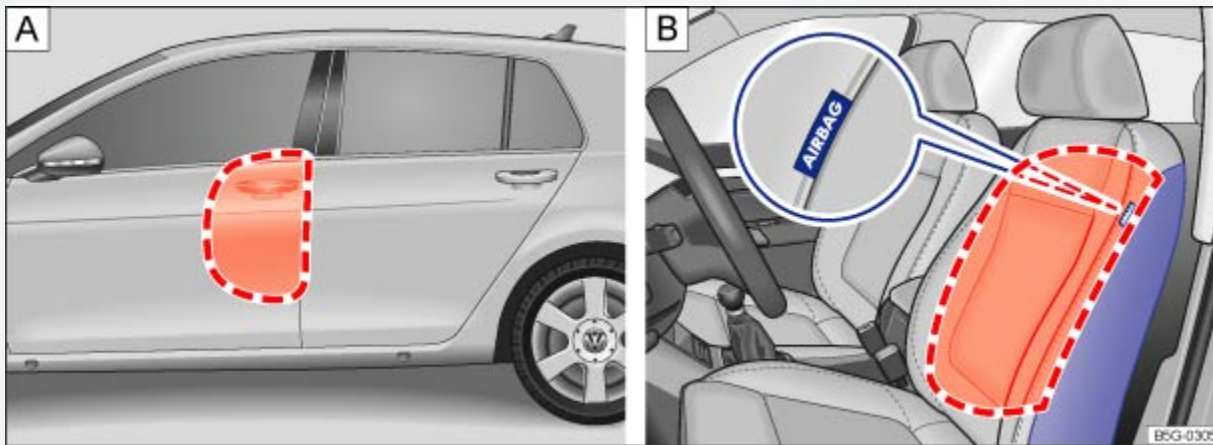



Fig. 72 On the driver side. : Location and deployment zone of the side airbags. : Location and deployment zone of the side airbags in the padding on the outboard side of the front seat backrests.




Read and follow the introductory information and safety information first ⇒  [Introduction to the subject](#)

The side airbags are in the backrest padding of the driver and passenger seats ⇒ Fig. 72. The general location is shown by the word AIRBAG. The area marked in red (dotted lines) indicates the deployment zone of the side airbags.

In a side collision, the side airbag in the seat backrest can deploy and help reduce the risk of injury to



The side airbags installed for the front seating positions have been designed and certified to help reduce the risk of injury that can be caused by airbags when they inflate, particularly when the occupant sitting next to it is not seated properly.


The side airbag for the front passenger seat can be used with properly installed child restraints. Always read and heed all important information and WARNINGS whenever using a child restraint in the vehicle: ⇒ [Safety belts](#) , ⇒ [Airbag system](#) , ⇒ [Child safety and child restraints](#) , and ⇒  .

The side airbag system includes:

- An electronic control module and side impact sensors.
- Side airbags in the front seat backrests.
- An airbag system indicator light in the instrument cluster ⇒ [Monitoring the Advanced Airbag System](#) .

When a side airbag deploys in a collision, a gas generator fills the side airbag between the vehicle occupant and the door. The side airbag system supplements the safety belts and can help to reduce the risk of injury to the occupant's upper torso.

In order to help provide this additional protection, the side airbag must inflate within the blink of an eye at very high speed and with great force. The supplemental side airbag could injure you if your seating position is not proper or upright or if items are in the area where the supplemental side airbag inflates. This applies especially to children ⇒ [Child safety and child restraints](#) .

The airbag system is monitored electronically to make sure it is working properly at all times. Every time you turn on the ignition, the airbag system indicator light  will come on for a few seconds (function check).

The airbag system is not a substitute for your safety belt. Rather, it is part of the overall occupant restraint system in your vehicle ⇒ [Adjusting the seating position](#) , ⇒ [Safety belts](#) .

It is important to remember that the side airbag system is designed to help reduce the likelihood of serious injury. However, it is important to remember that a deploying airbag may also cause other injuries, such as swelling, bruising, friction burns, and abrasions. Also remember that side airbags will deploy only once and only in certain kinds of accidents. After the side airbag inflates, the system must be replaced. Your safety belts are always there to offer protection in those accidents in which side airbags are not supposed to deploy or when they have already deployed.



- if the ignition is switched off when a crash occurs,
- in side collisions when the acceleration measured by the sensor is too low,
- in front-end collisions,
- in rear-end collisions,
- in rollovers, unless the deployment threshold for deployment stored in the control unit is met.

In some types of accidents, the front airbags, Side Curtain Protection[®] airbags and side airbags may be triggered together.

WARNING

An inflating side airbag can cause serious or even fatal injury. Improperly wearing safety belts and improper seating positions increase the risk of serious personal injury and death whenever a vehicle is being used.

- To help reduce the risk of injury when the supplemental side airbag inflates,
 - Always sit in an upright position and do not lean against the area where the side airbag is located.
 - Never let a child or anyone else rest their head against the side trim panel in the area where the side airbag inflates.
 - Always make sure that safety belts are worn correctly.
 - Never let anyone sitting in the front seat put their hand out of the window.
- Objects between you and the airbag can increase the risk of injury in a collision by interfering with the way the airbag unfolds or by being pushed into you as the airbag inflates.
- Never place or attach accessories or other objects (such as cup holders, telephone brackets, or even large, bulky objects) on the doors or over or near the area marked AIRBAG on the seat backrests ⇒ [Fig. 72](#).
- Accessories or other objects can fly dangerously through the passenger compartment and cause serious injury if the supplemental side airbag inflates.
- Never position or hold any objects or pets in the area where an airbag inflates or allow any children or other passengers to ride in that space.



of sharp-edged objects in the pockets. Such objects may interfere with side airbag deployment and cause serious personal injury in a collision.

WARNING

Improper use, repair, or disassembly of the driver and front passenger seats can prevent side airbags from working properly and result in severe injuries.

- Always make sure that the side airbag can inflate without interference:
 - Never install seat covers or replacement upholstery over the front seat backrests that have not been specifically approved by Volkswagen. Otherwise, the side airbag may not be able to deploy properly.
 - Never put seat cushions, blankets, or other coverings over the areas where the side airbags inflate.
 - Damage to the original seat covers or to the seam in the area of the side airbag module must always be repaired immediately by an authorized Volkswagen dealer or authorized Volkswagen Service Facility.
- Always prevent the side airbags from being damaged by heavy objects hitting the sides of the seat backrests or force being put on the seat backs, especially in the area where the side airbag module is located.
- The airbag system can only be triggered once. If the airbag has been triggered, the system must be replaced.
- Always have work involving the side airbag system, including removal, replacement, and installation of airbag components, or other repairs performed by an authorized Volkswagen dealer or authorized Volkswagen Service Facility. Otherwise, the airbag system may not work correctly.
- Never remove the front seats from the vehicle or modify parts of the front seats.
- Never attempt to modify any components of the airbag system in any way.
- If too much force is exerted on the seat backrest bolsters, the side airbags may deploy improperly, not at all, or when they should not.

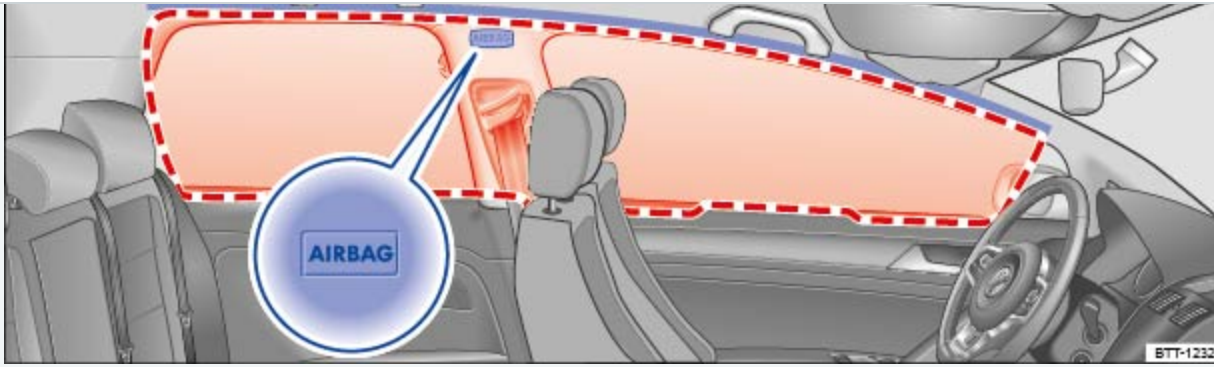


Fig. 73 On the left vehicle side (2-door vehicles only): Installation location and deployment zone of the Side Curtain Protection airbag.



Read and follow the introductory information and safety information first ⇒ [Introduction to the subject](#)

The Side Curtain Protection[®] airbags are in the header area on both sides of the vehicle ⇒ [Fig. 73](#). The general location is identified by the word AIRBAG. The red lines show the deployment zone of the Side Curtain Protection[®] airbags.

The Side Curtain Protection[®] airbag system includes:

- An electronic control module and side impact sensors.
- The Side Curtain Protection[®] airbags above the front and rear side windows.
- An airbag system indicator light in the instrument cluster ⇒ [Monitoring the Advanced Airbag System](#).

The Side Curtain Protection[®] airbags inflate downwards between the occupant and the side window on that side of the vehicle that is struck in certain side collisions ⇒ [Fig. 73](#). The Side Curtain Protection[®] airbag system supplements the safety belts and can help to reduce the risk of injury for occupants' heads and upper torsos on the side of the vehicle that is struck in a side collision.

In order to help provide this additional protection, the Side Curtain Protection[®] airbag must inflate within the blink of an eye at very high speed and with great force. The Side Curtain Protection[®] airbag could injure you if your seating position is not proper or upright or if items are located in the area where the supplemental Side Curtain Protection[®] airbag inflates. This applies especially to children ⇒ [Child safety and child restraints](#).

The airbag system is monitored electronically to make sure it is working properly at all times. Every



(function check).

The airbag system is not a substitute for your safety belt. Rather, it is part of the overall occupant restraint system in your vehicle ⇒ [Adjusting the seating position](#) , ⇒ [Safety belts](#) .

It is important to remember that the Side Curtain Protection[®] airbag system is designed to help reduce the likelihood of serious injury. However, it is possible that a deployed Side Curtain Protection[®] airbag may cause other injuries such as swelling, bruising, friction burns, and abrasions. Remember too, Side Curtain Protection[®] airbags will deploy only once and only in certain kinds of accidents. Side Curtain Protection[®] airbags that have deployed in a crash must be replaced. Your safety belts are always there to offer protection in those accidents in which Side Curtain Protection[®] airbags are not supposed to deploy or when they have already deployed.

The Side Curtain Protection[®] airbag will not inflate:

- if the ignition is switched off when a crash occurs,
- in side collisions when the acceleration measured by the sensor is too low,
- in front-end collisions,
- in rear-end collisions,
- in rollovers, unless the deployment threshold for deployment stored in the control unit is met.

In some types of accidents, the front, Side Curtain Protection[®] and side airbags may be triggered together.

WARNING

An inflating Side Curtain Protection[®] airbag can cause serious or even fatal injury. Improperly wearing safety belts and improper seating positions increase the risk of serious personal injury and death whenever a vehicle is being used.

- A deploying airbag inflates within a fraction of a second with a lot of force and at very high speed.
- Always make sure that the Side Curtain Protection[®] airbag can inflate without interference.
- Always sit in proper seating position and wear safety belts while traveling so that the Side Curtain Protection[®] airbags can help provide protection.
- Never let occupants place any parts of their bodies in the area where the Side Curtain



- Always keep the area where the Side Curtain Protection[®] airbag inflates clear. Never carry any objects or pets in the area between them and where the airbags inflate and never let children or other passengers ride in this area.
- Never use hangers to hang clothes on the hooks.
- Never use the built-in coat hooks for anything but lightweight clothing. Never leave any heavy or sharp-edged objects in the pockets that may interfere with airbag deployment and can cause personal injury in a collision.
- Only use factory-installed sunshades or, if shades installed after the vehicle leaves the factory, use only genuine Volkswagen sunshades.
- Never swing the sun visors over to the side windows if things such as pens, garage door openers, hands-free speakers, etc. are attached to the sun visors. They could come loose and cause serious injury if the Side Curtain Protection[®] airbag inflates.

WARNING

The airbag system can only be triggered once.

- If the airbag has been triggered, the system must be replaced by an authorized Volkswagen dealer or authorized Volkswagen Service Facility.
- Always have work involving the curtain airbag system, removal and installation of the airbag components, or other repairs performed by your authorized Volkswagen dealer or authorized Volkswagen Service Facility. Otherwise the airbag system may not work correctly.
- Never attempt to modify any components of the airbag system in any way.
- Never attach objects to the cover or in the deployment zone of a Side Curtain Protection[®] airbag.
- Always make sure that the airbag deployment zones are clear at all times. Never let anything or object, a pet, or a person, including an infant or small child, be in the space between any vehicle occupant and any airbag.
- Do not attach any accessories to the doors.

Side Curtain Protection[®] airbags for 4-door vehicles

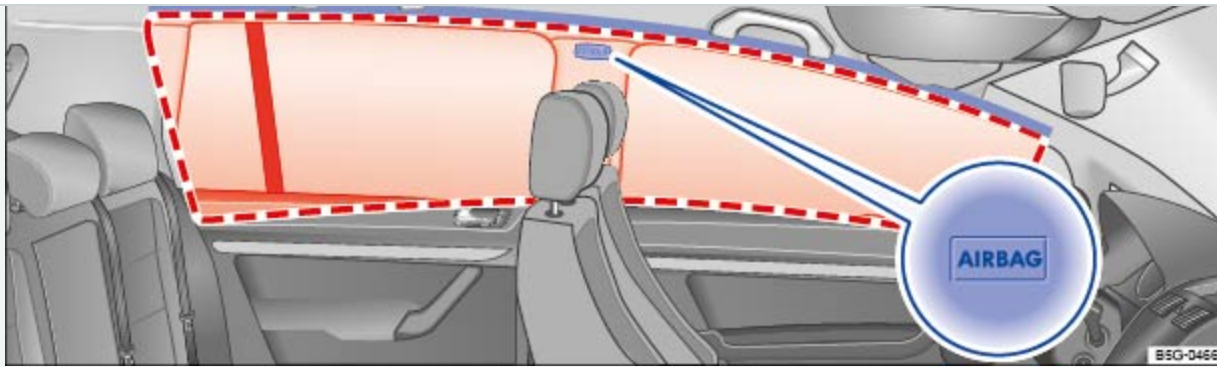


Fig. 74 On the left vehicle side (4-door vehicles only): Installation location and deployment zone of the Side Curtain Protection airbag.



Read and follow the introductory information and safety information first ⇒ [Introduction to the subject](#)

The Side Curtain Protection[®] airbags are in the header area on both sides of the vehicle ⇒ [Fig. 74](#). The general location is identified by the word AIRBAG. The red lines show the deployment zone of the Side Curtain Protection[®] airbags. The Side Curtain Protection airbags contain features that provide ejection mitigation to help prevent vehicle occupants or parts of their bodies from being completely or partially ejected from the vehicle interior in certain side impacts and vehicle rollovers.

The Side Curtain Protection[®] airbag system includes:


- An electronic control module and side impact sensors.
- The Side Curtain Protection[®] airbags above the front and rear side windows.
- An airbag system indicator light in the instrument cluster ⇒ [Monitoring the Advanced Airbag System](#).

The Side Curtain Protection[®] airbags inflate downwards between the occupant and the side window on that side of the vehicle that is struck in certain side collisions ⇒ [Fig. 74](#). The Side Curtain Protection[®] airbag system supplements the safety belts and can help to reduce the risk of injury for occupants' heads and upper torsos on the side of the vehicle that is struck in a side collision. The Side Curtain Protection airbags also contain features to help prevent vehicle occupants or parts of their bodies from being completely or partially ejected from the vehicle interior in certain vehicle rollovers.

In order to help provide this additional protection, the Side Curtain Protection[®] airbag must inflate within the blink of an eye at very high speed and with great force. The Side Curtain Protection[®] airbag could injure you if your seating position is not proper or upright or if items are located in the area



→ *Child Safety and Child Restraints* .

The airbag system is monitored electronically to make sure it is working properly at all times. Every time you turn on the ignition, the airbag system indicator light  will come on for a few seconds (function check).

The airbag system is not a substitute for your safety belt. Rather, it is part of the overall occupant restraint system in your vehicle ⇒ *Adjusting the seating position* , ⇒ *Safety belts* .

It is important to remember that the Side Curtain Protection[®] airbag system is designed to help reduce the likelihood of serious injury. However, it is possible that a deployed Side Curtain Protection[®] airbag may cause other injuries such as swelling, bruising, friction burns, and abrasions. Remember too, Side Curtain Protection[®] airbags will deploy only once and only in certain kinds of accidents. Side Curtain Protection[®] airbags that have deployed in a crash must be replaced. Your safety belts are always there to offer protection in those accidents in which Side Curtain Protection[®] airbags are not supposed to deploy or when they have already deployed.

The Side Curtain Protection[®] airbag will not inflate:

- if the ignition is switched off when a crash occurs,
- in side collisions when the acceleration measured by the sensor is too low,
- in front-end collisions,
- in rear-end collisions,
- in rollovers, unless the deployment threshold for deployment stored in the control unit is met.

In some types of accidents, the front, Side Curtain Protection[®] and side airbags may be triggered together.

WARNING

An inflating Side Curtain Protection[®] airbag can cause serious or even fatal injury. Improperly wearing safety belts and improper seating positions increase the risk of serious personal injury and death whenever a vehicle is being used.

- A deploying airbag inflates within a fraction of a second with a lot of force and at very high speed.
- Always make sure that the Side Curtain Protection[®] airbag can inflate without interference.



Curtain Protection® airbags can help provide protection.

- Never let occupants place any parts of their bodies in the area where the Side Curtain Protection® airbag inflates.
- Always keep the area where the Side Curtain Protection® airbag inflates clear. Never carry any objects or pets in the area between them and where the airbags inflate and never let children or other passengers ride in this area.
- Never use hangers to hang clothes on the hooks.
- Never use the built-in coat hooks for anything but lightweight clothing. Never leave any heavy or sharp-edged objects in the pockets that may interfere with airbag deployment and can cause personal injury in a collision.
- Only use factory-installed sunshades or, if shades installed after the vehicle leaves the factory, use only genuine Volkswagen sunshades.
- Never swing the sun visors over to the side windows if things such as pens, garage door openers, hands-free speakers, etc. are attached to the sun visors. They could come loose and cause serious injury if the Side Curtain Protection® airbag inflates.

WARNING

The airbag system can only be triggered once.

- If the airbag has been triggered, the system must be replaced by an authorized Volkswagen dealer or authorized Volkswagen Service Facility.
- Always have work involving the curtain airbag system, removal and installation of the airbag components, or other repairs performed by your authorized Volkswagen dealer or authorized Volkswagen Service Facility. Otherwise the airbag system may not work correctly.
- Never attempt to modify any components of the airbag system in any way.
- Never attach objects to the cover or in the deployment zone of a Side Curtain Protection® airbag.
- Always make sure that the airbag deployment zones are clear at all times. Never let anything or object, a pet, or a person, including an infant or small child, be in the space between any vehicle occupant and any airbag.
- Do not attach any accessories to the doors.



Introduction to the subject

In this chapter you will find information on the following subjects:

⇒ *Child restraints – Overview*

⇒ *Child restraints and the Advanced Airbag System*

⇒ *Important safety instructions for using child restraints*

⇒ *Using a child restraint on the rear seat*

⇒ *Infant seats*

⇒ *Convertible child restraints*

⇒ *Booster seats and safety belts*

⇒ *Installing child restraints with a safety belt*

⇒ *Securing the child restraint with LATCH/UCRA lower universal anchorages*

⇒ *Securing a child restraint with the Top Tether strap*

⇒ *Sources of information about child restraints and their use*

The physical principles of what happens when your vehicle is in a collision or other accident also apply to children ⇒ *Safety belts*. But unlike adults and teenagers, their muscles and bones are not fully developed. In many respects children are at greater risk of serious injury in accidents than are adults.

Because children's bodies are not fully developed, they must use restraint systems especially designed for their size, weight, and body structure. Many countries and all states of the United States and provinces of Canada have laws requiring the use of approved child restraint systems for infants and small children.

In a frontal crash at a speed of 20–35 mph (30–56 km/h), the forces acting on a 13 pound (6 kg) infant will be more than 20 times the weight of the child. This means the effective weight of the child would



Child restraint properly used can reduce the risk of serious injury. Child restraints, like adult safety belts, must be used properly to be effective. Used improperly, they can increase the risk of serious injury in an accident.

All children, especially those 12 years and younger, must always ride in the back seat properly restrained for their age and size. If you must install a child restraint on the front passenger seat in exceptional circumstances, be sure to read and heed the important information and warnings in the section of this Manual that begins on ⇒ [Child restraints and the Advanced Airbag System](#). Infants and other children who are properly restrained in an appropriate child restraint that is for their size and age can benefit from the protection that supplemental side airbags provide in some kinds of crashes.

For more information, please see information provided by the:

- National Highway Traffic Safety Administration (NHTSA), currently at: <http://www.safercar.gov> (for the USA)
- Transport Canada Information Centre, currently at: <http://www.tc.gc.ca> (for Canada)

Consult the child restraint manufacturer's instructions to be sure the seat is right for your child's size ⇒ [Sources of information about child restraints and their use](#). Please be sure to read and heed all of the important information and WARNINGS about child safety, Advanced Airbags, and the installation of child restraints in this Manual.


There is a lot you need to know about the Advanced Airbags in your vehicle and how they work when infants and children in child restraints are on the front passenger seat. Because of the large amount of important information, we cannot repeat it all here. We urge you to read the detailed information in this Manual about airbags and the Advanced Airbag System in your vehicle and the very important information about transporting children on the front passenger seat. Please be sure to heed the WARNINGS - they are extremely important for your safety and the safety of your passengers, especially infants and small children.

DANGER!

Children on the front seat of any car, even with Advanced Airbags, can be seriously injured or even killed when an airbag inflates.

- A child in a rearward-facing child restraint installed on the front passenger seat will be seriously injured and can be killed if the front airbag inflates.
- The inflating airbag will hit the child restraint or infant carrier with great force and will smash



- Always install rearward-facing child restraints on the rear seat.
- If you have, in exceptional circumstances, nevertheless decided to install a rearward-facing child restraint on the front passenger seat and the PASSENGER AIR BAG **OFF**  light does not come on and stay on whenever the ignition is on, immediately install the rearward-facing child restraint on the rear seat and have the airbag system inspected right away by your authorized Volkswagen dealer or authorized Volkswagen Service Facility.

WARNING

Accident statistics have shown that children are generally safer in the rear seat area than in the front seating position. Always restrain any child age 12 and under in the rear.


- All vehicle occupants and especially children must be restrained properly whenever riding in a vehicle. An unrestrained or improperly restrained child could be injured by striking the interior or by being ejected from the vehicle during a sudden maneuver or impact. An unrestrained or improperly restrained child is also at greater risk of injury or death through contact with an inflating airbag.
- A suitable child restraint properly installed and used at one of the rear seating positions provides the highest degree of protection for infants and small children in most accident situations.

WARNING

Forward-facing child restraints installed on the front passenger seat may interfere with the deployment of the airbag and cause serious personal injury to the child.

- If exceptional circumstances require the use of a forward-facing child restraint on the front passenger's seat, the child's safety and well-being require the following special precautions to be taken:
 - Always make sure that the forward-facing seat has been designed and certified by its manufacturer for use on a front passenger seat with a front and side airbag.
 - Always carefully follow the manufacturer's instructions provided with the child restraint or infant carrier.
 - Never install a child restraint without a properly attached top tether strap if the child re-



- Never put the forward-facing child restraint up against or very near the instrument panel.
- Always set the safety belt upper anchorage to the adjustment position that permits proper installation in accordance with the child restraint manufacturer's instructions.
- Always move the front passenger seat to the highest position in the up and down adjustment range and move it back to the rearmost position in the seat's fore and aft adjustment range, as far away from the airbag as possible before installing the forward-facing child restraint.
- Always make sure that the safety belt upper anchorage is behind the child restraint and not next to or in front of the child restraint so that the safety belt will be properly positioned.
- Always make sure that nothing is in the way that prevents the front passenger's seat from being moved to the rearmost position in its fore and aft adjustment range.
- Always make sure that the backrest is in the upright position.
- Never place objects on the seat (such as a laptop, CD player, or electronic games device). These may influence the electrical capacitance measured by the capacitive passenger detection system and can also fly around in an accident and cause serious personal injury.
- Never place or use any electrical device (such as a laptop, CD player, or electronic games device) on the front passenger seat if the device is connected to the 12 Volt socket ⇒ *Power outlets*.
- If a seat heater has been retrofitted or otherwise added to the front passenger seat, never install any child restraint system on this seat.
- Make sure that there are no wet objects (such as a wet towel) and no water or other liquids on the front passenger seat cushion.
- Always make sure that the PASSENGER AIR BAG **OFF**  light comes on and stays on all the time whenever the ignition is switched on.



stall the forward-facing child restraint in a rear seating position and have the airbag system inspected by your authorized Volkswagen dealer or authorized Volkswagen Service Facility.

- Always buckle the child restraint firmly in place even if a child is not sitting in it. A loose child restraint can fly around during a sudden stop or in a collision.
- Always read and heed all WARNINGS whenever using a child restraint in a vehicle. See [⇒ Safety belts](#), [⇒ Airbag system](#), and [⇒ Child safety and child restraints](#).



Always replace child restraints that were installed in a vehicle during a crash. Damage to a child restraint that is not visible could cause it to fail in another collision situation.

Child restraints – Overview



Read and follow the introductory information and safety information first ⇒ [Introduction to the subject](#)

All children and especially infants must be properly restrained in a child restraint appropriate for their size and age whenever riding in a vehicle. Their safety also requires that the child restraint be properly installed. There are many car seat choices on the market. You can use the information below to help you choose a car seat that best meets your child's needs.

Type of child restraint

Applies to



Birth to 12 months: Your child under age 1 should always ride in a rear-facing car seat. There are different types of rear-facing car seats:

Rear-facing child restraint

– Infant-only seats can only be used rear-facing.

– Convertible and all-in-one car seats typically have higher height and weight limits for the rear-facing position, allowing you to keep your child rear-facing for a longer period of time.

Rear-facing child restraint before moving to a forward-facing child restraint

1–3 years: Keep your child rear-facing as long as possible. It's the best way to keep him or her safe. Your child should remain in a rear-facing car seat until he or she reaches the top height or weight limit allowed by the car seat's manufacturer. Once your child outgrows the rear-facing car seat, your child is ready to travel in a forward-facing car seat with a harness and tether.



Forward-facing child restraint

4–7 years: Keep your child in a forward-facing car seat with a harness and tether until he or she reaches the top height or weight limit allowed by the car seat’s manufacturer. Once your child outgrows the forward-facing car seat with a harness, it’s time to travel in a booster seat, but still in the back seat.

Booster seat

7–12 years: Keep your child in a booster seat until he or she is big enough to fit in a seat belt properly. For a seat belt to fit properly, the lap belt must lie snugly across the upper thighs, not the stomach. The shoulder belt should lie snugly across the shoulder and chest and not cross the neck or face. Remember: your child should still ride in the back seat because it’s safer there.

Child restraints are designed to be secured to the vehicle with the lap belt portion of the 3 point lap and shoulder belt installed for the passenger seats. The outboard rear seating positions also have special fixtures for child restraints that can be used with LATCH/UCRA lower universal anchorages. Many child restraints also require the use of a top tether strap. The top tether strap reduces the forward movement of the child restraint in a crash, to help reduce the risk of head injury if the child hits the vehicle interior.

The LATCH/UCRA lower universal anchorage attachment points are on the lower part of the rear seat backrest for the 2 outboard seating positions. Each lower universal anchorage point has a cover. The circular markings on the covers help you to locate the lower anchorages ⇒ [Securing the child restraint with LATCH/UCRA lower universal anchorages ⇒ Fig. 80](#).

The top tether anchorages are behind each of the rear seating positions ⇒ [Securing a child restraint](#)



More information:

- Important safety instructions for using child restraints ⇒ [Important safety instructions for using child restraints](#)
- Using a child restraint on the rear seat ⇒ [Using a child restraint on the rear seat](#)
- Infant seats ⇒ [Infant seats](#)
- Convertible child restraints ⇒ [Convertible child restraints](#)
- Booster seats and safety belts ⇒ [Booster seats and safety belts](#)
- Installing child restraints with a safety belt ⇒ [Installing child restraints with a safety belt](#)

Child restraints and the Advanced Airbag System



Read and follow the introductory information and safety information first ⇒ [Introduction to the subject](#)

Advanced front airbag system and children

Your vehicle is equipped with a front Advanced Airbag System that complies with United States Federal Motor Vehicle Safety Standard (FMVSS) 208 and with Canada Motor Vehicle Safety Standard (CMVSS) 208 as applicable at the time your vehicle was manufactured.

The Advanced Airbag System in your vehicle has been certified to meet the low risk requirements for 3 to 6 year-old children (as defined in the standard) on the passenger side and small adults on the driver side. Low risk deployment occurs in those crashes that take place at lower decelerations as defined in the electronic control unit. The low risk deployment criteria are intended to reduce the risk of injury through interaction with the airbag that can occur in these collisions, for example, by being too close to the steering wheel or instrument panel when the airbag inflates.

In addition, the system has been certified to comply with the suppression requirements of the Safety Standard, to turn off the front airbag automatically for infants up to 12 months who are restrained on the front passenger seat in child restraints that are listed in the Standard.

Even though your vehicle is equipped with an Advanced Airbag System, all children, especially those 12 years and younger, must always ride in the back seat properly restrained for their age and size. The airbag on the passenger side makes the front seat a potentially dangerous place for a child to ride.




ous place for an infant or a larger child in a rearward-facing seat.

The vehicle's Advanced Airbag System has a capacitive passenger detection system in the front passenger seat cushion that can detect the presence of a baby or a child in a child restraint system on this seat.

The capacitive passenger detection system measures the capacitance of the child and the child restraint and a child blanket on the front passenger seat. The capacitance due to the presence of a child, a child restraint, and a baby blanket on the front passenger seat is related to the child restraint system resting on the seat. The capacitance of a child restraint system varies depending on the type of system and specific make and model.

The electrical capacitance of the various types, makes, and models of child restraints specified by the U.S. National Highway Traffic Safety Administration (NHTSA) in the relevant safety standard are stored in the Advanced Airbag System control unit together with the capacitances typical of infants and a 1 year-old child. When a child restraint is used on the front passenger seat with a typical 1 year-old infant, the Advanced Airbag System compares the capacitance measured by the capacitive passenger detection system with the data stored in the electronic control unit.

Child restraints and Advanced Airbags

No matter what child restraint you use, make sure that it has been certified to meet U.S. Federal Motor Vehicle Safety Standard 213 (FMVSS 213) or, if you live in Canada, Canada Motor Vehicle Safety Standard 213 (CMVSS 213). Also make sure that the child restraint you are using has been certified by its manufacturer for use with an airbag. Always be sure that the child restraint is properly installed at one of the rear seating positions. If in exceptional circumstances you must use it on the front passenger seat, carefully read all of the information on child safety and Advanced Airbags and heed all of the applicable WARNINGS. Make certain that the child restraint is correctly recognized by the capacitive passenger detection system inside the front passenger seat, that the passenger front airbag is switched off, and that the airbag status is always correctly signaled by the PASSENGER AIR BAG **OFF**  light.

Many types and models of child restraints have been available over the years, new models are introduced regularly incorporating new and improved designs and older models are taken out of production. Child restraints are not standardized. Child restraints of the same type typically have different weights and sizes and different footprints, the size and shape of the bottom of the child restraint that sits on the seat, when they are installed on a vehicle seat. These differences make it virtually impossible to certify compliance with the requirements for Advanced Airbags with each and every child re-



NOTE:

For this reason, the United States National Highway Traffic Safety Administration has published a list of specific types, makes and models of child restraints that must be used to certify compliance of the Advanced Airbag System in your vehicle with the suppression requirements of Federal Motor Vehicle Safety Standard 208. These child restraints are:

Subpart A. Car bed child restraints

Model	Manufactured on or after
Angel Guard Angel Ride AA2403FOF	September 25, 2007

Subpart B. Rear-facing child restraints

Model	Manufactured on or after
Century Smart Fit 4543	December 1, 1999
Cosco Arriva 22-013 PAW and base 22-999 WHO	September 25, 2007
Evenflo Discovery Adjust Right 212	December 1, 1999
Graco Infant 8457	December 1, 1999
Graco Snugride	September 25, 2007
Peg Perego Primo Viaggio SIP IMUN00US	September 25, 2007


Subpart C. Forward-facing and convertible child restraints


Model	Manufactured on or after
-------	--------------------------



Britax Roundabout E9L02xx	September 25, 2007
Cosco Touriva 02519	December 1, 1999
Cosco Summit Deluxe High Back Booster 22-262	September 25, 2007
Cosco High Back Booster 22-209	September 25, 2007
Evenflo Tribute V 379xxxx	September 25, 2007
Evenflo Medallion 254	December 1, 1999
Evenflo Generations 352xxxx	September 25, 2007
Graco ComfortSport	September 25, 2007
Graco Toddler SafeSeat Step 2	September 25, 2007
Graco Platinum Cargo	September 25, 2007

 **WARNING**

To reduce the risk of serious injury, always make sure that the PASSENGER AIR BAG **OFF**  light comes on and stays on whenever a child restraint is installed on the front passenger seat and the ignition is switched on.

- Take the child restraint off the front passenger seat and install it properly at one of the rear seat positions if the PASSENGER AIR BAG **OFF**  light does not come on and stay on.
- Have the airbag system inspected immediately by your authorized Volkswagen dealer or au-

Important safety instructions for using child restraints



Fig. 75 Never let babies or older children ride in a vehicle while sitting on the lap of another passenger.



Read and follow the introductory information and safety information first ⇒ [Introduction to the subject](#)

Proper use of child restraints greatly reduces the risk of injury in a collision or other kind of accident!

All children, especially those 12 years and younger, must always ride in the back seat properly restrained for their age and size.

Always use the right child restraint for each child and always use it properly.

Always carefully follow the child restraint manufacturer's instructions on how to route the safety belt properly through the child restraint and how to restrain the child in the child restraint.

When using the vehicle safety belt to install a child restraint, you must activate the switchable locking feature on the safety belt to help prevent the child restraint from moving ⇒ [Installing child restraints with a safety belt](#).


Push the child restraint down with your full weight to get the safety belt really tight so that the seat cannot move forward or sideways more than about 1 inch (2.5 cm).


Important additional information about installing a child restraint system on the front passenger seat:



to read and heed the important information and warnings in the section of this Manual that begins on [⇒ Child restraints and the Advanced Airbag System](#).

There are also additional adjustments that must be made in order to be able to properly install a child restraint on the front seat:

Set the safety belt upper anchorage for the front passenger seat so that the available safety belt is long enough to properly install the child restraint. Always follow the child restraint manufacturer's installation instructions ⇒ .

Move the front passenger seat to the highest position in the seat's up and down adjustment range and to the rearmost position in the seat's fore and aft adjustment range, as far away from the airbag as possible before installing the forward-facing child restraint and make sure the backrest is in the upright position ⇒ .

When using the vehicle safety belt to install a child restraint, you must activate the switchable locking feature on the safety belt to help prevent the child restraint from moving ⇒ [Using a child restraint on the rear seat](#). Always follow the child restraint manufacturer's instructions when installing a child restraint.

Do not use the switchable locking feature when using the vehicle's safety belt to restrain a child on a booster seat.

Always remember: Even though your vehicle is equipped with an Advanced Airbag System, all children, especially those 12 years and younger, must always ride in the back seat properly restrained for their age and size.

 **DANGER!**

Never install rearward-facing child restraints or infant carriers on the front passenger seat.

- A child will be seriously injured and can be killed when the passenger airbag inflates – even with an Advanced Airbag System.
- The inflating airbag will hit the child restraint or infant carrier with great force and will smash the child restraint and child against the backrest, center armrest, door or roof.
- Always install rearward-facing child restraints and infant carriers on the rear seat.



Not using a child restraint, using the wrong child restraint, or improperly installing a child restraint increases the risk of serious personal injury and death in a collision or other emergency situation.

- All vehicle occupants and especially children must always be restrained properly whenever riding in a vehicle.
 - An unrestrained or improperly restrained child can be injured or killed by being thrown against the inside of the vehicle or by being ejected from it during a sudden maneuver or impact.
 - An unrestrained or improperly restrained child is at much greater risk of injury or death by being struck by an inflating airbag.
- Commercially available child restraints are required to comply with U.S. Federal Motor Vehicle Safety Standard FMVSS 213 (in Canada CMVSS 213).
 - When buying a child restraint, select one that fits your child and the vehicle.
 - Only use child restraint systems that fully contact the flat portion of the seat cushion. The child restraint must not tip or lean to either side. Volkswagen does not recommend using child restraints that rest on legs or tube-like frames. They do not provide adequate contact with the seat.
 - Always heed all legal requirements pertaining to the installation and use of child restraints and carefully follow the instructions provided by the manufacturer of the seat you are using.
- For safety reasons, children under 4 ft. 9 in. (57 inches / 1.45 meters) may not wear safety belts. Children must always be restrained by a proper child restraint system. Otherwise, they could sustain injuries to the abdomen and neck areas during sudden braking maneuvers or accidents.
- Never let more than one child occupy a child restraint.
- Never let babies or older children ride in a vehicle while sitting on the lap of another passenger.
 - Holding a child in your arms is never a substitute for a child restraint system.



The child will strike the interior of the vehicle and can also be struck by another passenger.

- The child and the passenger can also injure each other in an accident.

WARNING

Forward-facing child restraints installed on the front passenger's seat can interfere with the airbag when it inflates and cause serious injury to the child.


- Always install child restraints on the rear seat.
- If exceptional circumstances require the use of a forward-facing child restraint on the front passenger's seat, the child's safety and well-being require the following special precautions to be taken:
 - Always make sure that the forward-facing seat has been designed and certified by its manufacturer for use on a front passenger seat with a front and side airbag.
 - Always carefully follow the manufacturer's instructions provided with the child restraint or carrier.
 - Never install a child restraint without a properly attached top tether strap if the child restraint manufacturer's instructions require the top tether strap to be used.
 - Never put the forward-facing child restraint up against or very near the instrument panel.
 - Always set the safety belt upper anchorage to the adjustment position that permits proper installation in accordance with the child restraint manufacturer's instructions.
 - Always move the front passenger seat to the highest position in the up and down adjustment range and move it back to the rearmost position in the seat's fore and aft adjustment range, as far away from the airbag as possible before installing the forward-facing child restraint.





not next to or in front of the child restraint so that the safety belt will be properly positioned.

- Always make sure that nothing is in the way that prevents the front passenger's seat from being moved to the rearmost position in its fore and aft adjustment range.
- Always make sure that the backrest is in the upright position.
- Never place additional items on the seat that can influence the capacitance registered by the capacitive passenger detection system and can cause injury in a crash.
- Never place or use any electrical device (such as a laptop, CD player, or electronic games device) on the front passenger seat if the device is connected to the 12 Volt socket ⇒ [Power outlets](#).
- If a seat heater has been retrofitted or otherwise added to the front passenger seat, never install any child restraint system on this seat.
- Make sure that there are no wet objects (such as a wet towel) and no water or other liquids on the front passenger seat cushion.
- Always buckle the child restraint firmly in place even if a child is not sitting in it. A loose child restraint can fly around during a sudden stop or in a collision.
- Always read and heed all WARNINGS whenever using a child restraint in a vehicle. See ⇒ [Safety belts](#), ⇒ [Airbag system](#), and ⇒ [Child safety and child restraints](#).

WARNING

To reduce the risk of serious injury, always make sure that the PASSENGER AIR BAG **OFF**  light comes on and stays on whenever a child restraint is installed on the front passenger seat and the ignition is switched on.

- If the PASSENGER AIR BAG **OFF**  light does not stay on, perform the checks described ⇒ [PASSENGER AIR BAG **OFF** !\[\]\(a502cb21d600ba28a5cdf414d68eef89_img.jpg\) light](#).
- Take the child restraint off the front passenger seat and install it properly at one of the rear seat positions if the PASSENGER AIR BAG **OFF**  light does not stay on.
- Have the airbag system inspected immediately by an authorized Volkswagen dealer or autho-

Using a child restraint on the rear seat

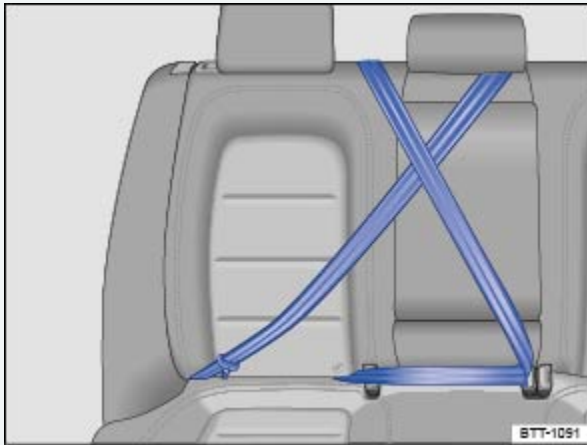


Fig. 76 Keep unused safety belts away from children in child restraints.



Read and follow the introductory information and safety information first ⇒ [Introduction to the subject](#)

Important special steps when installing a child restraint with LATCH/UCRA lower universal anchorages or with the vehicle safety belt.

You must take special precautions when installing a LATCH/UCRA child restraint behind the front passenger or driver seats. Always route the center safety belt and the unused safety belt for the seating position where the child restraint is being installed securely out of the child's reach. Securing the safety belts will help prevent a child from playing with an unused safety belt and becoming entangled with it ⇒ [Fig. 76](#).

Securing a safety belt for an outboard seating position

When routing a safety belt for an outboard seating position, do not activate the switchable locking feature, otherwise it will be very difficult to wind the safety belt back into its normal position. You should not hear a clicking sound when the safety belt retracts.


- Route the safety belt around the head restraint for the center seating position.
- Make sure the safety belt is out of the child's reach, so that the child cannot grab and play with it.

Securing the center seat safety belt

When routing a center seat safety belt, you must activate the switchable locking feature. When the



- Buckle the safety belt ⇒ *Fig. 76*.
- Pull the shoulder belt portion of the safety belt all the way out of the retractor to activate the switchable locking feature. You should hear a clicking noise as the belt winds back into the retractor.
- Let the safety belt fully retract and then pull on it to make sure the switchable locking feature is active and the safety belt is properly fastened and tight so that the child cannot grab and play with the safety belt.

When a child safety seat is secured on the rear bench, adjust the position of the front seat to provide the child with sufficient space. Therefore, adjust the front seat to the size of the child safety seat and the child. Consider the proper seating position of the passenger ⇒ .

When child restraints are not needed, be sure to remove the safety belt(s) from around the head restraint(s), unbuckle the center safety belt, and return all safety belts to their normal stored positions so that they will be available for regular use.

WARNING

A child in a child restraint installed with the LATCH/UCRA lower universal anchorages or with the standard safety belt on the rear seat may play with unused rear seat safety belts and become entangled, resulting in serious personal injury and even death.

- Always secure unused rear seat safety belts out of the reach of children in child restraints such as by properly routing them around the head restraint adjacent to the seating position where the child restraint is installed.

NOTE

- Be careful not to activate the switchable locking retractor when routing the unused safety belt around the head restraint adjacent to the seat where a child restraint has been installed.
- Only pull the unused safety belt out far enough to allow you to route the belt around the head restraint.
- When installing a child restraint, be careful not to get the belt caught in the structure of the child restraint and become damaged, especially when the switchable locking feature has been activated.



Fig. 77 Rearward-facing infant seat properly installed on the rear seat.



Read and follow the introductory information and safety information first ⇒ [Introduction to the subject](#)

The American Academy of Pediatrics (AAP) recommends that all infants should ride in rear-facing car safety seats (in which the child faces the back of the vehicle) starting with their first ride home from the hospital. All infants and toddlers (generally up to age 3) should ride in a rear-facing car safety seat as long as possible – or until they reach the highest weight or height allowed by their child restraint's manufacturer. These infant seats support the baby's back, neck and head in a collision. Rear-facing child restraints can be used safely only on the rear seat of the vehicle ⇒ [Fig. 77](#).

Before installing a child restraint on the front passenger seat, be sure to follow the special instructions and heed the warnings ⇒ [Child restraints and the Advanced Airbag System](#) and ⇒ [The dangers of using child restraints on the front seat](#).

- When using the vehicle safety belt to install a child restraint, you must activate the switchable locking feature on the safety belt to help prevent the child restraint from moving ⇒ [Using a child restraint on the rear seat](#). Always follow the child restraint manufacturer's instructions when installing a child restraint.
- Attach the tether strap to the tether anchorage for the seating position where the child restraint is being installed ⇒ [Securing a child restraint with the Top Tether strap](#).


The airbag on the passenger side makes the front seat a potentially dangerous place for a child to ride. The front seat is not the safest place for a child in a forward-facing child restraint. It is a very dangerous place for an infant or a larger child in a rearward-facing seat.



LATCH/UCRA lower universal anchorages behind the front passenger seat or behind the driver seat. Always route the center safety belt and the unused safety belt for the seating position where the child restraint is being installed securely out of the child's reach. Securing the safety belts will help prevent a child from playing with an unused safety belt and becoming entangled with it ⇒ [Using a child restraint on the rear seat](#), ⇒ [Fig. 76](#).

DANGER!

Not using a child restraint, using the wrong child restraint or improperly installing a child restraint increases the risk of serious personal injury and death in a collision or other emergency situation.

- Never install rearward-facing child restraints or infant carriers on the front passenger seat, even with an Advanced Airbag System. A child will be seriously injured and can be killed when the inflating airbag hits the child restraint or infant carrier with great force and smashes the child restraint and child against the backrest, center armrest, door or roof.
- Always install rearward-facing child restraints and infant carriers on the rear seat.
- Never install a rearward-facing child restraint in the forward-facing direction. These restraints are designed for the special needs of infants and very small children and cannot protect them properly if the seat is forward-facing.
- If you must install a rearward facing child restraint on the front passenger seat because of exceptional circumstances, but the PASSENGER AIR BAG **OFF**  light does not come on and stay on, immediately install the rearward-facing child restraint at a seating position on the rear seat and have the airbag system inspected right away by your authorized Volkswagen dealer or authorized Volkswagen Service Facility.
- Always read and heed all WARNINGS whenever using a child restraint in a vehicle. See ⇒ [Safety belts](#), ⇒ [Airbag system](#), and ⇒ [Child safety and child restraints](#).

WARNING

A child in a child restraint installed with the LATCH/UCRA lower universal anchorages or with the standard safety belt on the rear seat may play with unused rear seat safety belts and become entangled, resulting in serious personal injury and even death.

as by properly routing them around the head restraint adjacent to the seating position where the child restraint is installed.

! NOTE

- Be careful not to activate the switchable locking retractor when routing the unused safety belt around the head restraint adjacent to the seat where a child restraint has been installed.
- Only pull the unused safety belt out far enough to allow you to route the belt around the head restraint.
- When installing a child restraint with a safety belt, be careful not to get the belt caught in the structure of the child restraint and become damaged, especially when the switchable locking feature has been activated.

Convertible child restraints

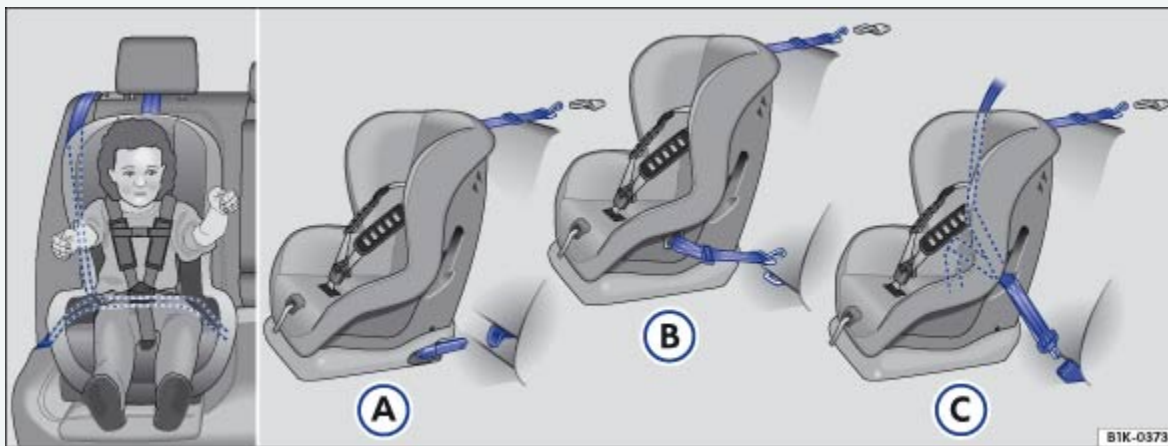


Fig. 78 Some child restraints have lower anchors and a top tether. Figures A and B show how to correctly install a LATCH/UCRA seat. Figure C shows the set up of a seat using the vehicle's safety belt system.



Read and follow the introductory information and safety information first ⇒ [Introduction to the subject](#)

Children between 1 and about 7 years old must always be properly restrained in a child restraint certified for their size and weight ⇒ [Fig. 78](#).

Once your child outgrows the rear-facing car seat (generally up to age 3), your child is ready to travel in a forward-facing car seat with a harness. Keep your child in a forward-facing car seat with a har-



Before installing a child restraint on the front passenger seat, be sure to follow the special instructions and heed the warnings ⇒ [Child restraints and the Advanced Airbag System](#) and ⇒ [The dangers of using child restraints on the front seat](#).

- When using the vehicle safety belt to install a child restraint, you must activate the switchable locking feature on the safety belt to help prevent the child restraint from moving ⇒ [Using a child restraint on the rear seat](#).
- Push the child restraint down with your full weight to get the safety belt really tight so that the seat cannot move forward or sideways more than about 1 inch (2.5 cm).
- Fasten the harness webbing that is part of the child restraint system securely and pull it tight so that you can only slip one finger underneath the shoulder belt portion at the child's chest.
- Attach the tether strap to the tether anchorage for the seating position where the child restraint is being installed ⇒ [Securing a child restraint with the Top Tether strap](#).

The airbag on the passenger side makes the front seat a potentially dangerous place for a child to ride. The front seat is not the safest place for a child in a forward-facing child restraint. It is a very dangerous place for an infant or a larger child in a rearward-facing seat.

You must take special precautions when installing a child restraint with the vehicle safety belt or with LATCH/UCRA lower universal anchorages behind the front passenger seat or behind the driver seat. Always route the center safety belt and the unused safety belt for the seating position where the child restraint is being installed securely out of the child's reach. Securing the safety belts will help prevent a child from playing with an unused safety belt and becoming entangled with it ⇒ [Using a child restraint on the rear seat](#), ⇒ [Fig. 76](#).


DANGER!

Not using a child restraint, using the wrong child restraint or improperly installing a child restraint increases the risk of serious personal injury and death in a collision or other emergency situation.

- Children on the front seat of any car, even with Advanced Airbags, can be seriously injured or even killed when an airbag inflates.
- A child in a rearward-facing child restraint installed on the front passenger seat will be seriously injured and can be killed if the front airbag inflates – even with an Advanced Airbag System.



the child restraint and child against the backrest, center armrest, door or foot.

- Always install rearward-facing child restraints on the rear seat.
- If you must install a rearward facing child restraint on the front passenger seat because of exceptional circumstances, but the PASSENGER AIR BAG **OFF**  light does not come on and stay on, immediately install the rearward-facing child restraint at a seating position on the rear seat and have the airbag system inspected right away by your authorized Volkswagen dealer or authorized Volkswagen Service Facility.
- Always read and heed all WARNINGS whenever using a child restraint in a vehicle. See [⇒ Safety belts](#) , [⇒ Airbag system](#) , and [⇒ Child safety and child restraints](#) .



WARNING

An improperly installed child restraint can interfere with the airbag as it deploys and seriously injure or even kill the child – even with an Advanced Airbag System.

- If exceptional circumstances require the use of a forward-facing child restraint on the front passenger's seat, the child's safety and well-being require the following special precautions to be taken:
 - Forward-facing child restraints installed on the front passenger seat may interfere with the deployment of the airbag and cause serious personal injury to the child.
 - Always make sure that the forward-facing seat has been designed and certified by its manufacturer for use on a front passenger seat with a front and side airbag.
 - Always carefully follow the manufacturer's instructions provided with the child restraint or carrier.
 - Never install a child restraint without a properly attached top tether strap if the child restraint manufacturer's instructions require the top tether strap to be used.
 - Never put the forward-facing child restraint up against or very near the instrument panel.
 - Always set the safety belt upper anchorage to the adjustment position that permits proper installation in accordance with the child restraint manufacturer's instructions.



ment range and move it back to the rearmost position in the seat's fore and aft adjustment range, as far away from the airbag as possible before installing the forward-facing child restraint.

- Always make sure that the safety belt upper anchorage is behind the child restraint and not next to or in front of the child restraint so that the safety belt will be properly positioned.
- Always make sure that nothing is in the way that prevents the front passenger's seat from being moved to the rearmost position in its fore and aft adjustment range.
- Always make sure that the backrest is in the upright position.
- Never place objects on the seat (such as a laptop, CD player, or electronic games device). These may influence the electrical capacitance measured by the capacitive passenger detection system and can also fly around in an accident and cause serious personal injury.
- Never place or use any electrical device (such as a laptop, CD player, or electronic games device) on the front passenger seat if the device is connected to the 12 Volt socket ⇒ *Power outlets*.
- If a seat heater has been retrofitted or otherwise added to the front passenger seat, never install any child restraint system on this seat.
- Make sure that there are no wet objects (such as a wet towel) and no water or other liquids on the front passenger seat cushion.
- Make sure that the PASSENGER AIR BAG **OFF**  light comes on and stays on all the time whenever the ignition is switched on.
- If the PASSENGER AIR BAG **OFF**  light does not come on and stay on, immediately install the forward-facing child restraint at a seating position on the rear seat and have the airbag system inspected by your authorized Volkswagen dealer or authorized Volkswagen Service Facility.

restraint can fly around during a sudden stop or in a collision.

WARNING

A child in a child restraint installed with the LATCH/UCRA lower universal anchorages or with the standard safety belt on the rear seat may play with unused rear seat safety belts and become entangled, resulting in serious personal injury and even death.

- Always secure unused rear seat safety belts out of the reach of children in child restraints such as by properly routing them around the head restraint adjacent to the seating position where the child restraint is installed.

NOTE

- Be careful not to activate the switchable locking retractor when routing the unused safety belt around the head restraint adjacent to the seat where a child restraint has been installed.
- Only pull the unused safety belt out far enough to allow you to route the belt around the head restraint.
- When installing a child restraint with a safety belt, be careful not to get the belt caught in the structure of the child restraint and become damaged, especially when the switchable locking feature has been activated.

Booster seats and safety belts

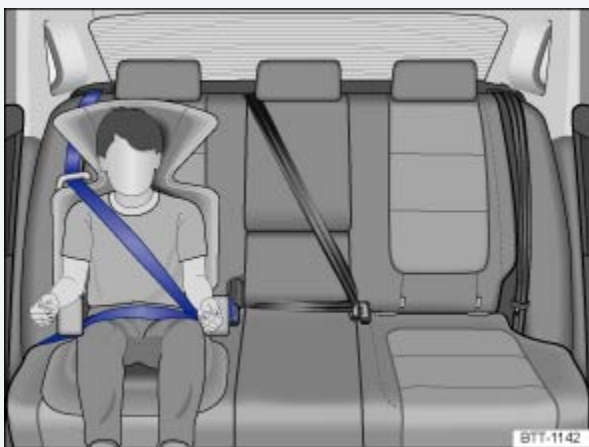


Fig. 79 Child properly restrained in a booster seat on the rear seat.



Read and follow the introductory information and safety information first ⇒ *Introduction to the*



Children between about 8 to 12 years old are best protected in child safety seats designed for their age and weight ⇒ [Fig. 79](#). Experts say that the skeletal structure, particularly the pelvis, of these children is not fully developed, and they must not use the vehicle safety belts without a suitable child restraint.

The vehicle's safety belts alone will not fit most children until they are at least 4 ft. 9 in. (57 inches / 1.45 meters) tall. Booster seats raise these children up so that the safety belt will pass properly over the strong parts of their bodies and the safety belt can help protect them in a collision.

- Do not use the switchable locking feature when using the vehicle's safety belt to restrain a child on a booster seat.
- Always position the shoulder portion of the safety belt midway over the child's shoulder. If you must transport an older child in a booster seat on the front passenger seat, you can use the safety belt height adjustment to help adjust the shoulder portion properly.
- Always make sure that the shoulder portion is snug across the shoulder and chest and never rests against or across the child's neck or face.
- Always make sure that the child can wear the lap belt portion across the upper thighs and never over the stomach or abdomen.

Children who are at least 4 ft. 9 in. (57 inches / 1.45 meters) tall can generally use the vehicle's 3 point lap and shoulder belts. Never use the lap belt portion of the vehicle's safety belt alone to restrain any child, regardless of how big the child is. Always remember that children do not have the pronounced pelvic structure required for the proper function of lap belt portion of the vehicle's 3 point lap and shoulder belts. The child's safety absolutely requires that a lap belt portion of the safety belt be fastened snugly across the upper thighs. Never let the lap belt portion of the safety belt pass over the child's stomach or abdomen.

It is usually best to put these children in appropriate booster seats and keep them in a booster seat until they are big enough to fit in a safety belt properly. Be sure the booster seat meets all applicable safety standards.

Booster seats raise the seating position of the child and reposition both the lap and shoulder parts of the safety belt so that they pass across the child's body in the right places. The routing of the belt over the child's body is very important for the child's protection, whether or not a booster seat is used. Children age 12 and under must always ride in the rear seat.



your child is:

- tall enough to sit without slouching; and
- able to keep his or her back against the vehicle seat; and
- able to keep his or her knees naturally bent over the edge of the vehicle seat; and
- able to keep his or her feet flat on the floor; and
- able to sit in that position during the entire trip.

The way the safety belt passes over the child's body is important for their safety and protection in a crash. Always make sure your child can wear the safety belt properly:

- The lap belt must lie snugly across the upper thighs, not the stomach.
- The shoulder belt must lie snugly across the shoulder and chest, and never cross the neck or face.
- Never let a child put the shoulder belt under the arm or behind the back, because it could cause severe injuries in a crash.

Always check belt fit on the child in every vehicle. A booster seat may be needed in some vehicles and not in others. If the seat belt does not fit properly, the child must continue to use a booster seat. Regardless of whether the child is using a booster or is able to properly wear the standard safety belt properly without a booster seat, keep your child in the back seat. Accident statistics show that children are safer on the rear seat than on the front seat.

In a collision, airbags must inflate within a blink of an eye and with considerable force. In order to do its job, the airbag needs room to inflate so that it will be there to protect the occupant as the occupant moves forward into the airbag.

Even Advanced Airbags can injure children when they inflate. A vehicle occupant who is out of position and too close to the airbag gets in the way of an inflating airbag. When an occupant is too close, he or she will be struck violently and will receive serious or possibly even fatal injuries.



In order for the airbag to offer protection, it is important that all vehicle occupants, especially children, who must be in the front seat under exceptional circumstances, be properly restrained and as far away from the airbag as possible. By keeping room between the child's body and the front of the passenger compartment, the airbag can inflate completely and provide supplemental protection in certain frontal collisions.




the front passenger seat or behind the driver seat. Always route and secure the unused center safety belt to help prevent a child from playing with the unused safety belt and becoming entangled in it
⇒ *Using a child restraint on the rear seat*, ⇒ *Fig. 76*.

WARNING

Not using a booster seat, using the booster seat improperly, incorrectly installing a booster seat or using the vehicle safety belt improperly increases the risk of serious personal injury and death in a collision or other emergency situation. To help reduce the risk of serious personal injury and/or death:

- Always make sure to position the shoulder portion of the 3 point belt over the middle of the child's shoulder.
- Never let the shoulder portion of the safety belt rest against or across the neck, face, chin, or throat of the child.
- Always make sure the lap belt portion of the 3 point belt is worn snugly across the upper thighs. Never let the lap belt portion of the safety belt pass over the child's stomach or abdomen.
- Never let a child put the shoulder belt under the arm or behind the back, because it could cause severe injuries in a crash.
- Failure to properly route safety belts over a child's body will cause severe injuries in a collision or other emergency situation.
- Children on the front seat of any car, even with Advanced Airbags, can be seriously injured or even killed when an airbag inflates.
- Never let a child stand or kneel on any seat, for example, the front seat.
- Never let a child ride in the cargo area of your vehicle.
- Always remember that a child leaning forward, sitting sideways or out of position in any way during a collision can be struck by a deploying airbag. This will result in serious personal injury or death.
- If you must install a booster seat on the front passenger seat because of exceptional circumstances, the PASSENGER AIR BAG **OFF**  light must come on and stay on, whenever the ignition is switched on.
- If the PASSENGER AIR BAG **OFF**  light does not come on and stay on, perform the checks de-



- Take the child restraint off the front passenger seat and install it properly at one of the seating positions on the rear seat if the PASSENGER AIR BAG **OFF**  light does not stay on whenever the ignition is switched on.
- Always read and heed all WARNINGS whenever using a child restraint in a vehicle. See [⇒ Safety belts](#) , [⇒ Airbag system](#) , and [⇒ Child safety and child restraints](#) .


WARNING

A child in a child restraint installed with the LATCH/UCRA lower universal anchorages or with the standard safety belt on the rear seat may play with unused rear seat safety belts and become entangled, resulting in serious personal injury and even death.

- Always secure unused rear seat safety belts out of the reach of children in child restraints such as by properly routing them around the head restraint adjacent to the seating position where the child restraint is installed.

Installing child restraints with a safety belt



Read and follow the introductory information and safety information first ⇒  [Introduction to the subject](#)

Safety belts for the rear seats and the front passenger seat must be locked with the switchable locking feature to properly secure child restraints.

Child restraints are designed to be secured to the vehicle with the lap belt portion of the 3 point lap and shoulder belt installed for the passenger seats. The outboard rear seating positions also have special fixtures for child restraints that can be used with LATCH/UCRA lower universal anchorages.

Regardless of the kind of child restraint that you use, always make sure that the child restraint is properly secured in the vehicle; otherwise the child could be seriously injured in a crash. Always follow legal requirements regarding the installation of child restraints.

Whenever a child restraint (except a booster seat) is installed with a safety belt, the safety belt must be locked so that the safety belt webbing cannot unreel. The switchable locking feature lets you lock the belt so that a child restraint can be properly installed and, for example, so that it cannot tip to the side when the vehicle goes around a corner.



Installing the child restraint on a rear seat

Always carefully follow the child restraint manufacturer's instructions when installing a child restraint in your vehicle ⇒ ⚠.

- Route the safety belt around or through the child restraint using the proper path for the safety belt as specified by the child restraint manufacturer.
- Insert the belt tongue into the buckle for that seating position.
- Make sure that the red release button faces away from the child restraint so that it can be unbuckled quickly.
- Remove all slack from the lap belt portion of the safety belt and hold it tightly against the child restraint.
- Push the child restraint down with your full weight to make sure that the child restraint will be properly installed with the safety belt really tight.
- Activate the belt's switchable locking feature ⇒ [Activating the switchable locking feature](#).
- Pull on the safety belt to make sure the safety belt is properly fastened and tight.
- Check the child restraint for proper installation by pulling on the child restraint at the place where the vehicle's safety belt goes into the child restraint. The child restraint should not move forward or sideways by more than about 1 inch (2.5 cm).

Special instructions for installing child restraints if the child restraint must be installed on the front seat



Always carefully follow the child restraint manufacturer's instructions when installing a child restraint in your vehicle ⇒ ⚠.

Place the child restraint on a seat, preferably on a rear seat ⇒ ⚠. If in exceptional circumstances you must install the child restraint on the front seat, be sure to follow the special instructions and heed the WARNINGS below.

- Make sure the front seat backrest is in the upright position.
- Move the front passenger seat to the rearmost position in the seat's fore and aft adjustment range, as far away from the airbag as possible.



cient to properly install the child restraint.



- Route the safety belt around or through the child restraint using the proper path for the safety belt as specified by the child restraint manufacturer.
- Insert the belt tongue into the buckle for that seating position.
- Make sure that the red release button faces away from the child restraint so that it can be unbuckled quickly.
- Remove all slack from the lap belt portion of the safety belt and hold it tightly against the child restraint.
- Push the child restraint down with your full weight to make sure that the child restraint will be properly installed with the safety belt really tight.
- Activate the belt's switchable locking feature ⇒ *Activating the switchable locking feature*.
- Pull on the safety belt to make sure the safety belt is properly fastened and tight.
- Check the child restraint for proper installation by pulling on the child restraint at the place where the vehicle's safety belt goes into the child restraint. The child restraint should not move forward or sideways by more than about 1 inch (2.5 cm).
- After checking to make sure that the child restraint is properly installed, make certain that the child restraint is correctly recognized by the capacitive passenger detection system in the front passenger seat and that the PASSENGER AIR BAG **OFF**  light signals the correct front passenger front airbag status. Please be sure to read the additional important information and heed the WARNINGS about the Advanced Airbag System and the function of the PASSENGER AIR BAG **OFF**  light in this Manual.

Always remember: Even though your vehicle is equipped with an Advanced Airbag System, all children, especially those 12 years and younger, must always ride in the back seat properly restrained for their age and size.

Activating the switchable locking feature

- Slowly pull the shoulder belt portion of the safety belt all the way out of the retractor.
- While keeping your weight on the child restraint, guide the shoulder belt portion of the safety belt back into the retractor until the belt lies flat and is tightened against the child restraint.
- You should hear a clicking noise as the belt winds back into the inertia reel of the safety belt retractor. Test the switchable locking feature by pulling on the belt. You should no longer be able to



- Pull on the safety belt to make sure the safety belt is properly fastened and tight.
- Check the child restraint for proper installation by pulling on the child restraint at the place where the vehicle's safety belt goes into the child restraint. The child restraint should not move forward or sideways by more than about 1 inch (2.5 cm).
- After checking to make sure that the child restraint is properly installed, make certain that the child restraint is correctly recognized by the capacitive passenger detection system in the front passenger seat and that the PASSENGER AIR BAG **OFF**  light signals the correct front passenger front airbag status. Please be sure to read the additional important information and heed the WARNINGS about the Advanced Airbag System and the function of the PASSENGER AIR BAG **OFF**  light in this Manual.

Always remember: Even though your vehicle is equipped with an Advanced Airbag System, all children, especially those 12 years and younger, must always ride in the back seat properly restrained for their age and size.

Deactivating the switchable locking feature

The switchable locking feature for child restraints will be deactivated automatically when the belt is wound all the way back into the retractor.

- Press the red button on the safety belt buckle. The belt tongue will pop out of the buckle.
- Guide the safety belt back by hand so that it rolls easily onto the retractor and the trim around the retractor will not be damaged.

Always let the safety belt retract completely into its stowed position. The safety belt can now be used as an ordinary safety belt without the switchable locking feature for child restraints.

If the switchable locking feature should be activated inadvertently, the safety belt must be unfastened and guided completely back into its stowed position to deactivate this feature. If the switchable locking feature is not deactivated, the safety belt will gradually become tighter and uncomfortable to wear.

WARNING

Using the wrong child restraint or an improperly installed child restraint can cause serious personal injury or death in an accident.

- Always make sure that the safety belt retractor is locked when installing a child restraint, ex-



during normal driving or in a crash.

- Always buckle the child restraint firmly in place even if a child is not sitting in it. A loose child restraint can fly around during a sudden stop or in a collision.
- Always make sure the seat backrest to which the child restraint is installed is in an upright position and securely latched into place and cannot fold forward. Otherwise, the seat backrest with the child restraint attached to it could fly forward in a collision or other emergency situation.
- Always read and heed all WARNINGS whenever using a child restraint in a vehicle ⇒ [Child safety and child restraints](#). Special precautions apply when installing a child restraint on the front passenger seat ⇒ [The dangers of using child restraints on the front seat](#), and ⇒ [Child restraints and the Advanced Airbag System](#), and ⇒ [Important safety instructions for using child restraints](#).

WARNING

Improperly installed child restraints increase the risk of serious personal injury and death in a collision.

- Never unfasten the safety belt to deactivate the switchable locking feature for child restraints while the vehicle is moving. You would not be restrained and could be seriously injured in an accident.

NOTE

When installing a child restraint, be careful not to get the belt caught in the structure of the child restraint and become damaged, especially when the switchable locking feature has been activated.

Securing the child restraint with LATCH/UCRA lower universal anchorages

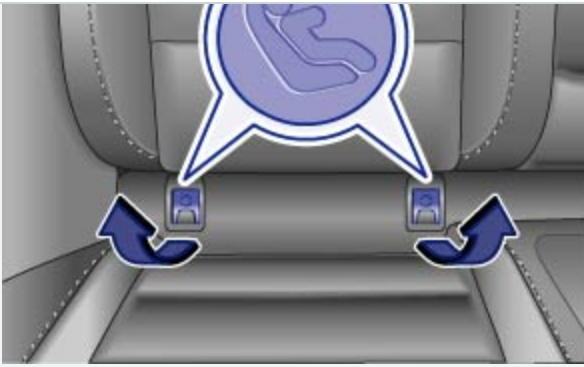


Fig. 80 On the rear outboard seat backrests: Markings on the covers of the LATCH/UCRA lower universal anchorages.

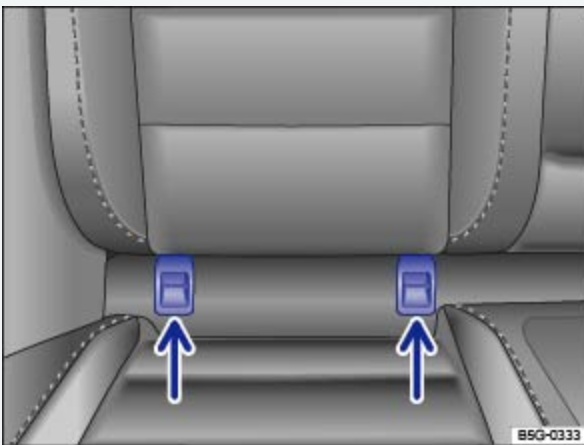


Fig. 81 On the rear outboard seat backrests: LATCH/UCRA lower universal anchorages (covers removed).



Read and follow the introductory information and safety information first ⇒ *Introduction to the subject*

LATCH is used in the United States for Lower Anchors and Tethers for Children. In Canada, Universal Child Restraint Anchorages (UCRA) is used to describe the combination of top tether straps and lower anchorages.

All child restraints manufactured after September 1, 1999 must have LATCH/UCRA lower universal anchorages.

The LATCH/UCRA lower universal anchorage attachment points are on the lower part of the rear seat backrest for the 2 outboard seating positions. Each lower universal anchorage point has a cover. The circular markings on the covers help you to locate the lower anchorages ⇒ Fig. 80. Remove the covers to access the lower anchorage points ⇒ Fig. 81 (arrows).



the vehicle's safety belts. Anchorages provide a secure and easy-to-use attachment and minimize the possibility of improper child restraint installation.

Remember that the LATCH/UCRA lower universal anchorage points are only intended for installation and attachment of child restraints specifically certified for use with these lower universal anchorages. Child restraints that are not equipped with the LATCH/UCRA lower universal anchorage attachments can still be installed with vehicle safety belts according to the child restraint manufacturer's instructions. You must never mount 2 child restraint systems to one LATCH/UCRA lower universal anchorage point at the same time. For instance, you must not install a child restraint with LATCH/UCRA lower universal anchorage points on one of the outboard seating positions and then use the inboard anchorage to also install a child restraint in the center of the rear seat that itself is not equipped with LATCH/UCRA lower universal anchorage points.

There are 2 ways to attach an appropriate child restraint to the LATCH/UCRA lower universal anchorages:

Rigid connectors on bars at the back of the child restraint:

Depending on your vehicle's seats, you may want to use guidance fixtures when installing a child restraint that has rigid mountings. Installation with guidance fixtures is easier and protects the upholstery. Guidance fixtures are included with the child restraint in some cases. If not, they can be purchased from an authorized Volkswagen dealer or an authorized Volkswagen Service Facility. The guidance fixtures must be installed in accordance with the manufacturer's instructions at the anchorage points between the seat cushion and the seat backrest.

- Make sure the seat backrest of the rear seat bench is in the upright position and securely latched in place.
- Release or deploy the top tether strap (if one is required by the child restraint manufacturer) to secure the seat ⇒ [Securing a child restraint with the Top Tether strap](#).
- Guide the upper tether strap under the rear head restraint (raise the head restraint if necessary).
- Attach the tether strap anchorage hook into the opening of the tether anchorage.
- Attach the connectors onto the LATCH/UCRA lower universal anchorages.
- Make sure you hear the child restraint click securely into place.
- Tighten the top tether strap (if there is one) to secure the seat ⇒ [Securing a child restraint with the Top Tether strap](#).



properly attached.

Releasing

- Release the top tether strap (if one is required by the child restraint manufacturer).
- Release the lower latch from the LATCH/UCRA lower universal anchorages following the child restraint manufacturer's instructions.

Hooks attached to adjustable straps (hook-on connectors)

- Make sure the seat backrest of the rear seat bench is in the upright position and securely latched in place.
- Attach the hook-on connectors with the spring catch release onto the LATCH/UCRA lower universal anchorage so that the connectors lock into place.
- Pull on the connector attachments to make sure that it is properly attached to the LATCH/UCRA lower universal anchorage.
- Pull straps tight following the child restraint manufacturer's instructions.
- Release or deploy the top tether strap (if one is required by the child restraint manufacturer) to secure the seat ⇒ [Securing a child restraint with the Top Tether strap](#).
- Guide the upper tether strap under the rear head restraint (raise the head restraint if necessary).
- Guide the tether strap between the rear seat back and the luggage compartment cover.
- Attach the tether strap anchorage hook into the opening of the tether anchorage and pull the top tether strap tight.
- After you have installed the child restraint, pull on both of the adjustable straps on the child restraint and pull also on the tether strap to make certain the seat is secure and properly attached.

Releasing

- Loosen the tension on the hook-on connector straps following the child restraint manufacturer's instructions.
- Release the top tether strap (if one is required by the child restraint manufacturer).
- Depress the spring catch on the hook.
- Hold the spring catch in the depressed position.



connector from the lower anchorage.

You must take special precautions when installing a child restraint with the vehicle safety belt or with LATCH/UCRA lower universal anchorages behind the front passenger seat or behind the driver seat. Always route the unused center seat safety belt and the unused safety belt for the seating position where the LATCH/UCRA child restraint is being installed around the rear head restraint behind the child restraint to help prevent a child from playing with the unused belt and becoming entangled in it.

WARNING

Improper use of the LATCH/UCRA system can increase the risk of serious personal injury and death in an accident.

- Always carefully follow the child restraint manufacturer's instructions for proper installation of the child restraints and proper use of tether straps as well as the LATCH/UCRA lower universal anchorages or safety belts in your vehicle.
- Never mount 2 child restraint systems on 1 LATCH/UCRA lower universal anchorage point.
- These anchors were developed only for child restraints using the LATCH/UCRA system.
- Never attach other child restraints, belts, luggage or other things to the LATCH/UCRA anchorages.
- Always make sure that you hear a click when latching the seat in place. If you do not hear a click, the seat is not secure and could fly forward and hit the interior of the vehicle or be ejected from the vehicle.

NOTE

- To help prevent permanent indentations from forming in the cushion, remove the guidance fixtures from the anchorage points when there is no child restraint secured in the vehicle anchorage points.
- To help prevent damage to the seat upholstery, always remove the guidance fixtures from the anchorage points before folding the backrest on the rear bench seat forward.

Be careful not to activate the switchable locking retractor when routing the safety belts around the head restraints. Only pull the safety belt out far enough to allow you to route the belt around the head restraint.

Securing a child restraint with the Top Tether strap

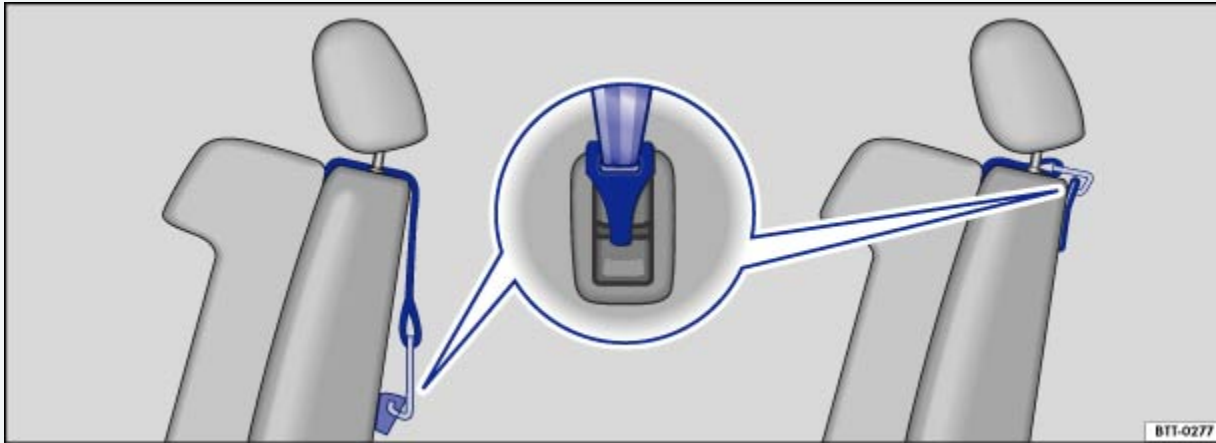


Fig. 82 Example of a mounted upper tether strap: The top tether strap reduces the forward movement of the child restraint in a crash, to help reduce the risk of head injury if the child hits the vehicle interior.

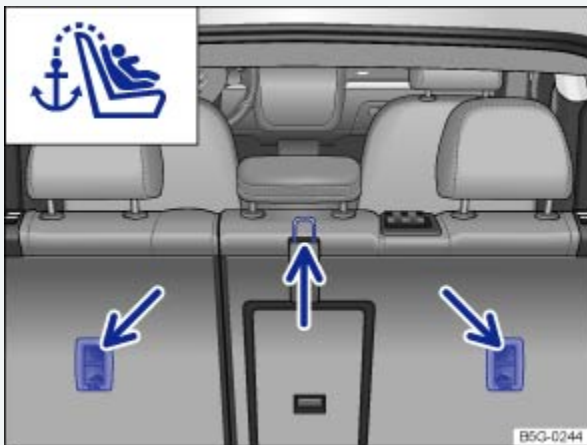


Fig. 83 Anchorages for the top tether strap on the back of the rear seat.



Read and follow the introductory information and safety information first ⇒ *Introduction to the subject*

Installing the tether strap

- Release or deploy the tether strap on the child restraint according to the child restraint manufacturer's instructions ⇒ .
- Remove the luggage compartment cover, if necessary.



- Outer seating position: Guide the upper tether strap under the outer rear head restraint (raise the head restraint if necessary). *For child restraints with V-tether straps:* Always make sure that the head restraint guide rods do not interfere with any part of the top tether strap.
- Center seating position: Guide the upper tether strap under the center rear head restraint only when it is pushed all the way up. If the tether strap hook is too big to pass under the center head restraint, push the head restraint all the way down and guide the strap over the center head restraint.
- Guide the tether strap between the rear seat backrest and the luggage compartment cover.
- Attach the tether strap anchorage hook into the opening of the tether anchorage ⇒ [Fig. 83](#).
- Pull on the tether strap hook so that the spring catch of the hook is engaged.
- Tighten the tether strap firmly following the child restraint manufacturer's instructions.
- Move the head restraint back into the original position, if necessary ⇒ [Adjusting the seating position](#).

Releasing the tether strap

- Loosen the tension on the tether strap following the child restraint manufacturer's instructions.
- Depress the spring catch on the hook and release it from the anchorage.

WARNING

Improper installation of child restraints will increase the risk of injury and death in a crash.

- Always follow the instructions provided by the manufacturer of the child restraint when installing it in your vehicle.
- Never install a child restraint without a properly attached top tether strap if the child restraint manufacturer's instructions require the top tether strap to be used. The use of a top tether strap for forward-facing child restraints is required by law in Canada.
- Improper use of top tether straps and anchors can lead to injury in a collision. The anchors are designed to withstand only those loads imposed by correctly fitted child restraints.
- Never attach 2 child restraint systems to 1 top tether strap or top tether anchorage.
- Never attach a child restraint tether strap to a tie-down hook in the luggage compartment.



part restraints.


- Never secure or attach any luggage or other items to the top tether anchorages.

NOTE

If you leave the child restraint with the tether strap firmly installed for several days, this could leave a mark on the upholstery on the seat cushion and backrest in the area where the tether strap was installed. The upholstery would also be permanently stretched around the tether strap. This applies especially to leather seats.

Sources of information about child restraints and their use



Read and follow the introductory information and safety information first ⇒  [Introduction to the subject](#)

The following are some sources of additional information about child restraint selection, installation and use:

Safety authorities advise that the best child safety seat is the one that fits your child and fits in your vehicle, and that you will use correctly and consistently.

Try before you buy!

Transport Canada Information Centre

Tel.: 1-800-333-0371

Tel.: 1-613-998-8616 (Ottawa)

<http://www.tc.gc.ca/roadsafety>

National Highway Traffic Safety Administration

Tel.: 1-888-327-4236 (TTY: 1-800-424-9153)

<http://www.nhtsa.gov>

<http://www.safercar.gov>

National SAFE KIDS Campaign

Tel.: 1-202-662-0600

<http://www.safekids.org>

SafetyBeltSafe U.S.A.



<http://www.carseat.org>

Volkswagen Customer CARE

Tel.: 1-800-822-8987

Lights and vision

Lights



Introduction to the subject

In this chapter you will find information on the following subjects:

⇒ *Indicator lights*

⇒ *Turn signal lever and high beam switch*

⇒ *Switching lights on and off*

⇒ *Lights and vision – features*

⇒ *Coming Home/Leaving Home features (orientation lighting)*

⇒ *Light Assist*

⇒ *Instrument panel lighting and headlight range adjustment*

⇒ *Interior and reading lights*

Always obey local vehicle lighting laws.

The driver is always responsible for the correct headlight settings.

WARNING

Crashes and other accidents can happen when you cannot see the road ahead and when you cannot be seen by other motorists.

weather is bad or visibility is poor.

WARNING

Headlights that are aimed too high and improper use of the headlight flasher or high beams can blind and distract other drivers. This can lead to a crash and serious personal injuries.

- Always make sure that headlights are properly adjusted.
- Never use the headlight flasher or high beams when they can blind or distract other drivers.

Indicator lights



Read and follow the introductory information and safety information first ⇒ [Introduction to the subject](#)

Indicator lights in the instrument cluster

Lights up Possible cause

Proper response



Central caution light.

Read and follow the text messages in the instrument cluster display.



One or more driving lights not working^{a)}, excluding the Adaptive Front Lighting System (AFS).^{b)}

Replace the burned out bulb ⇒ [Replacing light bulbs](#). If all light bulbs are OK, see an authorized Volkswagen dealer or authorized Volkswagen Service Facility.



Left or right turn signal.



The indicator light blinks twice as fast if a turn signal is not working on the vehicle or the trailer.

Check the turn signals on the vehicle and the trailer.



High beams switched on or headlight flashers in use.

⇒ *Turn signal lever and high beam switch.*



Light Assist high beam control switched on. ⇒ *Light Assist.*

When the ignition is switched on, several warning and indicator lights come on briefly for a function check. They go out after a few seconds.

Indicator lights in the light switch

Lights up Possible cause



The fog lights are switched on ⇒ *Switching lights on and off*



The parking lights are switched on ⇒ *Switching lights on and off.*



The automatic headlights and, if applicable, the daytime running lights are switched on ⇒ *Switching lights on and off.*



WARNING



break down in traffic and result in a collision and serious personal injury.

- Never ignore warning lights or text WARNINGS.
- Always stop the vehicle as soon as it is safe to do so.
- Whenever stalled or stopped for repair, move the vehicle a safe distance off the road, stop the engine, turn on the emergency flashers, and use other warning devices to warn approaching traffic.
- Never park the vehicle in areas where the hot catalytic converter and exhaust system can come into contact with dry grass, brush, spilled fuel, oil, or other material that can catch fire.
- A broken down vehicle presents a high accident risk for itself and others. Switch on emergency flashers and set up a warning triangle to warn oncoming traffic.

NOTE

Failure to heed warning lights or text WARNINGS can result in vehicle damage.



High Intensity Discharge (HID) headlights provide bright, uniform lighting to help you see and be seen. The light comes from an electric arc between two electrodes in the gas-filled bulb. Over time, the electrodes can wear down and the gap between them will get wider. The HID lamp's control unit then increases the voltage to keep the arc's brightness constant. However, the commonly called "Xenon" bulbs will also ultimately burn out. Before they burn out, HID lamps can flicker. A message will then appear in the MFD. This is your reminder to see an authorized Volkswagen dealer or an authorized Volkswagen Service facility to check the headlights.

a) Displayed in color on an instrument cluster with color display.

b) A separate display appears in the instrument cluster if there is an AFS malfunction.

Turn signal lever and high beam switch

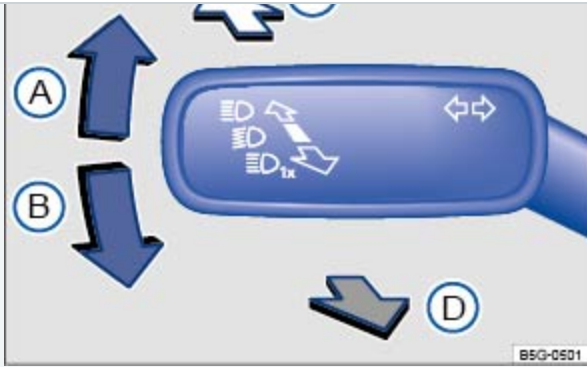


Fig. 84 On the left side of the steering column: Turn signal lever and high beam switch.

Read and follow the introductory information and safety information first ⇒ [Introduction to the subject](#)

Move the lever to the desired position

- A** Right turn signal .
- B** Left turn signal .
- C** Switching high beams on ⇒ . An indicator light lights up in the instrument cluster when the high beams are switched on.
- D** Switching the high beams off and operating the headlight flasher. The *headlight flasher* turns on the high beams as long as the lever is pulled and manually held in the pulled position. The indicator light lights up. When released, the lever moves back to the home position and turns off the high beams. The indicator light goes out.

Move the lever back to the home position to turn the selected feature off.

Convenience turn signal (lane change feature)

To use the convenience turn signal, move the lever up or down slightly, just to the point of resistance and then release it. If you have the convenience turn signal switched on, the turn signals and the turn signal indicator flash 3 times. If it is switched off, they flash as long as you hold the lever up or down, and go out when you release the lever.

The convenience turn signal can be switched on and off in the Infotainment system by pressing the **CA** **R** button followed by the and Lights function keys ⇒ [Menu and system settings](#).

Improper use of high beams can distract and blind others, causing accidents and serious injuries.



The turn signal light works only when the ignition is switched on. The emergency flasher works even when the ignition is switched off ⇒ *In an emergency*.



The indicator light flashes twice as fast if a turn signal bulb is burned out.



High beams can only be switched on when the low beams are on.

Switching lights on and off



Fig. 85 Headlight switch next to the steering wheel.

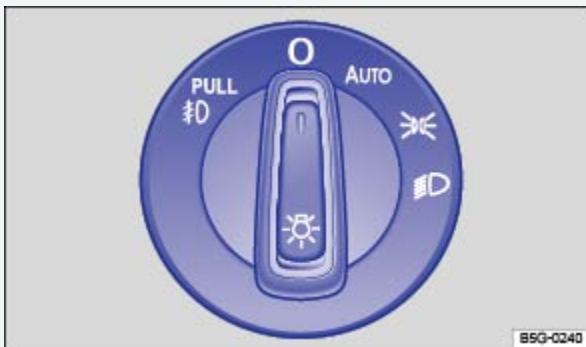


Fig. 86 Headlight switch next to the steering wheel (with fog lights and automatic headlights, if equipped).



Read and follow the introductory information and safety information first ⇒ *Introduction to the subject*



Symbol	When the ignition is switched off	When the ignition is switched on
0	Fog lights and low beams switched off.	Headlights off, daytime running lights (DRL) on.
AUTO	Orientation lighting may be switched on.	Automatic headlights active; DRL on.
	Low beams switched off. The DRL may stay on. The length of time they stay on depends on the vehicle battery charge.	Headlights and taillights switched on.
	Parking lights and taillights switched on.	Parking lights, DRL, and taillights switched on.
	Fog lights switched off. The DRL may stay on for some time.	Headlights and fog lights switched on.

Fog lights (if equipped)


The indicator light in the headlight switch shows that the fog lights are switched on.

- To switch on the fog lights : first turn the light switch to position or **AUTO**, then pull the light switch out to the detent.
- To switch off the fog lights, push the switch back in. To then turn off the headlights, turn the switch to position **0**.

Acoustic warning when lights are not switched off



the driver door. This is to remind you that lights are still on.

- Light switch in position .

WARNING

Daytime running lights and parking lights are not bright enough to let you see ahead or be seen by others when it is dark.


- Always switch on the low-beam headlights at dusk or when it is dark and whenever the weather is bad or visibility is poor.
- Never use the daytime running lights to see where you are going. They are not bright enough and will not let you see far enough ahead for safety, especially at dusk or when it is dark. Always switch on the low-beam headlights at dusk or when it is dark.
- The taillights do not come on with the daytime running lights. Unless the taillights are on, a vehicle cannot be seen by others in bad weather, at dusk, or when it is dark.
- Even if automatic headlights (**AUTO**) are switched on, the low-beam headlights may still not come on by themselves in fog or heavy rain. You have to switch on the low-beam headlights manually.




In cool or humid weather, the insides of the headlights, the rear lights, and turn signals can temporarily fog up. This is normal and does not affect the service life of the vehicle's lighting system.


Lights and vision – features



Read and follow the introductory information and safety information first ⇒  [Introduction to the subject](#)



Parking lights

If the ignition is switched off and the vehicle is locked from the outside with the headlight switch in the  position, the parking lights in both headlights come on together with both taillights.

If the headlight switch is in the  position *before* you switch off the ignition, and you do not switch the parking lights off when leaving the vehicle, the parking lights stay on for about 30 minutes before





battery if they were left on unintentionally.

If you move the headlight switch to the  position *after* switching off the ignition, the parking lights stay on when you leave the vehicle and will not switch off automatically ⇒  .

Daytime running lights (DRL)

Separate lamps are installed in the headlights or in the front bumper for the daytime running lights (DRL).

The daytime running lights are switched on whenever the ignition is switched on and the light switch is in position **0**, **AUTO**, or .

When the daytime running lights are switched on, only these separate lamps come on if the headlight switch is in position **0** or **AUTO** ⇒  .

If the light switch is in position **AUTO**, a low-light sensor switches the low beams as well as the instrument and switch lighting on and off automatically.

Daytime running lights (DRL) parking feature

Some models are equipped with a daytime running lights (DRL) parking feature that switches the daytime running lights off when the parking brake is engaged and the ignition is switched on.

Function	Action
Switching the DRL off:	<ul style="list-style-type: none"> - Switch the ignition on. - Turn the light switch to the 0 position. - Set the parking brake.
Switching the DRL back on:	<ul style="list-style-type: none"> - Release the parking brake.



Your vehicle may have fog lights under the front bumper, which on some models are also static cornering lights. On some models the static cornering lights may be integrated in the headlights. At speeds below about 25 mph (40 km/h), the light on one side of the vehicle will come on automatically when you turn a corner. If you turn to the right, the right fog light comes on; turn left and the left fog light comes on. The light dims and goes out when the steering wheel is straightened out again.

When you move the selector lever to Reverse (R), the static cornering lights on both sides of the vehicle may come on so that you can see the area around the vehicle better when backing up.

The static cornering lights work only when the headlights are on. If you are using automatic headlights (headlight switch in the **AUTO** position → Fig. 86), they work only when the headlights have been automatically switched on. The static cornering lights do not come on when the headlight switch is in the **0** position or when the fog lights themselves have been switched on ⇒ [Switching lights on and off](#).

Automatic headlights (AUTO)

Your vehicle may be equipped with automatic headlights (**AUTO**), which are a convenience feature only and cannot always recognize all lighting and driving situations.

If the light switch is in the **AUTO** position, both vehicle lighting and instrument and switch lighting are automatically switched on and off in the following situations ⇒ ⚠ :

Automatic activation:	Automatic deactivation:
If the low-light sensor registers <i>darkness</i> , for example, when driving through a tunnel or at dusk.	If sufficient brightness is registered.
If the rain sensor recognizes rain and switches the windshield wipers on.	If the windshield wipers have not moved for several minutes.

You can adjust the level of darkness the vehicle must register before automatically switching on the




and Lights → [Menu and system settings](#). You can also turn the automatic activation of the headlights with the rain sensors on and off via this menu.

Adaptive Front Lighting System (AFS)

The Adaptive Front Lighting System (AFS) works only with the low beams switched on and only at speeds above about 6 mph (10 km/h). The swivel-mounted lamps automatically improve road illumination during cornering.

In vehicles with Driving Mode Selection, the selected driving mode can affect the turning of the lights ⇒ [Driving Mode Selection](#).

In some models, the headlights will turn independently, even when driving straight ahead. They can adjust according to the weather conditions and the speed of the vehicle to better light up the road ahead. The bulbs return to their original position after a short period of time, depending on the vehicle speed.

On vehicles equipped with AFS, the feature can be switched on and off in the Infotainment system by pressing the **CAR** button followed by the  and Lights function keys ⇒ [Menu and system settings](#).

WARNING

Crashes and other accidents can happen when you cannot see the road ahead and when you cannot be seen by other motorists.

- Never use daytime running lights (DRL) to see where you are going. DRL are not bright enough to light up the roadway and be seen by other motorists. You will not be able to see far enough ahead for safety, especially at dusk or when it is dark. Always switch on the low-beam headlights at dusk or when it is dark.
- The taillights do not come on when the daytime running lights are switched on and the headlight switch is in position **0** or **AUTO**. A vehicle without taillights on cannot be seen by others in bad weather, at dusk, or when it is dark.
- If automatic headlights (**AUTO**) are switched on, the low-beam headlights still may not be switched on in fog or heavy rain. You have to switch on the low-beam headlights yourself.

NOTE




In cool or humid weather, the insides of the headlights, the rear lights, and turn signals can temporarily fog up. This is normal and does not affect the service life of the vehicle's lighting system.

Coming Home/Leaving Home features (orientation lighting)



Read and follow the introductory information and safety information first ⇒ [Introduction to the subject](#)

Your vehicle may be equipped with Coming Home/Leaving Home features, which are controlled automatically by a low-light sensor.

The length of time the lights stay on can be adjusted or the feature can be activated and deactivated in the Infotainment system by pressing the **CAR** button followed by the  and Lights function keys ⇒ [Menu and system settings](#).

Coming Home	Action
Switch on:	<p>- Switch off the ignition.</p> <p>The Coming Home feature is switched on when the headlight switch is in the AUTO position and the low-light sensor registers <i>darkness</i>.</p> <p>The <i>delay period</i> starts once the last vehicle door or the trunk lid is closed.</p>



Switch off:	<ul style="list-style-type: none">- Automatically after delay period is over. - Automatically, if a vehicle door or the trunk lid is still open about 30 seconds after activation. - Turn light switch to the 0 position. - Switch the ignition on.
-------------	---

Leaving Home	Action
Switch on:	<ul style="list-style-type: none">- Unlock the vehicle if the light switch is in the AUTO position and the low-light sensor registers <i>darkness</i>.



Switch off:

- Automatically after preset delay period is over.
- Lock the vehicle.
- Turn the light switch to the **0** position.
- Switch the ignition on.



If the Coming Home feature is switched on and the driver door is opened, no warning chime will sound to alert you that the lights are still on.

Light Assist



Read and follow the introductory information and safety information first ⇒ [Introduction to the subject](#)



Your vehicle may be equipped with the Light Assist automatic high beam control system.

Light Assist high beam control

Light assist switches the high beam headlights on at speeds above about 37 mph (60 km/h), depending on the surroundings and traffic conditions, and off again at speeds below about 18 mph (30 km/h), within the limits of the system. ⇒ . The system is controlled by a camera mounted in the rearview mirror base.

Light Assist generally detects well-lit areas such as towns and switches the high beam headlights off when driving through these areas.





Function	Action
Switch on:	<ul style="list-style-type: none">- Switch the ignition on and turn the light switch to the AUTO position.- Push the turn signal lever forward (out of the home position) ⇒ <i>Turn signal lever and high beam switch</i>.
	If the  indicator light appears in the instrument cluster display, Light Assist is switched on.
Switch off:	<ul style="list-style-type: none">- Switch the ignition off.- OR Turn the light switch to a position other than AUTO ⇒ <i>Switching lights on and off</i>.- OR When the high beam headlights are on, pull the turn signal lever back to the home position.- OR Push the turn signal lever forward to switch the high beam headlights on manually. Light Assist switches off.

On appropriately equipped vehicles, Light Assist can be turned on or off via the Infotainment system



Adjusting Light Assist sensitivity

Light Assist has two sensitivity levels.

- *Increase sensitivity:* Push the turn signal forward from the home position and hold for 15 seconds. The  indicator light in the instrument cluster display flashes 3 times to confirm the increased sensitivity level.
- *Reset sensitivity to the factory setting:* Push the turn signal lever forward from the home position a second time and hold for 15 seconds. The  indicator light in the instrument cluster display flashes (quickly) 3 times. OR: Turn the ignition off and back on again.

Light Assist malfunction

The following conditions can prevent Light Assist from switching the high beam headlights off in time or from switching them off at all:

- Poorly lit roads with highly reflective signs.
- If there are others on the road with insufficient lighting, such as pedestrians or bicycles.
- In tight curves, when traffic is partially hidden, on steep hills, or in valleys.
- On roads with a center barrier where the driver can clearly see oncoming traffic above the barrier, for example, a truck driver.
- If the camera is not working properly or the power is interrupted.
- In fog, snow, or heavy rain.
- When there is dust or sand in the air.
- If the windshield is damaged in the area of the camera.
- If the camera's visual field is fogged over, dirty, or covered by a sticker, snow, or ice.

WARNING

Never let the additional comfort provided by Light Assist tempt you into taking extra risks. The system is not a substitute for careful and attentive driving.

- Always be prepared to control the headlights yourself and to adapt them to road, traffic, weather, and visibility conditions.

certain situations.

- If the camera's area of view is dirty, covered, or damaged, Light Assist may not work properly. Changes to the vehicle lighting system, such as by adding additional headlights, can also change the way the systems work.

NOTE

To help the Light Assist system function properly, note the following:

- Always keep the windshield in front of the camera clean and free of snow and ice; do not cover the camera's area of view.
- Check the windshield for damage in the area of the camera.



The headlight flasher and the high beams can be switched on and off manually at any time with the turn signal lever ⇒ *Turn signal lever and high beam switch*.



The illuminated display on an electronic device, for example, an external navigation device, may prevent the Light Assist system from functioning properly.

Instrument panel lighting and headlight range adjustment




Fig. 87 To the left of the steering wheel: Thumbwheel to adjust instrument panel lighting ①.



Read and follow the introductory information and safety information first ⇒ *Introduction to the subject*


Instrument cluster and switch brightness




turning the thumbwheel ⇒ [Fig. 87](#) . On appropriately equipped vehicles, you can adjust other interior lights by pressing the **CAR** button followed by the  and Lights function keys in the Infotainment system ⇒ [Menu and system settings](#) .

In some vehicles with daytime running lights (DRL), the instrument cluster lighting switches off automatically when it is dark outside or when driving through tunnels, for example. You will need to switch the headlights on manually when this happens, so that the vehicle's taillights will turn on ⇒ [Lights and vision – features](#) .

Headlight range adjustment

For vehicles equipped with halogen headlights: The headlight range cannot be manually adjusted. If you believe the headlights are not properly adjusted or are not sure, have them checked immediately by an authorized Volkswagen dealer or an authorized Volkswagen Service Facility ⇒  .

For vehicles equipped with HID (Xenon) headlights: The headlights are equipped with an automatic leveling feature that automatically adjusts the headlight range to the vehicle loading condition once the low beams are switched on ⇒  .

WARNING

Headlights that are aimed too high because of the way the vehicle is loaded can blind and distract other drivers. This can lead to a crash and serious personal injuries.

- Always make sure the headlights are adjusted to loading conditions so that they do not blind others.


WARNING

If the automatic leveling feature of the headlights does not work properly or at all, the headlights could blind and distract other drivers. This can lead to a crash and serious personal injuries.




- Have headlight range adjustment checked immediately by an authorized Volkswagen dealer or an authorized Volkswagen Service Facility.

Interior and reading lights



Read and follow the introductory information and safety information first ⇒  [Introduction to the](#)



Button	Function
	<p>Door contact button.</p> <p>Press the button, and the interior lights come on automatically when the vehicle is unlocked, a door is opened, or the vehicle key is removed from the ignition.</p> <p>The lights go out about 20 seconds after you close the doors. They also go out when you lock the vehicle or switch on the ignition.</p> <p>Press the button back out again to switch the door contact feature off.</p>
	Reading light on or off.
	Rear interior lights on.

Glove and luggage compartment lights

The glove and luggage compartments may have lights that come on automatically when they are opened and go off when they are closed.

Ambient (background) lighting (if equipped)

When the ignition and the headlights are switched on, ambient lights in the doors and footwells light up.

Infotainment system by pressing the **CAR** button followed by the and Lights function keys ⇒ *Menu and system settings*.



The interior and reading lights go out when you lock the vehicle or a few minutes after you remove the vehicle key from the ignition. This helps to prevent unnecessary drain on the vehicle battery.

Sun protection



Introduction to the subject

In this chapter you will find information on the following subjects:

⇒ *Sun visors*

⇒ *Windshield made of heat-insulating glass*

WARNING

Sun visors can reduce visibility.

- Always stow sun visors when not needed to block sun glare.

Sun visors

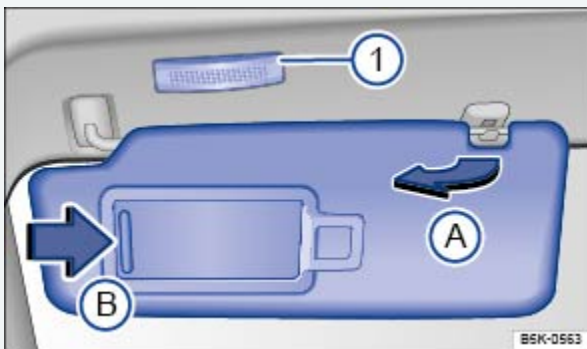


Fig. 88 In the headliner: Sun visor.



Read and follow the introductory information and safety information first ⇒ *Introduction to the subject*

- Flip the sun visor down toward the windshield.
- Lift it out of the retaining clip ⇒ [Fig. 88](#)Ⓐ and swivel it over toward the door.

Additional sun visor positions

On some vehicles, you can slide the sun visor towards the rear of the vehicle after swiveling it over to the door.

Vanity mirror and lighting

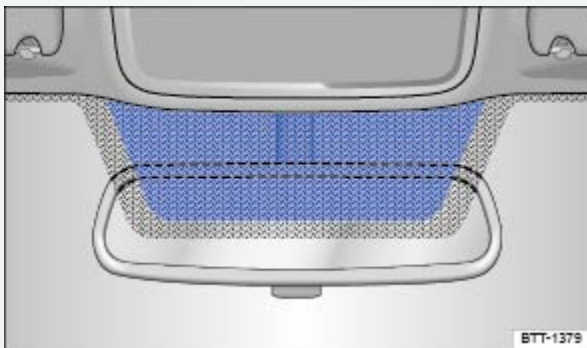
A vanity mirror is behind a cover in the sun visor. Your vehicle may also be equipped with a light ⇒ [Fig. 88](#)Ⓛ that comes on when you slide the cover Ⓜ open.

The light goes out when you shut the cover or if you flip the sun visor up again.



The interior light above the sun visor goes out after several minutes. This helps to prevent unnecessary drain on the vehicle battery.

Windshield made of heat-insulating glass



[Fig. 89](#) Heat-reflective windshield with communications window (blue shaded area).



Read and follow the introductory information and safety information first ⇒ [Introduction to the subject](#)

Windshields made of insulating glass have a transparent metallic infrared-reflecting coating. There is an uncoated area (communications window) just above the inside rearview mirror ⇒ [Fig. 89](#). This serves as a communications window for transmitting signals to and from electronic components and accessories.



can cause the electronic components to malfunction.

Windshield wipers and washer



Introduction to the subject

In this chapter you will find information on the following subjects:

⇒ *Indicator light*

⇒ *Windshield wiper lever*

⇒ *Windshield wiper functions*

⇒ *Windshield wiper service position*

⇒ *Rain sensor*

⇒ *Checking and refilling windshield washer fluid*

WARNING

Windshield washer fluid without enough frost protection can freeze on the windshield and reduce visibility.

- Use the windshield washer system with enough frost protection for winter temperatures.
- Never use the windshield wipers/washers when it is freezing without first defrosting the windshield. The washer solution may freeze on the windshield and reduce visibility.

WARNING

Worn or dirty wiper blades reduce visibility and increase the risk of accidents and severe injuries.

- Always replace wiper blades that are worn, damaged, or do not keep the windshield clear.

NOTE



make sure that blades are not frozen to the windshield before operating the wipers. Using the windshield wiper service position can be helpful in cold weather so the wipers do not freeze to the windshield ⇒ [Windshield wiper service position](#).

Indicator light



Read and follow the introductory information and safety information first ⇒ [Introduction to the subject](#)

Your vehicle may be equipped with an indicator light that comes on when the windshield washer fluid level is low.

Lights up

Proper response

Not enough windshield washer fluid.^{a)}



Refill windshield washer reservoir at the next opportunity ⇒ [Checking and refilling windshield washer fluid](#).

When the ignition is switched on, several warning and indicator lights come on briefly for a function check. They go out after a few seconds.

NOTE

Failure to heed warning lights or text WARNINGS can result in vehicle damage.

^{a)} Displayed in color on an instrument cluster with color display.

Windshield wiper lever

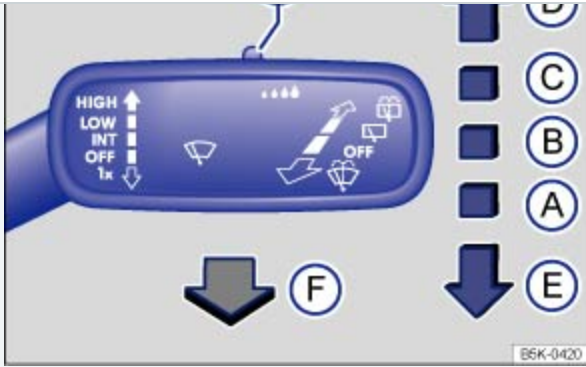


Fig. 90 Operating the front windshield wipers.

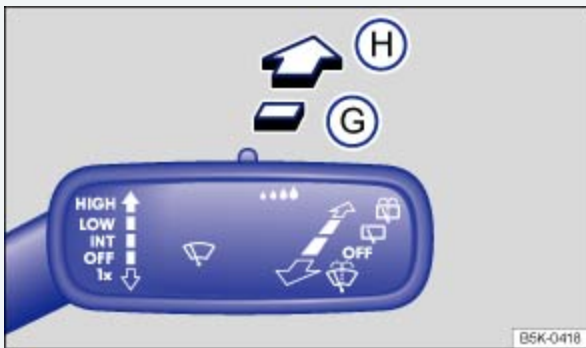


Fig. 91 Operating the rear wiper.








Read and follow the introductory information and safety information first ⇒ [Introduction to the subject](#)


Move the lever to the desired position ⇒ :

Ⓐ	OFF	Wiper switched off.
Ⓑ	INT	Intermittent wiping for the front windshield. Rain sensor active (if equipped).
Ⓒ	LOW	Slow wiper speed.
Ⓓ	HIGH	Fast wiper speed.



Ⓔ		One-tap wiping – brief wiping. Hold the lever pressed down longer to wipe more often.
Ⓕ		Pull the lever toward the steering wheel to activate the front windshield washers, then release.
Ⓖ		Intermittent wiping for the rear window. The wiper wipes about every 6 seconds.
Ⓗ		Press the lever forward as far as it will go to activate the rear window washers, then release to stay in intermittent wiping mode (position Ⓖ). Pull the lever toward the steering wheel to turn the rear wiper off.
①		Switch for adjusting the windshield wiper interval settings (vehicles without a rain sensor) or the sensitivity of the rain sensor (vehicles with a rain sensor).

If the front wipers are on, the rear wiper is switched on automatically when backing up.

This feature can be turned on and off in the Infotainment system by pressing the **CAR** button followed by the  and Mirrors and wipers function keys ⇒ [Menu and system settings](#).

NOTE

To help prevent damage to the wiper blades and the wiper motor when it is cold outside, always make sure that blades are not frozen to the windshield before operating the wipers. Using the



Windshield wiper service position.

- If the ignition is switched off while the wipers are running, the wipers will continue at the same wiping speed when the ignition is switched on again. Frost, ice, snow, leaves, and other objects on the windshield can damage the wipers and the wiper motor.
- Remove snow and ice from the wipers before you begin driving.
- If the wiper blades freeze to the windshield, loosen them carefully. Volkswagen recommends using a deicing spray.

NOTE

Never switch on the windshield wipers when the windshield is dry because the windshield can be scratched.



On some vehicles, the windshield wipers work only if the ignition is switched on and the engine hood is closed. The windshield wipers turn off automatically when the engine hood is opened. The rear window wiper turns off when the trunk lid is opened.



The intermittent wiping for the front windshield depends on the driving speed. The higher the speed, the faster the wipers move.



If the wiper blades freeze to the windshield, loosen them carefully. Volkswagen recommends using a deicing spray.

Windshield wiper functions



Read and follow the introductory information and safety information first ⇒ [Introduction to the subject](#)

Wiper performance in different situations:

When the vehicle is not moving:

The wiper speed changes temporarily to the next lower speed.



During automatic wipe/wash:	While the washer system is working, the Climatronic (if equipped) switches to recirculation for about 30 seconds to help prevent the washer fluid odor from entering the vehicle interior.
During intermittent wiping:	Speed-dependent interval control: The higher the vehicle speed, the faster the wipers move.

Heated washer nozzles (if equipped)

Some vehicles are equipped with heated washer nozzles. The heating thaws frozen washer nozzles, but not the fluid supply hoses. When the ignition is switched on, the heat applied to the washer nozzles is automatically regulated depending on the outside air temperature.

Headlight washer system (if equipped)

The headlight washer system cleans the headlight glass.

If the ignition and the headlights (high or low beams) are switched on, the headlights are cleaned the first time and every fifth time the front windshield washers are activated. This happens only when the low or high beams are on when the windshield wiper lever is pulled towards the steering wheel. However, the headlights must still be washed by hand periodically to get rid of hard-to-remove dirt (for example, insect splatter).

To help make sure that the headlight washer system works during winter weather, always keep the headlight washer nozzles free of snow and remove any ice with a deicer spray before driving. Use a deicer spray to remove any ice.



If there is something on the windshield, the wiper will try to wipe it away. If it continues to block the wiper, the wiper will stop moving. Remove the obstacle and switch the wiper on again.

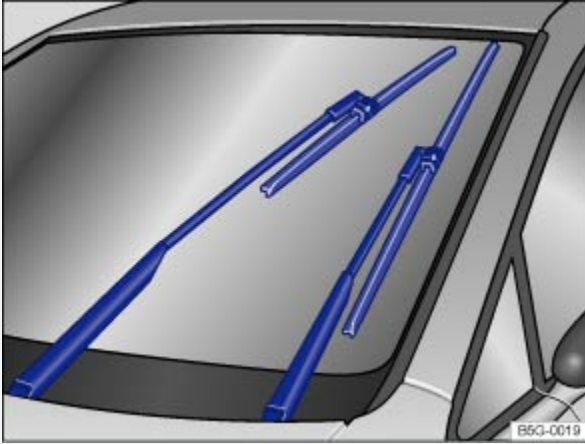


Fig. 92 Windshield wiper in service position.



Read and follow the introductory information and safety information first ⇒ *Introduction to the subject*

In the service position, the wiper arms can be lifted away from the windshield ⇒ *Fig. 92*. The wipers are moved to the service position as follows:

- The engine hood must be closed ⇒ *Working in the engine compartment*.
- Switch the ignition off, turn it on briefly, and then off again.
- Press the windshield wiper lever down briefly ⇒ *Fig. 90* when the ignition is off.
- Wipers move into service position.

Lifting the wiper blades and tilting them away from the windshield

- Put the wiper arms in service position ⇒ .
- Do not handle the wiper blades, handle the wiper arms only at the attachment above the wiper blades.

Carefully fold the wiper arms back onto the windshield before driving! Switch the ignition on and press the windshield wiper lever down briefly ⇒ *Fig. 90*. The wiper arms move back to their original position.

NOTE

away from the windshield only when they are in the service position.

- Always carefully fold the windshield wiper arms down against the windshield before driving the vehicle.



The windshield wiper arms can be moved to the service position only when the vehicle is not moving.

Rain sensor

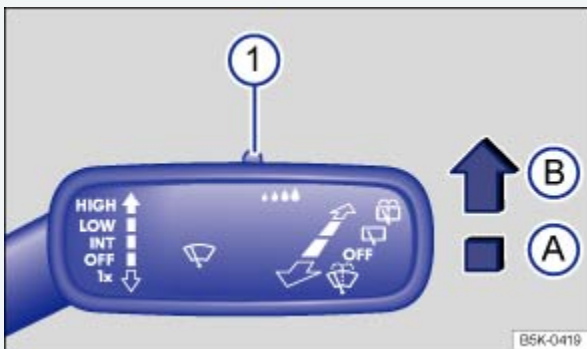


Fig. 93 Windshield wiper lever: Adjusting the rain sensor ① (if equipped).

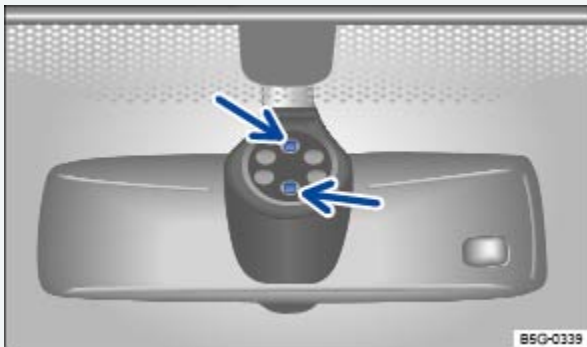


Fig. 94 Inside the front windshield above the inside mirror: Sensitive rain sensor surface.



Read and follow the introductory information and safety information first ⇒ [Introduction to the subject](#)

When switched on, the rain sensor automatically shortens or lengthens the time between wiping intervals depending on how hard it is raining ⇒ . The rain sensor's sensitivity can be adjusted manually ⇒ [Fig. 93](#) ① .

On appropriately equipped vehicles, the automatic wipe function of the rain sensor can be turned on



wipers function keys → [Menu and system settings](#).

Push the lever into the desired position ⇒ [Fig. 93](#) :

- Ⓐ Rain sensor off (windshield wiper lever home position).
 - Ⓑ Rain sensor active – automatic wiping as needed.
 - ① Adjust the sensitivity of the rain sensor:
 - Move switch to the right – high sensitivity.
-
- Move switch to the left – low sensitivity.

After switching the ignition off and back on again, the rain sensor stays on and works again when the wiper lever is in position Ⓑ.

Possible reasons for changes in the way the rain sensor works

The rain sensor may misread what is happening in the *detection zone of its sensitive rain-sensor surface* ⇒ [Fig. 94](#) (arrows) and not work for a number of reasons, which may include:

- Worn out wiper blades: Worn out wiper blades may leave a film of water or wiping streaks; this can cause the wipers to run longer, to wipe more often, or to wipe continuously at high speed.
- Insects: Insects hitting the windshield may trigger the wipers.
- Salt streaks: Salt streaks on the windshield from winter driving can cause wiping more often or continuously on glass that is almost dry.
- Dirt: Caked-on dust, wax, any other buildup on the windshield (lotus effect), or car-wash detergent residue can lower the rain sensor's sensitivity and cause it to react too slowly or not at all.
- Crack or chip in the windshield: If a stone hits and chips the windshield while the rain sensor is on, this will trigger a wiper cycle. After that, the rain sensor will recognize the change and recalibrate itself to respond to the sensitive surface's reduced detection zone. Depending on the size of the chip, the sensor's reaction pattern may or may not change.

WARNING

The rain sensor cannot always recognize rain and activate the wipers.

- Switch the wipers on manually when water on the windshield reduces visibility.

clean the rain sensor's sensitive surface → Fig. 74 (arrows) regularly and check the wiper blades for wear or damage.



To remove wax and coats of polish safely, we recommend using an alcohol-based windshield cleaner.

Checking and refilling windshield washer fluid



Fig. 95 In the engine compartment: Cap of the windshield washer fluid reservoir.



Read and follow the introductory information and safety information first ⇒ *Introduction to the subject*

Check the windshield washer fluid level regularly and refill as necessary.

There is a filter screen in the filler neck of the windshield washer fluid reservoir. The screen helps to keep large particles and debris from getting into and clogging the windshield washer nozzles when adding windshield washer fluid. Take the screen out only to clean it. If the screen is damaged or missing, have it replaced immediately, otherwise the system may become clogged and not work properly.

- Open the engine hood ⇒ *Working in the engine compartment*.
- The windshield washer fluid reservoir can be identified by the symbol on its cap ⇒ Fig. 95.
- Check if there is still enough windshield washer fluid in the reservoir.
- Refill with clear water (not distilled water) and an appropriate windshield washer fluid that is recommended by Volkswagen ⇒ . Follow the directions on the container.



water from freezing ⇒ ⚠ .

Recommended cleaners

- For the warmer months, Windscreen Clear Summer- G 052 184 A1 - or equivalent. Mixing ratio 1:100 (1 part concentrate to 100 parts water) in the windshield washer reservoir.
- All-season Windscreen Clear- G 052 164 A2 - or equivalent. Mixing ratio in winter to 0 °F (-18 °C) about 1:2 (1 part concentrate to 2 parts water), otherwise, mixing ratio 1:4 in the windshield washer reservoir.

Filling capacity

Depending on vehicle equipment, the windshield washer fluid reservoir holds between 3.1–5.2 quarts (3–5 liters).

WARNING

Never mix antifreeze or similar additives into the windshield washer reservoir. This could produce an oily film on the windshield, which would considerably reduce visibility.

- Use clear water (not distilled water) with a cleaning solution recommended by Volkswagen.
- If necessary, blend with a suitable windshield washer fluid antifreeze agent.

NOTE

- Never mix cleaning solutions recommended by Volkswagen with other cleaning agents. If you do, this could cause sediments or other by-products that can clog the windshield washer nozzles.
- When refilling, do not confuse one type of operating liquid with another! Otherwise serious malfunctions and engine damage can occur!

Mirrors




Introduction to the subject

In this chapter you will find information on the following subjects:



⇒ *Outside mirrors*

For your driving safety, it is important that you properly adjust the outside mirrors and the inside mirror before you start driving ⇒  .

The outside mirrors and the inside mirror help you see and adapt your driving to traffic behind you. Remember that the inside and outside rearview mirrors will not show everything behind you. There can be blind spots. Blind spots can be significantly larger if the mirrors are not properly adjusted.

WARNING

Adjusting mirrors when the vehicle is moving can cause driver distraction, accidents, and serious personal injury.

- Always adjust the rearview mirrors when the vehicle is not moving.
- Always be aware of what is happening around the vehicle when changing lanes, passing, turning, or parking. Another vehicle, pedestrian, or object could be in your blind spot.
- Always make sure mirrors are properly adjusted and the view to the rear is not reduced by moisture, ice, snow, or other things.

WARNING

Self-dimming rearview mirrors contain an electrolyte fluid which can leak if the mirror glass is broken. Electrolyte fluid can irritate the skin, eyes, and respiratory system.

- Repeated or prolonged exposure to electrolyte fluid can irritate the respiratory system, especially among people with asthma or other respiratory conditions. Get fresh air immediately by leaving the vehicle or, if that is not possible, open windows and doors all the way.
- If electrolyte fluid gets into the eyes, flush them thoroughly with large amounts of clean water for at least 15 minutes; medical attention is recommended.
- If electrolyte fluid contacts skin, flush affected area with clean water for at least 15 minutes and then wash affected area with soap and water; medical attention is recommended. Thoroughly wash affected clothing and shoes before reuse.
- If swallowed, and the person is conscious, rinse mouth with water for at least 15 minutes. Get

NOTE

Broken glass in the self-dimming rearview mirrors can cause electrolyte fluid leakage. Liquid electrolyte leaked from a broken mirror glass will damage any plastic surfaces it comes in contact with. Clean up spilled electrolyte fluid immediately with clear water and a sponge.

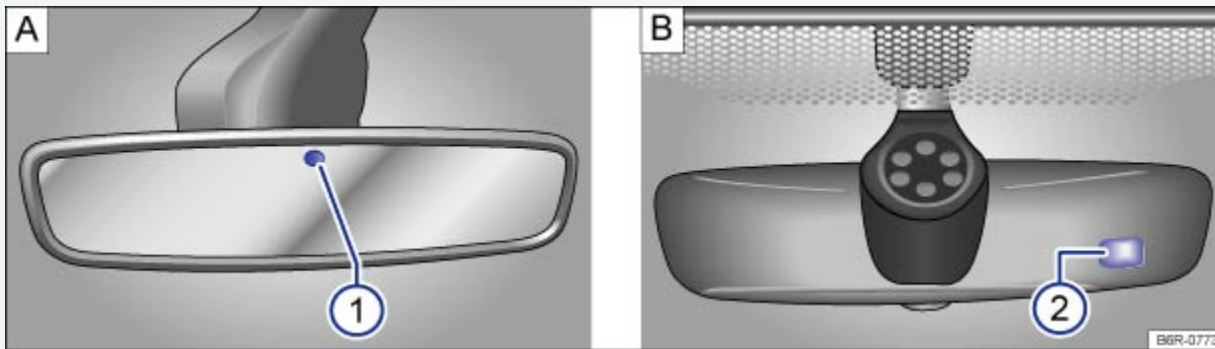
Inside mirror

Fig. 96 Self-dimming rearview mirror (if equipped).

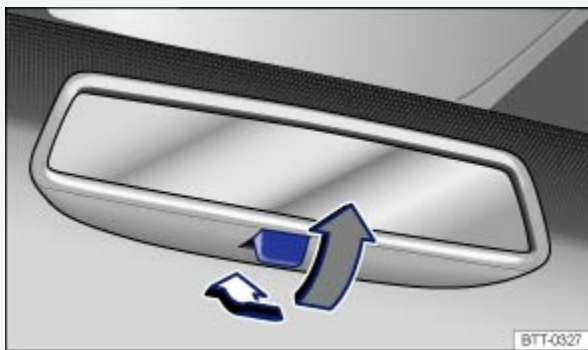


Fig. 97 Manually adjustable inside mirror.

Read and follow the introductory information and safety information first ⇒ [Introduction to the subject](#)

Adjust the inside mirror to make sure that there is good visibility through the rear window.

For example, visibility through the rear window could be impaired if there is a sunshade on the rear window or clothing on the luggage compartment cover, or if the rear window is covered with ice, snow, or dirt.



- Home position: Lever on the bottom edge of the mirror points forward.
- To adjust to non-glare visibility, move the lever so that it points down ⇒ [Fig. 97](#).


Self-dimming rearview mirror (if equipped)

There are two sensors in the interior mirror housing:

- One sensor on the side facing the interior to measure light from *the rear* of the vehicle ⇒ [Fig. 96①](#).
- One sensor on the side facing the windshield to measure light from *the front* of the vehicle ⇒ [Fig. 96②](#).

If the ignition is switched on, the mirror *automatically* darkens depending on the amount of light shining into the vehicle from the rear.

The self-dimming feature is deactivated when you shift the transmission into reverse or switch on the interior lights or the reading light.

Do not attach external navigation devices to the windshield or in the vicinity of the self-dimming inside mirror ⇒ .

WARNING

The illuminated display on an external navigation device can cause the self-dimming inside mirror to malfunction, which can result in crashes and serious injuries.

- Malfunctions in the self-dimming function can result in the inside mirror being unable to evaluate the exact distance of vehicles in the rear or other objects.



If the light striking the sensor is filtered or blocked (such as by a sunshade), the self-dimming inside mirror will not work properly or may not work at all.

Outside mirrors



Fig. 98 In the driver door: Adjusting knob for the outside mirrors.



Read and follow the introductory information and safety information first ⇒ [Introduction to the subject](#)

When the ignition is switched on, turn the knob in the driver door ⇒ [Fig. 98](#) to adjust the outside mirrors.


Turn the knob to the desired position:	
	Switch on outside mirror heating. Heats only at outside air temperatures below +68 °F (+20 °C).
L	Adjust the left outside mirror by pressing the knob to left/right and up/down.
R	Adjust the right outside mirror by pressing the knob to left/right and up/down.
0	Neutral position. No heating or adjustment possible.

Synchronous mirror adjustment (if equipped)

- To turn on the synchronous mirror adjustment feature in the Infotainment system, press the **CAR** button followed by the and Mirrors and wipers function keys ⇒ [Menu and system settings](#).
- Turn the outside mirror adjusting knob to the L position.
- Adjust the left outside mirror. The right (passenger) outside mirror will automatically adjust at the same time.



Passenger side mirror lowering in reverse gear (if equipped)

- Select a valid remote control vehicle key on which the settings should be saved.
- Unlock the vehicle using this key.
- Set the parking brake.
- Switch on the ignition.
- To turn the passenger side mirror lowering feature on in the Infotainment system, press the **CAR** button followed by the  and Mirrors and wipers function keys ⇒ *Menu and system settings*.
- Shift the transmission to Reverse (R).
- Adjust the passenger outside mirror for a clear view of the curb, for example.
- The adjusted mirror position is automatically stored and assigned to the vehicle key used to unlock the vehicle.

Recalling the passenger side mirror settings

- Turn the adjusting knob for the outside mirrors to the R position.
- Shift the transmission into Reverse (R) with the ignition switched on.
- The passenger mirror moves back to the regular position when the vehicle moves forward faster than about 10 mph (15 km/h) or the adjusting knob is moved from R to another position.

WARNING

Improper use of the folding outside mirrors can cause personal injury.

- Always make sure that nobody is in the way when folding the mirrors in or out.
- Make sure that you do not get your finger caught between the mirror and the mirror base when moving the mirrors.

WARNING

Incorrectly estimating distances with the right outside mirror can cause collisions and serious injury.

- The right outside mirror has a convex (curved) surface. This widens your field of vision. But ve-



any are.

- If you use the right outside mirror to judge distances from vehicles behind you when changing lanes, you could estimate incorrectly and cause a crash and serious injuries.
- Whenever possible, use the inside mirror to more accurately judge distance and size of vehicles or other objects seen in the convex mirror.
- Always make sure you have a clear view to the rear of the vehicle.

NOTE

Always fold in the outside mirrors when taking the vehicle through an automatic car wash.



To reduce fuel consumption, use outside mirror heating only when needed.



When first switched on, outside mirror heating works with maximum heat for about 2 minutes.



If power mirror adjustment does not work, the outside mirrors can be adjusted by hand by pressing on the edges of the mirror surface.

Transporting

Driving tips



Introduction to the subject

In this chapter you will find information on the following subjects:

⇒ *Stowing luggage*

⇒ *Driving with an open trunk lid*

⇒ *Driving a loaded vehicle*

⇒ *Weights and axle weights*



are securely latched. Always use the tie-downs in the luggage compartment and secure the objects with suitable straps. Never overload the vehicle. Remember that the vehicle load, as well as how it is distributed, can affect vehicle handling and braking ⇒ ⚠ .

WARNING

Unsecured or incorrectly stowed items can fly through the vehicle, causing serious personal injury during hard braking or sharp steering or in an accident. Loose items can also be struck and thrown through the passenger compartment by the front airbags if they inflate. To help reduce the risk of serious personal injury:

- Always stow all objects securely in the vehicle.
- Always keep storage compartments closed while driving.
- Do not stow hard, heavy, or sharp objects in open bins in the vehicle or on top of the instrument panel.
- Remove hard, heavy, and sharp objects from clothing and bags in the vehicle interior and stow securely. Always put heavy items in the luggage compartment.
- Always secure objects in the passenger compartment properly with suitable straps so that they cannot move into the deployment area of a side or front airbag during braking, in a sudden maneuver, or in a collision.
- Always make sure that there is nothing on the front passenger seat when the backrest is folded forward.
- Passengers must never ride in an incorrect seating position because objects are being transported in the vehicle.
- Never let anybody sit in a seat that is blocked by objects being carried in the vehicle.

WARNING

Heavy loads will influence the way your vehicle handles and increase stopping distances. Heavy loads that are not properly stowed or secured can cause loss of control and serious injury.

- Secure the load properly to keep it from shifting.
- Always remember when transporting heavy objects that a change in the center of gravity also changes the way your vehicle handles:



- Secure heavy objects properly as far forward in the luggage compartment as possible.
- Always tie down heavy items securely with suitable straps using the tie-downs in the luggage compartment.
- Securely latch the rear seat backrest in the upright position.
- Never exceed the Gross Axle Weight Rating or the Gross Vehicle Weight Rating on the safety compliance sticker on the left door jamb. Exceeding permissible weight can cause the vehicle to skid and handle differently.
- Always adapt your speed and driving to the heavier load and the weight distribution in the vehicle. Take road, weather, traffic, and visibility conditions into account as well.
- Always accelerate gently and avoid sudden braking and driving maneuvers.
- Always brake earlier than you would if you were not driving a loaded vehicle.

Stowing luggage



Read and follow the introductory information and safety information first ⇒ [Introduction to the subject](#)

Always stow all luggage securely in the vehicle

- Distribute the load in the vehicle and, if applicable, on the roof and in the trailer as evenly as possible.
- Put heavy objects as far forward as possible in the luggage compartment and securely latch the rear seat backrest in the upright position.
- Secure luggage in the luggage compartment using suitable straps and the tie downs ⇒ [Tie-downs](#). Also see ⇒ [Luggage compartment](#).
- Adjust the headlight range, if necessary ⇒ [Lights](#).
- Check the pressure in all 4 tires when the tires are still cold. Never reduce air pressure in warm tires to match cold tire inflation pressure. Heed the information on the tire pressure label ⇒ [Tires and wheels](#).
- Pay especially close attention to your vehicle's Tire Pressure Monitoring System when driving with



NOTE

Wires in the rear windows such as for heating or for an antenna can be damaged by objects that rub against them.



If applicable, please review the information on loading a trailer ⇒ [Trailer towing](#) and a roof rack ⇒ [Roof rack](#).

Driving with an open trunk lid



Read and follow the introductory information and safety information first ⇒ [Introduction to the subject](#)

Driving with an open trunk lid can lead to serious personal injury. If you have to drive with an open trunk lid, make sure that all objects and the lid itself are properly secured and take appropriate measures to keep toxic exhaust fumes from entering the vehicle.

WARNING

Driving with an unlatched or open trunk lid can lead to serious personal injury.

- Never transport objects larger than those that fit completely in the luggage compartment, because the trunk lid cannot be fully closed properly.
- After closing the lid, always pull up on it to make sure that it is properly closed and cannot open suddenly when the vehicle is moving.
- Always stow all objects securely in the luggage compartment. Loose objects can fall out of the luggage compartment and injure others on the road behind you.
- Drive carefully; anticipate what other drivers will do.
- Avoid abrupt or sudden acceleration, steering, or braking, because the unlatched trunk lid can move suddenly.
- Always mark objects sticking out from the luggage compartment clearly for others to see. Obey all applicable legal requirements.



- Always remove any luggage rack or other rack mounted on the trunk lid (along with any luggage on the rack) before driving with an open trunk lid.

WARNING

Driving with an open trunk lid can cause poisonous carbon monoxide in the engine exhaust to get into the passenger compartment.


- Carbon monoxide causes drowsiness, inattentiveness, poisoning, and loss of consciousness. It can lead to accidents and severe personal injuries.
- Always keep the trunk lid closed while driving to help keep poisonous exhaust fumes from being drawn into the vehicle.
- Never transport objects that are too large to fit completely into the luggage area, because then the trunk lid cannot be fully closed.
- If you absolutely must drive with an open trunk lid, do the following to reduce the risk of carbon monoxide poisoning:
 - Close all windows and the power sunroof.
 - Switch off the climate control system's air recirculation feature.
 - Open all air vents in the instrument panel.
 - Set the fresh air fan to the highest speed.

NOTE

The open trunk lid changes the vehicle length and height.

Driving a loaded vehicle



Read and follow the introductory information and safety information first ⇒  [Introduction to the subject](#)

For good handling when driving a loaded vehicle, please observe the following:



- Drive especially carefully and accelerate gently.
- Avoid sudden braking and driving maneuvers.
- Brake earlier than you would if you were not driving a loaded vehicle.
- If applicable, observe information about driving with a trailer ⇒ [Trailer towing](#).
- If applicable, observe information about driving with a roof rack ⇒ [Roof rack](#).

WARNING

Heavy loads can change the way your vehicle handles and increase stopping distances. Heavy loads that are not properly stowed or secured can shift suddenly, causing loss of control and serious injury.

- Secure the load properly to keep it from shifting.
- Always remember when transporting heavy objects that they change the vehicle's center of gravity and also the way it handles.
 - Always distribute the load as evenly as possible.
 - Secure heavy objects as far forward in the luggage compartment as possible.
 - Secure luggage in the luggage compartment using suitable straps and the tie downs ⇒ [Tie-downs](#). Also see ⇒ [Luggage compartment](#).
- Always tie down heavy items securely with suitable straps.
- Securely latch the rear seat backrest in the upright position.
- Never exceed the Gross Axle Weight Rating or the Gross Vehicle Weight Rating on the safety compliance sticker on the left door jamb. Exceeding permissible weight can cause the vehicle to skid and handle differently.
- Always adapt speed and driving to the heavier load and the weight distribution in the vehicle. Take road, weather, traffic, and visibility conditions into account as well.
- Always accelerate gently and avoid sudden braking and driving maneuvers.
- Always brake earlier than you would if you were not driving a loaded vehicle.



Read and follow the introductory information and safety information first ⇒ [Introduction to the subject](#)

The actual gross weight of any vehicle depends on the engine, basic equipment, any factory-installed optional equipment for the given model, and any accessories that have been installed. The Gross Vehicle Weight Rating (GVWR) and the Gross front and Rear Axle Weight Ratings (GAWR) for a given vehicle are printed on the vehicle's Safety Compliance Certification Label on the driver door jamb.

The Gross Vehicle Weight Rating includes the weight of the vehicle itself with all of its factory-installed equipment, plus a full tank of gasoline, the engine oil and coolant, all vehicle occupants (150 lbs/68 kg per seating position) and cargo.

The Gross Axle Weight Ratings specify the maximum allowable load for each axle.

The cargo payload may not be increased by using a roof rack without commensurately reducing the weight from vehicle occupants ⇒ .

Vehicle payload consists of the combined weight of the following:

- Passengers.
- Total luggage and other cargo.
- Roof load, including the roof rack system if permitted ⇒ [Roof rack](#) .
- Factory-installed or retrofitted accessories.
- Hitch weight and tongue weight for trailer towing ⇒ [Loading the trailer](#) .

Please refer to the Gross Vehicle Weight Rating (GVWR) and the Gross front and rear Axle Weight Ratings (GAWR) for your vehicle, which are printed on the vehicle's Safety Compliance Certification Label on the driver door jamb ⇒ [Important vehicle labels](#) .

WARNING

Exceeding maximum permissible weight ratings can result in vehicle damage, accidents, and serious personal injury.

- Never let the actual weights at the front and rear axles exceed the permissible Gross Axle Weight Rating. Also, never let the total of these actual weights exceed the Gross Vehicle



- Always remember that the vehicle's handling and braking will be affected by extra load and the distribution of this load. Adjust your speed accordingly.

NOTE

- Always distribute the load evenly and as low as possible in the vehicle. The vehicle capacity weight figures apply when the load is distributed evenly in the vehicle (passengers and luggage).
- When transporting a heavy load in the luggage compartment, carry the load as close to the rear axle (as far forward) as possible so that the vehicle's handling and braking are affected as little as possible.

Luggage compartment

Introduction to the subject

In this chapter you will find information on the following subjects:

⇒ *Folding the rear seat backrest forward and back into place*


⇒ *Luggage compartment cover*

⇒ *Luggage compartment pass-through*

⇒ *Tie-downs*

⇒ *Shopping bag hooks*

⇒ *Variable luggage compartment floor*

Always stow heavy objects in the luggage compartment and make sure that the rear seat backrests are securely latched in their upright position. Always secure objects to the tie-downs with suitable straps. Never overload the vehicle. Remember that the vehicle load, as well as how it is distributed, can affect vehicle handling and braking ⇒ .

WARNING



- Close and lock the trunk lid and all doors when the vehicle is not in use. First, make certain that no one is left inside.
- Never leave your vehicle unattended or let children play around the vehicle, especially with the trunk lid left open. A child could crawl into the vehicle and pull the trunk lid shut, becoming trapped and unable to get out. This could cause severe or fatal injuries.
- A closed vehicle can become very hot or very cold, depending on the season. Temperatures can quickly reach levels that can cause unconsciousness or death, particularly to small children.
- Never let children play in or around the vehicle.
- Never let anyone ride in the luggage compartment.

WARNING

Unsecured or incorrectly stowed items can fly through the vehicle, causing serious personal injury during hard braking or sharp steering or in an accident. Loose items can also be struck and thrown through the passenger compartment by the front airbags if they inflate. To help reduce the risk of serious personal injury:

- Always stow all objects securely in the vehicle. Always put luggage and heavy items in the luggage compartment.
- Always secure objects in the passenger compartment properly with suitable straps so that they cannot move into the deployment zone of a side or front airbag during sudden braking, in a sudden maneuver, or in a collision.
- Always keep storage compartments closed while driving.
- Never stow hard, heavy, or sharp objects in the vehicle's open storage compartments, on the luggage compartment cover, or on the top of the instrument panel.
- Always remove hard, heavy, or sharp objects from clothing and bags in the vehicle interior and stow them securely in the luggage compartment.

WARNING

Transporting heavy objects causes the handling characteristics of the vehicle to change and increases braking distances. Heavy loads which are not properly stowed or secured in the vehicle can lead to a loss of vehicle control and cause serious personal injury.



ing the vehicle's center of gravity.

- Always distribute luggage evenly and as low as possible within the vehicle. The vehicle capacity weight figures apply when the load is distributed evenly in the vehicle (passengers and luggage).
- Always stow luggage and heavy items in the luggage compartment as far forward of the rear axle as possible and secure them with appropriate straps to the tie-downs provided.
- Never exceed the vehicle's Gross Vehicle Weight Rating or Gross Axle Weight Ratings, which are printed on the Safety Compliance Certification Label located on the door jamb of the driver door. Exceeding the permissible weight can cause the vehicle to skid and behave differently.
- Always adapt your speed and driving style to accommodate your payload and its weight distribution within your vehicle.
- Be especially cautious and gentle when stepping on the accelerator pedal and avoid sudden braking and other maneuvers.
- Brake earlier than you would if you were not driving a loaded vehicle.

NOTE

The defroster heating wires or antenna in the rear window can be damaged by objects that rub against them.



The ventilation slots in the luggage compartment must not be blocked so that stale air can escape from the vehicle.

Folding the rear seat backrest forward and back into place

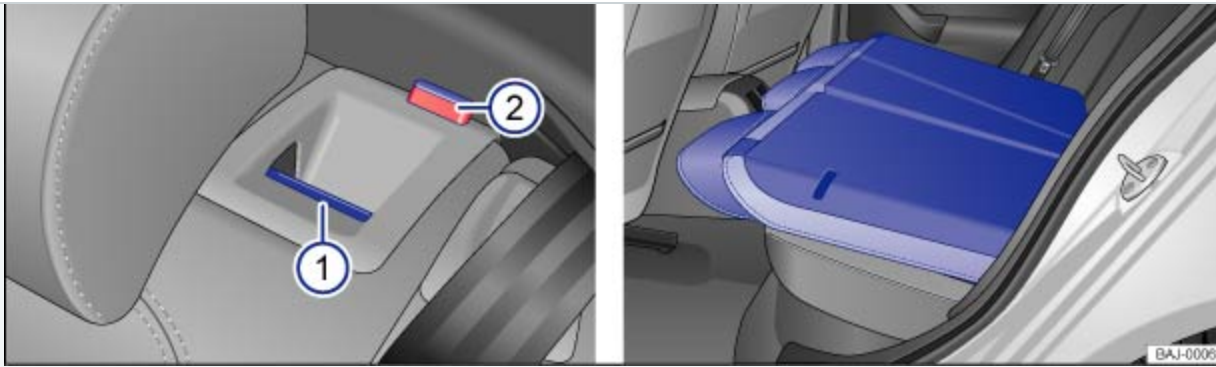


Fig. 99 : Rear seat bench: Release button ① and red mark on the indicator ②. : Seat backrest folded forward.



Read and follow the introductory information and safety information first ⇒ *Introduction to the subject*

The rear seat backrest is divided into 2 sections. Each section of the rear seat backrest can be folded down individually to increase luggage space.

Folding the rear seat backrest forward

- Push the head restraint all the way down ⇒ *Adjusting the seating position*.
- Pull the release button ⇒ *Fig. 99①* forward while folding the rear seat backrest forward.
- The rear seat backrest is unlocked if the red mark ⇒ *Fig. 99②* can be seen on the indicator.
- The rear seat backrest is released and can be folded forward.

If the rear seat backrest is folded down, no one, including children, may ride on the rear seat.

Folding the rear seat backrest back into place

- Fold the rear seat backrest back until it engages securely ⇒ .
- The red mark on the indicator ⇒ *Fig. 99②* should no longer be visible.
- The rear seat backrest must be securely latched into place for the safety belts on the rear seats to provide optimal protection.

WARNING

jury.

- Always make sure there are no people or animals in the area around the rear seat backrest when folding it forward.
- Never fold the rear seat backrest forward or back while the vehicle is moving.
- When folding the rear seat backrest back up, make sure that the safety belt does not get caught or damaged.
- Keep hands, fingers, feet and other body parts out of the way when folding the rear seat backrest forward or back.
- Each rear seat backrest must be securely latched in the upright position so that the safety belts on the rear seats can provide protection. This is particularly the case for the middle seat on the rear seat bench.
- If a seat is used with an unsecured backrest, the passenger will move forward together with the rear seat backrest during sudden braking, driving maneuvers, or in a collision.
- If the red mark on the indicator \Rightarrow *Fig. 99* is visible, this indicates that the backrest is not latched into place. Always check to make sure that the red mark is not visible whenever the rear seat backrest is in the upright position.
- No one, including children, may ride on the rear seats if the rear seat backrest is folded down or not correctly latched.

NOTE

Before folding the rear seat backrest forward, adjust the front seats so that the rear seat's head restraint or backrest cushion will not touch the front seats.

Luggage compartment cover



Fig. 100 In the luggage compartment: Installing and removing the luggage compartment cover.



Read and follow the introductory information and safety information first ⇒ [Introduction to the subject](#)

When you open or close the trunk lid, the supporting cords, when attached, will automatically raise or lower the luggage compartment cover.

You can put light articles of clothing on the luggage compartment cover. But remember that your view through the rear window must not be obstructed.

Removing the luggage compartment cover

- Unhook the supporting cords from each side of the trunk lid ⇒ [Fig. 100](#) (top arrows).
- Push the luggage compartment cover upward from below ⇒ [Fig. 100](#) (bottom arrows) until it releases from the side brackets.
- If necessary, stow the luggage compartment cover under the variable luggage compartment floor ⇒ [Variable luggage compartment floor](#).

Installing the luggage compartment cover

- Press the luggage compartment cover into the side brackets from above ⇒ [Fig. 100](#) (bottom arrows).
- Hook the supporting cords onto the trunk lid ⇒ [Fig. 100](#) (top arrows).

WARNING

In a sudden braking or other maneuver, or in a collision, unsecured or improperly secured objects or animals on the luggage compartment cover can cause serious personal injury.

- Never let animals ride on the luggage compartment cover.

WARNING

Clothes or other items on the luggage compartment cover behind the rear seat backrest may limit visibility and cause accidents and severe personal injuries.

- Always hang clothes so that they do not limit visibility.

NOTE

To help prevent damage to the luggage compartment cover, the luggage compartment may only be loaded to a height at which the luggage compartment cover will not press on the cargo when the trunk lid is closed.

NOTE

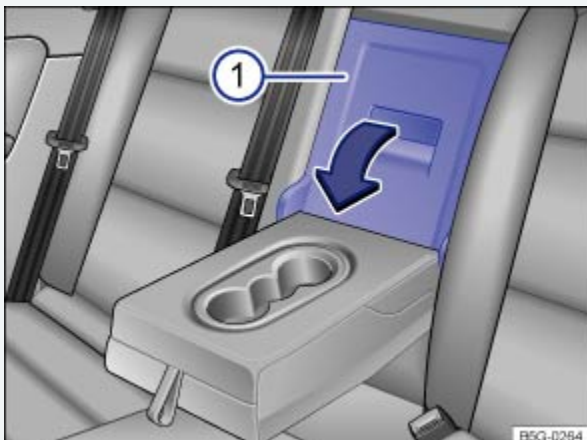
Things on the luggage compartment cover can damage it.

- The defroster heating wires or antenna in the rear window can be damaged by objects that rub against them.



The ventilation slots in the luggage compartment must not be blocked so that stale air can escape from the vehicle.

Luggage compartment pass-through



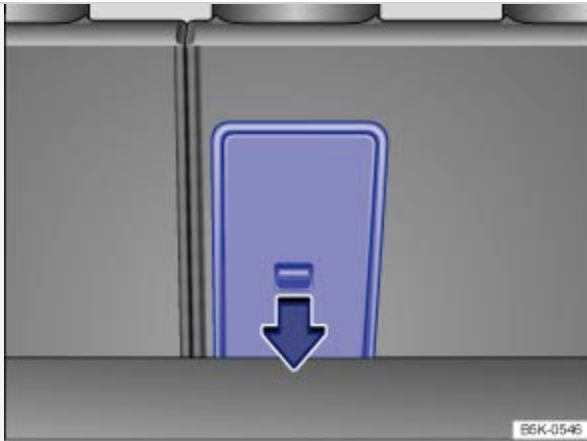


Fig. 102 In the luggage compartment: Opening the pass-through.



Read and follow the introductory information and safety information first ⇒ [Introduction to the subject](#)

There may be a pass-through for transporting things like skis in the rear seat backrest behind the center armrest.

To help prevent soiling the vehicle interior, cover dirty items before sliding them into the pass-through.

If the center armrest is folded down, no one can sit on the middle seat of the rear bench.

Opening the pass-through

- Fold down the rear center armrest ⇒ [Adjusting the seating position](#).
- Pull the release lever in the direction of the arrow ⇒ [Fig. 101](#) and fold the pass-through cover all the way forward.
- Open the trunk lid.
- Slide long objects from the luggage compartment through the pass-through.
- Secure objects with the safety belt.
- Close the trunk lid.

Closing the pass-through

- Pull the release lever on the pass-through cover in the direction of the arrow ⇒ [Fig. 101](#).

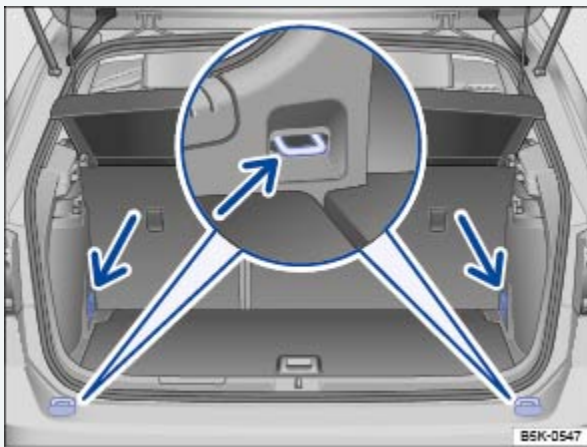
ment side should not be visible.

- Close the trunk lid.
- If necessary, fold the center armrest up.



The pass-through can also be opened from the luggage compartment. Press the release lever ⇒ [Fig. 102](#) in the direction of the arrow and push the cover forward.

Tie-downs



[Fig. 103](#) In the luggage compartment: Tie-downs.



Read and follow the introductory information and safety information first ⇒ [Introduction to the subject](#)

There are tie-downs in the front and rear of the luggage compartment, which you can use to secure luggage or other items ⇒ [Fig. 103](#) (arrows).

Some tie-downs may have to be folded open for use.

Elastic straps can snap back toward you if they are not properly attached ⇒ .

If you use elastic straps to secure items in the luggage compartment, be sure to securely attach them to the tie-downs just behind the rear seat backrest first and then to the tie-downs at the loading edge of the luggage compartment.

Remove the hooks from the tie-downs in the reverse order described above, first from the tie-downs



come loose suddenly, they will move away from you.

WARNING

Unsuitable, worn, or damaged tie-down straps (elastic or non-elastic) can snap or come loose during braking or other maneuvers or in a collision. Objects secured with these straps can then come loose and fly through the passenger compartment, causing severe personal injuries or death.

- To help prevent baggage or other items from coming loose and flying around, always use suitable undamaged tie-down straps.
- Securely fasten the tie-down straps to the tie-downs.
- Loose or improperly secured objects in the luggage compartment can slide about suddenly and change the vehicle's handling.
- Secure even small and light objects. Loose objects in the luggage or passenger compartment can fly about during sudden braking maneuvers or in the event of an accident and injure occupants.
- Never exceed the maximum allowable load on the tie-downs when securing objects.
- Never secure a child restraint to the tie-downs.

WARNING

Elastic straps have to be stretched when being attached to the tie-downs in the luggage compartment. Hooks on these straps can cause serious personal injury if not handled properly and attached securely.

- Always protect eyes and face from injury from the hooks when attaching them to the tie-downs in the luggage compartment.
- Always hold the hooks on elastic straps firmly when attaching to the vehicle and do not let them snap back and hit you.
- First attach the hooks on the straps to the tie-downs at the rear seat backrest in the luggage compartment and then to the tie-downs near the loading edge of the luggage compartment. This way, if one of the hooks on the elastic straps snaps back, it will move away from you, decreasing the risk of personal injury.

The maximum load for the tie-downs is about 500 lbs. (227 kg).



For suitable straps and luggage storage systems, please see an authorized Volkswagen dealer or authorized Volkswagen Service Facility.

Shopping bag hooks

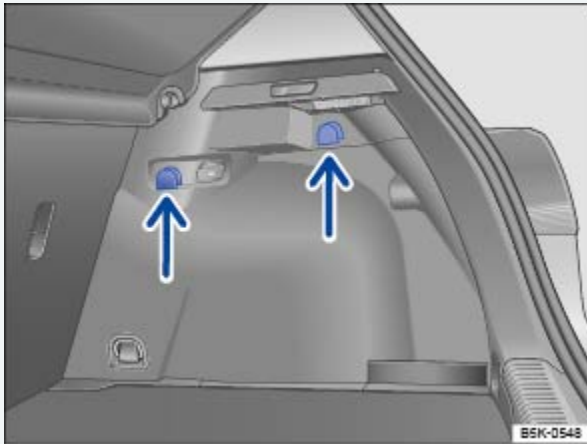


Fig. 104 In the luggage compartment: Shopping bag hooks.



Read and follow the introductory information and safety information first ⇒ [Introduction to the subject](#)

Shopping bag hooks may be located in the upper left and right areas of the luggage compartment ⇒ [Fig. 104](#) (arrows).

WARNING

Never use the shopping bag hooks as tie-downs. The hooks could break off during sudden braking maneuvers or in a collision.

NOTE

The maximum load for each shopping bag hook is 5 lbs. (2.5 kg).

Variable luggage compartment floor

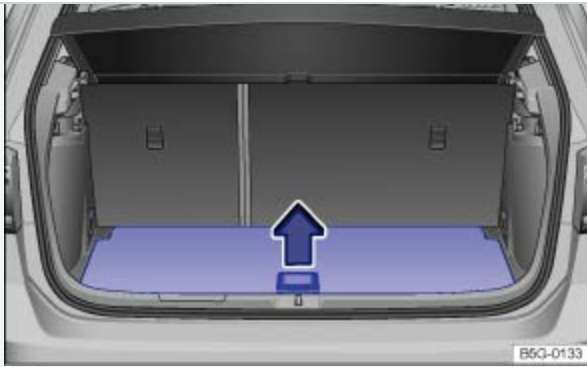


Fig. 105 In the luggage compartment: Opening the variable luggage compartment floor.

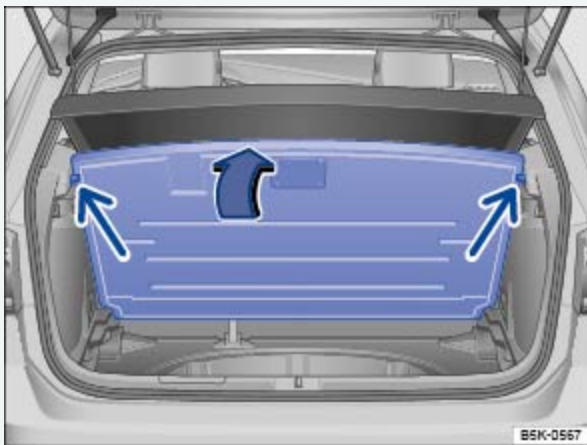


Fig. 106 In the luggage compartment: Variable luggage compartment floor folded up.



Read and follow the introductory information and safety information first ⇒ *Introduction to the subject*

Some models are equipped with a variable luggage compartment floor, which is height-adjustable.

Opening and closing the luggage compartment floor

- To *open* the luggage compartment floor, lift the recessed handle ⇒ [Fig. 105](#) and guide the floor upward until it is held in position by the stops on either side of the luggage compartment ⇒ [Fig. 106](#) (arrows).
- To *close*, guide the luggage compartment floor past the stops and downward into position. If necessary, gently pressing the stops can help the floor pass through ⇒ .

Adjusting the height of the luggage compartment floor

- Grasp the recessed handle ⇒ [Fig. 105](#), lift the luggage compartment floor, and pull it rearward out of the guides on the sides of the luggage compartment.



as far as it will go.

Removing the luggage compartment floor

- Grasp the recessed handle ⇒ *Fig. 105*, lift the luggage compartment floor, and pull it rearward out of the guides on the sides of the luggage compartment.
- Remove the luggage compartment floor and store it in a clean, dry location.

WARNING

During hard braking or an accident, loose objects can fly through the passenger compartment and cause serious or even fatal injuries.

- Even if the luggage compartment floor panel is properly raised, it is still necessary to secure all objects.
- The maximum weight rating of the variable luggage compartment floor is 330 lbs (150 kg) in the upper position

NOTE

Do not let the luggage compartment floor fall freely when closing it. Always guide it down into place. The trim or the luggage compartment floor could be damaged.



If you store the luggage compartment cover under the variable luggage compartment floor, insert the luggage compartment floor into the upper guides.

Roof rack

Introduction to the subject

In this chapter you will find information on the following subjects:

⇒ *Attaching the roof rack base carrier and roof rack*

⇒ *Securing a load on the roof rack*



rain gutters that are used to attach many kinds of roof racks.

Since the rain gutters are molded into the roof to provide efficient aerodynamics, only Volkswagen-approved base carrier mounts and roof racks can be used.

When should the roof rack be removed?

- When it is no longer needed.
- Before driving through an automatic car wash.
- When the vehicle would otherwise be too high for minimum clearance to enter, for example, a garage.

WARNING

Transporting heavy or bulky loads on the roof rack will change the way the vehicle handles by shifting the vehicle's center of gravity and increasing the wind drag.

- Always secure the load properly with suitable and undamaged straps so that the load will not shift.
- Cargo that is large, heavy, bulky, long or flat will have a negative effect on the vehicle's aerodynamics, center of gravity and overall handling.
- Always avoid sudden maneuvers and hard braking.
- Always adapt your speed and driving to the heavier load and the weight distribution in the vehicle. Take road, weather, traffic, and visibility conditions into account as well.

NOTE

- Always remove the roof rack before driving through an automatic car wash.
- Your vehicle is higher when the roof rack is installed, especially when it is loaded. Compare the vehicle height with existing clearance heights, such as underpasses and garage doors.
- Always make sure that the roof rack system and anything being carried on it does not interfere with the roof antenna, the power sunroof, or the trunk lid.
- Make sure that the trunk lid does not touch items on the roof rack when opened.

Attaching the roof rack base carrier and roof rack

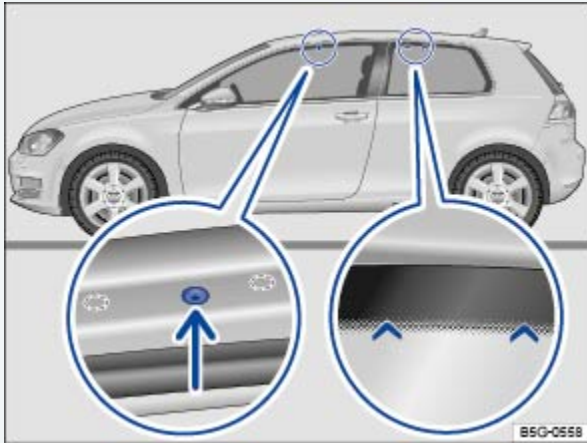


Fig. 107 Mounting points for the base carrier and roof rack on 2-door vehicles.

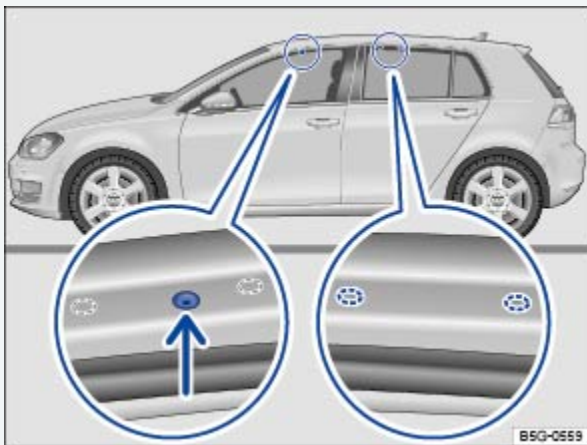


Fig. 108 Mounting points for the base carrier and roof rack on 4-door vehicles.



Read and follow the introductory information and safety information first ⇒ [Introduction to the subject](#)

The base carrier is the basis of a complete roof rack system. For safety reasons, additional attachments are necessary for transporting luggage, bicycles, surfboards, skis, and small boats. Suitable accessories can be purchased from your authorized Volkswagen dealer or authorized Volkswagen Service Facility.

Mounting the roof rack base carrier and roof rack on 2-door vehicles

Always attach the base carrier and roof rack correctly.



The front mounting holes are on the underside of the roof frame. They are sealed with plastic screws that must be removed before installation ⇒ [Fig. 107](#) (magnified view on left). The holes are only visible when the door is open. The rear markings for the base carrier are above the rear side windows ⇒ [Fig. 107](#) (magnified view on right).

Only mount the roof rack base carrier on the markings shown in the illustration.

Once you have installed the base carrier correctly, you can secure the roof rack on the base carrier according to the manufacturer's instructions.

Mounting the roof rack base carrier and roof rack on 4-door vehicles

Always attach the base carrier and roof rack correctly.

Always carefully follow the installation instructions from the base carrier or roof rack manufacturer.

The front mounting holes are on the underside of the roof frame. They are sealed with plastic screws that must be removed before installation ⇒ [Fig. 108](#) (magnified view on left). The rear markings for the base carrier are on the underside of the roof frame ⇒ [Fig. 108](#) (magnified view on right).

The holes and markings are only visible when the door is open.

Only mount the roof rack base carrier on the markings shown in the illustration.

Once you have installed the base carrier correctly, you can secure the roof rack on the base carrier according to the manufacturer's instructions.

WARNING

Installing or using a base carrier or roof rack improperly can cause the entire system to fly off the vehicle, causing accidents and injuries.

- Always follow the installation instructions provided by the manufacturer.
- Use the base carrier and roof rack only if they are undamaged and properly installed.
- Secure the roof rack base carrier only at the attachment points shown in the illustration ⇒ [Fig. 107](#) or ⇒ [Fig. 108](#).
- Always install the base carrier and roof rack properly.



ery trip and retighten them as needed after driving a short distance. During a long trip, check all bolts and fasteners at each stop.

- Always properly install special fixtures for items such as bicycles, skis, surfboards, etc.
- Do not modify or repair the base carrier or roof rack.



Follow the installation instructions provided for installing the roof rack system. Always carry them in the vehicle.

Securing a load on the roof rack



Read and follow the introductory information and safety information first ⇒ [Introduction to the subject](#)

It is not possible to secure a load unless the roof rack system has been properly installed ⇒ ⚠ .

Maximum permissible roof load

The maximum permissible roof load is 165 lbs. (75 kg) . The roof load is the combined weight of the roof rack and the items being carried on the roof ⇒ ⚠ .

Be sure you know the weight of the roof rack and the items you want to transport on the roof. Weigh them if necessary. Never carry a total of more than the maximum permissible roof load.

When using a roof rack with a lower load limit, do not load the rack to the maximum weight mentioned above. In this case, you may only load the roof rack to the weight limit specified in the system's installation instructions.

Distributing the load

Distribute the load evenly and secure it properly ⇒ ⚠ .

Checking the mountings

After the base carrier and roof rack have been installed, check all bolts and fasteners after driving a short time and at regular intervals thereafter.



If the maximum permissible roof load is exceeded, accidents and substantial vehicle damage may occur.

- Never exceed the specified roof load, the maximum Gross Axle Weight Rating, or the Gross Vehicle Weight Rating.
- Do not exceed the loading capacity of the roof rack, even if the permissible roof load is not fully utilized.
- Always make sure that loads are evenly distributed and that heavier items are, as far as possible, toward the front.

WARNING

Loose or improperly secured items can fall off the roof rack and cause accidents and injuries.

- Always use suitable, undamaged tie-down ropes and ratchet straps.
- Secure the load properly.

Trailer towing



Introduction to the subject

In this chapter you will find information on the following subjects:

⇒ *Technical requirements*

⇒ *Hitching up and connecting a trailer*

⇒ *Loading the trailer*

⇒ *Driving with a trailer*

⇒ *Ball mount*

⇒ *Retrofitting a trailer hitch*



Obey country-specific requirements about trailer towing and trailer hitches.

Volkswagen does not recommend installing a trailer hitch on your vehicle. Your Volkswagen was mainly designed for carrying passengers. If you plan to tow a trailer, please remember your vehicle will be performing a job for which it was not primarily intended. The additional load will affect durability, handling, fuel economy, and performance, and may require the vehicle to be serviced more often.

Trailer towing not only places more stress on the vehicle, it calls for more concentration from the driver. Always follow the operating and driving instructions given, and use common sense.

Under winter conditions, install winter tires on the vehicle and the trailer.

Important information for Golf R models

For technical reasons, the vehicle body structure is not designed for the installation of a trailer hitch.

Never install a trailer hitch on Golf R models. Installing a trailer hitch will do considerable damage to the vehicle ⇒ ⚠.

⚠ WARNING

Riding in a trailer is dangerous and may be illegal.

⚠ WARNING

Improper use of the trailer hitch can cause accidents and injuries. An improperly installed, incorrect, or damaged trailer hitch can cause the trailer to separate from the towing vehicle and cause serious personal injuries.

- Only use an undamaged, properly mounted trailer hitch.
- Never repair or modify the trailer hitch.
- To reduce the risk of injury in rear-end collisions, and the risk to pedestrians and cyclists when the vehicle is parked, always remove the ball mount when you are not towing a trailer.
- Never install a weight distributing or load equalizing trailer hitch on your vehicle. The vehicle was not designed for these kinds of trailer hitches. The trailer hitch attachment can fail, caus-



WARNING

Improper trailer towing can cause loss of vehicle control and serious personal injury.

- Driving with a trailer and carrying heavy or large things can change the way the vehicle handles, increase the distance it needs to stop safely, and cause accidents.
- Always secure the load properly with suitable and undamaged straps so that the load will not shift.
- Always adapt your speed and driving to the heavier load and the weight distribution in the vehicle. Take road, weather, traffic, and visibility conditions into account as well.
- Reduce your speed even more than you otherwise would when going downhill and under unfavorable load, weather, or wind conditions.
- Trailers with a high center of gravity tip more easily than trailers with a low center of gravity.
- Always avoid sudden maneuvers and hard braking.
- Be especially careful when passing other vehicles.
- Reduce speed immediately if the trailer shows the slightest sign of swaying.
- Never try to stop the swaying by accelerating.
- Always obey speed limits. In some areas, the speed limits for vehicles towing trailers are lower than for vehicles without trailers. Never drive faster than 50 mph (80 km/h; under exceptional circumstances, 60 mph - 100 km/h) when towing a trailer. This applies even if the local speed limit is higher.

WARNING

Installing a trailer hitch on Golf R models can cause an accident and serious personal injuries.

- Never install a trailer hitch on a Golf R vehicle.
- A trailer hitch can fall off while driving or rip loose while pulling a trailer, causing the trailer to separate from the vehicle.

NOTE



that will not be covered by any Volkswagen Limited Warranty.



If you are driving a new vehicle or a vehicle with a new or rebuilt engine, do not tow a trailer during the break-in period, about 600 miles (1000 km) ⇒ [Parts, accessories, repairs, and modifications](#).



If you tow a trailer, your vehicle may need maintenance more often because of the extra load it has to move.



When you are not towing, remove the trailer hitch ball. This helps keep the trailer hitch from causing damage to your vehicle and to others if your vehicle is hit from behind.




Some models need a trailer hitch to tow or tow-start other vehicles. You may want to always carry the ball mount in the vehicle after it has been removed. Be sure to stow it securely.

Technical requirements



Read and follow the introductory information and safety information first ⇒ [Introduction to the subject](#)

Use only a weight-carrying trailer hitch designed and approved for the gross weight of the trailer you want to tow. The trailer hitch must be suitable for your vehicle and trailer and must be securely bolted to the appropriate place on the vehicle chassis. Use only a trailer hitch with a removable ball mount. Always check with the trailer hitch manufacturer to make sure that you are using the correct trailer hitch and carefully follow the hitch manufacturer's instructions. Never install a weight-distributing or load-equalizing trailer hitch on your vehicle. The vehicle is not designed for this kind of trailer hitch ⇒  .

Do not use a bumper-mounted trailer hitch

Never install a trailer hitch on the bumper or on the bumper attachments. The trailer hitch must not interfere with the impact-absorbing bumper system. Do not make any changes to the vehicle exhaust and brake systems. From time to time, check that all trailer hitch mounting bolts are securely fas-



ing damage if your vehicle is hit from behind.

Engine cooling system

Towing a trailer makes the engine and its cooling system work harder. It is important that the engine cooling system is up to the job. Make sure that the cooling system has enough coolant.

Trailer brakes

If your trailer has its own brakes, make sure it meets all regulations. The trailer brake system must never be directly connected to the vehicle's brake system.

Safety chains

Always use safety chains between your vehicle and the trailer ⇒ [Hitching up and connecting a trailer](#).

Trailer taillights

Trailer lights must meet all regulations ⇒ [Hitching up and connecting a trailer](#).

Never connect the trailer lights directly to the electrical system of your vehicle.

Outside mirrors

If you cannot see the traffic behind you using the regular outside mirrors, then you must install extended mirrors. Extended mirrors may also be required by law in some countries/states/provinces. Always adjust the outside mirrors before driving. It's vital that you always have a clear view to the rear of the vehicle.

Maximum power consumption for the trailer

Do not exceed the power ratings listed in the chart below.

Electrical load	Maximum power
Brake lights total	108 watts
Turn signals per side	54 watts



Side marker lights total 100 watts

Taillights total 54 watts

WARNING

- An improperly installed or incorrect trailer hitch can cause a trailer to separate from the tow vehicle and cause serious personal injuries.
- If you don't have to tow a trailer any more, remove the entire trailer hitch. Always seal all bolt holes to prevent water and deadly exhaust fumes from getting into the vehicle.

NOTE

- If the trailer lights are not connected properly, the vehicle's electronics may be damaged.
- If the trailer uses too much electricity, the vehicle's electronics may be damaged.
- Never connect the electrical system for the trailer directly to the electrical connections for the rear lights or to any other unsuitable power sources. Use only a suitable connector to provide power to the trailer.



If you tow a trailer frequently, Volkswagen recommends having the vehicle serviced between the regular maintenance and inspection intervals because of the extra load it has to pull.

Hitching up and connecting a trailer



Read and follow the introductory information and safety information first ⇒ [Introduction to the subject](#)

Safety chains

Always make sure that the safety chains are properly attached to the towing vehicle. Leave enough slack in the chains so that you can go around corners without stretching the chains. The safety chains must not drag on the ground, however.



Make sure that the trailer lights work properly and meet legal requirements. Do not exceed the maximum power consumption for the trailer ⇒ [Technical requirements](#).

WARNING

Improper connections to the vehicle electrical system can cause malfunctions that affect the entire vehicle electrical system, which can lead to accidents and serious personal injury.

- Have any work on the electrical system done by an authorized Volkswagen dealer or authorized Volkswagen Service Facility.
- Never connect the electrical system for the trailer directly to the electrical connections for the rear lights or to any other unsuitable power sources. Use only a suitable connector to provide power to the trailer.

NOTE


Never attach a trailer to the vehicle or leave it attached to the vehicle when the trailer is supported by a trailer jack or blocks. Various things (such as a change in trailer or vehicle load or a flat tire) can lower or raise the vehicle. This subjects the trailer hitch and the trailer to strong forces that can damage the vehicle or the trailer.




If the engine is switched off and accessories in the trailer are on and use electricity from the vehicle, the vehicle battery will be drained as long as the electrical systems of the vehicle and the trailer are connected.

Loading the trailer



Read and follow the introductory information and safety information first ⇒  [Introduction to the subject](#)

Maximum permissible trailer weight and tongue weight

Maximum permissible trailer weight is the load that the vehicle can tow ⇒ . The tongue load or tongue weight is the load pressing down on the trailer hitch ball mount.



permissible trailer weight in this Manual.

The trailer load and tongue weight on the type identification plate for the trailer hitch are only test values. The vehicle-specific figures are often *lower than* these values. In some countries, but generally not in the United States, the vehicle-specific figures are listed in the official vehicle documents. Specifications in official vehicle documents always take precedence.

To help ensure optimum handling and driving safety, Volkswagen recommends always using the maximum permissible tongue weight. If the tongue weight is too low, the vehicle and trailer will not handle as well.

Tongue weight increases the load on the rear axle and, in turn, reduces the remaining load your vehicle can carry ⇒ *Determining the correct load limit*.

Combined towing weight

Combined towing weight is the weight of the loaded towing vehicle plus the weight of the loaded trailer.

This vehicle has not been designed to tow a Class II trailer and must never be retrofitted to tow a Class II trailer. Always make sure that your vehicle has been designed to tow the trailer you want to use and that it is legal to tow the trailer where you will be driving.

Loading the trailer

The weight distribution in the vehicle and trailer must be balanced. Use the maximum permissible tongue weight and make sure that the load in the trailer is evenly distributed and that it is not front-heavy or tail-heavy:

- Distribute the load in the trailer so that heavy objects are directly above the axle or as close as possible to the axle.
- Secure loads properly on the trailer.

Tire pressure

Always follow the trailer manufacturer's tire pressure recommendations for the trailer tires.

When towing, inflate the towing vehicle's tires to the maximum permissible pressure listed on the tire pressure label ⇒ *Tire inflation pressure*.



Exceeding the gross weight ratings for axle, tongue, vehicle, trailer or combined weight can cause accidents and serious personal injury.

- Never exceed the specified values.
- Never let the actual weights at the front and rear axles exceed the Gross Axle Weight Rating. Never let the combined front and rear weights exceed the Gross Vehicle Weight Rating.


WARNING

Trailer loads that are not properly secured can shift when the vehicle is moving or braking and suddenly change the way the vehicle handles, causing accidents and severe injuries.

- Always load the trailer properly.
- Always secure the load properly with suitable, undamaged straps that can be tightened so that the load cannot shift.

Driving with a trailer



Read and follow the introductory information and safety information first ⇒  [Introduction to the subject](#)

Headlight settings

Towing a trailer can raise the front end of the vehicle enough for the low beams to blind other road users. If your vehicle does not have headlight range adjustment, have the headlights adjusted by an authorized Volkswagen dealer or authorized Volkswagen Service Facility. Vehicles with Xenon headlights self-adjust to vehicle load and do not need manual adjustment.

Special towing considerations

- If the trailer has an overrun brake, apply the brakes *gently at first* and then firmly. This helps to prevent sudden brake shock and helps prevent trailer wheels from locking up.
- Due to the combined towing weight including the higher gross vehicle weight, the stopping distance is longer.
- Before driving downhill, especially on hills that are long or steep, shift into a lower gear (manual or automatic transmission) so that the engine helps to brake the vehicle. Otherwise, the brake sys-



- The vehicle's center of gravity and, in turn, the vehicle's handling, will change because of the trailer load and the increased combined towing weight of the vehicle and trailer.
- Weight distribution is especially bad if the towing vehicle is empty and the trailer is loaded. If you absolutely must drive with this combination, drive with extra care and at a reduced speed.

Starting off with a trailer on hills

Depending on how steep the hill is and the combined towing weight, a parked vehicle with trailer can roll backwards when you first start moving.

When starting off with a trailer on a hill:

- Depress and hold the brake pedal (and depress and hold the clutch - manual transmission).
- Shift into first gear or Drive (D/S) ⇒ *Shifting*.
- Unlock the parking brake and gently release it while holding the unlock button. At the same time, release the brake pedal and gradually depress the accelerator and, for a manual transmission, let out the clutch until you can feel the car moving forward. If applicable, follow the instructions for the Hill Start Assist feature ⇒ *Starting assistance systems*.
- Do not release the parking brake lever until the engine starts to move the vehicle forward. If your vehicle has an automatic transmission, you can also depress and hold the brake pedal for added braking and then let up on the brake pedal when you feel that the vehicle wants to move forward.
- Drive ahead slowly.

WARNING

Improper trailer towing can cause loss of vehicle control and serious personal injury.

- Driving with a trailer and carrying heavy or bulky items changes the way the vehicle handles and increases the distance it needs to stop safely.
- Always watch what is happening up ahead and around you. Brake earlier than you would if you were not towing a trailer.
- Always adapt your speed and driving to the heavier load and the weight distribution in the vehicle. Take road, weather, traffic, and visibility conditions into account as well.

favorable load, weather, or wind conditions.

- Drive especially carefully and accelerate gently. Always avoid sudden maneuvers and hard braking.
- Be especially careful when passing other vehicles.
- Reduce speed immediately if the trailer shows even the slightest sign of swaying.
- Never try to stop the swaying by accelerating.
- Always obey speed limits. In some areas speed limits for vehicles towing trailers are lower than for vehicles without trailers.

Ball mount

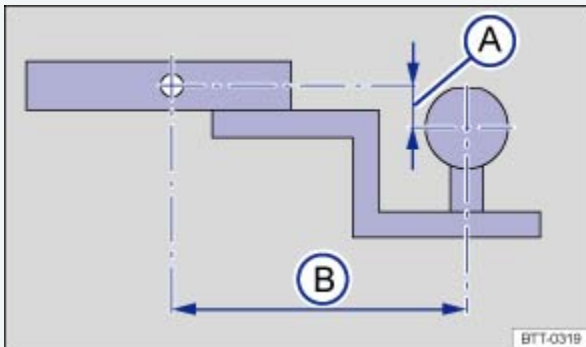


Fig. 109 Dimensions of the ball mount support.



Read and follow the introductory information and safety information first ⇒ [Introduction to the subject](#)

Your vehicle is not equipped with a trailer hitch or preparations for the installation of a trailer hitch. If you must tow a trailer, you must have the necessary electrical wiring and socket together with a suitable trailer hitch installed. Because towing a trailer places a great deal of stress on the vehicle, the attachment of a trailer to the vehicle and the dimensions of the receiver and ball mount are very important so that the extra forces the vehicle has to withstand can be properly handled.

The receiver used requires both a ball mount and a ball that meet special requirements regarding geometry and size. This applies to both the height of the ball above the surface where it attaches ⇒ [Fig. 109Ⓐ](#), and the pin-to-ball distance ⇒ [Fig. 109Ⓑ](#).

These dimensions are important because they help determine the way that the forces that arise dur-



ball, make sure that they meet the following specifications.

Ball mount dimensions

- The drop height Ⓐ from the center of the ball to the center of the hole for the securing pin on the ball mount must be at least 1 inch (25.4 mm) and at most $2\frac{7}{8}$ inches (73 mm).
- The pin-to-ball distance Ⓑ from the center of the ball to the center of the hole for the securing pin on the ball mount must be no more than 7 inches (178 mm).
- The ball diameter must be no more than $1\frac{1}{4}$ inches (32 mm).

A ball mount and ball combination that does not meet these specifications can damage your vehicle and may even fail in use ⇒ ⚠.

Never install a weight distributing or load equalizing trailer hitch on your vehicle. The vehicle is not designed for this kind of trailer hitch ⇒ ⚠.

WARNING

An improperly installed or unsuitable trailer hitch can cause the trailer to separate from the towing vehicle and result in a major accident with serious personal injuries.

- Have any trailer hitch retrofit or other work on a trailer hitch done by a qualified workshop.

CAUTION

The ball mount sticks out behind the rear bumper and can cause injury to pedestrians and cyclists.

- To reduce the risk of injury in rear-end collisions, and the risk to pedestrians and cyclists when the vehicle is parked, always remove the ball carrier when you are not towing a trailer.

NOTE

- Never use a ball larger than $1\frac{1}{4}$ inches (32 mm) on your vehicle. The vehicle was not designed to tow heavier trailers with a receiver larger than the specified ball. The increased loads can damage the attachment points for the trailer hitch.
- Never use an adapter to increase the size of the trailer hitch receiver from $1\frac{1}{4}$ inches (32 mm) to 2 inches (50.8 mm) or more to tow a trailer that is heavier than the maximum permissible

- You can use an adapter if required for the proper installation of a bicycle rack or other similar carrier as long as the maximum weight limits are observed. When using bicycle racks or similar carriers, make sure that the rear lights are not blocked.
- Only use trailer hitches that are approved by the hitch manufacturer for your vehicle and model.

Retrofitting a trailer hitch

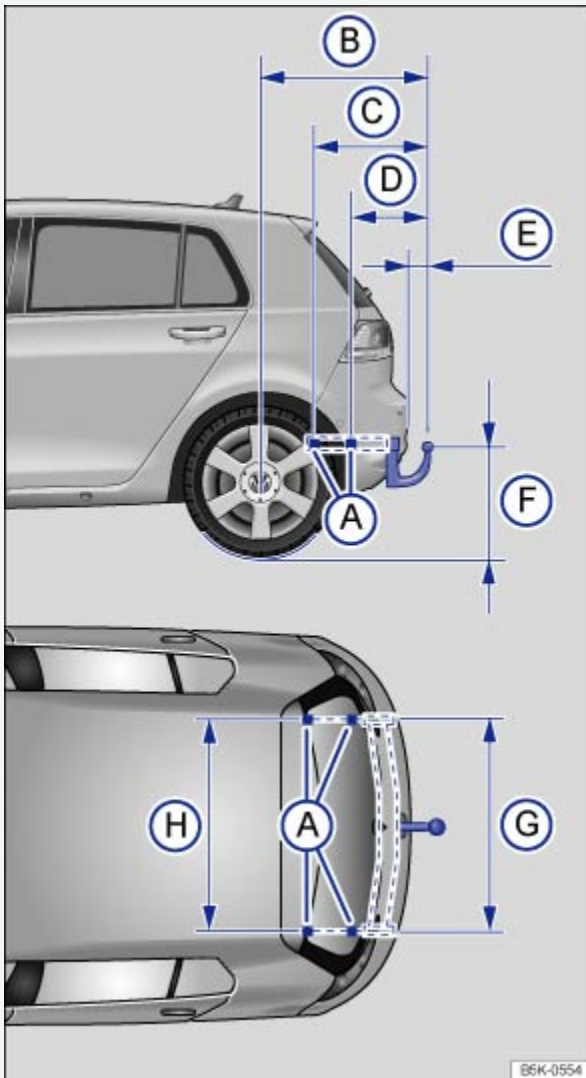


Fig. 110 Dimensions and attachment points for retrofitting a trailer hitch.



Read and follow the introductory information and safety information first ⇒ [Introduction to the subject](#)

Volkswagen recommends having the trailer hitch retrofit performed by a qualified workshop because



ments that you see an authorized Volkswagen dealer or an authorized Volkswagen service facility before having a trailer hitch installed on your vehicle.

When retrofitting a trailer hitch, the specified distance dimensions must be strictly adhered to. Under no circumstances may the distance from the center of the hitch ball to the surface of the road \Rightarrow Fig. 110[Ⓔ] be less than the specified minimum. This minimum height must be present even when the vehicle is fully loaded and subject to the maximum tongue weight.

Distance dimensions \Rightarrow Fig. 110 :

- A** Attachment points.
- B** 33 inches (838 mm)
- C** 20.2 inches (513 mm)
- D** 11.5 inches (293 mm)
- E** at least 2.6 inches (65 mm)
- F** 13.8 - 16.5 inches (350 - 420 mm)
- G** 41.1 inches (1043 mm)
- H** 41.3 inches (1048 mm)

WARNING

Improper or incorrect connections to the vehicle electrical system can cause malfunctions that affect the entire vehicle electrical system and cause accidents and serious personal injury.

- Never connect the electrical system of the trailer directly to the electrical connections of the rear lights or other unsuitable power sources. Use only a suitable connector to provide power to the trailer.
- Have any trailer hitch retrofit or other work on a trailer hitch done by a qualified workshop.

WARNING

An improperly installed or unsuitable trailer hitch can cause the trailer to separate from the towing vehicle and result in a major accident with serious personal injuries.

Maximum permissible trailer weight



subject

Model	Maximum power output	Engine code	Transmission	Trailer with brake	Trailer without brake	Tongue weight
Golf	1.8 L/170 hp (125 kW)	CXBA,	6S manual	a)	a)	a)
		CXBB				
Golf GTI	gasoline engine	1.8L	6S automatic	a)	a)	a)
		210 hp (155 kW)	CNTA, CXCA	6S manual	a)	a)
Golf GTI	gasoline engine	2.0L	DSG®	a)	a)	a)
		220 hp (162 kW)	CXCB	6S manual	a)	a)
Golf R	gasoline engine	2.0T	DSG®	a)	a)	a)
		292 hp (215 kW)	CYFB	6S manual	This vehicle cannot be used to tow a trailer ⇒ .	

The Gross Vehicle Weight Rating and the Gross Axle Weight Rating must not be exceeded, even with a



→ *important vehicle labels* . when a trailer is towed, the weight of the ball mount and the tongue weight of the trailer are added to the vehicle weight ⇒ *Determining the correct load limit* .

The trailer weight ratings given above are valid only up to altitudes of 3000 ft (1000 m) above sea level. The maximum permissible combined towing weight must be reduced by about 10% for every 3000 ft (1000 m), or portion thereof, of additional altitude.

WARNING

Exceeding the gross trailer weight rating and tongue weight can cause accidents and serious personal injury.

- Never let the actual weights at the front and rear axles exceed the Gross Axle Weight Rating (GAWR). Never let the combined front and rear weights exceed the Gross Vehicle Weight Rating (GVWR).

NOTE

Exceeding the gross weight ratings can cause extensive vehicle damage that is not covered by any Volkswagen Limited Warranty.

a) Information not available at time of printing.

Tires

Tires and wheels



Introduction to the subject

In this chapter you will find information on the following subjects:

⇒ *Tire and wheel handling*

⇒ *Wheel rims*

⇒ *New and replacement tires*



⇒ *Tire inflation pressure in cold tires*

⇒ *Tread depth and tread wear indicators*

⇒ *Tire wear and damage*

⇒ *Spare wheel or compact spare wheel*

⇒ *Tire labeling*

⇒ *Winter tires*

⇒ *Snow chains*

⇒ *Glossary of tire and loading terminology*

⇒ *Tires and vehicle load limits*

⇒ *Determining the correct load limit*

⇒ *UTQG classification*

Volkswagen recommends that all work on tires and wheels be done by an authorized Volkswagen dealer or authorized Volkswagen Service Facility. They are familiar with the technical requirements and recommended procedures, have the necessary special tools and spare parts, and can properly dispose of old tires.

WARNING

New tires or tires that are old, worn or damaged cannot provide maximum control and braking performance.

- Improper care and handling of tires and wheels can reduce driving safety and cause accidents and severe injuries.
- Install only radial tires of the same make, the same dimensions (tread circumference), and sim-



- New tires tend to be slippery and must be broken in. Always drive with special care for the first 350 miles (560 km) to help reduce the risk of losing control, a collision, and serious personal injuries.
- Check tire inflation pressure regularly when the tires are cold and always maintain the prescribed tire pressure. Low tire pressure can cause tires to get too hot, resulting in tread separation, sudden loss of pressure, and blowouts. Tires with excessively low pressure flex (bend) more, which can cause the tire to overheat and fail suddenly without warning.
- Check tires regularly for wear and damage.
- Never drive with worn or damaged tires (for example, tires with punctures, cuts, cracks, blisters, or bumps). Driving with worn or damaged tires can lead to loss of vehicle control, sudden tire failure including blowouts and sudden deflation, crashes, and serious personal injuries.
- Have worn or damaged tires replaced immediately.
- Never exceed the maximum speed rating or the maximum load rating of the tires on your vehicle.
- The effectiveness of the driver assistance systems and the braking support systems depends on the tire traction.
- If you notice unusual vibration or if the vehicle pulls to one side when driving, always stop as soon as it is safe to do so and check the wheels and tires for damage.
- To reduce the risk of losing control, crashes, and serious personal injuries, never loosen the bolts on wheels with bolted rim rings.
- Never mount used tires on your vehicle if you are not sure of their past use. Old, used tires and wheels may have damage that cannot be seen that can lead to sudden tire failure and loss of vehicle control.
- Tires age even if they are not being used and can fail suddenly, especially at high speeds, causing loss of vehicle control, accidents, and severe personal injuries. Tires that are more than 6 years old can be used only in an emergency and even then only with special care and at low speed.

For technical reasons it is usually not possible to use wheel rims from other vehicles. Even wheel rims from the same model may not fit properly. Check with an authorized Volkswagen dealer or authorized Volkswagen Service Facility if necessary.

Tire and wheel handling

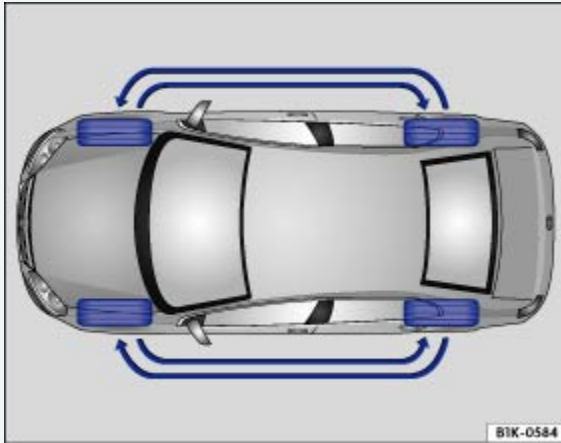


Fig. 111 Tire rotation diagram.



Read and follow the introductory information and safety information first ⇒ [Introduction to the subject](#)

Tires may be the least appreciated and most abused parts of a motor vehicle. Tires are very important, since their small patches of rubber are the only contact between your vehicle and the road.


Maintaining correct tire pressure, making sure that your vehicle and its tires do not have to carry more weight than they can safely handle, and regularly inspecting tires for damage (such as cuts, slashes, irregular wear, and overall condition) are the most important things that you can do to help avoid sudden tire failure, including tread separation and blowout.

The tires and wheels are essential parts of the vehicle's design. The tires and wheels approved by Volkswagen are specially matched to the characteristics of the vehicle for good road holding and safe handling when in good condition and properly inflated.

Avoiding tire damage

- If you must drive over a curb or other obstacle, drive very slowly and as much as possible at a right angle to the curb with the tire tread of both front wheels contacting the curb at the same time.



- Remove embedded material in the tread profile that has not yet penetrated the inside of the tire ⇒ [Tire wear and damage](#).
- Heed all warning messages from the Tire Pressure Monitoring System ⇒ [Tire Pressure Monitoring System \(TPMS\)](#).
- Replace worn or damaged tires immediately ⇒ [Tire wear and damage](#).
- Damage to tires and wheels is often not readily visible. If you notice unusual vibration or the vehicle pulls to one side, this may indicate that one of the tires is damaged. The tires must be checked immediately for hidden damage by an authorized Volkswagen dealer or an authorized Volkswagen Service Facility. See also ⇒ [Tire wear and damage](#).
- Never exceed the load and permissible maximum speed rating of the tires ⇒ [Tire labeling](#).
- Always keep aggressive chemicals including grease, oil, gasoline and brake fluid off the tires, including the compact spare wheel ⇒ .
- Replace missing valve caps immediately.

Unidirectional tires

Unidirectional tires are designed to rotate only in one direction. Unidirectional tires have arrows on the sidewalls that show the direction of rotation ⇒ [Tire labeling](#). Unidirectional tires must always be mounted according to the specified direction of rotation in order to deliver their best grip, braking performance, low road noise, and good wear as well as good hydroplaning resistance.

If you have to mount a tire opposite to its proper direction of rotation, you must drive more carefully, since the tire is no longer being used as designed. This is particularly important on wet roads. You must replace or remount the tire as soon as possible in order to restore the correct direction of rotation.

Rotating tires

To help ensure even wear on all tires, regular tire rotation according to the diagram ⇒ [Fig. 111](#) is recommended. In this way all tires can have about the same service life.

Volkswagen recommends that you have your tires rotated by an authorized Volkswagen dealer or authorized Volkswagen Service Facility.

Tires more than 6 years old



performance and cause them to harden and become brittle. Old tires can fail suddenly and without warning.

Volkswagen recommends replacing tires that are 6 years and older. This also applies to tires that look new (including the tire on the compact spare wheel) or that seem to still be usable with tread depth that has not yet reached the legal minimum depth ⇒ ⚠️ .

The age of each tire can be determined with the manufacturing date that is part of the U.S. DOT tire identification number (TIN) ⇒ [Tire labeling](#) .

Tire storage

Mark tires before removing them to help make sure that the previous location (left, right, front, rear) and rolling direction can be maintained when remounting them. Store tires in a cool, dry and preferably dark place. Do not store tires mounted on wheels standing up.

Tires not mounted on wheels should be covered to help protect them from dirt and stored vertically (sitting on the tread).

Lower profile tires (low aspect ratio tires)

Lower profile tires have a wider tread surface, larger rim diameter, and lower sidewalls than conventional wheel/tire combinations ⇒ ⓘ . Lower profile tires can improve the vehicle's handling and precision. They may, however, result in a less comfortable ride, for example, on uneven road surfaces.

⚠️ WARNING

Aggressive fluids and materials can cause visible and invisible tire damage that can cause tire blowouts.

- Always keep chemicals, oils, grease, fuels, braking fluids and other aggressive substances away from tires.

⚠️ WARNING

Tires age even if they are not being used and can fail suddenly, especially at high speeds, causing loss of vehicle control, accidents, and severe personal injuries.

- Tires that are more than 6 years old can be used only in an emergency and even then only with



NOTE

Tires and rims, especially lower profile tires and their rims, can be severely damaged and even destroyed by driving through potholes or over curbs and other obstacles.



Always dispose of old tires in accordance with legal requirements.

Wheel rims



Read and follow the introductory information and safety information first ⇒ [Introduction to the subject](#)

The design of the wheel bolts is matched to the factory-installed wheels. If different wheels are installed, wheel bolts with the right length and bolt head shape must be used. This helps to ensure that wheels can be mounted securely and that the brakes will work correctly ⇒ [Changing a wheel](#).

In most cases, you cannot use wheel bolts from a different vehicle. Even wheel rims from the same model may not fit properly.

Tires and wheel rims approved by Volkswagen have been matched precisely to your vehicle model and contribute considerably to good handling and safe vehicle performance.

Tightening torque

Wheel bolts must always be installed with the correct tightening torque ⇒ [Changing a wheel](#). The required tightening torque for your vehicle's wheel bolts is 88 ft-lbs (120 Nm). After changing a wheel, the bolt torque must be checked as soon as possible with an accurate torque wrench. See an authorized Volkswagen dealer or an authorized Volkswagen Service Facility.

Wheel rims with bolted rim rings

Wheel rims with bolted rim rings have several parts. The parts are bolted together with special screws in a special process. This helps to ensure that they will work properly, prevent leaks, run true and safely. Damaged wheel rims must be replaced, and you must never take them apart or try to repair them yourself. Have an authorized Volkswagen dealer or an authorized Volkswagen Service Facility repair them for you ⇒ .



Light-alloy wheels may have interchangeable decorative covers attached to the rim with self-locking screws. If you want to replace damaged wheel covers, contact your authorized Volkswagen dealer or authorized Volkswagen Service Facility.

WARNING

Using improper or damaged wheel rims can affect driving safety, cause accidents and severe personal injury.

- Use only wheel rims approved for the vehicle.
- Regularly check wheel rims for damage and replace them if necessary.


WARNING

Improper loosening and tightening of the bolts on wheel rims with bolted rim rings can cause accidents and severe personal injury.


- Never loosen bolted connections on wheel rims with bolted rim rings.
- Have all work on wheel rims with bolted rim rings performed by an authorized Volkswagen dealer or authorized Volkswagen Service Facility.

New and replacement tires



Read and follow the introductory information and safety information first ⇒  [Introduction to the subject](#)

New tires

- Drive a vehicle with new tires especially carefully for the first 350 miles (560 km) because the tires must first be *broken in*. Tires that are not broken in have reduced traction and braking performance ⇒ .
- Install only radial tires of the same make, the same dimensions (tread circumference), and similar tread profile on all 4 wheels.
- The tread depth of new tires can differ between tire models and manufacturers because of different design features and tread design.



- Tires should be replaced in pairs and not individually (both front tires or both rear tires at the same time) ⇒ ⚠.
- Replace tires only with tires that have the same specifications, including width and diameter, load and top speed rating as the tires approved by Volkswagen for your vehicle and model.
- Never use tires that are larger or wider than the dimensions of the tires approved by Volkswagen for your vehicle and model. Larger tires could scrape and rub on the vehicle body or other parts of the vehicle.

Tire Pressure Monitoring System (TPMS) considerations: The Tire Pressure Monitoring System (TPMS) must be recalibrated whenever you remove and remount or change any wheel or tire on the vehicle, even if the reinstalled or replacement wheels and tires are identical to those that were removed and even if the tire pressure does not change ⇒ [Tire Pressure Monitoring System \(TPMS\)](#).

WARNING

New tires tend to be slippery and must be broken in.

- Always drive with special care for the first 350 miles (560 km) to help reduce the risk of losing control, a collision, and serious personal injuries.

WARNING

Tires must have the required clearance. Tires that do not have enough clearance can rub against parts of the vehicle body, suspension, and brake system, causing brake system failure, tread delamination, and sudden blowouts.

- Always make sure that new tires are not larger than the tires approved for your vehicle and that the new tires do not rub against parts of the vehicle.

NOTE

- When switching to different tires, make certain the valves are not damaged.
- Never drive without valve stem caps. The valves could be damaged.



Always dispose of old tires in accordance with legal requirements.



example, winter tires, wider, low profile tires, or a compact spare – only use the replacement wheel for a short time and drive cautiously.

- Replace it with a tire matching the others on your vehicle as soon as possible.



Although tire size specifications can be the same, the actual dimensions may differ from those nominal values for different tire makes, or the tire contours may be significantly different.

Tire inflation pressure

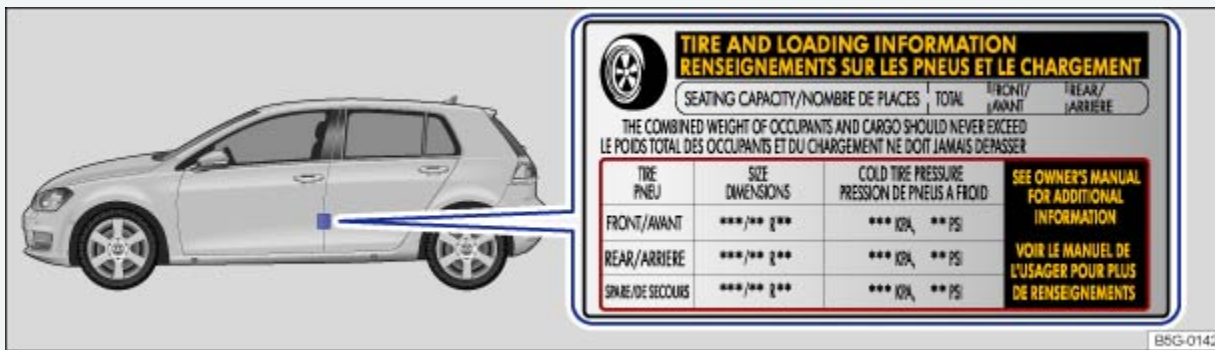


Fig. 112 On the driver door jamb: Location of the tire inflation pressure label.



Read and follow the introductory information and safety information first ⇒ *Introduction to the subject*

The correct tire inflation pressure for the factory-installed tires is listed on a label. The factory-installed tires may be summer, winter, or all-season tires. The label ⇒ *Fig. 112* is on the driver door jamb.

Under- or over-inflation significantly shortens the service life of your tires and affects the handling of the vehicle ⇒ . The correct tire pressure is very important, particularly when the vehicle is driven at higher speeds . Incorrect tire pressure causes increased wear and even sudden tire failure and blowouts.

Therefore, tire pressure should be checked at least once a month and always before long trips.

The specified tire inflation pressure applies to a cold tire . When tires are warm, the pressure will be higher than when the tires are cold.



tire inflation pressure would then be too low and could cause sudden tire failure and blowout.

Comfort tire pressure for Golf GTI vehicles with special 225/40 R18 92Y XL tires

For greater ride comfort, you can adjust tire pressures only for Golf GTI vehicles with special 225/40 R18 92Y XL tires to the lower Comfort tire pressure listed in the table ⇒ [Tire inflation pressure in cold tires](#).

Please remember that the lower Comfort tire pressure makes the tire 'softer' so that the tire will have a higher rolling resistance. Higher rolling resistance means that the vehicle will have lower fuel economy, increasing the amount of fuel you use and reducing the range of the vehicle.

You can increase the cold tire inflation pressure to the Standard tire pressure to increase fuel economy and range. Be sure to recalibrate the Tire Pressure Monitoring System whenever you change or adjust the cold tire inflation pressures ⇒ [Tire Pressure Monitoring System \(TPMS\)](#).

Checking tire inflation pressure

Always check the tire pressure only on cold tires when the vehicle has not been driven more than a couple of miles (kilometers) at low speed within the last 3 hours.

- Check tire inflation pressure regularly and on cold tires. Check all the tires, including the compact spare, if any. In colder climates tire pressure should be checked more often, but only when the tires are cold. Always use an accurate tire pressure gauge.
- After adjusting the tire inflation pressures, make sure to screw the valve caps back on; replace missing valve caps immediately. Please read and heed the information on resetting the Tire Pressure Monitoring System (TPMS), if necessary ⇒ [Tire Pressure Monitoring System \(TPMS\)](#).
- Remember that the vehicle manufacturer, not the tire manufacturer, determines the correct tire pressure for the tires on your vehicle. Never exceed the maximum inflation pressure listed on the tire sidewall for any reason.

Inflate a spare wheel to the pressure specified for the vehicle's road wheels on the tire pressure label; inflate a compact spare wheel to the pressure specified for the compact spare on the tire pressure label or on a separate label for the compact spare, if there is one.

WARNING


Incorrect tire pressure can cause a sudden tire failure or blowout, loss of control, collision, serious



- Always inflate tires to the recommended and correct cold tire pressure before driving off.
- Low tire pressure can cause tires to get too hot, resulting in tread separation, sudden loss of pressure, and blowouts. Tires with excessively low pressure flex (bend) more, which can cause the tire to overheat and fail suddenly without warning.
- Excessive speed and/or overloading can cause heat buildup, sudden tire failure including a blowout and sudden deflation and loss of control.
- If the tire pressure is too low or too high, the tires will wear prematurely and the vehicle will not handle well.
- Regularly check tire inflation pressure, at least once a month, and also especially before a long trip.
- Check the pressure in all 4 tires when the tires are still cold. Never reduce air pressure in warm tires to match cold tire inflation pressure.

NOTE

- Make sure not to jam the tire pressure gauge into the valve stem. Otherwise, you can damage the tire valves.
- Driving without valve caps, with the wrong valve caps, or with valve caps that are not properly screwed on can damage the tire valves. To help prevent damage, always use valve stem caps like those originally installed at the factory. The caps must be screwed on tightly. Do not use metal valve caps or comfort valve stem caps.


 Underinflation increases fuel consumption.



When the TPMS warns that the pressure in at least one tire is too low, check the tire pressure in all 4 tires with an accurate tire pressure gauge. Low tire pressure usually cannot be spotted by looking at the tire. This is especially true for low-profile tires. When checking the tire pressures, refer to ⇒ [Tire Pressure Monitoring System \(TPMS\)](#).

Tire inflation pressure in cold tires



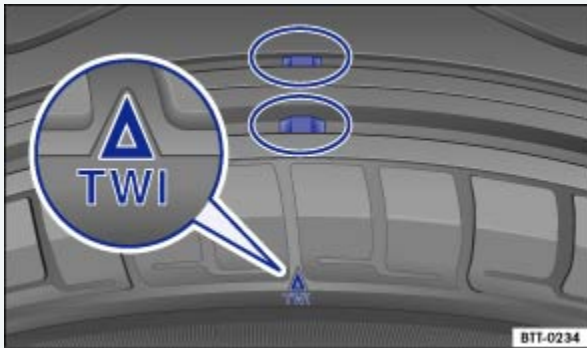
Read and follow the introductory information and safety information first ⇒  [Introduction to the](#)



Model and engine	Tire size	Comfort tire pressure			Standard tire pressure		
		(full load)			(full load)		
		psi	kPa	bar	psi	kPa	bar
Golf (170 hp/125 kW)	195/65 R15 91H	-	-	-	32	220	2.2
	205/55 R16 91H	-	-	-	32	220	2.2
	225/45 R17 91H	-	-	-	32	220	2.2
Golf GTI (210 hp/155 kW)	225/40 R18 92H XL	-	-	-	35	240	2.4
	225/45 R17 91H/W	-	-	-	33	230	2.3
	225/40 R18 92H XL	-	-	-	37	260	2.6
Golf GTI (220 hp/162 kW)	225/40 R18 92Y XL	33	230	2.3	37	270	2.7
Golf GTI (292 hp/215 kW)	225/40 R18 92H XL	-	-	-	37	250	2.5
Golf R (292 hp/215 kW)	225/40 R18 92Y XL	-	-	-	37	250	2.5
	225/40 R18 92Y XL	-	-	-	38	260	2.6
	235/35 R19 91Y XL	-	-	-	39	270	2.7

pressure applicable for the vehicle model, engine and factory-installed tires. The tire inflation pressure is listed on the tire inflation pressure label on the driver door jamb ⇒ [Fig. 112](#). The tire inflation pressures for the road tires are listed on this label. The inflation pressure for the compact spare is as specified on the tire pressure label or on a separate label for the compact spare, if there is one. In the event of a discrepancy between the above figures and the tire pressures listed on the tire inflation pressure label, the pressures listed on the label are the ones you should use. The listed pressure applies to all road tires. The Tire Pressure Monitoring System (TPMS) must be recalibrated whenever you change or adjust the cold tire inflation pressures or remove and remount or change any wheel or tire on the vehicle, even if the reinstalled or replacement wheels and tires are identical to those that were removed and even if the tire pressure does not change ⇒ [Tire Pressure Monitoring System \(TPMS\)](#).

Tread depth and tread wear indicators



[Fig. 113 Tread pattern: Wear indicator.](#)



Read and follow the introductory information and safety information first ⇒ [Introduction to the subject](#)

Tread depth

Most driving situations require as much tread depth as possible and similar tread depth for the tires on the front and rear wheels. This is especially true when driving in winter weather, at low temperatures and under wet conditions ⇒ .

In most countries the legally permissible minimum tread depth is 1/16 in. (1.6 mm), as measured in tread grooves next to the wear indicators. Please be sure to obey country-specific legal requirements.

Winter tires are no longer suitable for winter operation once the tread pattern is worn down to a depth of 3/16 in. (4.8 mm).



different design features and tread patterns.

Tread wear indicator (TWI) in the tire

The 1/16 in. (1.6 mm) high wear indicators are molded into the bottom of the tread grooves of the original tires running across the treads ⇒ [Fig. 113](#). Several wear indicators are evenly spaced around the tire. Markings on the sides of the tires (for example TWI or symbols) show the position of the wear indicators.

Wear indicators show when the tires are worn down. The tires must be replaced no later than when the tread pattern is worn down to the wear indicators.


WARNING


Worn tires are dangerous and can cause loss of vehicle control including serious personal injuries.

- Never drive a vehicle when the tread on any tire is worn down to the wear indicators, replace them sooner.
- Worn tires do not grip the road properly, especially on wet roads, increasing your risk of hydroplaning and loss of control.
- Worn tires reduce the ability of your vehicle to handle well in normal and difficult driving situations and increase braking distances and the risk of skidding.

Tire wear and damage



Read and follow the introductory information and safety information first ⇒  [Introduction to the subject](#)

Wheel rim and tire damage is often difficult to see. Unusual vibrations or pulling to one-side can be an indication of tire damage ⇒  .

- If you suspect tire damage, immediately reduce speed!
- Check tires and wheel rims for damage.
- If a tire is damaged, do not drive any farther. Get expert assistance.
- If no external damage is visible, slowly and carefully drive to the nearest authorized Volkswagen



checked.

Objects embedded in the tire

- If embedded objects have penetrated to the inside of the tire, do not remove them! If objects are stuck in the tread grooves of the tire, they can be removed.
- *With a spare wheel:* If necessary, change the damaged wheel ⇒ [Changing a wheel](#). If necessary, get professional assistance to change the wheel.
- *With the tire mobility set:* If necessary, seal and inflate the damaged tire with the tire mobility set ⇒ [Tire mobility set](#). Get assistance from an authorized Volkswagen dealer, an authorized Volkswagen Service Facility, or another qualified workshop.
- Check tire pressure and adjust if necessary.

Tire wear

Tire wear depends on several factors, including:

- Driving style.
- Unbalanced wheels.
- Wheel alignment.

Driving style – Fast cornering, hard acceleration and braking increase tire wear. If you experience increased tire wear under normal driving conditions, have the vehicle suspension checked by an authorized Volkswagen dealer or an authorized Volkswagen Service Facility.

Unbalanced wheels – The wheels on a new vehicle are balanced. When driving, however, various conditions can cause a wheel to become unbalanced. Unbalanced wheels can cause wear to the steering and suspension systems. Have all wheels rebalanced. A wheel must always be rebalanced if a new tire has been mounted.

Wheel alignment – Incorrect wheel alignment causes excessive and uneven tire wear, impairing vehicle safety. If you notice excessive or uneven tire wear, have the wheel alignment checked by an authorized Volkswagen dealer or an authorized Volkswagen Service Facility.

WARNING

Unusual vibrations or pulling to one side can indicate tire damage.

- Check tires and wheel rims for damage.
- Never drive with a damaged tire or rim. Get expert assistance instead.
- If no external damage is visible, slowly and carefully drive to the nearest authorized Volkswagen dealer, authorized Volkswagen Service Facility, or other qualified workshop and have the vehicle checked.

Spare wheel or compact spare wheel



Fig. 114 In the luggage compartment: Handwheel holding the spare wheel in place (if equipped).



Fig. 115 In the luggage compartment: Compact spare wheel (if equipped, label design may vary).



Read and follow the introductory information and safety information first ⇒ [Introduction to the subject](#)

Your vehicle may be equipped with a spare, a compact spare wheel, or a tire mobility set. For more information on the tire mobility set, see: ⇒ [Tire mobility set](#).



- Open the trunk lid and remove the variable luggage compartment floor ⇒ *Variable luggage compartment floor*.
- If applicable, remove the subwoofer ⇒ *Removing the subwoofer*.
- Pull the securing clip ⇒ *Fig. 114* (if equipped) out and up.
- Completely unscrew the handwheel in the center of the spare wheel ② or compact spare wheel ⇒ *Fig. 115* counterclockwise and remove the spare wheel.

Stowing the replaced wheel

- Open the trunk lid and remove the variable luggage compartment floor ⇒ *Variable luggage compartment floor*.
- If the wheel you took off the vehicle fits in the spare wheel well, position it so that the center hole of the rim is aligned with the threaded pin in the center of the well.
- Turn the handwheel ⇒ *Fig. 114* clockwise until the wheel is securely in place.
- Insert the securing clip ① (if equipped) in the stud slot so that the handwheel can no longer be turned.
- If necessary, return the vehicle tool kit to its location in the luggage compartment.
- Reinstall the variable luggage compartment floor in the luggage compartment.
- Close the trunk lid.

If the replaced wheel does not fit in the spare wheel well, stow it securely in the luggage compartment on top of the floor covering.

If the spare wheel is different from the road wheels

If the spare is different from the road wheels, a compact spare wheel, for example, or if the road wheels are winter tires, the spare wheel must be used only in the event of a flat tire, only for a brief time, and only when driving with extra caution ⇒ ⚠ .

Replace it with a tire matching the others on your vehicle as soon as possible.

Please heed the following:

- Do not drive faster than 50 mph (80 km/h)!



- Do not use snow chains on the compact spare wheel ⇒ [Snow chains](#).
- After installing the spare wheel or compact spare wheel, check the tire pressure as soon as possible ⇒ [Tire inflation pressure](#).

Check the tire inflation pressure of the spare or compact spare whenever you check the tire pressure of the road wheels, at least once a month. Inflate a spare wheel to the cold tire pressure specified for the vehicle's road wheels on the tire pressure label; inflate a compact spare wheel to the cold tire pressure specified for the compact spare on the tire pressure label or on a separate label for the compact spare, if there is one.

WARNING

Improper use of a spare wheel or a compact spare wheel can cause loss of vehicle control, a crash or other accident, and serious personal injury.

- Never use a spare wheel or compact spare wheel if it is damaged or worn down to the wear indicators.
- In some vehicles, the spare wheel or compact spare wheel is smaller than the original tire. A smaller compact spare wheel is identified with a sticker and the words 50 mph or 80 km/h. This is the maximum permissible speed when driving with this tire.
- Never drive faster than 50 mph (80 km/h) with a compact spare wheel. Avoid full-throttle acceleration, heavy braking, and fast cornering!
- Never drive more than 125 miles (200 km) if a compact spare wheel is installed on the front axle (drive axle).
- Replace the compact spare with a normal wheel and tire as soon as possible. Compact spare wheels are designed for brief use only.
- Regularly check the U.S. DOT Tire Identification Number (TIN) to determine the age of the compact spare wheel ⇒ [Tire labeling](#). Tires age even if they are not being used and can fail suddenly, especially at higher speeds.
- Tires that are more than 6 years old can only be used in an emergency and then with special care and at lower speeds.
- The compact spare wheel must always be secured with the wheel bolts provided by the factory.

- After installing the compact spare wheel, the tire pressure must be checked as soon as possible ⇒ *Tire inflation pressure* .
- Snow chains cannot be used on the compact spare wheel. If you must use snow chains and have a compact spare wheel mounted, move the compact spare wheel to the rear axle if a front tire has to be replaced. The tire taken off the rear axle can then be used to replace the flat front tire. Be sure you do not change the tire's direction of rotation. Install the snow chains on the full-sized road tire.

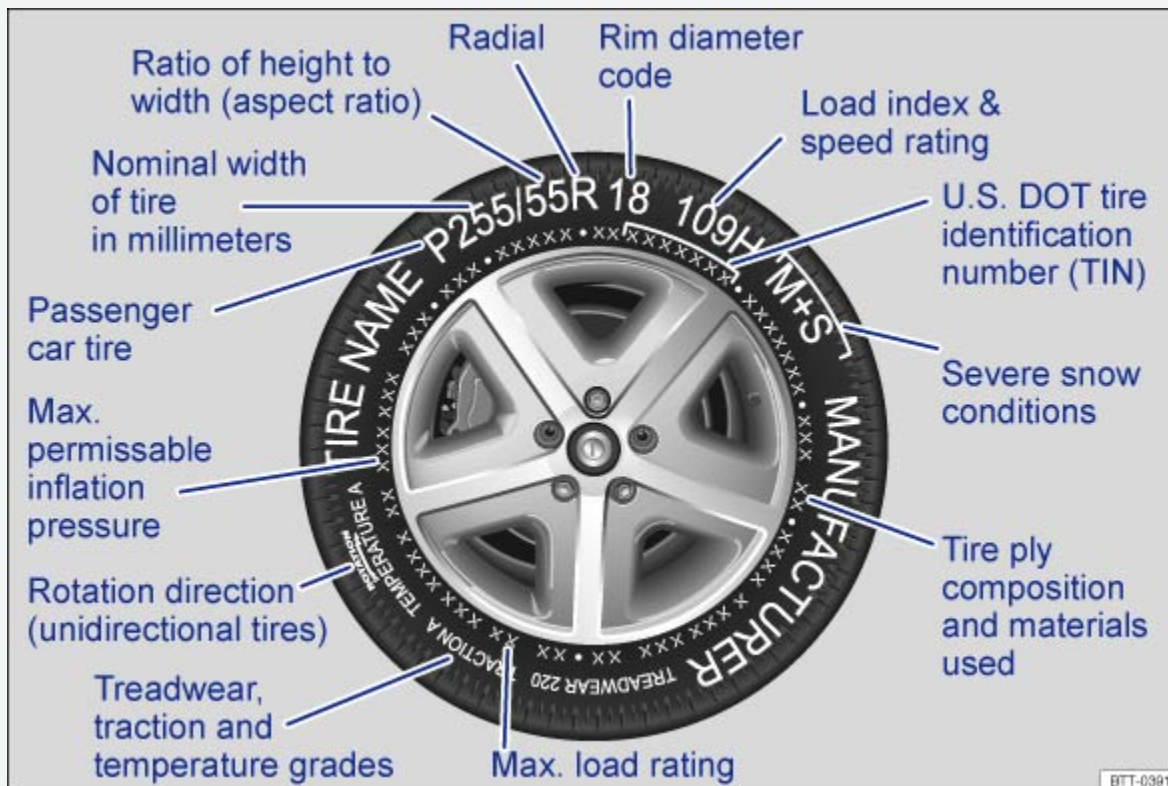
NOTE

When the spare wheel or compact spare is being used, the TPMS indicator light can light up after a couple of minutes ⇒ *Tire Pressure Monitoring System (TPMS)* .



If possible, attach the spare wheel, compact spare wheel, or the wheel you took off the vehicle securely in the luggage compartment.

Tire labeling





Read and follow the introductory information and safety information first ⇒ [Introduction to the subject](#)


Knowing about tire specifications makes it easier to choose the correct replacement tires. Radial tires have specifications marked on the sidewall.

Tire labeling (example)	Meaning	
<i>Brand, Logo</i>	<i>Manufacturer</i>	
<i>Tire name</i>	Individual tire designation of the manufacturer.	
P255 / 55 R 18	Dimensions:	
	P	Tire application: Passenger car
	255	Nominal sidewall-to-sidewall width of tire in millimeters.
	55	Ratio of height to width (aspect ratio)
	R	Tire belt design letter code for radial.
	18	Rim diameter (in inches)
109 H	Load rating code ⇒ Load rating code and speed rating code ⇒ Speed rating code letter .	



XL	Indicates reinforced tire (heavy-duty)	
M+S or M/S	Indicates Mud and Snow capability (also M/S) ⇒ <i>Winter tires</i> .	
RADIAL TUBELESS	Tubeless radial tire.	
E4 ...	Labeling according to international regulations (E) including number of the approving country. The multi-digit approval number is listed next.	
DOT BT RA TY5 1709	Tire identification number (TIN) ^{a)} – In some cases the manufacturing date is only on one side of the tire:	
	DOT	The tire complies with the requirements of the United States Department of Transportation, responsible for issuing safety standards.
	BT	Identification letter of the manufacturing site.
	RA	Manufacturer information regarding tire dimensions.
	TY5	Tire characteristics provided by the manufacturer.
	1709	Manufacturing date: 17th week in 2009.



TWI	Marks the position of the treadwear indicator ⇒ <i>Tread depth and tread wear indicators</i> .
Made in Germany	Country of manufacture.
MAX LOAD 615 KG (1356 LBS)	United States maximum load rating per wheel.
MAX INFLATION 350 KPA (51 PSI)	United States maximum permissible inflation pressure.
ROTATION	Rotation direction (unidirectional tires)
SIDEWALL 1 PLY RAYON	Tire ply composition and materials used: 1 layer of rayon.
TREAD 4 PLIES 1 RAYON + 2 STEEL + 1 NYLON	Tire tread composition and materials used: In this example there are 4 layers under the tread: 1 layer of rayon, 2 layers of steel belt and 1 layer of nylon.
Consumer information regarding comparison to specified base tires (standardized test procedure) ⇒  ⇒ <i>UTQG classification</i> :	



TREADWEAR 220	Relative service life expectancy of the tire referenced to a U.S.-specific standard test.
TRACTION A	Traction rating under wet conditions (AA, A, B or C).
TEMPERATURE A	Temperature stability of the tire at increased test bench speeds (A, B or C).
Additional numbers found on the tire could either be tire manufacturer internal labels or country-specific labels (such as for Brazil and China).	

Unidirectional tires

Unidirectional tires are designed to rotate only in one direction. Unidirectional tires have arrows on the sidewalls that show the direction of rotation. Make sure you mount the tire so that it rotates in the proper direction. The tire's performance with regard to hydroplaning, traction, noise, and wear is worse if it is not mounted in the proper direction of rotation.

If you have to mount a tire opposite to its proper direction of rotation, you must drive more carefully, since the tire is no longer being used as designed. This is particularly important on wet roads. You must replace or remount the tire as soon as possible in order to restore the correct direction of rotation.

Load rating code

The load index indicates the maximum permissible load per individual tire in pounds (kilograms).

- 91 1356 lbs (615 kg)
- 92 1388 lbs (630 kg)
- 93 1433 lbs (650 kg)
- 95 1521 lbs (690 kg)



98	1653 lbs (750 kg)
99	1709 lbs (775 kg)
100	1763 lbs (800 kg)
101	1819 lbs (825 kg)
102	1874 lbs (850 kg)
103	1929 lbs (875 kg)
104	1984 lbs (900 kg)
110	2337 lbs (1060 kg)

Speed rating code letter

The speed rating code letter indicates the maximum permissible road speed of the tires.

P	up to 93 mph (150 km/h)
Q	up to 99 mph (160 km/h)
R	up to 106 mph (170 km/h)
S	up to 112 mph (180 km/h)
T	up to 118 mph (190 km/h)
U	up to 124 mph (200 km/h)
H	up to 130 mph (210 km/h)
V	up to 149 mph (240 km/h)
Z	over 149 mph (240 km/h)
W	up to 168 mph (270 km/h)
Y	up to 186 mph (300 km/h)

Some tire manufacturers label tires with a maximum permissible road speed above 149 mph (240 km/h) with the letter combination ZR.

WARNING

Using incorrect or unmatched tires and/or wheels or improper tire and wheel combinations can lead to loss of control, collision and serious personal injury.

- Always use tires, wheels and wheel bolts that meet the specifications of the original factory-installed tires or other combinations that have been specifically approved by the vehicle manu-



- All 4 wheels must be fitted with radial tires of the same type, the same size (tread circumference), and the same tread pattern. Driving with different tires reduces vehicle handling and can lead to a loss of control.
- Never drive faster than the maximum speed for which the tires installed on your vehicle are rated because tires that are driven faster than their rated speed can fail suddenly.
- Overloading tires can cause heat build-up, sudden tire failure, including a blowout and sudden deflation and loss of control.
- Temperature grades apply to tires that are properly inflated and not over- or underinflated.

a) TIN represents the serial number of the tire.

Winter tires



Read and follow the introductory information and safety information first ⇒ [Introduction to the subject](#)


Winter tires improve the handling characteristics of your vehicle significantly when driving under wintry road conditions. Summer tires have less traction on snow and ice because of their design (width, rubber composition, tread design). Volkswagen strongly recommends that you always have winter tires or all-season tires installed on all 4 wheels on your vehicle, especially when winter road conditions are expected. Winter tires also improve the vehicle's braking performance and help reduce stopping distances during winter weather. Volkswagen recommends installing winter tires once temperatures are below +45 °F (+7 °C).

Winter tires are no longer suitable for winter driving once the tread pattern is worn down to a depth of 3/16 in (4.8 mm). In addition, winter tire performance decreases with age – independent of the tread profile depth.

When using winter tires:


- Obey state and country-specific legal requirements.
- Install winter tires on all 4 wheels.
- Use winter tires only under wintry road conditions.



- Use only winter tires of the same tire belt design, the same dimensions (tread circumference), and the same tread design.
- Follow speed restrictions according to the winter tire's speed rating code letter ⇒  .

Speed restrictions

Winter tires are certified up to a top speed identified by speed rating code letters on the sidewall ⇒ [Tire labeling](#) .

In appropriately equipped vehicles, the speed warning can be set and changed in the Infotainment system by pressing the **CAR** button followed by the  and Tires function keys ⇒ [Menu and system settings](#) .

Top speed rating and tire inflation pressure for V winter tires depend on the engine installed in your vehicle. Be sure to ask your authorized Volkswagen dealer or authorized Volkswagen Service Facility about the maximum permissible speed and the required tire inflation pressure for the winter tires that you plan to use.

All-wheel drive (4MOTION)

Vehicles with all-wheel drive and standard road wheels have good forward motion and traction even under wintry road conditions. However, Volkswagen recommends installing winter tires or all season tires on *all 4* wheels to improve handling as well as *braking performance*.

If you use snow chains , please read and heed information and directions ⇒ [Snow chains](#) .

WARNING

Driving faster than the maximum speed for which the winter tires on your vehicle were designed can cause sudden tire failure including a blowout and sudden deflation, loss of control, crashes and serious personal injuries.

- Winter tires have a maximum speed rating that may be lower than your vehicle's maximum speed.
- Never drive faster than the maximum speed for which the winter tires installed on your vehicle are rated because tires that are driven faster than their rated speed can fail suddenly.
- Never exceed the maximum load rating for the winter tires installed on your vehicle.



temperatures above 145 °F (70 °C), they are quieter, do not wear as quickly, and reduce fuel consumption.



The Tire Pressure Monitoring System must be recalibrated whenever you remove and remount or change any wheel or tire on the vehicle, even if the reinstalled or replacement wheels and tires are identical to those that were removed and even if the tire pressure does not change ⇒ [Tire Pressure Monitoring System \(TPMS\) and recalibration through the Infotainment system](#).



If necessary, ask your authorized Volkswagen dealer or authorized Volkswagen Service Facility about permissible winter tire dimensions.

Snow chains



Read and follow the introductory information and safety information first ⇒ [Introduction to the subject](#)


Obey local regulations as well as the applicable speed limits when driving with snow chains.

Snow chains improve forward motion, traction and braking characteristics under wintry conditions.

Snow chains may be used only on the front wheels and only in tire and wheel combinations that have been approved by Volkswagen. This applies even to all-wheel drive vehicles (4MOTION).

Please contact your authorized Volkswagen dealer or authorized Volkswagen Service Facility about appropriate wheel, tire and snow chain dimensions.

If possible, use only chains with low profile links that are not thicker than 37/64 in. (15 mm) including the tensioner.

Remove center hubcaps and decorative rim rings before installing snow chains ⇒ . However, for safety reasons, caps must be installed on the wheel bolts. These are available from authorized Volkswagen dealers and authorized Volkswagen Service Facilities.

Compact spare wheel

For technical reasons, snow chains cannot be used on the compact spare ⇒ [Spare wheel or compact](#)



If you must use snow chains and have a compact spare wheel mounted, move the compact spare wheel to the rear axle if a front tire has to be replaced. The tire taken off the rear axle can then be used to replace the flat front tire. Be sure to install the unidirectional tires so that they will run in the proper direction. Volkswagen recommends installing the snow chains before mounting the wheel to the vehicle.

WARNING

Using the wrong snow chains or installing snow chains improperly can cause accidents and severe personal injuries.

- Always use the proper snow chains.
- Follow the installation instructions provided by the snow chain manufacturer.
- Never exceed the permissible speed limit when driving with snow chains.

NOTE

- Remove snow chains when roads are free of snow. Otherwise, the chains can damage the tires, impair vehicle handling and can be quickly worn down.
- Snow chains can scratch or damage wheel rims if they have direct contact with the rims. Volkswagen recommends using coated snow chains.

Glossary of tire and loading terminology



Read and follow the introductory information and safety information first ⇒  [Introduction to the subject](#)

Accessory weight

The combined weight (in excess of those standard items which may be replaced) of automatic transmission, electro-mechanical power steering, power brakes, power windows, power seats, radio, and heater, to the extent that these items are available as factory-installed equipment (whether installed or not).

Aspect ratio



means that the cross-sectional height is 50% of the tread width. A shorter sidewall can improve steering response and provide better overall handling, for example, on dry pavement.

Bead

The part of a tire made of steel wires, wrapped or reinforced by ply cords, with the shape and structure to ensure proper fit to the wheel rim.

Bead separation

A breakdown of the bond between components in the bead.

Carcass

The tire structure, except tread and sidewall rubber which, when inflated, bears the load.

Chunking

The breaking away of pieces of the tread or sidewall.

Cord

The strands of material forming the plies in the tire.

Cord separation

The parting of cords from adjacent rubber compounds.

Cracking

Any parting within the tread, sidewall, or inner liner of the tire extending to cord material.

Cold tire inflation pressure

The tire pressure recommended by the vehicle manufacturer for a tire of a specified size that has not been driven for more than a couple of miles (kilometers) at low speeds in the 3 hour period before the tire pressure is measured or adjusted.

Curb weight

The weight of a motor vehicle with standard equipment including the maximum capacity of fuel, oil, and coolant, air conditioner, and additional weight of optional equipment.



A tire designed to operate at higher loads and at higher inflation pressures than the corresponding standard tire.

Gross Axle Weight Rating (GAWR)

The load-carrying capacity of a single axle system, measured where the tire contacts the ground.

Gross Vehicle Weight Rating (GVWR)

The maximum loaded weight of the vehicle.

Groove

The space between 2 adjacent tread ribs.

Load rating (code)

The maximum load that a tire is rated to carry for a given inflation pressure. You may not find this information on all tires because it is not required by law.

Maximum load rating

The load rating for a tire at the maximum permissible inflation pressure for that tire.

Maximum loaded vehicle weight

The total of:

- Curb weight.
- Accessory weight.
- Vehicle capacity weight.
- Production options weight.

Maximum (permissible) inflation pressure

The maximum cold inflation pressure to which a tire may be inflated. Also called maximum inflation pressure.

Normal occupant weight

Means 150 lbs (68 kilograms) times the number of occupants seated in the vehicle up to the total



Occupant distribution

The placement of passengers in a vehicle.

Outer diameter

The diameter of a new, properly inflated tire.

Overall width

Total width measured at the exterior sidewalls of an inflated tire, including the additional width of labeling, decorations, or protective bands or ribs.

Passenger car tire

A tire intended for use on passenger cars, multipurpose passenger vehicles, and trucks, that have a gross vehicle weight rating (GVWR) of 10,000 pounds or less.

Ply

A layer of rubber-coated parallel cords.

Ply separation

A parting of rubber compound between adjacent plies.

Pneumatic tire

A mechanical device made of rubber, chemicals, fabric, and steel or other materials, that, when mounted on an automotive wheel, provides the traction and contains the gas or fluid that sustains the load.

Production options weight

The combined weight of installed regular production options weighing over 5 lbs (2.3 kg) more than the standard items they replace, and not previously considered as curb weight or accessory weight. These include, for example, heavy-duty brakes, ride levelers, roof rack, heavy-duty battery, and special trim.

Radial ply tires

A pneumatic tire in which the ply cords that extend to the beads are laid at substantially 90 degrees to



Recommended inflation pressure

The tire pressure recommended by the vehicle manufacturer for a tire of a specified size that has not been driven for more than a couple of miles (kilometers) at low speeds in the 3 hour period before the tire pressure is measured or adjusted.

Reinforced tire

A tire designed to operate at higher loads and at higher inflation pressures than the corresponding standard tire.

Rim

The outer edge of a wheel upon which the tire beads are seated.

Rim diameter

The nominal diameter of the wheel's tire bead seating surface. If you change your wheel size, to wheels of a different diameter, you will have to purchase new tires to match the new wheels.

Rim size

Designation means rim diameter and width.

Rim type designation

The industry or manufacturer's designation for a rim by style or code.

Rim width

The nominal distance between wheel rim flanges.

Section width

The linear distance between the exteriors of the sidewalls of an inflated tire, excluding elevations due to labeling decoration, or protective bands.

Sidewall

The portion of a tire between the bead and the tread.

Sidewall separation



Speed rating (letter code)

A standardized letter code indicating the maximum speed at which a tire is designed to be driven for extended periods of time. The ratings range from 93 mph or 150 km/h (P) to 186 mph or (300 km/h) Y.

The speed rating letter code, where applicable, is molded on the tire sidewall ⇒ [Tire labeling](#). You may not find this information on all tires because it is not required by law.

Tire Pressure Monitoring System

A system that detects when at least one of a vehicle's tires is underinflated and illuminates a low tire-pressure warning light.

Tread

The portion of a tire that normally touches the road.

Tread rib

A tread section running circumferentially around a tire.

Tread separation

Tire failure caused by the tread pulling away from the tire carcass.

Tread wear indicators (TWI)

Raised areas within the main tread grooves that show, visually, when tires are worn and near the end of their useful life ⇒ [Tread depth and tread wear indicators](#).

Uniform Tire Quality Grading (UTQG)

A tire information system developed by the U.S. National Highway Traffic Safety Administration (NHTSA) that is designed to help buyers compare tires. UTQG is not a safety rating, nor is it a guarantee that a tire will last for a certain number of miles or perform a certain way. It gives tire buyers more information to compare with factors such as price, brand loyalty and dealer recommendations. Under UTQG, tires are graded by the tire manufacturers in 3 areas: tread wear, traction and temperature resistance. UTQG information is molded into the tire sidewalls.



A tire's serial number. It begins with the letters DOT (Department of Transportation) and indicates that the tire meets all federal standards. The next 2 numbers or letters indicate the plant where the tire was manufactured. The last 4 numbers represent the week and year of manufacture.

For example, the numbers 1709 mean that the tire was produced in the 17th week of 2009. Any other numbers are marketing codes used by the tire manufacturer. This information is used to help identify affected consumers if a tire defect requires a recall.

Vehicle capacity weight

The total rated cargo, luggage and passenger load. Passenger load is 150 lbs (68 kilograms) times the vehicle's total seating capacity (as listed on the label inside the driver door).

Vehicle maximum load on the tire

The load on an individual tire that is determined by taking each axle's share of the maximum loaded vehicle weight (GAWR) and dividing by 2.

Vehicle normal load on the tire

The load on an individual tire that is determined by taking each axle's share of the curb weight, accessory weight, and normal occupant weight (distributed according to the table below) and dividing by 2.

Wheel size designation

Wheel rim diameter and width.

Occupant loading and distribution for vehicle normal load for various designated seating capacities

Designated seating capacity, number of occupants	Vehicle normal load, number of occupants	Occupant distribution in a normally loaded vehicle
2, 3, or 4	2	2 in front
5	3	2 in front, 1 in back

Tires and vehicle load limits



subject

There are limits to the load any vehicle or any tire can carry. A vehicle that is overloaded will not handle well and is more difficult to stop. Overloading can damage important parts of the vehicle. Overloading can also lead to blowout, sudden loss of pressure or other tire failure that can cause loss of control.

Your safety and the safety of your passengers depends on making sure that load limits are not exceeded. Vehicle load includes everybody and everything in and on the vehicle. These load limits are technically referred to as the vehicle's Gross Vehicle Weight Rating (GVWR) .

The GVWR includes the weight of the basic vehicle, all factory-installed and other accessories, a full tank of fuel, oil, coolant and other fluids plus maximum load. The maximum load includes the number of passengers that the vehicle is intended to carry (seating capacity) with an assumed weight of 150 lbs (68 kg) for each passenger at a designated seating position and the total weight of any luggage in the vehicle. If you tow a trailer, the weight of the trailer hitch and the tongue weight of the loaded trailer must be included as part of the vehicle weight. At altitudes above 3000 ft (1000 m), combined towing weight (vehicle plus trailer) must be reduced by 10% for every 3000 ft (1000 m).

The Gross Axle Weight Rating (GAWR) is the maximum load that can be carried at each of the vehicle's 2 axles (by the front or rear tires). GVWR and GAWR are listed on the safety compliance label on the driver door jamb. Because there is an upper limit to your vehicle's total weight (GVWR), the weight of whatever is being carried (including the weight of a trailer hitch and the tongue weight of the loaded trailer) is also limited. More passengers, or passengers who are heavier than the assumed 150 lbs (68 kg), mean that less weight can be carried as luggage or other cargo. The tire pressure label on your Volkswagen also lists the maximum combined weight of all of the occupants and luggage or other cargo that the vehicle can carry.

WARNING

Overloading a vehicle can cause loss of vehicle control, a crash or other accident, serious personal injury, and even death.

- Carrying more weight than your vehicle was designed to carry will prevent the vehicle from handling properly and increase the risk of the loss of vehicle control.



distance.

- Tires on a vehicle that has been overloaded can fail suddenly, including a blowout and sudden deflation, causing loss of control and a crash.
- Always make sure that the total load being transported – including the weight of a trailer hitch and the tongue weight of a loaded trailer – does not make the vehicle heavier than the vehicle's Gross Vehicle Weight Rating.

Determining the correct load limit



Read and follow the introductory information and safety information first ⇒ [Introduction to the subject](#)

Never overload tires. The following example illustrates how to determine the combined weight of all vehicle occupants and luggage or other vehicle payloads. Never overload the vehicle!


Steps for Determining Correct Load Limit:	
1.	Locate the statement THE COMBINED WEIGHT OF OCCUPANTS AND CARGO SHOULD NEVER EXCEED XXX KG OR XXX LBS on your vehicle's placard (tire inflation pressure label) ⇒ <i>Tire inflation pressure</i> .
2.	Determine the combined weight of the driver and passengers that will be riding in your vehicle.
3.	Subtract the combined weight of the driver and passengers from XXX kg or XXX lbs.



4.	<p>The resulting figure equals the available amount of cargo and luggage load capacity.</p> <p>For example, if the XXX amount equals 1400 lbs. and there will be five 150 lb. passengers in your vehicle, the amount of available cargo and luggage load capacity is 650 lbs. (1400-750 (5 x 150) = 650 lbs.)</p>
5.	<p>Determine the combined weight of luggage and cargo being loaded on the vehicle. That weight may not safely exceed the available cargo and luggage load capacity calculated in Step 4.</p>
6.	<p>If your vehicle is capable of towing a trailer: The load from your trailer will be transferred to your vehicle. Consult this manual to determine how this reduces the available cargo and luggage load capacity of your vehicle.</p>
	<p>Check the tire sidewall to determine the load index specified for the tire.</p>

UTQG classification



Read and follow the introductory information and safety information first ⇒  [Introduction to the subject](#)

Uniform Tire Quality Grading (UTQG): Quality grades can be found where applicable on the tire sidewall between the tread shoulder and maximum section width. Example:

- Treadwear (number)



- Temperature: A, B or C

For example: Treadwear 200, Traction AA, Temperature A.

All passenger car tires must conform to Federal Safety Requirements in addition to these grades.

Treadwear

The treadwear grade is a comparative rating based on the wear rate of the tire when tested under controlled conditions on a specified government test course.

For example, a tire graded 150 (Treadwear-value 150) would wear one-and-one-half (1 1/2) times as well on the government course as a tire graded 100.

The relative performance of tires depends upon the actual conditions of their use, however, and may depart significantly from the norm due to variations in driving habits, service practices and differences in road characteristics and climate.

Traction

The traction grades, from highest to lowest, are AA, A, B, and C. Those grades represent the tire's ability to stop on wet pavement as measured under controlled conditions on specified government test surfaces of asphalt and concrete. A tire marked C may have poor traction performance ⇒ ⚠.

Temperature

The temperature grades are A (the highest), B, and C representing the tire's resistance to the generation of heat, and its ability to dissipate heat when tested under controlled conditions on a specified indoor laboratory test wheel.

Sustained high temperature can cause the material of the tire to degenerate and reduce tire life, and excessive temperature can lead to sudden tire failure.

The grade C corresponds to a level of performance which all passenger car tires must meet under the Federal Motor Vehicle Safety Standard No. 109. Grades B and A represent higher levels of performance on the laboratory test wheel than the minimum required by law ⇒ ⚠.

WARNING

does not include acceleration, cornering, hydroplaning or peak traction characteristics.

WARNING

The temperature grade for this tire is established for a tire that is properly inflated and not overloaded. Excessive speed, underinflation or excessive loading, either separately or in combination, can cause heat buildup and possible tire failure.

Tire Pressure Monitoring System (TPMS)

Introduction to the subject

In this chapter you will find information on the following subjects:

⇒ *Indicator light (telltale)*

⇒ *Tire Pressure Monitoring System (TPMS) and recalibration through the Infotainment system*

Your vehicle's Tire Pressure Monitoring System (TPMS) uses the Anti-lock Brake System (ABS) sensors to indirectly check the tire pressure of all 4 tires while you are driving. The sensors monitor the tread circumference (rolling circumference) and vibration characteristics of the individual tires. TPMS warns if there is a significant loss of pressure in one or more tires while the vehicle is moving. Pressure loss is signaled by the indicator light (described below) as well as by acoustic warnings and text warnings in the instrument cluster display if your vehicle has this display Infotainment system or the Multi-Function Display (MFD).

The original benchmark pressure is the recommended maximum load cold tire inflation pressure for the tires that come with your vehicle. This pressure is listed on the tire pressure label on the driver door jamb ⇒ *Tire inflation pressure*. After adjusting the tire pressures in all 4 tires, you must confirm and store the new cold inflation pressures through the Infotainment system, which changes the benchmark pressure to match the current pressure of the tires on your vehicle ⇒ *Tire Pressure Monitoring System (TPMS) and recalibration through the Infotainment system*.

Recalibrating the TPMS to reset the benchmark cold tire inflation pressure is explained on ⇒ *Tire Pressure Monitoring System (TPMS) and recalibration through the Infotainment system*.

WARNING



sion, serious personal injury or even death.

- When the warning symbol appears in the instrument cluster, stop and inspect the tires.
- Incorrect tire pressure and/or underinflation can cause increased tire wear and can affect the handling of the vehicle and stopping ability.
- Incorrect tire pressures and/or underinflation can also lead to sudden tire failure, including a blowout and sudden deflation, causing loss of vehicle control.
- The driver is responsible for the correct tire pressures for all tires on the vehicle. The recommended tire pressure values are listed on a sticker inside the driver door ⇒ *Tire inflation pressure*.
- The TPMS can only work correctly when all tires on the vehicle are filled to the correct cold tire inflation pressure.
- Using incorrect tire pressure values can cause accidents or other damage. Always inflate the tires to the correct specified cold tire pressure values for the tires installed on the vehicle.
- Always maintain correct cold tire inflation pressure so that TPMS can do its job.
- Always inflate tires to the recommended and correct tire pressure before driving off.
- Driving with underinflated tires causes them to flex (bend) more, letting them get too hot, resulting in tread separation, sudden tire failure, and loss of control.
- Excessive speed and/or overloading can cause heat buildup, sudden tire failure and loss of control.
- If the tire pressure is too low or too high, the tires will wear prematurely and the vehicle will not handle well.
- If the tire is not flat and you do not have to change a wheel immediately, drive carefully and at reduced speed to the nearest service station to check the tire pressure and add air as required.
- When replacing tires or wheel rims on vehicles equipped with TPMS always read and heed the information and all WARNINGS regarding ⇒ *Tires and wheels*.
- The Tire Pressure Monitoring System must be recalibrated whenever you remove and remount or change any wheel or tire on the vehicle, even if the reinstalled or replacement wheels and tires are identical to those that were removed and even if the tire pressure does not change ⇒ *Tire inflation pressure*.

Improper recalibration can cause the TPMS to give false warnings or to give no warning despite dangerously low tire pressure ⇒ [Tire Pressure Monitoring System \(TPMS\) and recalibration through the Infotainment system](#).



Underinflation increases fuel consumption and tire wear.



Do not rely solely on the Tire Pressure Monitoring System. Check your tires regularly to make sure they are properly inflated and have no signs of damage, such as punctures, cuts, cracks, and blisters. Remove any objects that become embedded in the tire tread but have not penetrated into the body of tire itself.



When you take delivery of the vehicle, the Tire Pressure Monitoring System is calibrated for the factory-recommended cold tire inflation pressure for the tires on your vehicle, as shown on the label inside the driver door ⇒ [Tire inflation pressure](#).

- The system must be recalibrated through the Infotainment system whenever you remove and re-mount or change any wheel or tire on the vehicle, even if the reinstalled or replacement wheels and tires are identical to those that were removed and even if the tire pressure does not change ⇒ [Tire Pressure Monitoring System \(TPMS\) and recalibration through the Infotainment system](#).
- If you have to adjust the tire pressure on a warm tire, fill the tire with 2.0 - 4.35 psi (20 - 30 kPa) more than the pressure specified on the tire pressure label inside the driver door ⇒ [Tire inflation pressure](#).
- If the TPMS determines that the air pressure in at least one tire is too low, carefully check the pressure in all 4 tires with an accurate tire pressure gauge. Low tire pressure usually cannot be determined by looking at the tire. This is especially true of low-profile tires.



If you have work done on your wheels or tires, inform the workshop that the vehicle is equipped with a Tire Pressure Monitoring System (TPMS).




New tires may expand slightly the first time they are driven at high speeds, which can trigger a tire pressure warning. Remember that tire pressure can only be properly measured when the tire is cold ⇒ [Tire inflation pressure](#).




Only replace old tires with tires that have been approved by Volkswagen for your vehicle type.


Indicator light (telltale)



Read and follow the introductory information and safety information first ⇒  [Introduction to the subject](#)

Lights up Possible cause or meaning ⇒  Proper response

Lights up and a chime may also sound.

 Stop safely as soon as possible!




The inflation pressure of one or more tires is significantly lower than the benchmark pressure set by the driver or a tire has

Reduce speed immediately! Avoid fast cornering and hard braking!

structural damage. Depending on vehicle equipment, a message may also appear in the instrument cluster display.

Check the condition and inflation pressure of all tires. Have damaged tires replaced.

Flashes Possible cause or meaning ⇒  Proper response



Flashes for about 70 seconds and then stays on:

System malfunction.


Check and, if necessary, adjust the tire inflation pressure in all 4 tires. If the tire pressure is correct, switch the ignition off and back on.

If the indicator light flashes again and then stays on or does not go out after checking and adjusting the air pressure in all 4 tires and recalibrating, take the vehicle to an authorized Volkswagen dealer or an authorized Volkswagen Service Facility. Have the system checked.

When the ignition is switched on, several warning and indicator lights come on briefly for a function check. They go out after a few seconds.

WARNING

Incorrect tire pressures and/or underinflation can cause sudden tire failure, loss of control, collision, serious personal injury, or even death.

- When the warning symbol  appears in the instrument cluster, stop the vehicle as soon as it is safe to do so and inspect all tires.
- Incorrect tire pressure and/or underinflation can cause increased tire wear and can affect the handling of the vehicle and its stopping ability.
- Incorrect tire pressure and/or underinflation can also lead to sudden tire failure, including a blowout and sudden deflation, causing loss of vehicle control.
- The driver is responsible for the correct tire pressures for all tires on the vehicle. The recom-



sure.

- The TPMS can only work correctly when all tires on the vehicle are filled to the correct cold tire inflation pressure. Always maintain the correct cold tire inflation pressure so that TPMS can do its job.
- Using incorrect tire pressure values can cause accidents or other damage. Check the pressure in all 4 tires when the tires are still cold. Never reduce air pressure in warm tires to match cold tire inflation pressure.
- Always inflate the tires to the correct specified cold tire pressure values for the tires installed on the vehicle; see the tire inflation pressure label on the driver door jamb ⇒ [Tires and wheels](#).
- Always inflate tires to the recommended and correct tire pressure before driving off.
- Driving with underinflated tires causes them to flex (bend) more, letting them get too hot, which can result in tread separation, sudden tire failure, and loss of control.
- Excessive speed and/or overloading can cause heat buildup, sudden tire failure, and loss of control.
- If the tire pressure is too low or too high, the tires will wear prematurely and the vehicle will not handle well.
- If the tire is not flat and you do not have to change the tire or wheel immediately, drive at reduced speed to the nearest service station to check the tire pressure and add air as required.
- When replacing tires or wheel rims on vehicles equipped with TPMS, always read and heed the information and all WARNINGS in the section ⇒ [Tires and wheels](#).
- The Tire Pressure Monitoring System must be recalibrated whenever you remove and remount or change any wheel or tire on the vehicle, even if the reinstalled or replacement wheels and tires are identical to those that were removed and even if the tire pressure does not change ⇒ [Tire Pressure Monitoring System \(TPMS\) and recalibration through the Infotainment system](#).

WARNING

Improper recalibration can cause the TPMS to give false warnings or to give no warning despite dangerously low tire pressure ⇒ [Tire Pressure Monitoring System \(TPMS\) and recalibration through the Infotainment system](#).



Failure to heed warning lights and instrument cluster text messages can cause the vehicle to break down in traffic and result in a collision and serious personal injury.

- Never ignore warning lights or text WARNINGS.
- Always stop the vehicle as soon as it is safe to do so.

NOTE

Failure to heed warning lights or text WARNINGS can result in vehicle damage.




If the ignition is switched on, an acoustic warning sounds when low tire pressure is detected. An acoustic warning also sounds if a system malfunction is detected.



Driving for a longer period of time on rough roads or with a dynamic and sporty style can make the TPMS system temporarily unavailable. The indicator light will come on, signaling a malfunction, but will go out again once the road condition or driving style changes.

Tire Pressure Monitoring System (TPMS) and recalibration through the Infotainment system



Read and follow the introductory information and safety information first ⇒  [Introduction to the subject](#)


Your vehicle's Tire Pressure Monitoring System (TPMS) indirectly checks the tire pressure of all 4 tires while you are driving by using the Anti-lock Brake System (ABS) sensors to monitor the tread circumference (rolling circumference) and vibration characteristics of the individual tires.

The tread circumference of a tire can change:

- If a tire's inflation pressure is too low.
- If the tire's tread is damaged or the tire is structurally damaged.
- If one side of the vehicle is more heavily loaded than the other.



- If a compact spare wheel has been mounted.
- If a wheel was replaced on each axle.
- If a tire was changed.
- If the tire pressure was changed, or wheels were rotated or replaced, but the TPMS was not reset.
- If there are snow chains on the tires. Using snow chains can cause the system to give false warnings because snow chains increase tire circumference.

The Tire Pressure Monitoring System (TPMS)  may not react at first or may not react at all when you are driving in a sporty manner, or on snow-covered or unpaved roads, when you are driving with snow chains, or in certain other situations. A change in the tread circumference of a tire is signaled by the Tire Pressure Monitoring System indicator in the instrument cluster (telltale).

The tire pressure recommended for the tires originally installed on the vehicle is on a sticker on the driver door jamb ⇒ [Tires and wheels](#).

Each tire, including the spare (if provided), should be checked monthly when cold and inflated to the inflation pressure recommended by the vehicle manufacturer on the vehicle placard or tire inflation pressure label. (If your vehicle has tires of a different size than the size indicated on the vehicle placard or tire inflation pressure label, you should determine the proper tire inflation pressure for those tires.)

As an added safety feature, your vehicle has been equipped with a Tire Pressure Monitoring System (TPMS) that illuminates a low tire pressure telltale when one or more of your tires is significantly underinflated. Accordingly, when the low tire pressure telltale illuminates, you should stop and check your tires as soon as possible, and inflate them to the proper pressure. Driving on a significantly underinflated tire causes the tire to overheat and can lead to tire failure. Underinflation also reduces fuel efficiency and tire tread life, and may affect the vehicle's handling and stopping ability.

Please note that the TPMS is not a substitute for proper tire maintenance, and it is the driver's responsibility to maintain correct tire pressure, even if underinflation has not reached the level to trigger illumination of the TPMS low tire pressure telltale.

Your vehicle has also been equipped with a TPMS malfunction indicator to indicate when the system is not operating properly. The TPMS malfunction indicator is combined with the low tire pressure telltale. When the system detects a malfunction, the telltale will flash for approximately one minute and




as long as the malfunction exists.

When the malfunction indicator is illuminated, the system may not be able to detect or signal low tire pressure as intended. TPMS malfunctions may occur for a variety of reasons, including the installation of replacement or alternate tires or wheels on the vehicle that prevent the TPMS from functioning properly. Always check the TPMS malfunction telltale after replacing one or more tires or wheels on your vehicle to ensure that the replacement or alternate tires and wheels allow the TPMS to continue to function properly.

Resetting and recalibrating the benchmark tire pressure

Resetting the tire pressures in the Infotainment system resets the benchmark tire pressure used by the TPMS to the current tire pressure in the tires based on the circumference of the tires.

- Switch on the ignition.
- Press the **CAR** Infotainment button ⇒ *Menu and system settings*.
- Tap the  function key to open the Vehicle settings menu.
- Tap the Tires function key.
- Tap the SET function key in the Tire Pressure Monitoring System menu.
- If all 4 wheels are set to the correct values, touch the Confirm function key to store the tire pressures.
- Touching the Cancel button will prevent the current tire pressures from being stored and the system will not be recalibrated.

The recalibration must be performed each time the tire pressure in one or more tires has been adjusted or after one or more tires has been changed, exchanged, or repaired. The new tire pressures are stored in the system only after at least 20 minutes of normal driving.

If you have reset the benchmark tire pressure when your tires do not have the correct tire pressure, this will prevent the TPMS from working properly. It may then give false warnings or may not give any warning even if the tire pressure is too low.

For this reason, it is vital to make certain that all 4 tires are inflated to the correct pressure when they are cold before calibrating the system. Cold tire tires are tires that have not been driven more than a couple of miles (kilometers) at low speed within the last 3 hours.



pressures. The calibrated values are stored and monitored after a long journey at various speeds.

If the wheels are loaded more heavily than normal, for example, if the vehicle is carrying heavy load, the tire pressure must be raised to the recommended full-load tire pressure before recalibration
⇒ [Tires and wheels](#).

Recalibrate the system to reset the benchmark TPMS pressure in the following situations:

- After installing tires on your vehicle that have recommended cold tire inflation pressures that are different from the tires that were taken off.
- After any tire on your vehicle is removed and then remounted, even if the same tire and wheel rim that were taken off are reinstalled (for instance, after repair).
- After any tire on your vehicle is changed and replaced by another tire, even if the replacement tire is the same type and is inflated to the same pressure as the tire it replaced.
- After adjusting the tire pressure of any tire on the vehicle to its correct cold tire inflation pressure, either by putting air in one or more tires or by letting air out. Do this even though air was only added (or let out) to bring the tire to the inflation pressure it should have had all along.
- After rotating the front and rear wheels ⇒ [Tires and wheels](#).
- After mounting the compact spare wheel.

WARNING

Incorrect recalibration can cause the TPMS to give false warnings or to give no warning despite dangerously low tire pressure. Make certain the tire inflation pressure of all tires is correct before recalibrating the system.

WARNING

Incorrect tire pressure can cause sudden tire failure, loss of vehicle control and serious personal injury.

- Always check and correct air pressure in all 4 tires, particularly after changing, exchanging, or repairing tires.
- After that, always make sure that all 4 tires are inflated to the correct tire pressure for the tires



sure in the tire.

- See the tire pressure label ⇒ [Tire inflation pressure](#) and the Owner's Literature for recommended cold tire inflation pressure and other important information.
- When replacing tires or wheel rims, always read and heed all of the information and WARNINGS ⇒ [Tires and wheels](#).
- The Tire Pressure Monitoring System must be recalibrated whenever you remove and remount or change any wheel or tire on the vehicle, even if the reinstalled or replacement wheels and tires are identical to those that were removed and even if the tire pressure does not change.



The Tire Pressure Monitoring System stops working if there is an ESC/ABS malfunction ⇒ [Braking and parking](#).



After a low tire pressure warning, the vehicle must stand and must not be driven for at least 1 minute before the new benchmark tire pressures can be stored.

Storage and equipment

Storage areas



Introduction to the subject

In this chapter you will find information on the following subjects:

⇒ [Storage compartments in the doors](#)

⇒ [Storage compartment on the driver side](#)

⇒ [Eyeglass storage compartment in the overhead console](#)

⇒ [Storage compartment in the front center console](#)

⇒ [Coin holders in the front center console \(Golf, Golf GTI\)](#)





⇒ *Glove compartment*

⇒ *Storage compartment under the front seat*

⇒ *Other storage compartments*

Store only lightweight or small objects in storage compartments.

Depending on options, there may be a factory-installed AUX-in jack  and/or USB port  in the front center console storage compartment.

WARNING

Loose objects can be thrown around the inside of the vehicle when the vehicle is moving, especially during sudden maneuvers and hard braking. This can cause serious personal injuries and even make the driver lose control of the vehicle.

- Never let animals ride in the vehicle's open storage compartments, on top of the instrument panel, or on the luggage compartment cover behind the rear seat backrests.
- Never put hard, heavy or sharp objects in these places or in articles of clothing or bags in the passenger compartment.
- Always keep storage compartments closed while driving.

WARNING

Objects in the driver footwell can prevent the pedals from moving freely. This can cause loss of vehicle control and increase the risk of serious personal injuries.

- Always make sure that nothing can interfere with the pedals.
- Always fasten floor mats securely to the floor.
- Never put floor mats or other floor coverings on top of already installed floor mats.
- Always make sure that nothing can fall into the driver footwell while the vehicle is moving.

WARNING

in serious burns and vehicle damage.

- Always make sure that there are no lighters in the seat tracks or near other moving parts before adjusting the seats.
- Before closing a storage compartment, always make sure that no cigarette lighter can be activated, crushed, or otherwise damaged.
- Never leave a cigarette lighter in a storage compartment, on the instrument panel, or in other places in the vehicle. Heat buildup in the passenger and luggage compartment of a parked vehicle can result in temperatures in the vehicle that are much higher than the outside temperatures, particularly in summer. High temperatures could cause the cigarette lighter to catch fire.

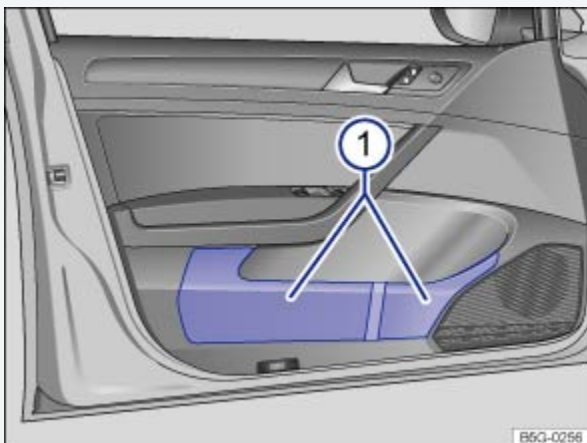
NOTE

- The defroster heating wires or antenna in the rear window can be damaged by hard or sharp things on the shelf below the rear window.
- Do not keep any food, medicine, or other items sensitive to heat or cold in the vehicle. They can be damaged or made unusable by heat or cold.
- Things that are made of transparent materials (such as eyeglasses, magnifying glasses, or transparent suction cups on the windows) can magnify sunlight and damage the vehicle.



The ventilation slots in the luggage compartment must not be blocked so that stale air can escape from the vehicle.

Storage compartments in the doors



Read and follow the introductory information and safety information first ⇒ [Introduction to the subject](#)

There is a storage compartment in each vehicle door ⇒ [Fig. 117](#).

Storage compartment on the driver side



[Fig. 118](#) On the driver side: Storage compartment.

Read and follow the introductory information and safety information first ⇒ [Introduction to the subject](#)

To *open* the compartment, pull the handle ⇒ [Fig. 118](#) in the direction of the arrow.

To *close*, push the lid up until it latches.




On some vehicles, there is a holder for SD cards on the inside of the storage compartment lid.

Eyeglass storage compartment in the overhead console



Fig. 119 In the overhead console: Storage compartment.



Read and follow the introductory information and safety information first ⇒  *Introduction to the subject*

Your vehicle may have a storage compartment that can be used for storing eyeglasses or other light objects.

To *open*, briefly press and release the button ⇒ *Fig. 119* (arrow) on the storage compartment cover.


To *close*, push the lid up until it latches.

Storage compartment in the front center console



Fig. 120 In the front center console: Storage compartment.



Read and follow the introductory information and safety information first ⇒  *Introduction to the subject*

To *open*, briefly press the lower edge of the cover in the direction of the arrow ⇒ *Fig. 120*.

To *close*, press the lid down completely.

The storage compartment in the front center console may have an AUX-in jack and/or a USB port ⇒ Booklet *Infotainment System*.

Coin holders in the front center console (Golf, Golf GTI)



Fig. 121 In the front center console: Coin holders.



Read and follow the introductory information and safety information first ⇒ *Introduction to the subject*

Depending on equipment, the lower part of the front center console ⇒ Fig. 121 may have slots for storing coins.

Storage compartment in the front center armrest (Golf, Golf GTI)



Fig. 122 In the front center armrest: Storage compartment.



Read and follow the introductory information and safety information first ⇒ *Introduction to the subject*

Depending on equipment, your vehicle may have a storage compartment under the front center armrest.

To *open*, push the release button (small arrow) and lift the center armrest up as far as it will go in the direction of the large arrow ⇒ [Fig. 122](#).

To *close*, push the center armrest down.

WARNING

The center armrest can restrict the driver's arm movement and cause crashes and serious personal injury.

- Always keep storage compartments in the center armrest closed while driving.

WARNING

Never let a passenger, especially a child, ride on the center armrest.



There may be a 12 volt socket ⇒ [Power outlets](#) or a phone holder in the front center armrest storage compartment ⇒ [Booklet Infotainment System](#),.

Glove compartment



[Fig. 123](#) On the passenger side: Glove compartment.

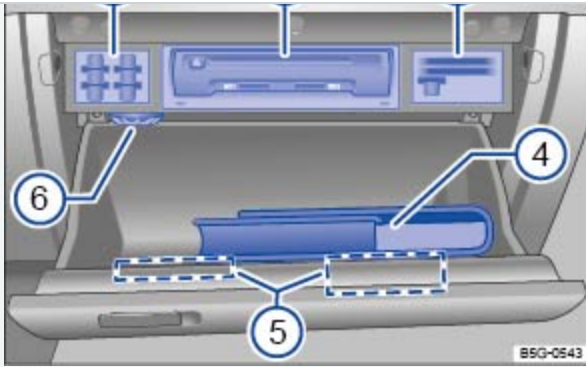


Fig. 124 Inside the glove compartment.



Read and follow the introductory information and safety information first ⇒ [Introduction to the subject](#)

Key to ⇒ [Fig. 124](#) :

- ① SD card holders
- ② Infotainment system accessories (if equipped) ,Chapter *Infotainment System*
- ③ Card holders and coin holder
- ④ Owner's Manual
- ⑤ Additional holders for coins, cards, or sunglasses
- ⑥ Air vent ⇒ [Heating and air conditioning](#)

Opening and closing the glove compartment

To *open*, pull the handle ⇒ [Fig. 123](#) .

To *close*, push the lid up.

Infotainment system accessories

Vehicles equipped with an Infotainment system may have a CD player, SD card readers, or other Infotainment System accessories ⇒ [Fig. 124](#) in the glove compartment. See ,Chapter *Infotainment System* for further information.

Owner's Manual

If the vehicle is not equipped with an Infotainment system, there is a slot for the Owner's Manual in



compartment as shown in [Fig. 124](#).

Holders

Depending on vehicle equipment, there may be holders for SD cards [⇒ Fig. 124](#), other types of cards ^③, and a coin holder in the upper part of the glove compartment.

There may also be additional holders for coins, cards, or sunglasses in the glove compartment cover ^⑤.

Cooling the glove compartment

There is an air vent [⇒ Fig. 124](#) in the glove compartment. Cool air can be directed into the glove compartment if the air conditioner is on. Open or close the air vent by turning it.

WARNING

An open glove compartment door can increase the risk of serious injury during sudden braking or driving maneuvers or in a crash.

- Always keep the glove compartment closed while the vehicle is moving.



[Purchase Owner's Literature](#)

[Terms](#)

[Privacy](#)

* This Online Owner's Manual may not include Supplements issued after the publication of the physical Owner's Manual. Please consult your physical Owner's literature. In the event of a discrepancy between the Online Owner's Manual and physical Owner's literature, the physical Owner's literature controls.

"Volkswagen" and the Volkswagen logo are registered trademarks of Volkswagen AG. © 2018 Volkswagen of America, Inc.

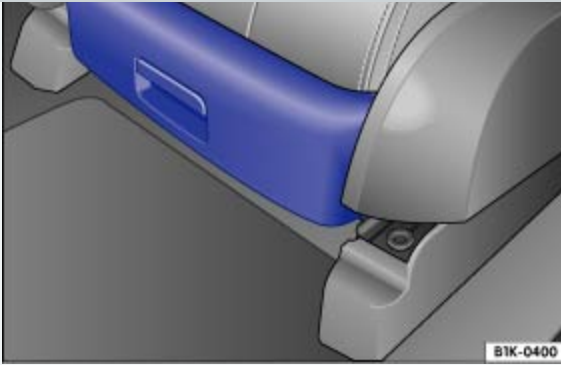


Fig. 125 Under the driver seat: Storage compartment.



Read and follow the introductory information and safety information first ⇒ [Introduction to the subject](#)

Some vehicles are equipped with a storage compartment ⇒ [Fig. 125](#) under the driver or passenger seat. A first aid kit can be stored in this storage compartment.

Opening and closing the storage compartment

To *open*: Grasp the opening handle and pull the storage compartment out.

To *close*: Push the storage compartment toward the seat until it engages securely.

WARNING

An open storage compartment can interfere with the pedals and cause accidents and severe personal injuries.

- Always keep the storage compartment closed when the vehicle is moving. Otherwise, the storage compartment cover and other objects could get into the driver footwell and interfere with the pedals.

Other storage compartments

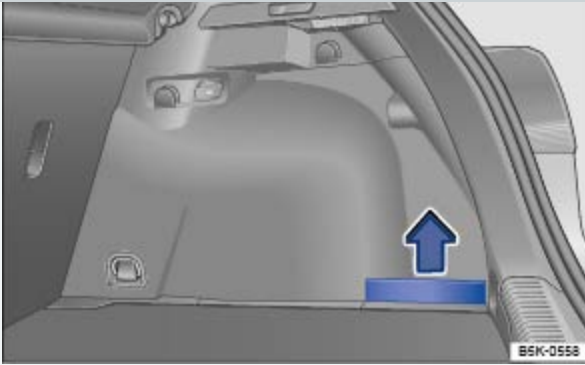


Fig. 126 In the luggage compartment: Side storage compartment.



Read and follow the introductory information and safety information first ⇒ [Introduction to the subject](#)

Storage compartments in the luggage compartment

Additional storage compartments are located in the sides of the luggage compartment. The side panels can be removed by pulling upward in the direction of the arrow ⇒ [Fig. 126](#) to make room for larger objects in the luggage compartment.

The vehicle tool kit may be stored in this compartment ⇒ [Vehicle tool kit](#).

Additional storage

- In the center console.
- Pockets in the backrests of the front seats (if equipped).
- Luggage compartment cover behind the rear seat backrest – only for light clothing or similar objects that do not interfere with visibility to the rear!
- Coat hooks on the center door pillars (4-door vehicles only) and on the overhead grab handles in the rear.

WARNING

Clothes or other items on the luggage compartment cover behind the rear seat backrest may limit visibility and cause accidents and severe personal injuries.

- Always hang clothes so that they do not limit visibility.
- Always use the built-in coat hooks only for lightweight clothing. Never leave any heavy or



personal injury in a collision.

NOTE

The maximum load for each coat hook is 5 lbs. (2.5 kg).

Cup holders



Introduction to the subject


In this chapter you will find information on the following subjects:

⇒ *Cup holders in the front center console*

⇒ *Cup holders in the rear center armrest*

⇒ *Cup holders in the rear trim*

Bottle holders

There is a place for bottles in the open compartments in the driver and passenger doors. The bottle volume must not exceed 16.9 oz (0.5 liter) ⇒  .

WARNING

Improper use of beverage holders can cause injuries.

- Never put hot drinks in the cup holders. During normal or sudden maneuvers, sudden braking or in a collision, hot liquid can be spilled and cause burns!
- Make certain that bottles or other items cannot fall into the driver's footwell while the vehicle is moving and interfere with the movement of the pedals.
- Never put heavy cups, food or other heavy items in the cup holders. Heavy items can fly through the passenger compartment in a crash and cause serious injury.

WARNING

Hot or freezing temperatures in the passenger compartment can cause closed bottles to explode

- Never leave closed bottles in a very hot or cold vehicle.

WARNING

Bottles and other things can fall into the driver's footwell and interfere with the pedals while driving.

- Make sure that bottles cannot fall into the driver's footwell during driving to avoid obstructing the pedals.
- Use the bottle holders only for standard beverage bottles holding no more than 16.9 oz (0.5 liter).

NOTE

Never put open drinks in the cup holders when the vehicle is moving. The drinks can spill and damage the vehicle, including the electrical system.



Some cup holder inserts can be removed for cleaning.

Cup holders in the front center console

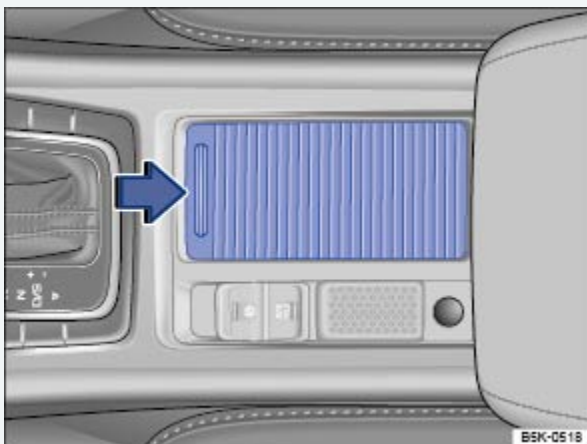



Fig. 127 In the front center console: Opening the cup holder cover (if equipped).



Fig. 128 In the front center console: Cup holders (without a cover).



Read and follow the introductory information and safety information first ⇒  *Introduction to the subject*

Some models are equipped with a cover for the cup holders.

To *open*, pull the cover to the rear ⇒ *Fig. 127* (arrow).

To *close*, push the cover forward (opposite direction of the arrow).

For vehicles without a cover, place the drink in the cup holder ⇒ *Fig. 128*.

Cup holders in the rear center armrest

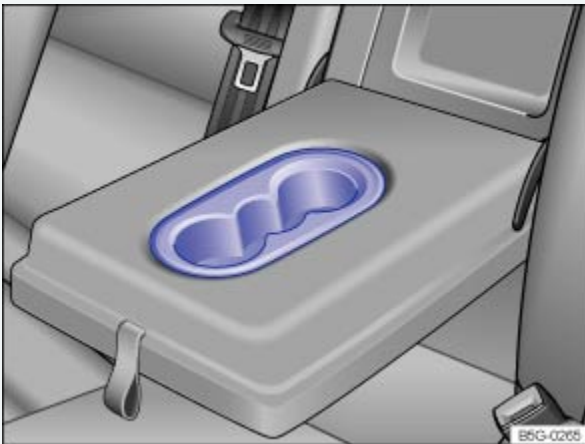


Fig. 129 Cup holders in the rear center armrest (version 1).

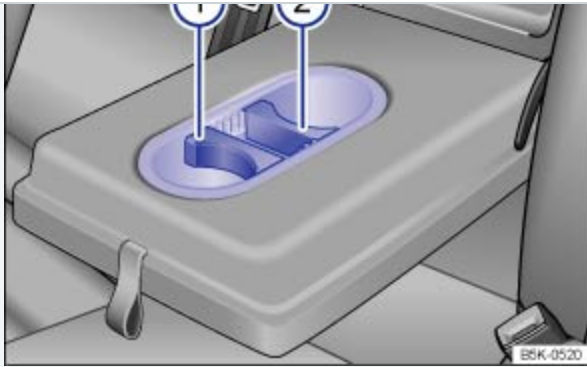



Fig. 130 Cup holders in the rear center armrest (version 2).



Read and follow the introductory information and safety information first ⇒  [Introduction to the subject](#)

Your vehicle may be equipped with cup holders in the rear center armrest.

To *open*, fold the center armrest down.

Some cup holders have inserts that can be positioned to hold beverages of different sizes ⇒ [Fig. 130](#). To *adjust* the cup holder to the size of the cup, pull the inserts ① or ② upward and reposition them to fit the size of the cup.

To *close*, fold the center armrest up.

WARNING

Always keep the armrest folded up when the vehicle is moving to reduce the risk of injury.

- Never let anybody, especially children, ride on the rear center armrest or in the center position on the rear seat when the armrest is folded down. An improper seating position can increase the risk of serious injury in a crash.



Some cup holder designs allow you to adjust to the size of the cup by turning the inserts 180 degrees.

Cup holders in the rear trim

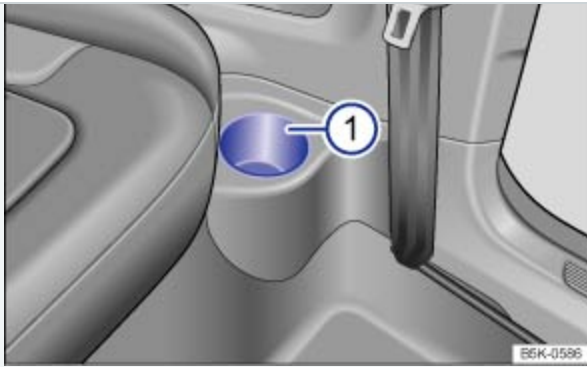




Fig. 131 In the trim next to the rear seats (2-door models only): Cup holder.



Read and follow the introductory information and safety information first ⇒  *Introduction to the subject*

Some 2-door vehicles are equipped with open cup holders in the trim next to the rear seats
⇒ *Fig. 131* .

Power outlets



Introduction to the subject

In this chapter you will find information on the following subjects:

⇒ *12 Volt sockets in the vehicle*

Electrical devices can be connected to the vehicle 12 Volt sockets.

The connected devices must be in good working order.

WARNING

Improper use of electrical sockets and electrical devices may start a fire and cause severe personal injury.

- Never leave children unattended in the vehicle. Sockets and connected devices can be used when the ignition is switched on.
- If the connected device gets warm, immediately switch it off and disconnect the power supply.

- To help prevent damage to the electrical system, never connect any accessories such as a solar panel or vehicle battery charger to a 12 Volt socket.
- Only use accessories which have been tested for electromagnetic compatibility with a motor vehicle.
- To help prevent damage from voltage fluctuations, switch off all electrical consumers connected to the 12 Volt socket before switching the ignition on or off or starting the engine.
- Never connect devices to a 12 Volt socket that draw more than the maximum wattage the socket can supply. Drawing too much power can damage the vehicle electrical system.

Please turn off the engine when you stop for any length of time.



The vehicle battery will drain if you use electrical equipment when the engine is not running.



Unshielded devices may interfere with radio reception or the vehicle's electrical system.



Operating electrical devices near the windshield-integrated antenna may interfere with AM radio reception.

12 Volt sockets in the vehicle



Fig. 132 In the lower center console: 12 Volt socket (vehicles with parking brake lever).

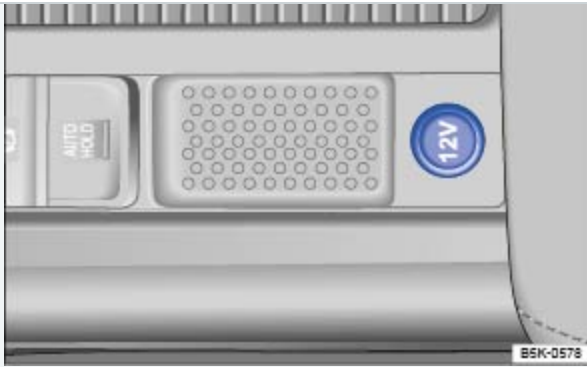


Fig. 133 In the lower center console: 12 Volt socket (vehicles with electronic parking brake).




Read and follow the introductory information and safety information first ⇒ [Introduction to the subject](#)

Maximum power draw

Socket Maximum power draw

12 Volts 120 watts

The maximum power draw at any one socket must never be exceeded. Electrical devices should have information on them that says how much power they draw.

If 2 or more electrical devices are connected at the same time, the total power draw of all connected devices must never be more than 190 watts ⇒ .

12 Volt socket

The 12 Volt socket works only when the ignition is switched on.

If the ignition is on but the engine is not running, the vehicle battery will be drained by any device that is plugged in and turned on. For this reason, never use the electrical sockets unless the engine is running.

To help prevent damage from voltage fluctuations, switch off all electrical devices connected to a 12 Volt socket before switching the ignition on or off or starting the engine.

The vehicle may have 12 Volt sockets at the following places:



- In the luggage compartment.
- In the front center armrest storage compartment ⇒ *Storage compartment in the front center armrest (Golf, Golf GTI)*.

NOTE

- Follow the manufacturer's instructions for connected devices!
- Never exceed the maximum power consumption, or the entire vehicle electrical system may be damaged.
- 12 Volt socket:
 - Only use equipment that has been tested for electromagnetic compatibility and complies with applicable guidelines.
 - Never feed current into the socket, with a solar panel, for example.



Unshielded devices may interfere with radio reception or the vehicle's electrical system.



Owner's manual
Owner's Manual
Edition: 12.2016
ID: 5GM012723AL

While driving

Vehicle operation

Starting and stopping the engine



Introduction to the subject

In this chapter you will find information on the following subjects:

⇒ *Indicator lights*

⇒ *Vehicle key positions in the ignition switch*

⇒ *Starter button*

⇒ *Starting the engine*

⇒ *Stopping the engine*

⇒ *Electronic immobilizer*

Explanatory notes in this section regarding automatic transmissions also apply to the DSG[®] automated transmission.

Immobilizer display

If an unauthorized vehicle key is used or the system malfunctions, a message may appear in the instrument cluster display. The engine cannot be started.

Push-starting and tow-starting



while following proper and safe procedures.

WARNING

Switching off the engine while the vehicle is moving can make the vehicle harder to stop and result in loss of vehicle control, leading to collisions and severe personal injuries.

- Brake and steering assistance systems, the airbag system, safety belt pretensioners, and other vehicle safety features only work when the engine is running.
- Switch off the engine only when the vehicle is not moving.

WARNING

To reduce the risk of serious personal injury when starting and running the vehicle's engine:

- Never start the engine or let it run in a confined or enclosed area. Engine exhaust contains carbon monoxide, a poisonous, colorless, and odorless gas. Carbon monoxide can cause unconsciousness and death.
- Never start the engine or let it run if oil, fuel, or other flammable substances are under, around, or have leaked from the vehicle, for example, due to vehicle damage.
- Never leave the vehicle unattended with the engine running, especially when it is in gear. The vehicle could move suddenly or some other unexpected event could occur, resulting in property damage, fire, or personal injury.
- Never use starting assist fluids. Starting fluids can explode and can cause a run-away vehicle condition.

WARNING

To reduce the risk of serious personal injury when you leave the vehicle.

- Always switch off the engine and ignition and take the key with you when you leave the vehicle. Never let the engine run in a confined or enclosed area. Engine exhaust contains carbon monoxide, a poisonous, colorless, and odorless gas. Carbon monoxide can cause unconsciousness and death.

The vehicle exhaust system and the catalytic converter get very hot. They can cause fires and serious personal injury.

- Never park the vehicle where the hot exhaust system or catalytic converter could ignite flammable materials, such as brush, leaves, dry grass, spilled fuel, etc.
- Never apply additional undercoating or rustproofing on or near the exhaust manifold, exhaust pipes, catalytic converter, or heat shields.

Indicator lights



Read and follow the introductory information and safety information first ⇒ [Introduction to the subject](#)

Lights up Possible cause

Proper response



Brake pedal not depressed.

Apply the brake pedal to start the engine

⇒ [Braking and parking](#).

Flashes Possible cause

Proper response



The release button in the selector lever did not engage. Vehicle movement is prevented. ⇒ [Automatic Shift Lock \(ASL\)](#).

Engage the selector lever release button

When the ignition is switched on, several warning and indicator lights come on briefly for a function check. They go out after a few seconds.

WARNING

Failure to heed warning lights and instrument cluster text messages can cause the vehicle to break down in traffic and result in a collision and serious personal injury.

- Never ignore warning lights or text WARNINGS.

- Whenever stalled or stopped for repair, move the vehicle a safe distance off the road, turn on the emergency flashers, stop the engine, and use other warning devices to warn approaching traffic.

NOTE

Failure to heed warning lights or text WARNINGS can result in vehicle damage.

Vehicle key positions in the ignition switch



Fig. 134 In the ignition switch: Vehicle key positions.



Read and follow the introductory information and safety information first ⇒ [Introduction to the subject](#)

If there is no vehicle key in the ignition, the steering column is locked.

Vehicle key position ⇒ [Fig. 134](#)

- ① Ignition switched off. Steering column lock engaged. The vehicle key can be removed.
- ① Ignition is switched on. Steering column lock can be released.
- ② Start the engine. When the engine starts, release the vehicle key. When released, the vehicle key returns to position ①.


If you use the wrong key

If an unauthorized vehicle key has been inserted into the ignition switch, it can be removed as follows:

- *Automatic transmission:* Press the release button on the transmission selector lever and release. The vehicle key can now be removed.



If you leave the ignition on

If you leave the ignition on and open the driver door, a warning message may appear in the instrument cluster. In addition, you may also hear an acoustic warning. This warning reminds you to switch off the ignition before leaving the vehicle ⇒ .

WARNING

Improper use of vehicle keys can result in serious personal injury.

- Always switch off the engine and the ignition and take the key with you when you leave the vehicle. The engine can be started and vehicle systems such as the power windows can be operated, leading to serious personal injury.
- Never leave children, disabled persons, or anyone who cannot help themselves in the vehicle. The doors can be locked with the remote control vehicle key. This could result in people being trapped in the vehicle in an emergency. For example, depending on the time of year, people trapped in the vehicle can be exposed to very high or very low temperatures.
- Heat buildup in the passenger and luggage compartment of a parked vehicle can result in temperatures in the vehicle that are much higher than the outside temperatures, particularly in summer. Temperatures can quickly reach levels that can cause unconsciousness and death, particularly to small children.
- Never remove the key from the ignition switch while the vehicle is moving or rolling to a stop. The steering wheel will lock and you will not be able to steer or control the vehicle.
- Only attach lightweight objects to the remote control vehicle key that weigh no more than a combined total of 3.5 oz (100 g).

NOTE

Leaving the key in the ignition for a long time when the engine is not running will drain the vehicle battery.

- Always switch off the ignition before leaving the vehicle.



Leaving the selector lever for a long period of time in any position other than Park (P) when the



On automatic transmission vehicles , the vehicle key can be removed from the ignition switch only when the transmission is in Park (P). You may have to press the release button on the transmission selector lever to put the lever into Park (P).

Starter button



Fig. 135 In the lower center console: Starter button for the Keyless Access system.

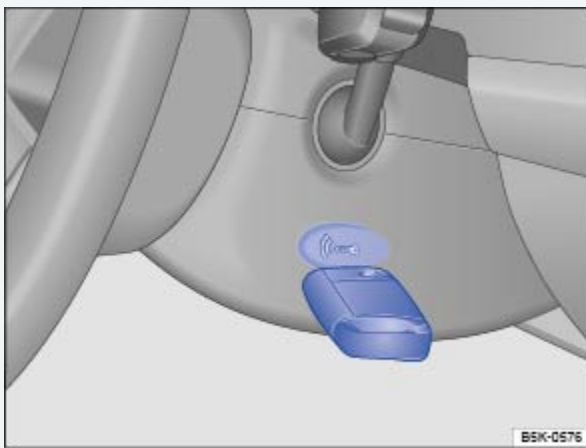


Fig. 136 Hold the remote control vehicle key to the right of the steering column: Emergency starting feature.



Read and follow the introductory information and safety information first ⇒ [Introduction to the subject](#)


On appropriately equipped vehicles, the vehicle can be started and stopped with the starter button in the lower center console ⇒ [Fig. 135](#).

The starter button can only be used when an authorized vehicle key is in the vehicle.



switched off and the driver door is opened ⇒ *Steering* .

Switching the ignition on and off

- Briefly press the starter button once without operating the brake or clutch pedals ⇒  .


Emergency start feature

If you push the starter button while an authorized remote control vehicle key is in the passenger compartment, but a driver information message appears in the instrument cluster indicating that the vehicle key is not detected, the remote control vehicle key battery is weak or dead. You can still start the engine using the Emergency start feature.

- Make sure the selector lever is in the Park (P) position.
- Hold the remote control vehicle key to the right of the steering column trim immediately after pressing the starter button ⇒ *Fig. 136* .
- The ignition automatically switches on and the engine starts.

Emergency shut-off

If the engine does not switch off by briefly pressing the starter button, emergency shut-off is necessary:

- Press the starter button twice within 3 seconds or press and hold the button longer than 1 second ⇒  .
- The engine switches off automatically.

If no authorized remote control vehicle key is identified in the passenger compartment after the engine has been switched off, the engine cannot be restarted. A related message is shown in the instrument cluster display.

WARNING

Unintended vehicle movement can cause serious personal injury.

- Do *not* depress the brake or clutch pedals when switching on the ignition, as the engine could otherwise start immediately.



Improper use of vehicle keys can result in serious personal injury.

- Always switch off the engine and the ignition and take the key with you when you leave the vehicle. Children or unauthorized persons may use it to lock the vehicle, start the engine, and operate vehicle systems such as the power windows, leading to serious personal injury.
- Never leave children, disabled persons, or anyone who cannot help themselves in the vehicle. The doors can be locked using the remote control vehicle key. This could result in people being trapped in the vehicle in an emergency. For example, depending on the time of year, people trapped in the vehicle can be exposed to very high or very low temperatures.
- Heat buildup in the passenger and luggage compartment of a parked vehicle can result in temperatures in the vehicle that are much higher than the outside temperatures, particularly in summer. Temperatures can quickly reach levels that can cause unconsciousness and death, particularly to small children.



If the ignition is switched on or the engine is running and the driver door is opened, a chime sounds. The chime is also a reminder to switch off the engine and turn off the ignition before leaving and locking the vehicle from the outside.



Leaving the ignition on for a long time when the engine is not running will drain the vehicle battery and the engine may not start.


- Always switch off the ignition before leaving the vehicle.



Always switch off the ignition before leaving the vehicle. Read and follow any information in the instrument cluster display.

Starting the engine



Read and follow the introductory information and safety information first ⇒  [Introduction to the subject](#)

Please perform these steps only in the order listed.



1.	Depress the brake pedal and hold it down until step 5 is completed.	
1 a.	Manual transmission: Fully depress clutch pedal and hold until the engine has started.	
2.	Make sure the transmission is in Park (P) or Neutral (N).	
3.	Turn the vehicle key to position ⇒ Fig. 134 – do not depress the accelerator pedal.	Briefly press the starter button ⇒ Fig. 135 – do not depress the accelerator pedal. An authorized vehicle key must be inside the vehicle in order to start the engine.
4.	When the engine starts, release the vehicle key.	When the engine starts, release the starter button.
5.	If the engine does not start, switch off the ignition and start again after about 1 minute.	If the engine does not start, switch off the ignition and start again after about 1 minute. Use the emergency start feature if necessary ⇒ Emergency start feature .
6.	Release the parking brake when you are ready to start driving ⇒ Braking and parking .	

 **WARNING**

Never leave the vehicle unattended with the engine running, especially when it is in gear. The vehicle could move suddenly or some other unexpected event could occur, resulting in property

WARNING

Starting fluids can explode and can cause a run-away vehicle condition.

- Never use starting assist fluids.

NOTE

- You can damage the starter or the engine if you try to start the engine when the vehicle is still moving, or if you try to restart the engine right after switching it off.
- Avoid high engine speeds, full throttle acceleration, and heavy engine loads when the engine is cold.
- Do not try to start the engine by pushing or towing the vehicle. Unburned fuel can get into the catalytic converter and damage it. The steering column may also be locked.



Do not let your vehicle warm up while standing; instead, start driving right away after making sure that you have good visibility through all windows. This will help the engine reach operating temperature faster and keep down emissions.



Major consumers of electricity are temporarily switched off when the engine is being started.



After starting a cold engine, there may be increased operating noises for a few seconds. This is normal and harmless.

Stopping the engine



Read and follow the introductory information and safety information first ⇒ [Introduction to the subject](#)

Please perform these steps only in the order listed.

Step	Vehicles without Keyless Access	Vehicles with Keyless Access
------	---------------------------------	------------------------------



Step	Vehicles without Keyless Access	Vehicles with Keyless Access
1.	Bring the vehicle to a complete stop ⇒ .	
2.	Depress and hold down the brake pedal until step 4 is completed.	
3.	Automatic transmission: Shift the transmission into Park (P).	
4.	Apply the parking brake to help prevent the vehicle from moving ⇒ <i>Braking and parking</i> .	
5.	Turn the vehicle key to position ⇒ <i>Fig. 134</i> in the ignition switch.	Briefly press the starter button ⇒ <i>Fig. 135</i> . If the engine will not switch off, carry out the emergency shut-off procedure ⇒ <i>Emergency shut-off</i> .
6.	Manual transmission: Shift into 1st gear (vehicle on flat surface or pointing uphill) or Reverse (R) (vehicle pointing downhill).	
7.	Removing the vehicle key from the ignition switches off electrical equipment and acti- vates the steering column lock.	Opening the doors switches off electrical equipment and activates the steering col- umn lock.

WARNING

Never stop the engine before the vehicle has come to a complete stop. You can lose control of the vehicle, crash, and be seriously injured.



- The brake booster does not work when the engine is not running. More brake pedal pressure will be needed to stop the vehicle.
- The power steering system does not work when the engine is not running, and you will need more force to steer the vehicle.
- Never remove the key from the ignition switch or turn off the ignition with the starter button while the vehicle is moving or rolling to a stop. The electronic steering column could suddenly lock, you would not be able to steer, and you could lose control of the vehicle, crash, and seriously injure yourself and others.

NOTE

If the vehicle has been driven hard for a long time, the engine could overheat when it is stopped. To reduce the risk of engine damage, let the engine idle in Neutral for about 2 minutes before you switch off the ignition.



If the ignition is switched on or the engine is running and the driver door is opened, a chime sounds. The chime is also a reminder to switch off the engine and turn off the ignition before leaving and locking the vehicle from the outside.




On vehicles with automatic transmissions, the vehicle key can only be removed from the ignition when the transmission is in Park (P).



After the engine has been switched off, the radiator fan in the engine compartment may keep running for several minutes, or may start running after the vehicle has been parked for a while, even if the ignition is switched off and the vehicle key has been removed. The radiator fan shuts off automatically when the engine has cooled down enough.

Electronic immobilizer



Read and follow the introductory information and safety information first ⇒  [Introduction to the subject](#)



vehicle key.

There is a microchip inside the vehicle key. The chip deactivates the immobilizer automatically when an authorized vehicle key is inserted into the ignition switch or the starter button is pressed.

The electronic immobilizer is automatically activated when the remote control vehicle key is pulled out of the ignition switch. On vehicles with push-button start, the vehicle key must be outside the vehicle ⇒ [Unlocking or locking the vehicle with Keyless Access](#).

The engine can therefore only be started with an authorized and correctly coded genuine Volkswagen vehicle key. Coded vehicle keys are available from authorized Volkswagen dealers, authorized Volkswagen Service Facilities, and from certain independent repair facilities and locksmiths who are qualified to make these vehicle keys ⇒ [Vehicle key set](#).

If an unauthorized vehicle key is used, a message may appear in the instrument cluster display. The vehicle cannot be operated with this key.

A Declaration of Compliance with the United States FCC and Industry Canada regulations is on ⇒ [Declaration of Compliance, Telecommunications and Electronic Systems](#).



Using genuine Volkswagen keys helps minimize the risk of malfunctions.

Shifting



Introduction to the subject

In this chapter you will find information on the following subjects:

⇒ [Warning and indicator lights](#)

⇒ [Pedals](#)

⇒ [Manual transmission: Gearshift lever](#)

⇒ [Automatic transmission: Selector lever](#)



⇒ *Driving with automatic transmission*

⇒ *Automatic transmission malfunction*

⇒ *Gear recommendation*

Explanatory notes in this section regarding automatic transmissions also apply to the DSG[®] automated transmission.

Your vehicle may be equipped with a special DSG[®] automated transmission that combines the performance and economy of a standard manual transmission with the comfort and convenience of a conventional automatic transmission. The DSG transmission housing contains two clutches, one that works with the odd-numbered gears (1, 3, 5 and R) and the other that works with the even-numbered gears (2, 4, 6). The dual clutch configuration enables rapid shifts between gears without loss of traction as the dual clutch seamlessly transfers the engine power from one driveshaft to the other during gear shifts. An output shaft for each of the two gearbox units transmits the drive to the driven wheels via a differential. The DSG electronic control unit, sensors, and hydraulic control for clutch engagement and gear selection form one compact weight-saving unit.

Thanks to the dual-clutch design, the DSG system is more efficient than a conventional automatic transmission. For example, while idling, a torque converter in a conventional automatic transmission is engaged all the time (increasing load and engine fuel consumption), while the DSG gradually opens the clutch, allowing the engine to idle freely. In most cases, this efficiency combined with its low weight and intelligent control means that DSG can achieve the same or better fuel consumption than a manual transmission. The clutches, like the clutch in a standard manual transmission are subject to wear over time. The DSG transmission requires periodic maintenance that is described in the *Chapter Warranty and Maintenance*.

When the ignition is switched on and the transmission is in Reverse (R):

- The backup lights come on.
- Climatronic (if equipped) switches automatically to air recirculation mode.
- The rear window wiper switches on when the windshield wipers are switched on.
- The Rear View Camera system and the Park Distance Control system switch on (if equipped).



Rapid acceleration can cause skidding and loss of traction, especially on slippery roads, resulting in a loss of vehicle control, collisions, and serious personal injury.

- Only use the kick-down feature or fast acceleration if visibility, weather, road, and traffic conditions permit and other drivers will not be endangered by your driving and the vehicle's acceleration.

WARNING

Constant braking causes the brakes to overheat and even to fail leading to collisions and serious personal injury.


- Never ride the brakes or apply the brake pedal too often or too long.
- Riding the brakes will substantially reduce braking performance, increase stopping distance, and can cause complete brake system failure.

NOTE

- Never ride the brakes by keeping your foot on the brake pedal when you do not want to brake. This will make the brakes wear faster.
- Before driving downhill, especially on hills that are long or steep, always reduce speed and shift into lower gear (manual or automatic transmission). This will let the vehicle use engine braking and reduce the load on the brakes. Otherwise, the brake system could overheat and even fail. Only use the brakes when you need them to slow the vehicle down more or to stop.

Warning and indicator lights




Read and follow the introductory information and safety information first ⇒  [Introduction to the subject](#)


Lights up Possible cause

Proper response




 Do not continue driving!

Allow the transmission to cool with the selector lever in the P position.

 Transmission malfunction.

If the warning does not turn off, do not continue driving. See your authorized Volkswagen dealer for assistance. Otherwise, serious transmission damage could result ⇒ *Automatic transmission malfunction*.

 Brake pedal not depressed.

Apply the brake pedal to select a drive gear ⇒ *Braking and parking*.

Flashes Possible cause

Proper response



Engage selector lever release button ⇒ [Automatic](#)

The release button in the selector lever [Shift Lock \(ASL\)](#).



did not engage. Vehicle movement is

prevented.

If the vehicle has an electronic parking brake, refer

to ⇒ [Electronic parking brake \(Golf R\)](#).

When the ignition is switched on, several warning and indicator lights come on briefly for a function check. They go out after a few seconds.

WARNING

Failure to heed warning lights and instrument cluster text messages can cause the vehicle to break down in traffic and result in a collision and serious personal injury.

- Never ignore warning lights or text WARNINGS.
- Always stop the vehicle as soon as it is safe to do so.
- Whenever stalled or stopped for repair, move the vehicle a safe distance off the road, turn on the emergency flashers, stop the engine, and use other warning devices to warn approaching traffic.

NOTE

Failure to heed warning lights or text WARNINGS can result in vehicle damage.

Pedals

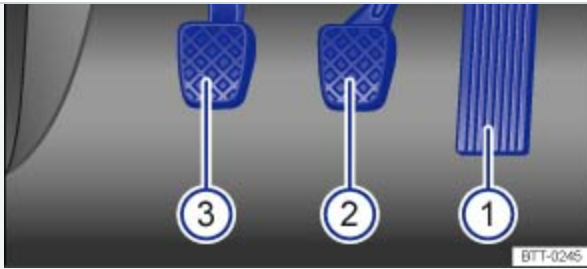


Fig. 137 Pedals in vehicles with manual transmission: ① Accelerator pedal, ② Brake pedal, ③ Clutch pedal.

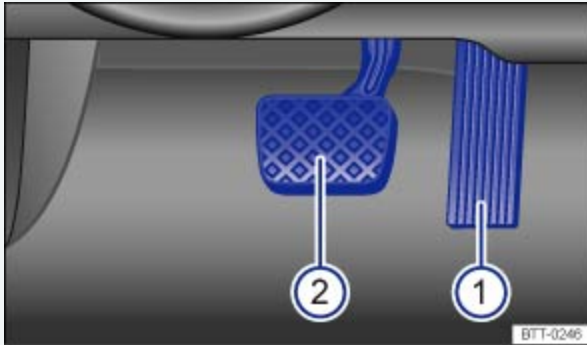


Fig. 138 Pedals in vehicles with automatic transmission: ① Accelerator pedal, ② Brake pedal.



Read and follow the introductory information and safety information first ⇒ [Introduction to the subject](#)

All pedals must always be able to move freely in and out without interference from floor mats or other things.

Only use floor mats that leave the pedal area free and are held securely in place with floor mat fasteners to help prevent sliding.

If a brake circuit malfunctions, more brake pedal travel is needed to bring the vehicle to a full stop, and it is important that nothing is in the way when you have to depress the brake pedal harder and farther than normal.

WARNING

Objects in the driver footwell can prevent the pedals from moving freely. This can cause loss of vehicle control and increase the risk of serious personal injuries.

- Always make sure that nothing can interfere with the pedals.

- Never put floor mats or other floor coverings on top of already installed floor mats.
- Always make sure that nothing can fall into the driver footwell while the vehicle is moving.

NOTE

Always make sure that the pedals are able to move freely and that nothing can interfere with them. If a brake circuit fails, more brake pedal travel will be needed to bring the vehicle to a stop. The brake pedal must be pressed farther and harder than normal.

Manual transmission: Gearshift lever

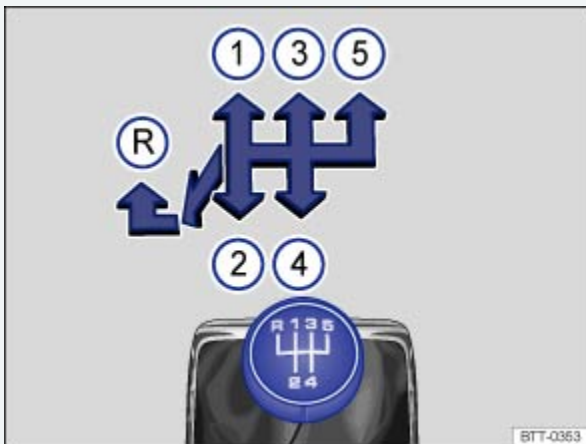


Fig. 139 Gearshift pattern of a 5-speed manual transmission.

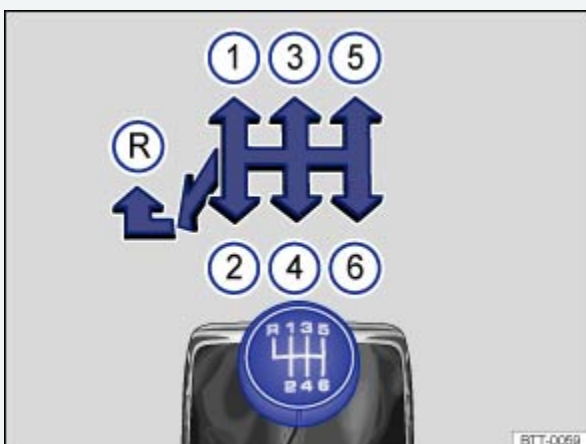


Fig. 140 Gearshift pattern of a 6-speed manual transmission.



Read and follow the introductory information and safety information first ⇒ [Introduction to the subject](#)



- Depress the clutch pedal all the way and hold.
- Move the gearshift lever into the desired position ⇒ ⚠.
- Release the clutch pedal to engage the gear.

The clutch pedal must be fully depressed to start the engine.

Shifting into reverse

- Only shift to the reverse gear when the vehicle is not moving.
- Depress the clutch pedal fully and hold ⇒ ⚠.
- Move the gearshift lever to neutral and press down.
- Move the shift lever to the left and then push forward into the reverse gear position ⇒ [Fig. 139®](#) or ⇒ [Fig. 140®](#).
- Release the clutch pedal to engage the gear.

Downshifting

You should always downshift gear by gear when driving, meaning always into the next lowest gear. Do not downshift when the engine rpm (revolutions per minute) is too high ⇒ ⚠. At fast speeds or high engine rpm, skipping over one or more gears when downshifting can cause damage to the clutch and transmission, even if a gear is not engaged ⇒ ⚠.

⚠ WARNING

Downshifting to a lower gear incorrectly can result in loss of vehicle control and can cause accidents and serious personal injuries.

⚠ WARNING

When the engine is running and a gear is engaged, the vehicle will start to move as soon as the clutch pedal is released. This also applies when the parking brake is engaged.

- Never shift into Reverse (R) when the vehicle is moving.

ⓘ NOTE

extensive damage to the clutch and transmission. That is true even if the clutch pedal is pressed so that the clutch is not engaged.

NOTE

To help prevent damage and premature wear:

- Do not rest your hand on the gearshift lever while driving. Over time, the pressure will cause premature wear in the transmission.
- Make sure that the vehicle has come to a complete stop before shifting into Reverse (R).
- Always depress the clutch pedal all the way when changing gears.
- Do not hold the vehicle on a hill using engine power with the clutch pedal partially engaged and the engine running.

Automatic transmission: Selector lever

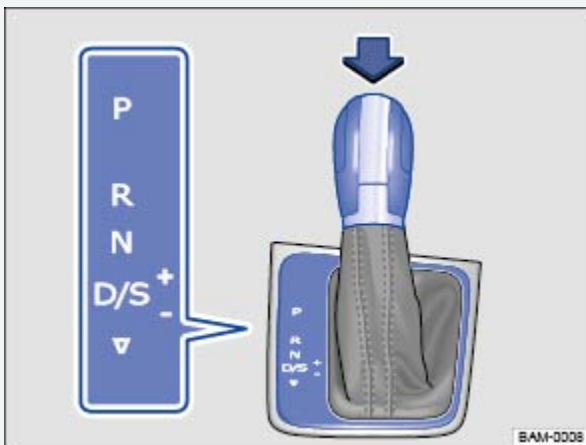


Fig. 141 Automatic transmission selector lever with shift lever release button (arrow).




Read and follow the introductory information and safety information first ⇒ [Introduction to the subject](#)

Automatic transmission vehicles have an Automatic Shift Lock (ASL). With ASL, you must switch on the ignition, depress the brake pedal and hold it down while pressing the release button on the selector lever handle in the direction of the arrow ⇒ [Fig. 141](#) to move the selector lever out of Park (P) and into a drive gear. When the selector lever is in Neutral (N), you also have to depress the brake pedal before you can move the selector lever to position (D/S), or Reverse (R).



the instrument cluster display.

Selector lever position	Designation	Meaning ⇒ 
P	Park	<p>The drive wheels are mechanically locked.</p> <p>Select only when the vehicle is <i>not moving</i>. To change the selector lever position, switch on the ignition (if it is off) and then press the selector lever release button while holding down the brake pedal.</p>
R	Reverse	<p>The Reverse gear is engaged.</p> <p>Shift into Reverse only when the vehicle is <i>not moving</i>.</p>
N	Neutral	<p>Transmission is in Neutral position. No power is transmitted to the wheels and no engine braking is available.</p>



Gear position	Designation	Meaning
D/S	Drive (standard driving position)	<p>Standard driving position D:</p> <p>All forward gears shift up and down automatically. The transmission shifts as needed depending on engine load, individual driving style, and vehicle speed.</p>
	OR Sport drive (sport driving position)	<p>Sport driving position S:</p> <p>All forward gears automatically upshift <i>later</i> and downshift <i>earlier</i> than in position D to take full advantage of the engine's power reserves. The transmission shifts as needed depending on engine load, individual driving style, and vehicle speed. The system will not, however, switch to the highest forward gear.</p>
		<p>The timing of the gear shift is determined by the engine load, your individual driving style, and the vehicle speed.</p>




lever position	Designation	Meaning
	Changing gear selection	Switch between Drive (D) and Sport drive (S) by pulling the selector lever <i>once</i> to the rear from gear position D/S ⇒ Fig. 141 . The selector lever always returns to gear position D/S.
		It is possible to access Tiptronic selection from gear position D/S when either Drive (D) or Sport drive (S) is active ⇒ Shifting with Tiptronic® .

Automatic Shift Lock (ASL)

The Automatic Shift Lock (ASL) in Park (P) and Neutral (N) prevents drive positions from being engaged inadvertently, which would cause the vehicle to move.

To release the ASL, depress and hold the brake pedal with the ignition switched on. Press the release button on the selector lever at the same time.

The ASL is not engaged if the selector lever is moved quickly through Neutral (N) (e.g., when shifting from Reverse (R) to Drive (D/S)). This makes it possible to rock the vehicle backwards and forwards if it is stuck in snow or mud. The ASL engages automatically if the brake pedal is not depressed and the lever is in Neutral (N) for more than about 1 second and the vehicle is traveling no faster than about 3 mph (5 km/h).

In rare cases, the ASL may not engage on vehicles with a DSG® automated transmission. If this happens, power to the drive wheels will be interrupted to prevent the vehicle from moving unexpectedly. The green indicator light  will blink and a text message will be displayed. To engage the Automatic Shift Lock (ASL):

- Depress and then release the brake pedal. Try to engage the ASL again.

 **WARNING**



serious personal injury.

- Never accelerate when moving the selector lever.
- When the engine is running and a drive position is engaged, the vehicle will start to move as soon as the brake pedal is released.
- Never shift into Reverse (R) or Park (P) when the vehicle is moving.

WARNING

Unintended vehicle movement can cause serious personal injury.

- Never get out of the driver's seat while the engine is running, especially when the transmission is in a drive gear. If you must leave your vehicle while the engine is running, always set the parking brake and shift the transmission into Park (P).
- Never leave the vehicle in Neutral (N). It will roll down hills, whether the engine is running or not.
- When the engine is running and a drive gear - Drive or Sport Drive (D/S) or Reverse (R) - has been selected, press and hold the brake pedal to keep the vehicle from moving. The vehicle may creep and move forward or backward even if the engine is idling slowly.
- Never shift into Reverse (R) or Park (P) when the vehicle is moving.

NOTE

Even though the transmission is in Park (P), the vehicle may move a couple of inches (a few centimeters) forwards or backwards if you take your foot off the brake pedal after stopping the vehicle without first setting the parking brake.



If the selector lever is moved into Neutral (N) by mistake when the vehicle is moving, take your foot off the accelerator pedal. Wait until the engine speed has dropped to idle speed before moving the selector lever into a drive gear.



Leaving the selector lever for a long period of time in any position other than Park (P) when the ignition is switched off can drain the vehicle battery.

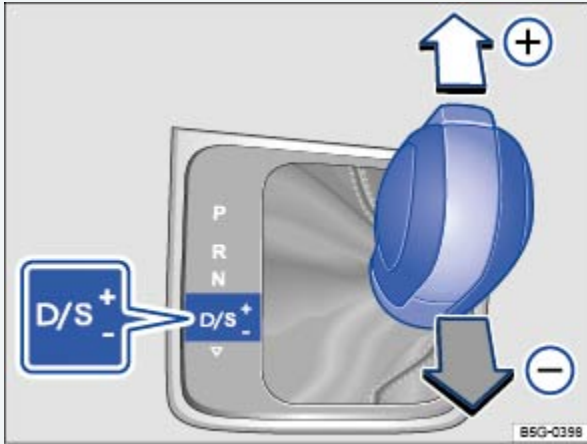


Fig. 142 Selector lever in Tiptronic position.

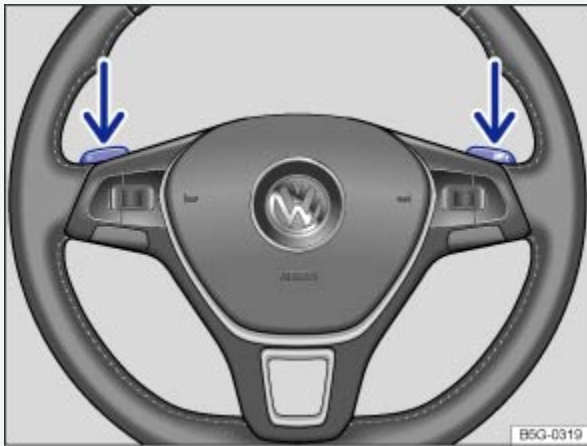


Fig. 143 Steering wheel with Tiptronic shift paddles (if equipped).



Read and follow the introductory information and safety information first ⇒ [Introduction to the subject](#)

Tiptronic lets you upshift and downshift manually with the automatic transmission. When Tiptronic mode is used, the transmission stays in the current gear and does not upshift or downshift automatically unless the transmission senses a situation where upshifting or downshifting is necessary to keep the engine from over- or under-revving.

Using Tiptronic with the selector lever

- Push the selector lever sideways to the right from the D/S position into the Tiptronic position ⇒ .
- Briefly push the selector lever forward ⊕ to upshift into a higher gear or backward ⊖ to downshift into a lower gear ⇒ [Fig. 142](#) .



- The paddles ⇒ *Fig. 143* (arrows) work when the selector lever is in the Tiptronic position or when the selector lever is in Drive or Sport Drive (D/S). You do not have to move the selector lever over to the right into the Tiptronic position.
- To upshift, pull the paddle on the right **OFF** + toward you.
- To downshift, pull the paddle on the left – toward you.
- To switch off Tiptronic mode, pull the paddle on the right **OFF** + toward you and hold it there for about 1 second.


Tiptronic will switch off automatically if the shift paddles have not been used for a while and the selector lever is not in the Tiptronic position.

NOTE

- During acceleration, the transmission will shift automatically into the next higher gear before reaching maximum engine speed (rpm).
- If you use Tiptronic to shift into a lower gear, the transmission will downshift only when doing so will not over-rev the engine.

Driving with automatic transmission



Read and follow the introductory information and safety information first ⇒  *Introduction to the subject*

All forward gears shift up and down automatically.

Driving on hills


The steeper the grade, the lower the gear that must be selected. Lower gears increase the braking effect of the engine. Never coast downhill in Neutral (N).

- Reduce speed.
- Switch to Tiptronic mode by moving the selector lever from Drive or Sport Drive (D/S) to the right into the Tiptronic position ⇒ *Shifting with Tiptronic*[®].
- Downshift by pulling the selector lever back briefly (-).




behind the steering wheel (if equipped).

If you stop and start up again when going uphill, you should use the Hill Start Assist feature ⇒ *Starting assistance systems* as long as the engine is running.

Vehicles without Hill Start Assist: If you stop on a hill with the vehicle in gear, you must depress the brake pedal or engage the parking brake to keep the vehicle from rolling. Do not release the brake pedal or the parking brake until the vehicle has started to move forward ⇒ .

Kick-down acceleration


The kick-down feature permits maximum acceleration when the selector lever is in the Drive or Sport Drive (D/S) position or in Tiptronic mode.

If you push the accelerator all the way down, the vehicle will automatically downshift, depending on vehicle speed and engine speed (rpm). This feature lets you take advantage of the full acceleration capacity of the vehicle ⇒ .

With kick-down activated, the transmission will stay in the current gear longer and not upshift until the engine reaches maximum rpm.

Launch control program

The launch control program lets you take advantage of maximum acceleration from a standstill.

- Switch off Anti-Slip Regulation (ASR). Golf R only: Switch off Anti-Slip Regulation (ASR) and Electronic Stability Control (ESC) ⇒ *Braking and parking*.
- Firmly depress and hold the brake pedal with your left foot.
- Make sure your steering wheel is straight and the front wheels are pointing straight ahead.
- Move the selector lever into Sport Drive (S) or the Tiptronic position. For vehicles with Driving Mode Selection, select the Sport or Race driving mode ⇒ *Driving Mode Selection*.
- With your right foot, depress the accelerator pedal all the way. The engine speed automatically increases to about 3200 rpm (Golf GTI) or 4000 rpm (Golf R) and stays there.
- Remove your left foot from the brake ⇒ . The vehicle will accelerate from a stop at the maximum rate.
- Once you have accelerated, switch ASR back on again!



Rapid acceleration can cause skidding and loss of traction, especially on slippery roads, resulting in a loss of vehicle control, collisions, and serious personal injury.


- Only use the kick-down feature, Launch Control Program, or fast acceleration if visibility, weather, road, and traffic conditions permit and other drivers will not be endangered by your driving and the vehicle's acceleration.
- Always adapt your driving to the traffic flow.
- Note that the drive wheels can spin and the vehicle can swerve when ASR is switched off, especially when the road is slippery.
- Once you have accelerated, switch ASR back on again.

NOTE

- When stopping on hills with the transmission in a drive gear, do not use the accelerator to help prevent the vehicle from rolling backwards. This can cause the automatic transmission to overheat and be damaged.
- Never let the vehicle coast or roll down a hill in Neutral (N), especially when the engine is not running. The transmission will not be lubricated and will be damaged.
- Launch Control acceleration uses the maximum acceleration capability of the vehicle but places significant loads on the drive train and related parts. If you do use the Launch Control feature, do not use it regularly or often to help prevent unnecessary wear on the vehicle and its systems.

Automatic transmission malfunction



Read and follow the introductory information and safety information first ⇒  [Introduction to the subject](#)

Emergency shift program



If all selector lever position indicators in the instrument cluster display are highlighted against a bright background, there is a system malfunction. The automatic transmission or the DSG® automated transmission will then operate in the emergency shift program. The emergency shift program lets you drive the vehicle, but at a reduced speed and without being able to use all of the forward gears.



is then impossible to drive the vehicle backwards.

In any event, have the automatic transmission checked by an authorized Volkswagen dealer or authorized Volkswagen Service Facility.

Overheating of the DSG[®] automated transmission

The DSG transmission may overheat, for example, due to frequent starts, extended creeping, or stop-and-go traffic. Overheating is indicated by the warning light  and, if applicable, by a text message in the instrument cluster. An additional warning chime may sound. Stop and let the transmission cool down ⇒ .

The vehicle does not move forward or in reverse even though a drive position is selected with the selector lever

If the vehicle does not move in the desired direction, the system may not have engaged the drive position correctly. Press the brake pedal and select the drive position again.

If the vehicle still does not move in the desired direction, there is a system malfunction. See your authorized Volkswagen dealer or authorized Volkswagen Service Facility for assistance to have the system checked.

NOTE

- As soon as you get any of these warnings about transmission overheating, you must either park the vehicle in a safe place or drive faster than 12 mph (20 km/h).
- If the text message and acoustic warning repeat themselves every 10 seconds or so, you must park the vehicle in a safe place as soon as you can safely do so and stop the engine. Let the transmission cool down.
- To help prevent damage to the transmission, do not drive the vehicle again until the acoustic warning has stopped. As long as the engine is overheated, avoid stop and start driving and avoid low speeds (walking pace).

Gear recommendation



Fig. 144 In the instrument cluster display: Gear recommendation.



Read and follow the introductory information and safety information first ⇒ [Introduction to the subject](#)

Your vehicle may be equipped with a gear recommendation feature. The gear recommendation displays a gear in the instrument cluster display that can help reduce fuel consumption.

For vehicles with an *automatic transmission*: The selector lever must be in the Tiptronic position ⇒ [Shifting with Tiptronic®](#).

Key to ⇒ [Fig. 144](#) :



Current gear.



Recommended gear.

If the optimal gear is already selected, another gear is not recommended. Only the current gear is displayed.

WARNING

The gear recommendation is only intended to assist the driver to select a gear for optimum fuel economy. The gear recommendation cannot take road and traffic conditions into account.

- The driver is responsible for selecting the correct gear for the current driving conditions, such as when passing, when driving on hills, or when towing a trailer.



Selecting the optimal gear helps to reduce fuel consumption.



The gear recommendation display turns off if you depress the clutch pedal (manual transmission) or move the selector lever out of the Tiptronic position (automatic transmission).



In this chapter you will find information on the following subjects:

⇒ *Warning and indicator lights*

⇒ *Steering system information*

Your vehicle is equipped with an electromechanical power steering system. The power steering works only when the engine is running.

The electromechanical power steering system automatically adjusts to driving speed, steering torque, and the steering angle of the wheels. It delivers extra steering force only when you are actually turning the wheels.

In vehicles with Driving Mode Selection, the selected driving mode can affect the steering behavior
⇒ *Driving Mode Selection*.


WARNING

Turning the steering wheel is very hard when the power steering system is not working. This makes it harder to steer and control the vehicle.

- Power steering works only when the engine is running.
- Never let the vehicle coast with the engine switched off.
- Never remove the key from the ignition switch or turn off the ignition with the starter button while the vehicle is moving or rolling to a stop. The electronic steering column could suddenly lock, you would not be able to steer, and you could lose control of the vehicle, crash, and seriously injure yourself and others.

Warning and indicator lights




Read and follow the introductory information and safety information first ⇒  *Introduction to the subject*

Lights up Possible cause

Proper response



 Stop!



Power steering malfunction.

Have the power steering system checked immediately by an authorized Volkswagen dealer or an authorized Volkswagen Service Facility.

Stop, restart the engine, and drive a short distance. If the yellow warning light does not come on again, you do not need to have the steering system checked.

Power steering assist is reduced.



Otherwise, have the steering checked immediately by an authorized Volkswagen dealer or an authorized Volkswagen Service Facility.


Vehicle battery was disconnected and has been reconnected.

Drive a short distance at about 10–12 mph (15–20 km/h).

Flashes Possible cause

Proper response



 Stop!



Electronic steering column lock malfunction.

The ignition cannot be switched on. The vehicle must not be towed! Get professional assistance.



Steering system stiff.

Turn the steering wheel back and forth.



Steering column not locked/unlocked.

Switch the ignition off and then switch it on again. Heed any messages shown in the instrument cluster display, if applicable.

On vehicles with Keyless Access ⇒ *Starting the engine*, press the starter button briefly twice in a row without depressing the brake or clutch pedal.

Do not drive any farther if the steering column remains locked after you switch on the ignition. Contact your authorized Volkswagen dealer or an authorized Volkswagen Service Facility for assistance.

When the ignition is switched on, several warning and indicator lights come on briefly for a function check. They go out after a few seconds.

 **WARNING**

Failure to heed warning lights and instrument cluster text messages can cause the vehicle to break down in traffic and result in a collision and serious personal injury.



- Always stop the vehicle as soon as it is safe to do so.

NOTE

Failure to heed warning lights or text WARNINGS can result in vehicle damage.

Steering system information



Read and follow the introductory information and safety information first ⇒ [Introduction to the subject](#)

To help prevent vehicle theft, you should always make sure the steering column is locked before leaving the vehicle.

Electronic steering column lock

Vehicles with Keyless Access: The steering column is locked if the driver door is opened with the ignition switched off. The vehicle must be standing still and the transmission must be in Park (P) on an automatic transmission vehicle.

If the driver door is opened before the ignition is switched off, the electronic steering column lock is activated only after the vehicle has been locked with the vehicle key or via the sensor in the door handle.

Mechanical steering column lock

Vehicles without Keyless Access: The steering column is locked if the vehicle is stationary and the vehicle key is removed from the ignition switch.

Engaging the steering column lock	Disengaging the steering column lock
Park the vehicle ⇒ Braking and parking .	Turn the steering wheel slightly to take pressure off the steering column lock.
Remove the vehicle key.	Insert the vehicle key into the ignition switch.



Turn the steering wheel slightly until you hear the steering column lock engage.	Hold the steering wheel in this position and turn the ignition switch.
--	--

Power steering

Power steering automatically adjusts to driving speed, steering torque, and the steering angle of the wheels. Power steering works only when the engine is running.

If power steering is reduced or lost completely, it will be much harder to steer and control the vehicle.

Counter-steering assistance

Counter-steering assistance is part of Electronic Stability Control (ESC). This feature makes it easier for the driver to control the vehicle in difficult situations. For example, if you have to brake hard on a surface that provides uneven traction, the vehicle could pull to the right or left. ESC detects this situation and helps the driver counter-steer with additional steering power ⇒ ⚠.

Progressive steering (Golf GTI, Golf R only)

Your vehicle may be equipped with progressive steering, which can adjust the force of the steering movement in a driving situation. Progressive steering only works when the engine is running.

In *city traffic*, less steering input is required when parking, maneuvering, or turning sharply.

When driving on *country roads* or *highways*, the progressive steering provides a more sporty, direct steering response and a more dynamic feel.

WARNING

The counter-steering assistance in ESC can do no more than help the driver steer in difficult situations. The driver must still control the vehicle. The vehicle does not steer by itself with this feature!

NOTE

If the ignition is off, the steering column lock will engage and the vehicle cannot be steered. For



ple, so that the wheels will self-steer.

Braking and parking



Introduction to the subject

In this chapter you will find information on the following subjects:

⇒ *Warning and indicator lights*

⇒ *Parking brake (Golf, Golf GTI)*

⇒ *Electronic parking brake (Golf R)*

⇒ *Parking*

⇒ *About the brakes*

⇒ *Braking assistance systems*

⇒ *Switching Anti-Slip Regulation (ASR) and ESC Sport mode on and off*

⇒ *Brake fluid*

The braking assistance systems are the Anti-Lock Brake System (ABS), Brake Assist System (BAS), Electronic Differential Lock (EDL), Anti-Slip Regulation (ASR), and Electronic Stability Control (ESC).

WARNING

Driving with bad brakes or worn brake pads can cause a collision and serious personal injury.

- If the brake pads are worn or you notice changes in the way the vehicle brakes, immediately contact an authorized Volkswagen dealer or authorized Volkswagen Service Facility to have the brake pads checked and, if necessary, replaced.

WARNING

Parking improperly can cause serious personal injury.



while the vehicle is moving or coming to a stop. The electronic steering column could suddenly lock, you would not be able to steer, and you could lose control of the vehicle, crash, and seriously injure yourself and others.

- Never park the vehicle where the hot exhaust system or catalytic converter could ignite flammable materials, such as brush, leaves, dry grass, spilled fuel, etc.
- Always apply the parking brake when parking your vehicle.
- Improper use of the parking brake can seriously injure you and your passengers.
- Never use the parking brake to slow down the vehicle when it is moving, except in an emergency. The stopping distance is much longer because only the rear wheels are braked. Always use the foot brake to stop the vehicle.
- Never activate the throttle manually from the engine compartment when the engine is running and the automatic transmission is in gear. The vehicle will start to move as soon as the engine speed increases even if the parking brake is on.
- Never leave children or anyone who cannot help themselves behind in the vehicle. They could release the parking brake and move the gear selector lever or gear shift, which could cause the vehicle to start moving. This can lead to a crash and serious personal injuries.
- Always switch off the engine and the ignition and take the key with you when you leave the vehicle. The engine can be started and vehicle systems such as the power windows can be operated, leading to serious personal injury.
- Never leave children, disabled persons, or anyone who cannot help themselves in the vehicle. The doors can be locked with the remote control vehicle key, trapping passengers in the vehicle in an emergency. For example, depending on the time of year, people trapped in the vehicle can be exposed to very high or very low temperatures.
- Heat buildup in the passenger and luggage compartment of a parked vehicle can result in temperatures in the vehicle that are much higher than the outside temperatures, particularly in summer. Temperatures can quickly reach levels that can cause unconsciousness and death, particularly to small children.

NOTE

- Always be careful when you park in areas with parking barriers or high curbs. These vary in height and could damage your bumper and related parts if the front of your vehicle hits a barrier or curb that is too high while you are getting into or out of a parking spot. To help prevent



- Always be careful when you enter a driveway or drive up or down steep ramps or over curbs or other obstacles. Parts of the vehicle close to the ground may be damaged (such as bumper covers, spoilers, and parts of the engine, suspension, and exhaust systems).

Warning and indicator lights



Read and follow the introductory information and safety information first ⇒ [Introduction to the subject](#)

Lights up Possible cause or meaning ⇒

Proper response



Parking brake engaged.



Stop!

Release the parking brake ⇒ [Parking brake \(Golf, Golf GTI\)](#).



Stop!

Brake system malfunction.

Get professional assistance immediately

⇒ [Brake system malfunction](#).



Stop!

Brake fluid level too low.

Check the brake fluid level ⇒ [Brake fluid level](#).



See an authorized Volkswagen dealer or an au-

Together with the ABS indicator light  or thorized Volkswagen Service Facility.

ABS: ABS failure.

The vehicle brakes will work without ABS.

ESC switched off by the system.

Switch ignition off and on again. You may have to drive a short distance.

ESC malfunction.

See an authorized Volkswagen dealer or an authorized Volkswagen Service Facility.

See an authorized Volkswagen dealer or an au-

Together with the ABS indicator light  or thorized Volkswagen Service Facility.



ABS: ABS malfunction.

The vehicle brakes will work without ABS.

Vehicle battery has been reconnected.

Drive a short distance at a speed of 10–12 mph (15–20 km/h). If the indicator light stays on, see an authorized Volkswagen dealer or an authorized Volkswagen Service Facility

⇒ *Vehicle battery*.



ASR manually deactivated.



OR: ESC Sport mode manually activated.

Switch on ASR or switch off ESC Sport mode

⇒ *Switching Anti-Slip Regulation (ASR) and*

ESC Sport mode on and off. ASR automatically

turns on when you turn the ignition off and

back on again.


Together with the ESC indicator light :

ABS malfunction.




See an authorized Volkswagen dealer or an au-

thorized Volkswagen Service Facility.

Together with warning light  or **BRAKE**:

ABS failure.

The vehicle brakes will work without ABS.

Electronic parking brake malfunction (if  equipped).

See an authorized Volkswagen dealer or an au-


thorized Volkswagen Service Facility.



Brake pedal not depressed.

Depress the brake pedal to select a gear or

drive position.

Flashes Possible cause or meaning ⇒ 

Proper response



ESC or ASR is operating.

Take foot off accelerator pedal. Adapt driving

to road conditions.



The release button in the selector lever is not engaged. Engage the Automatic Shift Lock (ASL) ⇒ *Automatic transmission: Selector lever*.

When the ignition is switched on, several warning and indicator lights come on briefly for a function check. They go out after a few seconds.





WARNING

Failure to heed warning lights and instrument cluster text messages can cause the vehicle to break down in traffic and result in a collision and serious personal injury.

- Never ignore warning lights or text WARNINGS.
- Always stop the vehicle as soon as it is safe to do so.

WARNING

Driving with bad brakes can cause a collision and serious personal injury.

- If the brake warning light **BRAKE** or  does not go out, or lights up when driving, either the brake fluid level in the reservoir is too low or there is a fault in the brake system. Stop the vehicle as soon as you can do so safely and get expert assistance ⇒ *Brake fluid*.
- If the brake warning light **BRAKE** or  lights up at the same time as the ABS warning light **ABS** or , the ABS may not be working properly. This could cause the rear wheels to lock up relatively quickly during braking. Rear wheel brake lock-up can cause loss of vehicle control.
- If you believe the vehicle is safe to drive, drive slowly and very carefully to the nearest authorized Volkswagen dealer, authorized Volkswagen Service Facility, or other qualified workshop and have the brake system inspected. Avoid sudden hard braking and steering.
- If the ABS indicator light **ABS** or  does not go out, or if it lights up while driving, the ABS system is not working properly. The vehicle can then be stopped only with the standard brakes (without ABS). You will not have the protection ABS provides. Contact your authorized Volkswagen dealer or an authorized Volkswagen Service Facility as soon as possible.
- If the brake pads are worn or you notice changes in the way the vehicle brakes, immediately contact an authorized Volkswagen dealer or authorized Volkswagen Service Facility to have the

NOTE

Failure to heed warning lights or text WARNINGS can result in vehicle damage.

Parking brake (Golf, Golf GTI)

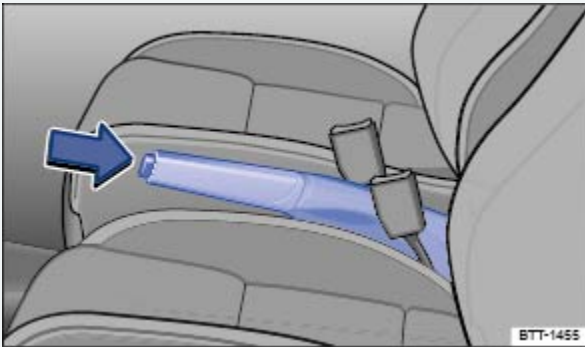


Fig. 145 Between the front seats: Parking brake.



Read and follow the introductory information and safety information first ⇒  *Introduction to the subject*

The following information applies to models with a parking brake lever. If your vehicle is equipped with an electronic parking brake, see ⇒ *Electronic parking brake (Golf R)*.

Setting the parking brake

- Pull the parking brake lever up firmly.
- When the ignition is on, the indicator light  or **PARK** appears in the instrument cluster display to show that the parking brake is engaged ⇒ *Warning and indicator lights*.

Releasing the parking brake

- Pull the lever up slightly and press the release button ⇒ *Fig. 145* (arrow).
- While holding the release button down, move the lever all the way down.

WARNING

Improper use of the parking brake can cause accidents and severe injuries.

gency. Braking distance is much longer, since only the rear wheels are braked. Always use the foot brake.

- Never drive with the parking brake partially engaged. This can cause the brake to overheat and negatively affect the brake system. It will also cause the rear brake pads to wear prematurely.
- Never activate the throttle manually from the engine compartment when the engine is running and the automatic transmission is in gear. The vehicle will start to move even if the parking brake is engaged.

NOTE

Even though the transmission is in Park (P), the vehicle may move a couple of inches (a few centimeters) forwards or backwards if you take your foot off the brake pedal after stopping the vehicle without first firmly setting the parking brake.



A warning signal sounds if you drive faster than about 4 mph (6 km/h) with the parking brake engaged.

Electronic parking brake (Golf R)



Fig. 146 In the lower center console: Electronic parking brake switch.



Read and follow the introductory information and safety information first ⇒ [Introduction to the subject](#)

The following information applies to models with an electronic parking brake. If your vehicle is

Setting the electronic parking brake

You can engage the electronic parking brake any time the vehicle is not moving - even if the ignition is switched off. Always engage the parking brake when you leave or park the vehicle.

- Pull and hold the switch ⇒ [Fig. 146](#).
- The parking brake is engaged when the yellow indicator light in the switch ⇒ [Fig. 146](#) (arrow) and the red indicator light in the instrument cluster ⇒ [Warning and indicator lights](#) light up.

Releasing the electronic parking brake

- Switch the ignition on.
- Press the switch ⇒ [Fig. 146](#). At the same time, press the brake pedal firmly or press the accelerator pedal lightly if the engine is running.
- The parking brake is released when the yellow indicator light in the switch ⇒ [Fig. 146](#) (arrow) and the red indicator light in the instrument cluster ⇒ [Warning and indicator lights](#) go out.

Automatic electronic parking brake release when you start driving

The electronic parking brake releases automatically when you start driving if the driver door is closed. With a manual transmission, you must also press the clutch pedal all the way down before you start driving so the system recognizes that the parking brake should be switched off.

You can prevent the electronic parking brake from switching off automatically by pulling and holding the switch while pulling away.

The electronic parking brake is only switched off after you let go of the switch. This makes it easier to start off with a heavier load.

Automatic electronic parking brake activation when the driver leaves the vehicle

In vehicles with an automatic transmission, the electronic parking brake automatically switches on to prevent the vehicle from moving when all of the following conditions are met:

- The selector lever is in position D/S, R, or Tiptronic position.
- The ignition is switched on.
- The vehicle is stationary.



Emergency braking function

Only use the emergency braking function in an emergency, when you cannot stop the vehicle using the brake pedal ⇒ ⚠ !

- Pull and hold the (P) switch ⇒ *Fig. 146* to brake the vehicle hard. An audible warning signal will sound at the same time.
- To stop the braking maneuver, release the (P) switch or press the accelerator pedal.

⚠ WARNING

Improper use of the electronic parking brake can cause accidents and severe injuries.

- Never use the parking brake to slow down the vehicle when it is moving, except in an emergency. Braking distance is much longer, since only the rear wheels are braked. Always use the foot brake.
- Never press the accelerator pedal when a selector lever position or gear is engaged and the engine is running. The vehicle could begin moving, even if the electronic parking brake is set.
- Never activate the throttle manually from the engine compartment when the engine is running and the automatic transmission is in gear. The vehicle will start to move even if the parking brake is engaged.

ⓘ NOTE

Even though the transmission is in Park (P), the vehicle may move a couple of inches (a few centimeters) forwards or backwards if you take your foot off the brake pedal after stopping the vehicle without first firmly setting the parking brake.



Vehicles with manual transmission: The electronic parking brake switches off automatically when you release the clutch pedal and press the accelerator pedal at the same time.



If the vehicle battery is dead, the electronic parking brake cannot be released. Use a jump-start ⇒ *Jump-starting*.



You may hear noises when setting or releasing the electronic parking brake.



If the electronic parking brake is not used for a while, an automatic system check will occasionally run when the vehicle is parked. This system check makes audible noises.

Parking



Read and follow the introductory information and safety information first ⇒ [Introduction to the subject](#)

Please note legal regulations when stopping and parking your vehicle.

Parking the vehicle

Please perform these steps only in the order listed.

- Stop the vehicle on a suitable surface ⇒ .
- Hold the brake pedal down until the engine is switched off.
- Apply the parking brake to help prevent the vehicle from moving ⇒ [Parking brake \(Golf, Golf GTI\)](#) or ⇒ [Electronic parking brake \(Golf R\)](#) (depending on equipment).
- For automatic transmissions: Shift the transmission into Park (P).
- Switch off the engine and then take your foot off the brake.
- Remove the vehicle key from the ignition.
- If necessary, turn the steering wheel slightly to engage the steering column lock.
- Shift manual transmission into 1st gear (on level ground or if pointed uphill) or reverse (if pointed downhill) and let the clutch out.
- Make sure all passengers and especially children leave the vehicle.
- Take all vehicle keys with you when leaving your vehicle.
- Lock the vehicle.

On hills



wheels will roll into the curb:

- Facing downhill, turn the front wheels so that they point toward the curb.
- Facing uphill, turn the front wheels so that they point away from the curb.

WARNING

The vehicle exhaust system and the catalytic converter get very hot. They can cause fires and serious personal injury.

- Never park where the hot exhaust system could ignite flammable materials, such as brush, leaves, dry grass, spilled fuel, etc.

WARNING

Leaving the vehicle when the selector lever is not in Park (P) (automatic transmissions) can cause the vehicle to roll away. This can cause accidents and serious personal injuries.


- When leaving the vehicle, always move the selector lever to Park (P), engage the parking brake, and pay attention to the warning messages in the instrument cluster display at all times.

NOTE

- Always be careful when you park in areas with parking barriers or high curbs. These vary in height and could damage your bumper and related parts if the front of your vehicle hits a barrier or curb that is too high while you are getting into or out of a parking spot. To help prevent damage, stop before the tires of your vehicle touch a parking barrier or curb.
- Always be careful when you enter a driveway or drive up or down steep ramps or over curbs or other obstacles. Parts of the vehicle close to the ground may be damaged (such as bumper covers, spoilers, and parts of the engine, suspension, and exhaust systems).

About the brakes



Read and follow the introductory information and safety information first ⇒  [Introduction to the subject](#)



and must first be broken in ⇒ . To some extent, you can make up for the somewhat reduced performance by applying more pressure to the brake pedal. But, during the break-in period , the stopping distance for hard braking and emergency braking will be longer until the brakes are fully broken in. Avoid hard braking and situations that might require hard braking (such as following other vehicles too closely) – especially during the break-in period.

Brake pad wear depends mostly on operating conditions and the way the vehicle is driven. If you do a lot of city and short-distance driving and/or have a sporty driving style, you should have the brake pads checked by an authorized Volkswagen dealer or authorized Volkswagen Service Facility more often than the regular service intervals.

Wet brakes (for example, after driving through water or washing the vehicle or after heavy rainfall) will not brake as well. Stopping distances will be longer when brake discs are wet or, in winter, even icy. Wet or icy brakes must be dried as soon as possible by carefully applying the brakes a couple of times while traveling at a relatively high speed. Make sure nobody is behind you and that you do not endanger yourself or others ⇒ .

Brakes coated with road salt also react slower and need longer stopping distances. If there is salt on the roads and you are not braking regularly, brake carefully and gently from time to time to remove any salt coating from the brake discs and pads ⇒ .

Brake disc corrosion (rust) and dirt buildup on the brake pads are more likely to occur if the vehicle is not driven much or is driven only for short distances with little braking. If the brakes have not been used and there is some rust on the discs, clean the brake discs and pads once in a while by carefully braking a couple of times while driving at relatively high speed to help clean the brake discs and pads. Make sure nobody is behind you and that you do not endanger yourself or others ⇒ .

Brake system malfunction

If you brake and find that the vehicle doesn't brake nearly as well as it used to (sudden increase in stopping distance), a brake circuit may have failed. The brake warning light or **BRAKE** will light up and a message may appear in the instrument cluster display. If you believe the vehicle is safe to drive, immediately take it to the nearest authorized Volkswagen dealer or authorized Volkswagen Service Facility for repair. Drive slowly and very carefully, allow for the longer stopping distance, and be ready to push longer and harder on the brake pedal to slow the vehicle down.

Brake booster



and beyond the pressure put on the brake pedal by the driver.

If the brake booster is not working, or if the vehicle has to be towed, you will have to push the brake pedal harder to make up for the lack of booster assistance and the resulting longer stopping distance ⇒ ⚠ .

WARNING

New brake pads do not provide maximum braking performance.

- New brake pads do not have the best stopping power for the first 200 miles (320 km) and must be broken in. You can compensate for the slightly reduced braking force by putting more pressure on the brake pedal.
- Drive with extra care while the new brake pads are being broken in. This reduces the risk of collisions and serious personal injuries due to a loss of control over the vehicle.
- Never follow other vehicles too closely or put yourself into other situations that might require sudden, hard braking, especially when the brake pads have not been broken in.

WARNING

Overheated brakes will reduce the vehicle's stopping power and increase stopping distances considerably.

- When driving downhill, the brakes have to work especially hard and heat up quickly.
- Before driving downhill, especially on hills that are long or steep, always reduce speed and shift into lower gear (manual or automatic transmission). This will let the vehicle use engine braking and reduce the load on the brakes. Otherwise, the brake system could overheat and possibly fail. Only use the brakes when you need them to slow the vehicle down more or to stop.
- A damaged front bumper or a non-standard spoiler can reduce airflow to the brakes and make them overheat.

WARNING



tances.

- Carefully apply the brakes to test them.
- Always dry brakes and clean off ice and salt coatings with a few cautious brake applications when visibility, weather, road and traffic conditions permit.

WARNING

Driving when the brake booster is not working increases stopping distances and can cause accidents and serious personal injuries.

- Never let the vehicle coast when the engine is switched off.
- If the brake booster is not working (such as when the vehicle is being towed), a lot more pedal force is needed to slow down and stop.

NOTE

- Never ride the brakes by keeping your foot on the brake pedal when you do not want to brake. Constant pressure on the brake pedal can make the brakes overheat. Riding the brakes will substantially reduce braking performance, increase stopping distance, and can cause complete brake system failure.
- Before driving downhill, especially on hills that are long or steep, always reduce speed and shift into lower gear (manual or automatic transmission). This will let the vehicle use engine braking and reduce the load on the brakes. Otherwise, the brake system could overheat and possibly fail. Only use the brakes when you need them to slow the vehicle down more or to stop.



When the front brakes are serviced, you should have the rear brake pads inspected at the same time. The wear of all brake pads should be visually checked regularly. The best way to check for brake pad wear is to have your authorized Volkswagen dealer or authorized Volkswagen Service Facility visually inspect the pads through the openings in the wheel rims or from underneath the vehicle. If necessary, the wheels can be taken off for a more thorough inspection.

Braking assistance systems



subject


The ESC, ABS, BAS, ASR, and EDL braking assistance systems work only when the engine is running. These systems can significantly improve active driving safety.

Electronic Stability Control (ESC)

ESC helps to improve road holding and vehicle dynamics to help reduce the probability of skidding and loss of vehicle control. It works only when the engine is running. ESC detects certain difficult driving situations, including when the vehicle is beginning to spin (yaw) out of control. ESC then helps you to get the vehicle back under control by selectively braking the wheels and/or reducing engine power and by providing steering assistance to help hold the vehicle on the driver's intended course.

ESC has limitations. It is important to remember that ESC cannot overcome the laws of physics. It will not always be able to help out under all conditions you may come up against. For example, ESC may not always be able to help you master situations where there is a sudden change in the coefficient of friction of the road surface. When there is a section of dry road that is suddenly covered with water, slush or snow, ESC cannot perform the same way it would on a dry surface. If the vehicle hydroplanes (rides on a cushion of water instead of the road surface), ESC will not be able to help you steer the vehicle because contact with the pavement has been interrupted and the vehicle cannot be braked or steered. During fast cornering, particularly on winding roads, ESC cannot always deal as effectively with difficult driving situations as it can at lower speeds. When towing a trailer, ESC is not able to help you regain control as it would if you were not towing a trailer.

Always adjust your speed and driving style to visibility, road, traffic, and weather conditions. ESC cannot override the vehicle's physical limits, increase the available traction, or keep a vehicle on the road if road departure is a result of driver inattention. Instead, ESC improves the possibility of keeping the vehicle under control and on the road during extreme maneuvers by using the driver's steering inputs to help keep the vehicle going in the intended direction. If you are traveling at a speed that causes you to run off the road before ESC can provide any assistance, you may not experience the benefits of ESC.

ESC includes and/or works together with the ABS, BAS, ASR, EDL, and XDL systems (see below). ESC is switched on all the time. In certain situations when you need less traction or additional traction cannot be achieved, you can switch off ASR in the Infotainment system by pressing the **CAR** button followed by the  and ESC System function keys ⇒ [Menu and system settings](#).



switched off by pressing the button. ESC Sport mode can also be switched on ⇒ [Switching Anti-Slip Regulation \(ASR\) and ESC Sport mode on and off](#).

Be sure to switch ASR on again when you no longer need less traction.

Automatic Post-Collision Braking System

In the event of an accident, the Automatic Post-Collision Braking System can help the driver to reduce the risk of skidding and the danger of secondary collisions through automatic braking.

The Automatic Post-Collision Braking System only functions in frontal, side, and rear collisions if the airbag control unit registers the corresponding triggering threshold during the accident, and the accident occurs at a speed greater than 6 mph (10 km/h).

The ESC brakes the vehicle automatically, provided that the hydraulic braking system, the ESC, and the electrical system are undamaged in the accident and remain functional.

The following actions override automatic braking in the event of an accident:

- When the driver depresses the accelerator. No automatic braking occurs.
- When the brake pressure transmitted through the depressed brake pedal is greater than the brake pressure provided by the system. The vehicle is braked manually.

Anti-Lock Brake System (ABS)

ABS helps to keep the wheels from locking up and helps to maintain the driver's ability to steer and control the vehicle. This means the vehicle is less likely to skid, even during hard braking:

- Push the brake pedal down hard and hold it there. Don't take your foot off the pedal or reduce the force on the pedal!
- Do not pump the brake pedal or let up on it!
- Steer the vehicle while pushing down hard on the brake pedal.
- ABS stops working if you release or let up on the brake.

When ABS is doing its job, you will notice a slight vibration through the brake pedal and hear a noise. *ABS cannot shorten the stopping distance under all conditions.* The stopping distance may even be longer, for instance, when driving on gravel or on newly fallen snow covering an icy or slippery sur-



Brake Assist (BAS)

The Brake Assist System can help to reduce stopping distances. If you press the brake pedal very quickly, BAS detects an emergency situation. It then very quickly builds up full brake system pressure, maximizing braking power and reducing the stopping distance. This way, ABS can be activated more quickly and efficiently.

Do not reduce pressure on the brake pedal! BAS switches off automatically as soon as you release or let up on the brake.

Anti-Slip Regulation (ASR)

ASR reduces engine power directed to spinning wheels and adjusts power to the road conditions. Even under poor road conditions, ASR can make it easier to get moving, accelerate, and climb hills.

ASR can be switched on and off manually ⇒ [Switching Anti-Slip Regulation \(ASR\) and ESC Sport mode on and off](#).

Electronic Differential Lock (EDL and XDL)

EDL is applied during regular straight-line acceleration. EDL gently brakes a drive wheel that has lost traction (spinning) and redirects the drive force to other drive wheels. In extreme cases, EDL automatically switches off to keep the brake from overheating. As soon as the brake has cooled down, EDL automatically switches on again.

XDL is an extension of the Electronic Differential Lock system. XDL does not react to drive wheel slippage when driving straight ahead. Instead, XDL detects slippage of the inside front wheel during fast cornering. XDL applies enough brake pressure to this wheel in order to stop the slippage. This improves traction, which helps the vehicle stay on track.

WARNING

Driving fast on icy, slippery, or wet roads can lead to a loss of control and result in serious personal injury for you and your passengers.

- Always adjust your speed and driving style to road, traffic, weather, and visibility conditions. Never let the additional safety that ESC, ABS, BAS, ASR, and EDL can provide tempt you into taking extra risks.
- Braking assistance systems cannot overcome the laws of physics and always prevent loss of



tems:

- Driving too fast on wet roads can cause the wheels to lose contact with the road and hydroplane. A vehicle that has lost road contact cannot be braked, steered, or controlled.
- These systems cannot reduce the risk of accident, for example if you drive too fast for conditions or if you do not keep your distance from the vehicle in front of you.
- Although these systems are very effective and can help you control the vehicle in many difficult situations, always remember that your vehicle handling control is limited by tire traction.
- When accelerating on a slippery surface, for example on ice and snow, depress the accelerator carefully. Even with these systems, the wheels may start to spin, leading to a loss of vehicle control.

WARNING

The effectiveness of ESC can be significantly reduced if other components and systems that affect vehicle dynamics, including but not limited to brakes, tires, and other systems mentioned above, are not properly maintained or functioning.

- Always remember that vehicle alterations or modifications can affect the functioning of the ABS, BAS, ASR, EDL, and ESC systems.
- Changing the vehicle suspension or using an unapproved tire/wheel combination can change the way the ABS, BAS, ASR, EDL, and ESC systems work and reduce their effectiveness.
- The effectiveness of ESC is also determined by the tires fitted ⇒ [Tires and wheels](#).



All 4 wheels must be equipped with identical tires in order for ESC and ASR to work properly. Differences in the tread circumference of the tires can cause the system to reduce the engine power when it is not expected.



If ABS is not working, ESC, ASR, and EDL will also not work.



You may hear noises when these systems are active.




Fig. 147 In the center console: Button for switching ASR or ESC Sport mode on and off manually (if equipped).



Read and follow the introductory information and safety information first ⇒ [Introduction to the subject](#)




The Electronic Stability Control (ESC) only works when the engine is running. This system includes ABS, EDL and ASR.


When ASR is switched off, a driver information message appears in the instrument cluster display and the  indicator light in the instrument cluster lights up ⇒ [Warning and indicator lights](#). Switch off ASR only in situations where there is not enough traction, such as the following:

- When driving in deep snow or on loose surfaces.
- When rocking the vehicle back and forth when you are stuck.

Afterward, activate ASR again.

Switching ASR on and off

- You can switch ASR off and on in the Infotainment system by pressing the **CAR** button followed by  and ESC System ⇒ [Vehicle settings menu](#).
- OR: If the vehicle is equipped with a  button in the lower center console ⇒ [Fig. 147](#), ASR can be switched off by pressing the button when the ignition is on. Press the  button again to switch ASR back on.

When ASR is switched off, a driver information message appears in the instrument cluster display and the  indicator light in the instrument cluster lights up ⇒ [Warning and indicator lights](#).

Depending on the vehicle model, when switching off the ASR, the ESC can also be switched off or the ESC sport mode (ESC Sport) can be switched on. ESC Sport can also be switched on in addition to switching off the ASR.

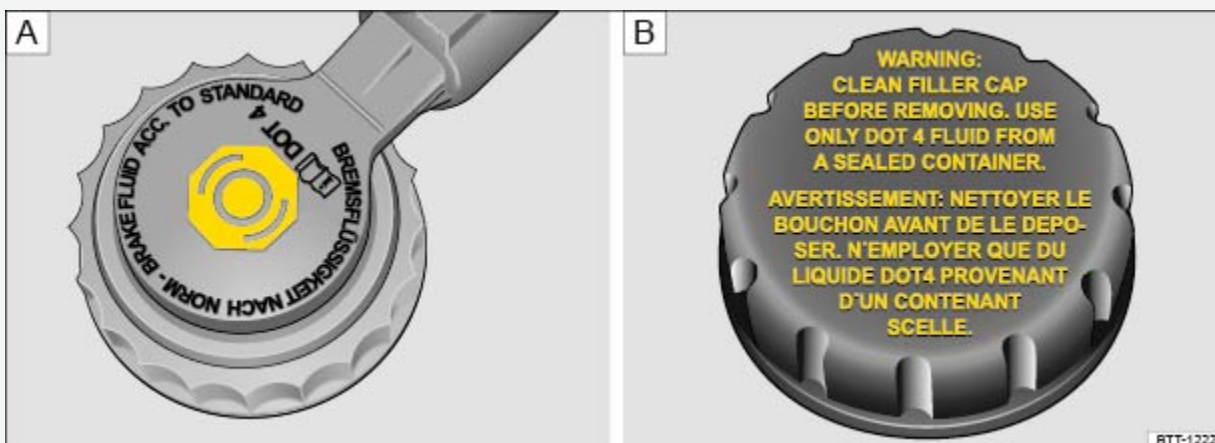
The brake intervention functions of ESC are limited when ESC Sport is switched on. It can be switched on and off by pressing the button ⇒ [Fig. 147](#).

Button	Golf GTI	Golf R
Press for about 1 second	ASR switched off	ASR switched off, ESC Sport switched on
Press and hold longer than 3 seconds	ASR switched off, ESC Sport switched on	ASR and ESC switched off
Press again	ASR (with ESC) switched on	ASR (with ESC) switched on





Depending on vehicle equipment, additional text messages may appear in the instrument cluster display to provide further information or to ask you to perform certain tasks ⇒ [Instrument cluster](#).

Brake fluid






Read and follow the introductory information and safety information first ⇒  [Introduction to the subject](#)

Brake fluid absorbs water from the air over time. Too much water in the brake fluid will damage the brake system. Water also lowers the boiling point of the brake fluid. Too much water in the brake fluid can cause vapor lock during heavy brake use or hard braking. Vapor lock reduces braking performance, increases stopping distances and can even cause total brake failure. Your safety and the safety of others depends on brakes that are working properly at all times ⇒ .

Brake fluid specifications

Volkswagen has developed a special brake fluid that is optimized for the brake system in your Volkswagen. Volkswagen recommends that you use brake fluid that expressly conforms to quality standard VW Standard 501 14 for optimum performance of the brake system. Check the information on the container for the brake fluid you want to use to make sure it meets the requirements for your vehicle.


Brake fluid that complies with VW Standard 501 14 can be purchased from your authorized Volkswagen dealer or authorized Volkswagen Service Facility.

If this special brake fluid is not available you may – under these circumstances – use another high quality brake fluid that complies with U.S. Federal Motor Vehicle Safety Standard (FMVSS) 116 DOT 4 ⇒ .

Please note, however, that not all brake fluids that comply with U.S. Federal Motor Vehicle Safety Standard (FMVSS) 116 DOT 4 have the same chemical composition. Some of these brake fluids can contain chemicals that could, over time, degrade or damage internal parts of the vehicle's brake system.

Volkswagen therefore recommends that you use brake fluid that expressly complies with VW Standard 501 14 for optimum brake system performance over the long term.

Brake fluid level

The fluid level in the transparent brake fluid reservoir must always be between the MIN and MAX marking ⇒ .



make it impossible to see the brake fluid level. If you cannot clearly see the brake fluid level in the brake fluid reservoir, please see an authorized Volkswagen dealer or authorized Volkswagen Service Facility.

The brake fluid level drops slightly when the vehicle is being used as the brake pads wear and the brakes are automatically adjusted.

Changing brake fluid

Brake fluid must be changed according to the service schedule in your \Rightarrow Booklet *Warranty and Maintenance*. Have the brake fluid checked by an authorized Volkswagen dealer or an authorized Volkswagen Service Facility. Refill only with new brake fluid that meets the standards listed above.

WARNING

Brake failure and reduced brake performance can be caused by not having enough brake fluid in the reservoir or by old or incorrect brake fluid.

- Check the brake system and brake fluid level regularly.
- Always change the brake fluid according to the service schedule in your \Rightarrow Booklet *Warranty and Maintenance*.
- Hard braking with old brake fluid may cause vapor lock. Vapor lock reduces braking performance, increases stopping distances and can even cause total brake failure.
- Always make sure that only the correct brake fluid is used. Only use brake fluid that expressly conforms to VW Standard 501 14 or, if it is not available, only use a high-quality brake fluid that conforms to U.S. Standard FMVSS 116 DOT 4 requirements.
- Using another brake fluid, or one that is not of high quality, can impair the function of the brake system and reduce its effectiveness. If the container does not say that the brake fluid complies with VW Standard 501 14, or U.S. Standard FMVSS 116 DOT 4, do not use it.
- The brake fluid must be new.

WARNING

Brake fluid is poisonous.

- To reduce the risk of poisoning, never use food, beverage or other non-original containers to



shape of the container, and drink the brake fluid. This could occur even if you relabel the container as brake fluid.

- Only store brake fluid in the closed, original container and keep it out of the reach of children.

NOTE

Brake fluid will damage vehicle paint, plastic parts, and tires. Wipe any brake fluid off vehicle paint and other vehicle parts immediately.



Brake fluid can pollute the environment. Brake fluid that has leaked out must be collected and disposed of properly, following all applicable environmental regulations.

Saving fuel and helping the environment



Introduction to the subject

In this chapter you will find information on the following subjects:

⇒ *Efficient driving style*

⇒ *Fuel-efficient driving*

⇒ *Think Blue. Trainer.*

Fuel consumption, environmental impact, and wear and tear on engine, brakes and tires depend mainly on the following 3 factors:

- Your personal driving style.
- External conditions (weather, road conditions).
- Technical requirements.

You can reduce fuel consumption by up to 25% by using a few simple techniques and adjusting your driving style.




WARNING



to the road, traffic, weather, and visibility conditions.

Efficient driving style



Read and follow the introductory information and safety information first ⇒  [Introduction to the subject](#)

Shifting faster

As a rule, the following applies: The higher gear is always the most efficient gear. The rule of thumb for most vehicles is to drive in 3rd gear at 20 mph (30 km/h), 4th gear at 25 mph (40 km/h), 5th gear at 30 mph (50 km/h), and 6th gear at 36 mph (60 km/h).

If traffic and driving conditions permit, skipping gears when upshifting also saves fuel.

Do not run the gears up to their limit. Use 1st gear only to start moving and then smoothly shift into 2nd gear. Avoid kick-downs in vehicles with automatic transmissions.

Coasting

If you take your foot off the accelerator, fuel delivery to the engine is interrupted, which lowers fuel consumption.

Therefore, when nearing a red stop light, for instance, allow the vehicle to coast without using the accelerator. Press the clutch pedal and release it only if the vehicle moving too slowly or the coasting distance is too long. The engine will then continue to run at idle.

In situations where the vehicle will be stopped for a longer period of time, such as at a railroad crossing, physically switch off the engine.

Defensive driving and flowing with traffic

Frequent braking and acceleration increase fuel consumption significantly. If you keep a sufficiently large distance away from the car in front of you, you can maintain a more constant speed. Active braking and accelerating is then not necessarily required.

Calm and smooth driving

Consistency is more important than speed. The more smoothly you drive, the less fuel the vehicle



When driving on the highway or freeway, a constant, moderate speed is more efficient and economical than constantly accelerating and braking. Usually you can reach your destination just as quickly by driving at a moderate, but steady speed.

The cruise control can assist in maintaining a uniform driving style.

Moderate use of extra electrical loads

Comfort inside the vehicle is nice and important, but it is important to use extra electrical loads in an environmentally conscious manner.

Some devices can increase fuel consumption when activated (examples):

- Climate control system (air conditioner): If the air conditioner has to produce starkly contrasting temperatures, it requires a large amount of energy, which is generated by the engine. The temperature in the vehicle should therefore not be extremely different from that of the outside temperature. It may be helpful to ventilate the vehicle before driving and then to drive a short distance with the windows open. After that, switch on the air conditioner with the windows closed. Keep the windows closed when driving at high speeds. Open windows increase fuel consumption.
- Switch off seat heating once it has served its purpose.
- Switch off the rear window defroster as soon as the windows are free of fog and ice.

Additional factors that increase fuel consumption (examples):

- Malfunctioning engine control.
- Driving in the mountains.
- Towing a trailer.

NOTE

Never let the vehicle coast or roll down a hill in Neutral (N), especially when the engine is not running. The transmission will not be lubricated and will be damaged.

Fuel-efficient driving

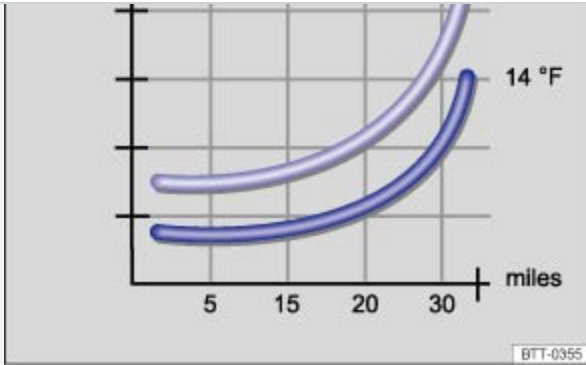


Fig. 149 Fuel consumption in miles per gallon (mpg) at 2 different outside air temperatures.



Fig. 150 Fuel consumption in l/100 km at 2 different outside air temperatures.



Read and follow the introductory information and safety information first ⇒ [Introduction to the subject](#)

Driving defensively and economically can easily reduce fuel consumption by 10 to 15%.

The vehicle consumes the most fuel when accelerating. Defensive driving requires less braking and therefore less acceleration. If possible, coast the vehicle to a stop, for example, when you can see that the next traffic light is red or about to turn red.

Avoid traveling short distances

A cold engine consumes significantly more fuel immediately after starting. It takes a few miles (km) before the engine is warmed up and fuel consumption is stabilized.

To reduce fuel consumption and the emission of pollutants effectively, the engine and catalytic converter must reach their optimal operating temperature. Critical in this context is also the outside air temperature.



once at +68 °F (+20 °C) and once at +14 °F (-10 °C).

Therefore, avoid driving short distances unnecessarily and consolidate routes.

Under the same conditions, the vehicle consumes more fuel in winter than in summer.

Letting the engine run to warm up is not only illegal in some places, but also technically not necessary and wastes fuel.

Adjust the tire pressure

The proper tire pressure helps reduce rolling resistance as well as fuel consumption.

When purchasing new tires, always make sure that the tires are optimized for lower rolling resistance.

Use low viscosity engine oil

Fully synthetic, low viscosity engine oils that expressly comply with Volkswagen oil quality standards reduce fuel consumption. Low viscosity engine oils reduce the frictional resistance on the engine and are distributed more evenly and quickly, particularly when cold-starting the engine. The effect is particularly apparent in vehicles that frequently travel short distances.

Always ensure the right engine oil level is maintained and keep to the scheduled service intervals (engine oil changes).

Make sure the engine oil that you purchase expressly complies with Volkswagen oil quality standards and is the oil approved by Volkswagen for your vehicle.

Avoid unnecessary weight

The lighter the vehicle, the more economical and eco-friendly it will be. For example, an extra 220 lbs (100 kg) of weight increases fuel consumption by up to 1 pint per 60 miles (0.3 l/100 km).

Remove all unnecessary items and unnecessary dead weight from the vehicle.

Remove unnecessary aftermarket components

The more aerodynamic the vehicle, the less fuel it will consume. Aftermarket components such as bicycle racks reduce its aerodynamic performance.

higher speeds.

Think Blue. Trainer.

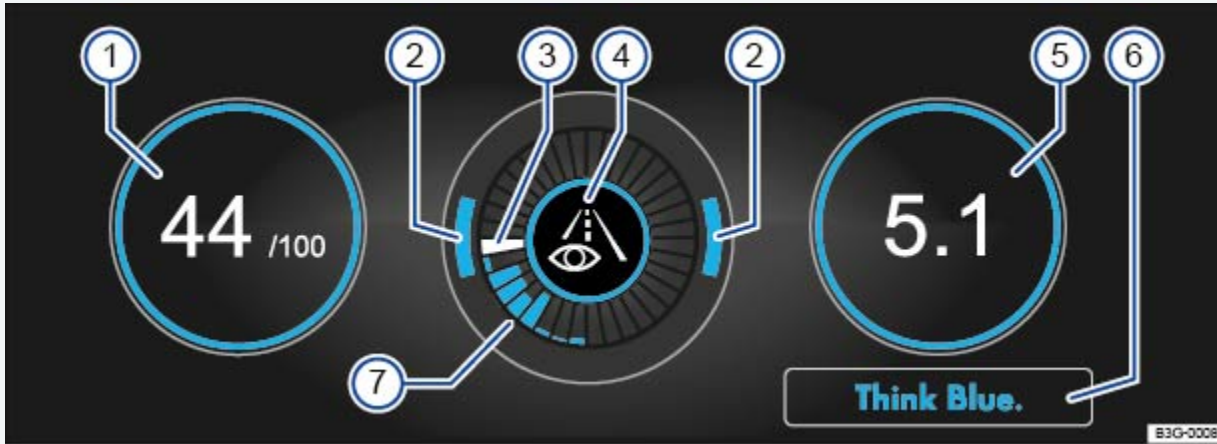



Fig. 151 Infotainment system screen: Think Blue. Trainer.



Read and follow the introductory information and safety information first ⇒  [Introduction to the subject](#)

The Think Blue. Trainer. analyzes your driving while the vehicle is moving forward. It then generates a visual display which can help you to adopt a more fuel-efficient driving style.

Key to
⇒ Fig. 1
51

Meaning



①	<p>The Blue Score is a rating of your driving style efficiency on a scale of 0 to 100. The higher the value displayed, the more efficient your driving style.</p> <p>You can touch the display to show the statistics for the last 30 minutes of the current trip. If the current driving time is less than 30 minutes, the values from the last trip are displayed in grey.</p> <p>A blue frame around the display indicates a fuel-efficient and consistent driving style. A grey frame indicates a less efficient driving style.</p>
②	<p>The position of the two arcs in the outer ring shows the acceleration. At a constant speed, the arcs appear in the central area. The arcs move up and down during braking and acceleration, respectively.</p>
③	<p>The white segment in the central ring shows the current evaluation status. It gradually moves clockwise about every 5 seconds, creating a blue segment each time. See ⑦.</p>
④	<p>Various symbols in the inner ring provide feedback about the current driving style:</p> <p>: Think ahead while driving.</p>



Fig. 2
51

Meaning

3>4: A different gear is recommended (larger number). Only applies to vehicles equipped with a gear recommendation feature.

: The current speed is not fuel-efficient.

eco: The current driving style is ecological and fuel-efficient.

The average fuel consumption is displayed in the units set by the driver, for example, Av. mpg or Av. l/100km. The value refers to the distance traveled since the start of the trip.

⑤

You can touch the display to show the statistics for the last 30 minutes of the current trip. If the current driving time is less than 30 minutes, the values from the last trip are displayed in grey.

A blue frame around the display indicates a fuel-efficient and consistent driving style. A grey frame indicates a less efficient driving style.

⑥

Tap the Think Blue. function key for additional tips on saving fuel.



Fig. 151	Training
⑦	The blue segments in the central ring show driving style efficiency. Each segment indicates an elapsed time of about 5 seconds. The larger the blue segment, the more efficient the driving style during this period.

Displaying the Think Blue. Trainer.

When the vehicle is stationary, press the **CAR** Infotainment button until the Think Blue. Trainer.

⇒ Fig. 151 is displayed ⇒ *Infotainment system*.

OR: When the vehicle is stationary, press the **CAR** Infotainment button once, then tap the Selection function key and select Think Blue. Trainer..

WARNING

Never pay so much attention to the graphics shown on the screen that you fail to notice what is going on around you.

- Always pay close attention to what is happening around the vehicle.

Driver assistance systems

Starting assistance systems

Introduction to the subject

In this chapter you will find information on the following subjects:

⇒ *Indicator light*

⇒ *Hill Start Assist (Hill Hold)*

⇒ *Auto Hold (Golf R)*



The intelligent technology of the dynamic starting assistance features cannot overcome the laws of physics. Never let the increased convenience provided by the dynamic starting assistance features tempt you into taking risks.

- Unintended vehicle movement can cause serious personal injury.
- The dynamic starting assistance features are no substitute for careful and attentive driving.
- Always adapt your speed and driving style to visibility, weather, road, and traffic conditions.
- The dynamic starting assistance features cannot keep the vehicle from moving in all hill-start situations (for example, if the ground is slippery or icy).
- Never activate the throttle manually from the engine compartment when the engine is running and the automatic transmission is in gear. The vehicle will start to move as soon as the engine speed increases, even if the parking brake is set.


WARNING


Driving with too little fuel in the fuel tank increases the risk of stalling, especially when driving up and down hills.

- If your vehicle stalls suddenly, this can cause an accident and serious personal injuries.
- Driver assistance and braking assistance systems can malfunction when there is too little fuel in the tank and cause you to lose control of the vehicle.
- Never drive until the fuel tank is almost empty.

Indicator light



Read and follow the introductory information and safety information first ⇒  *Introduction to the subject*

Lights up Possible cause or meaning ⇒ 



The vehicle is being held by the Auto Hold feature (if equipped).



Switch off the Auto Hold feature, if necessary ⇒ [Auto Hold \(Golf R\)](#).

When the ignition is switched on, several warning and indicator lights come on briefly for a function check. They go out after a few seconds.

WARNING

Failure to heed warning lights and instrument cluster text messages can cause the vehicle to break down in traffic and result in a collision and serious personal injury.

- Never ignore warning lights or text WARNINGS.
- Always stop the vehicle as soon as it is safe to do so.

NOTE

Failure to heed warning lights or text WARNINGS can result in vehicle damage.

Hill Start Assist (Hill Hold)



Read and follow the introductory information and safety information first ⇒ [Introduction to the subject](#)

Some vehicles are equipped with Hill Start Assist (Hill Hold), a feature that helps keep the vehicle from rolling backwards when starting out on a hill, for example after stopping at a traffic light. You don't have to apply and release the parking brake while depressing the accelerator. For Hill Start Assist to work, the engine must be running and the vehicle must be in First Gear or Reverse (manual transmission) or in Drive or Sport Drive (D/S) or Reverse (R) (automatic transmission) and you must use the foot brake to hold the vehicle before starting to move.

Hill Start Assist keeps the brake applied for almost 2 seconds with the same force you used to prevent



manual transmission vehicle, and gently depress the accelerator to get the vehicle moving again. If you do not depress the accelerator pedal and get the vehicle moving again within this time, the brakes will release and the vehicle will roll downhill. Furthermore, if any requirement for engaging Hill Start Assist is no longer met while the vehicle is stopped, Hill Start Assist disengages and the brakes are automatically released and will no longer hold the vehicle.

Hill Start Assist is activated automatically when points 1 to 3 are met at the same time:

Step	Manual transmission	Automatic transmission
1.	Hold the stopped vehicle on an incline with the foot or parking brake.	
2.	The engine must be running smoothly.	
3.	A manual transmission vehicle must be in 1st gear (1) if headed up a hill or in Reverse (R) if backing up a hill; you must hold the clutch down and the foot brake must be depressed to keep the vehicle from moving.	An automatic transmission vehicle must be in Reverse (R) or Drive or Sport Drive (D/S), and the foot brake must be depressed to keep the vehicle from moving.
4.	To drive off, take your foot off the brake pedal as you let the clutch out and gently depress the accelerator within 2 seconds. If the accelerator is not depressed, the brakes will release automatically.	To drive off, take your foot off the brake pedal and gently depress the accelerator within 2 seconds.

Hill Start Assist is immediately deactivated:

- If the engine is not running smoothly or the engine malfunctions.
- If the engine stalls or is switched off.
- *Automatic transmission vehicles:* If the transmission is in Neutral (N).
- *Automatic transmission vehicles:* If a tire does not have enough road contact (such as when the vehicle is tipped or at an angle).

WARNING

The intelligent technology of Hill Start Assist cannot overcome the laws of physics. Never let the increased convenience provided by Hill Start Assist tempt you into taking risks.

- The Hill Start Assist feature cannot hold the vehicle in all hill start situations (for example, if the surface is icy or slippery).
- Hill Start Assist can only help keep the vehicle from moving for less than 2 seconds. After that, the brakes will be released and the vehicle can roll down the hill.

Auto Hold (Golf R)



Fig. 152 In the lower center console: Button for Auto Hold (if equipped).




Read and follow the introductory information and safety information first ⇒ [Introduction to the subject](#)


Depending on vehicle equipment, models equipped with an electronic parking brake may also be equipped with the Auto Hold feature.

The indicator light in the **AUTO HOLD** button ⇒ Fig. 152 (arrow) lights up when the feature is switched on.




out the driver having to press the brake pedal.


The Auto Hold feature holds the vehicle as soon as it detects that the vehicle is not moving and the brake pedal is released. The green indicator light  in the instrument cluster display lights up to show that the vehicle is being held by the electronic parking brake.



When the driver accelerates, the Auto Hold feature releases the electronic parking brake again. The green indicator light  in the instrument cluster display goes out and the vehicle begins to move, depending on the incline.

Requirements for holding the vehicle with Auto Hold:


- The driver door is closed.
- The driver is wearing a safety belt.
- The engine is running.


Vehicles with automatic transmission: If the selector lever is moved to position N, Auto Hold will not switch on and will remain deactivated. The vehicle will not be held at a standstill ⇒ .

If any of the conditions for using Auto Hold change while the vehicle is not moving, the Auto Hold feature switches off automatically and the green indicator light  in the instrument cluster display goes out, along with the yellow indicator light in the **AUTO HOLD** button.

The electronic parking brake may engage automatically to hold the vehicle securely ⇒ . The red indicator light  or **PARK** comes on in the instrument cluster display.

Switching Auto Hold on and off manually

Press the **AUTO HOLD** button ⇒ . The indicator light in the button ⇒ [Fig. 152](#) (arrow) goes out when Auto Hold is switched off.

If Auto Hold is switched off while it is holding the vehicle in place, the electronic parking brake switches on automatically. The electronic parking brake will not switch on if the brake pedal is depressed when Auto Hold is switched off ⇒ .

Switching Auto Hold on and off automatically


If Auto Hold has been switched on using the **AUTO HOLD** button before switching the ignition off, the Auto Hold feature switches on automatically when the ignition is switched on the next time. The



switched on again.

Switching Auto Hold off temporarily using the electronic parking brake

You can switch the Auto Hold feature off temporarily so that the vehicle can roll more easily, for example, when maneuvering.

- With the engine switched on, depress the brake pedal.
- Press the  switch ⇒ *Electronic parking brake (Golf R)*. Auto Hold switches off.

Auto Hold switches on again as soon as the brake pedal is depressed and the vehicle comes to a standstill.

WARNING

The intelligent technology of the Auto Hold feature cannot overcome the laws of physics. Never let the increased convenience provided by the Auto Hold feature tempt you into taking risks.

- Never leave the vehicle with the engine running and the Auto Hold feature switched on.
- The Auto Hold feature cannot keep the vehicle from moving in all hill-start situations (for example, if the ground is slippery or icy).
- Unintended vehicle movement can cause serious personal injury.

NOTE

Before entering a car wash, always deactivate Auto Hold. Otherwise, the electronic parking brake can engage automatically and cause damage.

Cruise control



Introduction to the subject

In this chapter you will find information on the following subjects:

⇒ *Indicator lights*

⇒ *Cruise control operation*



stant speed when driving above about 15 mph (20 km/h).

Cruise control slows down the vehicle only by reducing the flow of fuel to the engine, not by braking

⇒  .

WARNING

Using the cruise control when it is not possible to drive safely at a constant speed can be dangerous and can lead to an accident and serious personal injuries.

- Never use cruise control when driving in heavy or varying traffic or when you cannot keep a safe distance between you and the vehicles ahead of you.
- Never use cruise control on steep, winding, or slippery roads (such gravel roads, wet roads, or snowy or icy roads) or on roads with standing water.
- Never use cruise control when driving off-road or on unpaved roads.
- Always adjust your speed and the distance you keep between you and the vehicles ahead of you to the road, traffic, weather, and visibility conditions.
- To help prevent unintended operation of cruise control, switch the system off when it is not being used.
- It is dangerous to use the Resume feature when the previously set speed is too high for the existing road, traffic, or weather conditions.
- When going downhill, the cruise control may not be able to maintain a constant speed. The vehicle will speed up because of its own weight. Downshift and/or use the foot brake to slow the vehicle.

Indicator lights



Fig. 153 In the instrument cluster display: Cruise control status indications.



Read and follow the introductory information and safety information first ⇒ [Introduction to the subject](#)

Display

Different cruise control versions are available. The stored speed is shown in the instrument cluster display on some equipment versions.

Status ⇒ [Fig. 153](#)



Cruise control temporarily deactivated. Stored speed displayed in a darker shade or in smaller numbers.



System malfunction. See an authorized Volkswagen dealer or an authorized Volkswagen Service Facility.



Cruise control activated. No speed stored in memory.



Cruise control is active. Stored speed displayed in white or in larger numbers.

Indicator lights

Lights up Possible cause



Cruise control is regulating the vehicle speed.

When the ignition is switched on, several warning and indicator lights come on briefly for a function check. They go out after a few seconds.

Failure to heed warning lights and instrument cluster text messages can cause the vehicle to break down in traffic and result in a collision and serious personal injury.

- Never ignore warning lights or text WARNINGS.
- Always stop the vehicle as soon as it is safe to do so.

NOTE

Failure to heed warning lights or text WARNINGS can result in vehicle damage.



If the cruise control is switched on when the ignition is switched off, it may be switched on automatically the next time the ignition is switched on, depending on vehicle equipment. No speed is stored for the cruise control.



The displays may vary depending on vehicle equipment.

Cruise control operation



Fig. 154 On the turn signal lever: Cruise control buttons and switches (if equipped).




Fig. 155 Left-hand side of the multi-function steering wheel (if equipped): Buttons for operating the cruise control.

Read and follow the introductory information and safety information first ⇒ [Introduction to the subject](#)

In order to:	You must: ⇒ Fig. 154 or ⇒ Fig. 155	Result:
Switch on cruise control.	<p>Move switch ① on the turn signal lever to the ON position.</p> <p>OR: Press the button on the multi-function steering wheel.</p>	System is switched on, but does not regulate vehicle speed until a speed is set.
Set cruise control to current vehicle speed.	<p>Press button ② on the turn signal lever in the area marked SET/-.</p> <p>OR: Press the SET button on the multi-function steering wheel.</p>	Current vehicle speed is set; cruise control helps to maintain this speed.



<p>Temporarily deactivate cruise control.</p>	<p>Move switch ① on the turn signal lever to the CANCEL position.</p> <p>OR: Press the CNL button on the multi-function steering wheel.</p> <p>OR: Briefly press the  button on the multi-function steering wheel.</p> <p>OR: Depress the brake pedal.</p>	<p>Cruise control is temporarily deactivated. The speed is still stored in the memory.</p>
<p>Resume speed stored in cruise control.</p>	<p>Press button ② on the turn signal lever in the area marked RES/+.</p> <p>OR: Press the RES button on the multi-function steering wheel.</p>	<p>Cruise control resumes speed previously set.</p>





<p>Increase set speed (while cruise control is actively controlling vehicle speed).</p>	<p>Press button ② on the turn signal lever in the area marked RES/+.</p> <p>OR: Press the + button on the multifunction steering wheel.</p> <p><i>Press briefly</i> to increase the speed by 1 mph (1 km/h) and store it.</p> <p><i>Press and hold</i> to increase the stored speed continuously until you release the button.</p>	<p>The vehicle will accelerate until the new higher speed is reached and saves the new higher speed in the memory.</p>
---	--	--



<p>Reduce set speed (while cruise control is actively controlling vehicle speed).</p>	<p>Press button ② on the turn signal lever in the area marked SET/-.</p> <p>OR: Press the - button on the multi-function steering wheel.</p> <p><i>Press briefly</i> to reduce the speed by 1 mph (1 km/h) and store it.</p> <p><i>Press and hold</i> to reduce the stored speed continuously until you release the button.</p>	<p>Cruise control will slow the vehicle down <i>without braking</i> by reducing the flow of fuel to the engine until the new lower speed is reached and saves the new lower speed in the memory.</p>
---	---	--



Switch off cruise control.	Move switch ① to the OFF position. OR: Briefly press the  button <i>twice</i> on the multi-function steering wheel with active regulation. OR: In any operating mode, press <i>and hold</i> the  button on the multi-function steering wheel.	System is switched off. The set speed is deleted.
----------------------------	--	---

Changing gears when cruise control is active (manual transmission only)

The cruise control reduces acceleration as soon as the clutch pedal is pressed, and automatically continues to regulate the speed after a gear change.

Driving downhill with cruise control

If cruise control cannot maintain constant speed while driving downhill, slow the vehicle with the foot brake and downshift if necessary.

Automatic deactivation

Cruise control speed regulation is automatically deactivated or temporarily interrupted:

- If the system detects an error that could affect the function of the cruise control.
- If the vehicle has accelerated and goes faster than the stored speed for a longer time.
- If the brake pedal is depressed.
- If regulation related to driving dynamics is taking place, for example, through ESC.



- *Automatic transmission:* If the selector lever is shifted to Neutral (N). The cruise control will not deactivate when shifting between D/S and Tiptronic mode.

Adaptive Cruise Control (ACC)



Introduction to the subject

In this chapter you will find information on the following subjects:

⇒ *Display, warning and indicator lights*


⇒ *Radar sensor*

⇒ *Operating Adaptive Cruise Control (ACC)*

⇒ *When to temporarily switch off Adaptive Cruise Control (ACC)*

⇒ *Special driving situations*

Your vehicle may be equipped with the Adaptive Cruise Control system (ACC), which helps maintain an individually stored constant speed between about 20 mph (30 km/h) and 95 mph (150 km/h) and a previously set distance in time intervals between your vehicle and those in front of you.

The vehicle may be braked, if the situation so requires, to a standstill by an active braking maneuver ⇒  .

Driver intervention warning

Adaptive Cruise Control has system-specified limits. As a driver, you must control the speed and the distance to other vehicles under some circumstances. If that is necessary, the system requests the driver to take over using a visual and audible warning , even if the vehicle can be braked to a standstill by an active braking maneuver.

WARNING

Always remember that the Adaptive Cruise Control has limits – Using Adaptive Cruise Control when it is not possible to drive safely at a constant speed can be dangerous and can lead to an accident and serious personal injury.



drive towards an obstacle or something on or near the road that is not moving, such as vehicles stopped in a traffic jam, a stalled or disabled vehicle.

- Always adjust your speed and the distance you keep between you and the vehicles ahead of you to the road, traffic, weather, and visibility conditions.
- Never use Adaptive Cruise Control on steep, winding, or slippery roads (such gravel roads, wet roads, or snowy or icy roads) or on roads with standing water.
- Never use Adaptive Cruise Control when driving in heavy or varying stop-and-go traffic.
- Never use Adaptive Cruise Control when driving off-road or on unpaved roads.
- Always remember that the Adaptive Cruise Control cannot detect a vehicle that is driving towards you in your traffic lane and that it cannot detect narrow vehicles such as motorcycles and bicycles.
- Never follow a vehicle so closely that you cannot stop your vehicle safely. The Adaptive Cruise Control cannot slow or brake the vehicle safely when you follow another vehicle too closely. Always remember that the Adaptive Cruise Control has a braking power that is only about 30% of the vehicle's maximum braking ability, under certain circumstances the automatic braking function cannot bring the vehicle to a stop in time.
- Always turn off Adaptive Cruise Control when entering turn lanes, exit lanes and construction zones or in similar situations because the vehicle will automatically accelerate to the stored speed when the road ahead is clear.
- To help prevent unintended operation of Adaptive Cruise Control, switch the system off when it is not being used.
- It is dangerous to use the Resume feature when the previously set speed is too high for the existing road, traffic, or weather conditions.
- When traveling downhill, the Adaptive Cruise Control may not be able to maintain a constant speed. The vehicle will speed up because of its own weight. Downshift and/or use the foot brake to slow the vehicle.
- Never allow the closing speed between you and other vehicles to be so high that the Adaptive Cruise Control may not be able to slow your vehicle safely. If closing speed is too high, you must apply the brakes yourself to reduce the risk of a rear-end crash.
- If a driver intervention warning or Front Assist warning appears in the instrument cluster display, immediately take over the control of the brake and gas pedals and slow down the vehicle

- Always be prepared to take over the control of the brake and the gas pedal in every situation.

NOTE

If you suspect that ACC doesn't work properly or the sensors are damaged, switch off ACC immediately.

- Go see an authorized Volkswagen dealer or Volkswagen Service Facility for assistance and have the ACC system checked.



The ACC restricts the vehicle speed to 95 mph (150 km/h).



If the ACC is active, you may hear noise during the automatic braking procedure. This is normal; the noises are caused by the braking system.

Display, warning and indicator lights

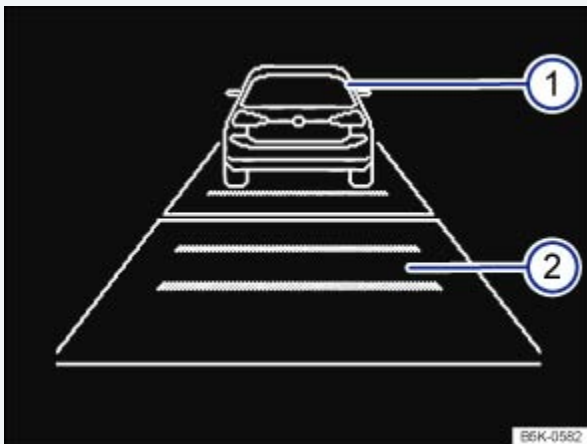


Fig. 156 In the instrument cluster display: ACC deactivated temporarily; vehicle detected ahead, time interval set (displayed in color on an instrument cluster with color display).

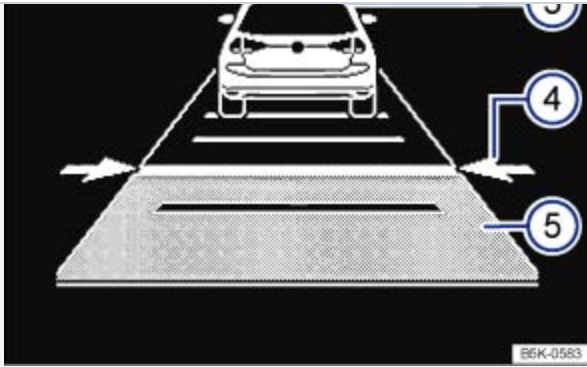


Fig. 157 In the instrument cluster display: ACC active, vehicle detected ahead, time interval is being set (displayed in color on an instrument cluster with color display).



Read and follow the introductory information and safety information first ⇒ *Introduction to the subject*

Displays

Key to ⇒ *Fig. 156* or ⇒ *Fig. 157* :

- ① Vehicle detected ahead (ACC inactive)
- ② Selected distance range (ACC inactive)
- ③ Vehicle detected ahead when ACC is active
- ④ Setting the time interval to the vehicle ahead while traveling at the stored speed
- ⑤ Time interval to the vehicle ahead while traveling at the stored speed has been set

Warning and indicator lights

Lights up Possible cause and action, if necessary ⇒

The deceleration of the ACC automatic braking system is not sufficient to bring the vehicle to a full stop in time.



Depress the brake pedal! Driver intervention warning!



ACC currently not available.^{a)}



Park your vehicle and turn the engine off and on again. Check the sensor for damages or soiling. If the system is still not available, have it checked by an authorized Volkswagen dealer or authorized Volkswagen Service Facility.



ACC is active. No vehicle has been detected ahead. The system is regulating vehicle speed.

When displayed in white: ACC active. Vehicle detected ahead. ACC regulates the speed and the distance from the vehicle ahead.



When displayed in grey: ACC not active. System switched on, does not regulate.



ACC is switched on and active.

When the ignition is switched on, several warning and indicator lights come on briefly for a function check. They go out after a few seconds.

WARNING

Failure to heed warning lights and instrument cluster text messages can cause the vehicle to break down in traffic and result in a collision and serious personal injury.

- Never ignore warning lights or text WARNINGS.
- Always stop the vehicle as soon as it is safe to do so.

Failure to heed warning lights or text WARNINGS can result in vehicle damage.



When the ACC is switched on, the display in the instrument cluster can be overwritten by other functions, for example, incoming telephone calls.

a) Displayed in color on an instrument cluster with color display.

Radar sensor

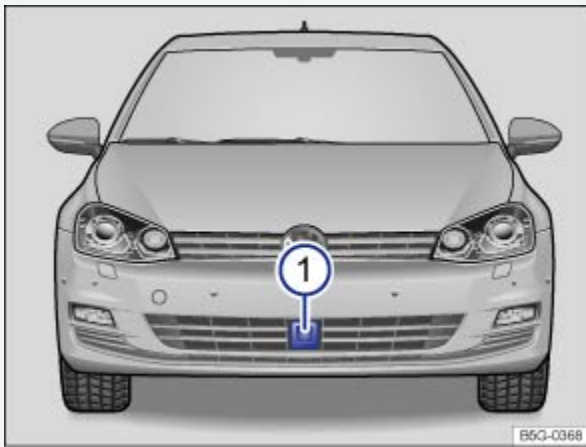


Fig. 158 In the front bumper: Radar sensor.

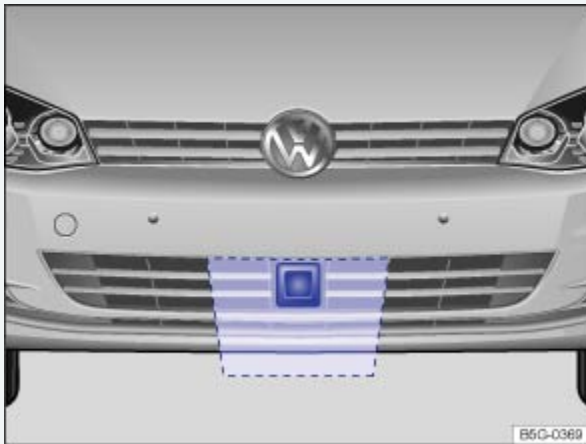


Fig. 159 Area around the radar sensor to be kept clean and free of obstructions.




Read and follow the introductory information and safety information first ⇒ *Introduction to the subject*

Vehicles equipped with ACC have a radar sensor below the front bumper to monitor the traffic situa-



your vehicle.

The radar sensor function can be impaired by things such as mud, slush, or snow, or by conditions such as heavy rain or spray. In cases like these, the ACC may not work. The driver message ACC not available appears in the instrument cluster display. Clean the radar sensor as required ⇒ .

The ACC will automatically be available again as soon as the radar sensor is no longer impaired. The message in the instrument cluster display turns off.

The area in front of and around the radar sensor ⇒ [Fig. 159](#) must not be covered by objects such as stickers, additional headlights, a license plate bracket, or other things, as these items can impair the function of the ACC system.

Any structural modifications to the vehicle, for example, lowering the vehicle or alterations to the front end trim, can impair the function of the ACC system. Structural modifications should only be carried out by a qualified workshop ⇒ [Parts, accessories, repairs, and modifications](#). Contact an authorized Volkswagen dealer or an authorized Volkswagen Service Facility for assistance.

Incorrectly performed repairs to the front end of the vehicle can change the position of the radar sensor and therefore impair the function of the ACC system. Repair work should only be carried out by a qualified workshop. Contact an authorized Volkswagen dealer or an authorized Volkswagen Service Facility for assistance.

NOTE

If you notice that the Adaptive Cruise Control (ACC) or Front Assist doesn't work properly, or if you suspect that the radar sensor has been damaged or if its position has been changed, switch off ACC immediately. This can help prevent further damage. Contact an authorized Volkswagen dealer or an authorized Volkswagen Service Facility to have the radar sensor realigned.

- The radar sensor can become misaligned if it is hit, for example, when parking the vehicle. Readjusting the sensor could impair the performance of the system or cause it to switch off.
- Repairs to the radar sensor require special knowledge and tools. Contact an authorized Volkswagen dealer or an authorized Volkswagen Service Facility for assistance.
- Remove snow with a brush, and remove ice with a solvent-free deicer spray.
- A Declaration of Compliance with the United States FCC and Industry Canada regulations is found on ⇒ [Declaration of Compliance, Telecommunications and Electronic Systems](#).



Fig. 160 Left-hand side of the multifunction steering wheel: Buttons for operating the Adaptive Cruise Control (ACC).

Read and follow the introductory information and safety information first ⇒ [Introduction to the subject](#)

When the Adaptive Cruise Control (ACC) is switched on, the green indicator light comes on in the instrument cluster, and the ACC speed memory and status are shown in the display ⇒ [Fig. 156](#).

Conditions for starting the Adaptive Cruise Control


- *Vehicles with automatic transmission:* The selector lever must be in D/S or the Tiptronic position.
- *Vehicles with manual transmission:* A forward gear, but not first gear, must be selected. The current vehicle speed should be at least 16 mph (25 km/h) if no speed is stored.

Controlling speed

When switched on, the speed can be stored and set. The stored speed can vary from the speed actually being driven if the distance is being actively controlled.

In order to:	You must: ⇒ Fig. 160	Result:
Switch on ACC	Press the button on the multifunction steering wheel.	The ACC is switched on, but not activated.





Activate ACC	Press the SET button on the multi-function steering wheel.	The current speed is stored and controlled.
Temporarily deactivate ACC	<p><i>Briefly</i> press the  button on the multi-function steering wheel.</p> <p>OR: Depress the brake pedal.</p> <p>OR: Press the CNL button on the multi-function steering wheel.</p>	Speed regulation is temporarily deactivated. The set speed is still stored.
Resume speed regulation (reactivate ACC)	Press the RES button on the multi-function steering wheel.	<p>The speed regulation resumes at the stored speed value.</p> <p>If no speed has yet been stored, the current speed is stored and controlled.</p>



<p>Increase set speed (while ACC is actively regulating vehicle speed)</p>	<p>Press the + button on the multi-function steering wheel.</p> <p><i>Press briefly</i> to increase the speed by 1 mph (1 km/h) and store it.</p> <p><i>Press and hold</i> to increase the stored speed in increments of 5 mph (10 km/h) until you release the button.</p>	<p>The vehicle accelerates until the new higher speed is reached and saves the new higher speed in the memory.</p>
<p>Reduce set speed (while ACC is actively regulating vehicle speed)</p>	<p>Press the - button on the multi-function steering wheel.</p> <p><i>Press briefly</i> to reduce the speed by 1 mph (1 km/h) and store it.</p> <p><i>Press and hold</i> to reduce the stored speed in increments of 5 mph (10 km/h) until you release the button.</p>	<p>Speed is reduced by accelerator release or automatic braking until the new lower speed is reached.</p>



Switch off ACC	<p>Press and hold the  button on the multi-function steering wheel. <i>Briefly</i> press the  button on the multi-function steering wheel if the ACC is temporarily switched off.</p>	The system is switched off and the stored speed is canceled.
----------------	---	--



Setting the distance level

You can set the speed-dependent distance from the vehicle ahead to one of 5 levels.


In wet road conditions, you should always set a larger distance than when driving in dry road conditions.

The following distances can be selected:

- Very close
- Close
- Medium
- Far
- Very far

The distance level to the vehicle ahead is set using the  button on the multi-function steering wheel ⇒ [Fig. 160](#). The ACC display appears when the button is pressed ⇒ [Display, warning and indicator lights](#). To set the distance level, press the  button.

When the highest level is reached, the distance returns to the lowest level when the button is pressed again.


The distance level can also be set using the **+** or **-** buttons on the multi-function steering wheel immediately after the  button on the multi-function steering wheel ⇒ [Fig. 160](#) has been pressed.

Setting the drive program



equipped vehicles, the following drive programs can be selected:

- Eco
- Comfort
- Normal
- Sport

The acceleration response can be influenced by the drive program selected in the Infotainment system by pressing the **CAR** button followed by the  and Assistance systems function keys ⇒ [Menu and system settings](#).

The following conditions could prevent the ACC from reacting, or delay its ability to react:

- When driving in tight curves.
- When the accelerator pedal is depressed.
- When Front Assist is switched off or if there is a fault.
- When no gear is selected.
- When the ESC is taking corrective action.
- When the driver safety belt is not buckled.
- When several brake lights on the vehicle or trailer are faulty.
- When the radar sensor is dirty or covered.
- When the vehicle is in Reverse (R).
- When weather conditions are poor.
- When narrow vehicles, such as motorcycles, are moving in front of your vehicle.
- When vehicles are traveling slightly offset to the left or right in front of your vehicle.
- When there is strong reflected radiation of the radar signal, for example, in multilevel parking structures.
- When vehicles are crossing in front of your vehicle.
- When there is oncoming traffic.



- When a stationary obstacle, such as a broken-down vehicle, is in front of your vehicle.
- When loads or attachment parts on other vehicles in front of your vehicle protrude to the side, rear, or above the normal vehicle dimensions.
- When the vehicle is traveling faster than about 95 mph (150 km/h).

DANGER!

Following other vehicles too closely increases the risk of collisions and serious personal injury or even death.

- Always obey applicable traffic laws when setting the distance to the vehicles ahead in traffic.
- Setting short distances to the traffic ahead reduces the time and distance available to bring your vehicle to a safe stop and makes it even more necessary to pay close attention to traffic.
- Always use good judgment and select a safe following distance for the traffic, road and weather conditions.
- Never use Adaptive Cruise Control on narrow or winding roads or under poor road conditions (snow, ice, streets covered with standing water or gravel, for example) or when visibility is poor, especially when it is foggy.
- Always select a greater following distance to the vehicle ahead on wet roads than on dry roads.

WARNING

Improper use of the Adaptive Cruise Control can cause collisions, other accidents and serious personal injury.

- Always remember that the Adaptive Cruise Control has limits – it will not slow the vehicle down or maintain the set distance when you drive towards an obstacle or something on or near the road that is not moving, such as vehicles stopped in a traffic jam, a stalled or disabled vehicle.
- Always remember that the Adaptive Cruise Control cannot detect a vehicle that is driving towards you in your traffic lane and that it cannot detect narrow vehicles such as motorcycles and bicycles.



- Never follow a vehicle so closely that you cannot stop your vehicle safely. The Adaptive Cruise Control cannot slow or brake the vehicle safely when you follow another vehicle too closely. Always remember that the Adaptive Cruise Control has a braking power that is only about 30% of the vehicle's maximum braking ability, and the automatic braking function cannot bring the vehicle to a stop.
- Never use Adaptive Cruise Control when you cannot drive safely at a steady speed, including on city streets, on winding roads or when road conditions are poor (for example, on ice, gravel, in fog, heavy rain or on wet roads that increase the risk of hydroplaning).
- The radar sensor's *vision* can be reduced by rain, snow and heavy road spray. These and similar conditions can prevent vehicles up ahead from being accurately detected and in some cases they may not be detected at all. Do not use ACC when the radar sensors cannot accurately detect vehicles moving ahead of you in traffic.
- Always turn off Adaptive Cruise Control when entering turn lanes, exit lanes and construction zones or in similar situations because the vehicle will automatically accelerate to the stored speed when the road ahead is clear.
- Never rest your foot on the accelerator pedal, especially when the Adaptive Cruise Control is being used because doing so will override the braking function.
- Always pay attention to traffic, especially when Adaptive Cruise Control is switched on.
- Always maintain a safe speed and distance between your vehicle and other vehicles while considering the traffic situation. This is the duty of the driver. Adaptive Cruise Control is merely an aid to the driver.
- To prevent unintended operation, always switch ACC off when it is not being used.
- It is dangerous to use the Resume feature when the previously set speed is too high for existing road, traffic or weather conditions.
- Always select a speed and distance to traffic ahead that is safe and appropriate under the prevailing traffic, road, weather and lighting conditions.
- Never allow the closing speed between you and other vehicles to be so high that the Adaptive Cruise Control may not be able to slow your vehicle safely. If closing speed is too high, you must apply the brakes yourself to reduce the risk of a rear-end crash.

The stored speed is canceled when the ignition of the ACC is switched on.



ACC is automatically deactivated when ASR is switched off.

When to temporarily switch off Adaptive Cruise Control (ACC)



Read and follow the introductory information and safety information first ⇒ [Introduction to the subject](#)

Please deactivate ACC under following conditions due to system limitations ⇒ :

- When driving around curves, turn lanes, highway ramps, or construction sites; to prevent unwanted acceleration of the vehicle.
- When driving through tunnels.
- On roads with more than one lane, if other vehicles are driving more slowly in the fast lane. Vehicles in other lanes will normally not be detected and will, in this case, be passed from the slow lane.
- Under bad weather conditions or bad visibility, for example, in heavy rain, snowfall, or fog.

WARNING

Not deactivating Adaptive Cruise Control (ACC) in the situations mentioned above can cause collisions, other accidents, and serious personal injury.

Special driving situations

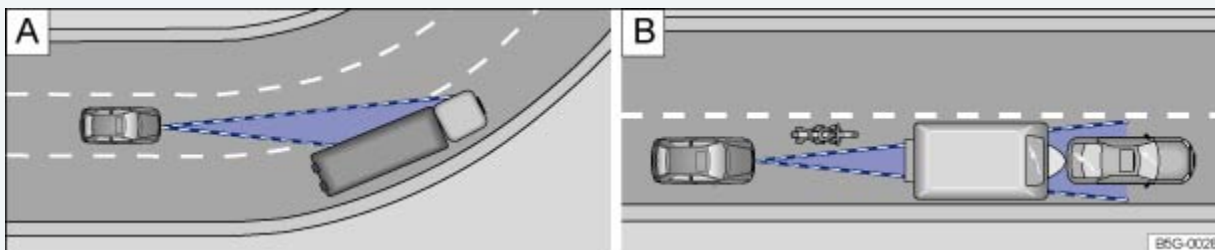


Fig. 161 Driving in a curve. Motorcycle traveling ahead outside of the sensor range.

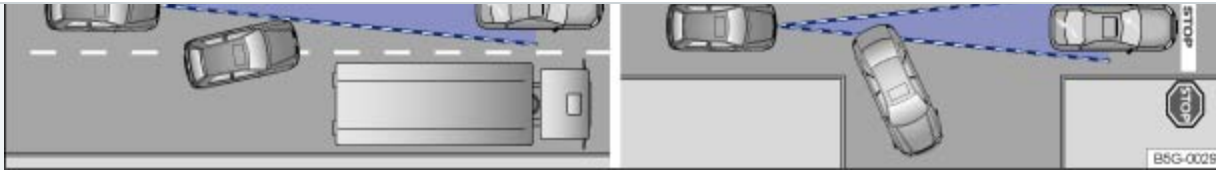


Fig. 162 Vehicle changing lanes. A turning and a stationary vehicle ahead.



Read and follow the introductory information and safety information first ⇒ [Introduction to the subject](#)

Adaptive Cruise Control has physical and system-related limits. The driver may therefore feel that, in certain circumstances, some Adaptive Cruise Control reactions are unwanted or occur with a delay. You should therefore always be prepared to take full control of the vehicle whenever necessary.

Deceleration to standstill (vehicles with automatic transmission only)

If a vehicle traveling ahead brakes to a standstill, the ACC will also brake your vehicle to a standstill. The vehicle is then held stationary by the brakes for no more than a few seconds. You must press the brake pedal or the vehicle will start moving forward again!


Driving off after a stationary phase (vehicles with automatic transmission only)

After a stationary phase, press the **RES** button on the multi-function steering wheel and the Adaptive Cruise Control (ACC) will resume speed regulation as long as the vehicle in front is moving again.


Passing other vehicles

If you switch on the turn signal when starting to pass another vehicle, Adaptive Cruise Control accelerates the vehicle automatically and reduces the distance to the vehicle in front.

If you move your vehicle into the passing lane and there is no vehicle ahead of you, the ACC will automatically increase the speed to your set level and maintain it.

Acceleration can be stopped at any time by depressing the brake pedal or pressing the  button on the multi-function steering wheel ⇒ [Operating Adaptive Cruise Control \(ACC\)](#).

Driving around curves and roundabouts

When driving into a curve and driving out of a long curve, the radar sensor may react to a vehicle in the next lane ⇒ [Fig. 161](#) . In such situations, the vehicle might decelerate unnecessarily or not re-




tor, interrupt the braking procedure by depressing the brake pedal, or press the  button on the multi-function steering wheel ⇒ [Operating Adaptive Cruise Control \(ACC\)](#).

Driving through tunnels

The function of the distance radar may be limited when driving in tunnels. Switch off ACC when driving through tunnels.

Narrow vehicles and vehicles offset to one side


Narrow vehicles and vehicles traveling slightly to the left or right of your vehicle can only be detected by the radar sensor when they are within sensor range ⇒ [Fig. 161](#) . This applies especially to narrow vehicles such as motorcycles. If required, brake the vehicle yourself.

Vehicles with oversize loads or special equipment

Under certain circumstances, ACC will not correctly recognize vehicles carrying oversize loads or loads that exceed the vehicle dimensions, like flatbed trailer trucks.


Switch off ACC when driving behind or while passing such vehicles. If required, brake the vehicle yourself.

Other vehicles changing lanes

Vehicles that change into your lane within a short distance can only be detected by the radar sensor once they are within sensor range ⇒ [Fig. 162](#) . The result is a delayed reaction by the Adaptive Cruise Control. If required, brake the vehicle yourself.

Stationary vehicles

The ACC will not detect stationary obstacles, such as the end of a traffic jam or a broken down vehicle, or a vehicle approaching you in the same lane.

If a vehicle detected by Adaptive Cruise Control turns or changes lanes and there is a stationary vehicle in front of that vehicle, the system will not react to the stationary vehicle ⇒ [Fig. 162](#) . If required, brake the vehicle yourself.

Narrow vehicles

Narrow vehicles, such as motorcycles traveling ahead, are often detected late or not at all under some circumstances.



ACC does not detect oncoming vehicles in your lane.

Metal objects on the road

Metal objects on the road, such as tracks or metal plates, can lead to unwanted reactions of the system, such as abrupt braking maneuvers.

Possible radar sensor function impairments

If the radar sensor function is impaired by heavy rain, spray, snow or mud, Adaptive Cruise Control switches off temporarily. A driver information message appears in the instrument cluster display. Clean the radar sensors as required.

The Adaptive Cruise Control will automatically be available again as soon as the radar sensor is working properly. The message in the instrument cluster display switches off, and the Adaptive Cruise Control can be reactivated.

Strong reflected radiation of the radar signal, for example, in multilevel parking structures, can impair the function of the radar sensor.

Overheated brakes

Adaptive Cruise Control may switch off temporarily if the brakes overheat significantly, for example from braking maneuvers or driving down steep slopes. A driver information message appears in the instrument cluster display. Adaptive Cruise Control cannot be activated.

Adaptive Cruise Control can be activated again once the temperature of the brakes decreases sufficiently. The message in the instrument cluster display switches off. If the message does not go out for a long time, there is a fault.

If the message ACC not available does not switch off, there is a malfunction. Contact your authorized Volkswagen dealer or authorized Volkswagen Service Facility.

Trailer towing

When towing a trailer, ACC and Front Assist may work only with limited functionality.

WARNING

If ACC brings your vehicle to a complete stop before the system prompts you to brake and the



cases the radar sensor may be unable to detect obstacles in the vehicle's path. This can result in serious injury and accidents.

- Always check the road ahead before the vehicle pulls away. If necessary, cancel the pulling away procedure by depressing the brake pedal.

WARNING

The *view* of the radar sensor can be impaired by rain, snow or heavy spray. Under certain circumstances, this could result in the vehicle ahead being detected inadequately or not at all. Take over yourself if necessary!

- Switch Adaptive Cruise Control off when driving through tunnels because the function of the system could be impaired.
- Adaptive Cruise Control distance regulation will not work if the sensors are covered by heavy rain, spray, snow, etc. A driver information message appears in the instrument cluster display.
- Adaptive Cruise Control switches off temporarily if the brakes overheat too much. ACC not available appears in the instrument cluster display.

Forward Collision Warning (Front Assist)



Introduction to the subject

In this chapter you will find information on the following subjects:

⇒ *Driver warnings and Autonomous Emergency Braking*

⇒ *Radar sensor*

⇒ *Operating Front Assist*

⇒ *Temporarily switch off Front Assist in the following situations*

⇒ *System limits*

Depending on vehicle equipment, the vehicle may be equipped with Forward Collision Warning (Front Assist), which includes Forward Collision Warning and Autonomous Emergency Braking systems.



end collisions by providing a warning of a possible collision with a vehicle on the road ahead within physical and technical limits of the system.

When Front Assist is switched on, the Autonomous Emergency Braking system can automatically apply the brakes within the Front Assist speed range to help minimize the effects of a collision.

The Front Assist system is not a substitute for the driver's full concentration.

WARNING

The Front Assist system technology cannot overcome the laws of physics and system-related limits. The driver is always responsible for braking in time. If the Front Assist system issues a warning, immediately apply the brake to slow the vehicle down or avoid the obstacle, depending on the traffic situation.

- Always adjust your speed and driving style to road, traffic, weather, and visibility conditions.
- The Front Assist system cannot prevent accidents and serious injuries on its own.
- The Front Assist system can issue unnecessary warnings in certain complex driving situations, for example, at traffic islands.
- The Front Assist system can issue unnecessary warnings when its function is impaired, for example, if the radar sensor is dirty or if the position of the radar sensor has been changed.
- The Front Assist system does not react to people, animals, or vehicles crossing or approaching in the same lane.
- Always be prepared to take full control of the vehicle at all times.



Deactivate Front Assist if it does not work as described in this chapter, for example, if multiple unwanted warnings occur. Have the system checked by an authorized Volkswagen dealer or authorized Volkswagen Service Facility.

Driver warnings and Autonomous Emergency Braking



Fig. 163 Symbols in the instrument cluster display. : Distance warning. : System switched off (symbol displayed in color on an instrument cluster with color display).



Fig. 164 In the instrument cluster display: Advance warning (symbol displayed in color on an instrument cluster with color display).



Read and follow the introductory information and safety information first ⇒ [Introduction to the subject](#)

Distance warning

If the vehicle is traveling within a speed range of about 40–155 mph (65–250 km/h), the system warns the driver with a message in the instrument cluster display (⇒ [Fig. 163](#)) if it detects that the vehicle is driving too close to the vehicle ahead ⇒ . No acoustic warning will sound.

The warning period varies according to the traffic situation and your driving style.

Increase the distance between your vehicle and the vehicle ahead.

Advance warning


If the vehicle is traveling within a speed range of about 18–155 mph (30–250 km/h), the system



It detects a possible collision with a vehicle ahead → .

The warning period varies according to the traffic situation and your driving style.

Brake or take action to avoid the vehicle ahead!

However, do not rely solely on Front Assist. Under certain conditions, the reactions of Front Assist may be unexpected or delayed from the driver's viewpoint. Always pay attention and take over if necessary ⇒ .

Immediate warning


If you fail to respond to the advance warning, within a speed range of about 18–155 mph (30–250 km/h), Front Assist can initiate a short active braking maneuver, should you not react accordingly to an advance alert. In this case you will notice brief, jerky braking of the vehicle to warn you of an impending collision.

The moment of this alert can vary, depending on the traffic situation and the driving behavior.

Autonomous Emergency Braking

If you should also fail to react to the immediate warning, within a speed range of about 3–155 mph (5–250 km/h), Front Assist can initiate an automatic braking maneuver that will abruptly decelerate the vehicle with elevated braking force. The emergency braking maneuver occurs shortly before a potential collision to reduce vehicle speed and help to minimize the effects of a collision.

Autonomous Emergency Braking below 18 mph (30 km/h)

In case of an impending collision, within a speed range of about 3–18 mph (5–30 km/h), Front Assist can initiate an automatic braking maneuver without the distance, advance, or immediate warnings to reduce vehicle speed and help to minimize the effects of a collision ⇒ .

The automatic braking maneuver occurs simultaneously with a warning in the instrument cluster display ⇒ [Fig. 164](#)¹⁾.

Braking support

Front Assist can help to minimize the effects of a collision by supporting with additional braking force in case of an emergency braking situation within a speed range of about 3–155 mph (5–250 km/h), should the system detect that the force applied to the brake pedal by the driver is not sufficient to




collision with another vehicle ahead of yours and the brake pedal has to be hit hard and suddenly.

However, this support only works as long as the brake pedal is depressed.

Front Assist considers the driver's response time to give warnings in time. This response time reduces automatically when the system, for example, detects movement of the accelerator or steering wheel. The system thus prevents unnecessary brake interventions, for example, when the driver passes another vehicle.

Front Assist cannot react when approaching standing objects ahead of you, for example, when driving up to a line of stopped vehicles in heavy traffic.

System deactivated

If the system is switched off, a text message and symbol appear in the instrument cluster display ⇒ [Fig. 163](#)  (magnified view)¹.

WARNING

The Front Assist technology cannot overcome the laws of physics and system-related limits. Do not allow the increased convenience Front Assist can provide tempt you into taking extra risks. The driver is always responsible for braking in time. If the Front Assist system issues a warning, immediately apply the brake to slow the vehicle down or avoid the obstacle, depending on the traffic situation.

- Always adjust your speed, driving style, and the distance you keep between you and the vehicles ahead of you to the road, traffic, weather, and visibility conditions.
- The Front Assist system cannot prevent accidents and serious injuries on its own.
- The Front Assist system can issue unnecessary warnings in certain complex driving situations, for example, at traffic islands.
- The Front Assist system can issue unnecessary warnings or braking maneuvers when its function is impaired, for example, if the radar sensor is dirty or if the position of the radar sensor has been changed.
- The Front Assist system does not react to people, animals, or vehicles crossing or approaching in the same lane.
- Never follow a vehicle so closely that you cannot stop your vehicle safely, under certain circumstances the automatic braking function cannot bring the vehicle to a stop in time.



may not be able to slow your vehicle safely. If closing speed is too high, you must apply the brakes yourself to reduce the risk of a rear-end crash.

- Always be prepared to take full control of the vehicle at all times.

WARNING

Failure to heed warning lights and instrument cluster text messages can result in a collision and serious personal injury.

- Never ignore warning lights or text WARNINGS.

NOTE

If you notice that Front Assist doesn't work properly or the sensor is damaged, switch off Front Assist immediately.

- See an authorized Volkswagen dealer or authorized Volkswagen Service Facility for assistance and have the Front Assist system checked.



If Front Assist initiates a braking maneuver, the braking system is under pressure. In this case the braking pedal will feel harder and the brake pedal travel will be shorter.



Automatic braking maneuvers can be interrupted by depressing the clutch or gas pedal, or by moving the steering wheel.



Deactivate the Front Assist system if it does not work as described in this chapter, for example, if multiple unwanted warnings or braking maneuvers occur. Have the system checked by an authorized Volkswagen dealer or authorized Volkswagen Service Facility.



When the Front Assist system is switched on, the display in the instrument cluster can be overwritten by displays related to other functions, for example, an incoming telephone call.



The Autonomous Emergency Braking system can slow your vehicle down to a standstill, but not



Front Assist is automatically deactivated when ASR is switched off.

1) Displayed in color on an instrument cluster with color display.

Radar sensor

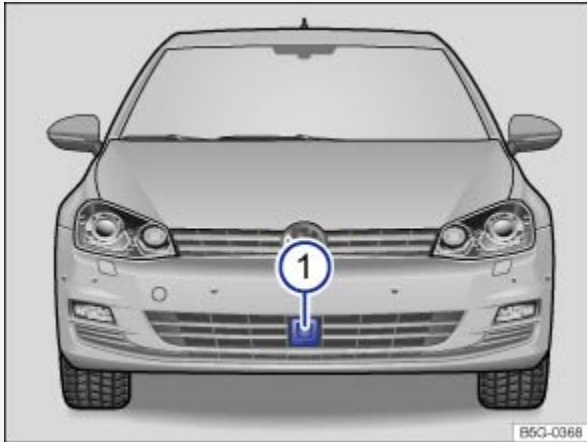


Fig. 165 In the front bumper: Radar sensor.

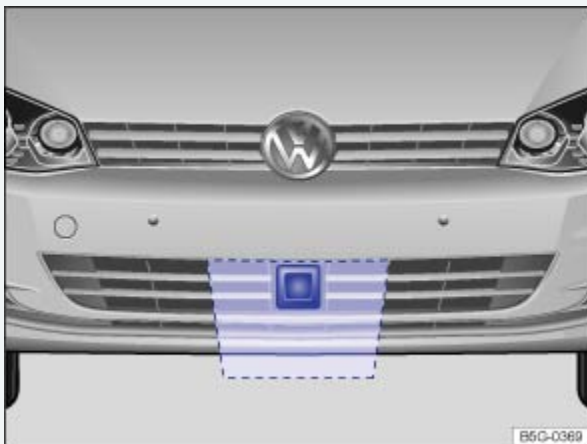


Fig. 166 Area around the radar sensor to be kept clean and free of obstructions.



Read and follow the introductory information and safety information first ⇒ [Introduction to the subject](#)

A radar sensor mounted in the front bumper monitors traffic ⇒ [Fig. 165](#) and can detect vehicles traveling ahead up to a distance of about 130 yards (120 m).

The radar sensor function can be impaired by things such as mud, slush, or snow, or by conditions



Assist, no sensor view: appears in the instrument cluster display. Clean the radar sensor as required ⇒ .

The Front Assist system will automatically be available again as soon as the radar sensor is no longer impaired. The message in the instrument cluster display turns off.

The function of the Front Assist system can also be impaired when the radar signal radiation is reflected, for example, in multilevel parking structures, or by nearby metallic objects such as rails or metal plates in the road.

The area in front of and around the radar sensor ⇒ [Fig. 166](#) must not be covered by objects such as stickers, additional headlights, a license plate bracket, or other things, as these items can impair the function of the Front Assist system.

Any structural modifications to the vehicle, for example, lowering the vehicle or alterations to the front end trim, can impair the function of the Front Assist system. Structural modifications should only be carried out by a qualified workshop ⇒ [Parts, accessories, repairs, and modifications](#). Contact an authorized Volkswagen dealer or an authorized Volkswagen Service Facility for assistance.

Incorrectly performed repairs to the front end of the vehicle can change the position of the radar sensor and therefore impair the function of the Front Assist system. Repair work should only be carried out by a qualified workshop. Contact an authorized Volkswagen dealer or an authorized Volkswagen Service Facility for assistance.

NOTE

Switch off the Front Assist system if you suspect that the radar sensor has been damaged or if its position has been changed. This can help prevent further damage. Contact an authorized Volkswagen dealer or an authorized Volkswagen Service Facility to have the radar sensor re-aligned.

- The radar sensor can become misaligned if it is hit, for example, when parking the vehicle. Readjusting the sensor could impair the performance of the system or cause it to switch off.
- Repairs to the radar sensor require special knowledge and tools. Contact an authorized Volkswagen dealer or an authorized Volkswagen Service Facility for assistance.
- Remove snow with a brush, and remove ice with a solvent-free deicer spray.
- A Declaration of Compliance with the United States FCC and Industry Canada regulations is



Operating Front Assist




Read and follow the introductory information and safety information first ⇒ [Introduction to the subject](#)

The Front Assist system is automatically active once the ignition is switched on ⇒ [Starting and stopping the engine](#).


The advance warning and distance warning are automatically switched off when the Front Assist system is switched off.

Volkswagen recommends that the Front Assist system is switched on at all times, except in the specific situations described in this Manual ⇒ [Temporarily switch off Front Assist in the following situations](#).

Turning Front Assist on or off

- In the Assist systems menu in the instrument cluster display, select Front Assist ⇒ [Volkswagen Information System](#).
- OR: Press the driver assist systems button on the turn signal lever (if equipped) and select Front Assist ⇒ [Volkswagen Information System](#).
- OR: On appropriately equipped vehicles, you can turn Front Assist on or off in the Infotainment system by pressing the **CAR** button followed by the  and Assistance systems function keys ⇒ [Menu and system settings](#).
- If the system is switched off, a text message and symbol appear in the instrument cluster display ⇒ [Driver warnings and Autonomous Emergency Braking](#).

Turning the distance warning and advance warning on or off

On appropriately equipped vehicles, you can turn the distance warning and the advance warning on or off in the Infotainment system by pressing the **CAR** button followed by the  and Assistance systems function keys ⇒ [Menu and system settings](#).

Via this menu, you can also adjust the warning period for the advance warning to one of three settings:



- Medium
- Late

Volkswagen recommends that the distance and advance warnings are switched on at all times.

Temporarily switch off Front Assist in the following situations



Read and follow the introductory information and safety information first ⇒ [Introduction to the subject](#)

Front Assist should be switched off in the following situations due to system limitations ⇒ ⚠ :

- If the vehicle is being towed.
- If the vehicle is on a dynamometer test bed.
- If the vehicle is not being driven on public roads, for example, off-road or on a track.
- If the radar sensor malfunctions.
- If external force has affected the radar sensor, for example, after a rear-end collision.
- If the radar sensor is covered (even temporarily) by any accessories or other equipment, for example, auxiliary headlights.
- If the vehicle is being loaded onto a truck, ferry, or train.

WARNING

Failure to switch off Front Assist in the situations mentioned can cause accidents and serious personal injury.

System limits



Read and follow the introductory information and safety information first ⇒ [Introduction to the subject](#)

Front Assist has physical and system-related limits. The driver may therefore feel that, in certain circumstances, some Front Assist reactions are unwanted or occur with a delay. You should therefore al-



The following conditions can prevent Front Assist from reacting, or delay its ability to react:

- When driving in tight curves.
- When the accelerator pedal is depressed.
- When Front Assist is switched off or if there is a fault.
- When the ASR is manually switched off.
- When the ESC is taking corrective action.
- When several brake lights on the vehicle or on a trailer connected to the vehicle electrical system are faulty.
- When the radar sensor is dirty or covered.
- When there are metal objects, for example, tracks or metal plates in the road.
- When the vehicle is in Reverse (R).
- When weather conditions are poor.
- When narrow vehicles, such as motorcycles, are moving in front of your vehicle.
- When vehicles are traveling slightly offset to the left or right in front of your vehicle.
- When vehicles are crossing in front of your vehicle.
- When there is oncoming traffic.
- When the system cannot detect the traffic situation clearly.
- When loads or attachment parts on other vehicles in front of your vehicle protrude to the side, rear, or above the normal vehicle dimensions.

Lane Keeping System (Lane Assist)



Introduction to the subject

In this chapter you will find information on the following subjects:

⇒ *Display and indicator lights*

⇒ *How Lane Assist works*



⇒ *Driver information*

Your vehicle may be equipped with a Lane Assist system, which can warn you if your vehicle unintentionally leaves the current drive lane.

⚠ WARNING

Always remember that Lane Assist has limits – using Lane Assist when it is not possible to drive safely can be dangerous and can lead to an accident and serious personal injury.

- Always adjust your speed and the distance you keep between you and the vehicles ahead of you to the road, traffic, weather, and visibility conditions.
- Always keep your hands on the steering wheel and be ready to react – Lane Assist will not release you from the responsibility to control your vehicle.
- Always pay attention to the messages in the instrument cluster display and act accordingly.
- Always pay close attention to what is happening around your vehicle.

⚠ WARNING

Under certain circumstances, the Lane Assist may not be able to recognize all lane markings. Bad or wet roads, worn out markings, or objects on the road can lead to the Lane Assist not or mistakenly recognizing lane markings.

- Always switch off Lane Assist under these conditions.

⚠ WARNING

If the view area of the camera is covered or dirty, Lane Assist may not work properly.

- Always make sure that the camera area is free of dirt or snow and not covered.

ⓘ NOTE

To help maintain the proper function of Lane Assist:

- Always keep the camera area in the front windshield free of ice, dirt and snow.

- Regularly check the windshield and especially the area of the camera for damages.
- Never attach or mount any accessories or other items to the steering wheel.



Lane Assist has been developed only for on-road driving.



If Lane Assist does not work properly and as described here or if there is a system fault, have the system checked by an authorized Volkswagen dealer or authorized Volkswagen Service Facility.

Display and indicator lights

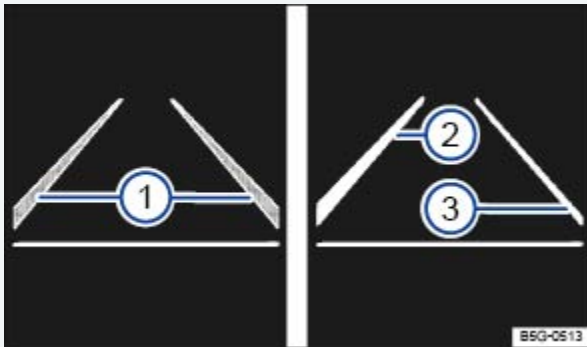


Fig. 167 In the instrument cluster display: Lane Assist display (displayed in color on an instrument cluster with color display).



Read and follow the introductory information and safety information first ⇒ [Introduction to the subject](#)

Displays

Display fields ⇒ Fig. 167 :

- ① Lane marking detected (shown in grey). No regulation is necessary.
- ② Lane marking detected (shown in white). System is actively regulating.
- ③ No lane marking detected. System is not regulating.

Indicator lights

Lights up	Possible cause
-----------	----------------

Lane Assist is switched on but not active.



The system cannot clearly detect the lane. Refer to ⇒ [Driver information](#).



Lane Assist is switched on and active.

When the ignition is switched on, several warning and indicator lights come on briefly for a function check. They go out after a few seconds.

WARNING

Failure to heed warning lights and instrument cluster text messages can cause the vehicle to break down in traffic and result in a collision and serious personal injury.

- Never ignore warning lights or text WARNINGS.
- Always stop the vehicle as soon as it is safe to do so.

NOTE

Failure to heed warning lights or text WARNINGS can result in vehicle damage.

How Lane Assist works

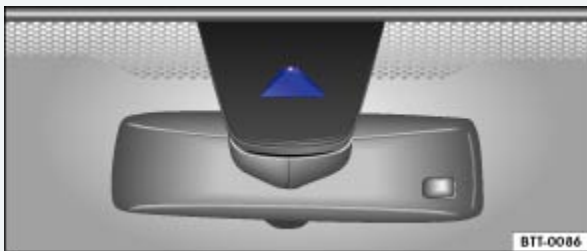


Fig. 168 In the front windshield: Area of the Lane Assist camera.



Read and follow the introductory information and safety information first ⇒ [Introduction to the subject](#)



drive lane. Should the vehicle leave this area unintentionally, for example, when leaving the current drive lane without activating a turn signal, the system will warn you with a *corrective steering intervention*. The driver can override the corrective steering intervention at any time.


Lane Assist will not warn you of a lane change if you activate the turn signal, because the system will assume that the lane change is happening intentionally.

Steering wheel vibration

The following (very rare) situations will cause the steering wheel to vibrate and demand active steering intervention by the driver:

- If the corrective steering intervention is not sufficient to keep the vehicle in its lane.
- If the system no longer detects a lane during a strong corrective steering intervention.

Switching Lane Assist on and off

- In the Assist systems menu in the instrument cluster display, select Lane Assist ⇒ [Volkswagen Information System](#).
- OR: Press the driver assist systems button on the turn signal lever and select Lane Assist ⇒ [Volkswagen Information System](#).
- OR: You can turn Lane Assist on and off in the Infotainment system by pressing the **CAR** button followed by the  and Assistance systems function keys ⇒ [Infotainment system](#).

The indicator light in the instrument cluster shows the status of the system.


Automatic deactivation: The Lane Assist system can switch off automatically if there is a system fault. The indicator light goes out.



Before starting to drive, always make sure that the area of the camera ⇒ [Fig. 168](#) is not covered. Keep this area clean at all times.

When to switch off Lane Assist



Read and follow the introductory information and safety information first ⇒  [Introduction to the subject](#)




- In complex traffic situations when it is necessary for the driver to pay special attention.
- On bad roads or on roads with no or hardly visible side markings.
- Under bad weather conditions and/or bad visibility.
- When the vehicle is off road, for example, on construction sites or on race tracks.
- If the camera is covered by dirt, ice, or snow. In this case, clean the camera area as soon as possible or deactivate the system.
- When driving with a sporty or dynamic driving style.
- Before hill crests.

WARNING

Not deactivating Lane Assist in the situations mentioned above can cause collisions, other accidents and serious personal injury.

Driver information



Read and follow the introductory information and safety information first ⇒  [Introduction to the subject](#)

Automatic deactivation of Lane Assist (yellow indicator light comes on)

Under certain circumstances Lane Assist can be deactivated automatically:

- If the system cannot recognize side markings correctly, for example, in construction sites, on bad roads, when visibility is bad, or when the camera area is covered.
- If there is no lane marking or if the distance to the nearest lane marking is too great.
- When the speed of your vehicle is less than about 40 mph (65 km/h).
- In narrow curves.
- When a turn signal is switched on.
- If your driving style is very sporty or dynamic (the system may switch off temporarily).
- If the system does not detect any clear steering activity by the driver over an extended period.



mode on and off.

Rear View Camera system

Introduction to the subject

In this chapter you will find information on the following subjects:

⇒ *Special considerations*

⇒ *Camera*

⇒ *Operation*

⇒ *Parking*

Depending on equipment, your vehicle may be equipped with a Rear View Camera system.

A camera in the trunk lid assists the driver while backing up or maneuvering. The camera image is shown together with the orientation lines projected by the system on the screen of the factory-installed Infotainment system.

The Rear View Camera system may take a few seconds to bring up the camera image.

The functions and displays of the Rear View Camera system may vary on vehicles with or without Park Distance Control (PDC) ⇒ *Park Distance Control (PDC)*.

WARNING

The Rear View Camera system is not able to give you a clear and undistorted view of all areas behind the vehicle.

- The Rear View Camera system has blind spots in which it cannot detect people and objects.
- Always be careful and look around you when parking. The Rear View Camera system cannot show people, animals, and objects in certain situations. Watch out for small children and animals in particular.



chain-link fences and similar fences, and other objects, or it may not show them clearly.

- The camera lens enlarges and distorts the field of vision and causes objects on the screen to appear altered and imprecise.
- Always keep the camera lens clean and free of snow and ice; do not cover the lens.

WARNING

The Rear View Camera system technology cannot overcome the laws of physics and the limits of the system. Careless or unintentional use of the Rear View Camera system may result in accidents and severe injuries.


- Always adjust your speed and driving style to road, traffic, weather, and visibility conditions.
- Always keep an eye on the parking direction and the vehicle surroundings. The front of the vehicle swings out more than the rear of the vehicle.
- Never pay so much attention to the graphics shown on the screen that you fail to notice what is going on around you.
- Always watch for people, especially small children, animals, and objects, because the Rear View Camera system may not always be able to detect them.
- The system may not be able to clearly show everything behind the vehicle.
- Use the Rear View Camera system only when the trunk lid is completely closed.

NOTE

- The Rear View Camera system shows only two-dimensional images on the screen. Due to the lack of depth of field, it may be difficult or impossible to identify protruding objects or recesses in the road, for example.
- Things like thin rods, fences, posts, and trees may not be detected by the Rear View Camera system and could damage the vehicle.

Special considerations



Read and follow the introductory information and safety information first ⇒  [Introduction to the subject](#)



Checklist


- ✓ The trunk lid must be closed.
- ✓ A reliable and clear image must be displayed and the camera lens must be clean .
- ✓ There must be a clear and complete view of the area behind the vehicle.
- ✓ The rear of the vehicle must not be heavily loaded.
- ✓ The driver must be familiar with the system.
- ✓ The position of the camera has not changed, such as after a rear-end collision. If the position of the camera has changed, have the system checked by an authorized Volkswagen dealer or an authorized Volkswagen Service Facility.

Volkswagen recommends practicing parking and maneuvering with the Rear View Camera system in a safe place with little or no traffic or in a parking lot under good visibility and weather conditions to familiarize yourself with the system, the orientation lines, and the way they work.

Rear View Camera system settings

Depending on equipment, various settings, including *brightness, contrast, and color*, can be adjusted by moving your hand toward the Infotainment system screen and tapping the function keys - or +, or by moving the corresponding slider.

To change the settings follow these instructions:

- Park the vehicle in a safe place on a firm, level surface.
- Set the parking brake to help prevent the vehicle from moving ⇒ *Parking brake (Golf, Golf GTI)* or ⇒ *Electronic parking brake (Golf R)* (depending on equipment).
- Switch on the ignition.
- Switch on the Infotainment system (if not already on) ⇒ *Booklet Infotainment System*,
- Shift into Reverse (R).
- Move your hand toward the screen and tap the  function key.
- Adjust the desired settings in the menu.


It is not possible to open the trunk lid if the Volkswagen emblem is folded out.

Camera



Fig. 169 In the trunk lid: Location of the camera.



Read and follow the introductory information and safety information first ⇒  *Introduction to the subject*

The camera ⇒ *Fig. 169* (magnified view) displays only two-dimensional images. Recesses and protruding objects on the ground or protruding parts on other vehicles may be difficult or impossible to identify due to the lack of depth of field.

Objects or another vehicle may seem closer or farther away on the screen than they really are.

Examples of optical distortion by the camera:

- When driving from a level surface onto an upward or downward slope.
- When driving up or down a slope onto a level surface.
- If the rear of the vehicle is heavily loaded.



– When approaching protruding objects. These objects can disappear from the field of view when backing up.

Cleaning the camera lens

Keep the camera lens clean and free of snow and ice:

- Park the vehicle in a safe place on a firm, level surface.
- Switch on the ignition (but *do not* start the engine).
- Apply the parking brake to help prevent the vehicle from moving ⇒ *Parking brake (Golf, Golf GTI)* or ⇒ *Electronic parking brake (Golf R)* (depending on equipment).
- Shift into Reverse (R).
- Wet the camera lens with a commercially available alcohol-based glass cleaner and clean with a dry cloth ⇒ ⚠.
- Remove snow with a brush.
- Remove ice with deicer spray ⇒ ⚠.
- Shift the vehicle out of Reverse (R).
- Switch off the ignition.

⚠ NOTE

- Never use abrasive cleaning agents to clean the camera lens.
- Never remove snow or ice on the camera lens with warm or hot water. This can damage the camera lens.

Operation

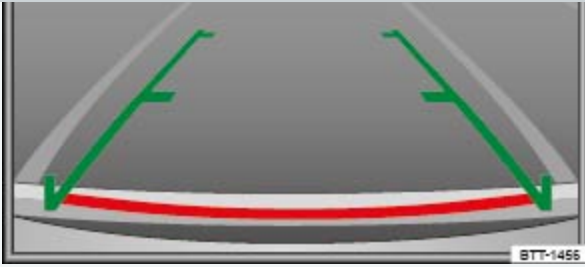


Fig. 170 In the Infotainment system: Rear View Camera system display (may vary depending on vehicle equipment).



Read and follow the introductory information and safety information first ⇒ [Introduction to the subject](#)

Screen

Tap the MENU function key on the screen. The following function buttons appear when you move your hand toward the screen. Buttons may vary, depending on vehicle equipment.

Symbol	Meaning
	Depending on vehicle equipment: Switch the PDC display on.
	Depending on vehicle equipment: Switch the PDC display off.
	Close the current display.
	Depending on vehicle equipment: Switch the PDC sound on or off.
	Setting display: brightness, contrast, color.
	Depending on vehicle equipment: Display PDC.

Switching the Rear View Camera system on and off: Vehicles without Park Distance Control

The Rear View Camera system switches on and off automatically when the ignition is on.






Switch on the display automatically:	Shift into Reverse (R).
Switch off the display automatically:	Switch off the ignition.
	OR: Drive forward faster than about 5 mph (10 km/h) or for longer than 10 seconds.
	OR: Shift out of Reverse (R) and wait about 10 seconds.
Switch off the display manually:	Press one of the Infotainment system buttons or move your hand toward the screen and tap the X function key.
Show the display again:	Shift out of Reverse (R), then shift back into Reverse (R).

Switching the Rear View Camera system on and off: Vehicles with Park Distance Control

The Rear View Camera system switches on and off automatically when the ignition is on.

Function	Action
Switch on the display automatically:	Shift into Reverse (R).
Switch off the display automatically:	Switch off the ignition.



	<p>OR: Drive forward faster than about 5 mph (10 km/h) or for longer than 10 seconds.</p>
	<p>OR: Shift out of Reverse (R) (display switches off immediately).</p>
Switch off the display manually:	<p>Press one of the Infotainment system buttons or move your hand toward the screen and tap the  function key.</p>
	<p>OR: Move your hand toward the screen and tap the  function key to select the full-screen PDC display ⇒ <i>Park Distance Control (PDC)</i>.</p>
Show the display again:	<p>Shift out of Reverse (R), then shift back into Reverse (R).</p>
	<p>OR: Move your hand toward the screen and tap the  function key.</p>

Parking

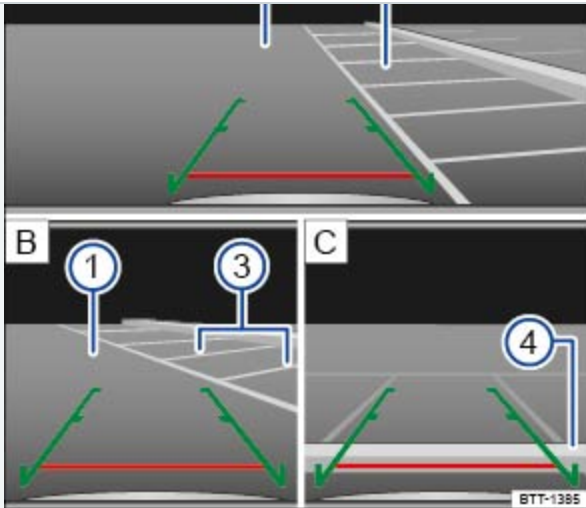


Fig. 171 On the screen: Orientation lines for the parking space behind the vehicle. : Searching for a parking space, : Backing into the parking space, : Maneuvering.



Read and follow the introductory information and safety information first ⇒ [Introduction to the subject](#)


Key to ⇒ Fig. 1 71	Meaning
—	Lateral green lines: Projection of the vehicle (widened somewhat) toward the rear. The green lines stop about 6 feet (2 meters) behind the vehicle on the road.
—	Horizontal red line: Safety distance (area up to about 16 inches (40 cm) behind the vehicle on the road).
①	Road.
②	Selected parking space.
③	Side lines of the selected parking space.



Fig. 171 1	Parking
④	Rear boundary of the parking space, such as a curb.

All references to orientation line length apply to vehicles on a horizontal surface.

Parking using the Rear View Camera system

Step	Action
1.	The requirements for parking and maneuvering with the Rear View Camera system must be fulfilled ⇒ <i>Special considerations</i> .
2.	Position the vehicle in front of the parking space ② ⇒ Fig. 171 A .
3.	Shift into Reverse (R).
4.	Reverse slowly and steer the vehicle B so that the lateral green orientation lines lead into the parking space ②. Pay attention to the message in the display: Look! Safe to move? ⇒ 
5.	Align the vehicle in the parking space B so that the green orientation lines are parallel with the parking space ③.
6.	Stop the vehicle C before (or at the very latest, when) the horizontal red line reaches the rear boundary, for example, a curb ④.



Smaller objects up to about 20 inches (50 cm) from the rear of the vehicle will not be detected by the camera and could result in vehicle damage.

Park Distance Control (PDC)

Introduction to the subject

In this chapter you will find information on the following subjects:

⇒ *Operation*

⇒ *PDC signal chimes and displays*

⇒ *Vehicle path display*

⇒ *PDC menu*

Depending on equipment, the vehicle may be equipped with the Park Distance Control system (PDC).

The Park Distance Control (PDC) system can help the driver when backing up and parking. PDC uses ultrasonic sensors in the bumpers to measure the distance between the vehicle and objects. The system uses the time it takes for the ultrasonic waves to bounce back from the object to calculate the distance between the vehicle and an object. PDC works only at speeds up to about 5–10 mph (10–15 km/h).

If the vehicle gets too close to an obstacle behind it, a beeping signal sounds. The closer the vehicle gets to the obstacle, the faster the beep. When the obstacle is very close, the sound is continuous.

If you move even closer to the obstacle despite the continuous warning sound, the system cannot measure the distance remaining until collision.

A Declaration of Compliance with United States FCC and Industry Canada regulations is found in the Consumer information section of this Manual ⇒ [Consumer information](#).

WARNING

Park Distance Control is no substitute for careful and attentive driving. Never rely completely on



and could be struck resulting in serious personal injuries.

- The sensors have blind spots in which they cannot detect people, animals, and objects.
- Always be careful and look around you when parking. The sensors cannot always detect people, animals, and objects. Watch out for small children and animals in particular.
- Certain types of clothing and the surfaces of certain objects do not reflect the ultrasonic waves that the sensors send and receive. Such objects and persons wearing such clothing will not be detected by PDC or will not be detected accurately.
- Noise in the area can interfere with the signals of the Park Distance Control sensors. Under certain circumstances, the system will not detect people and objects for this reason.

NOTE

- Things like trailer draw bars, thin rods, fences, trees, narrow painted vertical poles, posts, or a trunk lid that is opening may not be detected by the Park Distance Control sensors and could damage the vehicle.
- If you continue driving closer to an object that the Park Distance Control has already detected and reported, the object may disappear from the sensor range and may no longer be detected. This is especially true for low or high objects. The system will no longer sound warnings about these objects. Ignoring signals from the Park Distance Control system could result in serious damage to the vehicle.
- The sensors in the bumpers can be damaged or become misaligned in low speed impacts and parking maneuvers. Damaged or misaligned sensors cannot accurately detect or report objects that might be within range of the PDC system.
- To help make sure that the system works properly, always keep the sensors in the bumpers clean and free of snow and ice; do not cover the sensors with stickers or other objects.
- Repainting the sensors in the bumpers can impair the function of the PDC system.
- When cleaning the sensors with power washers or steam cleaners, only spray the sensors directly for a very short time, and always keep the washer nozzle at least 4 inches (10 cm) from the sensors.
- Noise from rough roads, cobblestones, other vehicles and the surrounding area, for example, can prevent the Park Distance Control system from accurately detecting and reporting people and objects that may be within range of the sensors.

Control system.



Volkswagen recommends practicing with the Park Distance Control system in a location or parking space with no traffic in order to become familiar with the system and how it works.



If an ultrasonic sensor malfunctions, the corresponding sensor area is switched off and cannot be reactivated until the malfunction is corrected (depending on vehicle equipment). Have the system checked by an authorized Volkswagen dealer or an authorized Volkswagen Service Facility.



If you hear a long beep of about 3 seconds when you first turn PDC on or the indicator light in the **P** button starts blinking, there is a malfunction in the Park Distance Control system. Switch off the Park Distance Control system with the button and have it checked by an authorized Volkswagen dealer or an authorized Volkswagen Service Facility.

Operation

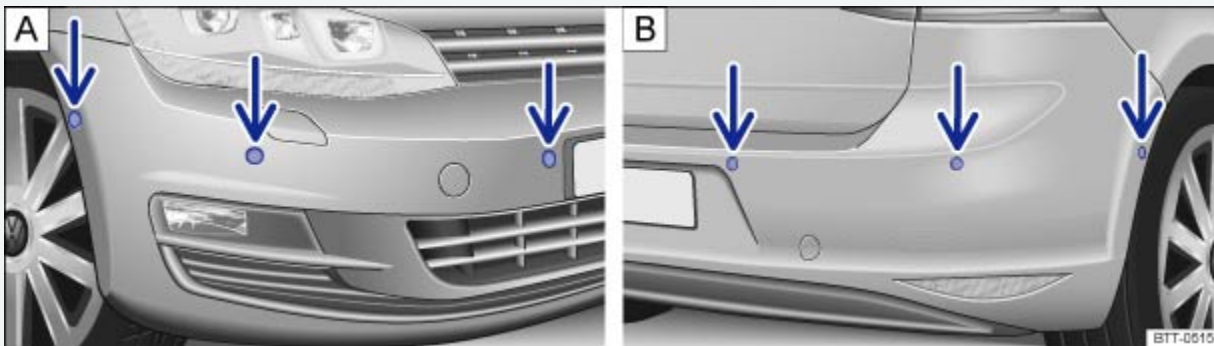


Fig. 172 In the front and rear bumpers: Park Distance Control system sensors.



Fig. 173 In the lower center console: Button to switch the Park Distance Control system on or off.






subject

The Park Distance Control (PDC) uses ultrasonic sensors to determine the distance from the front or rear bumpers to an obstacle. Depending on vehicle equipment, there are either 4 or 6 sensors for the PDC located in the rear bumper (B) and additional sensors in the front bumper (A) ⇒ Fig. 172 (arrows).



The intermittent and permanent signal chimes given by the front PDC sensors are of a higher pitch than those given by the rear PDC sensors. This is a standard feature.

The warning signals can be adjusted in the Infotainment system menu ⇒ [Infotainment system](#).


Switching the Park Distance Control (PDC) system on and off

In order to	Operation (when the ignition is switched on)
Manually activate or deactivate PDC:	Press the  button. The indicator light in the  button ⇒ Fig. 173 lights up and stays on as long as the feature is active.
Manually deactivate the display (sound stays active):	Press a function selection button on the factory-installed Infotainment system ⇒ Booklet Infotainment System ,
	OR: Move your hand toward the screen and tap the  function key.
Automatically activate PDC:	Shift into Reverse (R).
	OR: Depending on vehicle equipment, when the vehicle rolls backwards.




	<p>OR: Depending on vehicle equipment, when slowly driving toward an obstacle located in the scanned area in front of the vehicle at a speed below about 5–10 mph (10–15 km/h) ⇒ <i>PDC signal chimes and displays</i> when automatic activation is switched on in the Infotainment system. A miniature PDC view may be displayed.</p>
Automatically deactivate PDC:	<p>Shift into Park (P).</p> <p>OR: Drive forward faster than about 5–10 mph (10–15 km/h).</p>
Show the mini PDC display when the Rear View Camera display is active:	<p>Tap the MENU function key on the screen.</p>
Mute the PDC volume:	<p>Move your hand toward the screen and tap the  function key.</p> <p>OR: Switch on the electronic parking brake (if equipped).</p>
Switch from mini PDC display to full-screen mode:	<p>Move your hand toward the screen and tap the  function key.</p>
Switch to the Rear View	<p>Shift into Reverse (R).</p>



Camera system display:	OR: Move your hand toward the screen and tap the  function key.
------------------------	--

Automatic activation

When the PDC is activated automatically, a mini PDC display appears on the left-hand side of the screen ⇒ [Fig. 175](#).

Automatic activation of the PDC when driving slowly towards an obstacle located in front of the vehicle only works when the speed falls below about 5–10 mph (10–15 km/h) for the first time. If the PDC was switched off using the  button, performing one of the following actions with the ignition switched on can automatically reactivate the PDC:

- If the vehicle accelerates to a speed greater than about 5–10 mph (10–15 km/h) and then drops below that speed again.
- OR: If the ignition is switched off and then switched on again.
- OR: If the selector lever is moved from Park (P) and then to Reverse (R).
- OR: If automatic activation is turned off and on again in the Infotainment system.
- OR: Depending on vehicle equipment, if the electronic parking brake is switched on and is switched off again.

Automatic activation of the mini PDC display can be turned on or off in the Infotainment system ⇒ [Infotainment system](#).

When the box in the automatic activation function key is checked , signal chimes sound from a distance of about 20 inches (50 cm) from the obstacle.

WARNING

Never rely completely on the PDC for information about people and objects that might be in the way of the vehicle and could be struck by the vehicle causing serious personal injury.

- The PDC sensors have blind spots where they cannot detect people or objects.
- Always watch for people, especially small children and animals, because the sensors may not

PDC signal chimes and displays

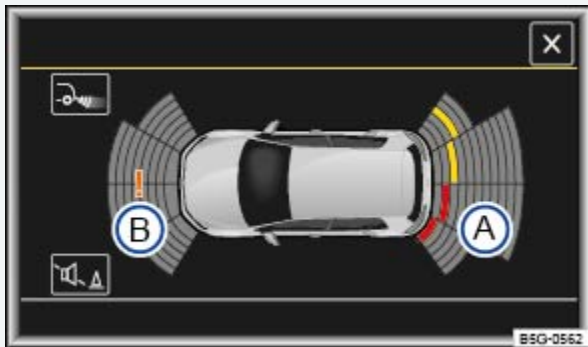


Fig. 174 PDC display of the area surrounding the vehicle.

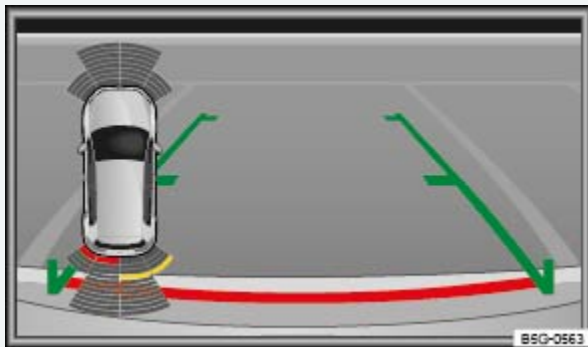







Fig. 175 Mini PDC display of the area surrounding the vehicle (display may vary depending on vehicle equipment).

Read and follow the introductory information and safety information first ⇒ [Introduction to the subject](#)

Key to ⇒ Fig. 174 and ⇒ Fig. 175	Meaning
Ⓐ	Scanned area behind the vehicle.
Ⓑ	Scanned area in front of the vehicle.
	A yellow segment represents an obstacle in the vehicle's path.



	A red segment depicts an obstacle located close to the vehicle.
	A grey segment represents an obstacle outside of the vehicle's path.
	System fault in the scanned area.
	Temporary malfunction in the scanned area, depending on vehicle equipment (not pictured).

When the factory-installed Infotainment system is switched on, the areas to the front and rear of the vehicle that are scanned by ultrasonic sensors are shown on the screen \Rightarrow [Fig. 174](#). The positions of potential obstacles are displayed relative to the vehicle \Rightarrow .

Signal chimes

When the vehicle approaches an obstacle located in the range of the ultrasonic sensors, there are audible signal chimes. An intermittent signal chime means that a sufficiently short distance between the vehicle and an obstacle is detected. The shorter the distance, the shorter the intervals between the chimes. The signal chime will sound continuously if the obstacle is very close.

When there is an imminent risk of collision at the front area of the vehicle, the signal chimes beep at the front of the vehicle. When there is a risk of imminent collision at the rear area of the vehicle, the signal chimes beep at the rear of the vehicle.

If you continue to drive the vehicle closer to the obstacle despite a continuous signal chime, the system will no longer be able to measure the distance.

The intermittent signal chime volume decreases after a few seconds if the distance remains the same. The volume remains constant if the signal chime is continuous. As soon as the vehicle moves away from an obstacle again, the intermittent signal chime switches off automatically. If the vehicle moves towards an obstruction again, the intermittent signal chimes beep automatically.



The graphic on the screen displays the scanned areas in several segments. The closer the vehicle drives towards an obstacle, the closer the segment will move to the vehicle in the display. The collision area has been reached at the latest when the second to last segment is displayed. Do not keep driving!

Vehicles with PDC at the front and rear					
Area of the vehicle			Distance of vehicle from obstacle	Signal tone	Segment color if obstacle is detected (color display only)
Ⓐ	Rear center	Obstacle not in the vehicle's path	about 12 – 63 in. (31 – 160 cm)	-	Grey
	Rear side		about 12 – 23 in. (31 – 60 cm)		
Ⓑ	Front center		about 12 – 47 in. (31 – 120 cm)		
	Front side		about 12 – 23 in. (31 – 60 cm)		



Area of the vehicle	Distance of vehicle from obstacle	Signal tone	Segment color if obstacle is detected (color display only)
<p data-bbox="248 527 407 558">Rear center</p> <p data-bbox="159 688 185 720">Ⓐ</p> <hr data-bbox="228 699 483 709"/> <p data-bbox="248 848 375 879">Rear side</p> <p data-bbox="505 919 678 1041">Obstacle in the vehicle's path</p>	<p data-bbox="732 432 964 464">about 12 – 63 in.</p> <p data-bbox="732 621 922 653">(31 – 160 cm)</p>	<p data-bbox="1016 968 1187 1094">Intermittent tone</p>	<p data-bbox="1284 1010 1377 1041">Yellow</p>
<p data-bbox="248 1173 420 1205">Front center</p> <p data-bbox="159 1337 185 1369">Ⓑ</p> <hr data-bbox="228 1348 483 1358"/> <p data-bbox="248 1497 388 1528">Front side</p>	<p data-bbox="732 1081 964 1113">about 12 – 47 in.</p> <p data-bbox="732 1270 922 1302">(31 – 120 cm)</p>		
<p data-bbox="136 1822 207 1854">Ⓐ, Ⓑ</p> <p data-bbox="248 1772 688 1898">Obstacle outside of the collision area</p>	<p data-bbox="732 1726 948 1757">about 0 – 12 in.</p> <p data-bbox="732 1915 889 1946">(0 – 30 cm)</p>		



Area of the vehicle	Distance of vehicle from obstacle	Signal tone	Segment color if obstacle is detected (color display only)
Ⓐ, Ⓑ Obstacle in the collision area	about 0 – 12 in. (0 – 30 cm)	Constant tone	Red

Muting the Park Distance Control volume

You can mute the PDC beeping signals by moving your hand toward the Infotainment system screen and tapping the function key (if applicable). Tap the function key again to turn the beeping signals back on.

Switching Park Distance Control back on after it was switched off reactivates the volume. System malfunction warning signals cannot be switched off.

If you manually deactivate the display, PDC remains on and the sound is reactivated.

Switching on the electronic parking brake also mutes the PDC volume.

The mute setting is active if the PDC was switched on using the button when the selector lever is in Park (P).

WARNING

Never pay so much attention to the graphics shown on the screen that you fail to notice what is going on around you.

NOTE

Failure to observe the illuminated text messages can lead to the vehicle being damaged.



Vehicle path display

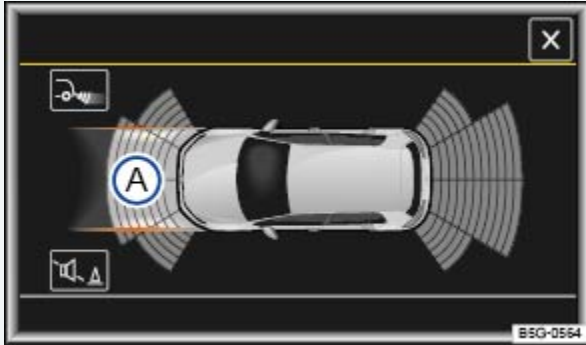


Fig. 176 PDC display (depending on vehicle equipment): Vehicle path display without steering input.

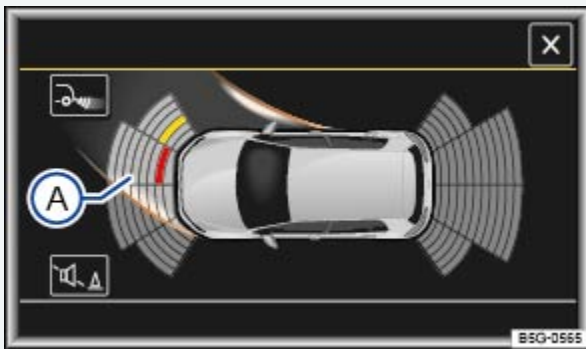


Fig. 177 PDC display (depending on vehicle equipment): Vehicle path display with steering input.




Read and follow the introductory information and safety information first ⇒ [Introduction to the subject](#)

Depending on equipment, the vehicle path may not be displayed on the Infotainment system screen.

Key to ⇒ Fig. 176 and ⇒ Fig. 177	Meaning
	Vehicle path display.
	A yellow segment represents an obstacle in the vehicle's path.
	A red segment represents an obstacle close to the vehicle.



	A grey segment represents an obstacle outside of the vehicle's path.
---	--

Vehicle path display

Function	Operation (when the ignition is switched on)
Front vehicle path display	Forward gear engaged.
	OR: Shift to Neutral (N).
	OR: Depending on vehicle equipment, roll forward.
Rear vehicle path display	Select the Reverse (R) gear.
	OR: Depending on vehicle equipment, roll backward.

The vehicle path display changes in relation to the input from the steering system. Obstacles that are located in the vehicle's path, depending on the current steering angle, are displayed in yellow and red segments.

Obstacles that are no longer in the vehicle's path, depending on the current steering angle, are displayed as follows:

- Segments are shown in red when the distance to an obstacle is less than about 12 inches (30 cm).
- Segments are shown in grey when the distance to an obstacle is greater than about 12 inches (30 cm).

When the selector lever is in position P and the PDC is activated, all segments representing an obstacle are displayed in grey and the vehicle path display is hidden.

When the electronic parking brake is engaged, all segments symbolizing an obstruction are displayed



NOTE

If an ultrasonic sensor malfunctions, the vehicle path display is switched off and cannot be reactivated until the malfunction is corrected.

- In this case, the steering angle no longer determines the segments displayed on the screen or the signal chimes that sound.

PDC menu




Read and follow the introductory information and safety information first ⇒ [Introduction to the subject](#)

PDC settings in the Infotainment system menu

Switch on the ignition.

If necessary, switch on the Infotainment system.

Press the **CAR** button.

Tap the  function key.

Tap the Parking and maneuvering function key.

Select the required settings in the ParkPilot menu.

Function key	Action
--------------	--------



Automatic activation	If the box in the function key is checked <input checked="" type="checkbox"/> , the mini PDC switches on automatically when the vehicle slowly approaches an obstacle to the front. Tap Automatic activation again to switch off this feature. After deactivation, the PDC will not switch on automatically when the vehicle approaches an obstacle to the front.
Front volume	Set different volumes for the front signal chimes by tapping the - or + function keys or by adjusting the control.
Front pitch	Set different pitches for the front signal chimes by tapping the - or + function keys or by adjusting the control.
Rear volume	Set different volumes for the rear signal chimes by tapping the - or + function keys or by adjusting the control.
Rear pitch	Set different pitches for the rear signal chimes by tapping the - or + function keys or by adjusting the control.
Audio lowering	Set the level to which the Infotainment system volume should be lowered when the PDC is active:
	<i>Off:</i> The Infotainment system volume is not lowered.



	<i>1-5</i> : The Infotainment system volume is lowered slightly to medium, depending on the number selected.
	<i>Mute</i> : The Infotainment system volume is muted.

Park Assist



Introduction to the subject

In this chapter you will find information on the following subjects:

⇒ *Description of the Park Assist system*

⇒ *Parking while using the Park Assist system*

⇒ *Driving out of a parallel parking space using Park Assist*

⇒ *Park Assist automatic braking*

The Park Assist system is an extension of the Park Distance Control system ⇒ *Park Distance Control (PDC)* and can assist the driver when:

- Finding a suitable parking space.
- Parking in a suitable parallel parking space.
- Parking in a suitable perpendicular parking space.
- Pulling out of a parallel parking space.

In vehicles with Park Distance Control (PDC), the display of the scanned area to the front, rear, and sides of the vehicle is shown on the screen of the factory-installed Infotainment system. Within the system limits, the position of obstacles can be shown in relation to the vehicle.

The Park Assist system has certain system-related limitations. The driver should exercise caution when using the Park Assist system ⇒ .



Park Assist technology cannot overcome the laws of physics and the limits of the system. Do not let the extra convenience Park Assist can provide tempt you into taking extra risks. The system is not a substitute for the driver's full concentration.

- Careless or unintentional use of Park Assist may result in accidents and severe injuries.
- Always adjust your speed and driving style to road, traffic, weather, and visibility conditions.
- Certain surfaces of objects and clothing cannot reflect the signals from the ultrasonic sensors. The system is unable to detect objects or people wearing these particular types of clothing, or they may be detected incorrectly.
- External sources of sound can affect the signals of the ultrasonic sensors. In certain circumstances, the system may not recognize people or objects.
- The ultrasonic sensors have blind spots in which they cannot detect people and objects.
- Always be careful and look around you. The sensors cannot detect people, animals, objects in certain situations. Watch out for small children and animals in particular.

WARNING

Making quick turning movements of the steering wheel when parking or driving out of a parking space can cause serious injuries.

- When parking or driving out of a parking space, do not reach for the steering wheel until prompted to do so by the system.

NOTE

- Park Assist uses parked vehicles, the curb, and other objects as guidance. Please ensure that the wheels and tires are not damaged when parking the vehicle. If necessary, stop the parking procedure early enough to prevent damage to the vehicle.
- Things like trailer draw bars, thin rods, fences, posts, trees, or an open trunk lid may not be detected by the Park Assist system and could damage the vehicle.
- The sensors in the bumpers can be damaged or become misaligned in low speed impacts and parking maneuvers. Damaged or misaligned sensors cannot accurately detect or report objects that might be within range of the Park Assist system.
- When cleaning the sensors with power washers or steam cleaners, only spray the sensors di-



the sensors.

- Aftermarket components such as bicycle racks can impair the function of the Park Assist system and may cause vehicle damage.
- Noise from rough roads, cobblestones, other vehicles and the surrounding area, for example, can prevent the Park Assist system from accurately detecting and reporting people and objects that may be within range of the sensors.

NOTE

If an ultrasonic sensor fails, the corresponding area of the ultrasonic sensor cluster is switched off and cannot be reactivated until the fault has been corrected. Have the system checked by an authorized Volkswagen dealer or an authorized Volkswagen Service Facility.



Always keep the ultrasonic sensors in the bumpers clean and free of ice, dirt, and snow. Do not cover the sensors with stickers or other objects, as these may prevent the system from working properly.




Volkswagen recommends practicing with the Park Assist system in a location or parking space with no traffic in order to become familiar with the system and how it works.



When parking or driving out of a parking space, the system gives a signal tone to tell the driver to switch between driving forward and reversing. The driver should not wait until the Park Distance Control sounds continuously before changing direction.



If the Park Assist system turns the steering wheel when the vehicle is stationary, the  symbol appears in the instrument cluster display as well. Depress the brake pedal so that the steering movement takes place with the vehicle stationary, keeping the required number of parking maneuvers to a minimum.

Description of the Park Assist system



Fig. 178 In the lower center console: Button for switching on the Park Assist system.



Read and follow the introductory information and safety information first ⇒ [Introduction to the subject](#)

Park Assist consists of ultrasonic sensors in the front and rear bumpers and the **P** button ⇒ [Fig. 178](#), which turns the Park Assist system and the instrument cluster display on and off.

Interrupting or automatically stopping a parking procedure or driving out of a parking space

The Park Assist system cancels the procedure of parking or driving out of a parking space if one of the following occurs:

- The **P** button is pressed.
- The vehicle speed is faster than about 4 mph (7 km/h).
- The driver intervenes using the steering wheel.
- The parking procedure was not completed within about 6 minutes after activating the automatic steering intervention.
- There is a system fault (system is temporarily unavailable).
- ASR is switched off.
- Regulation related to driving dynamics takes place through ASR or ESC.
- The driver door is opened.

If none of the above situations apply, resume Park Assist by pressing the **P** button once more.

Special considerations

The Park Assist system has system-related limitations. For example, if there is a tight curve in the road, the Park Assist system cannot help you park the vehicle or drive out of a parking space.

If after a wheel has been changed, you notice that the system does not park the vehicle or leave a parking space as well as it did before the wheel was changed, the new wheel dimensions may need to be synchronized with the system. The synchronization process happens automatically while the vehicle is in motion. To help the system synchronize the new wheel, drive around curves slowly at speeds of less than about 12 mph (20 km/h) ⇒ ⚠ .

Parking while using the Park Assist system

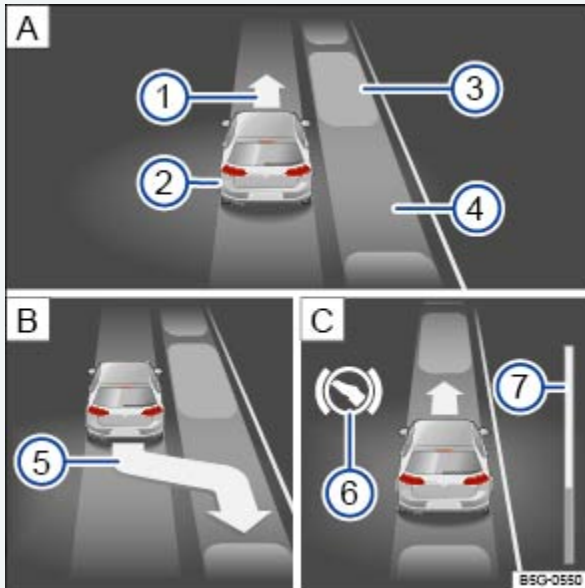


Fig. 179 In the instrument cluster display: Parallel parking. Searching for a parking space, positioning the vehicle for parking, maneuvering.

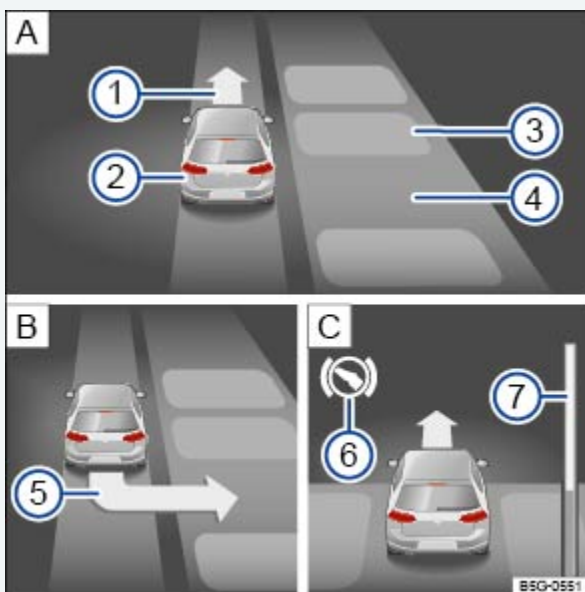


Fig. 180 In the instrument cluster display: Parking perpendicular to the road. Searching for a parking space, positioning the vehicle for parking, maneuvering.



subject

Key to ⇒ [Fig. 179](#) and ⇒ [Fig. 180](#) :

- ① Prompt to drive forward
- ② Your vehicle
- ③ Parked vehicles
- ④ Parking space detected
- ⑤ Arrow indicating the parking suggestion (prompt to park)
- ⑥ Prompt to press the brake pedal
- ⑦ Progress bar

Progress bar

The progress bar ⇒ [Fig. 179](#) or ⇒ [Fig. 180](#) in the instrument cluster display shows the relative remaining distance using symbols. The higher the progress bar, the longer the remaining distance. When driving forward, the progress level moves up; when driving in reverse, it moves down.

Requirements for parking using Park Assist



For parking spaces parallel to the side of the road	For parking spaces perpendicular to the side of the road
The ASR must be switched on ⇒ Braking and parking .	The ASR must be switched on ⇒ Braking and parking .
Do not go faster than about 25 mph (40 km/h) when driving past the parking space.	Do not go faster than about 12 mph (20 km/h) when driving past the parking space.



<p>Maintain a distance of 1.6–6.5 feet (0.5–2 meters) when driving past the parking space.</p>	<p>Maintain a distance of 1.6–6.5 feet (0.5–2 meters) when driving past the parking space.</p>
<p>Length of the parking space: vehicle length + 3.3 feet (1.0 meters) .</p>	<p>Width of the parking space: vehicle width + 2.6 feet (0.8 meters) .</p>
<p>Do not go faster than about 4 mph (7 km/h) when parking.</p>	<p>Do not go faster than about 4 mph (7 km/h) when parking.</p>

Parking the vehicle




Complete the following steps:

Step	For parking spaces parallel to the side of the road ⇒ Fig. 179	For parking spaces perpendicular to the side of the road ⇒ Fig. 180
1.	Requirements for parking using Park Assist must be fulfilled ⇒ Requirements for parking using Park Assist .	
2.	Press the P  ⇒ Fig. 178 button <i>once</i> while driving at a speed less than about 25 mph (40 km/h) .	Press the P  ⇒ Fig. 178 button <i>twice</i> while driving at a speed less than about 12 mph (20 km/h) .



	of the road Fig. 277	of the road Fig. 288
	<p>An indicator light comes on in the P button when Park Assist is switched on. The selected parking mode is also stored and displayed in the instrument cluster display.</p>	
3.	<p>Press the P button again to switch between parallel and perpendicular parking modes, if necessary.</p>	
4.	<p>Activate the turn signal for the side of the street on which you want to park. The corresponding side of the street is shown in the instrument cluster display.</p>	
5.	<p>Follow the messages in the instrument cluster display while observing traffic, and drive the vehicle past the parking space.</p>	
6.	<p>Watch the instrument cluster display to see if the parking space has been determined suitable and whether the vehicle has reached the correct position for parking B.</p>	<p>The parking space is only determined suitable when the instrument cluster displays the prompt to park Ⓢ.</p>
	<p>Stop the vehicle and after a short stationary period, move the selector lever to Reverse (R).</p>	



	of the road → Fig. 277	of the road → Fig. 288
8.	<p>Release the steering wheel when the following message is shown ⇒  Steer. interv.</p> <p>Check area around veh.!</p>	<p>Check the area around the vehicle and carefully depress the accelerator pedal. Do not exceed 4 mph (7 km/h) .</p> <p>The Park Assist system will only operate the steering wheel during the parking procedure. The driver controls the accelerator, the brake, and the transmission selector lever.</p>
9.	<p>Reverse the vehicle until there is a continuous tone from the Park Distance Control (PDC) system.</p> <p>OR: Reverse the vehicle until the prompt to drive forward appears in the instrument cluster display.</p> <p>OR: Drive in reverse until the message Park Assist finished! appears in the instrument cluster display.</p> <p>The progress bar  displays the remaining distance ⇒ <i>Progress bar</i> .</p>	
10.	<p>Press the brake pedal until Park Assist has finished steering.</p> <p>OR: Until the  symbol in the instrument cluster display disappears.</p>	



	of the Road - Fig. 277	of the Road - Fig. 280
11.	Drive the vehicle forward until there is a continuous tone from the Park Distance Control (PDC) system.	
	OR: Drive forward until the prompt to drive in reverse appears in the instrument cluster display.	
	Park Assist will guide the vehicle when driving forward and reversing C until the vehicle is parked straight in the parking space.	
12.	Wait until Park Assist has completed turning the steering wheel at the end of each parking maneuver to achieve an optimal parking result.	
	A message is displayed in the instrument cluster once parking is completed. A signal tone may also sound.	



Stopping the maneuver too soon while parking could lead to less than optimal parking results.



If there is not enough space to maneuver the vehicle, the suggested parking space may still be indicated in the instrument cluster display. However, you will not be prompted to park.



The Park Assist system can also be activated after driving past a parallel parking space at less than about 25 mph (40 km/h) or a perpendicular parking space at less than about 12 mph (20 km/h) and then pressing the **P** button.

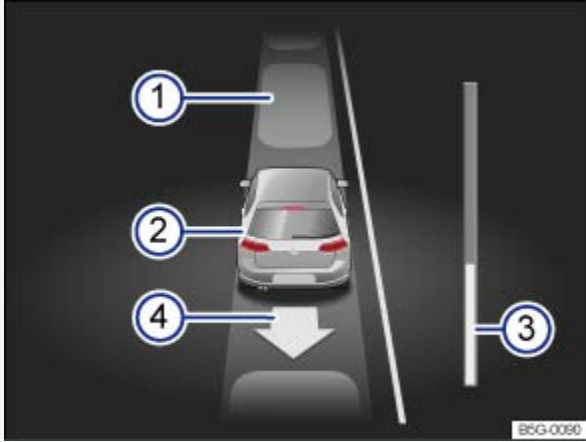


Fig. 181 In the instrument cluster display: Driving out of a parallel parking space.

Read and follow the introductory information and safety information first ⇒ [Introduction to the subject](#)

Key to ⇒ [Fig. 181](#) :

- ① Parked vehicles
- ② Your vehicle with reverse gear engaged
- ③ Progress bar
- ④ Arrow indicating the suggested procedure for driving out of a space

Requirements for driving out of a parallel parking space using Park Assist




- You must be parked in a parallel parking space.
- ASR must be switched on ⇒ [Braking and parking](#) .
- The parking space length must be vehicle length + 2.6 feet (0.8 meters) .
- You must not drive faster than about 4 mph (7 km/h) when driving out of the parking space.

Driving out of a parallel parking space


Complete the following steps:

Step	For parallel parking spaces only
------	----------------------------------



1.	<p>The requirements for driving out of a parking space using Park Assist must be fulfilled ⇒ <i>Requirements for driving out of a parallel parking space using Park Assist</i>.</p>
2.	<p>Start the engine ⇒ <i>Starting and stopping the engine</i>.</p>
3.	<p>Press the P  ⇒ <i>Fig. 178</i> button.</p>
	<p>An indicator light comes on in the P  button when Park Assist is switched on.</p>
4.	<p>Activate the turn signal in the direction (left or right) in which you would like to drive out of the parking space.</p>
5.	<p>Move the selector lever to Reverse (R).</p>
	<p>Release the steering wheel when the following message is shown ⇒  Steer. interv. Check area around veh.!</p>
	<p>Check the area around the vehicle and carefully depress the accelerator pedal. Do not exceed 4 mph (7 km/h).</p>
	<p>The Park Assist system will only operate the steering wheel while driving out of the parking space. The driver controls the accelerator, the brake, and the transmission selector lever.</p>



6.	Reverse the vehicle until there is a continuous tone from the Park Distance Control (PDC) system.
	OR: Reverse the vehicle until the prompt to drive forward appears in the instrument cluster display.
	The progress bar ⇒ <i>Fig. 181</i> displays the distance left to be traveled ⇒ <i>Progress bar</i> .
7.	Press the brake pedal until the Park Assist system has finished steering.
	OR: Press the brake pedal until the  symbol in the instrument cluster display disappears.
8.	Drive forward until there is a continuous tone from the Park Distance Control (PDC) system.
	OR: Drive forward until the prompt to drive in reverse appears in the instrument cluster display.
	The Park Assist system steers the vehicle when driving forward or reversing until the vehicle can be driven out of the parking space.



9.	A message is displayed in the instrument cluster when the vehicle can be driven out of the parking space. A signal tone may also sound.
	Take over steering with the steering angle turned by the Park Assist system.
10.	When traffic permits, drive the vehicle out of the parking space.

Park Assist automatic braking



Read and follow the introductory information and safety information first ⇒ [Introduction to the subject](#)

Park Assist can help the driver by braking automatically in certain situations.

The driver is always responsible for braking in time ⇒ .

Automatic brake intervention to avoid excess speed

An automatic brake intervention may occur to prevent the vehicle from exceeding a speed of about 4 mph (7 km/h) when parking or driving out of a parking space. You can continue the maneuver to park or drive out of a parking space after the automatic brake intervention.

Automatic brake intervention occurs no more than one time per parking maneuver. The parking maneuver is interrupted if the vehicle speed exceeds 4 mph (7 km/h) again.

Automatic brake intervention to minimize damage

Depending on certain conditions such as weather, vehicle condition, vehicle load, or vehicle angle, the Park Assist system can bring the vehicle to a stop before it reaches an obstruction. Depress the brake pedal ⇒ !

An automatic brake intervention to minimize damage ends the current parking maneuver.

Park Assist technology cannot overcome the laws of physics and the limits of the system. Do not let the extra convenience Park Assist can provide tempt you into taking extra risks. The system is not a substitute for the driver's full concentration.

- The Park Assist system has system-related limitations. In some situations the automatic brake intervention can be restricted or may not work at all.
- Always be prepared to brake the vehicle yourself.
- Automatic braking assistance ends after about 1.5 seconds. Always depress the brake pedal yourself after an automatic braking intervention.

Blind Spot Monitor with Rear Traffic Alert



Introduction to the subject

In this chapter you will find information on the following subjects:

⇒ *Indicator lights*

⇒ *Blind Spot Monitor*

⇒ *Driving situations*

⇒ *Rear Traffic Alert*

⇒ *Using the Blind Spot Monitor with Rear Traffic Alert*

Depending on vehicle equipment, the vehicle may be equipped with the Blind Spot Monitor system.

The Blind Spot Monitor assists the driver by using radar sensors to monitor the traffic in the blind spot detection area as well as traffic behind the vehicle.

The integrated Rear Traffic Alert system can help the driver when backing out of parking spaces and when maneuvering.

The Blind Spot Monitor is only designed for use on paved roads.



The Blind Spot Monitor with Rear Traffic Alert technology cannot overcome the laws of physics and limits of the system. Careless or unintentional use of the Blind Spot Monitor and Rear Traffic Alert may result in accidents and serious injuries.

- The Blind Spot Monitor with Rear Traffic Alert is not a substitute for careful and attentive driving.
- Always adjust your driving style to road, traffic, weather, and visibility conditions.
- Always keep both hands on the steering wheel so that you are prepared to steer at any time.
- Pay attention to and heed the indicator lights in the outside mirrors and in the instrument cluster display.
- The Blind Spot Monitor may react to certain equipment installed on the side of the road, such as high or offset guardrails. False warnings may result.
- Never use the Blind Spot Monitor with Rear Traffic Alert on unpaved roads. The Blind Spot Monitor with Rear Traffic Alert was designed only for paved roads.
- Always pay attention to the area surrounding your vehicle.
- Never use the Blind Spot Monitor with Rear Traffic Alert if the radar sensors are dirty, obstructed, or damaged; the function of the system may be impaired.

NOTE


- The radar sensors in the rear bumper can be damaged or become misaligned in low-speed impacts and parking maneuvers. The system can switch itself off or may be impaired as a result.
- Always keep the rear bumper clean and free of snow and ice so that the radar sensors can function properly. Do not cover the radar sensor area.
- The rear bumper may only be painted with vehicle paint that is approved by Volkswagen. Other paints may impair the function of the Blind Spot Monitor or cause it to malfunction.
- Sunlight may reduce the visibility of the indicator light in the outside mirror.



If the system does not function as described in this chapter or if your vehicle was involved in a collision, do not use the Blind Spot Monitor with Rear Traffic Alert. See an authorized Volkswagen dealer or an authorized Volkswagen Service Facility to have the system checked.

Indicator lights



Read and follow the introductory information and safety information first ⇒  [Introduction to the subject](#)

Indicator light in the instrument cluster display:

Lights up Possible cause

Blind Spot Monitor malfunction.



Contact an authorized Volkswagen dealer or authorized Volkswagen Service Facility for assistance.

Indicator light in the outside mirror:

Lights up Possible cause


Lights up briefly: The Blind Spot Monitor is active and ready.



Lights up and stays on: The Blind Spot Monitor detects a vehicle in the blind spot.

Flashes Possible cause



A vehicle is detected in the blind spot, and the turn signal on that side of the vehicle is switched on ⇒  .

check. They go out after a few seconds.

If the indicator light in the outside mirror does not light up, the Blind Spot Monitor does not currently detect a vehicle in the monitored area around your vehicle ⇒ .

The brightness of the indicator lights in the outside mirrors are dimmed when the headlights are switched on (night mode).

WARNING

Failure to heed warning and indicator lights and instrument cluster text messages can result in a collision and serious personal injury.

- Never ignore warning and indicator lights or text WARNINGS.
- Always heed warning and indicator lights and take action where necessary.

NOTE

Failure to heed warning and indicator lights or text WARNINGS can result in vehicle damage.

Blind Spot Monitor

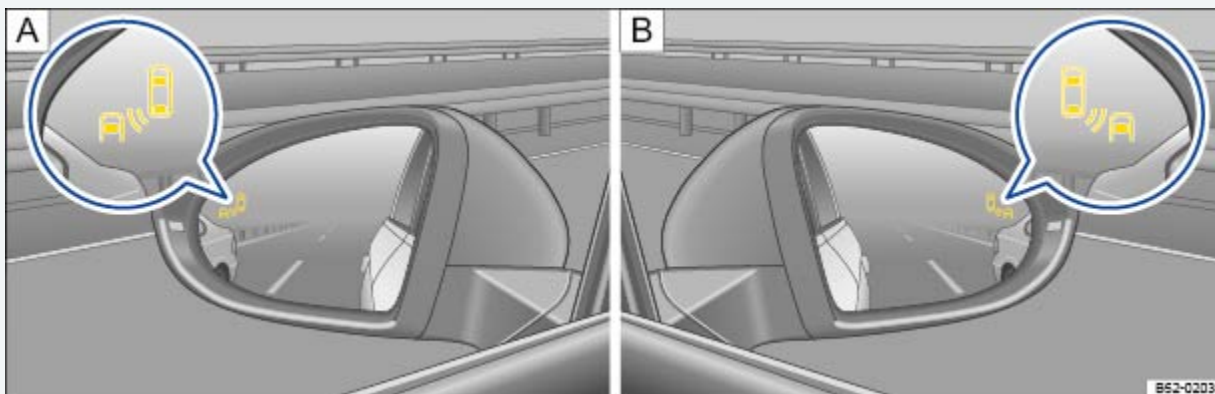


Fig. 182 In the outside mirrors: Indicator lights for the Blind Spot Monitor.

Read and follow the introductory information and safety information first ⇒ [Introduction to the subject](#)

The Blind Spot Monitor uses sensors to monitor the blind spot detection area and the area behind



distance to other vehicles and the difference in speed between your vehicle and other vehicles. The Blind Spot Monitor only works at speeds above about 9 mph (15 km/h).

The Blind Spot Monitor automatically deactivates when driving through tight curves in the road. In this situation, the deactivation occurs without a driver information message. No warnings appear in the mirror glass or in the instrument cluster display. After driving through the curve, the Blind Spot Monitor automatically reactivates and the system is available again.

Indicator lights in the outside mirrors

The indicator light [⇒ Fig. 182](#) in the glass for the respective outside mirror informs you about traffic to the rear, if the system interprets the situation as critical. The indicator light in the driver side outside mirror **A** informs you about traffic to the left, and the indicator light in the passenger side outside mirror **B** informs you about traffic to the right of your vehicle.

Tinting on the side windows or aftermarket tinting films can interfere with the indicator lights in the outside mirrors or cause false readings.

Keep the glass in the outside mirrors clean and free of snow and ice, and do not cover the mirrors with stickers or other objects.

Radar sensors

The radar sensors are behind the rear bumper on the left and right [⇒ Fig. 3](#). They are not visible from outside the vehicle. They monitor an area about 21 yards (20 meters) behind the vehicle as well as the blind spots on the left and right sides of the vehicle. The monitored area next to the vehicle is about one lane wide.

The width of the lane is not detected individually on each road, but is preprogrammed into the system. Because of this, the indicators may be incorrect when driving on narrow roads or driving in the center of two lanes. Likewise, vehicles that are two lanes away from you or stationary objects such as guard rails may also be detected and cause a false warning.

Driving situations

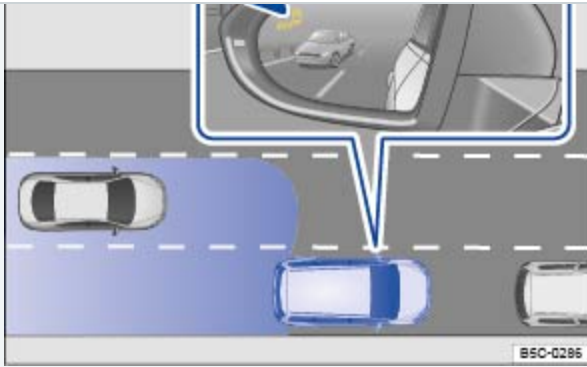


Fig. 183 Driving situation when passing with traffic behind your vehicle. Arrow: Blind Spot Monitor indicator light in the driver side mirror.

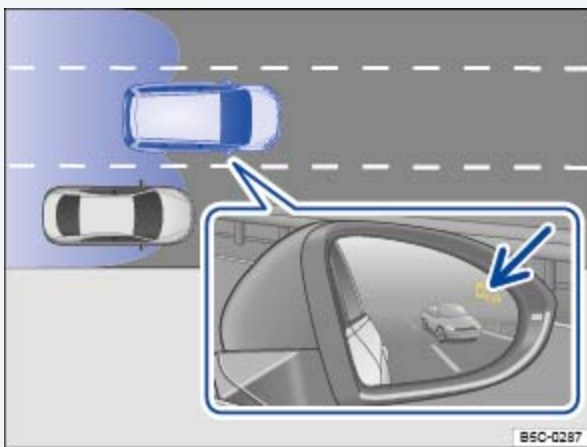


Fig. 184 Driving situation when passing and merging into the lane. Arrow: Blind Spot Monitor indicator light in the passenger side mirror.



Read and follow the introductory information and safety information first ⇒ [Introduction to the subject](#)

The following situations result in a signal in the outside mirror ⇒ [Fig. 183](#) (arrow) or ⇒ [Fig. 184](#) (arrow).

- If your vehicle is being passed by another vehicle ⇒ [Fig. 183](#).
- When passing another vehicle ⇒ [Fig. 184](#), and the difference in speed between the two vehicles is no more than about 6 mph (10 km/h). There is no signal if the passing speed is clearly faster.

The faster another vehicle approaches, the earlier the signal in the outside mirror appears, because the Blind Spot Monitor accounts for the difference in speed between your vehicle and other vehicles. Therefore, the signals may trigger for different vehicles at different times, even when the distance to those vehicles is the same.

automatically when the vehicle speed drops below about 6 mph (10 km/h).

Physical and system limitations

In certain situations, the Blind Spot Monitor may not interpret the traffic situation correctly. These situations may include:

- When driving in tight curves.
- When the width of the lanes differs.
- When there is a rise in the road surface.
- When there are poor weather conditions.
- When certain types of equipment are on the side of the road, such as high or offset guard rails.

Rear Traffic Alert



Fig. 185 Rear Traffic Alert: Monitored area around the vehicle that is backing out of a parking space.

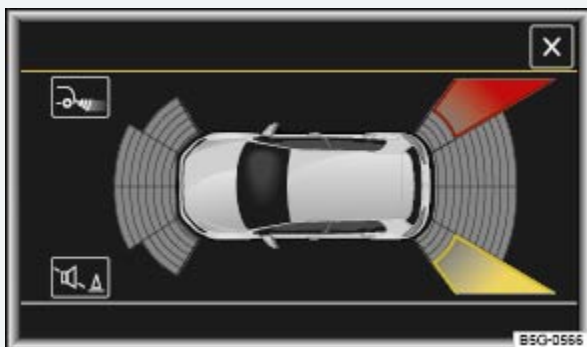





Fig. 186 Rear Traffic Alert display: Colored display shown (may vary depending on vehicle equipment).



Read and follow the introductory information and safety information first ⇒ [Introduction to the](#)

Key to ⇒ <i>Fig. 186</i>	
Color or symbol	Meaning
	The yellow area indicates that the system has possibly detected traffic behind the vehicle.
	The red area indicates that the system has detected traffic behind the vehicle.
	There is a system malfunction in the scanned area (not pictured).

The Rear Traffic Alert system uses the radar sensors in the rear bumper to monitor the traffic crossing behind your vehicle when you are backing out of a parking space or maneuvering, for example, in traffic situations with poor visibility.

A warning sounds if the system detects approaching traffic behind your vehicle when backing up ⇒ *Fig. 185* (red area).

- *Vehicles without Park Distance Control (PDC):* There is a warning tone and a text message in the instrument cluster display.
- *Vehicles with Park Distance Control (PDC):* There is a continuous warning tone from the PDC. If PDC is deactivated, a warning for the driver may not be possible, and therefore the Rear Traffic Alert is also deactivated.

Automatic braking intervention

If the Rear Traffic Alert detects an approaching vehicle and the driver does not press the brake pedal, the system can intervene with automatic braking.

The Rear Traffic Alert assists the driver with harsh automatic braking that could help prevent or reduce damage that may result from a collision. The automatic braking occurs while backing up at speeds between 1–7 mph (1–12 km/h). Once the system detects that your vehicle is stationary, it



After an automatic braking intervention, about 10 seconds must pass before the system can brake automatically again.

The driver can interrupt the automatic braking and take control of the vehicle by pressing firmly on the gas or brake pedal.

WARNING

The Blind Spot Monitor with Rear Traffic Alert technology cannot overcome the laws of physics and limits of the system. Careless or unintentional use of the Blind Spot Monitor and Rear Traffic Alert may result in accidents and serious injuries.

- The Rear Traffic Alert is not a substitute for careful and attentive driving.
- Never use the system when visibility is limited or in confusing traffic situations, for example, on heavily traveled roads or when there are multiple lanes.
- Always watch for people, especially small children, bicycles, animals, and objects, because the Rear Traffic Alert may not always be able to detect them. Rear Traffic Alert cannot detect people, animals, and things that are moving slowly or not at all.
- The Rear Traffic Alert does not always brake the vehicle to a complete stop.
- The harsh automatic braking will be uncomfortable for many people, and if you or your passengers have special conditions or sensitivities, particularly in the neck, you may want to switch off Rear Traffic Alert.

Using the Blind Spot Monitor with Rear Traffic Alert



Read and follow the introductory information and safety information first ⇒  [Introduction to the subject](#)

Switching the Blind Spot Monitor with Rear Traffic Alert on and off


On appropriately equipped vehicles, you can turn the Blind Spot Monitor and Rear Traffic Alert on and off in the Assist systems menu in the Volkswagen Information System.

Open the Assist systems menu.

- Blind Spot



Switching the Blind Spot Monitor and Rear Traffic Alert on and off in the Infotainment system

- Press the **CAR** button.
- Tap the  function key.
- Tap the Assistance systems function key to switch the Blind Spot Monitor on or off.
- Tap the Parking and maneuvering function key to switch the Rear Traffic Alert on or off.

When the box next to the option is checked , the function will turn on automatically when the ignition is switched on.

The indicator lights in the outside mirrors will turn on briefly to confirm that the Blind Spot Monitor is ready.

The indicator light in the instrument cluster informs you about the status of the system.

The last system setting that was stored is kept after switching the ignition off/on.

If the Blind Spot Monitor was deactivated automatically, the system can only be activated again after switching the ignition off/on.

Automatic deactivation of the Blind Spot Monitor

The radar sensors for the Blind Spot Monitor with Rear Traffic Alert turn off automatically if the system detects a permanent obstruction over a radar sensor. This could occur if the radar sensor area is covered by ice or snow, for example.

A text message appears in the instrument cluster display when the system turns off automatically.

Trailer towing

When towing a trailer, the Blind Spot Monitor and Rear Traffic Alert must be manually switched off.

Driving Mode Selection



Introduction to the subject

In this chapter you will find information on the following subjects:



⇒ *Function and operation*

⇒ *Adjusting the Custom driving mode*

Your vehicle may be equipped with the Driving Mode Selection feature.

WARNING

Driving on today's roads demands the full attention of the driver at all times. Driver distraction causes accidents, collisions and serious personal injury!


- Never let yourself be distracted when selecting a driving mode or using the Infotainment system.
- Always drive attentively and responsibly. Use the Driving Mode Selection feature and the Infotainment system only if road, traffic, and weather conditions permit and you will not be distracted from your driving.

Indicator light



Read and follow the introductory information and safety information first ⇒  *Introduction to the subject*

Lights up

Possible cause ⇒ 

Adaptive chassis control DCC system malfunction (if equipped).^{a)}



Have the system checked by an authorized Volkswagen dealer or authorized Volkswagen Service Facility.

When the ignition is switched on, several warning and indicator lights come on briefly for a function check. They go out after a few seconds.

Failure to heed warning and indicator lights and instrument cluster text messages can result in a collision and serious personal injury.

- Never ignore warning and indicator lights or text WARNINGS.
- Always heed warning and indicator lights and take action where necessary.

! NOTE

Failure to heed warning and indicator lights or text WARNINGS can result in vehicle damage.

a) Displayed in color on an instrument cluster with color display.

Function and operation



Fig. 187 In the lower center console: Driving Mode Selection button.



Read and follow the introductory information and safety information first ⇒ [Introduction to the subject](#)

The driver can choose from different driving modes, each of which has different driving characteristics:

Driving mode	Recommended driving situations
--------------	--------------------------------



Comfort ^{a)}	Gives the vehicle a more comfortable driving feel, which may be preferred, for example, on bumpy road conditions or on long highway drives.
Normal	Balanced setting for everyday use.
Sport	Gives the vehicle a sporty driving feel and is suited for a sporty driving style.
Race ^{b)}	
Custom	Individual systems can be adjusted to suit your personal requirements <i>⇒ Adjusting the Custom driving mode.</i>

The effect on the vehicle settings in the individual driving modes depends on vehicle equipment.

The driving mode can be changed while the vehicle is stationary or when it is moving. After selecting a driving mode, the vehicle settings (excluding engine settings) are switched to the new driving mode immediately.

When traffic conditions allow, briefly take your foot off the accelerator to activate the newly selected driving mode for the engine.

Steering

In Sport or Race mode, power steering is reduced and the effort required to steer the vehicle increases. The vehicle's driving response becomes more agile.

Powertrain (engine and transmission)

The engine and transmission will give either a more dynamic or more balanced response to the movement of the accelerator, depending on the selected driving mode. In vehicles with an automatic trans-



acceleration response.

Adaptive Cruise Control (ACC)


When the ACC is active, vehicle acceleration and deceleration can become more sporty, depending on the selected driving mode.

Adaptive front lighting system (AFS) and Light Assist (if equipped)

AFS and Light Assist give either a more dynamic or more balanced response to the current driving situation, depending on the selected driving mode.

Adaptive chassis control DCC (if equipped)

While driving, DCC continuously adjusts the suspension characteristics to match the current road and driving conditions in accordance with the selected driving mode.

If the DCC system malfunctions, the  indicator light appears in the instrument cluster display along with a driver information message.



Engine sound

The engine sound can be adjusted in the Custom driving mode.

Front differential lock

In the Sport driving mode, the front differential lock provides a more agile driving response.

Displaying the driving mode


- Switch on the ignition.
- Press the Driving Mode Selection button  ⇒ *Fig. 187*. The Driving Mode Selection menu appears in the Infotainment system display. The active driving mode is highlighted.
- Tap the information (i) function key to display additional information about the current driving mode.
- Tap the  function key to close the menu, if necessary.

Selecting the driving mode


- Switch on the ignition.



driving mode in the Infotainment system display.

- OR: press the Driving Mode Selection button  to toggle through the driving modes.

The selected driving mode will stay set even after the ignition has been switched off.

If the Sport, Race, or Custom modes are selected, the  lights up. The light in the button goes out when the Normal driving mode is selected.

In vehicles with an automatic transmission, the transmission automatically shifts to Sport drive (S) when either the Sport or Race driving mode is selected. After the ignition is switched off, the current driving mode remains set but the automatic transmission may return to Drive (D) when the ignition is switched back on again.

To shift to Sport drive (S), briefly pull the selector lever back ⇒ *Shifting*.

WARNING

Changing the driving mode can alter the vehicle handling. Never allow Driving Mode Selection to tempt you into taking extra risks.

- Always adjust your speed and driving style to road, traffic, weather, and visibility conditions.

WARNING

Failure to heed warning lights and instrument cluster text messages can cause the vehicle to break down in traffic and result in a collision and serious personal injury.

- Never ignore warning lights or text WARNINGS.
- Always stop the vehicle as soon as it is safe to do so.

NOTE

Failure to heed warning lights or text WARNINGS can result in vehicle damage.




The driver can adjust certain vehicle functions, regardless of the selected driving mode. For example, the driver can shift the selector lever to Sport drive (S), even if the Normal driving mode is selected.


- a) Available only on models equipped with adaptive chassis control DCC.
- b) Available only on Golf R models (instead of Sport mode).

Adjusting the Custom driving mode



Read and follow the introductory information and safety information first ⇒  [Introduction to the subject](#)

The systems that can be adjusted to your individual requirements depend on the vehicle equipment.

- Switch on the ignition.
- If necessary, switch on the Infotainment system.
- Press the Driving Mode Selection button  and tap the Custom function key in the Infotainment system display.
- Tap the Adjust function key to open the Custom menu.

A checkmark next to the name of the function indicates that the function is switched on.

Tapping the  function key always takes you back to the previously active menu.

Custom menu

The following options in the Custom menu may vary depending on vehicle equipment.

Submenu	Settings options
DCC: ^{a)}	Comfort
	Normal



	Sport
Steering:	Normal
	Sport
Drive system:	Normal
	Sport
Front differential lock: ^{b)}	Normal
	Sport
ACC: ^{b)}	Normal
	Sport
Dyn. Adapt. Frnt. Lght (AFS)	Normal
	Sport
Engine sound:	Normal
	Sport



Reset mode:

Settings are reset to Normal.

Changes to the settings are applied immediately, with the exception of engine settings.

WARNING

Driving on today's roads demands the full attention of the driver at all times. Driver distraction causes accidents, collisions and serious personal injury!

- Never let yourself be distracted when setting, adjusting, or using the Infotainment system.
- Always drive attentively and responsibly. Use the Infotainment system only if road, traffic, and weather conditions permit and you will not be distracted from your driving.

a) Option only available on models equipped with adaptive chassis control DCC.

b) Option only available on models equipped with Adaptive Cruise Control (ACC).

Performance Monitor



Introduction to the subject

In this chapter you will find information on the following subjects:

⇒ *Performance Monitor sport gauges*

⇒ *Performance Monitor lap timer and stopwatch*

Your vehicle may be equipped with the Performance Monitor feature.

WARNING

Driving on today's roads demands the full attention of the driver at all times. Driver distraction causes accidents, collisions and serious personal injury!

- Never pay so much attention to the gauges in the Infotainment system that you fail to notice what is going on around you.

WARNING

Rapid acceleration can cause skidding and loss of traction, especially on slippery roads, resulting in a loss of vehicle control, collisions, and serious personal injury.

Performance Monitor sport gauges



Fig. 188 In the Infotainment system: Performance Monitor sport gauges. Gauges shown in the display may vary depending on configuration.



Read and follow the introductory information and safety information first ⇒ [Introduction to the subject](#)

Your vehicle may be equipped with the Performance Monitor feature, which includes sport gauges and a lap timer/stopwatch in the Infotainment system.

Depending on vehicle equipment, the following Performance Monitor sport gauges may be available:

- Boost pressure gauge ⇒ [Fig. 188①](#)
- Accelerometer (g-meter) ⇒ [Fig. 188②](#)
- Power display ⇒ [Fig. 188③](#)
- Engine oil temperature gauge
- Engine coolant temperature gauge

You can access the Performance Monitor sport gauges in the Infotainment system by pressing the **CAR** button followed by Selection and Sport.



gauges and the lap timer/stopwatch ⇒ [Performance Monitor lap timer and stopwatch](#).

Changing the gauges and units in the display

The display can show 3 Performance Monitor sport gauges at any given time. Swipe your finger up or down on a gauge to select a different one.

For some gauges, the units can be changed in the Infotainment system. See ⇒ [Menu and system settings](#).

Boost pressure gauge

The boost pressure gauge ⇒ [Fig. 188①](#) shows the pressure in the boost pressure duct between the turbocharger and the engine (shown in bar or psi, depending on the units selected). The farther right the needle points on the gauge, the higher the pressure in the boost pressure duct and the greater the output from the engine.

Accelerometer (g-meter)

The accelerometer, or g-meter ⇒ [Fig. 188②](#), shows the current vehicle acceleration in the center display (shown in g).

The red mark moves to different areas of the gauge as the direction of acceleration changes. If you turn left, the mark moves to the right of the gauge (and vice versa). The red mark also moves down when accelerating and up when braking. These values are combined in certain situations, for example, when making a right turn while accelerating, the red mark moves to the lower left area of the gauge.

The red mark also moves toward or away from the center of the gauge depending on the level of acceleration. The farther the red mark is from the center, the heavier the acceleration (greater g).


Power display

The power display ⇒ [Fig. 188③](#) shows the current engine power output on both a gauge and a digital display (shown in kilowatts).

Engine oil temperature gauge


If the needle in the engine oil temperature gauge is located in the cold range, the engine has not reached operating temperature. Avoid high engine speeds and heavy engine loads until the engine has reached operating temperature.



under normal driving conditions. The needle may move farther to the right on the gauge with a heavier engine load at high outside temperatures. This is not a cause for concern as long as the indicator light  does not light up or flash in the instrument cluster. See [⇒ Engine oil](#).

Engine coolant temperature gauge

If the needle in the engine coolant temperature gauge is located in the cold range, the engine has not reached operating temperature. Avoid high engine speeds and heavy engine loads until the engine has reached operating temperature.

Under normal driving conditions, the needle should be in the middle of the gauge. The temperature may go higher when the engine is working hard, especially in hot weather. This is not a cause for concern as long as the indicator light  does not light up or flash in the instrument cluster. See [⇒ Engine coolant](#).

WARNING

Driving on today's roads demands the full attention of the driver at all times. Driver distraction causes accidents, collisions and serious personal injury!

- Never pay so much attention to the gauges in the Infotainment system that you fail to notice what is going on around you.

WARNING

Rapid acceleration can cause skidding and loss of traction, especially on slippery roads, resulting in a loss of vehicle control, collisions, and serious personal injury.

NOTE

To help prevent engine damage, always avoid high engine speeds, full throttle acceleration and heavy engine loads when the engine is cold.



Because conditions used to determine vehicle performance may vary, the displayed values may not always be exact.

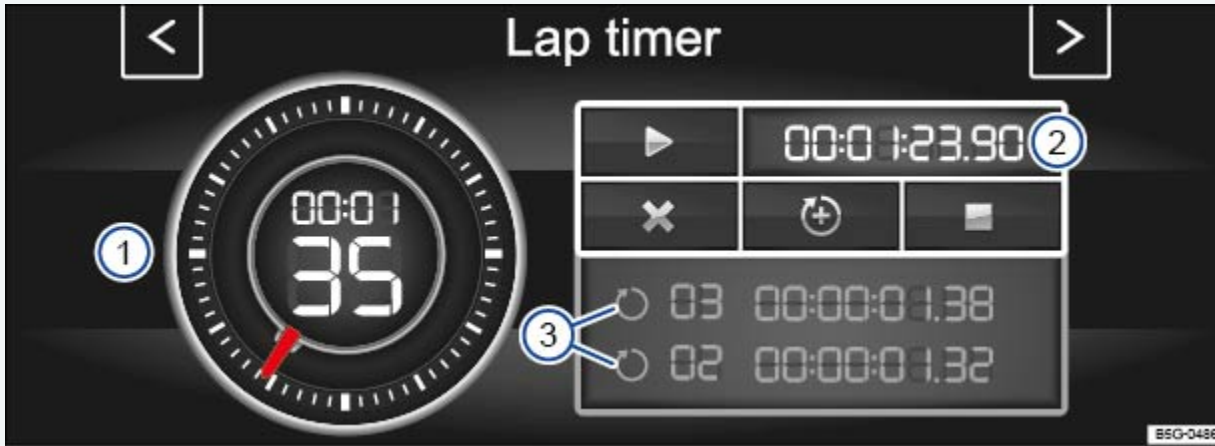


Fig. 189 In the Infotainment system: Performance Monitor lap timer/stopwatch.

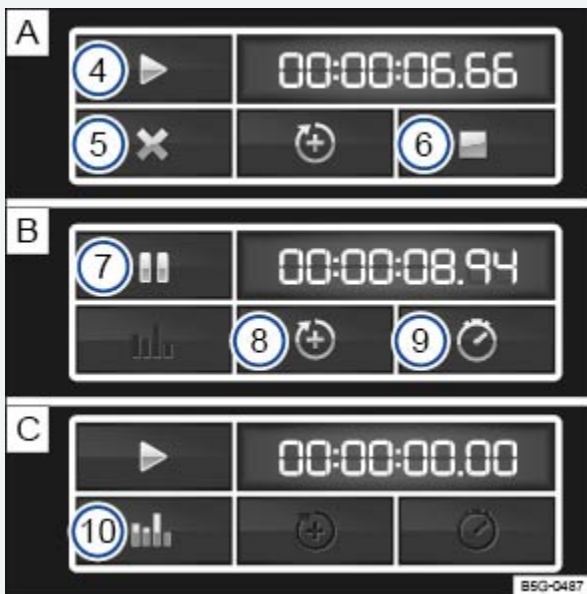


Fig. 190 In the Infotainment system: Buttons for operating the Performance Monitor lap timer/stopwatch. The buttons displayed vary depending on the current lap timer/stopwatch activity.



Read and follow the introductory information and safety information first ⇒ [Introduction to the subject](#)

You can access the lap timer/stopwatch in the Infotainment system by pressing the **CAR** button followed by the Selection and Sport function keys.

Tap the arrow buttons at either side of the screen to toggle between the Performance Monitor sport gauges and the lap timer/stopwatch ⇒ [Performance Monitor sport gauges](#).

Key to ⇒ [Fig. 189](#) and ⇒ [Fig. 190](#) :

- ② Digital split time display
- ③ Display of recent split times
- ④ Play button to start timing
- ⑤ Button to cancel the current lap
- ⑥ Stop button to end timing
- ⑦ Pause button to pause timing
- ⑧ Button to start a new lap
- ⑨ Button to show lap split times in the stopwatch display
- ⑩ Button to show statistics

Operating the stopwatch and lap timer

The stopwatch has two different measuring functions. The stopwatch in the outer ring of the display (red needle) ⇒ [Fig. 189](#) can measure up to 60 seconds. The digital display in the center of the stopwatch shows the elapsed hours, minutes, and seconds. The seconds appear as large numbers.

The digital display on the right side ⇒ [Fig. 189](#) shows the current lap split time in 1/100 second intervals. If the lap timer is not being used to track split times, both digital displays show the same time.

Function	Action ⇒ Fig. 189 and ⇒ Fig. 190
----------	--



<p>Start or resume timing:</p>	<p>Tap the play button A ④.</p> <p>If you tap the play button when the vehicle is not moving, a confirmation message appears in the display. Tap Start to begin timing immediately. Otherwise, the timer starts automatically as soon as the vehicle moves forward.</p> <p>If laps have already been completed and are recorded in the statistics, timing will resume on the current lap.</p> <p>A new first lap can only be started if the statistics are reset in the statistics area. Tap the statistics button C ⑩ to see lap statistics and reset the lap timer, if necessary.</p>
<p>Stop timing:</p>	<p>Tap the stop button A ⑥.</p>
<p>Pause timing:</p>	<p>Tap the pause button B ⑦.</p>



<p>Start a new lap:</p>	<p>Tap button B ⑧.</p> <p>Timing of the current lap is interrupted and a new lap begins. The time of the completed lap is carried over to the statistics.</p>
<p>Cancel the current lap:</p>	<p>Tap button A ⑤ (after pressing pause B ⑦).</p> <p>Timing of the active lap ends and the lap time is deleted. It is entered in the statistics as --:--:--:--.</p>
<p>Show lap split times in the stopwatch display:</p>	<p>Tap button B ⑨.</p> <p>The split time is shown in the digital display in the center of the stopwatch ⇒ <i>Fig. 189</i> ⑩ only.</p>
<p>Show lap statistics:</p>	<p>Tap the statistics button C ⑩ to see lap statistics such as number of laps, total time, fastest lap number and time, slowest lap number and time, and individual lap times.</p> <p>From this screen you can also reset stored lap times.</p>



Reset lap timer and statistics:

Tap the Reset button in the statistics area (not shown).

A maximum of 99 laps and a maximum overall duration of 99 hours, 59 minutes, and 59 seconds can be recorded. If one of the two limits is reached, timing can only start again after tapping the Reset button in the statistics area.

For vehicles equipped with a lap timer in the instrument cluster display, see [⇒ Volkswagen Information System](#).

WARNING

Driving on today's roads demands the full attention of the driver at all times. Driver distraction causes accidents, collisions and serious personal injury!

- Never set the lap timer when the vehicle is moving.

WARNING

Rapid acceleration can cause skidding and loss of traction, especially on slippery roads, resulting in a loss of vehicle control, collisions, and serious personal injury.

- Only use the lap timer or fast acceleration if visibility, weather, road, and traffic conditions permit and other drivers will not be endangered by your driving and the vehicle's acceleration.

NOTE

To help prevent engine damage, always avoid high engine speeds, full throttle acceleration, and heavy engine loads when the engine is cold.

Climate control

Heating and air conditioning



In this chapter you will find information on the following subjects:

⇒ *Manual controls*

⇒ *Climatronic controls*

⇒ *Operation via the Infotainment system*

⇒ *Operation*

⇒ *Air vents*

⇒ *Air recirculation*

Manual air conditioning and Climatronic

Your vehicle is equipped with either a manual air conditioning climate control system or a Climatronic climate control system .

On vehicles with Climatronic climate control, Climatronic information appears in the Climatronic display and/or on the screen of the factory-installed Infotainment system.

The dust and pollen filter

The dust and pollen filter reduces the entry of pollutants into the passenger compartment.

The dust and pollen filter must be replaced at the intervals recommended in ⇒*Booklet Warranty and Maintenance*, so that the air conditioner can work properly.

If the effectiveness of the filter decreases prematurely due to operating the vehicle where the outside air is heavily polluted, the dust and pollen filter should be replaced more frequently than indicated.

WARNING

Poor visibility increases the risk of collisions and other accidents that cause serious personal injuries.



front, sides, and rear.

- Maximum heating output and defrosting performance are not possible until the engine has reached operating temperature. Wait until you have good visibility before driving off.
- Always make sure you know how to properly use the climate control system as well as the rear window defroster that you will need for good visibility.
- Never use air recirculation for long periods of time. When the air conditioner is off and recirculation mode is on, condensation can quickly form on the windows and greatly reduce visibility.
- Always switch off recirculation mode when it is not needed.

WARNING

Stale air causes driver fatigue and reduces driver alertness, which can cause accidents, collisions and serious personal injury.

- Never switch off the fan for a long period of time and never use air recirculation for a long period of time because no fresh air will enter the passenger compartment.

NOTE

- If you think the air conditioner is not working properly or may be damaged, switch it off to help prevent more damage. Have the air conditioner checked by an authorized Volkswagen dealer or an authorized Volkswagen Service Facility.
- Air conditioner repair requires specialized knowledge and special tools. Volkswagen recommends that you see an authorized Volkswagen dealer or an authorized Volkswagen Service Facility.
- Do not smoke when air recirculation is switched on. Smoke drawn into the ventilation system can leave residue on the evaporator and on the dust and pollen filter, resulting in permanent odors whenever the air conditioner is switched on.
- The heating elements for the rear defroster are on the inside of the rear window. Do not put stickers over the heating elements on the inside of the rear window and never clean the inside of the windows with corrosive or acidic cleaning agents or other chemicals that could damage the heating elements.



the windows from fogging over, Volkswagen recommends leaving the air conditioner (compressor) switched on. Press the **A/C** button. The indicator light in the button must light up.



When it is very hot and humid outside, water condensation can drip from the air conditioner evaporator and form a puddle under the vehicle. This is normal and does not indicate a leak.



Keep the air intake slots in front of the windshield free of ice, snow, and leaves in order to maintain proper functioning of the heating and ventilation systems.



Maximum heating output and defrosting performance are not possible until the engine has reached operating temperature.



Emergency starting and starting the engine with a very weak vehicle battery or after the vehicle battery has been replaced may change or delete system settings (including time, date, personal convenience settings, and programming). Check the settings and correct as necessary once the vehicle battery has built up a sufficient charge.

Manual controls

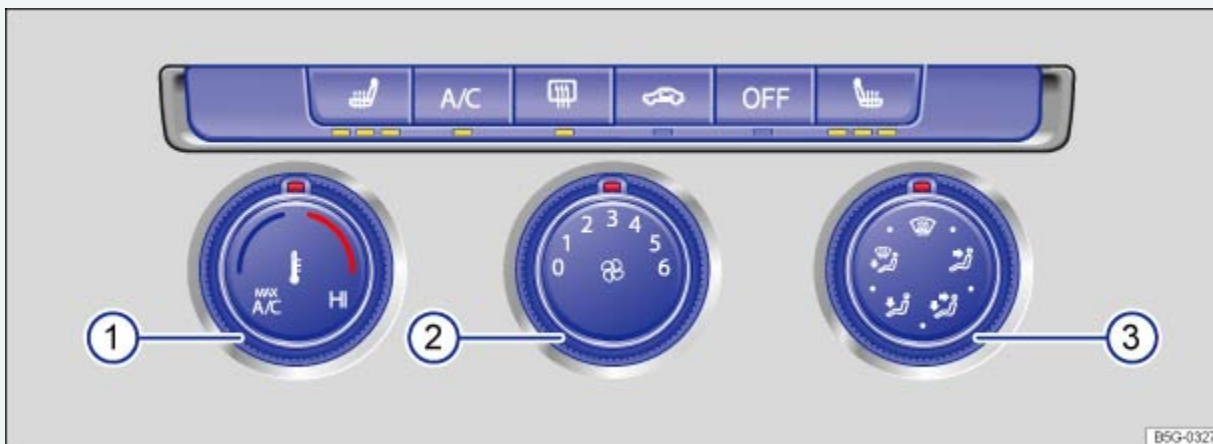








Fig. 191 In the center console: Manual air conditioning controls.







Read and follow the introductory information and safety information first ⇒ [Introduction to the subject](#)



tor light under the button lights up. To switch off a function, press the button again.

Button/Knob	More information: Manual air conditioning ⇒ Fig. 191
<p data-bbox="191 359 404 394">Temperature ①</p> 	<p data-bbox="500 359 1487 583">Turn knob to set the desired temperature. The maxA/C position provides maximum cooling output. Recirculation mode and the cooling system switch on automatically.</p>
<p data-bbox="253 682 342 718">Fan ②</p> 	<p data-bbox="500 682 1365 718">Setting 0: the fan and manual air conditioning are switched off.</p> <p data-bbox="500 869 894 905">Setting 6: highest fan speed.</p>
<p data-bbox="175 1005 418 1041">Air distribution ③</p>	<p data-bbox="500 1005 1463 1041">Direct airflow by turning knob to any setting (continuously adjustable).</p>
	<p data-bbox="500 1138 1484 1461">Defog/defrost: Airflow is directed to the windshield. Recirculation mode switches off automatically in this position. Increases the fan speed to clear the windshield as quickly as possible. The cooling system switches on automatically to dehumidify the air.</p>
	<p data-bbox="500 1556 1235 1591">Air distribution to the upper instrument panel outlets.</p>
	<p data-bbox="500 1688 1430 1724">Air distribution to the upper instrument panel outlets and footwells.</p>
	<p data-bbox="500 1818 938 1854">Air distribution to the footwells.</p>



	Air distribution to the windshield and footwells.
	Rear window defroster: Works only when the engine is running and switches off automatically after 10 minutes or less.
	Air recirculation mode ⇒ <i>Air recirculation</i> .
	Buttons for seat heating (if equipped) ⇒ <i>Seat heating</i> .
A/C	Press the button to switch the air conditioner on or off.
OFF	Press the OFF button. If the system is switched off, the indicator light under the OFF button lights up.

WARNING

Stale air causes driver fatigue and reduces alertness, which can cause accidents, collisions, and serious personal injury.

- Never switch off the fan for a long time because no fresh air will enter the passenger compartment.

Climatronic controls









Fig. 192 In the center console: Climatronic controls.



Read and follow the introductory information and safety information first ⇒ [Introduction to the subject](#)

Press the corresponding button to switch a function on or off. If a function is switched on, an indicator light in or under the button lights up. To switch off a function, press the button again.

Button/Knob	More information: Climatronic ⇒ Fig. 192 .
Temperature ① 	Left and right sides of the vehicle can be set to different temperatures. Turn the knob to set the temperature.
Fan ② 	Turn the knob to adjust the fan speed manually. In AUTO mode, the fan speed is automatically controlled depending on the vehicle speed to help prevent unnecessary noise.

<p>Air distribution ③</p>	<p>Press the buttons ⇒ Fig. 192 ③ to direct air flow in the desired direction.</p> <p>In AUTO mode, air flow is automatically adjusted to a comfortable level.</p>
<p>Displays ④</p>	<p>Left-side and right-side digital temperature displays.</p>
<p></p>	<p>Defog/defrost button. The incoming outside air is directed to the windshield, and air recirculation automatically switches off. To defrost the windshield as quickly as possible, humidity is removed from the air at temperatures above about +35 °F (+1.5 °C), and the blower is set to a high speed.</p>
<p></p>	<p>Air distribution to the upper instrument panel outlets.</p>
<p></p>	<p>Air distribution to the footwells.</p>
<p></p>	<p>Air is directed upward.</p>
<p></p>	<p>Rear window defroster: Works only when the engine is running and switches off automatically after 10 minutes or less.</p>
<p></p>	<p>Air recirculation mode ⇒ Air recirculation.</p>



	Buttons for seat heating ⇒ <i>Seat functions</i> .
A/C	Press the button to switch the air conditioner on or off.
MAX A/C	Press the button for maximum air conditioner cooling. The air recirculation and cooling system are switched on automatically and the air distribution is automatically set to position  .
SYNC	<p>Applies the temperature settings for the driver side to the passenger side: If the indicator light in the SYNC button lights up, the temperature settings for the driver side also apply to the passenger side.</p> <p>Press the button or turn the temperature knob for the passenger side to set a different temperature for the passenger side. The indicator light in the button goes out.</p>
AUTO	<p>Automatic temperature control, fan speed, and air distribution.</p> <p>Press the AUTO button to switch on the feature. The indicator light in the button lights up.</p>



MENU	Press the button to open the air conditioning settings in the Infotainment system ⇒ <i>Operation via the Infotainment system</i> .
OFF	Press the OFF button. If the system is switched off, the indicator light in the OFF button lights up. OR: Turn the blower switch to the left as far as it will go. OR: Switch off using the Infotainment system ⇒ <i>Operation via the Infotainment system</i> .

WARNING

Stale air causes driver fatigue and reduces alertness, which can cause accidents, collisions, and serious personal injury.


- Never switch off the fan for a long time because no fresh air will enter the passenger compartment.



When adjusting fan speed manually, LEDs in the knob ⇒ *Fig. 192* light up to indicate the current fan speed. During automatic regulation, the fan speed is not indicated.

Operation via the Infotainment system



Read and follow the introductory information and safety information first ⇒  *Introduction to the subject*



justed via the Infotainment system.

Opening the climate control settings menu



- Press the **MENU** ⇒ [Fig. 192](#) button on the Climatronic controls.

Tap the corresponding function key to switch a function on or off, or to select a submenu.

The current air conditioning settings are displayed in the upper section of the screen, for example, the temperatures that are currently set for the driver and passenger sides. Blue arrows indicate that cool air is flowing from the vents, while red arrows indicate that warm air is flowing from the vents.

Adjusting settings in the Infotainment system

The following menu items may be available, depending on vehicle equipment.


Function key	Options
AUTO	Tap the function key for automatic temperature control, fan speed, and air distribution. The indicator light in the AUTO button lights up.
MAX A/C	Tap the function key for maximum air conditioner cooling. The air recirculation and cooling system are switched on automatically and the air distribution is automatically set to position 
MAX 	Tap the function key for defog/defrost. The incoming outside air is directed to the windshield, and air recirculation automatically switches off. To defrost the windshield as quickly as possible, humidity is removed from the air at temperatures above about +35 °F (+1.5 °C), and the blower is set to a high speed.



Manual	Displays only when the climate control system is in manual mode.
Temperature displays for driver side and passenger side	Tap the blue bar at the left of each function key to decrease the temperature. Tap the red bar at the right of each function key to increase the temperature.
OFF	Tap to switch the Climatronic on (white) or off (yellow).
SYNC	Applies the temperature settings for the driver side to the passenger side. The word SYNC appears in yellow on the screen and the indicator light in the SYNC button lights up when the feature is active.

Operation



Read and follow the introductory information and safety information first ⇒  [Introduction to the subject](#)

The air conditioner works only when the ignition is switched on. The cooling system for the passenger compartment works only when the engine is running and the fan is on.

The air conditioner is most efficient when the windows and the power sunroof are closed. If the vehicle is stationary and the passenger compartment becomes very hot due to sunlight, briefly opening the windows and the power sunroof may speed up the cooling process.

Keep the air intake slots in front of the windshield free of ice, snow, and leaves so that the heating



Settings for optimum visibility

When you switch on the cooling system, both the temperature and humidity in the vehicle are reduced. This will help make passengers feel more comfortable and help keep the windows from fogging up.

For manual air conditioning


- Switch off the air recirculation ⇒ [Air recirculation](#) .
- Set the fan to the desired speed.
- Turn the temperature knob to the center position.
- Open and adjust all air vents in the instrument panel ⇒ [Air vents](#) .
- Turn the air distribution knob to the desired setting.
- Push the **A/C** button to turn on the air conditioner. The indicator light in the button lights up.

For Climatronic

- Press the **AUTO** button.
- Set the temperature to +72 °F (+22 °C).
- Open and adjust all air vents in the instrument panel ⇒ [Air vents](#) .

Climatronic: Changing the temperature units

The inside and outside temperatures can be displayed in either Fahrenheit (F) or Celsius (C).

You can change the units in the Infotainment system by pressing the **CAR** button followed by the  and Units function keys ⇒ [Menu and system settings](#) .

Heating

Maximum heating output and defrosting performance are not possible until the engine has reached operating temperature.

Air conditioner does not work

The air conditioner may not switch on for one of the following reasons:

- The fan is switched off.
- The air conditioner fuse has blown.
- The outside air temperature is colder than about +38 °F (+3 °C).
- The air conditioner compressor has been temporarily switched off due to excessive engine coolant temperature.
- There is another malfunction in the vehicle. Have the air conditioner checked by an authorized Volkswagen dealer or authorized Volkswagen Service Facility.

Special considerations

When it is very hot and humid outside, water condensation can drip from the air conditioner evaporator and form a puddle under the vehicle. This is normal and does not indicate a leak.



The climate control system adjusts the passenger compartment temperature as fast as possible considering the outside temperature.



Due to residual moisture in the air conditioner, the windshield may fog up after the engine is started. Switch on the windshield defroster to help evaporate the condensation as quickly as possible.



The air coming out of the vents flows through the passenger compartment and through the vents in the luggage compartment. Do not cover these slots with clothing or other things.

Air vents



Fig. 193 In the instrument panel: Air vents.



subject

Air vents

To help ensure sufficient heating, cooling, and ventilation in the passenger compartment, never close the air vents completely ⇒ [Fig. 193①](#).

- To open and close the air vents, turn the respective thumbwheel (magnified view) in the desired direction. When the thumbwheel is turned all the way toward position ►, the air vent is closed.
- Use the lever on the vent grille to adjust the airflow direction.

Additional, non-adjustable air vents are located in the instrument panel ⇒ [Fig. 193②](#), in the footwells, as well as in the rear area of the passenger compartment.

Some models also have an adjustable air vent inside the glove compartment ⇒ [Glove compartment](#).

! NOTE

Do not place food, medications, or other temperature-sensitive things in front of the air vents. Food, medications, and other things that are sensitive to heat or cold can be damaged or made unusable by the air flow from the vents.



The air coming out of the vents flows through the passenger compartment and through the air vents in the luggage compartment. Do not cover these slots with clothing or other things.

Air recirculation



Read and follow the introductory information and safety information first ⇒ [Introduction to the subject](#)

General information





Air recirculation mode.

The air recirculation mode helps prevent outside air from entering the vehicle interior.





rior faster.

For safety reasons, air recirculation is switched off in the following situations ⇒ ⚠ :

- *Manually:* The **MAX**  button is pushed (Climatronic) or the air distribution knob is turned to  (manual air conditioning).
- *Automatically:* A sensor detects conditions that could cause the windows to fog up.

Switching air recirculation mode on and off

Switching on: Press the  button. The indicator light under the button lights up.

Switching off: Press the  button. The indicator light under the button goes out.

WARNING

Stale air causes driver fatigue and reduces driver alertness, which can cause accidents, collisions and serious personal injury.

- Never use air recirculation mode over an extended period of time, since no fresh air will enter the passenger compartment.
- When the air conditioner is off and recirculation mode is on, condensation can quickly form on the windows and greatly reduce visibility.
- Always switch off recirculation mode when it is not needed.

NOTE

Do not smoke when air recirculation is switched on. Smoke drawn into the ventilation system can leave residue on the evaporator and on the dust and pollen filter, resulting in permanent odors whenever the air conditioner is switched on.



Climatronic: When backing up and while the automatic wiper/washer is operating, air recirculation is briefly activated to help keep exhaust fumes from getting into the passenger compartment.



Refueling



[Purchase Owner's Literature](#) | [Terms](#) | [Privacy](#)

* This Online Owner's Manual may not include Supplements issued after the publication of the physical Owner's Manual. Please consult your physical Owner's literature. In the event of a discrepancy between the Online Owner's Manual and physical Owner's literature, the physical Owner's literature controls.

"Volkswagen" and the Volkswagen logo are registered trademarks of Volkswagen AG. © 2018 Volkswagen of America, Inc.

The fuel filler flap is located on the rear right side of the vehicle.

WARNING

Improper refueling or handling of fuel is dangerous and can cause fire, explosion, and severe burns.

- Always make sure that the fuel filler cap is screwed on all the way. This helps keep fuel from spilling out or evaporating.
- Fuel is highly flammable and explosive; it can cause severe burns and other severe injuries.
- Failure to shut the engine off while refueling and/or to insert the pump nozzle all the way into the fuel filler neck can cause fuel to overflow and to spray out. Fuel spray and overflowing fuel are dangerous because they can cause fire and serious personal injury.
- During refueling, the engine and the ignition must be switched off for safety reasons.
- Never use a mobile telephone, CB radio, or other radio equipment while refueling. The electromagnetic radiation can cause sparks that can ignite fuel vapors and cause a fire.
- Never get back into your vehicle while refueling. If in exceptional circumstances you must get back in your vehicle while refueling, make certain that you close the door and touch metal to discharge static electricity before touching the filler nozzle again. This helps avoid the buildup of static electricity, which can cause sparks that can ignite fuel vapors released during refueling.



where in or near your vehicle when refueling or filling a portable fuel container.

- Follow all safety instructions and procedures that apply at the service station where you refuel.
- Never spill fuel in the vehicle or the luggage compartment.

WARNING

Even if empty, portable fuel containers can leak and cause a fire and serious personal injuries, especially in a crash.

- For your safety, we strongly recommend that you do not travel with a portable fuel container in your vehicle.
- If, under exceptional circumstances, you must transport a portable fuel container, please observe the following:
 - Never fill a portable fuel container while it is anywhere in or on the vehicle (for example, in the luggage compartment or on top of the trunk lid). Static electricity can build up while filling and can ignite fuel vapors, causing a fire.
 - Always place a portable fuel container on the ground before filling. Never spill fuel inside the vehicle or luggage compartment. Fuel vapors are highly flammable.
 - Always keep the filler nozzle completely inside the portable container before and during filling.
 - If filling a portable container made of metal, the filler nozzle must always be in contact with the container. This will help prevent static electricity from discharging and causing a fire.
 - Always observe local and state or provincial laws about the use, storage, and transportation of portable fuel containers.
 - Make certain that the portable fuel container meets industry standards, such as ANSI/ASTM F852-86.

NOTE

and wheel housings.

- Refueling with gasoline when your vehicle has a diesel engine or refueling with diesel fuel when your vehicle has a gasoline engine can cause very serious and expensive engine and fuel system damage that is not covered by any Volkswagen Limited Warranty.
- If you put any amount of incorrect fuel in the fuel tank, do not start the engine under any circumstances. Immediately contact the nearest authorized Volkswagen dealer or authorized Volkswagen Service Facility for assistance. These fuels contain substances that can severely damage the fuel system and the engine if the engine is started.



Fuels can pollute the environment. Spilled fuel must be collected and disposed of properly, following all applicable environmental regulations.



There is no emergency release for the fuel filler flap. Contact an authorized Volkswagen dealer or an authorized Volkswagen Service Facility for assistance.

Indicator lights and fuel gauge



Fig. 194 In the instrument cluster: Fuel gauge.



Read and follow the introductory information and safety information first ⇒ [Introduction to the subject](#)

Lights up

Gauge position

⇒ [Fig. 194](#)

Possible cause or meaning ⇒ Proper response




⇒ Fig. 194

Fuel tank almost empty.



Red range (arrow)

Time to refuel ⇒  .

Running on reserve ⇒ *Fuel capaci-*

ties .



-


Fuel filler cap not properly closed.^{a)}

Stop and close the fuel filler cap


properly.


When the ignition is switched on, several warning and indicator lights come on briefly for a function check. They go out after a few seconds.

Fuel filler cap not properly closed

If the indicator light  comes on or you see a text message in the instrument cluster display indicating that the fuel filler cap is not properly closed, stop the vehicle in a safe place and switch off the engine and the ignition.

Open the fuel filler flap and take the fuel filler cap off the filler neck. Then put the fuel filler cap back on the filler neck and screw it on clockwise until you clearly hear a clicking sound. Close the fuel filler flap.

After switching on the ignition, the indicator light  may stay on or the text message may still appear in the instrument cluster display, even if the fuel filler cap is now properly closed. This is normal and no reason to take your vehicle in for service.

If, however, the malfunction indicator light  also comes on, drive to your nearest authorized Volkswagen dealer or authorized Volkswagen Service Facility and have the fuel system and the engine checked.

Driving with a fuel tank that is almost empty can lead to stalling in traffic, a collision, and serious personal injuries.

- When the fuel tank is almost empty, fuel supply to the engine can be interrupted, especially when driving over bumps, across slopes, and up and down hills.
- Steering and braking assistance as well as ESC and related systems will not work if the engine sputters or stalls due to lack of fuel.
- Always refuel when the tank is 1/4 full to reduce the risk of running out of fuel and stalling in traffic.

NOTE

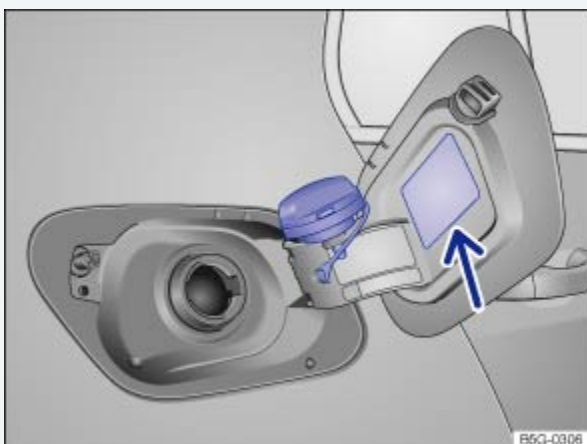
- Failure to heed warning lights or text WARNINGS can result in vehicle damage.
- Never drive until the fuel tank is completely empty. The irregular fuel supply can cause the engine to misfire. This allows unburned fuel to get into the exhaust system and damage the catalytic converter.



The small arrow next to the gas pump symbol in the fuel gauge ⇒ [Fig. 194](#) shows the side of the vehicle with the fuel filler flap.

a) Displayed in color on an instrument cluster with color display.

Refueling




[Fig. 195](#) Right rear side of vehicle: Fuel cap placed on the open fuel filler flap.



subject


Before refueling, always switch off the engine, the ignition, and all mobile phones, and leave them switched off until refueling is complete.

Opening the fuel filler cap

- Unlock the vehicle from the outside with the vehicle key or press the central locking button in the driver door  to unlock the vehicle from the inside ⇒ *Power locking system*.
- The fuel filler flap is located at the right rear of the vehicle.
- Press on the back part of the fuel filler flap and fold open.
- Unscrew the fuel cap counterclockwise and remove. Use the slot on the fuel filler flap hinge ⇒ *Fig. 195* to hold the cap while refueling.

Refueling

The correct fuel grade for your vehicle ⇒ *Fuel* is listed on a sticker on the inside of the fuel filler flap ⇒ *Fig. 195* (arrow).

- The fuel tank is *full* when the automatic filler nozzle pump switches off the first time ⇒ .
- Do not try to add fuel after the pump stops! Topping off the tank in this way may fill the expansion space that the tank needs and cause fuel to overflow, for example, if it gets warmer outside.

Closing the fuel filler cap

- Screw the fuel cap clockwise onto the fuel filler neck until you hear it click into place.
- Close the fuel filler flap until you hear it latch shut. The fuel filler flap must be flush with the vehicle body.

WARNING


Spilled fuel can cause fires, explosions, burns, and other severe injuries.

- Always stop refueling once the pump nozzle switches off so that the tank does not overflow.



NOTE



tires, and wheel housings.



 Fuel spills may pollute the environment.

Fuel capacities

 Read and follow the introductory information and safety information first ⇒  [Introduction to the subject](#)

Model	Fuel tank capacity
Golf, Golf GTI	About 13.2 gallons (50.0 liters), of which about 1.3 gallons (5.0 liters) are reserve.
Golf R	About 14.5 gallons (55.0 liters), of which about 1.3 gallons (5.0 liters) are reserve.

Refueling checklist

 Read and follow the introductory information and safety information first ⇒  [Introduction to the subject](#)

The engine compartment of any motor vehicle is a hazardous area. Never do any work on the engine or in the engine compartment unless you

- know exactly how to carry out the job,
- have the correct technical information and the proper tools and supplies, and



Checklist

If you are uncertain in any way, have the work done by an authorized Volkswagen dealer or authorized Volkswagen Service Facility. Serious personal injury may result from improperly performed work. Make sure that you check the following items regularly. The best thing is to check them every time you refuel:

- ✓ Windshield washer fluid level Windshield wipers and washer
- ✓ Engine oil level Engine oil
- ✓ Engine coolant level Engine coolant
- ✓ Brake fluid level Braking and parking
- ✓ Tire pressure Tires and wheels

Vehicle lighting necessary for driving safety:

- Turn signals
- Low beams and high beams
- Taillights
- Brake lights
- License plate lights

Information on replacing light bulbs: ⇒ [Replacing light bulbs](#).

WARNING

Disregarding the safety-related checklist may lead to accidents and injuries.

- Please note and follow the points listed in the checklist.

Fuel



Introduction to the subject

In this chapter you will find information on the following subjects:



⇒ Gasoline additives

The correct fuel grade for your engine is shown on a sticker located on the inside of the fuel filler flap ⇒ [Fig. 195](#).

Bad or poor quality fuel reduces operating performance, efficiency and service life of the engine. If you notice any symptoms like rough engine idle or performance or bucking, immediately reduce the vehicle speed, accelerate slowly, and keep the engine speed in the middle of the rpm range. Avoid high rpm and rapid acceleration. If these symptoms should appear right after refueling, switch off the engine. In both cases contact an authorized Volkswagen dealer or an authorized Volkswagen Service Facility to have the engine checked.


WARNING

Improper refueling or handling of fuel can cause fire, explosion, and severe burns.

- Fuel is highly explosive and flammable and can cause severe burns and other injuries.
- Heed applicable safety warnings and obey local fuel handling regulations.
- Always make sure the fuel cap is screwed on all the way. This keeps fuel from spilling out and from evaporating.
- Failure to shut the engine off while refueling and/or to insert the pump nozzle fully into the vehicle's filler neck could cause fuel overflow and fuel spray. Fuel spray and overflowing fuel are dangerous because they can cause fire or serious injury.
- For safety reasons, the engine must be turned off when refueling.
- Never get back into your vehicle while refueling. If in exceptional circumstances you must get back in your vehicle while refueling, make certain that you close the door and touch metal to discharge static electricity before touching the filler nozzle again. Static electricity can cause sparks that can ignite fuel vapors released during refueling.

Gasoline



Read and follow the introductory information and safety information first ⇒  [Introduction to the subject](#)



Octane rating indicates a gasoline's ability to resist engine-damaging "knock" caused by pre-ignition. Using gasoline that does not meet minimum octane requirements can affect engine performance, while the use of poor quality gasoline or gasoline with octane levels below 87 can also cause engine damage. If Regular gasoline is recommended for your engine, you may be able to enhance engine performance by using Premium gasoline.

The recommended gasoline octane rating for your engine is listed on a label inside of the fuel filler flap. This rating may be specified according to AKI (CLC) or RON (ROZ) standards.

Regardless of whether unleaded Regular or Premium grade gasoline is specified for your vehicle, Volkswagen recommends using TOP TIER Detergent Gasoline with a minimum octane rating of 87 AKI (91 RON) for Regular gasoline, and 91 AKI (95 RON) for Premium gasoline. For more information on TOP TIER Detergent Gasoline, please go to the official website, <http://www.toptiergas.com>.

The gasoline grades most commonly sold in the United States and Canada have the following octane ratings, which can usually be found on the filler pump:

- Regular grade: 87 to 90 AKI
- Premium grade: 91 to 96 AKI

Unleaded gasoline

Unleaded gasoline is available throughout the USA and Canada. Volkswagen recommends that you do not take your vehicle to places where unleaded gasoline may not be available.

Gasoline containing alcohol or MTBE

You may use unleaded gasoline blended with alcohol or MTBE (methyl tertiary butyl ether), commonly referred to as oxygenated fuels, if the blended mixture meets the following criteria:

Blends of gasoline and methanol (wood alcohol or methyl alcohol):

- Anti-Knock Index (AKI) must be 87 or higher.
- Blend must contain no more than 3% methanol.
- Blend must contain more than 2% co-solvents.

Blends of gasoline and ethanol (grain alcohol or ethyl alcohol):



- Blend must contain no more than 15% ethanol.

Blends of gasoline and MTBE:

- Anti-Knock Index (AKI) must be 87 or higher.
- Blend must contain no more than 15% MTBE.

Seasonally adjusted gasoline

Many fuels are blended especially for winter or summer conditions. When seasons change, Volkswagen suggests that you buy fuel at busy stations where the seasonal adjustment is more likely to be made earlier.

WARNING

Starting fluids can explode and cause a run-away vehicle condition.

- Never use starting assist fluids.

NOTE

- Never use fuel with an octane rating lower than 87 AKI/91 RON. Using lower octane fuel may cause expensive engine damage.
- Never use leaded gasoline! Leaded gasoline will severely damage your vehicle's catalytic converter.
- Methanol-blended fuels that do not meet the criteria listed above may cause corrosion and may damage plastic and rubber parts in the fuel system.
- Never use fuels that contain lead or other metals (check listing on the fuel pump). Even lead replacement gasoline (LRP fuels) contain metallic additives in high concentrations. They can damage the engine.
- Do not use fuels that fail to meet the criteria above, or with contents that cannot be identified.
- If you cannot tell whether a particular fuel blend meets the criteria above, ask your service station or its fuel supplier. If you notice a loss of fuel economy or drivability and performance problems using one of these fuel blends, we recommend that you switch to unblended fuel.
- Using fuels that are different from those specified above can damage your vehicle's engine



- Damage to the engine and fuel system and performance problems caused by using fuels that are different from those specified above or by using starting assist fluids are not the responsibility of Volkswagen and are not covered under the Emission warranties or any other Volkswagen Limited Warranty.




Even a single tank full of leaded fuel can do major damage to the catalytic converter and degrade its effectiveness in reducing polluting emissions.



If you notice a loss of fuel economy or drivability and performance problems using one of these fuel blends, we recommend that you switch to unblended fuel. Never use fuel line antifreeze offered for gasoline engines.

Gasoline additives




Read and follow the introductory information and safety information first ⇒  [Introduction to the subject](#)

Additives are used to improve the quality of the gasoline.

Fuel quality impacts the operating performance, efficiency and service life of the engine. Therefore, use high quality gasoline that is already blended by the fuel supplier with suitable gasoline additives that do not contain metal. The additives provide corrosion protection, clean the fuel system, and help prevent deposits on the engine.

Volkswagen recommends TOP TIER Detergent Gasoline. For more information on TOP TIER Detergent Gasoline, please go to the official Web site <http://www.toptiergas.com>.

If quality gasoline with additives that do not contain metal is not available or engine malfunctions occur, you should add the required additives while refueling ⇒  .

Not all gasoline additives are effective. Using the wrong additives can cause significant and expensive damage to the engine and the catalytic converter. Never use additives that contain metal. Please note that metal can be included in some aftermarket gasoline additives that are available to be added to gasoline during or after refueling to help improve knock resistance or increase the octane rating.



as instructions on how to use them are available from your authorized Volkswagen dealer or authorized Volkswagen Service Facility. Do not add any other gasoline additives.

NOTE

You can damage the engine by using incorrect additives.

- Using incorrect gasoline additives can cause extensive engine damage as well as damage to the catalytic converter.
- If you must fuel your vehicle with gasoline whose octane rating is too low, only drive with the engine speed in the middle of the rpm range and with low engine load. Avoid high rpm and heavy engine load. Otherwise, the engine could be damaged. Refuel your vehicle with gasoline with the required octane rating as soon as possible.
- Do not use fuel that is labeled at the pump as containing metal. Lead replacement fuel contains high concentrations of metallic additives. Expensive engine and catalytic converter damage could result.
- Fueling your vehicle just one time with leaded fuel or fuel that contains other metallic additives can affect the performance of the catalytic converter and cause extensive damage to it.



Owner's manual
Owner's Manual
Edition: 12.2016
ID: 5GM012723AL

Care, cleaning, maintenance

In the engine compartment

Working in the engine compartment



Introduction to the subject

In this chapter you will find information on the following subjects:


⇒ *Display*

⇒ *Preparing to work in the engine compartment*

⇒ *Opening or closing the engine compartment*

Always position the vehicle on a firm and level surface before doing any work in the engine compartment.

The engine compartment of a vehicle is a hazardous area. Never do any work on the engine or in the engine compartment unless you

- know exactly how to carry out the job,
- have the correct technical information and the proper tools and supplies, and
- are familiar with the necessary safety precautions ⇒  .

If you are uncertain in any way, have the work done by an authorized Volkswagen dealer or an authorized Volkswagen Service Facility. Serious personal injury may result from improperly performed work.

 **WARNING**



- Never work under the vehicle unless you have safely secured the vehicle from moving. If you must work under the vehicle with the wheels on the ground, always make sure that the vehicle is on level ground, that all 4 wheels are chocked to keep them from moving, and that the key is not in the ignition.
- If you must work under a vehicle raised on a floor jack, always make sure that the vehicle is safely supported on safety stands intended for that purpose that are strong enough to support the weight of the vehicle. The jack supplied with the vehicle is not strong enough for this purpose and can collapse causing serious personal injury.

WARNING

The engine compartment of any motor vehicle is a potentially dangerous area and can cause serious personal injury.

- Always use extreme caution when doing any work in the engine compartment. Always follow commonly accepted safety practices and use common sense. Never risk personal injury.
- Never perform any work in the engine compartment unless you know exactly how to carry out the job and have the correct technical information and the correct tools.
- If you are uncertain about what to do, have the work performed by an authorized Volkswagen dealer, an authorized Volkswagen Service Facility, or another qualified workshop. Serious personal injury may result from improperly performed work.
- We strongly recommend that you always have HID – High Intensity Discharge (Xenon) headlights and H7 bulbs replaced by a qualified technician. Serious personal injury may result from improperly performed work.
- Never open or close the engine hood if steam or coolant is escaping. Hot steam or coolant can cause serious burns. Always wait until you no longer see or hear steam or coolant escaping from the engine.
- Always let the engine cool down completely before carefully opening the hood.
- Hot parts of the engine and the exhaust system will burn skin on contact.
- When the engine has cooled down and you are ready to open the hood:
 - Firmly apply the parking brake and shift the transmission into Park (P) (automatic) or Neutral (manual only).



- On vehicles with Keyless Access, make sure that the remote control vehicle key is out of range of the vehicle and that the vehicle cannot be started by depressing the starter button ⇒ *Unlocking or locking the vehicle with Keyless Access*.
- Always keep children and others away from the engine compartment and never leave them unsupervised.
- The engine coolant system is under pressure when the engine is hot. Never unscrew the coolant expansion tank cap when the engine is hot. Hot coolant can spray out and cause severe burns and other serious injuries.
 - Turn the cap slowly and very carefully in a counterclockwise direction while applying light downward pressure on the top of the cap.
 - Always protect your face, hands, and arms from hot escaping coolant or steam by covering the cap with a large, thick rag.
- Never spill fluids on the engine or exhaust system when refilling. Spilling fluids onto hot parts of the engine or exhaust system can cause a fire.

WARNING

High voltage systems in the engine compartment can cause electrical shocks or even electrocution, severe burns, other serious injuries, and even death!

- Never short-circuit the electrical system. Be especially careful when using jumper cables. The vehicle's battery could explode!
- To reduce the risk of electrical shock and personal injury while the engine is running or being started:
 - Never touch ignition cables. Never touch other components of the high voltage electronic ignition system.
 - Never touch the wiring of the HID – High Intensity Discharge (Xenon) headlights.
- Read and heed the important information and warnings on cleaning the engine compartment ⇒ *Cleaning the engine compartment*.



Moving parts in the engine compartment can cause serious personal injury on contact.

- Never reach into the area around or touch the radiator fan. Contact with the blades can cause serious personal injury. Always remember that the radiator fan is temperature-controlled and can come on suddenly even when the engine has been switched off for a while and the key has been removed from the ignition.
- If you have to perform a check or repair when the engine is running, there are more risks from the rotating parts, such as the drive belts, alternator, radiator fan, etc., and from the high-voltage ignition system. Always use extreme care.
 - Always make sure that jewelry, loose clothing and long hair do not get caught in rotating engine parts. Before starting any work remove your jewelry, take off your necktie, tie back and cover your hair, and do not wear clothing that can hang down and get caught in moving engine parts.
 - Always use extreme caution if the accelerator pedal has to be depressed to perform a check. The vehicle will start to move even if the parking brake is on.
- Never leave any objects in the engine compartment, for example cleaning rags and tools. Objects left behind can cause malfunctions, engine damage, and even fires.

WARNING

Additional materials in the engine compartment such as blankets can interfere with the operation of the engine and can cause fires, which can lead to serious injuries.

- Never cover the engine with blankets or other materials.

WARNING

Operating fluids and some materials in the engine compartment can catch fire easily, causing burns and other serious personal injuries!

- Never smoke near the engine compartment.
- Never work next to open flames or sparks.



ignite or hot engine parts and cause injuries.

- If work on the fuel system or the electrical system is necessary:
 - Always disconnect the 12 Volt vehicle battery. Make sure the vehicle is unlocked when you disconnect the battery, or the alarm will go off. Never touch the electrical wiring of the ignition system.
 - Never work near heaters, water heaters, or other open flames.
- Always have a functional, approved fire extinguisher nearby.

NOTE


When changing or topping off fluids, make sure that you pour the fluids into the correct reservoirs. Adding the wrong type of operating fluids will cause serious malfunctions and engine damage.



Fluid leaks and spills are harmful to the environment. Regularly check the ground underneath your vehicle for this reason. If you find spots of oil or other fluids, have your vehicle checked by your authorized Volkswagen dealer or authorized Volkswagen Service Facility. Dispose of leaked operating fluids properly.

Display



Read and follow the introductory information and safety information first ⇒  [Introduction to the subject](#)

Lights up

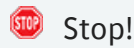
Proper response



Engine hood not properly closed.

Icon appears in the display

⇒ *Displays*



Stop!

Close the engine hood.

When the ignition is switched on, several warning and indicator lights come on briefly for a function check. They go out after a few seconds.

If the engine hood is open or not closed properly, the vehicle icon appears in the instrument cluster display showing the open engine hood ⇒ *Fig. 12*.

Depending on your vehicle's equipment and options, the icon may still be displayed even after the ignition is switched off as long as the key has not been taken out of the ignition. The instrument cluster display goes out a short period of time after the vehicle has been locked.


WARNING

Failure to heed warning lights and instrument cluster text messages can cause the vehicle to break down in traffic and result in a collision and serious personal injury.

- Never ignore warning lights or text WARNINGS.
- Always stop the vehicle as soon as it is safe to do so.

Preparing to work in the engine compartment



Read and follow the introductory information and safety information first ⇒  *Introduction to the subject*

Checklist

they are listed → .

- ✓ Park the vehicle in a safe place on a firm, level surface.
- ✓ Hold the brake pedal down until the engine is switched off.
- ✓ Set the parking brake to help prevent the vehicle from moving Parking brake (Golf, Golf GTI) or Electronic parking brake (Golf R) (depending on equipment).
- ✓ Shift the transmission into Park (P) (automatic) or Neutral (manual only) Shifting.
- ✓ Stop the engine and remove the key from the ignition switch or turn off the ignition with the starter button and remove the key from the vehicle Starting and stopping the engine.
- ✓ Let the engine cool down sufficiently.
- ✓ Keep children and others away from the vehicle.
- ✓ Make sure the vehicle cannot move unexpectedly.

WARNING

Disregarding the safety-related checklist may result in serious injuries.

- Always review and follow the checklist. Follow accepted safety practices and use common sense.

Opening or closing the engine compartment

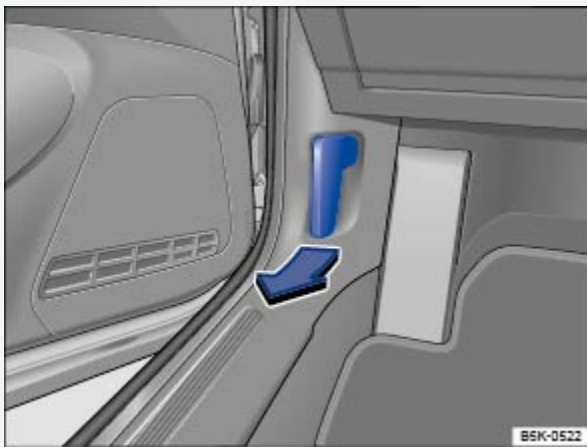



Fig. 196 In the footwell on the driver side: Inside engine hood release lever.





Fig. 197 Above the radiator grille: Outside engine hood release.




Read and follow the introductory information and safety information first ⇒  [Introduction to the subject](#)

Opening the engine hood

- Before you open the hood, make sure that the windshield wiper arms are resting on the windshield ⇒  .
- Open the driver door and pull the inside hood release lever in the direction of the arrow ⇒ [Fig. 196](#) . The engine hood is released from its latch by a spring ⇒  .
- Push the outside hood release lever ⇒ [Fig. 197](#) (arrow) and lift the hood all the way up. A gas-filled strut will hold the hood up.

Closing the engine hood

- Pull the hood down to overcome the resistance of the gas-pressure strut ⇒  .
- Lower the engine hood by hand until it is about 8 in. (20 cm) above its latch and then let it drop into place to latch it. *Do not* push down on it afterwards!

If the hood does not close completely, open it again and close it properly.

When the hood is properly closed, you can see that it fits flush with the other body parts. The display in the instrument cluster no longer indicates that the engine hood is open ⇒ [Display](#) .

WARNING

If the hood is not closed properly, it could fly up and block your view while you are driving. This can lead to a crash and serious personal injuries.



hood latch. The engine hood must be flush with the surrounding auto body parts.

- If you ever notice that the hood latch is not properly secured when the vehicle is moving, stop at once and close it.
- Never let anyone get in the way of the hood when closing it.

NOTE

- Make sure the windshield wipers are switched off and the windshield wiper arms are resting on the windshield before you open the hood. Otherwise, the windshield wipers and the hood may be damaged.
- Always put the windshield wiper arms down against the windshield before driving the vehicle.

NOTE

Before opening or closing the engine hood, make sure there is enough room to do so, for example when the vehicle is in a garage.

Engine oil



Introduction to the subject

In this chapter you will find information on the following subjects:

⇒ *Warning and indicator lights*

⇒ *Engine oil specifications*

⇒ *Engine oil capacities*

⇒ *Checking the engine oil level and adding oil*

⇒ *Engine oil consumption*

⇒ *Changing engine oil*

Improper handling of engine oil can cause severe burns and other serious injuries.

- Always wear eye protection.
- Engine oil is poisonous and must be stored out of the reach of children.
- Store engine oil only in the closed original container. This also applies to used oil until disposal.
- To reduce the risk of poisoning, never drain the oil into empty food or beverage containers that might mislead someone into drinking from them.
- Continuous contact with used engine oil is harmful to your skin. Always protect your skin by washing thoroughly with soap and water.
- Engine oil becomes extremely hot when the engine is running and can cause severe burns. Always let the engine cool down to the touch.



Like all other operating fluids, engine oil can pollute the environment. Collect leaked or spilled operating fluids and dispose of them properly in accordance with applicable environmental laws and regulations.

Warning and indicator lights




Read and follow the introductory information and safety information first ⇒ [Introduction to the subject](#)

Lights
up^{a)}

Possible cause

Proper response



 Stop!


Switch off the engine. Check the engine oil level

⇒ *Checking the engine oil level and adding oil* .



Engine oil level too low.


If the engine oil level is too high, contact an authorized Volkswagen dealer or an authorized

Volkswagen Service Facility for assistance ⇒  .

Flashes^{a)} Possible cause

Proper response



 Stop!

Switch off the engine. Check the engine oil level

⇒ [Checking the engine oil level and adding oil](#).



Engine oil pressure too low.

– If the warning light flashes although the oil level is normal, *do not* continue driving or let the engine idle. Otherwise, the engine could be damaged.

Contact an authorized Volkswagen dealer or an authorized Volkswagen Service Facility.



Engine oil system malfunction.

Have the engine oil sensor checked by an authorized Volkswagen dealer or an authorized Volkswagen Service Facility.

When the ignition is switched on, several warning and indicator lights come on briefly for a function check. They go out after a few seconds.

Depending on equipment, the engine oil temperature may be displayed in the Volkswagen Information System Driving data menu ⇒ [Volkswagen Information System](#).

 **WARNING**



break down in traffic and result in a collision and serious personal injury.

- Never ignore warning lights or text WARNINGS.
- Always stop the vehicle as soon as it is safe to do so.

NOTE

Failure to heed warning lights or text WARNINGS can result in vehicle damage.


NOTE

Do not start the engine if the engine oil level is in range ⇒ *Fig. 198*^{a)}. Contact an authorized Volkswagen dealer or an authorized Volkswagen Service Facility. Otherwise the catalytic converter and engine can be damaged!

a) Displayed in color on an instrument cluster with color display.

Engine oil specifications



Read and follow the introductory information and safety information first ⇒  *Introduction to the subject*

The engine oil used must conform to exact specifications.

Using the proper engine oil is important for the functionality and service life of the engine. Your engine was factory-filled with a high-quality multi-grade oil which can usually be used throughout the entire year.

Engine oils are constantly being improved. Authorized Volkswagen dealers and authorized Volkswagen Service Facilities are always up-to-date regarding new developments and changes. Volkswagen therefore recommends that you have the engine oil changed by an authorized Volkswagen dealer or an authorized Volkswagen Service Facility.

Engine oil quality is based not only on requirements for engines and exhaust treatment systems, but also on fuel quality. Engine oil comes into contact with fuel and fuel residue in all internal combustion engines, causing engine oil to age and its lubricating qualities to deteriorate.



Volkswagen oil quality standards and has a viscosity grade of SAE 5W-40. or SAE 5W-30. You can use this oil for normal driving in all temperatures.

If you need to add oil between oil changes, use only a high quality oil that expressly complies with the Volkswagen oil quality standard specified for your vehicle's engine:

Engines	Engine oil specification
---------	--------------------------

	VW 502 00
--	-----------

Gasoline engines	VW 503 00
------------------	-----------

	VW 504 00
--	-----------

At the time this Manual was printed, the engine oils available in the U.S. that meet these Volkswagen standards are synthetic oils. This does not mean, however, that any synthetic engine oil will meet Volkswagen standards. Always use an approved oil that expressly complies with the Volkswagen oil quality standard that applies to your vehicle's engine.

General recommendations:

If synthetic oil that meets the applicable Volkswagen oil quality standard with viscosity grade SAE 5W-40 or SAE 5W-30 is not available in your area, be sure to use a viscosity grade suitable for the climate, season, and operating conditions that exist where the vehicle is used. Make sure the oil meets the quality standard listed in .

Engine oils are constantly being improved. Authorized Volkswagen dealers and authorized Volkswagen Service Facilities are always up-to-date regarding new developments and changes. Volkswagen therefore recommends that you have the engine oil changed by an authorized Volkswagen dealer or an authorized Volkswagen Service Facility.

 **NOTE**



and your engine requires, you may add a total of no more than 1/2 quart (0.5 liter) of a high-quality synthetic oil that meets ACEA A3 specifications and has a viscosity grade of SAE 5W-40 or SAE 5W-30.

- Use only a high quality engine oil that expressly complies with the Volkswagen oil quality standard specified for your vehicle's engine. Using any other oil can cause serious engine damage that will not be covered by any Volkswagen Limited Warranty.
- Do not mix any lubricants or other additives into the engine oil. Doing so can cause engine damage! Damage caused by these kinds of additives are not covered by any Volkswagen Limited Warranty.

Engine oil capacities



Read and follow the introductory information and safety information first ⇒ [Introduction to the subject](#)

Engines	Engine oil capacity (with filter)
170 hp (125 kW), 1.8 L gasoline engines (Golf)	About 5.8 quarts (5.5 liters)
210 hp (155 kW) 2.0 L gasoline engines (Golf GTI)	About 6.0 quarts (5.7 liters)
220 hp (162 kW) 2.0 L gasoline engines (Golf GTI)	About 6.0 quarts (5.7 liters)
292 hp (215 kW) 2.0 L gasoline engines (Golf R)	About 6.0 quarts (5.7 liters)

Checking the engine oil level and adding oil

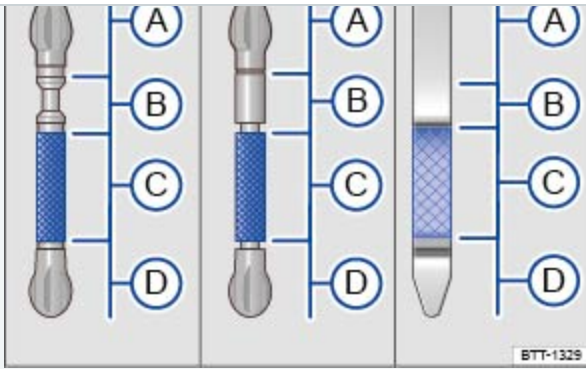


Fig. 198 Engine oil dipstick with oil level marks.



Fig. 199 In the engine compartment: Engine oil filler cap (cap design may vary depending on vehicle equipment).



Read and follow the introductory information and safety information first ⇒ *Introduction to the subject*

Checklist

Perform the steps in the order listed ⇒ :

- ✓ With the engine at operating temperature, park the vehicle on a level surface to help prevent an incorrect oil level reading.
- ✓ Switch off the engine and wait a few minutes for the engine oil to flow back into the oil pan.
- ✓ Open the engine hood Working in the engine compartment.
- ✓ Find the oil filler opening and the dipstick. You can identify these by the symbol on the engine oil filler cap and the colored handle on the dipstick. If you are not sure where the cap and the dipstick are located, see your authorized Volkswagen dealer or authorized Volkswagen Service Facility for assistance.



✓ Reinsert the dipstick into the guide tube and push it all the way in. If there is an alignment tab on the top of the engine oil dipstick, make sure it lines up with the notch in the guide tube, and that the dipstick goes all the way in.

Remove the dipstick again and read the oil level on the dipstick as described below: Ⓐ: Do not start the engine . Contact an authorized Volkswagen dealer or an authorized Volkswagen Service Facility for assistance. Ⓑ: Do not add any oil . Continue with step 15. Ⓒ: Oil may be added, depending on the oil level. Continue with step 8 or step 15. Ⓓ: You must add oil (about 1 quart / 1.0 liter). Continue with step 8.

✓ After reading the oil level, reinsert the dipstick back into the guide tube and push it all the way in.

✓ Remove the cap on the engine oil filler opening .

✓ Only add engine oil that Volkswagen has approved for that engine. Add the oil gradually in small quantities (no more than 1 pint / 0.5 liter).

✓ To help prevent overfilling, you must wait about 1 minute each time you add oil so that the oil can flow into the oil pan up to the marking on the dipstick.

✓ Read the oil level on the dipstick again before adding another small amount, if necessary. Never add too much oil .

✓ After adding oil, the level must at least be in the center of the Ⓒ range and can enter range Ⓑ, but should never enter range Ⓐ .

✓ After adding oil, securely install the cap on the engine oil filler opening. Otherwise, oil could leak out while the engine is running.


✓ Insert the oil dipstick back in the guide tube and push it all the way in.

✓ Close the hood .

Engine oil level ranges

⇒ Fig. 198	Required action according to the respective engine oil level:
Range Ⓐ	Do not start the engine ⇒ ⚠ . Contact an authorized Volkswagen dealer or an authorized Volkswagen Service Facility for assistance.




Range Ⓑ	Do not refill oil ⇒  .
Range Ⓒ	You may add oil, as long as the oil level does not go above the Ⓑ range.
Range Ⓓ	You must add oil (about 1 quart / 1.0 liter). After adding oil, make sure that the oil level is about in the middle of the Ⓒ range.

WARNING


Engine oil can ignite when it touches hot engine parts. This can cause fires, burns, and other severe injuries.

- Never spill oil on the engine. Oil spilled on a cold engine can also cause a fire when the engine warms up.
- Always make certain that you screw the cap of the engine oil filler opening back on tightly after adding oil and that the dipstick has been pushed all the way back into the in the guide tube. This helps prevent engine oil from leaking onto the hot engine when the engine is running.

NOTE

- Do not start the engine if the engine oil level is in range ⇒ *Fig. 198*  . Contact an authorized Volkswagen dealer or an authorized Volkswagen Service Facility. Otherwise the catalytic converter and engine can be damaged!
- When changing or topping off fluids, make sure that you pour the fluids into the correct reservoirs. Adding the wrong type of operating fluids will cause serious malfunctions and engine damage.



The engine oil level should never be in range ⇒ *Fig. 198*  . Otherwise oil can be drawn in by the crankcase ventilation system and enter the atmosphere via the exhaust system.

Engine oil consumption



subject

To provide effective lubrication and cooling for internal engine parts, all internal combustion engines use some oil. Oil consumption varies from engine to engine and may change over the life of the engine. Engines tend to use more oil during the break-in period than they do afterward, when oil consumption has stabilized.

Under normal conditions, the rate of oil consumption depends on oil quality as well as viscosity, engine speed (rpm), outside temperature, road conditions, the amount of oil dilution caused by condensed water or fuel residue, and oxidation of the oil. Oil consumption may increase with engine wear over time, until replacement of worn engine parts may become necessary.

Volkswagen recommends that you to check the engine oil level at regular intervals, preferably every time you fill the fuel tank, and always before a long trip. Your vehicle may consume engine oil depending on several variables. A maximum of 1 quart per 1200 miles (1 liter per 2000 km) would be considered normal. New vehicles may consume more oil over the first 3000 miles (5000 km).

The oil pressure warning light is not an indicator of low engine oil level. If the warning light stays on or flashes while driving (above 1500 rpm), a chime will sound. It indicates that the oil pressure is too low. Stop the engine immediately, check the engine oil level and add oil if necessary. If the engine oil level is normal, but the light continues to flash, do not keep driving or let the engine idle, as damage may occur.

If you believe your engine uses too much oil, we recommend that you consult your authorized Volkswagen dealer or authorized Volkswagen Service Facility so that the cause of your concern can be properly diagnosed. Please keep in mind that accurate measurement of oil consumption requires great care and may take some time. Your authorized Volkswagen dealer and authorized Volkswagen Service Facility have instructions for how to measure oil consumption accurately.



Depending on the way the vehicle is driven and the operating conditions, oil consumption can be up to 1 quart per 1200 miles (1 liter per 2000 km). Consumption may be higher for new vehicles during the first 3000 miles (5000 km).

Changing engine oil



subject

The engine oil must be changed according to the intervals specified in your ⇒Booklet *Warranty and Maintenance*,

Changing oil at regular intervals is very important because the lubricating properties of oil decrease gradually during normal vehicle use. If you are not sure when to have the oil changed, ask your authorized Volkswagen dealer or authorized Volkswagen Service Facility.

Sometimes, engine oil should be changed more often than specified for normal use. Change oil more frequently if you often drive short distances, in dusty areas or in stop-and-go traffic, or if you use your vehicle where temperatures stay below freezing for long periods.

Volkswagen recommends that you have your oil and oil filter changed by an authorized Volkswagen dealer or an authorized Volkswagen Service Facility ⇒ ⚠ . They have the required expertise and special tools and will dispose of the old oil properly.





Detergent additives in the oil will make fresh oil look dark after the engine has been running a short time. This is normal and no reason to change engine oil more often.

WARNING

If you must change the engine oil yourself, be sure to take the following precautions:

- Always wear eye protection.
- To reduce the risk of burns from hot engine oil, let the engine cool down completely before beginning.
- When removing the oil drain plug with your fingers, stay as far away as possible. Always keep your forearm parallel to the ground to help prevent hot oil from running down your arm.
- Drain the oil into a container designed for this purpose, one large enough to hold at least the total amount of oil in your engine.
- To reduce the risk of poisoning, never drain the oil into empty food or beverage containers that might mislead someone into drinking from them.
- Engine oil is poisonous and must be stored out of the reach of children.
- Continuous contact with used engine oil is harmful to your skin. Always protect your skin by



-  Before changing the oil, first make sure you know where you can properly dispose of the old oil.
-  Dispose of the old oil in an environmentally-responsible manner. Never dump the old oil on garden soil, in wooded areas, in the street, into streams, rivers, or bodies of water, or down sewage drains.
-  Recycle used oil by taking it to a collection facility for used engine oil in your area, or contact an authorized Volkswagen dealer or an authorized Volkswagen Service Facility.
-  Volkswagen recommends that you always have your oil and oil filter changed by an authorized Volkswagen dealer or an authorized Volkswagen Service Facility. They have the required expertise and special tools and will dispose of the old oil properly.

Engine coolant

Introduction to the subject


In this chapter you will find information on the following subjects:

⇒ *Warning light and engine coolant temperature gauge*

⇒ *Engine coolant specifications*

⇒ *Checking engine coolant level and topping off*

Never do any work on the coolant system unless you

- know exactly how to carry out the job,
- have the correct technical information and the proper tools, supplies, and operating fluids, and
- are familiar with the necessary safety precautions ⇒  !

If you are uncertain in any way, have the work done by an authorized Volkswagen dealer or an authorized Volkswagen Service Facility.

Serious personal injury may result from improperly performed work.

Engine coolant is poisonous!

- Always keep the coolant in its original container stored in a safe place.
- To reduce the risk of poisoning, never store engine coolant in empty food or beverage containers or in any other containers that might mislead someone into drinking from them.
- Always keep engine coolant out of reach of children.
- Always make sure there is enough of the correct coolant additive to provide proper antifreeze protection at the coldest temperatures that can be expected where the vehicle will be used.
- At extremely cold temperatures, the coolant could freeze, causing the vehicle to break down. The heater would also not work, and vehicle occupants could be without protection at sub-freezing temperatures.




Coolant and coolant additives can pollute the environment. Collect leaking operating fluids and dispose of them properly in accordance with applicable environmental laws and regulations.

Warning light and engine coolant temperature gauge



Fig. 200 Engine coolant temperature gauge in the instrument cluster: Ⓐ Engine cold; Ⓑ Normal temperature range; Ⓒ Warning zone.




Read and follow the introductory information and safety information first ⇒  *Introduction to the subject*

If the indicator in the engine coolant temperature gauge is located in the cold range Ⓐ, the engine has not reached operating temperature. High engine speeds and heavy engine loads should be avoided.

Under normal driving conditions, the needle should be in the middle of the gauge. The temperature



When the ignition is switched on, several warning and indicator lights come on briefly for a function check. They go out after a few seconds.

The following table explains what to do if the engine coolant temperature warning light  does not go out a few seconds after the engine is started or starts flashing while driving.

Flashes ^{a)}	Temperature gauge needle	Possible cause	Proper response
	⇒ Fig. 200		



Flashes^{d)}

gauge needle

Possible cause

Proper response

⇒ Fig. 200

 Stop!

Pull off the road and stop as soon as you can do so safely. Stop the engine and let it cool down until the temperature needle is in the normal range again. Check the engine coolant level and add engine coolant if needed

⇒ *Checking engine coolant level and topping*

©

Engine coolant temperature *off*.

too high.

Warning zone


If the engine coolant level is correct or the problem continues after adding coolant and driving a short distance, do not drive any farther. Contact the nearest authorized Volkswagen dealer or authorized Volkswagen Service Facility.





Flashes ^{d)}	gauge needle	Possible cause	Proper response
	⇒ Fig. 200		
			<p>If the coolant level is correct, the overheating may be caused by a radiator fan fault. Check the fuses and replace as necessary ⇒ Fuses.</p>
			<p>Check the engine coolant level after the engine has cooled down and add engine coolant if low ⇒ Engine coolant.</p>
	ⓑ	Engine coolant level too low.	
Normal range			<p>If the engine coolant level is correct or the problem continues after adding coolant, do not drive any farther. Contact an authorized Volkswagen dealer or authorized Volkswagen Service Facility.</p>
			<p>These instructions apply only when the coolant temperature stays in the normal range. Stop immediately if the needle goes into the red warning zone ⇒ Fig. 200ⓐ.</p>



Flashes ^{d)}	gauge needle	Possible cause	Proper response
	⇒ Fig. 200		
	-	Engine coolant system mal-	 Stop!
		function.	<p>Pull off the road and stop as soon as you can do so safely. Get assistance from an authorized Volkswagen dealer, an authorized Volkswagen Service Facility, or another qualified workshop.</p>
	Ⓐ	The engine has not yet	Do not drive at high engine speeds or with
	-	warmed up.	heavy engine loads until the engine warms
	Cold range		up.

When the ignition is switched on, several warning and indicator lights come on briefly for a function check. They go out after a few seconds.

 **WARNING**

Failure to heed warning lights and instrument cluster text messages can cause the vehicle to break down in traffic and result in a collision and serious personal injury.

- Never ignore warning lights or text WARNINGS.
- Always stop the vehicle as soon as it is safe to do so.

 **NOTE**



a) Displayed in color on an instrument cluster with color display.

Engine coolant specifications



Read and follow the introductory information and safety information first ⇒ [Introduction to the subject](#)

The engine cooling system is filled at the factory with a mixture of specially conditioned water and at least 40 percent of Volkswagen engine coolant additive G 13 (TL-VW 774 J). This engine coolant additive is pink.

This mixture provides antifreeze protection down to -13 °F (-25 °C). It also helps to protect the light alloy parts in the engine cooling system against corrosion. In addition, the mixture helps prevent calcium deposits and increases the boiling point of the engine coolant.

To protect the engine, the mixture must *always* contain *at least 40% coolant additive* even in warm weather or climates where antifreeze protection is not needed.

If more antifreeze protection is needed for climate conditions, the percentage of coolant additive can be increased. However, the coolant additive percentage must never be more than 60%; otherwise, antifreeze protection is reduced and the ability of the mixture to cool the engine is also reduced.

When adding engine coolant, use a mixture of distilled water and at least 40% coolant additive - G 13 - or - G 12 plus-plus - (TL-VW 774 G) for optimum corrosion protection ⇒ .

Do not mix - G 13 - with - G 12 plus - or - G 11 -. Mixing these coolant additives together significantly reduces corrosion protection ⇒ and can lead to engine damage that is not covered by any Volkswagen Limited Warranty.

WARNING

Too little antifreeze protection in the engine cooling system can cause engine failure and severe injuries.

- Always make sure there is enough of the correct coolant additive to provide proper antifreeze protection at the coldest temperatures that can be expected where the vehicle will be used.

The heater would also not work, and vehicle occupants could be without protection at sub-freezing temperatures.

NOTE

Never mix original Volkswagen engine coolant additives with other additives not approved by Volkswagen. Mixing Volkswagen coolant additives with coolant additives made by other manufacturers can seriously damage the engine and the engine cooling system.

- If the fluid in the engine coolant reservoir is any color but pink, then - G 13 - was mixed with a different engine coolant. If this is the case, the engine coolant must be replaced immediately. Otherwise serious malfunctions or engine damage can occur!

Engine coolant and engine coolant additives can pollute the environment. Collect leaking operating fluids and dispose of them properly in accordance with applicable environmental laws and regulations.

Checking engine coolant level and topping off



Fig. 201 Coolant expansion tank in the engine compartment.



Fig. 202 Coolant expansion tank cap in the engine compartment.



Read and follow the introductory information and safety information first ⇒ [▲ Introduction to the subject](#)

If the coolant level drops too low, the engine coolant level/temperature warning light comes on.

Preparations

- Park the vehicle on level ground.
- Always let the engine cool down ⇒ [▲](#) .
- Open the engine hood [▲](#) ⇒ [Working in the engine compartment](#) .
- There is a [▲](#) symbol on the cap of the engine coolant expansion tank ⇒ [Fig. 202](#) .

Checking engine coolant level

- When the engine is cold, check the engine coolant level relative to the marking on the side of the expansion tank ⇒ [Fig. 201](#) .
- If the coolant level in the tank is below the minimum mark (min), add coolant. When the engine is warm, the engine coolant level may be slightly above the upper edge of the marked range.

Adding engine coolant

- Always protect face, hands, and arms from hot escaping coolant or steam by covering the cap with a large, thick rag.
- Carefully unscrew the cap ⇒ [▲](#) .
- Add only new engine coolant according to Volkswagen specifications (⇒ [Engine coolant specifications](#)) ⇒ [!](#) .



pansion tank, the engine could be damaged. If you cannot see any coolant in the expansion tank, do not drive the vehicle . Seek professional assistance.

- If you can see coolant in the expansion tank, refill coolant until the level remains stable.
- The engine coolant level must be inside the marks on the side of the expansion tank ⇒ [Fig. 201](#) . Do not fill above the top edge of the filling range! ⇒
- Screw the lid tightly.
- Even in an emergency, do not use any other kind of coolant additive if engine coolant that meets Volkswagen specifications (⇒ [Engine coolant specifications](#)) is not available! Instead, add distilled water only ⇒ . As soon as possible, have the correct coolant ratio restored using engine coolant that meets Volkswagen specifications ⇒ [Engine coolant specifications](#) .

WARNING

Hot steam and hot engine coolant can cause serious burns.

- Never open the hood if you see steam or coolant escaping from the engine compartment. Always wait until you no longer see or hear steam or coolant escaping from the engine.
- Always let the engine cool down completely before carefully opening the hood. Hot components will burn skin on contact.
- When the engine has cooled down and you are ready to open the hood:
 - Firmly apply the parking brake and shift the transmission into Park (P) (automatic) or Neutral (manual only).
 - Take the vehicle key out of the ignition.
 - On vehicles with Keyless Access, make sure that the remote control vehicle key is out of range of the vehicle and that the vehicle cannot be started by depressing the starter button ⇒ [Starter button](#) .
 - Always keep children and others away from the engine compartment and never leave them unsupervised.
- The engine coolant system is under pressure when the engine is hot. Never unscrew the coolant expansion tank cap when the engine is hot. Hot coolant can spray out and cause severe burns and other serious injuries.



light downward pressure on the top of the cap.

- Always protect your face, hands, and arms from hot escaping coolant or steam by covering the cap with a large, thick rag.
- Never spill fluids on the engine or exhaust system when refilling. Spilling fluids onto hot parts of the engine or exhaust system can cause a fire. Under some conditions, the ethylene glycol in engine coolant can catch fire.

NOTE

- Use distilled water only when adding coolant! All other types of water contain chemical compounds that can cause extensive corrosion damage to the engine. This can even lead to engine failure. If you have added non-distilled water, take the vehicle immediately to an authorized Volkswagen dealer or an authorized Volkswagen Service Facility to have the coolant system drained, flushed, and refilled completely with the proper coolant.
- Refill engine coolant only up to the top edge of the marked fill range ⇒ [Fig. 201](#). Excess engine coolant may be forced out of the engine cooling system when it gets hot and cause damage.
- In the case of significant engine coolant loss, refill engine coolant only when the engine is *completely cooled down*. Significant engine coolant loss is a sign of leaks in the cooling system. Have the engine cooling system checked immediately by an authorized Volkswagen dealer or an authorized Volkswagen Service Facility. Otherwise the engine may be damaged!
- Do not refill engine coolant if there is no coolant in the expansion tank. Air could enter the cooling system. Do not drive the vehicle! Seek expert assistance. Failure to do so can result in engine damage.
- When changing or topping off operating fluids, make sure that you pour the fluids into the correct reservoirs. Serious malfunctions and engine damage can result if you pour operating fluids into the wrong reservoir.

Vehicle battery



Introduction to the subject

In this chapter you will find information on the following subjects:



⇒ *Checking the vehicle battery electrolyte level*

⇒ *Charging, replacing, disconnecting, and connecting the vehicle battery*

The standard 12 Volt vehicle battery is part of the vehicle electrical system.

Never do any work on the vehicle electrical system unless you

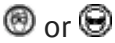







- know exactly how to carry out the job,
- have the correct technical information and the proper tools, and
- are familiar with the necessary safety precautions ⇒ ⚠ !

If you are uncertain in any way, have the work done by an authorized Volkswagen dealer or authorized Volkswagen Service Facility. Serious personal injury may result from improperly performed work.





Location of the vehicle battery

The 12 Volt vehicle battery is located in the engine compartment.

Explanation of the warnings on the vehicle battery

Symbol	Meaning
 or 	Always wear eye protection!
 or 	Battery acid is highly corrosive. Always wear protective gloves and eye protection!
 or 	Fire, sparks, open flame, and smoking are prohibited!
 or 	When a battery is charged, it produces hydrogen gas which is highly explosive!



 or 	Always keep children away from battery acid and vehicle batteries!
 or 	Always read and follow the information and WARNINGS in this Owner's Manual!

WARNING

Working on the batteries or the electrical system in your vehicle can cause serious acid burns, fires, explosions, or electrical shocks. Always read and heed the following WARNINGS and safety precautions before working on the batteries or the electrical system.

- Before working on the electrical system, always switch off the ignition and all electrical consumers and disconnect the negative (-) cable from the standard 12 Volt battery.
- When you change a light bulb, always switch off the light first.
- Always keep children away from battery acid and vehicle batteries in general.
- Always wear eye protection. Never let battery acid or lead particles come into contact with your eyes, skin, or clothing.
- Sulfuric battery acid is very corrosive. It can burn unprotected skin and cause blindness. Always wear protective gloves and eye protection. To reduce your risk of injury, never tilt the batteries, as this could spill acid through the vents and burn you.
- If you get battery acid in your eyes or on your skin, immediately rinse with cold water for several minutes and then get immediate medical attention. If you swallow any battery acid, get medical attention immediately.
- When disconnecting the batteries from the vehicle electrical system, always disconnect the negative cable (-) first and then the positive cable (+).
- Always switch off all electrical consumers before reconnecting 12 Volt batteries. Reconnect the plus cable (+) first and then the negative cable (-). Never reverse the polarity of the connections. This could cause a fire.
- A highly explosive mixture of gases is given off when the battery is being charged.
- Do not smoke and avoid fires, sparks, and open flames when working. Never create sparks or



battery terminals. High-energy sparks can cause serious personal injury.

- Never use or attempt to charge a damaged or frozen battery, or a battery that was frozen but has thawed. Charging a frozen or thawed battery could cause explosions and chemical burns! Replace damaged or frozen vehicle batteries immediately. A dead battery can freeze at temperatures around +32 °F (0 °C).
- If the battery has a vent line or tube, make sure that it is properly connected to the battery.

WARNING

California Proposition 65 Warning

- Battery posts, terminals, and related accessories contain lead and lead components, chemicals known to the State of California to cause cancer and reproductive harm. Wash your hands after handling.

NOTE


- Do not expose the vehicle battery to direct sunlight for an extended period of time as ultraviolet rays may damage the battery housing.
- If the vehicle is left standing in the cold for a long time, protect the vehicle battery from freezing. A battery will be permanently damaged by freezing.



Emergency starting and starting the engine with a very weak vehicle battery or after the vehicle battery has been replaced may change or delete system settings (including time, date, personal convenience settings, and programming). Check the settings and correct as necessary once the vehicle battery has built up a sufficient charge.

Warning light



Read and follow the introductory information and safety information first ⇒  [Introduction to the subject](#)

Lights up

Proper response



Alternator malfunction.

See an authorized Volkswagen dealer or an authorized Volkswagen Service



Facility. Have the electrical system checked.

Switch off unnecessary electrical loads. The vehicle battery will not be charged by the alternator as you drive.

When the ignition is switched on, several warning and indicator lights come on briefly for a function check. They go out after a few seconds.

WARNING

Failure to heed warning lights and instrument cluster text messages can cause the vehicle to break down in traffic and result in a collision and serious personal injury.

- Never ignore warning lights or text WARNINGS.
- Always stop the vehicle as soon as it is safe to do so.

NOTE

Failure to heed warning lights or text WARNINGS can result in vehicle damage.

Checking the vehicle battery electrolyte level

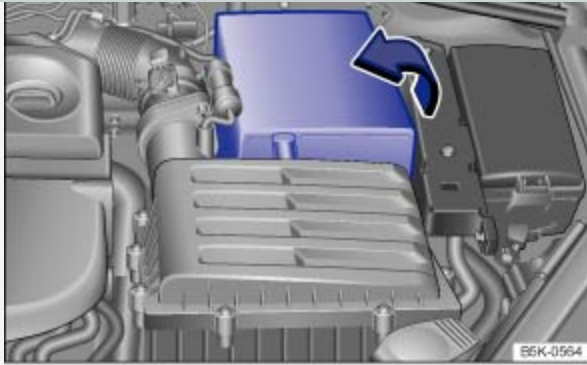




Fig. 203 In the engine compartment: Open the sleeve covering of the vehicle battery.



Read and follow the introductory information and safety information first ⇒  *Introduction to the subject*

Check the electrolyte level of the battery regularly if the vehicle has high mileage (km), in places with a warm climate, and if the vehicle has an old battery. Otherwise the vehicle battery does not require maintenance.

Preparations

- Prepare the vehicle for work in the engine compartment ⇒ *Working in the engine compartment*.
- Open the engine hood ⇒ .

Opening and closing the battery cover

To *open*, fold the cover to the side in the direction of the arrow ⇒ *Fig. 203*.

To *close*, fold the cover against the direction of the arrow.

Checking the vehicle battery acid level

- If the lighting conditions are poor, use a flashlight so that you can clearly see the battery acid level indicator and tell what color it is. Never use an open flame or an unprotected light source.
- The round battery window (acid level indicator) on the top of the battery changes color, depending on the battery's electrolyte level.

Color	Action
-------	--------



<i>Light yellow or colorless</i>	Battery electrolyte level is too low. The vehicle battery may need to be replaced. Have it checked by an authorized Volkswagen dealer or an authorized Volkswagen Service Facility.
<i>Black</i>	Battery electrolyte level is satisfactory.


WARNING

Working on the batteries can cause serious acid burns, explosion, or electrical shock.

- Always wear eye protection and protective gloves.
- Sulfuric battery acid is very corrosive. It can burn unprotected skin and cause blindness. Always wear protective gloves and eye protection.
- Never tilt the vehicle battery. Acid could spill out of the battery vents and burn you.
- Never open a vehicle battery.
- If you get battery acid in your eyes or on your skin, immediately rinse with cold water for several minutes and then get immediate medical attention.
- If you swallow any battery acid, get medical attention immediately.

Charging, replacing, disconnecting, and connecting the vehicle battery



Read and follow the introductory information and safety information first ⇒  *Introduction to the subject*

Charging the vehicle battery

Vehicle batteries should be charged by an authorized Volkswagen dealer or an authorized Volkswagen Service Facility because the factory-installed battery requires a charger with overload protection ⇒





The battery in your vehicle is specially developed for its location, with special dimensions and safety features. Before buying a new battery, ask an authorized Volkswagen dealer or authorized Volkswagen Service Facility what batteries are suitable with regard to electro-magnetic compatibility, dimensions, required maintenance, performance, and safety specifications. Have the battery replaced by an authorized Volkswagen dealer or an authorized Volkswagen Service Facility.

Only use maintenance-free vehicle batteries meeting standards TL 825 06 and VW 7 50 73. These standards must date from July 2012 or later.

Disconnecting the vehicle battery

If the battery must be disconnected from the vehicle's electrical system, note the following:

- Switch off all electrical systems and devices and the ignition.
- Unlock the vehicle before disconnecting the battery; otherwise the alarm system will go off.
- First disconnect the negative cable (-) and then the positive cable (+) ⇒ ⚠ .

Connecting the vehicle battery

- Prior to reconnecting the battery, switch off all electrical systems and devices and the ignition.
- Connect the positive cable (+) first and then the negative cable (-) ⇒ ⚠ .

After the battery is connected and the ignition is switched on, different indicator lights may light up. They should go out after you drive a short distance at 10–12 mph (15–20 km/h). If the indicator lights do not go out, contact an authorized Volkswagen dealer or an authorized Volkswagen Service Facility and have the vehicle checked.

If the battery was disconnected for a long time, the next scheduled service may not be correctly calculated and displayed ⇒ [Instrument cluster](#). The maximum permissible service and maintenance intervals are shown in the ⇒ [Booklet Warranty and Maintenance](#).

Vehicles with Keyless Access

If the ignition will not start after reconnecting the vehicle battery, lock the vehicle from the outside and unlock it again ⇒ [Unlocking or locking the vehicle with Keyless Access](#). Then try to start the ignition again. If the ignition cannot be switched on, contact an authorized Volkswagen dealer, an authorized Volkswagen Service Facility, or another qualified workshop for assistance.



If the vehicle battery drain is high, the intelligent onboard electrical system management automatically takes steps to help prevent battery drain.

- The idle speed is increased so that the alternator provides more power.
- The power to devices that consume a lot of electricity is cut back or switched off completely.
- When the engine is started, the power supply to the 12 Volt sockets is temporarily interrupted.

The onboard electrical system management cannot always keep the battery from being drained. For example, the battery will drain if the engine is not running, but the ignition is switched on or the parking lights are left on for a long time when parked.

What drains the vehicle battery?

- Long periods when the engine is not running, especially when the ignition is on.
- Using electrical systems or devices when the engine is switched off.
- Leaving the vehicle unlocked for several days when not in use.
- The selector lever is left for a long period of time in any position other than Park (P) when the ignition is switched off → [Automatic transmission: Selector lever](#).

WARNING

Failure to use the proper battery with proper mounting and connections may cause short circuits, fires, and serious personal injuries.

- Always use only maintenance-free or cycle-free, leak-proof batteries with the same specifications and dimensions as the original equipment battery. Specifications are listed on the battery housing.

WARNING

When the vehicle battery is charged, it produces highly explosive hydrogen gas.

- Charge vehicle batteries only in well-ventilated areas.
- Never charge a frozen or thawed battery. A dead battery can freeze at temperatures around +32 °F (0 °C).



- Incorrectly connected cables can cause a short-circuit. First connect the positive cable (+) and then the negative cable (-).

NOTE

- Never disconnect the vehicle battery or connect 2 vehicle batteries to each other when the ignition is switched on or the engine is running. Doing this may damage the electrical system or electronic components.
- Never use a vehicle battery that does not meet the specifications for the vehicle battery for your vehicle. Using the wrong battery can damage the electrical system or electronic components and cause electrical malfunctions.
- Never connect power generating equipment, such as a solar panel or battery charger, to the 12 Volt socket in order to charge the vehicle battery. This can damage the vehicle's electrical system.



Dispose of the vehicle battery according to regulations. Vehicle batteries contain poisonous substances such as sulfuric acid and lead.



Battery acid can pollute the environment. Catch leaking operating fluids and dispose of them properly.

Vehicle care and maintenance

Exterior care and cleaning



Introduction to the subject

In this chapter you will find information on the following subjects:

⇒ *Washing the vehicle*

⇒ *Washing with a power washer*

⇒ *Cleaning windows and outside mirrors*



⇒ *Waxing and polishing vehicle paint*

⇒ *Caring for and cleaning chrome and aluminum parts*

⇒ *Cleaning wheel rims*

⇒ *Caring for rubber door and window seals*

⇒ *Deicing door lock cylinders*

⇒ *Undercoating*

⇒ *Cleaning the engine compartment*

Regular and expert care helps to preserve the value of your vehicle. Such expert care may also be one of the requirements of your New Vehicle Limited Warranty if corrosion repair or repainting is necessary.

Vehicle care products are available from your authorized Volkswagen dealer or authorized Volkswagen Service Facility.

WARNING

Vehicle care products can be dangerous. Improper use can cause accidents, burns, poisoning, or other serious personal injuries.

- Always store vehicle care products only in original containers that are securely closed.
- Always read and heed all the instructions and all WARNINGS on the package.
- To reduce the risk of poisoning, never use empty food or beverage containers that might mislead someone into drinking from them.
- Always keep vehicle care products out of the reach of children.
- Always use such products outdoors or in well-ventilated areas, because harmful vapors may be released when these products are used.
- Never use fuel, turpentine, engine oil, nail polish remover or other volatile fluids for vehicle

WARNING

Improper care and cleaning of vehicle components can impact the safety features of the vehicle and cause severe injuries.

- Always clean and maintain vehicle components according to manufacturer's instructions.
- Only use approved or recommended cleaners.

NOTE

Vehicle care products containing solvents can damage plastics and other vehicle materials.

Wash the vehicle only at specifically designated wash locations to help prevent water contaminated with oil, grease and fuel from entering the storm drain sewer system. In some areas it is against the law to wash motor vehicles anywhere other than at specified designated car washing locations.

When buying vehicle care products, try to choose those that are not harmful to the environment.

Never throw out vehicle care products with ordinary household waste. Always read and heed all the instructions and all WARNINGS on the package.

Washing the vehicle



Read and follow the introductory information and safety information first ⇒ [Introduction to the subject](#)

The longer insect splatter, bird droppings, tree sap, road dirt, industrial deposits, tar, soot, road salt, and other aggressive materials stay on your vehicle, the more damage they do to the paint finish. High temperatures (including strong sunlight) increase the corrosive effects. The vehicle underbody should also be washed regularly and thoroughly.

Car wash

Pay close attention to the information provided by the car wash operator. Before going through a car wash, be sure to take the usual precautions to help prevent damage, such as closing the windows,



as a spoiler, a roof rack, or an antenna, always ask the car wash operator if this poses a problem →

The paint finish is tough enough that the vehicle can normally be washed without problems in an automatic car wash. However, the effect on the paint depends to a large extent on the type of car wash. Volkswagen recommends using brushless car wash facilities.

To remove wax residue from the windows and avoid jerky windshield wiper movement, heed the following tips ⇒ [Cleaning windows and outside mirrors](#).

Washing by hand

When washing by hand, first soften the dirt with plenty of water and then rinse off as much dirt as possible.

Then clean the vehicle with a soft sponge, a washing mitt or brush using only light pressure. Start on the roof and work down. Use special shampoo only on hard-to-remove dirt or grime.

Rinse the sponge or glove thoroughly and often.

Clean the wheels and under the door sills last. Use a different sponge or wash mitt.

WARNING

After the vehicle has been washed, the wet brakes or, in winter, brake discs or pads coated with ice, react slower and need longer stopping distances.

- Always dry the brakes and clean off any ice coatings with a few careful applications of the brake. Make sure not to endanger other motorists or cyclists or disobey legal requirements.

CAUTION

Sharp edges under the vehicle can cut exposed skin.

- Always protect your hands and arms from cuts on sharp metal edges when cleaning the underbody, the inside of the wheel housings, etc.

NOTE



- To help prevent damage to the paint, do not wash the vehicle in direct sunlight.
- Do not use insect sponges, abrasive kitchen sponges or similar things to clean the vehicle. These can damage the paint finish.
- Never clean headlights with a dry cloth or sponge. Always use a wet cloth or sponge. For best results use soapy water.
- When washing or rinsing the vehicle in cold weather, do not let water get into the lock cylinders or point the hose at gaps around the doors, hood, or trunk lid. The water could freeze on the locks and seals and make it difficult to open the vehicle!
- When outside temperatures are low, wipe the rubber seals and their contact surfaces dry to help prevent freezing.


NOTE


To help prevent vehicle damage in a car wash:

- Compare the vehicle track width with the dimensions of the guide rails in the car wash to help prevent damage to wheel rims and tires!
- Switch off the rain sensor before driving the vehicle through a car wash ⇒ *Rain sensor*.
- Make sure there is enough clearance for the height and width of the vehicle.
- To help prevent paint damage to the engine hood, place wiper blades against the windshield after they have dried. Do not let them snap back into place.
- Fold the outside mirrors toward the vehicle body. For vehicles equipped with electrically folding outside mirrors, do not fold the mirrors manually!
- Lock the trunk lid to help prevent unintentional opening in the car wash.

Washing with a power washer



Read and follow the introductory information and safety information first ⇒  *Introduction to the subject*

Always follow the instructions for the power washer. This especially applies to the pressure and spraying distance ⇒ .



well as any sensors that can be located on the front and rear of the vehicle, for example, the Park Distance Control system sensors (if equipped) ⇒ .

Never use concentrated jet nozzles or so-called dirt blasters ⇒ .

Never use a power washer to clean the engine compartment ⇒ *Cleaning the engine compartment* .

WARNING

Improper use of power washers can cause serious invisible permanent damage leading to tire failure and loss of vehicle control. This can cause accidents and severe personal injury.

- Keep sufficient distance between water jet and tires. Never wash tires with a nozzle that sprays the water out in a direct stream regardless of the distance to the tire and even for a very short time.
- Never use dirt blasters to clean tires. Even spraying from a relatively long distance for a very short time can do visible or invisible damage to tires.

WARNING

After the vehicle has been washed, the wet brakes or, in winter, brake discs or pads coated with ice, react slower and need longer stopping distances.

- Always dry the brakes and clean off any ice coatings with a few careful applications of the brake. Make sure not to endanger other motorists or cyclists or disobey legal requirements.

NOTE

- Water temperature should not be more than +140 °F (+60 °C).
- To help prevent damage to the paint, do not wash the vehicle in direct sunlight.
- In order for any sensors located on the outside of the vehicle to work correctly, they must be kept clean and clear of snow and ice.
- When using a power washer or steam cleaner, only spray the sensors directly for a short period of time and always keep the nozzle at least 4 inches (10 cm) from the sensor.
- Do not clean icy or snow-covered windows with a power washer.
- When washing or rinsing the vehicle in cold weather, do not let water get into the lock cylin-



the locks and seals and make it difficult to open the vehicle:

Cleaning windows and outside mirrors




Read and follow the introductory information and safety information first ⇒ [Introduction to the subject](#)

Cleaning windows and outside mirrors


Spray windows and outside mirrors with a commercially available alcohol-based window cleaner.

Dry windows and mirrors with a clean chamois or a lint-free cloth. Do not use a chamois that has been used to wipe painted surfaces because it will have absorbed an oily residue that will smear the glass surfaces.

Use window cleaner or a silicone remover to remove rubber, oil, grease and silicone deposits ⇒  .

Removing wax residue

Automatic car washes and vehicle care products can leave a wax residue on all glass surfaces. These wax residues can only be removed with special cleaners or cleaning cloths. Wax residue left on the windshield can cause the windshield wipers to grab and squeak instead of gliding smoothly. We recommend that after every car wash you remove any wax residue left on the windshield with a window cleaning cloth/chamois - G 052 522 A1 - or equivalent.

Windshield wiper squeak and grab can be reduced by filling the windshield washer fluid tank with a wiper fluid containing wax-removing agents. Make sure to maintain the proper mixing ratio when re-filling the washer fluid tank. Grease-removing cleaning agents cannot remove wax residue ⇒  .

Windshield cleaners, special cleaners, and cleaning cloths are available from your authorized Volkswagen dealer and authorized Volkswagen Service Facility.

Removing snow

Remove snow from all windows and outside mirrors with an appropriate brush.

Removing ice

The best way to remove ice is with a deicer spray. When using an ice scraper always scrape in one di-

WARNING

Dirty or fogged up windows reduce visibility and increase the risk of accidents and severe injuries.

- Don't drive until you have clear visibility through all windows.
- Remove ice, snow and condensation from all inside and outside window surfaces.

NOTE

- Never mix recommended cleaning agents with other cleaning agents in the windshield washer reservoir. If you do, this could cause sediments or other by-products that can clog the windshield washer nozzles.
- Never use warm or hot water to remove snow and ice from windows and mirrors. This could cause the glass to crack!
- The heating elements for the rear defroster are on the inside of the rear window. Do not put stickers over the heating elements on the inside of the rear window and never clean the inside of the windows with corrosive or acidic cleaning agents or other chemicals that could damage the heating elements.
- Antennas installed on the insides of windows can be damaged by abrasive objects or by corrosive or acidic cleaning agents or other chemicals. Do not place any stickers on the windshield-integrated antenna and never clean the antenna with corrosive or acidic cleaning agents or other chemicals.

Cleaning and changing the windshield wiper blades

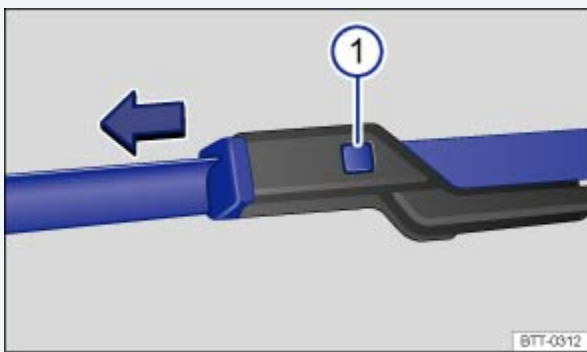


Fig. 204 Changing the windshield wiper blades.




Fig. 205 Changing the rear window wiper blades.



Read and follow the introductory information and safety information first ⇒ [Introduction to the subject](#)

Factory-installed wiper blades have a graphite coating. The graphite coating lets the wiper blades glide smoothly over the windshield. If this coating is worn or damaged, the wipers may grab or squeak.

Check all wiper blades regularly. Wiper blades that grab and squeak must be replaced if worn or damaged and cleaned if dirty ⇒ .

Replace worn or damaged wiper blades immediately. Replacement blades may be purchased from any authorized Volkswagen dealer or authorized Volkswagen Service Facility.


Lifting and tilting windshield wiper arms

Move the front wiper arms to the service position before lifting them away from the windshield ⇒ [Windshield wipers and washer](#).

It is not possible to lift the front wiper arms away from the windshield when they are not in the service position.

When lifting or replacing a wiper blade on a window, grip it only by its mounting and not by the blade itself.

Cleaning the wiper blades

- Move the front wiper arms to the service position and lift them away from the windshield.
- Using a soft cloth, carefully remove dust and dirt from the wiper blades.
- If the blades are very dirty, carefully clean them with a sponge or cloth ⇒ .



Changing the front windshield wiper blades

- Move the front wiper arms to the service position and lift them away from the windshield.
- Press and hold the release button ⇒ [Fig. 204①](#).
- While lifting the wiper blade in the direction of the wiper arm, pull off the wiper blade in the direction of the arrow. This may require moderate force.
- Install a new wiper blade of same length and type onto the wiper arm by pushing in the opposite direction of the arrow until it latches.
- Carefully fold the wiper arm back down onto the windshield.

Changing the rear window wiper blade

- Lift the wiper arm away from the rear window.
- Press and hold the release button ⇒ [Fig. 205①](#).
- While lifting the wiper blade in the direction of the wiper arm ⇒ [Fig. 205](#) (arrow ①), pull off the wiper blade in the direction of the arrow ②. This may require moderate force.
- Install a new wiper blade of the same length and type onto the wiper arm by pushing in the opposite direction of the arrow ⇒ [Fig. 205②](#) until it latches.
- Carefully fold the wiper arm back down onto the window.

WARNING

Worn or dirty wiper blades reduce visibility and increase the risk of accidents and severe injuries.

- Always change wiper blades if they are damaged or worn, and if they cannot clean the windows sufficiently.

NOTE

- Damaged or dirty wiper blades can scratch the windshield and the rear window.
- Solvents, abrasive sponges and sharp-edged objects will damage the graphite coating on the wiper blades.
- Do not clean the windows with gasoline, nail polish remover, paint thinner or similar fluids.



away from the windshield only when they are in the service position.

Waxing and polishing vehicle paint



Read and follow the introductory information and safety information first ⇒ [Introduction to the subject](#)

Waxing

A good coat of wax helps to protect the vehicle paint. When water no longer forms small drops and runs off when the paint is *clean*, apply a new coat of good hard wax to protect the vehicle again.

Even if a wax solution is used regularly at the car wash, Volkswagen recommends applying a coat of hard wax at least twice a year to protect the paint.

Polishing

Polish your vehicle if the paint has lost its shine and the gloss cannot be brought back with wax.

The vehicle must be waxed after polishing if the polish used does not contain wax compounds to seal the paint.

NOTE

- To help prevent damage, do not use hard wax or polish on matte-finished parts, plastic parts, headlights or rear lights.
- Do not wax or polish your vehicle if it is dirty, or in a sandy or dusty place.

Caring for and cleaning chrome and aluminum parts



Read and follow the introductory information and safety information first ⇒ [Introduction to the subject](#)

- Clean the surface using a clean, soft, lint-free cloth dampened with water.
- If the surface is especially dirty, use a special solvent-free cleaning material.
- Then polish chrome and aluminum parts with a soft, dry cloth.



To help prevent damage to chrome and aluminum parts:

- Do not clean or polish in direct sunlight.
- Do not clean or polish in sandy or dusty places.
- Do not use abrasive cleaners or abrasive sponges.
- Do not polish dirty surfaces.
- Do not use cleaning materials that contain solvents.
- Do not use hard wax.

NOTE

Chrome wheel covers and hubcaps can have an extra coating. Do not treat them with chrome care or polishing products. Use regular paint care and polishing products.

Cleaning wheel rims



Read and follow the introductory information and safety information first ⇒ [Introduction to the subject](#)

Cleaning steel wheels

Stubborn brake dust can be removed with an industrial cleaner. Clean steel wheels regularly with a separate sponge.

Repair any paint damage on steel wheels before rust begins to form.

Cleaning alloy wheels

Every 2 weeks: Wash road salt and brake dust off alloy wheels, and clean the wheels with an acid-free detergent. Every 3 months: Volkswagen recommends applying a hard wax compound to the wheels.

If road salt and brake dust are not removed regularly, they can corrode the metal.

Use an acid-free detergent specifically designed for light alloy wheels. Do not use car polish or other



If the protective coating is damaged, for example by stone impact, repair the damaged area right away.

Caring for rubber door and window seals



Read and follow the introductory information and safety information first ⇒ [Introduction to the subject](#)

The rubber seals around the doors and windows will stay soft and flexible, seal better and last longer if the seals are treated regularly with a suitable rubber care product.

Before applying the treatment, use a soft cloth to remove dust and dirt from the rubber seals.



Do not apply any rubber care products to the rubber seals on the body in the areas around the windows in the driver and front passenger doors. The product could run down onto the windows and smudge them.

Deicing door lock cylinders



Read and follow the introductory information and safety information first ⇒ [Introduction to the subject](#)

Volkswagen recommends using only genuine Volkswagen deicer spray with lubricating and anti-corrosive properties to deice door lock cylinders.

NOTE

Lock deicers that contain grease solvents can cause the lock cylinder to rust.

Undercoating



Read and follow the introductory information and safety information first ⇒ [Introduction to the subject](#)



could be damaged during normal use. We therefore recommend that you have the protective coatings on the underbody and suspension inspected regularly, and repaired if necessary.

WARNING

Undercoating and rustproofing products can catch fire on the hot exhaust system or any other hot engine component.


- Never apply additional undercoating or rustproofing on or near the exhaust manifold, the exhaust pipes, the catalytic converter, the heat shields, or any other hot vehicle component.


Cleaning the engine compartment



Read and follow the introductory information and safety information first ⇒ [Introduction to the subject](#)

The engine compartment of a vehicle is a dangerous area ⇒ [Working in the engine compartment](#).

If necessary, the engine compartment should be cleaned by an authorized Volkswagen dealer or authorized Volkswagen Service Facility. Incorrect cleaning procedures could remove corrosion protection and damage electrical components, among other things. In addition, water could enter directly into the vehicle interior through the plenum chamber ⇒ .

Never use a power washer to clean the engine compartment ⇒ .

If the engine compartment is extremely dirty, have it cleaned professionally by your authorized Volkswagen dealer or authorized Volkswagen Service Facility.

Plenum chamber

The plenum chamber is located in the engine compartment between windshield and engine, under a perforated cover. Outside air is taken into the vehicle interior from the plenum chamber via the climate control system.

Regularly remove leaves and other loose objects from the plenum chamber cover by hand or with a vacuum cleaner.

Have the area under the perforated cover cleaned by an authorized Volkswagen dealer or authorized



WARNING

Injuries, scalding, electric shock, accidents, and fire hazards can occur while working on the engine or in the engine compartment!

- Before working in the engine compartment, be sure to familiarize yourself with the necessary procedures and generally accepted safety precautions ⇒ [Working in the engine compartment](#).
- Volkswagen recommends having the work performed by an authorized Volkswagen dealer or authorized Volkswagen Service Facility.

NOTE

Spraying or pouring water (for example, with a power washer) into the plenum chamber can cause severe damage to the vehicle.



Wash the engine compartment only in special wash bays so that the oily dirt and fuel residue that are washed off the vehicle will not enter the sewage system. In some areas it is illegal to wash the engine compartment anywhere other than at such specified locations.

Interior care and cleaning



Introduction to the subject

In this chapter you will find information on the following subjects:

⇒ *Caring for upholstery*

⇒ *Cleaning upholstery, fabric trim, and microfiber fabric*

⇒ *Care and cleaning of leather upholstery*

⇒ *Cleaning leatherette*

⇒ *Cleaning storage compartments and cup holders*

⇒ *Care and cleaning of plastic components, wood trim, and instrument panel*



Modern clothing fabrics such as dark denim may not be completely colorfast. Even with normal use, dye from these and other fabrics can rub off on seat upholstery and leave visible discolorations (especially on light-colored seat upholstery). This is caused by a lack of colorfastness in the clothing fabric, not by any fault in the seat upholstery fabric. To help prevent damage to the seat upholstery, always make sure your clothing is colorfast. Volkswagen recommends having a qualified specialist remove any discolorations from the seat upholstery.

The longer stains, dirt and other deposits remain on the surfaces of vehicle components and upholstery, the more difficult it may be to clean them. If stains, dirt and deposits are left untreated for a long time, they may become impossible to remove.

WARNING

Vehicle care products can be dangerous. Improper use can cause accidents, burns, poisoning, or other serious personal injuries.

- Always store vehicle care products only in original containers that are securely closed.
- Always read and heed all the instructions and all WARNINGS on the package.
- To reduce the risk of poisoning, never use empty food or beverage containers that might mislead someone into drinking from them.
- Always keep vehicle care products out of the reach of children.
- Always use such products outdoors or in well-ventilated areas, because harmful vapors may be released when these products are used.
- Never use fuel, turpentine, engine oil, nail polish remover or other volatile fluids for vehicle care. They are poisonous and highly flammable.

WARNING

Improper care and cleaning of vehicle components can compromise the vehicle's safety features and cause serious personal injury.

- Always clean and maintain vehicle components according to manufacturer's instructions.
- Only use approved or recommended cleaners.




- Vehicle care products containing solvents can cause irreparable damage to plastics and other vehicle materials.
- Stains, dirt and other deposits that contain aggressive substances or solvents can corrode vehicle materials and cause permanent damage, even after brief contact with the surface.
- Remove stains, dirt, and other deposits as quickly as possible and do not allow them to dry.
- To help prevent damage, have stubborn stains removed by a professional who has the necessary expertise and experience.




Suitable care products are available from authorized Volkswagen dealers and authorized Volkswagen Service Facilities.

Caring for upholstery



Read and follow the introductory information and safety information first ⇒  [Introduction to the subject](#)

Checklist

Please note the following when it comes to the care and preservation of the upholstery ⇒  :

- ✓ Open Velcro® fasteners can damage upholstery, fabric, and trim. Before you get into the vehicle, close all Velcro® fasteners that could come into contact with upholstery fabrics and cloth trim.
- ✓ Sharp-edged objects and items on clothing and belts (such as belt clips, mobile phone cases, zippers, rivets, and rhinestones) can damage upholstery material and fabric trim. To help prevent damage, do not let such items come into direct contact with the upholstery and fabric trim.
- ✓ Dust and dirt particles in pores, folds, and seams can have a scouring effect on material and damage the surface. Remove dust and dirt regularly to help prevent permanent surface damage.
- ✓ Check clothing for color-fastness to help prevent upholstery discoloration, especially to light-colored upholstery.

 **NOTE**



and fabric trim.

- Please note and follow the points listed in the checklist.



Volkswagen recommends having any discoloration removed by an authorized Volkswagen dealer or authorized Volkswagen Service Facility.

Cleaning upholstery, fabric trim, and microfiber fabric



Read and follow the introductory information and safety information first ⇒ [Introduction to the subject](#)

Cleaning upholstery on heated seats and power seats or seats with airbag components

Airbag components and electrical connectors may be installed in the driver seat, the front passenger seat, and in the outer rear seats. Damaging, cleaning and handling incorrectly, or wetting or soaking these seat surfaces and backrests can damage the vehicle electrical system and prevent the airbag system from working properly ⇒ ⚠ .

Electrical components and connectors that could be damaged by incorrect cleaning or handling are installed in power seats and heated seats ⇒ ⚠ . This can also result in damage to other parts of the vehicle electrical system.

For this reason, read and follow these cleaning instructions:

- Do not use power washers, steam cleaners, or cooling spray.
- Do not use detergent pastes or mild detergent solutions.
- Do not wet the surface completely.
- Only use cleaning products approved by Volkswagen.
- If you have questions or concerns, consult a professional cleaner.
- Before using any cleaning agent, familiarize yourself with instructions and warnings on the packaging.
- Vacuum upholstery, fabric trim, microfiber fabric, upholstery, and carpeting regularly with a suitable brush attachment.



ing ⇒ ⓘ .

- Clean microfiber fabric surfaces with a damp cotton or wool cloth or a commercially available lint-free microfiber cloth ⇒ ⓘ .

Upholstery and fabric trim with light generalized soiling can be cleaned with a commercially available dry-foam cleaner.

If the upholstery and fabric trim pieces are heavily soiled, see your authorized Volkswagen dealer or authorized Volkswagen Service Facility before you begin cleaning to learn about suitable cleaning options. If necessary, have the cleaning done by a professional.

Cleaning upholstery on non-heated seats, manual seats, or seats without airbag components

- Before using any cleaning agent, familiarize yourself with instructions and warnings on the packaging.
- Vacuum upholstery, fabric trim, microfiber fabric, and carpeting regularly with a suitable brush attachment.
- Do not use power washers, steam cleaners, or cooling spray.
- A soft sponge or a commercially available lint-free microfiber cloth may be used for general cleaning ⇒ ⓘ .
- Clean microfiber fabric surfaces with a damp cotton or wool cloth or a commercially available lint-free microfiber cloth ⇒ ⓘ .

Upholstery and fabric trim with light generalized soiling can be cleaned with a commercially available dry-foam cleaner.

If the upholstery and fabric trim pieces are heavily soiled, see your authorized Volkswagen dealer or authorized Volkswagen Service Facility before you begin cleaning to learn about suitable cleaning options. If necessary, have the cleaning done by a professional.

Treating stains

When treating stains, it may be necessary to clean the entire surface and not just the stain itself. This is especially true if the entire surface has become dirty from normal use. Otherwise, the area that is treated may become lighter than the untreated area. If you have questions or concerns, consult a professional cleaner.



<p><i>Water-based stains</i>, such as coffee or fruit juice.</p>	<ul style="list-style-type: none">- Moisten a sponge with water and rub the stain gently with a circular motion.- Wipe dry with an absorbent cloth.
<p><i>Persistent stains</i>, such as chocolate or make-up.</p>	<ul style="list-style-type: none">- Use only Volkswagen-approved cleaning products.- If necessary, have the fabric or upholstery professionally cleaned.
<p><i>Grease-based stains</i>, such as oil, lipstick, etc.</p>	<ul style="list-style-type: none">- Use only Volkswagen-approved cleaning products.- If necessary, have the fabric or upholstery professionally cleaned.

 **WARNING**

If there is a malfunction in the airbag system, the airbag may not deploy correctly or at all, or it may deploy unexpectedly. This could cause fatal injuries.

- Have the airbag system inspected immediately by your authorized Volkswagen dealer or authorized Volkswagen Service Facility.

 **NOTE**

If the upholstery on power seats, heated seats, or seats with airbag components is wet, electrical



- If the seating surface becomes soaked, have it dried and the system components checked immediately by an authorized Volkswagen dealer or authorized Volkswagen Service Facility.
- Do not use steam cleaners because the steam could cause the dirt to penetrate deeper into the fabric and make it impossible to remove.
- Power washers and cooling sprays can damage the upholstery.

NOTE


- Clean only the carpet and floor mats with brushes. Other textile surfaces can be damaged by brushes.
- If detergent pastes or mild detergent solutions are applied with a damp cloth or sponge, the surfactants in the detergent may cause visible lines to form at the edges of the area where the detergent was applied. These lines are generally difficult or impossible to remove.

NOTE

- Do not soak microfiber fabric.
- Do not treat microfiber fabric with leather care products, solvents, floor wax, shoe polish, stain remover or similar products.
- Do not use brushes for damp cleaning, because they can damage upholstery surfaces.
- Do not use a steam cleaner, because dirt will penetrate deeper into the fabric.

Care and cleaning of leather upholstery



Read and follow the introductory information and safety information first ⇒  [Introduction to the subject](#)

If you have questions regarding the care and cleaning of the leather upholstery in the vehicle, please contact an authorized Volkswagen dealer or authorized Volkswagen Service Facility.

Care and treatment

Natural leather requires special attention and care. Napa leather has a smooth surface. The intensity of the color application determines the leather's appearance and texture. If you can see the leather



comfortable seating. Delicate veins, closed scars, insect bites, folds, and a slightly clouded color remain visible and represent authentic characteristics of the natural material. Untreated napa leather has no protective coating. It is therefore more susceptible to damage. You should keep this in mind if the leather is going to be exposed to severe wear from children, animals, or other factors. By contrast, leather that has a protective coating is more robust. This has a positive effect on the leather's durability in daily use. The typical natural characteristics are hardly visible or no longer visible at all, but that has no impact on the quality of the leather itself. The typical characteristics of untreated leather are much more distinctive than those of a surface-treated leather.

- After each cleaning, apply cream that waterproofs the leather and protects it against the sun. Such creams also nourish the leather, let it breathe, keep it flexible and moisturized. At the same time it protects the surface.
- Clean leather every 2 to 3 months and remove any new stains.
- Treat leather with a suitable leather-care product twice a year ⇒ ⓘ .
- Apply cleaning and conditioning materials sparingly and always with a dry, lint-free cotton or wool cloth. Do not apply cleaning and conditioning materials directly to the leather.
- Remove fresh stains such as ballpoint pen, lipstick, ink, shoe polish, etc. as soon as possible.
- Preserve the leather's color. If necessary, refresh fading spots with a specially-colored leather cream.
- Wipe the leather with a soft cloth.

Cleaning

Volkswagen recommends using a slightly moistened cotton or wool cloth for general cleaning.

It is important not to let water soak through the leather or penetrate into seams.

Before cleaning leather surfaces, read and heed the information ⇒ [Cleaning upholstery, fabric trim, and microfiber fabric](#) .

Type of stain	Cleaning
---------------	----------



<p><i>Heavy stains</i></p>	<ul style="list-style-type: none">- Apply a mild soapy solution with a cloth that has been wrung nearly dry^{a)}.- Dab dry with an absorbent cloth.
<p><i>Water-based stains, such as coffee, tea, juice, or blood.</i></p>	<ul style="list-style-type: none">- Remove fresh stains with an absorbent cloth.- If the stains are already dry, use an appropriate cleaning agent ⇒ ⚠ .
<p><i>Grease-based stains, such as oil, lipstick, etc.</i></p>	<ul style="list-style-type: none">- Remove fresh stains with an absorbent cloth.- Use an appropriate cleaning agent on stains that have not yet penetrated the surface ⇒ ⚠ .
<p><i>Special stains, such as ballpoint pen, marker, nail polish, latex paint, or shoe polish.</i></p>	<ul style="list-style-type: none">- Dab dry with an absorbent cloth.- Clean with a special stain remover designed for leather.

⚠ NOTE

- Stains that have been left in place too long will penetrate the surface of the leather and cannot be removed.



- Wipe up spilled liquids immediately with an absorbent cloth. Liquid can penetrate leather surfaces and seams within a few seconds.
- If the vehicle is left in the sun for a long time, cover the upholstery to protect the leather from direct sunlight and to help prevent fading and discoloration.



Slight discoloration caused by wear and tear is normal.

a) Mild soap solution: 2 tablespoons of liquid soap in 1 quart (liter) of water.

Cleaning leatherette



Read and follow the introductory information and safety information first ⇒ [Introduction to the subject](#)

Clean leatherette upholstery only with water and a mild soap solution.

Before cleaning leatherette surfaces, read and heed the information ⇒ [Cleaning upholstery, fabric trim, and microfiber fabric](#).

NOTE

- Do not clean leatherette with solvents, floor wax, shoe polish, stain remover, or similar products.
- These can cause the material to become brittle and break. Sharp-edged objects and items on clothing and belts (such as belt clips, mobile phone cases, zippers, rivets, and rhinestones) can damage upholstery material and fabric trim.
- If the vehicle is left in the sun for a long time, cover the upholstery to protect the leatherette from direct sunlight and to help prevent fading or discoloration.

Cleaning storage compartments and cup holders



Read and follow the introductory information and safety information first ⇒ [Introduction to the subject](#)



tom.

- Moisten a clean, lint-free cloth with water and clean plastic or rubber parts.
- If this is not sufficient, then use a special solvent-free care and cleaning product designed for plastics.
- Clean felt inserts with a vacuum cleaner.

Care and cleaning of plastic components, wood trim, and instrument panel



Read and follow the introductory information and safety information first ⇒ [Introduction to the subject](#)

- Moisten a clean, lint-free cloth with water and clean the parts.
- Clean *plastic components (inside and outside of the vehicle) and the instrument panel only* with a solvent-free care and cleaning product that is specifically designed for plastics and approved by Volkswagen ⇒ .
- Clean *wood trim* with a mild soap solution.

WARNING

Using solvents or other improper cleaning products on surfaces where airbags are located can change the way airbags deploy in a crash.

- Products containing solvents will change the properties of the plastics and may cause plastic parts to break and fly around when the airbag deploys in a crash, causing injury.
- Never use solvents or cleaners on the steering wheel horn pad or on the instrument panel because they can damage the airbag cover or change the stiffness or strength of the material so that the airbag cannot deploy and protect properly.
- When cleaning the horn pad and instrument panel, use only a soft, dry cloth or a cloth moistened with plain water.

Cleaning the safety belts



subject

If a safety belt is dirty, this can prevent the belt from working properly. Keep safety belts clean and regularly check all safety belts for damage.

Safety belts must never be taken apart for cleaning.

- Remove coarse dirt with a soft brush ⇒ ⚠.
- Carefully pull the dirty safety belt out of the retractor and keep it out.
- Clean the safety belt with a *mild* soap solution.
- After cleaning, always give the safety belts time to dry thoroughly before letting them retract. This helps prevent damage to the retractor.
- Do not let the safety belts retract until they are completely dry.

WARNING

Damage to safety belts reduces their overall effectiveness and increases the risk of serious personal injury and death whenever the vehicle is being used.

- Check the condition of all safety belts regularly. If you notice that the safety belt webbing, hardware, retractor, buckle, or any other part of the safety belts is damaged, immediately have an authorized Volkswagen dealer or authorized Volkswagen Service Facility replace the safety belt with the correct replacement belt for your vehicle model and model year.
- Never use chemical cleaning agents, solvents, or any substance that may damage or weaken the safety belt webbing or any other parts of the safety belt. Never let the belts come into contact with corrosive fluids or sharp objects. Otherwise, the safety belt webbing will be significantly weakened.
- After cleaning, always give the safety belts time to dry completely before letting them retract. The moisture can damage the retractor and keep it from working properly.
- Never let foreign objects or liquids get into the safety belt latch. This could prevent the belt buckles and safety belts from working properly.
- Damaged safety belts must be replaced; they cannot be repaired.
- Never try to repair a damaged safety belt yourself. Never remove or modify the safety belts in



- Safety belts that were subject to stress in an accident and stretched must be replaced with a correct, new safety belt, preferably by an authorized Volkswagen dealer or authorized Volkswagen Service Facility.
- Replacement after a crash may be necessary even if a safety belt shows no visible damage. Anchorages that have been loaded must also be inspected.

Parts, accessories, repairs, and modifications



Introduction to the subject

In this chapter you will find information on the following subjects:

⇒ *Break-in period*

⇒ *Parts and accessories*

⇒ *Operating fluids and equipment*

⇒ *Repairs and technical modifications*

⇒ *Repairs and other things that can affect Advanced Airbag performance*

⇒ *Notice about data recorded by the Event Data Recorder and vehicle control modules*

⇒ *Using a mobile phone in a motor vehicle when it is not connected to a vehicle telephone antenna:
Some important things to know*

WARNING

Inappropriate spare parts and accessories as well as improperly performed work, modifications and repairs can cause vehicle damage, accidents and serious personal injuries.

- Volkswagen strongly recommends to only use accessories approved by Volkswagen and Genuine Volkswagen Parts[®]. These parts and accessories have been evaluated by Volkswagen for their suitability, reliability and safety.
- Have repairs and vehicle modifications performed by an authorized Volkswagen dealer or au-



Volkswagen service facilities have the required tools, diagnostic equipment, repair information, and trained personnel to properly replace any airbag in your vehicle and assure system effectiveness in a crash.

- Only install parts on the vehicle that are consistent with factory-installed parts with respect to design and characteristics.
- Never store, mount, or attach objects, such as cup holders or phone cradles, on or next to the airbag module covers or within the airbags deployment zones.
- Only use wheel rim/tire combinations approved by Volkswagen for the respective vehicle type.

Break-in period



Read and follow the introductory information and safety information first ⇒ [Introduction to the subject](#)

Note applicable requirements for breaking in new parts.

Breaking in a new engine

A new engine must be carefully broken in during the first 1000 miles (1600 kilometers). During the first few hours of driving, the engine's internal friction is higher than later when all moving parts have been broken in.

Engine life is influenced by how you drive the vehicle for the first 1000 miles (1600 km). Even afterwards, driving at moderate engine speeds, especially when the engine is cold, will tend to reduce engine wear and help the engine to last longer and go farther. But do not drive at an excessively low engine speed, either. Always downshift if the engine is not running smoothly. For the first 600 miles (1000 km):

- Do not use full throttle.
- Don't let the engine speed get above 2/3 of the maximum speed.
- Do not tow a trailer.

From 600 to 1000 miles (1000 to 1600 km): Speed may *gradually* be increased to maximum permissible road and engine speed.

New tires and brake pads



- Brakes ⇒ [Braking and parking](#)



Breaking in a new engine gently will increase service life and reduce oil consumption.

Parts and accessories



Read and follow the introductory information and safety information first ⇒ [Introduction to the subject](#)

Volkswagen recommends that you consult an authorized Volkswagen dealer or authorized Volkswagen Service Facility before purchasing accessories, spare parts or other equipment. Always do so if you want to install additional accessories or replace parts. Your authorized Volkswagen dealer or authorized Volkswagen Service Facility can provide information about legal requirements and factory-recommended accessories, spare parts, and other equipment.

WARNING

Improper vehicle modifications and repairs affect the performance of the airbag system and cause malfunctions and severe personal injuries.

- Never store, mount, or attach objects, such as cup holders or phone cradles, on or next to the airbag module covers or within the airbag deployment zones.
- Objects on or near the surface where airbags are located can come loose and cause serious personal injury if the airbag deploys.

Operating fluids and equipment



Read and follow the introductory information and safety information first ⇒ [Introduction to the subject](#)

Operating fluids and parts that wear out with use (such as timing belts, tires, engine coolants, engine oils, spark plugs, and vehicle batteries) are constantly being improved. For this reason, it is important to have operating fluids changed and wearing parts replaced by an authorized Volkswagen dealer or authorized Volkswagen Service Facility. Authorized Volkswagen dealers and authorized Volkswagen Service Facilities are always up-to-date regarding new developments and changes.



Improper use of operating fluids and equipment can cause accidents, serious personal injuries, burns and/or poisoning.

- Always store vehicle care products in a safe place in original containers that are securely closed.
- To reduce the risk of poisoning, never use empty food or beverage containers that might mislead someone into drinking from them.
- Always keep vehicle care products out of the reach of children.
- Always read and heed all the instructions and all WARNINGS on the package before using vehicle care products.
- When using products that give off harmful fumes, always work outdoors or in a well ventilated area.
- Never use fuel, turpentine, engine oil, nail polish remover or other volatile fluids for vehicle care. They are poisonous and highly flammable. They could cause fires and explosions!

NOTE


- Only refill with suitable operating fluids. When changing or topping off fluids, make sure that you pour the fluids into the correct reservoirs. Adding incorrect fluids will cause serious malfunctions and engine damage! Under no circumstances should you mix up operating fluids. Otherwise serious malfunctions and engine damage can occur!
- Accessories and other things installed in front of the cooling air intakes impair the efficiency of the engine coolant. The engine can overheat under high outside temperatures or under high engine loads!



Leaking operating fluids can pollute the environment. Collect leaking operating fluids in suitable containers and dispose of them properly in accordance with applicable environmental laws and regulations.

Repairs and technical modifications



Read and follow the introductory information and safety information first ⇒  *Introduction to the subject*



Changes to electronic components and related software can cause malfunctions. These malfunctions can also affect other systems that are related to the component or software that was modified. The vehicle's operational safety can be seriously jeopardized, increased vehicle component wear can occur, and the vehicle may no longer meet applicable emissions requirements.

Volkswagen recommends having all repairs and technical modifications performed by an authorized Volkswagen dealer or authorized Volkswagen Service Facility using Genuine Volkswagen Parts[®].

Damage that is caused by improper repairs or unapproved technical modifications will not be covered by any Volkswagen Limited Warranty.

WARNING

Improperly performed repairs and modifications can cause vehicle damage and malfunctions, and can impair the efficiency of driver assistance systems. This can lead to accidents and severe personal injuries.


- Have repairs and vehicle modifications done by an authorized Volkswagen dealer or an authorized Volkswagen Service Facility.

NOTE

Improperly performed repairs and modifications can cause increased component wear and result in vehicle emissions that no longer meet applicable requirements.

Repairs and other things that can affect Advanced Airbag performance



Read and follow the introductory information and safety information first ⇒  [Introduction to the subject](#)

Repairs and modifications of front bumpers, doors, front seats, headliners and the chassis can affect proper airbag performance and should be performed by an authorized Volkswagen dealer or authorized Volkswagen Service Facility. These vehicle areas can contain important parts of the airbag system.



the airbag system itself or related components. Damage to airbag parts can prevent the system from working properly in a collision.

Observe all regulations so that the effectiveness of the airbag is not affected and to prevent disassembled parts from causing injuries and pollution. Authorized Volkswagen dealers, authorized Volkswagen Service Facilities, and other qualified workshops are familiar with these regulations.

Changing the vehicle's suspension system can change the way that the airbag system works in a crash. For example, using tire-rim combinations not approved by Volkswagen, lowering the vehicle, changing the stiffness of the suspension, including the springs, suspension struts, shock absorbers etc. can change the forces that are measured by the airbag sensors and sent to the electronic control unit. Some suspension changes can, for example, increase the force levels measured by the airbag sensors and sent to the electronic control unit and make the airbag system deploy in crashes in which it would not deploy if the changes had not been made. Other kinds of changes may reduce the force levels measured by the sensors and prevent the airbag from deploying when it should.

Never install leather upholstery on a vehicle that originally had cloth upholstery. Never install cloth upholstery on a vehicle that originally had leather upholstery. The capacitive passenger detection system for the Advanced Airbag system will not work properly if different upholstery is installed on the passenger seat than the upholstery originally installed on the vehicle when it was originally manufactured.

WARNING

Changing the vehicle's suspension including use of unapproved tire-rim combinations can change airbag performance and increase the risk of serious personal injury in a crash.

- Never install suspension components that do not have the same performance characteristics as the components originally installed on your vehicle.
- Never use tire-rim combinations that have not been approved by Volkswagen.

WARNING

Leaving the optional safety belt extender attached to the safety belt buckle on the front passenger seat when the safety belt is not being used will prevent the Advanced Airbag System from working properly and can increase the risk of serious personal injury in a collision.



the safety belt is not being used will signal to the airbag control unit that the front passenger seat is occupied and that the safety belt is being used. The electronic control unit for the airbag system will then receive incorrect information that will

- cause the safety belt pretensioner to deploy unnecessarily in collisions and
- cause the front passenger airbag to deploy later in collisions in which the front airbag would otherwise be triggered earlier to help protect an unrestrained front seat passenger.
- Always remove the safety belt extender when it is not needed and stow it safely.
- Never use the safety belt extender to secure a child restraint.

WARNING

Items stored between the safety belt buckle and the center console can cause safety belt buckle to send the wrong information to the airbag control unit and prevent the Advanced Airbag System from working properly.

- Always make sure that nothing can interfere with the safety belt buckles and that they are not obstructed.

WARNING

Improper care and servicing, and improper modification and repair work, can increase the risk of personal injury and death by preventing an airbag from deploying when needed or deploying an airbag unexpectedly:

- Never repair, adjust, or change any parts of the airbag system.
- All work on the airbag system, steering wheel, instrument panel, front seats or electrical system (including the installation of audio equipment, mobile telephones and CB radios, etc.) should be performed by authorized Volkswagen dealers or authorized Volkswagen Service Facilities. They have the necessary manuals, training, and special equipment.
- The airbag system can be activated only once. After an airbag has inflated, it must be replaced.



technician who has the necessary tools and diagnostic equipment to properly replace any airbag in your vehicle and assure system effectiveness in a crash.

- Never permit salvaged or recycled airbags to be installed in your vehicle.



Undeployed airbag modules and safety belt pretensioners are classified as Perchlorate Material . Special handling may apply – see <http://www.dtsc.ca.gov/hazardouswaste/perchlorate>. Obey all applicable legal requirements regarding handling and disposal of the vehicle or parts of its restraint system, including airbag modules and safety belts with pretensioners. Authorized Volkswagen dealers and authorized Volkswagen Service Facilities are familiar with the requirements, and we recommend that you have them perform this service for you.

Notice about data recorded by the Event Data Recorder and vehicle control modules



Read and follow the introductory information and safety information first ⇒ [Introduction to the subject](#)

This vehicle is equipped with an Event Data Recorder (EDR). The main purpose of an EDR is to record, in certain crash or near crash-like situations, such as an airbag deployment or hitting a road obstacle, data that will assist in understanding how a vehicle's systems performed. The EDR is designed to record data related to vehicle dynamics and safety systems for a short period of time, typically 30 seconds or less. The EDR in this vehicle is designed to record such data as:

- How various systems in your vehicle were operating;
- Whether or not the driver and passenger safety belts were buckled/fastened;
- How far (if at all) the driver was depressing the accelerator and/or brake pedal; and,
- How fast the vehicle was traveling.

These data can help provide a better understanding of the circumstances in which crashes and injuries occur. NOTE: EDR data are recorded by your vehicle only if a non-trivial crash situation occurs; no data are recorded by the EDR under normal driving conditions and no personal data (e.g., name, gender, age, and crash location) are recorded. However, other parties, such as law enforcement, could combine the EDR data with the type of personally identifying data routinely acquired during a crash investigation.



is needed. In addition to the vehicle manufacturer, other parties, such as law enforcement, that have the special equipment, can read the information if they have access to the vehicle or the EDR.

Some state laws restrict the retrieval or downloading of data stored by EDRs installed in a vehicle for the express purpose of retrieving data after an accident or crash event without the owner's consent.

Volkswagen will not access the EDR and/or similar data or give it to others - unless the vehicle owner (or lessee if the vehicle has been leased) agrees, or;

- upon the official request by the police;
- upon the order of a court of law or a government agency; or
- for the defense of a lawsuit through the judicial discovery process.

Volkswagen may also use the data for research about vehicle operation and safety performance or provide the data to a third party for research purposes without identifying the specific vehicle or information about the identity of its owner or lessee.

NOTE: Your vehicle may be equipped with VW Car-Net. Please see ⇒ [VW Car-Net®](#) and the VW Car-Net Terms of Service and Privacy Policy at ([http:// www.vw.com/carnet](http://www.vw.com/carnet)) for details regarding how Volkswagen collects, processes, transmits, uses and shares information obtained through the VW Car-Net equipment and service.

Your vehicle is also equipped with a number of electronic control modules for various vehicle systems, such as engine management, emission control, airbags, and safety belts.

These electronic control modules record data during normal vehicle operation that may be needed by trained technicians for diagnostic and repair purposes. The recording capability of these modules is limited to data (no sound is recorded). Only a small amount of data is actually recorded over a very limited period of time, or stored when a system fault is detected by a control module. Some of the data stored may relate to vehicle speed, direction, or braking, as well as restraint system use and performance in the event of a crash. Stored data can also only be read and downloaded with special equipment that is directly connected to the vehicle.

Using a mobile phone in a motor vehicle when it is not connected to a vehicle telephone antenna: Some important things to know



subject

Mobile or cellular telephones send and receive radio waves, sometimes called radiofrequency energy (RF energy), both when they are being used and when they are in standby mode. Current scientific literature indicates that radio waves that exceed a certain level can have effects on the human body. Limits and guidelines have been established by governmental authorities and international committees in an effort to keep the electromagnetic radiation from mobile phones at levels that will not cause health problems. However, there is no scientifically based proof that wireless phones are absolutely safe.

Therefore, some experts recommend a precautionary approach regarding the use of mobile phones by taking measures that lower the personal exposure to electromagnetic fields. When using a mobile telephone inside a motor vehicle without a proper connection to an integrated vehicle telephone antenna, the personal exposure to electromagnetic fields will be higher than when using the mobile telephone while properly connected to an integrated or other outside vehicle telephone antenna.

Your vehicle may be equipped with an optional hands-free system that will permit many of the features of compatible Bluetooth[®] enabled mobile telephones to be used for greater convenience and is consistent with the laws of an increasing number of states and localities that prohibit the use of mobile telephones without some kind of hands-free device.

The hands-free system in your vehicle can be used with certain mobile phones that are connected by wire and hardware connector or via compatible Bluetooth[®] enabled phones with a cradle that is designed to fit your mobile telephone. The special cradle offers several advantages: The phone cradle must be safely secured to the base plate. Your phone is firmly attached to the instrument panel and is within reach at all times. Placing the phone in its cradle permits it to be charged, but more importantly connects the mobile phone to the vehicle's outside antenna. A mobile telephone that is properly connected to the integrated or other outside vehicle telephone antenna will lower the personal exposure to electromagnetic fields. You should also experience a better quality of service. Although a mobile telephone can be used inside your vehicle without a cradle, the phone will not be securely attached to the vehicle, will not be charged through the cradle wiring, and more importantly will not be connected to the vehicle's integrated telephone antenna. The mobile phone will also not be recharged. You might also experience more dropped calls and an overall impaired quality of the connection.

Therefore we strongly recommend that you use your mobile telephone in your vehicle only when it is



Because of the large number and variety of mobile telephones on the market and the frequency with which new models are introduced, Volkswagen does not offer cradles for mobile telephones. Please check with the manufacturer of the mobile telephone that you plan to use.

Bluetooth® is a registered trademark of Bluetooth® SIG, Inc.

WARNING

A mobile phone on the seat, instrument panel or in other places can be thrown around the inside of the vehicle during a sudden braking maneuver, a crash or other accident and injure vehicle occupants.

- Never place or attach accessories or other objects (such as cup holders, telephone brackets, note pads, navigation systems, large, heavy or bulky objects) on the doors, on the windshield, over or near the area marked AIRBAG on the steering wheel, instrument panel, backrests or between these areas and the occupant. Such objects could cause serious injury in a collision, especially if an airbag inflates.

WARNING

Using a mobile phone or CB radio inside the vehicle without a properly installed and separate outside antenna can be dangerous to your health and that of your passengers because the electromagnetic radiation energy that mobile phones and CB radios emit may be above established limits. This also applies if the outside antenna is not installed properly.

- Always keep the mobile phone antenna at least 8 in. (20 cm) away from pacemakers. Heart specialists advise that mobile phones can adversely affect the way pacemakers work.
- Never carry a mobile phone that is switched on in the breast pocket directly over a pacemaker.
- If you suspect there may be interference with a pacemaker or other medical device, switch the mobile phone off immediately.

Consumer information



Introduction to the subject

In this chapter you will find information on the following subjects:



⇒ *Radio antenna and reception*

⇒ *Component protection*

⇒ *Volkswagen service information*

WARNING

Improper vehicle care and use, as well as improper changes to the vehicle, increase the risk of accidents and injuries.

- Obey all applicable legal requirements.
- Read your Owner's Manual and heed all WARNINGS.


NOTE

Improper vehicle care and use, as well as improper changes to the vehicle, can result in damage to the vehicle.

- Obey all applicable legal requirements.
- Perform service according to the specifications in the ⇒ *Booklet Warranty and Maintenance*.
- Read your Owner's Manual and heed all WARNINGS.

Operating your vehicle outside of the United States and Canada



Read and follow the introductory information and safety information first ⇒  *Introduction to the subject*

Government regulations in the United States and Canada require that automobiles meet specific emission regulations and safety standards. Therefore, vehicles built for the U.S. and Canada differ from vehicles sold in other countries.

If you want to drive the car in another country for a short time, please see the information in ⇒ *Driving in other countries*.



the possibility that:

- Fuel with the appropriate rating for your vehicle's engine requirements may not be readily available.
- Service may be inadequate due to lack of proper service facilities, tools, or testing equipment.
- Replacement parts may not be readily available.
- DVD navigation systems for vehicles built for the United States and Canada will not necessarily work in Europe, and may not work in other countries outside of North America.


NOTE

Volkswagen is not responsible for mechanical damage that may result from substandard fuel or service or the unavailability of Genuine Volkswagen parts.

- Volkswagen is not responsible if the vehicle does not meet the respective legal requirements in other countries and continents.

Radio antenna and reception



Read and follow the introductory information and safety information first ⇒  [Introduction to the subject](#)

If the Infotainment system was installed at the factory, the radio antenna may be installed in different locations in the vehicle:

- On the inside of the rear window with the rear window defroster,
- On the inside of the rear side windows,
- On the inside of the windshield,
- On the vehicle roof.

Antennas on the insides of windows are thin wires.

NOTE

Antennas installed on the insides of windows can be damaged by abrasive objects or by corrosive



integrated antenna and never clean the antenna with corrosive or acidic cleaning agents or other chemicals.

NOTE

If retrofitting a radio or a navigation system, make sure that the vehicle's standard integrated antenna amplifier is compatible with the radio or navigation system. If not, use an additional antenna adapter. Otherwise, the antenna amplifier could be overloaded and damaged.



Operating electrical devices near the integrated windshield antenna may interfere with AM radio reception.

Component protection



Read and follow the introductory information and safety information first ⇒ [Introduction to the subject](#)

Some electronic components and control units in the vehicle may be equipped with a component protection feature, for example, the Infotainment system.

Component protection is a protective feature that helps to:

- Prevent any factory-installed parts from functioning fully if they are installed into other vehicles (for example, after theft),
- Prevent full function of components outside of the vehicle,
- Allow legitimate installation or exchange of parts and control units by a professional should they require service.

If a component protection-related message appears in the instrument cluster display or the Infotainment system display, see an authorized Volkswagen dealer or an authorized Volkswagen Service Facility for assistance.

Volkswagen service information



subject

Volkswagen service information is published as soon as possible after model introduction.

To order service information contact:

Volkswagen Technical Literature Ordering Center

www.vw.techliterature.com

WARNING

Improperly performed repairs and modifications can cause vehicle damage and malfunctions, and can impair the efficiency of driver assistance systems and the airbag system. This can lead to accidents and severe personal injuries.

- Have repairs and vehicle modifications performed by an authorized Volkswagen dealer or an authorized Volkswagen Service Facility.

Declaration of Compliance, Telecommunications and Electronic Systems

Radio Frequency Devices and Radiocommunication Equipment User Manual Notice.

Radio-based equipment

- Mobile Phone Package
- Electronic immobilizer
- Remote control vehicle key
- Keyless Access with push-button start
- Car-Net (US only)
- Park Distance Control (PDC) system
- Adaptive Cruise Control (ACC) system
- Forward Collision Warning (Front Assist) system
- Blind Spot Monitor with Rear Traffic Alert



FCC Part 15.19

These devices comply with Part 15 of the FCC Rules . Operation is subject to the following 2 conditions:

- (1) This device may not cause harmful interference, and
- (2) this device must accept any interference received, including interference that may cause undesired operation.

FCC Part 15.21

CAUTION:

Changes or modifications not expressly approved by the party responsible for compliance could void the user's authority to operate the equipment.

These devices comply with RSS-210 of Industry Canada .

Operation is subject to the following 2 conditions:

- (1) This device may not cause interference, and
- (2) this device must accept any interference, including interference that may cause undesired operation of the device.

The manufacturer is not responsible for any radio or TV interference caused by unauthorized modifications to this equipment.

Reporting Safety Defects

If you believe that your vehicle has a defect which could cause a crash or could cause injury or death, you should immediately inform the National Highway Traffic Safety Administration (NHTSA) in addition to notifying Volkswagen of America, Inc. 3800 Hamlin Road, Auburn Hills, MI 48326.

If NHTSA receives similar complaints, it may open an investigation, and if it finds that a safety defect





* This Online Owner's Manual may not include Supplements issued after the publication of the physical Owner's Manual. Please consult your physical Owner's literature. In the event of a discrepancy between the Online Owner's Manual and physical Owner's literature, the physical Owner's literature controls.

"Volkswagen" and the Volkswagen logo are registered trademarks of Volkswagen AG. © 2018 Volkswagen of America, Inc.

Administrator

NHTSA

1200 New Jersey Avenue, SE.

Washington, D.C. 20590

You can also obtain other information about motor vehicle safety from <http://www.safercar.gov>.

Engine control and emission control system



Introduction to the subject

In this chapter you will find information on the following subjects:

⇒ *Indicator lights*

⇒ *Catalytic converter*



WARNING



rious personal injury.

- Never park where parts of the hot exhaust system and catalytic converter could ignite flammable materials, such as brush, leaves, dry grass, spilled fuel, etc.
- Never apply additional undercoating or rustproofing on or near the exhaust manifold, exhaust pipes, catalytic converter, or heat shields.

WARNING

California Proposition 65 Warning

- Engine exhaust, some of its constituents, and certain vehicle components contain or emit chemicals known to the State of California to cause cancer and birth defects and reproductive harm. In addition, certain fluids contained in vehicles and certain products of component wear contain or emit chemicals known to the State of California to cause cancer and birth defects and reproductive harm.

Indicator lights



Read and follow the introductory information and safety information first ⇒ *Introduction to the subject*

Lights up Possible cause

Proper response

EPC


Engine control malfunction (Electronic Power Control).

Have engine checked immediately by an authorized Volkswagen dealer or authorized Volkswagen Service Facility.



On some vehicles, the engine speed (rpm) may be automatically limited to the engine speed shown in the instrument cluster display to help prevent the engine from overheating.

Once the engine is no longer at a critical temperature and you have briefly taken your foot off the accelerator, the engine speed limit is increased.

 Engine speed (rpm) limited (if equipped).^{a)}

If the engine speed is limited due to a malfunction in the engine management system, the **EPC** indicator light also lights up. Have the engine checked immediately by an authorized Volkswagen dealer or authorized Volkswagen Service Facility. Make sure that the engine speed does not exceed the engine speed displayed, for example, when downshifting.



Engine control/monitoring system malfunction (engine Malfunction Indicator Light - MIL)

Ease off the accelerator. Carefully drive to the nearest authorized Volkswagen dealer or authorized Volkswagen Service Facility. Have engine checked.

Flashes Possible cause

Proper response



Misfire, which can damage the catalytic converter.


Ease off the accelerator. Carefully drive to the nearest authorized Volkswagen dealer or authorized Volkswagen Service Facility. Have engine checked.

When the ignition is switched on, several warning and indicator lights come on briefly for a function check. They go out after a few seconds.

NOTE

Failure to heed warning lights or text WARNINGS can result in vehicle damage.




As long as the indicator lights  or **EPC** are on, expect engine malfunctions, increased fuel consumption, and loss of engine efficiency.

^{a)} Displayed in color on an instrument cluster with color display.

Catalytic converter



Read and follow the introductory information and safety information first ⇒  [Introduction to the](#)



The catalytic converter provides exhaust gas after-treatment to help reduce pollutants in the exhaust gas. To help ensure long service life of the exhaust system and gasoline engine catalytic converter:

- Only use unleaded fuel.
- Never completely empty the fuel tank.
- Do not exceed the correct oil level ⇒ *Engine oil*.
- Do not tow the vehicle to start it, but use a jump-start instead ⇒ *Jump-starting*.

If you experience misfires, loss of power or the engine is not running smoothly while driving, reduce speed immediately and have the vehicle checked by an authorized Volkswagen dealer or authorized Volkswagen Service Facility. Otherwise, gasoline could reach the exhaust system and get into the atmosphere. The catalytic converter could also be damaged by overheating!



Under certain engine conditions, you may smell a sulfur odor. This is not an indication of a malfunctioning emission control system. This depends upon the sulfur content of the fuel.



Owner's manual
Owner's Manual
Edition: 12.2016
ID: 5GM012723AL

Do it yourself

Practical tips

Frequently asked questions (FAQ)

If you suspect a malfunction or vehicle damage, read and follow the following advice before contacting an authorized Volkswagen dealer or an authorized Volkswagen Service Facility. You may also find helpful information under Special considerations or Checklist in the index.

Description	Possible causes, among others	Possible remedy
Engine does not start.	Vehicle battery dead.	- Perform jump-start ⇒ Jump-starting .
		- Charge vehicle battery ⇒ Vehicle battery .
	The wrong vehicle key is used.	Use a valid vehicle key ⇒ Vehicle key set .
	Fuel level too low.	Refuel ⇒ Refueling .



– Replace the battery in the remote con-

– Battery in the remote control vehicle key ⇒ *Vehicle key set*.

vehicle key is dead.

– Move closer to vehicle.

Vehicle cannot be locked or – Too far away from the vehicle

unlocked using vehicle key. (out of range).

– Synchronize vehicle key ⇒ *Vehicle key set*.

– Buttons have been pressed too

many times.

– Lock or unlock vehicle manually

⇒ *Emergency closing and opening*.

Cold engine, braking assist sys-

tems, electronic steering column

Unusual noises.

lock, electronic parking brake,

Check the Noises entry in the index.

Auto Hold.

Odd driving behavior.

Assistance systems activated.

Check the Assistance systems entry in the index.



	DSG [®] automated transmission too hot.	Stop vehicle as soon as you can safely do so.
	Vehicle battery dead.	Charge vehicle battery ⇒ Vehicle battery
Front seats cannot be adjusted with power controls.	Fuse blown.	· Check fuse and replace if necessary ⇒ Fuses .
No jack in vehicle, no spare tire, or tire mobility set in vehicle.	Equipment differs, depending on the vehicle.	No direct corrective action possible; depends on the vehicle equipment. Contact an authorized Volkswagen dealer or an authorized Volkswagen Service Facility for assistance.
Features do not work as described in this manual.	Settings were adjusted in the Volkswagen Information System.	Check and reset to factory settings if necessary ⇒ Volkswagen Information System .



- Headlights incorrectly adjusted.

- Have the headlight range adjusted by an authorized Volkswagen dealer or an authorized Volkswagen Service Facility.

Headlights do not light up

the road as they should.

- Light bulbs burned out.

- Change light bulbs ⇒ [Replacing light bulbs](#).

- Low beams not switched on.

- Switch on low beams ⇒ [Lights](#).

Vehicle battery charge too low.

Charge vehicle battery ⇒ [Vehicle battery](#).

Electrical consumers do not

work.

Remaining fuel level too low.

Refuel ⇒ [Refueling](#).

Fuse blown.

Check fuse and replace if necessary

⇒ [Fuses](#).



	- Avoid short distance driving.
- Short hauls.	
	- Drive defensively.
- Jumpy accelerator pedal.	
	- Accelerate smoothly.
Electrical loads switched on.	Switch off unnecessary loads.
	Have the malfunction corrected
Engine control malfunction.	⇒ <i>Engine control and emission control system</i> .
Fuel consumption higher than indicated.	
Tire pressure too low.	Adjust tire pressure ⇒ <i>Tires and wheels</i> .
Driving in the mountains.	No direct corrective action possible.
	- Check use.
Towing a trailer or driving with a roof rack.	
	- Remove if not in use.
Driving with heavy payload.	No direct corrective action possible.
Driving at high engine speed.	Select a higher gear.

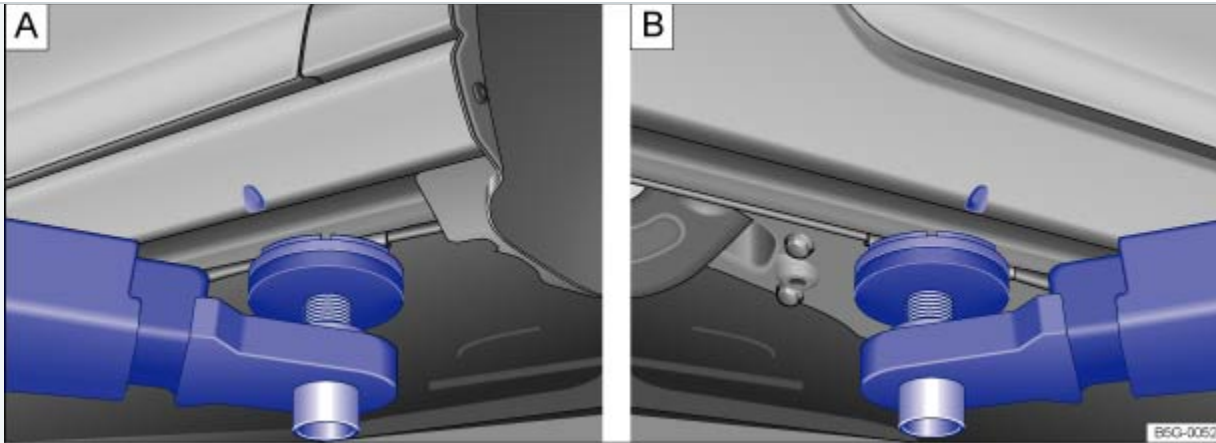


Fig. 206 : Lifting point at the front. : Lifting point at rear for lifting the vehicle using a workshop hoist or floor jack (Golf).

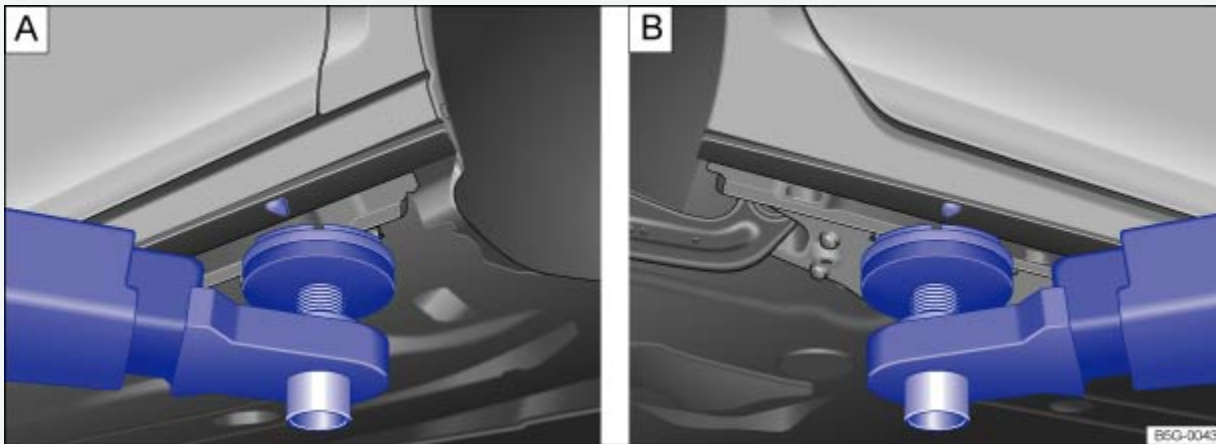


Fig. 207 : Lifting point at the front. : Lifting point at rear for lifting the vehicle using a workshop hoist or floor jack (Golf GTI, Golf R).

The vehicle may only be raised at the lift points shown in the illustration ⇒ [Fig. 206](#) or ⇒ [Fig. 207](#). If the vehicle is lifted at different points, vehicle damage ⇒ and serious injuries may occur ⇒ .

Workshop hoists that use fluid cushions (receiving platforms) must not be used for lifting the vehicle.

There are many precautions that have to be followed when lifting a vehicle on a workshop hoist or floor jack. Do not try to lift a vehicle on a workshop hoist or floor jack unless you have the training, knowledge, and experience to be able to do so safely.

Information about lifting the vehicle with a vehicle jack ⇒ [Lifting the vehicle with the vehicle jack \(Golf\)](#).



off and cause serious personal injury.

- Always read and heed the operating instructions from the floor jack manufacturer and legal regulations if necessary before using the floor jack to lift the vehicle.
- Never let anyone stay in the vehicle when it is being lifted or when it is off the ground.
- Always lift your vehicle only at the designated lift points shown in the illustration ⇒ *Fig. 206* or ⇒ *Fig. 207*. Not using the designated lift points can cause the vehicle to fall off the floor jack when heavy parts such as the engine or transmission are removed.
- Always make sure that the vehicle's lift points lie as flat as possible and centered on the carrier plates of the floor jack.
- Never start the engine when you have raised the vehicle on the floor jack. The engine vibrations and vehicle movements could knock the vehicle off the floor jack.
- If you must work under a vehicle raised on a floor jack, always make sure that the vehicle is safely supported on safety stands intended for that purpose that are strong enough to support the weight of the vehicle.
- Never use the floor jack as a ladder or step ladder.
- Always make sure that the weight of the vehicle is not heavier than the lifting capacity of the floor jack and safety stands being used.

NOTE

- To help prevent serious vehicle damage, never lift the vehicle by the engine oil pan, transmission housing, or by the front or rear axles or suspension.
- To help prevent damage to the underbody or chassis, always insert a rubber pad between the hoist and the lifting points. In addition make sure the lifting arms have enough clearance.
- The lifting arms should not touch side sills or other parts of the vehicle.

In an emergency



Introduction to the subject

In this chapter you will find information on the following subjects:

WARNING

A vehicle breakdown in traffic is dangerous and creates a great risk for you, your passengers, and others.

- Always stop the vehicle as soon as it is safe to do so. Move the vehicle a safe distance off the road where it is safe to park and, if necessary, lock all doors in an emergency. Turn on the emergency flashers and set up another warning device about 25 yards (25 meters) behind the vehicle to warn approaching traffic.
- Never leave children, disabled persons, or anyone who cannot help themselves alone in the vehicle when locking the doors. This could result in people being trapped in the vehicle in an emergency. Depending on the time of year, people trapped in the vehicle can be exposed to very high or very low temperatures.

Protecting yourself and the vehicle

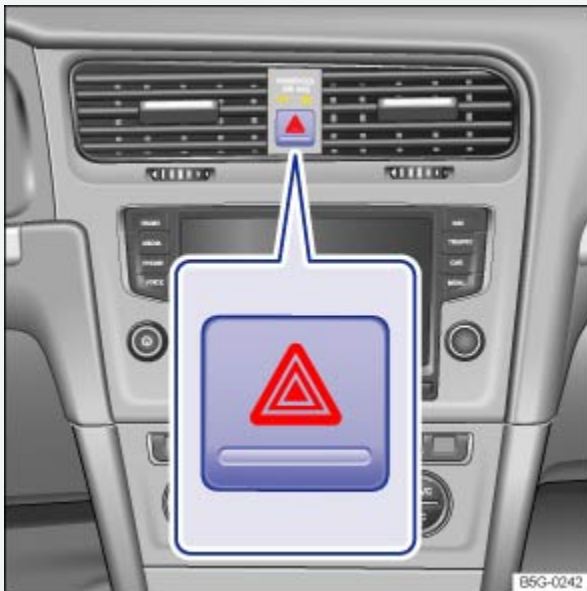


Fig. 208 In the center of the instrument panel: Button for the emergency flashers.



Read and follow the introductory information and safety information first ⇒ *Introduction to the subject*

Obey all legal requirements regarding protecting a broken-down vehicle. For example, turning on the emergency flashers and wearing a safety vest are mandatory in many countries.



For your own safety and that of your passengers, carry out the following steps in the order listed ⇒ ⚠ :

- ✓ Park the vehicle at a safe distance from traffic and on a suitable surface .
- ✓ Switch on emergency flashers by pressing the button .
- ✓ Apply the parking brake to help prevent the vehicle from moving Parking brake (Golf, Golf GTI) or Electronic parking brake (Golf R) (depending on equipment).
- ✓ Shift the transmission into Park (P) (automatic) or Neutral (manual only) Shifting.
- ✓ Stop the engine and remove the key from the ignition switch or turn off the ignition with the starter button and remove the key from the vehicle Starting and stopping the engine.
- ✓ Have all passengers exit and go to a safe location away from moving traffic, such as behind a guard rail.
- ✓ Take all vehicle keys with you when leaving your vehicle.
- ✓ Set up a warning triangle or other warning device in order to alert other motorists and cyclists.
- ✓ Let the engine cool down and get expert assistance if necessary.

If the emergency flashers are on, use the turn signal lever to indicate a direction or lane change, for example when the vehicle is being towed. This temporarily interrupts the emergency flashers.

Switch on the emergency flashers when:

- Traffic suddenly slows down or stops in front of you to warn those approaching from behind.
- In any emergency situation.
- If the vehicle breaks down.
- When being towed.

Always obey traffic laws that govern the use of emergency flashers where you are driving.

If the emergency flashers are not working, a different method – as permitted by law – must be used to alert other motorists and cyclists to the breakdown.

 **WARNING**



- Always review and follow the checklist. Follow accepted safety practices and use common sense.

WARNING

The vehicle exhaust system and the catalytic converter get very hot. They can cause fires and serious personal injury.

- Never park where parts of the hot exhaust system or catalytic converter could ignite flammable materials, such as dry grass, brush, leaves, spilled fuel, etc.

NOTE

To help prevent damage to the vehicle if you should have to push it a short distance by hand, never push against spoilers, lights, body panels, windows, or similar parts. Concentrating force on these parts of the vehicle can cause expensive damage that may not always be obvious right away.



The vehicle battery will be drained if the emergency flashers are on for a long time – even if the ignition is switched off.

Emergency closing and opening



Introduction to the subject

In this chapter you will find information on the following subjects:

⇒ *Manually unlocking and locking the driver door*

⇒ *Manually locking the passenger doors*

⇒ *Opening the trunk lid from inside the luggage compartment*

⇒ *Emergency release for the fuel filler flap*



The doors and the trunk lid can be manually locked and, in some cases, unlocked if necessary, for instance because the power locking system or the remote control vehicle key malfunctions.

WARNING

Serious injuries can result if the emergency closing and opening procedures are used carelessly.

- Never leave children, disabled persons, or anyone who cannot help themselves in the vehicle. The doors can be locked with the remote control vehicle key. This could result in people being trapped in the vehicle in an emergency.
- A closed vehicle can become very hot or very cold, depending on the season. Particularly in the summer, heat buildup in the passenger and luggage compartment of a parked vehicle can result in temperatures in the vehicle that are much higher than the outside temperatures. Temperatures can quickly reach levels that can cause unconsciousness and death, particularly to small children.

WARNING

Careless opening and closing of the doors, the trunk lid, and the power sunroof is dangerous and can cause serious personal injury.

- Open or close the doors, the trunk lid, and the power sunroof only when no one is in the way.

NOTE

To help prevent vehicle damage, carefully remove and properly reinstall parts after emergency locking or unlocking.

Manually unlocking and locking the driver door

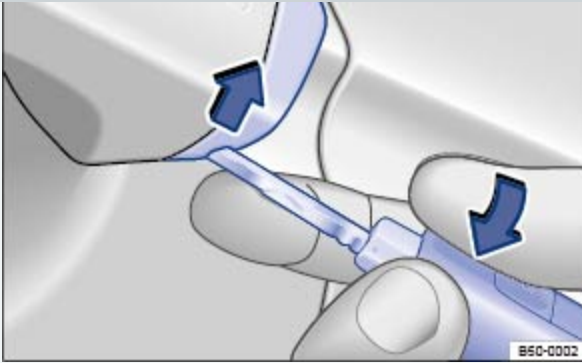



Fig. 209 Door handle on driver door: Removing the lock cylinder cover.



Read and follow the introductory information and safety information first ⇒  *Introduction to the subject*

When locking the vehicle manually, all doors are locked. To unlock the vehicle manually, turn (counter-clockwise) to the unlocking position. When the vehicle is unlocked manually, only the driver door is unlocked. Note the instructions for the anti-theft alarm system ⇒ *Power locking system*.

- Unfold the key bit from the remote control vehicle key ⇒ *Vehicle key set*.
- If the vehicle has a concealed lock cylinder, insert the key bit from below into the opening of the cover cap on the driver door ⇒ *Fig. 209* (arrow) and lift the cover cap off. Grasping the door handle and pulling slightly makes it easier to remove the cap.
- Insert the key bit into the lock cylinder of the driver door and unlock or lock the door. If the larger side of the vehicle key touches the door handle during locking or unlocking, either pull the door handle slightly or reinsert the vehicle key in the lock cylinder with the opposite side facing up.
- Reinsert the cover cap from top to bottom and press until it clicks into place. Grasping the door handle and pulling slightly makes it easier to reinstall the cap.

Special considerations when unlocking

- If the vehicle is equipped with an anti-theft alarm system, the system remains activated for the unlocked vehicle. But the alarm is not triggered at first ⇒ *Power locking system*.
- Open the driver door. The alarm will sound.
- Switch on the ignition. The electronic immobilizer recognizes a valid remote control vehicle key when the ignition is switched on and deactivates the anti-theft alarm system.



to open the door → [Unlocking or locking the vehicle from the inside.](#)



The anti-theft alarm system, when installed, is not activated when the vehicle is locked manually with the key bit ⇒ [Anti-theft alarm system.](#)

Manually locking the passenger doors



Fig. 210 On the front side of the passenger side rear door: Manual lock, covered by a rubber seal.



Fig. 211 On the front side of the passenger side rear door: Locking the vehicle with the key bit in the vehicle key.



Read and follow the introductory information and safety information first ⇒ [Introduction to the subject](#)

The passenger door and rear doors can each be locked manually. This will not activate the anti-theft alarm system, when installed.

- Remove the rubber seal on the front side of the door. The seal is marked with a lock ⇒ [Fig. 210](#) .
- Unfold the key bit from the remote control vehicle key ⇒ [Vehicle key set](#) .
- Insert the key bit into the slot ⇒ [Fig. 211](#) . On the passenger side doors, turn the key clockwise. On the driver side rear door, turn the key counterclockwise.
- Reinsert the rubber seal and completely close the door.
- Make sure that the door is locked.
- Repeat the procedure for other doors if necessary.
- Have the vehicle checked immediately by an authorized Volkswagen dealer or an authorized Volkswagen Service Facility.



The vehicle doors can be unlocked and opened separately from inside the vehicle by pulling the door handle to open the door ⇒ [Power locking system](#) .

Opening the trunk lid from inside the luggage compartment

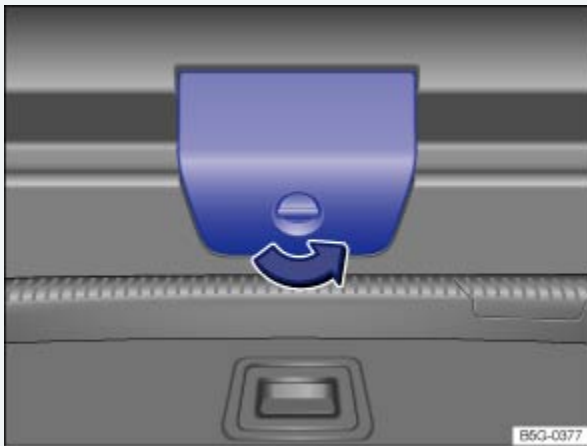


Fig. 212 Inside the luggage compartment: Cover for the trunk lid release.

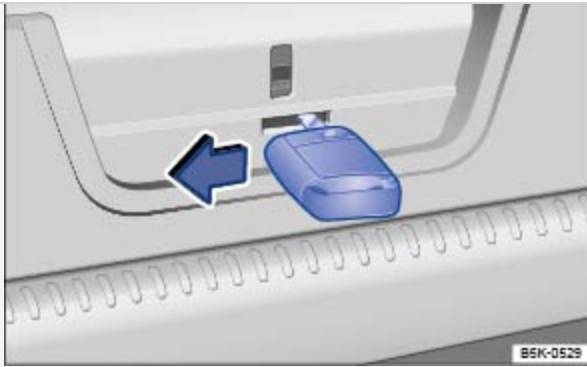


Fig. 213 Inside the luggage compartment: Opening the trunk lid.



Read and follow the introductory information and safety information first ⇒ *Introduction to the subject*

- If necessary, fold the rear seat backrest forward ⇒ *Seat functions*.
- Remove luggage in order to reach the trunk lid from the inside.
- Open the cover ⇒ *Fig. 212* by turning the release in the direction of the arrow.
- Unfold the key bit from the vehicle key fob ⇒ *Vehicle key set*.
- Insert the key into the slot on the trunk lid ⇒ *Fig. 213* and press the release lever in the direction of the arrow to unlock the trunk lid. At the same time, push the trunk lid out until it opens.

Emergency release for the fuel filler flap



Read and follow the introductory information and safety information first ⇒ *Introduction to the subject*

There is no emergency release for the fuel filler flap. Contact an authorized Volkswagen dealer or an authorized Volkswagen Service Facility for assistance.

Emergency release for the selector lever lock

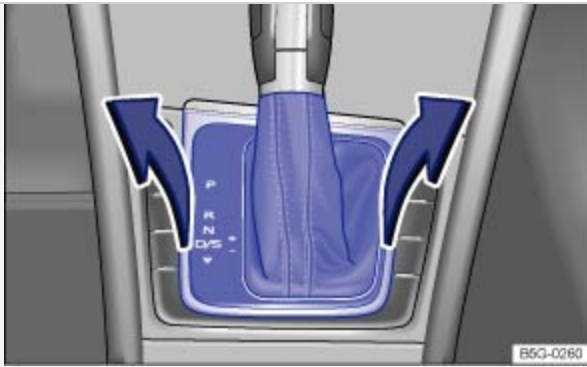


Fig. 214 Removing the selector gate cover.

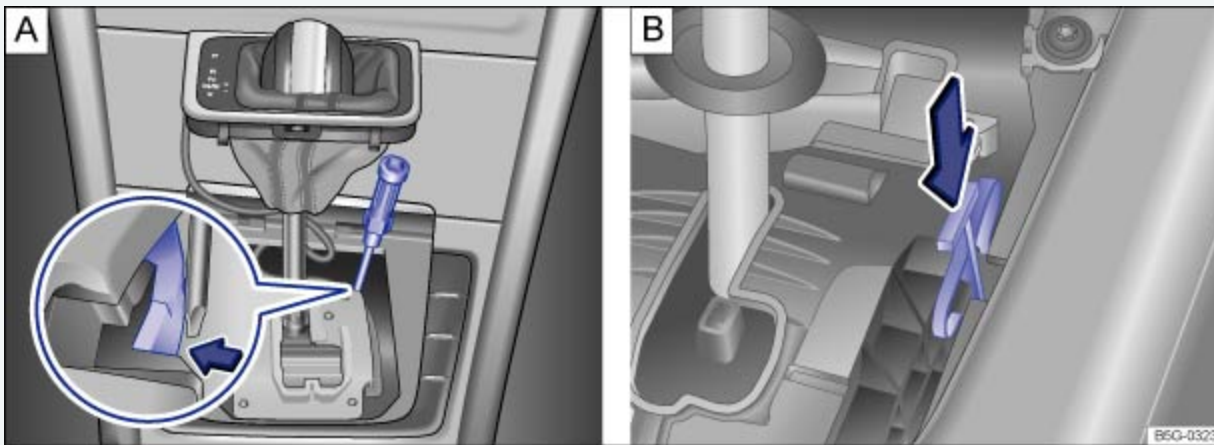


Fig. 215 Releasing the selector lever lock (versions and).



Read and follow the introductory information and safety information first ⇒ [Introduction to the subject](#)


If the power supply fails (due to a dead vehicle battery, for example) and the vehicle has to be pushed or towed, the emergency release must be used to move the selector lever to Neutral (N). You will need the screwdriver from the vehicle tool kit to release the selector lever ⇒ [Vehicle tool kit](#).

The emergency release is located under the selector gate cover on the right side when viewed in the driving direction.


Preparations

- Set the parking brake. If the parking brake cannot be set, you must find another way to help prevent the vehicle from moving.
- Switch off the ignition.




- Open the storage compartment in front of the selector lever ⇒ *Storage compartment in the front center console*.
- Using your hands, pull upward on the front of the selector lever cover to release it, then pull the selector lever sleeve upward ⇒ *Fig. 214*.
- Slip the cover up and over the selector lever ⇒ .

Emergency release for the selector lever (version A)

- With the screwdriver from the vehicle tool kit, carefully push the colored release lever ⇒ *Fig. 215*  in the direction of the arrow and hold it in this position.
- Press the release button in the selector lever handle and shift the selector lever to Neutral (N).
- Carefully press the selector gate cover back in place, making sure that the electrical wiring stays in the correct position and is not pinched or damaged.

Emergency release for the selector lever (version B)

- Using the flat blade of the screwdriver from the vehicle tool kit, carefully push down on the middle of the colored release lever ⇒ *Fig. 215*  in the direction of the arrow and hold it in this position.
- Press the release button in the selector lever handle and shift the selector lever to Neutral (N).
- Carefully press the selector gate cover back in place, making sure that the electrical wiring stays in the correct position and is not pinched or damaged.

WARNING

Never shift the transmission out of Park (P) without first firmly applying the parking brake. Otherwise, the vehicle can start to roll unexpectedly, especially on hills or inclines, and cause an accident and serious injuries.

NOTE

Even with the selector lever is in Neutral (N), the automatic transmission will be damaged if the vehicle is towed (or you let it coast) for an extended period or at high speed with the engine shut off.

Introduction to the subject

In this chapter you will find information on the following subjects:

⇒ *Storage*

⇒ *Contents*

When securing the vehicle after a breakdown, always obey all applicable legal requirements.

WARNING

Loose tools and other items in the vehicle tool kit and a loose spare (or compact spare) wheel may be thrown through the passenger compartment if you brake suddenly or steer sharply or are involved in an accident. This can cause severe injuries.

- Always make sure the vehicle tool kit and spare (or compact spare) wheel are securely stowed in the luggage compartment.

WARNING

Improper or damaged vehicle tools can lead to accidents and injury.

- Never work with tools that are damaged or not right for the job.

Storage

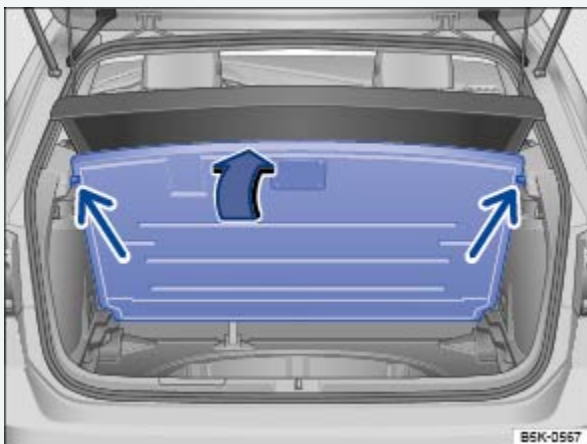


Fig. 216 In the luggage compartment: Floor covering raised and secured.

subject

The vehicle tool kit and the spare wheel, compact spare wheel, or tire mobility set may be in one of several places under the floor covering in the luggage compartment.

- If necessary, detach the luggage net.
- Lift the floor covering and secure it in the stops on either side of the luggage compartment ⇒ [Fig. 216](#) (small arrows).

NOTE

Always guide the luggage compartment floor covering back down carefully. Dropping the floor covering could damage the vehicle trim and the floor covering itself.



Completely retract the jack after use. Otherwise it will not fit in its compartment and cannot be stowed safely.

Contents

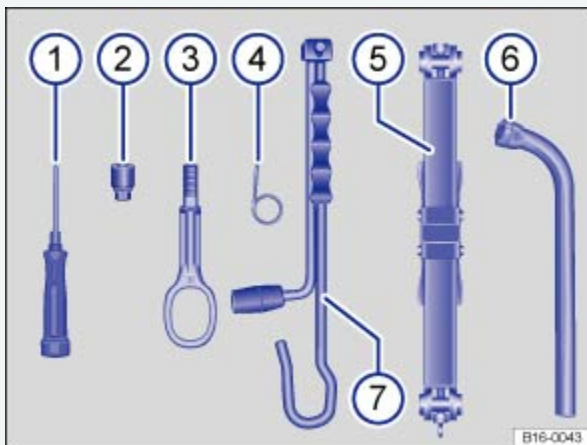


Fig. 217 Contents of the vehicle tool kit.



Read and follow the introductory information and safety information first ⇒ [Introduction to the subject](#)

The contents of the vehicle tool kit depend on the vehicle's equipment. The following describes the



Contents of the vehicle tool kit ⇒ *Fig. 217*

- ① Screwdriver with a hexagonal socket in the handle for removing or inserting previously loosened wheel bolts. The screwdriver blade is reversible. The screwdriver may be stored under the lug wrench (if equipped).
- ② Adapter for anti-theft wheel bolts (if equipped). Volkswagen recommends that you always carry the adapter for the wheel bolts in the vehicle along with the vehicle tool kit. The code number of the wheel bolt lock is imprinted on the front of the adapter. If lost, a replacement adapter can be ordered using this number. Record the code number of the wheel bolt lock and store it separately from the vehicle.
- ③ Screw-in towing eye.
- ④ Hubcap puller clip for removing hubcaps, full wheel covers, or wheel bolt caps.
- ⑤ Jack (if equipped). Before putting the jack back in the foam insert, be sure to completely crank the jack down to its original position.
- ⑥ Lug wrench (if equipped).
- ⑦ Crank (if equipped).

Maintaining the vehicle jack

The vehicle jack requires no regular maintenance. If necessary, apply multi-purpose grease to the joints of the vehicle jack.

Wheel trim



Introduction to the subject

In this chapter you will find information on the following subjects:

⇒ *Hubcaps*

⇒ *Wheel bolt caps*

⇒ *Wheel covers*



WARNING

vere injuries.

- Improperly installed wheel covers can come loose while driving and endanger other motorists and cyclists.
- Do not use damaged wheel covers.
- Always make sure that the flow of air for brake system cooling is not blocked or reduced before installing wheel covers. This applies to both factory-installed wheel covers and aftermarket wheel covers. Insufficient air supply may significantly increase stopping distance.

NOTE

To help prevent damage to the vehicle, be careful when removing wheel covers and be sure to install them properly.

Hubcaps



Fig. 218 Pulling the hubcap off.



Read and follow the introductory information and safety information first ⇒ [Introduction to the subject](#)

Depending on the vehicle model, the hubcaps can either be pulled off ⇒ [Fig. 218](#) or removed by twisting ⇒ [Fig. 219](#).

Vehicles with pull-off hubcaps

- *To remove* Take the wire clip out of vehicle tool kit and hook it into one of the holes in the hubcap ⇒ [Fig. 218](#).
- Pull the hubcap off in the direction of the arrow.
- *To install* Press the hubcap against the rim until it latches.

Vehicles with twist-off hubcaps

- *To remove* Twist the hubcap to the left or right until it loosens from the wheel rim ⇒ [Fig. 219](#).
- Grasp behind one of the lugs and pull the hubcap off.
- *To install* Push the hubcap onto the center of the rim.
- Press the hubcap against the rim until it latches.

Wheel bolt caps



[Fig. 220](#) Pulling cover caps off wheel bolts.

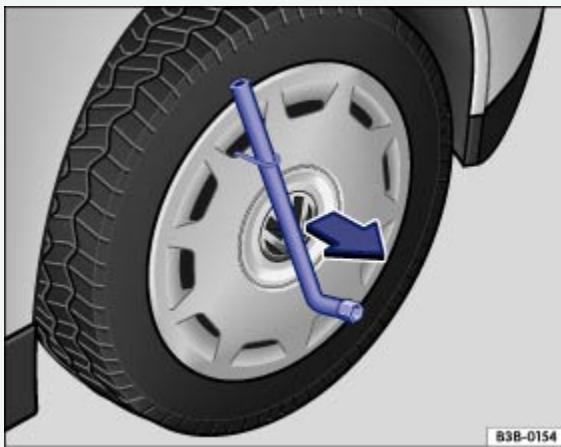
Read and follow the introductory information and safety information first ⇒ [Introduction to the subject](#)

- Insert the wire clip through the opening of the cover cap ⇒ [Fig. 220](#) and pull off in the direction of the arrow.

The caps are designed to protect the wheel bolts and should be installed again after the wheel change.

The anti-theft wheel bolt (if equipped) has a separate cap. This only fits the anti-theft wheel bolt, but not the standard wheel bolts.

Wheel covers



[Fig. 221](#) Pulling the wheel cover off.



Read and follow the introductory information and safety information first ⇒ [⚠ Introduction to the subject](#)

Pulling off the wheel cover

- Take the lug wrench (if equipped) and wire clip out of the vehicle tool kit ⇒ [Vehicle tool kit](#).
- Place the wire clip hook in one of the openings of the wheel cover.
- Slide the lug wrench through the clip ⇒ [Fig. 221](#) and pull the wheel cover off in the direction of the arrow.

Installing the wheel cover

Before installing the wheel cover, the anti-theft wheel bolt (if equipped) must be screwed into position ⇒ [Fig. 223](#) ② or ③ in relation to the position of the tire valve. Otherwise, the wheel cover cannot be installed.



onto the wheel rim. Make sure that the wheel cover is latched onto the rim along the entire circumference.

Changing a wheel



Introduction to the subject

In this chapter you will find information on the following subjects:

⇒ *Preparations for changing a wheel*

⇒ *Wheel bolts*

⇒ *Lifting the vehicle with the vehicle jack (Golf)*

⇒ *Lifting the vehicle with the vehicle jack (Golf GTI, Golf R)*

⇒ *Removing the subwoofer*

⇒ *Changing a wheel*

⇒ *After changing a wheel*

Change a wheel by yourself only if the vehicle is parked in a safe location, you are familiar with safety procedures and the technical steps, and you have proper tools available. Otherwise, get expert assistance.

The vehicle jack can only be safely used to change the wheel on a vehicle that has only one flat or damaged tire. If the vehicle does not have the support it needs from 3 fully inflated tires, the vehicle can fall off the jack. If more than 1 tire on the vehicle is flat or damaged, do not lift the vehicle with the vehicle jack. Instead, get expert assistance.

WARNING

Changing a wheel, especially on the side of the road, can be dangerous. To help reduce the risk of serious personal injury:

- Always stop the vehicle as soon as it is safe to do so. Move the vehicle a safe distance off the



- Always make sure that all passengers, especially children, are in a safe place outside the vehicle and away from the vehicle and traffic (such as behind a guard rail).
- Turn on the emergency flashers and set up another warning device about 25 yards (25 meters) behind the vehicle to warn approaching traffic.
- Change a wheel by yourself only if you are familiar with the necessary steps. Otherwise, get expert assistance.
- Always switch the engine off, firmly apply the parking brake, and shift the transmission into Park (P) (automatic transmission) or any gear (manual only) to help prevent the vehicle from moving suddenly and slipping off the jack.
- Always make sure that the ground is level and firm. If necessary, place the jack on a large and sturdy board or on a similar ground support.
- Always block the wheel diagonally opposite the wheel being changed with chocks or other similar things.
- If you are towing a trailer, always unhitch it from your vehicle before starting to change the wheel. Always apply the trailer brakes firmly and make sure the trailer cannot move unintentionally.
- Always use proper and undamaged tools when changing a wheel.
- Once a wheel is lifted off the ground, having the transmission in Park (P) or in gear will not prevent sudden vehicle movement.
- Always use a jack that has been approved by the manufacturer for your vehicle. Never use other jacks, even if they have been approved for use on other Volkswagen models.
- To reduce the risk of losing control, crashes, and serious personal injuries, never loosen the screws on rims with threaded rim rings.
- After changing a wheel, have the wheel bolt tightening torque checked with an accurate torque wrench.
- After changing a wheel or tire, reset the Tire Pressure Monitoring System ⇒ [Tire Pressure Monitoring System \(TPMS\)](#).

Preparations for changing a wheel



subject

Checklist

Getting ready to change a wheel. Follow these steps in the order listed here ⇒ ⚠ :

- ✓ If you have a flat tire, move as far away from traffic as possible. Park the vehicle on a flat and level surface where no part of the hot catalytic converter and exhaust system can come into contact with flammable materials under the vehicle, such as dry grass, brush, spilled fuel, etc.
- ✓ Set the parking brake to help prevent the vehicle from moving Parking brake (Golf, Golf GTI) or Electronic parking brake (Golf R) (depending on equipment).
- ✓ Automatic transmission: Shift the transmission into Park (P) Shifting.
- ✓ Stop the engine and remove the key from the ignition switch or turn off the ignition with the starter button and remove the key from the vehicle Starting and stopping the engine.
- ✓ Manual transmission: Engage a gear Shifting.
- ✓ Have all passengers exit and go to a safe place, such as behind a guard rail.
- ✓ Block the diagonally opposite wheel with chocks or other suitable things.
- ✓ If towing a trailer: Unhitch the trailer from the vehicle and park the trailer properly.
- ✓ If the luggage compartment is loaded: Remove the luggage.
- ✓ Raise and secure the luggage compartment floor.
- ✓ If applicable: Remove the subwoofer Removing the subwoofer.
- ✓ Unscrew the fastening screw with washer counterclockwise and remove.
- ✓ Take the spare or compact spare wheel and the vehicle tool kit out of the luggage compartment.
- ✓ Take off the wheel covers Wheel trim.

WARNING

Disregarding the safety-related checklist may lead to accidents and serious personal injuries.

- Always review and follow the checklist. Follow accepted safety practices and use common sense.



Fig. 222 Changing a wheel: Loosening the wheel bolts.

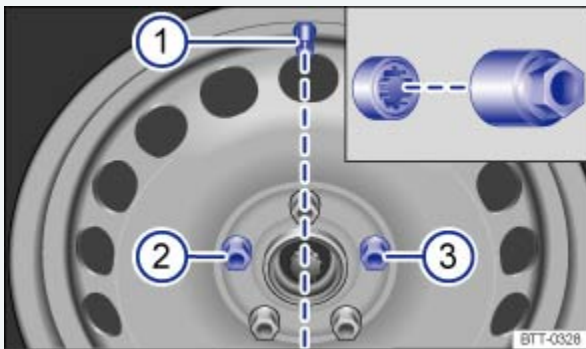



Fig. 223 Changing a wheel: Tire valve ① and installation points for the anti-theft wheel bolt (if equipped) ② or ③.




Read and follow the introductory information and safety information first ⇒  [Introduction to the subject](#)

Loosen the wheel bolts only with the lug wrench produced by Volkswagen for your vehicle.


Loosen the wheel bolts only about 1 turn before lifting the vehicle with the jack.

If a wheel bolt does not come loose, carefully push the end of the lug wrench with your foot. Make sure you are standing firmly on the ground and hold on to the vehicle for support.

Loosening the wheel bolts

- Push the lug wrench over the wheel bolt all the way ⇒ [Fig. 222](#).
- Holding the lug wrench at the end, loosen the wheel bolt by turning it counterclockwise about 1 complete turn (360°) ⇒ .






- Take the adapter for the anti-theft wheel bolt out of the vehicle tool kit.
- Push the adapter all the way over the anti-theft wheel bolt.
- Slide the lug wrench onto the adapter until it stops.
- Holding the lug wrench at the end, loosen the wheel bolt by turning it counterclockwise about 1 complete turn (360°) ⇒  .

Important information regarding wheel bolts

The design of rims and wheel bolts is matched to the factory-installed wheels. If different wheels are installed, wheel bolts with the right length and bolt head shape must be used. The attachment of the wheels and function of the brake system depend on this.

It may not be possible to use wheel bolts from different vehicles of the same model.

On a wheel with a wheel cover, the anti-theft wheel bolt (if equipped) must be installed at points ⇒ [Fig. 223](#)  or  in relation to the position of the tire valve . Otherwise, the wheel cover cannot be installed.

Wheel bolt tightening torque

Correctly tightened bolts for steel and alloy wheel rims should have a torque of 88 ft-lbs (120 Nm) . After changing a wheel, have the wheel bolt tightening torque checked right away with an accurate torque wrench.

Before you check the tightening torque, replace corroded and difficult-to-turn wheel bolts and clean the threads in the wheel hub.

Never grease or oil the wheel bolts and the threads in the wheel hubs. The bolts can come loose while driving if greased or oiled, even if tightened to the required torque.

WARNING

Improperly tightened wheel bolts can come loose while driving and cause you to lose control over the vehicle, resulting in accidents and serious injuries.

- Only use wheel bolts that belong your vehicle and to the wheel being installed.
- Never use different wheel bolts.

grease.

- Only use the lug wrench produced by Volkswagen for your vehicle to loosen the wheel bolts.
- Loosen the wheel bolts only about 1 turn before lifting the vehicle with the jack.
- Never grease or oil the wheel bolts and the threads in the wheel hubs. The bolts can come loose while driving if greased or oiled, even if tightened to the required torque.
- Never loosen bolted connections on wheel rims with bolted rim rings.
- If the wheel bolts are not tightened to the proper torque, the wheel can come off the vehicle when it is moving. Extremely high torque can damage the wheel bolts and/or their threads.

Lifting the vehicle with the vehicle jack (Golf)

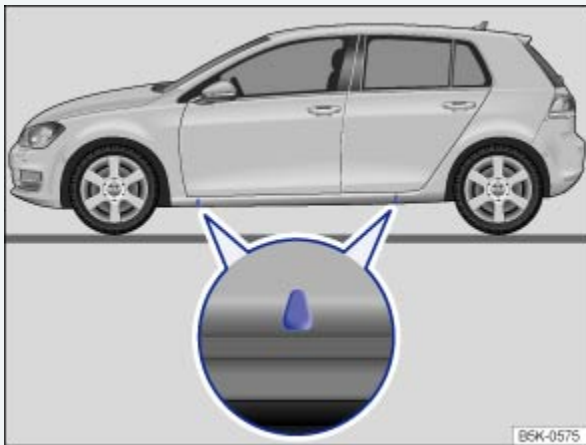


Fig. 224 Lift points for the jack.

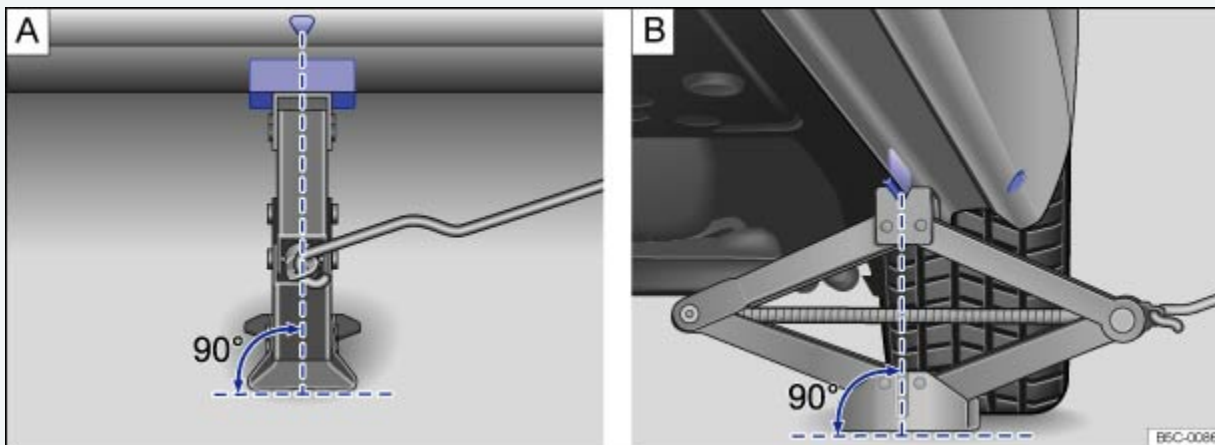


Fig. 225 Jack in position at the left rear lift point.



Read and follow the introductory information and safety information first ⇒ [Introduction to the subject](#)



body (2 on each side as shown in [⇒ Fig. 224](#)). You must use the lift point closest to the wheel being changed [⇒ ⚠](#).

The vehicle may only be lifted by a jack positioned at one of the 4 jack lift points.

Checklist

For your own safety and that of your passengers, carry out the following steps in the order listed [⇒ ⚠](#) :

- ✓ Find a level spot on firm ground for lifting the vehicle.
- ✓ Switch off the engine. Automatic transmission: shift the transmission into Park (P) Automatic transmission: Selector lever. Manual transmission only: shift into a gear Manual transmission: Gearshift lever. Then firmly apply the parking brake to help prevent the vehicle from moving Braking and parking.
- ✓ If towing a trailer: Unhitch the trailer from the vehicle and park the trailer properly.
- ✓ Straighten the steering wheel so that the front wheels point straight forward.
- ✓ Block the diagonally opposite wheel with chocks or other suitable things.
- ✓ Loosen the wheel bolts of the wheel to be changed Wheel bolts.
- ✓ Find the jack lift point on the vehicle frame that is closest to the wheel to be changed.
- ✓ Insert the crank ⑦ into the opening on the vehicle jack ⑤.
- ✓ Crank up the jack so that it still just fits underneath the lift point.
- ✓ Position the jack so that its base is directly underneath the lift point , making sure that the entire base of the jack rests securely on the ground.
- ✓ Align the jack and wind up the jack claw at the same time, until the claw cradles the vertical rib underneath the vehicle (arrow).
- ✓ Continue cranking up the jack until the wheel is just a little off the ground.

WARNING

Improper use of your vehicle jack can cause the vehicle to fall off the jack leading to serious personal injury. To help reduce the risk of serious personal injury:



proved for other Volkswagen models, but not for your vehicle.

- Always set up the jack on firm and level ground. The vehicle may slip off the jack if the jack is resting on soft or sloping ground. If necessary, place a sturdy board under the jack.
- On a hard, slippery surface (such as a tiled floor), use an anti-skid rubber mat or something similar to help prevent the jack from slipping.
- Position the jack only at the described vehicle lift points. Before you raise your vehicle, always make sure the jack claw properly grips the vertical rib under the sill so that the jack does not slip off when you are raising the vehicle ⇒ *Fig. 225*.
- Never have any part of your body (such as your arm or leg) under the vehicle when it is supported by the jack. Never let other persons have any part of their body under the vehicle, either!
- If you must work under a vehicle raised on a floor jack, always make sure that the vehicle is safely supported on safety stands intended for that purpose that are strong enough to support the weight of the vehicle.
- Never lift the vehicle when it is tilted or inclined to one side or the engine is running.
- Never lift the vehicle when more than 1 tire is flat or damaged.
- Do not start the engine while the vehicle is supported by a jack. Engine vibrations may cause the vehicle to slip off the jack.

WARNING

Disregarding the safety-related checklist may lead to accidents and serious personal injuries.

- Always review and follow the checklist. Follow accepted safety practices and use common sense.

Lifting the vehicle with the vehicle jack (Golf GTI, Golf R)



Fig. 226 Lift points for the jack.

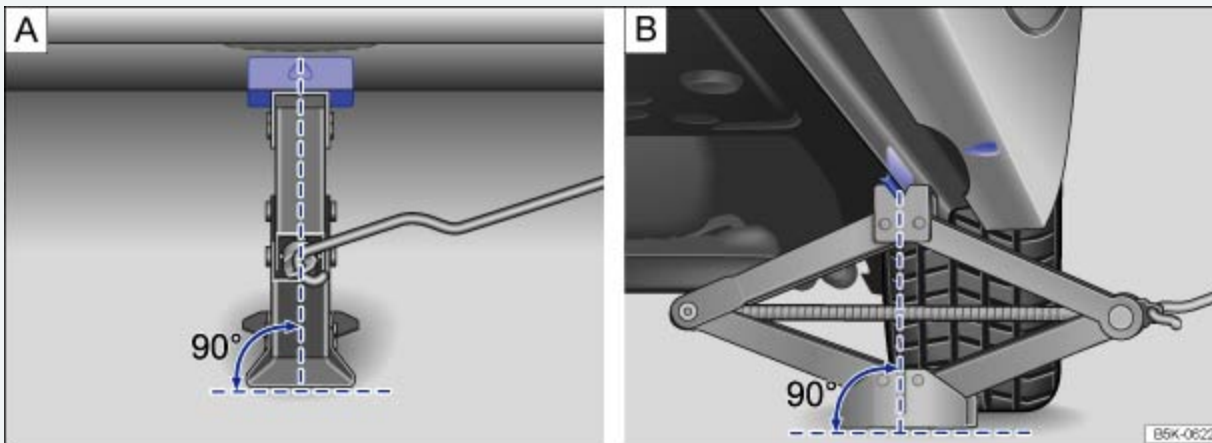


Fig. 227 Jack in position at the left rear lift point.



Read and follow the introductory information and safety information first ⇒ *Introduction to the subject*

If your vehicle is equipped with a tire mobility set instead of a vehicle jack, please see ⇒ *Tire mobility set* for instructions on sealing and inflating a tire with the tire mobility set.

The jack must be positioned at one of the 4 lift points located behind the markings on the vehicle body (2 on each side as shown in ⇒ *Fig. 226*). You must use the lift point closest to the wheel being changed ⇒ .

The vehicle may only be lifted by a jack positioned at one of the 4 jack lift points.

Checklist

For your own safety and that of your passengers, carry out the following steps in the order listed ⇒ :



- ✓ Switch off the engine. Automatic transmission: shift the transmission into Park (P) Automatic transmission: Selector lever. Manual transmission only: shift into a gear Manual transmission: Gearshift lever. Then set the parking brake to help prevent the vehicle from moving Parking brake (Golf, Golf GTI) or Electronic parking brake (Golf R) (depending on equipment).
- ✓ If towing a trailer: Unhitch the trailer from the vehicle and park the trailer properly.
- ✓ Straighten the steering wheel so that the front wheels point straight forward.
- ✓ Block the diagonally opposite wheel with chocks or other suitable things.
- ✓ Loosen the wheel bolts of the wheel to be changed Wheel bolts.
- ✓ Find the jack lift point on the vehicle frame that is closest to the wheel to be changed.
- ✓ Insert the crank ⑦ into the opening on the vehicle jack ⑤.
- ✓ Crank up the jack so that it still just fits underneath the lift point.
- ✓ Position the jack so that its base is directly underneath the lift point , making sure that the entire base of the jack rests securely on the ground.
- ✓ Align the jack and wind up the jack claw at the same time, until the claw cradles the vertical rib underneath the vehicle (arrow).
- ✓ Continue cranking up the jack until the wheel is just a little off the ground.

WARNING

Improper use of your vehicle jack can cause the vehicle to fall off the jack leading to serious personal injury. To help reduce the risk of serious personal injury:

- Use only jacks approved by Volkswagen for the vehicle. Other jacks might slip, even those approved for other Volkswagen models, but not for your vehicle.
- Always set up the jack on firm and level ground. The vehicle may slip off the jack if the jack is resting on soft or sloping ground. If necessary, place a sturdy board under the jack.
- On a hard, slippery surface (such as a tiled floor), use an anti-skid rubber mat or something similar to help prevent the jack from slipping.
- Position the jack only at the described vehicle lift points. Before you raise your vehicle, always make sure the jack claw properly grips the vertical rib under the sill so that the jack does not slip off when you are raising the vehicle ⇒ [Fig. 227](#).

ported by the jack. Never let other persons have any part of their body under the vehicle, either!

- If you must work under a vehicle raised on a floor jack, always make sure that the vehicle is safely supported on safety stands intended for that purpose that are strong enough to support the weight of the vehicle.
- Never lift the vehicle when it is tilted or inclined to one side or the engine is running.
- Never lift the vehicle when more than 1 tire is flat or damaged.
- Do not start the engine while the vehicle is supported by a jack. Engine vibrations may cause the vehicle to slip off the jack.

WARNING

Disregarding the safety-related checklist may lead to accidents and serious personal injuries.

- Always review and follow the checklist. Follow accepted safety practices and use common sense.

Removing the subwoofer

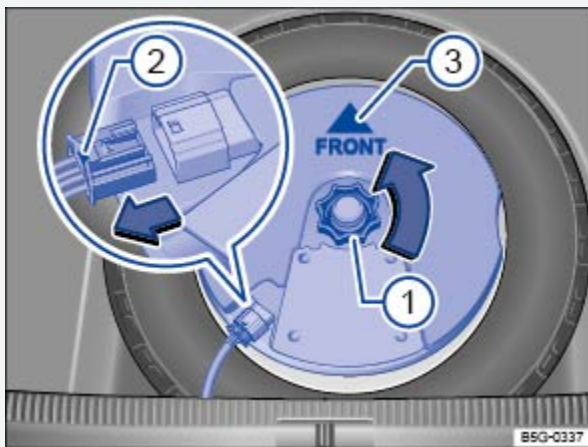


Fig. 228 Under the luggage compartment floor: Subwoofer (if equipped).



Read and follow the introductory information and safety information first ⇒ [Introduction to the subject](#)

The subwoofer, if equipped, is located under the luggage compartment floor and must be removed to access the spare wheel.

Follow these steps in the order listed:

- ✓ Raise and secure the luggage compartment floor Storage.
- ✓ Unscrew the handwheel ① in a counterclockwise direction (arrow).
- ✓ To release the connector, press and hold the center tab down with one hand ②.
- ✓ With the other hand, grasp the connector on both sides, and carefully pull the connector out of the socket in the direction of the arrow (magnified view). Put the electric cable aside.
- ✓ Remove the subwoofer carefully and place in a clean storage location.

Checklist

- ✓ Reinstall the subwoofer carefully back into the recess. The tip of the arrow symbol FRONT on the subwoofer ③ must point toward the front of the vehicle
- ✓ Insert the connector ② into the socket until it clicks into place.
- ✓ Turn the handwheel ① clockwise to secure the subwoofer.
- ✓ Carefully lower the luggage compartment floor back into place.

Changing a wheel



Fig. 229 Changing a wheel: Remove previously loosened wheel bolts using the screwdriver handle.

Read and follow the introductory information and safety information first ⇒ *Introduction to the subject*


Removing the wheel



- Loosen the wheel bolts ⇒ *Wheel bolts*.
- Lift the vehicle ⇒ *Lifting the vehicle with the vehicle jack (Golf)* or ⇒ *Lifting the vehicle with the vehicle jack (Golf GTI, Golf R)*.
- Completely unscrew and remove the previously loosened wheel bolts using the hexagonal socket in the screwdriver handle ⇒ *Fig. 229*. Place the wheel bolts on a clean surface.
- Remove the wheel.

Mounting a spare or compact spare wheel

If the tire is a unidirectional tire, be sure to install it in the proper rolling direction ⇒ *Tires and wheels*.

- Place the spare wheel or compact spare wheel on the axle.
- Place the anti-theft wheel bolt (if equipped) in position ⇒ *Fig. 223* ② or ③ in relation to the position of the tire valve ①. Hand tighten it using the adapter by turning clockwise.
- Screw in the wheel bolts clockwise and tighten them *slightly* using the hexagonal socket in the screwdriver handle.
- Lower the vehicle with the jack.
- Use the lug wrench to firmly tighten all wheel bolts (turn clockwise) ⇒ . Do not tighten them in sequence! Tighten any wheel bolt to begin, then tighten the wheel bolt diagonally opposite the first bolt, and so forth.
- Install the wheel bolt caps, center wheel hubcap, or wheel cover, if any ⇒ *Wheel trim*.

WARNING

Wheel bolts that are tightened or installed improperly can come loose, causing loss of vehicle control, a crash, and serious personal injury.

- Always keep wheel bolts and threads in the wheel hub clean and free of oil and grease. The wheel bolts must turn easily and must be tightened with the right torque.
- Use the hexagonal socket in the screwdriver handle only to turn the wheel bolts when they are loose, never to loosen them or tighten them firmly.

WARNING



dent, and serious personal injury.

- Never use a compact spare wheel if it is damaged or worn down to the wear indicators.
- Never drive faster than 50 mph (80 km/h) with a compact spare wheel. Avoid full-throttle acceleration, heavy braking, and fast cornering!
- Never drive more than 125 miles (200 km) with a compact spare wheel that is installed on the front axle (drive axle).
- Replace the compact spare with a normal wheel and tire as soon as possible. Compact spare tires are designed for brief use only.

After changing a wheel



Read and follow the introductory information and safety information first ⇒ [Introduction to the subject](#)

- Clean the tools in the vehicle tool kit if necessary and stow them in the foam insert in the luggage compartment ⇒ [Vehicle tool kit](#).
- Securely store the spare wheel, compact spare wheel, or the wheel you took off the vehicle in the luggage compartment.
- Have the wheel bolt tightening torque immediately checked with a torque wrench ⇒ [Wheel bolt tightening torque](#).
- Have the damaged wheel replaced as soon as possible.



The Tire Pressure Monitoring System must be recalibrated after each tire change ⇒ [Tire Pressure Monitoring System \(TPMS\)](#).

Tire mobility set



Introduction to the subject

In this chapter you will find information on the following subjects:

⇒ [Contents of the tire mobility set](#)



⇒ *Sealing and inflating the tire*

⇒ *Check after 10 minutes of driving*

Your vehicle is equipped with a tire mobility set instead of a spare tire.

Tire damage caused by foreign objects or punctures up to about 3/16 in (4 mm) in diameter can be reliably sealed using the tire mobility set. Do not remove the foreign object (screw or nail, for example) from the tire!

After the sealant is filled into the tire, drive for about 10 minutes and check tire pressure again.

Never use the tire mobility set to fill a tire unless all of the following requirements have been met:

- The vehicle is parked at a safe spot.
- You are familiar with all the necessary procedures and safety precautions.
- You have the correct tire mobility set.

Otherwise, get expert assistance.

Tire sealant must not be used:

- If the wheel rim is damaged.
- At outside temperatures below -4 °F (-20 °C).
- If the cut or puncture damage of the tire is greater than 3/16 in. (4 mm) in diameter.
- If you were driving with very low tire pressure or a flat tire.
- If the tire inflation cylinder has passed its expiration date or if the cylinder is damaged.

⚠ WARNING

Using the tire mobility set on the side of the road can be dangerous. To help reduce the risk of serious personal injury:

- Always stop the vehicle as soon as it is safe to do so and move the vehicle a safe distance off the road where it is safe to use the tire mobility set.



- All passengers and especially children must stay a safe distance away from you while you are working and keep out of the area you are working in.
- Turn on the emergency flashers and set up another warning device about 25 yards (25 meters) behind the vehicle to warn approaching traffic.
- Use the tire mobility set only if you are familiar with the necessary steps. Otherwise, contact an authorized Volkswagen dealer or authorized Volkswagen Service Facility for assistance.
- Use the tire mobility set only in emergencies and only until you can get professional help.
- Immediately replace a tire repaired with the tire mobility set according to the manufacturer's specifications and with a tire matching the currently installed tires.
- Sealant is harmful and must immediately be removed in case of skin contact.
- Always store the tire mobility set out of reach of children.
- Never use a vehicle jack, even if the jack is approved for use with your vehicle.
- Always switch off the engine, engage the parking brake, and shift the transmission into Park (P) to help prevent the vehicle from moving unexpectedly.

WARNING

Improper use of the tire mobility set can cause a temporary tire to fail and lead to loss of vehicle control and serious personal injuries.

- Always remember that a tire filled with sealant does not handle as well as an undamaged tire without sealant.
- Never drive faster than 50 mph (80 km/h) with a sealed tire.
- Never use the tire mobility set if the outside temperature is below -4 °F (-20 °C).
- Never drive with a tire that has cuts or punctures, especially when they are larger than 3/16 in. (4 mm).
- Use the tire mobility set only for emergencies until you can get professional help.
- If the tire cannot be inflated to at least 29 psi (200 kPa), do not drive the vehicle. Contact the nearest authorized Volkswagen dealer, authorized Volkswagen Service Facility, or other qualified workshop for assistance.
- If the tire inflation pressure drops below 26 psi (180 kPa) after driving for 10 minutes, do not

Volkswagen Service Facility, or other qualified workshop for assistance.

- Always replace a tire repaired with the tire mobility set immediately. Do not drive a tire that has been repaired with the tire mobility set longer or farther than is absolutely necessary.
- Avoid full throttle acceleration, hard braking, and fast cornering.
- Drive at slow speed for 10 minutes. Then get out and check the air pressure and condition of the sealed tire.

Obey all legal requirements when disposing of used or expired sealant.



New tire inflation cylinders are available from authorized Volkswagen dealers and authorized Volkswagen Service Facilities.



Read the separate user manual from the manufacturer of the tire mobility set.

Contents of the tire mobility set

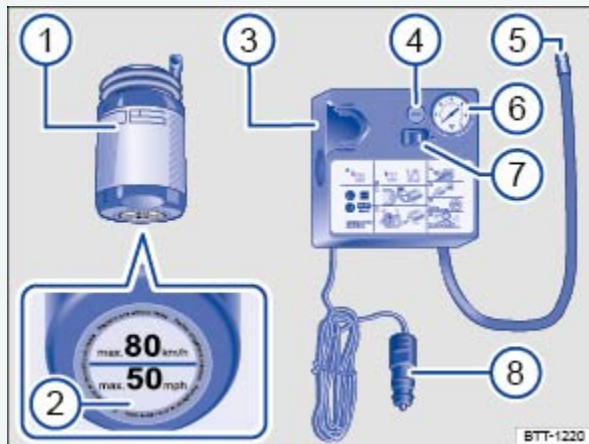


Fig. 230 Basic diagram: Contents of the tire mobility set.



Read and follow the introductory information and safety information first ⇒ *Introduction to the subject*

The tire mobility set may be stored in one of several places in the luggage compartment (for example, in the side storage compartment or under the floor covering). It contains the following ⇒ *Fig. 230*:



- ② Label (on the bottom of the tire inflation cylinder) with speed instruction
max. 80 km/h/max. 50 mph
- ③ Air compressor
- ④ Air release valve
- ⑤ Inflation hose
- ⑥ Tire pressure gauge
- ⑦ ON/OFF switch²⁾
- ⑧ 12 Volt plug

1) May also be integrated in the compressor.

2) May also be located on the side of the compressor.

Preparations



Read and follow the introductory information and safety information first ⇒ *Introduction to the subject*

Checklist

Carry out the following steps in the order listed before starting to inflate a tire ⇒ :

- ✓ If you have a flat tire, move the vehicle as far away from traffic as possible. Park the vehicle on a flat, level surface at a safe spot.
- ✓ Apply the parking brake to help prevent the vehicle from moving Braking and parking.
- ✓ Move the selector lever into Park (P) Shifting.
- ✓ Stop the engine and remove the key from the ignition switch Starting and stopping the engine.
- ✓ Have all passengers exit and go to a safe place, such as behind a guard rail.
- ✓ Switch on emergency flashers and use a warning triangle or other device to warn oncoming traffic In an emergency. Observe all legal requirements.
- ✓ Check whether a repair with the tire mobility set is possible Tire sealant must not be used:.
- ✓



- ✓ Remove the tire mobility set from the luggage compartment.
- ✓ Affix the label ② from the bottom of the tire inflation cylinder to the dashboard in the driver's field of vision, making sure the label does not cover the instrument cluster or other warning lights and signals on the instrument panel.
- ✓ Do not remove the foreign object (screw or nail, for example) from the tire!


WARNING

Disregarding the safety-related checklist may lead to accidents and serious injuries.



- Always review and follow the checklist. Follow accepted safety practices and use common sense.

Sealing and inflating the tire



Read and follow the introductory information and safety information first ⇒  [Introduction to the subject](#)

Sealing and inflating the tire

- Unscrew the valve cap from the tire valve.
- Vigorously shake the tire inflation cylinder ⇒ [Fig. 230①](#) a few times back and forth.
- Tightly screw the inflation hose on the air compressor ⇒ [Fig. 230②](#) to the valve on the top of the sealant cylinder.
- Tightly screw the filling hose from the tire inflation cylinder ⇒ [Fig. 230①](#) to the tire valve.
- Hold the cylinder with the bottom pointing up and insert the top of the cylinder into the notch in the air compressor ⇒ [Fig. 230③](#).
- Place the air compressor (with cylinder) on a flat surface.
- Insert the 12 Volt plug ⇒ [Fig. 230④](#) into one of the vehicle's 12 Volt sockets ⇒ [Power outlets](#).
- Switch the air compressor on using the ON/OFF switch ⇒ [Fig. 230⑤](#).
- Let the air compressor run until a pressure of 29–36 psi (200–250 kPa) is reached ⇒  .
Maximum run time 8 minutes ⇒  .
- Switch off the air compressor.



valve. Continue driving right away and drive at a speed of no more than 50 mph (80 km/h).

- Pull over to a safe location and check tire pressure again after 10 minutes of driving ⇒ *Check after 10 minutes of driving*.

If an air pressure of 29–36 psi (200–250 kPa) cannot be reached

- If an air pressure of 29–36 psi (200–250 kPa) cannot be reached, unscrew the filling hose from the tire valve.
- Drive about 30 feet (10 meters) forward or in reverse so that the sealant can be distributed inside the tire.
- Connect the tire inflation hose of the air compressor directly to the tire valve and repeat the inflation process.
- If a tire pressure of 29–36 psi (200–250 kPa) is reached, unscrew the inflation hose from the tire valve. Continue driving right away and drive at a speed of no more than 50 mph (80 km/h). Check the tire pressure again after 10 minutes of driving ⇒ *Check after 10 minutes of driving*.
- If the required tire pressure still cannot be reached, the tire is too badly damaged. The tire cannot be sealed using the tire mobility set. Do not drive the vehicle. Contact an authorized Volkswagen dealer, authorized Volkswagen Service Facility, or other qualified workshop for assistance ⇒ ⚠.

WARNING

The tire inflation hose and air compressor can get hot during inflation.

- Protect hands and skin from hot parts.
- Do not place the hot tire inflation hose or hot air compressor on flammable material.
- Let the equipment cool off almost completely before stowing it.
- If the tire cannot be inflated to at least 29 psi (200 kPa), the damage is too great to be repaired with the tire mobility set. The sealant is not able to seal the tire. Do not drive the vehicle. Contact an authorized Volkswagen dealer, authorized Volkswagen Service Facility, or other qualified workshop for assistance.

NOTE



Let the compressor cool down for a few minutes before switching it on again. Let it cool down almost completely before stowing it in the repair kit.

Check after 10 minutes of driving



Read and follow the introductory information and safety information first ⇒ [Introduction to the subject](#)

Connect the inflation hose ⇒ [Fig. 230](#) from the air compressor to the tire valve and read the tire pressure on the tire pressure gauge ⑥.

19 psi (130 kPa) and lower:

- Stop! The tire cannot be sealed sufficiently using the tire mobility set.
- Contact an authorized Volkswagen dealer, authorized Volkswagen Service Facility, or other qualified workshop for assistance ⇒ .

20 psi (140 kPa) and higher:

- Correct the tire pressure again to the proper value ⇒ [Tires and wheels](#) .
- Carefully drive on to the nearest authorized Volkswagen dealer, authorized Volkswagen Service Facility, or other qualified workshop at a speed of no more than 50 mph (80 km/h).
- Have the damaged tire replaced.

WARNING

Driving with a tire that cannot be sealed is dangerous and can cause accidents and serious injuries.

- Do not continue driving if the tire pressure is 19 psi (130 kPa) or lower.
- Contact an authorized Volkswagen dealer, authorized Volkswagen Service Facility, or other qualified workshop for assistance.

Fuses



In this chapter you will find information on the following subjects:

⇒ *Fuses in the vehicle*

⇒ *Replacing blown fuses*

Due to ongoing development of the vehicle, configuration-dependent allocation of fuses and the combined fuse protection of multiple loads with one fuse, an up-to-date overview of the fuse location per load is not possible at the time of printing. Detailed information regarding fuse box layout is available from authorized Volkswagen dealers and authorized Volkswagen Service Facilities.

In general, one fuse can protect several loads. One load can also be protected by several fuses.

Find out why the fuse blew and correct the problem before replacing a blown fuse. If a newly replaced fuse blows again after a short time, the electrical system should be checked by an authorized Volkswagen dealer or an authorized Volkswagen Service Facility.

WARNING

High voltage systems in the engine compartment can cause electrical shocks, severe burns, and even death!

- Never touch ignition cables. Never touch other components of the high voltage electronic ignition system.
- Avoid short circuits in the electrical system.

WARNING

Using the wrong fuse, using a blown fuse that has been repaired, and using metal objects in place of fuses to complete the electrical connection in the circuit can cause fires and serious personal injury.

- Never replace a fuse with one that has a higher amp rating. Replace a blown fuse only with a fuse of the same amperage (same color and same imprint) and same overall size.
- Never repair fuses.
- Never replace fuses with a metal strip, a paper clip, or a similar object.

- To help prevent damage to the electrical system, switch off all lights and accessories, switch off the ignition, and remove the key from the ignition switch (if applicable) before replacing a fuse.
- If a fuse is replaced with a fuse with higher amperage, this can also cause damage at different locations in the electrical system.
- Open fuse boxes must be protected from dirt and moisture. Dirt and moisture in fuse boxes can cause damage to the electrical system.

Fuses in the vehicle



Fig. 231 On the driver side in the instrument panel: Fuse box cover.

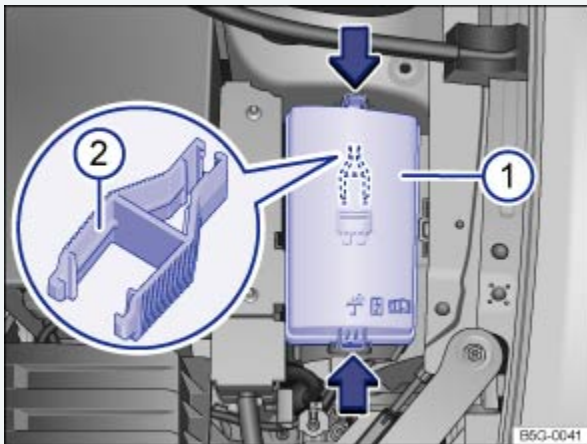


Fig. 232 In the engine compartment: Fuse box cover ① with tweezers ②.



Read and follow the introductory information and safety information first ⇒ *Introduction to the subject*



overall size.

Fuse types

- Regular blade fuse (ATO[®]).
- Mini blade fuse (MINI[®]).
- Cartridge fuse (JCASE[®]).

Fuse color coding

Color	Current strength in amps	Current strength in amps
	(ATO [®] / MINI [®])	(JCASE [®])
Black	1	—
Light brown	5	—
Brown	7.5	—
Red	10	50
Blue	15	20
Yellow	20	60
White or clear	25	—
Green	30	40
Orange	40	—




	(ATO®/MINI®)	(JCASE®)
Pink	30	30

Opening the fuse box in the instrument panel

- Pull the lower part of the cover straight out (in the direction of the arrow ⇒ [Fig. 231](#)) and remove the cover from the bottom. This action may require moderate force.
- To *install*, guide the cover from the bottom into the instrument panel and push in the direction opposite to the arrow ⇒ [Fig. 231](#) until you can hear it latch into place.

Opening the fuse box in the engine compartment

- Open the engine hood  ⇒ [Working in the engine compartment](#).
- Press the release tabs in the direction of the arrows ⇒ [Fig. 232](#) to unlock the fuse box cover ①.
- Remove the cover upward.
- To *install* push the cover onto the fuse box. The locking tabs must latch with an audible click.

In some vehicles, there are plastic tweezers for removing fuses on the inside of the fuse box cover ⇒ [Fig. 232](#)Ⓞ.

NOTE

- To help prevent vehicle damage, be careful when removing fuse box covers and be sure to re-install them properly.
- Open fuse boxes must be protected from dirt and moisture. Dirt and moisture in fuse boxes can cause damage to the electrical system.



The vehicle contains other fuses in addition to those mentioned in this section. Have these fuses replaced by an authorized Volkswagen dealer or an authorized Volkswagen Service Facility.

Replacing blown fuses

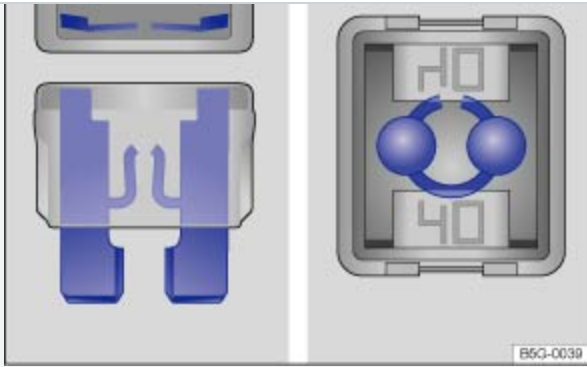


Fig. 233 Blown fuse: : Blade fuse. : JCASE® fuse.

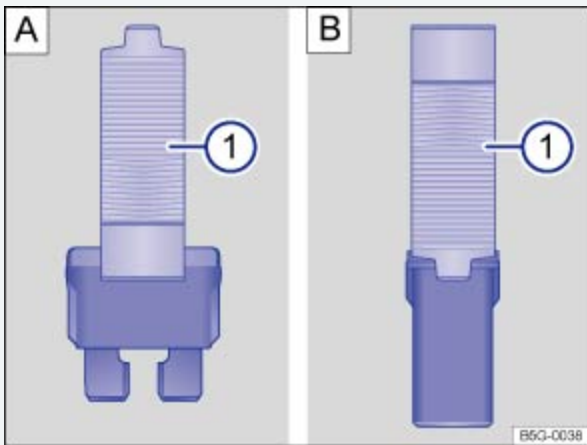


Fig. 234 Removing or installing a blade fuse with the plastic tweezers: : Blade fuse. : JCASE® fuse.



Read and follow the introductory information and safety information first ⇒ ⚠ [Introduction to the subject](#)

Preparations

- Switch off the headlights, the ignition, and all electrical consumers.
- Open the appropriate fuse box ⇒ [Fuses in the vehicle](#).

Identifying a blown fuse

- Shine a flashlight on the fuse. This makes it easier to tell if the fuse has blown.
- A blown *blade fuse* (ATO®, MINI®) has metal strips that have burned through, which you can see through the transparent housing from above and from the side ⇒ [Fig. 233](#) **A**.
- A blown *cartridge fuse* (JCASE®) has metal strips that have burned through, which you can see through the transparent housing from above ⇒ [Fig. 233](#) **B**.



In some vehicles, there are plastic tweezers for removing blade fuses on the inside of the fuse box cover in the engine compartment.

- Open the fuse box cover in the engine compartment ⇒ *Fuses in the vehicle* and remove the plastic tweezers.
- Depending on the type of fuse, slide the tweezers ⇒ *Fig. 234 A* ① or ⇒ *Fig. 234 B* ① onto the fuse from the side.
- Pull out the fuse.
- If the fuse is blown, replace the fuse with a new fuse of the *same* amperage (same color and same imprint) and *same* size ⇒ ⚠ .
- Clip the plastic tweezers back into the holder inside the fuse box cover.
- Replace the fuse box cover.

⚠ NOTE

If a fuse is replaced with a fuse with higher amperage, then damage can occur at various places in the electrical system.

Replacing light bulbs



Introduction to the subject

In this chapter you will find information on the following subjects:

⇒ *Indicator light*

Changing a light bulb requires a certain amount of skill. Therefore, Volkswagen recommends having the light bulb changed by an authorized Volkswagen dealer or an authorized Volkswagen Service Facility. Special training and knowledge are generally required when other vehicle parts must be disassembled to replace a bulb, or when HID – High Intensity Discharge (Xenon) headlights must be replaced.

You should always keep a box in the vehicle with all the replacement bulbs required for traffic safety. Replacement bulbs are available from your authorized Volkswagen dealer or authorized Volkswagen Service Facility. The laws of some countries explicitly require you to have replacement bulbs in the ve-



Driving with outside lights that do not work may be against the law.

To obtain the Volkswagen service information necessary to change light bulbs yourself, see [⇒ Volkswagen service information](#).

Additional light bulb specifications

Some factory-installed light bulbs in the headlights or the rear lights may have different specifications than conventional light bulbs. Specifications are on the glass bulb or on the metal base.

⚠ WARNING

Crashes and other accidents can happen when you cannot see the road ahead and when you cannot be seen by other motorists.

⚠ WARNING

Improper replacement of burned out headlights and other light bulbs can cause serious personal injury.

- Stop! Always read and heed the WARNINGS before doing any work in the engine compartment [⇒ Working in the engine compartment](#). The engine compartment of any motor vehicle is a potentially dangerous area, and work in this area can lead to serious personal injury.
- HID – High Intensity Discharge (Xenon) headlights get power from a high voltage source that can cause severe personal injury and even death if handled improperly.
- H7 bulbs and HID – High Intensity Discharge (Xenon) headlights are under high pressure and can explode if handled improperly.
- Always let a burned out light bulb cool down before replacing it.
- Never replace a light bulb unless you are familiar with all of the necessary procedures. In particular, never remove a headlight unless you know exactly how to carry out the job and have the correct tools and light bulbs.
- If you are uncertain about what to do, have the work performed by an authorized Volkswagen dealer, an authorized Volkswagen Service Facility, or another qualified workshop. Serious personal injury may result from improperly performed work.
- We strongly recommend that you always have HID – High Intensity Discharge (Xenon) head-



- Do not touch the glass of light bulbs with your bare hands. Fingerprints left on the bulb evaporate due to the heat when the bulb is switched on and cause the reflector to cloud.
- There are sharp edges on and around the headlight housing in the engine compartment and the rear light housing. Wear hand protection if you replace bulbs.

NOTE


After replacing a headlight bulb or other light bulb, always make sure that the rubber covers or plastic caps have been properly and securely reinstalled to help prevent water from getting into the electrical connections and the headlight housing and damaging the electrical system.



LEDs cannot be replaced. Contact your authorized Volkswagen dealer or authorized Volkswagen Service Facility for assistance.

Indicator light



Read and follow the introductory information and safety information first ⇒  [Introduction to the subject](#)

Lights up Possible cause

Proper response



Light bulb of the exterior vehicle lighting not working.^{a)}

See an authorized Volkswagen dealer, an authorized Volkswagen Service Facility, or other qualified workshop to replace the light bulb that isn't working.

When the ignition is switched on, several warning and indicator lights come on briefly for a function check. They go out after a few seconds.




Failure to heed warning lights and instrument cluster text messages can cause the vehicle to break down in traffic and result in a collision and serious personal injury.

- Never ignore warning lights or text WARNINGS.
- Always stop the vehicle as soon as it is safe to do so.

NOTE

Failure to heed warning lights or text WARNINGS can result in vehicle damage.



Failure of a single LED within a taillight is not indicated. However, the  indicator light will light up if all LEDs fail.

a) Displayed in color on an instrument cluster with color display.

Jump-starting



Introduction to the subject

In this chapter you will find information on the following subjects:

⇒ *Jump-start terminal*

⇒ *Using jumper cables*

If your engine does not start because the vehicle battery is dead, your vehicle's battery can be connected to the battery of another vehicle to start your engine (jump-starting). Check the battery acid level indicator on the vehicle battery before jump-starting ⇒ *Vehicle battery*.

You must use jumper cables that meet recognized industrial standards (check information provided by the jumper cable manufacturer). For vehicles with gasoline engines, the cross-section of the jumper cable wire must be at least 0.038 in.² (25 mm²), or about 3 ga. (AWG).

WARNING

Working on the batteries or the electrical system in your vehicle can cause serious acid burns,



- Always keep children away from battery acid and vehicle batteries in general.
- Sulfuric battery acid is very corrosive and can cause blindness and damage to unprotected skin. Never let battery acid or lead particles contact your eyes, skin, and clothing.
- Never lean over a vehicle battery. Always wear protective gloves and eye protection. To reduce your risk of injury, never tilt the batteries; acid could spill out through the vents and burn you.
- A highly explosive mixture of gases is given off when the battery is being charged.
- Always avoid fires, sparks, open flame, and smoking. Never create sparks or electrostatic charges when handling cables and electrical equipment. Never short-circuit the battery terminals. High-energy sparks can cause serious personal injury.
- If you get battery acid in your eyes or on your skin, immediately rinse with cold water for several minutes and get medical attention immediately. If you swallow any battery acid, get medical attention immediately.

WARNING

Improper use of jumper cables when jump-starting a vehicle with a dead battery can cause the battery to explode, leading to serious personal injury. To help reduce the risk of battery explosion:

- All work on the batteries or the electrical system in your vehicle can cause serious acid burns, fires, or electrical shocks. Always read and heed the following WARNINGS and safety precautions before working on the batteries or the electrical system ⇒ [Vehicle battery](#).
- Always make sure that the battery providing starting assistance (the booster battery) has the same voltage as the dead battery (12 V) and about the same amperage capacity (see battery label).
- Never jump-start a vehicle with a thawed or frozen vehicle battery. The battery can explode. A dead battery can freeze at temperatures around +32 °F (0 °C).
- A battery that is frozen or was frozen, but has since thawed, must be replaced.
- When the vehicle battery is jump-started, it gives off hydrogen gas, which is highly explosive! Always keep fire, sparks, open flame, and smoking materials far away from vehicle batteries. Never use a mobile telephone while connecting or disconnecting jumper cables.
- Jump-start batteries only in well-ventilated areas. Batteries give off highly explosive hydrogen gas during jump-starting.

engine compartment.

- Never short out the battery terminals by connecting the positive (+) and negative (-) terminals with each other.
- Never connect the negative cable from the other vehicle directly to the negative terminal of the dead battery, as this may cause the hydrogen gas given off by the dead battery to explode.
- Never attach the negative cable from the vehicle providing starting assistance to any part of the fuel system or to the brake hoses or brake lines.
- Never allow the non-insulated parts of the battery clamps to touch.
- Never allow the jumper cable attached to the positive battery terminal to contact metal parts of the vehicle.
- Always follow the instructions of the jumper cable manufacturer.

NOTE

To help prevent extensive damage to the vehicle electrical system, read and heed the following:

- Connecting jumper cables improperly can cause a short circuit and do expensive damage to the vehicle's electrical system.
- Do not let the vehicles touch each other while the jumper cables are connected. If they do, electrical current may flow between the vehicles when the positive (+) terminals are connected, causing electrical system damage.

Jump-start terminal



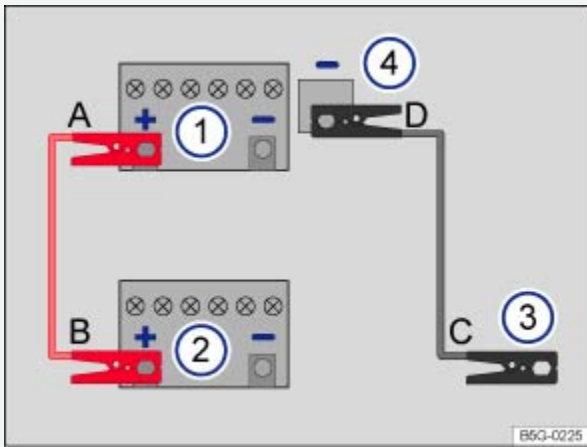
Fig. 235 In the engine compartment: Negative jump-start terminal ⊖.

subject

The jump-start terminal for connecting the *black* jump-start cable is in the engine compartment
 ⇒ [Fig. 235](#) ⊖.

Your vehicle can only be jump-started or be used to jump-start another vehicle via this jump-start terminal.

Using jumper cables



[Fig. 236](#) Diagram for attaching the jumper cables: Dead battery ① and booster battery ②.

Read and follow the introductory information and safety information first ⇒ [Introduction to the subject](#)

Key to ⇒ [Fig. 236](#) :

- ① Battery of the vehicle receiving starting assistance
- ② Battery of the vehicle providing starting assistance.
- ③ Negative jump-start terminal on vehicle providing starting assistance.
- ④ Negative jump-start terminal on vehicle receiving starting assistance.

The dead battery must be properly connected to the vehicle's electrical system.

Make certain that the vehicles are not touching each other. Otherwise, electric current could flow as soon as the positive battery terminals (+) are connected. Use longer jumper cables if necessary.

If the engine does not start, stop the process after 10 seconds and repeat after about 1 minute. If the engine still does not start, get professional assistance.

The procedure for attaching and for removing the jumper cables is described below. Perform each of the following steps only in the order described, which follow the letters shown in the illustration ⇒ *Fig. 236* A – B – C – D.

Checklist

- ✓ Switch off the ignition in both vehicles Starting and stopping the engine.
- ✓ Open the battery cover, if necessary Vehicle battery.
- ✓ Attach one end of the red jumper cable A to the positive battery terminal \oplus on the dead battery: ① .
- ✓ Attach the other end of the red jumper cable B to the positive battery terminal \oplus on the good battery (booster battery): ②.
- ✓ Attach one end of the black jumper cable C to the negative jump-start terminal of the vehicle providing assistance: ③ (Jump-start terminal), or if that is not available, to a bare metal part of the vehicle providing assistance. This part should be connected directly to the engine block.
- ✓ Attach the other end of the black jumper cable D to the negative jump-start terminal of the vehicle receiving assistance ④ (Jump-start terminal), or if that is not available, to a bare metal part of the vehicle receiving assistance. This part should be connected directly to the engine block. Attach the clamp to a point that is as far away as possible from the dead battery ①
- ✓ Route the jumper cables so that they cannot get caught in any moving parts in the engine compartment of either vehicle.

Starting the engine

- Start the engine of the vehicle with the good battery that is providing help and let it run at idle speed.
- Turn on the ignition of the vehicle with the dead battery. If the engine starts, wait 2 to 3 minutes until it runs smoothly before removing the jumper cables as described below ⇒ . If the engine does not start within about 10 seconds, turn off the ignition and wait at least 1 minute; then try again. If the engine still does not start, get professional assistance.



- Switch off the headlights (if they are on).
- In the vehicle with the dead battery, switch on the heater fan and the rear window defroster. This helps to minimize voltage spikes when the cables are disconnected.

Checklist

With the engine running, remove the jumper cables in reverse order to the way they were connected.

- ✓ Disconnect the black (-) cable from the vehicle with the dead battery.
- ✓ Disconnect the black (-) cable from the other vehicle (vehicle with the good battery).
- ✓ Disconnect the red (+) cable from the other vehicle (vehicle with the good battery).
- ✓ Disconnect the red (+) cable from the vehicle with the dead battery.
- ✓ Close the battery cover.

WARNING

Improper use of jumper cables when jump-starting a vehicle with a dead battery can cause the battery to explode, leading to serious personal injury. To help reduce the risk of battery explosion:

- All work on the batteries or the electrical system in your vehicle can cause serious acid burns, fires, or electrical shocks. Always read and heed the following WARNINGS and safety precautions before working on the batteries or the electrical system ⇒ [Vehicle battery](#).
- Always wear proper eye protection. Never lean over the vehicle battery.
- Attach the jumper cables in the correct order: first the positive cable, then the negative cable.
- Never connect the negative cable from the vehicle providing starting assistance to parts of the fuel system or to the brake hoses or brake lines.
- Never allow the non-insulated parts of the battery clamps to touch.
- Never allow the jumper cable attached to the positive battery terminal to contact metal parts of the vehicle.
- Check the battery acid level indicator window on the vehicle battery. Use a flashlight, never a match, cigarette lighter, or other open flame. If you cannot see the color of the window clearly, or if it is light yellow or colorless, do not jump-start the vehicle. Get expert assistance.



gen gas escaping from the vehicle battery to ignite.

- Never jump-start a vehicle with a battery that is damaged or frozen or that was frozen and has thawed. The battery can explode. Replace the battery instead.
- Always follow the instructions of the jumper cable manufacturer.
- Always make sure that the battery providing starting assistance has the same voltage as the dead battery (12 V) and about the same capacity (see battery label).
- Batteries give off explosive hydrogen gas. Always keep fire, sparks, open flame and smoking materials away from batteries.
- Never connect the negative cable from the other vehicle directly to the negative battery terminal on the dead battery. The hydrogen gas from the battery is explosive.
- Never short out the battery terminals by connecting the positive (+) and negative (-) terminals with each other.

Towing



Introduction to the subject

In this chapter you will find information on the following subjects:

⇒ *Towing on a commercial tow truck*

⇒ *Tips on towing*

⇒ *Installing the front towing eye*

⇒ *Installing the rear towing eye*

⇒ *Driving tips while towing*

Observe legal requirements when towing.

For technical reasons:

- A vehicle with a dead battery must never be towed. Jump-start the vehicle instead.
- It is not possible to tow-start or push-start your vehicle. Jump-start the vehicle instead.



Towing the vehicle when the engine is turned off and the ignition is turned on drains the vehicle battery. Depending on the charge level of the vehicle battery, it is possible that even after just a few minutes, electrical devices such as the emergency flashers may not have the power necessary to function. The steering wheel might lock in vehicles with Keyless Access ⇒ ⚠ .

WARNING

Never tow a vehicle without any electrical power.

- Never remove the key from the ignition switch or turn off the ignition with the starter button while the vehicle is moving or rolling to a stop. The electronic steering column could suddenly lock, you would not be able to steer, and you could lose control of the vehicle, crash, and seriously injure yourself and others.
- If the vehicle loses power while it is being towed, stop towing the vehicle immediately and contact your authorized Volkswagen dealer or authorized Volkswagen Service Facility for assistance.

WARNING

Towing a vehicle changes the way it handles and brakes. To help reduce the risk of an accident and serious personal injury, note the following:

- The driver of the vehicle that is being towed:
 - Since the brake booster also does not work when the engine is stopped, you will need to press harder on the brake pedal to slow down or stop. Always be alert so as not to rear-end the towing vehicle.
 - Will have to use considerably more force to turn the steering wheel because the power steering is not working.




- Must accelerate gradually and gently and avoid jerking movements.
- Must not brake hard or steer sharply.
- Must brake earlier and more gently than in normal driving.

NOTE

- Be careful not to damage the paint when installing and removing the towing eye and the cover for the threaded hole behind the bumper.
- Unburned fuel can get into the catalytic converter during towing and damage it.

Towing on a commercial tow truck



Read and follow the introductory information and safety information first ⇒  [Introduction to the subject](#)


To help avoid damaging the vehicle, have it towed only by a professional towing company. Read and heed the following information:

General information

Never let the vehicle be towed at speeds above 30 mph (50 km/h).

Never let the vehicle be towed for more than 30 miles (50 km).

Towing manual transmission vehicles

- Release the parking brake.
- Shift the transmission into Neutral (N).
- If possible, have the vehicle towed with the front wheels off the ground.
- If necessary, the vehicle can also be towed with the rear wheels off the ground ⇒ .

Towing automatic transmission vehicles

- Release the parking brake.



- Tow the vehicle only with its front wheels off the ground ⇒ ⓘ .

Special towing instructions for vehicles with all-wheel drive (4MOTION)

- To help prevent unnecessary damage, vehicles with all-wheel drive (4MOTION) must be transported on a flatbed truck.
- To load the vehicle on the flatbed, use the towing eye found in the vehicle tool kit and attach it to the front anchorage ⇒ [Vehicle tool kit](#) , ⇒ [Installing the front towing eye](#) .

When not to tow your vehicle

If there is little or no oil in the transmission because of damage to your vehicle, it must be moved with the drive wheels off the ground. The vehicle can only be towed if its ignition is switched on and its electrical system is operating.

In the following situations, the vehicle cannot be towed at all and must be transported on a flatbed truck or trailer:

- If the front and rear wheels cannot turn.
- If the vehicle battery is dead (because the electronic steering column lock cannot be released, if engaged). *Vehicles with an electronic parking brake*: If the electronic parking brake was engaged when the battery died, it cannot be released ⇒ [Electronic parking brake \(Golf R\)](#) .
- If you have to tow an automatic transmission vehicle more than 30 miles (50 km).

WARNING

It is not safe for children or other persons to ride in a vehicle that is being towed.

- Never let children or anyone else remain in the vehicle while it is being towed.

NOTE

The drive axle rotates while the vehicle is being towed with its rear wheels off the ground. This can damage the automatic transmission.

- Never tow automatic transmission vehicle with the rear wheels off the ground.
- Tow manual transmission vehicles with the rear wheels off the ground only if it is certain that



Tips on towing



Read and follow the introductory information and safety information first ⇒ [Introduction to the subject](#)

Towing eye; tow rope or tow bar

A towing eye is included in your vehicle's tool kit. This can be inserted in a threaded hole in the front bumper and used when your vehicle is being towed by another vehicle. On most vehicles, there is another threaded hole in the rear bumper, so you can use the towing eye to tow other vehicles as well. Towing a vehicle with a tow bar is safer and easier on both vehicles than using a tow rope. A tow rope should be used only if a tow bar is not available.

The tow rope should be flexible enough to help protect both vehicles from damage. Use a synthetic fiber rope or similar rope.

Attach the tow rope or tow bar only to the towing eye included in the vehicle tool kit for this purpose, or to a trailer hitch.

Towing manual transmission vehicles

Check whether your vehicle can be towed at all; see below ⇒ [When not to tow your vehicle](#).

If yes, note the following for the towed vehicle:

- Shift the gearshift lever to Neutral ⇒ [Shifting](#).
- Do not tow faster than 30 mph (50 km/h).
- Do not tow more than 30 miles (50 km).

Towing automatic transmission vehicles

Check whether your vehicle can be towed at all; see below ⇒ [When not to tow your vehicle](#).

If yes, note the following for the towed vehicle:

- Put the transmission in Neutral (N).
- Do not tow faster than 30 mph (50 km/h).



- When a commercial tow truck is being used, the vehicle must only be towed with the front wheels lifted off the ground.
- Follow the special instructions for towing vehicles with all-wheel drive (4MOTION).

Towing vehicles with all-wheel drive (4MOTION)

Vehicles with all-wheel drive (4MOTION) should be towed with a tow bar or a tow rope. If the vehicle is towed with the front or rear axles lifted off the ground, the engine must be switched off. Otherwise the powertrain may be damaged.

For vehicles with DSG[®] automated transmission, also follow the directions on how to tow a vehicle with automatic transmission ⇒ [Towing automatic transmission vehicles](#).

When not to tow your vehicle

In the following situations, the vehicle cannot be towed and must be transported on a flatbed truck or trailer:

- If transmission fluid has leaked out of the transmission.
- If there is little or no oil in the transmission because of damage to your vehicle, it must be moved with the drive wheels off the ground.
- If the front and rear wheels cannot turn.
- When the vehicle battery is dead, because the steering may remain disabled and it may not be possible to release the electronic steering column lock. *Vehicles with an electronic parking brake:* If the electronic parking brake was engaged when the battery died, it cannot be released ⇒ [Electronic parking brake \(Golf R\)](#).
- If you have to tow an automatic transmission vehicle more than 30 miles (50 km).
- If the steering or the wheel clearance might be impaired, for example, after an accident.

Towing other vehicles

- Obey all legal requirements.
- Read and heed all towing information in the owner's manual for the other vehicle.



A vehicle can be towed only if the electronic steering column lock and the electronic parking

the engine may have to be jump started in order to release the electronic steering column lock and the electronic parking brake (if equipped).

Installing the front towing eye



Fig. 237 In the right front bumper: Removing the cover.

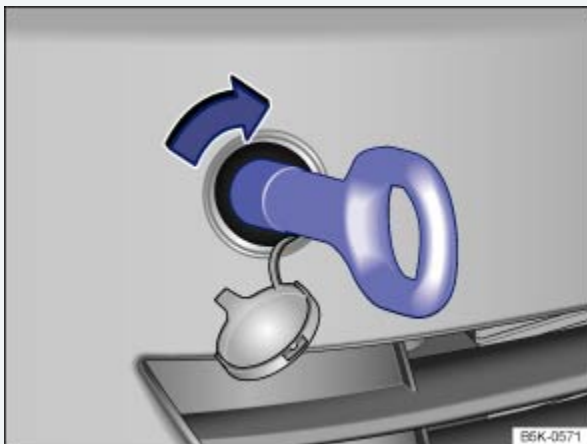



Fig. 238 In the right front bumper: Installing the towing eye.



Read and follow the introductory information and safety information first ⇒  [Introduction to the subject](#)

There is a threaded hole for the towing eye in the right front bumper behind a cover ⇒ [Fig. 238](#).


Always keep the towing eye in the vehicle and stow it securely.

Read and follow the notes about towing ⇒ [Tips on towing](#).

Installing the front towing eye



compartment ⇒ *Vehicle tool kit*.

- Push on the left side of the cover ⇒ *Fig. 237* (arrow) so that it pops out.
- Remove the cover and let it hang from the bumper.
- Screw the towing eye clockwise into the threaded hole as far as it will go (arrow) ⇒ *Fig. 238* ⇒ 



[Purchase Owner's Literature](#)

[Terms](#)

[Privacy](#)



* This Online Owner's Manual may not include Supplements issued after the publication of the physical Owner's Manual. Please consult your physical Owner's literature. In the event of a discrepancy between the Online Owner's Manual and physical Owner's literature, the physical Owner's literature controls.

"Volkswagen" and the Volkswagen logo are registered trademarks of Volkswagen AG. © 2018 Volkswagen of America, Inc.

Installing the rear towing eye



Fig. 239 In the right rear bumper: Removing the cover.

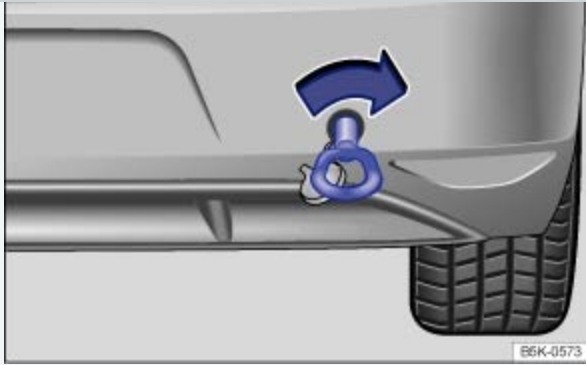


Fig. 240 In the right rear bumper: Installing the towing eye.




Read and follow the introductory information and safety information first ⇒ [Introduction to the subject](#)

There is a threaded hole for the towing eye in the right rear bumper behind a cover ⇒ [Fig. 240](#).

Always keep the towing eye in the vehicle and stow it securely.

Read and follow the notes about towing ⇒ [Tips on towing](#).

Installing the rear towing eye

- Take the towing eye, the lug wrench, and the screwdriver out of the vehicle tool kit in the luggage compartment ⇒ [Vehicle tool kit](#).
- Push on the cover at the bottom marking ⇒ [Fig. 239](#) (arrow) so that it pops out.
- Remove the cover and let it hang from the bumper.
- Screw the towing eye clockwise into the threaded hole as far as it will go (arrow) ⇒ [Fig. 240](#) ⇒ . Use the lug wrench to turn and tighten the towing eye.
- When towing is complete, unscrew the towing eye counterclockwise to remove it.
- Position the lower lip of the cover in the opening in the bumper and carefully push the upper lip over the edge of the opening until the cover locks in place.

NOTE

Always make sure the towing eye is screwed all the way into threaded hole so that it is secure. If not, it could be pulled out while your vehicle is being towed.



Read and follow the introductory information and safety information first ⇒ [Introduction to the subject](#)

Towing requires some experience, especially when using a tow rope. Both drivers must be familiar with the techniques required for towing. Inexperienced drivers should not try to tow a vehicle or to drive a vehicle that is being towed.

Do not pull too hard with the towing vehicle, and avoid jerking the tow rope. When towing on an unpaved road, there is always a risk of overloading and damaging the attachment points.

If your vehicle is being towed, it can still signal turns even if the emergency flashers are activated, as long as the ignition is switched on. Use the turn signal in the normal way. The emergency flashers go off as long as the turn signal is blinking. As soon as the turn signal lever returns to its neutral position, the emergency flashers are automatically activated again.

As the driver of the vehicle being towed:

- If your vehicle is the one being towed, the ignition must be switched on to keep the steering wheel from locking. Also make sure that the turn signals, horn, windshield wipers, and windshield washers work properly.
- Since power steering does not work when the engine is switched off, more effort is needed to steer the vehicle.
- Since the brake booster also does not work when the engine is stopped, you will need to press harder on the brake pedal to slow down or stop. Do not hit the towing vehicle.
- Read and heed the information and WARNINGS in the towing vehicle's owner's manual.

As the driver of the towing vehicle:

- Drive especially carefully and accelerate gently. Avoid sudden driving maneuvers.
- Brake earlier and more gently than usual and with light pedal pressure.
- Read and heed the information and WARNINGS in the owner's manual of the vehicle being towed.



Owner's manual
Owner's Manual
Edition: 12.2016
ID: 5GM012723AL

Abbreviations used

Abbreviation	Meaning
ABS	Anti-lock Brake System
AFS	Adaptive Front Lighting System
AKI	Anti-Knock Index
ANSI	American National Standards Institute
ASL	Automatic Shift Lock
ASR	Anti-Slip Regulation
ATA	Anti-Theft Alarm system
BAS	Brake Assist System
ccm	Cubic centimeter – metric unit of measure for engine displacement
CID	Cubic inch displacement – unit of measure for engine displacement



cm	Centimeter – metric unit of measure for length
CO ₂	Carbon dioxide
DIN	Deutsches Institut für Normung (German Institute for Standardization)
DRL	Daytime Running Lights
DSG [®]	DSG automated transmission
EDL	Electronic Differential Lock
EDR	Event Data Recorder
EN	European Norm
EPC	Engine control (Electronic Power Control)
ESC	Electronic Stability Control
g/mi (g/km)	Generated carbon monoxide amount in grams per mile (kilometer) driven
GAWR	Gross Axle Weight Rating
GVWR	Gross Vehicle Weight Rating



HID	High Intensity Discharge headlights (Xenon)
hp	Horsepower – unit of measure for engine power
kg	Kilogram – metric unit of measure for weight
kN	Kilonewton – unit of measure for force
kPa	Kilopascal – unit of measure for tire pressure
kp	Kilopond – unit of measure for force
kW	Kilowatt – engine rating
LED	Light Emitting Diode
m	Meter – metric unit of measure for length
MFD	Multifunction Display
MIL	Malfunction Indicator Light (engine)
MTBE	Methyl Tertiary Butyl Ether
Nm	Newton meter – unit of measure for engine torque



PDC	Park Distance Control
RON	Research Octane Number – measurement of anti-knock resistance of gasoline
rpm	Engine revolutions per minute (engine speed)
SAE	Society of Automotive Engineers
TSI [®]	Turbocharged gasoline engine with direct fuel injection



[Purchase Owner's Literature](#) | [Terms](#) | [Privacy](#)

* This Online Owner's Manual may not include Supplements issued after the publication of the physical Owner's Manual. Please consult your physical Owner's literature. In the event of a discrepancy between the Online Owner's Manual and physical Owner's literature, the physical Owner's literature controls.

"Volkswagen" and the Volkswagen logo are registered trademarks of Volkswagen AG. © 2018 Volkswagen of America, Inc.



Owner's manual
Owner's Manual
Edition: 12.2016
ID: 5GM012723AL

1

12 Volt sockets

(Power outlets)

3

3-button module Information button

(3-button module)

LED light

(3-button module)

SOS button

(3-button module)

Wrench button

(3-button module)

A

Abroad

(Operating your vehicle outside of the United States and Canada)

Extended stays with the vehicle

(Operating your vehicle outside of the United States and Canada)

Sale of the vehicle

(Operating your vehicle outside of the United States and Canada)

ABS

(Braking assistance systems)

ACC

(Adaptive Cruise Control (ACC))

Accelerometer

(Performance Monitor sport gauges)

Accessories

(Parts, accessories, repairs, and modifications)



Lights

(Switching lights on and off)

Warning and indicator lights Adaptive chassis control DCC

(Driving Mode Selection)

Adaptive Cruise Control (ACC) Indicator lights

(Display, warning and indicator lights)

Operating

(Operating Adaptive Cruise Control (ACC))

Radar sensor Special driving situations Warning lights

(Display, warning and indicator lights)

Adaptive Front Lighting System

(Lights and vision – features)

Adjusting

(Proper seating position)

Electrical controls on the front seats

(Electrical controls on the driver and front passenger seats)

Head restraints

(Adjusting the front and rear head restraints)

Manual controls on the front seats

(Manual controls on the driver and front passenger seats)

Proper seating position

Rear seat backrest

(Folding the rear seat backrest forward and back into place)

Steering wheel

(Adjusting the steering wheel position)

Adjusting the driving mode

(Adjusting the Custom driving mode)

Advanced Airbag System

(Advanced Airbag System components)

AFS

(Lights and vision – features)



Air conditioning

(Heating and air conditioning)

Air recirculation

Air vents

Climatronic

(Climatronic controls)

Controls

Manual controls

Climatronic controls

Operation via the Infotainment system

(Manual controls)

Infotainment

(Operation via the Infotainment system)

Malfunction

(Operation)

Manual air conditioning

(Manual controls)

Operation

Settings

(Operation)

Special considerations

(Operation)

Air recirculation

Functionality

(Air recirculation)

Switching off

(Air recirculation)

Air vents

Airbag system

(Description of the power locking system)

Advanced Airbag System

(Advanced Airbag System components)

Advanced Airbags

(How to tell if the front passenger front airbag is on or off)

Capacitive passenger detection system

(How to tell if the front passenger front airbag is on or off)



Deactivation of the front passenger front airbag

(How to tell if the front passenger front airbag is on or off)

Description

(Airbags and how they work)

Front airbags

Functionality

(Airbags and how they work)

Indicator light

(Monitoring the Advanced Airbag System)

Locking vehicle after inflation

(Description of the power locking system)

PASSENGER AIR BAG light

Side airbags

Side Curtain Protection airbags (2-door vehicles)

(Side Curtain Protection airbags for 2-door vehicles)

Side Curtain Protection airbags (4-door vehicles)

(Side Curtain Protection airbags for 4-door vehicles)

Use of child restraints

(How to tell if the front passenger front airbag is on or off)

Vehicle care

(Care and cleaning of plastic components, wood trim, and instrument panel)

Alarm button on vehicle key

(Remote control vehicle keys)

Alarm system

(Anti-theft alarm system)

All-wheel drive

(Winter tires)

Snow chains

Winter tires

Aluminum parts

(Caring for and cleaning chrome and aluminum parts)

Ambient lighting

(Interior and reading lights)

Anodized surfaces

(Caring for and cleaning chrome and aluminum parts)



[Anti-Lock Brake System \(ABS\)](#)

(Braking assistance systems)

[Anti-Slip Regulation \(ASR\)](#)

(Braking assistance systems)

[Anti-theft alarm system](#)

[Anti-theft wheel bolts](#)

(Contents)

[Antifreeze agent](#)

(Engine coolant specifications)

[Apps](#)

(Application software ("apps"))

[Armrest](#)

(Center armrest (Golf, Golf GTI))

[Golf, Golf GTI](#)

(Center armrest (Golf, Golf GTI))

[Golf R](#)

(Center armrest (Golf R))

[ASR](#)

(Braking assistance systems)

See Braking assistance systems

[Braking assistance systems](#)

[Switching Anti-Slip Regulation \(ASR\) and ESC Sport mode on and off](#)

(Braking assistance systems)

[Switching on and off](#)

(Switching Anti-Slip Regulation (ASR) and ESC Sport mode on and off)

[Assistance systems](#)

(Tire Pressure Monitoring System (TPMS) and recalibration through the Infotainment system)

[Adaptive chassis control DCC](#)

(Driving Mode Selection)

[Adaptive Cruise Control \(ACC\)](#)

[Anti-Lock Brake System \(ABS\)](#)

(Braking assistance systems)

Anti-Slip Regulation (ASR)

[Braking assistance systems](#)

[Switching Anti-Slip Regulation \(ASR\) and ESC Sport mode on and off](#)

(Braking assistance systems)



Automatic Post-Collision Braking System

(Braking assistance systems)

Blind Spot Monitor with Rear Traffic Alert Brake Assist (BAS)

(Braking assistance systems)

Braking assistance systems

Cruise control

Cruise control

Driving Mode Selection

Electronic Differential Lock (EDL and XDL)

(Braking assistance systems)

Electronic Stability Control (ESC)

(Braking assistance systems)

Front Assist

(Forward Collision Warning (Front Assist))

Hill Start Assist

(Hill Start Assist (Hill Hold))

Lane Assist

(Lane Keeping System (Lane Assist))

Park Assist

Park Distance Control

(Park Distance Control (PDC))

Rear View Camera system

Tire Pressure Monitoring System (TPMS)

(Tire Pressure Monitoring System (TPMS) and recalibration through the Infotainment system)

Attaching jumper cables

(Using jumper cables)

Auto Hold

(Indicator light)

Auto-dimming rearview mirror

(Inside mirror)

Automatic headlights

(Lights and vision – features)

Automatic leveling headlights

(Instrument panel lighting and headlight range adjustment)

Automatic load deactivation



Automatic Post-Collision Braking System

(Braking assistance systems)

Automatic Shift Lock (ASL)

(Automatic transmission: Selector lever)

Automatic transmission

(Vehicle key positions in the ignition switch)

Driving

(Driving with automatic transmission)

Driving on hills

(Driving with automatic transmission)

DSG®

(Driving with automatic transmission)

Emergency release for the selector lever lock Kick-down feature

(Driving with automatic transmission)

Launch control program

(Driving with automatic transmission)

Malfunction

Automatic transmission malfunction

Shifting

Shifting

Automatic transmission: Selector lever

(Shifting)

Towing

Towing on a commercial tow truck

Tips on towing

(Towing on a commercial tow truck)

Vehicle key safety interlock

(Vehicle key positions in the ignition switch)

Autonomous Emergency Braking

(Forward Collision Warning (Front Assist))

AUX-in jack

(Storage compartment in the front center console)

Axle weights

(Weights and axle weights)

B



[*Ball mount*](#)

[*BAS*](#)

(Braking assistance systems)

[*Battery*](#)

(Replacing the remote control vehicle key battery)

[*Remote control vehicle key*](#)

(Replacing the remote control vehicle key battery)

[*See Vehicle battery*](#)

(Vehicle battery)

[*Battery acid*](#)

(Checking the vehicle battery electrolyte level)

[*Before taking the vehicle in to the shop*](#)

(Frequently asked questions (FAQ))

[*Belt pretensioners*](#)

(Service and disposal of belt pretensioners)

[*Disposal*](#)

(Service and disposal of belt pretensioners)

[*Service and disposal*](#)

(Service and disposal of belt pretensioners)

[*Belt warning light*](#)

(Warning light)

[*Blind Spot Monitor*](#)

(Blind Spot Monitor with Rear Traffic Alert)

[*Driving situations*](#)

[*Function*](#)

(Blind Spot Monitor)

[*Indicator lights*](#)

[*Indicator lights in the outside mirrors*](#)

(Blind Spot Monitor)

[*Malfunction*](#)

(Blind Spot Monitor with Rear Traffic Alert)

[*Bottle holders*](#)

(Cup holders)

[*Brake Assist \(BAS\)*](#)

(Braking assistance systems)



[Brake fluid](#)

[Brake system](#)

(About the brakes)

[Brakes](#)

(Braking and parking)

[Brake booster](#)

(About the brakes)

[Brake fluid](#)

[Brake fluid level](#)

(Brake fluid)

[Brake pads](#)

(About the brakes)

[Braking assistance systems](#)

[Break-in period](#)

(About the brakes)

[Breaking in the brake pads](#)

(About the brakes)

[Changing brake fluid](#)

(Brake fluid)

[Electronic parking brake](#)

(Electronic parking brake (Golf R))

[Emergency braking function](#)

(Electronic parking brake (Golf R))

[Indicator light](#)

(Warning and indicator lights)

[Parking brake](#)

(Parking brake (Golf, Golf GTI))

[Warning light](#)

(Warning and indicator lights)

[Braking assistance systems](#)

[Break-in period](#)

(New and replacement tires)

[Engine](#)

(Break-in period)

[The first few miles \(kilometers\)](#)



[Tires](#)

(New and replacement tires)

[Breakdown](#)

(Protecting yourself and the vehicle)

C

[California Proposition 65 Warning](#)

(Vehicle battery)

[Camera](#)

(Rear View Camera system)

[Capacitive passenger detection system](#)

(How to tell if the front passenger front airbag is on or off)

[Car wash](#)

(Outside mirrors)

[Folding outside mirrors in](#)

(Outside mirrors)

[Switching off Auto Hold](#)

(Auto Hold (Golf R))

[Car-Net](#)

(Features)

[3-button module](#)

[Application software](#)

(Application software ("apps"))

[Features](#)

[Care](#)

(Exterior care and cleaning)

[Catalytic converter](#)

(Indicator lights)

[Indicator light](#)

(Indicator lights)

[Malfunction](#)

(Indicator lights)

[Cell phone](#)

(Using a mobile phone in a motor vehicle when it is not connected to a vehicle telephone antenna:
Some important things to know)



Golf, Golf GTI

(Center armrest (Golf, Golf GTI))

Golf R

(Center armrest (Golf R))

Center console

(Upper center console)

Changing a wheel

After the wheel change

(After changing a wheel)

Lifting the vehicle (Golf)

(Lifting the vehicle with the vehicle jack (Golf))

Lifting the vehicle (Golf GTI, Golf R)

(Lifting the vehicle with the vehicle jack (Golf GTI, Golf R))

Preparations

(Preparations for changing a wheel)

Removing the subwoofer

Wheel bolts

When more than one tire is damaged

(Changing a wheel)

Changing light bulbs

(Replacing light bulbs)

Checking engine oil level

(Checking the engine oil level and adding oil)

Checklist

(Getting ready and driving safely)

Adding engine oil

(Checking the engine oil level and adding oil)

Before working in the engine compartment

(Preparing to work in the engine compartment)

Breakdown

(Protecting yourself and the vehicle)

Checking engine oil level

(Checking the engine oil level and adding oil)

Checks while refueling

(Refueling checklist)



(Getting ready and driving safely)

Getting ready

(Getting ready and driving safely)

In an emergency

(Protecting yourself and the vehicle)

Lifting vehicle with jack

Lifting the vehicle with the vehicle jack (Golf)

Lifting the vehicle with the vehicle jack (Golf GTI, Golf R)

(Lifting the vehicle with the vehicle jack (Golf))

Preparations for changing a wheel

Safety belts

(Using safety belts)

Tire mobility set

(Preparations)

Upholstery

(Caring for upholstery)

Checks while refueling

(Refueling checklist)

Child restraints

(How to tell if the front passenger front airbag is on or off)

and front airbag

(Child restraints and the Advanced Airbag System)

and the Advanced Airbag System

(Child restraints and the Advanced Airbag System)

Booster seats

(Booster seats and safety belts)

Child restraint mounting

Infant seats

Convertible child restraints

(Infant seats)

Child seat mounting

(Booster seats and safety belts)

Convertible child restraints

Deactivating the passenger front airbag

(How to tell if the front passenger front airbag is on or off)

Infant carriers



Information about child restraint systems

(Sources of information about child restraints and their use)

On front passenger seat

(Child restraints and the Advanced Airbag System)

On the rear seat

(Using a child restraint on the rear seat)

Securing with LATCH/UCRA anchorages

(Securing the child restraint with LATCH/UCRA lower universal anchorages)

Securing with lockable safety belt

(Installing child restraints with a safety belt)

Securing with safety belt

(Installing child restraints with a safety belt)

Securing with the Top Tether strap

(Securing a child restraint with the Top Tether strap)

Transporting children in vehicles

(Important safety instructions for using child restraints)

Child safety lock

Child seats

(Child safety and child restraints)

Chrome parts

(Caring for and cleaning chrome and aluminum parts)

Cleaning

(Exterior care and cleaning)

Climatronic

(Heating and air conditioning)

Clock

(Displays)

Closing

(Unlocking or locking the vehicle from the outside)

Doors

From inside the vehicle

(Unlocking or locking the vehicle from the inside)

From outside the vehicle

(Unlocking or locking the vehicle from the outside)

Power sunroof



Trunk lid

(Closing the trunk lid)

Windows

(Opening or closing power windows)

with Keyless Access

(Unlocking or locking the vehicle with)

Coat hooks

(Other storage compartments)

Cockpit

(Passenger compartment)

Code number

(Contents)

Coin holders

(Coin holders in the front center console (Golf, Golf GTI))

Collision warning

(Forward Collision Warning (Front Assist))

Combined weight

(Determining the correct load limit)

Coming Home feature

(Coming Home/Leaving Home features (orientation lighting))

Communication window

(Windshield made of heat-insulating glass)

Compact spare wheel

(Spare wheel or compact spare wheel)

Differences from road tires

(Spare wheel or compact spare wheel)

Driving tips

(Spare wheel or compact spare wheel)

Snow chains

Compass

(Displays)

Component protection

Consumer information

Control units

(Notice about data recorded by the Event Data Recorder and vehicle control modules)



Electrical controls on the front seats

(Electrical controls on the driver and front passenger seats)

Manual controls on the front seats

(Manual controls on the driver and front passenger seats)

Convenience opening and closing

(Power windows – features)

Power sunroof

(Power sunroof – features)

Power windows

(Power windows – features)

Convenience turn signal

(Turn signal lever and high beam switch)

Coolant

(Engine coolant)

Cornering lights

(Lights and vision – features)

Counter-steering assistance

(Steering system information)

Cruise control

Adaptive Cruise Control (ACC)

Indicator lights

Operating

(Cruise control operation)

Cup holders

Bottles

(Cup holders)

Cleaning

(Cleaning storage compartments and cup holders)

Front center console

(Cup holders in the front center console)

Rear center armrest

(Cup holders in the rear center armrest)

Rear side trim

(Cup holders in the rear trim)

Curb weight



D

[Data recorded](#)

(Notice about data recorded by the Event Data Recorder and vehicle control modules)

[Data recorder](#)

(Notice about data recorded by the Event Data Recorder and vehicle control modules)

[Daytime running lights \(DRL\)](#)

(Lights and vision – features)

[Deactivating](#)

(Lights and vision – features)

[Parking feature](#)

(Lights and vision – features)

[Deactivation](#)

(When to switch off Lane Assist)

[Declaration of compliance](#)

(Declaration of Compliance, Telecommunications and Electronic Systems)

[Deicing door lock cylinders](#)

[Department of Transportation uniform tire quality grades](#)

(UTQG classification)

[Diagnosis](#)

(Frequently asked questions (FAQ))

[Differential lock](#)

(Braking assistance systems)

[Digital clock](#)

(Displays)

[Dimensions](#)

[Display](#)

(Instrument overview)

[Compass](#)

(Displays)

[Doors](#)

(Display)

[Engine hood](#)

(Display)

[Engine identification code](#)



Front Assist

(Driver warnings and Autonomous Emergency Braking)

Gear recommendation

(Displays)

Instrument cluster

(Displays)

Lane Assist

(Display and indicator lights)

Odometer

(Displays)

Open doors, hood, or trunk lid

(Displays)

Outside temperature

(Displays)

Selector lever position

(Displays)

Service reminder display

Speed warning

(Displays)

Time

(Displays)

Trunk lid

(Display)

Warning and information texts

(Displays)

Disposal

(Service and disposal of belt pretensioners)

Door and window seals

(Caring for rubber door and window seals)

Door handle

(Side view)

Doors

Child safety lock

Display in the instrument cluster

(Display)



[*Drawer under the front seat*](#)

(Storage compartment under the front seat)

[*Driver door*](#)

(Driver door overview)

[*Driver side*](#)

(Driver side overview)

[*Driving*](#)

(Driving checklists and warnings)

[*Driving checklists and warnings*](#)

[*Driving in other countries*](#)

[*Driving through water on roads*](#)

[*Efficiency*](#)

(Saving fuel and helping the environment)

[*Environmentally friendly*](#)

(Saving fuel and helping the environment)

[*Fuel gauge*](#)

(Indicator lights and fuel gauge)

[*Fuel supply too low*](#)

(Indicator lights and fuel gauge)

[*Getting ready*](#)

(Getting ready and driving safely)

[*Parking on a hill*](#)

(Parking)

[*Recorded data*](#)

(Notice about data recorded by the Event Data Recorder and vehicle control modules)

[*Some basics*](#)

(Driving checklists and warnings)

[*Starting up on hills*](#)

(Driving with automatic transmission)

[*Stopping on hills*](#)

(Driving with automatic transmission)

[*Through salt water*](#)

(Driving through water on roads)

[*Towing*](#)

(Driving tips while towing)



With automatic transmission

(Driving with automatic transmission)

Driving checklists and warnings

Driving efficiently

(Saving fuel and helping the environment)

Driving lights

(Switching lights on and off)

Driving Mode Selection

Function

(Function and operation)

Operation

(Function and operation)

Driving out of a parking space

(Driving out of a parallel parking space using Park Assist)

Driving safely

(Getting ready and driving safely)

Driving through salt water

(Driving through water on roads)

Driving through water

(Driving through water on roads)

Driving tips

Compact spare wheel

(Spare wheel or compact spare wheel)

Spare wheel

(Spare wheel or compact spare wheel)

When the vehicle is loaded

(Driving tips)

DRL

(Lights and vision – features)

DSG® automated transmission

(Shifting)

Malfunction

(Automatic transmission malfunction)

See Automatic transmission

(Driving with automatic transmission)



E

Earth connection

(Jump-start terminal)

EDL

(Braking assistance systems)

Electrical consumers

(12 Volt sockets in the vehicle)

Electrical controls on the front seats

(Electrical controls on the driver and front passenger seats)

Electrical load

(Hitching up and connecting a trailer)

Electrical sockets

(12 Volt sockets in the vehicle)

Electronic Differential Lock (EDL and XDL)

(Braking assistance systems)

Electronic immobilizer

Electronic parking brake

(Electronic parking brake (Golf R))

Electronic Stability Control (ESC)

(Braking assistance systems)

Emergency brake

(Electronic parking brake (Golf R))

Emergency braking function

(Electronic parking brake (Golf R))

Emergency closing and opening

Driver door

(Manually unlocking and locking the driver door)

Emergency release for the selector lever lock

Fuel filler flap

(Emergency release for the fuel filler flap)

Passenger doors

(Manually locking the passenger doors)

Trunk lid

(Opening the trunk lid from inside the luggage compartment)



Emergency starting

(Jump-starting)

Emission control system

(Engine control and emission control system)

Engine

(Starting the engine)

Break-in period

Does not start

(Frequently asked questions (FAQ))

Noises

(Starting the engine)

Engine and ignition

(Power outlets)

12 Volt sockets

(Power outlets)

Ignition switch

(Vehicle key positions in the ignition switch)

Immobilizer

(Electronic immobilizer)

Starting the engine

Starting the engine with Keyless Access

(Starter button)

Starting the engine with push-button start

(Starting the engine)

Stopping the engine

Stopping the engine with Keyless Access

(Stopping the engine)

Unauthorized vehicle key

(Vehicle key positions in the ignition switch)

Engine compartment

(Working in the engine compartment)

Cleaning

(Cleaning the engine compartment)

Engine coolant

Engine oil



Plenum chamber

(Cleaning the engine compartment)

Preparations

(Preparing to work in the engine compartment)

Vehicle battery

Engine control system

(Indicator lights)

Indicator light

(Indicator lights)

Malfunction

(Indicator lights)

Engine coolant

Checking coolant level

(Checking engine coolant level and topping off)

Filler opening

(Checking engine coolant level and topping off)

G 13

(Engine coolant specifications)

Indicator light

(Warning light and engine coolant temperature gauge)

Specifications

(Engine coolant specifications)

Temperature gauge

(Warning light and engine coolant temperature gauge)

Topping off

(Checking engine coolant level and topping off)

Warning light

(Warning light and engine coolant temperature gauge)

Engine data

Engine hood

(Display)

Display in the instrument cluster

(Display)

Opening or closing

(Opening or closing the engine compartment)



Determining

Important vehicle labels

Displays

Engine oil

Adding oil

(Checking the engine oil level and adding oil)

Capacity

(Engine oil capacities)

Change

(Changing engine oil)

Checking engine oil level

(Checking the engine oil level and adding oil)

Consumption

(Engine oil consumption)

Dipstick

(Checking the engine oil level and adding oil)

Filler opening

(Checking the engine oil level and adding oil)

Indicator light

(Warning and indicator lights)

Specifications

(Engine oil specifications)

Warning light

(Warning and indicator lights)

Environmentally friendly driving

(Saving fuel and helping the environment)

Equipment

(Operating fluids and equipment)

ESC

(Braking assistance systems)

ESC Sport

(Switching Anti-Slip Regulation (ASR) and ESC Sport mode on and off)

Exterior views

Eyeglass storage compartment

(Eyeglass storage compartment in the overhead console)



[FAQs](#)

(Frequently asked questions (FAQ))

[Fault](#)

(Park Assist)

[Features](#)

(Frequently asked questions (FAQ))

[Filling capacity](#)

(Checking and refilling windshield washer fluid)

[Floor mats](#)

(Pedals)

[Fog lights](#)

(Switching lights on and off)

[Forward Collision Warning](#)

(Forward Collision Warning (Front Assist))

[Frequently asked questions](#)

(Frequently asked questions (FAQ))

[Front airbags](#)

[Front Assist](#)

(Forward Collision Warning (Front Assist))

[Displays](#)

(Driver warnings and Autonomous Emergency Braking)

[Operating](#)

(Operating Front Assist)

[Radar sensor](#)

[Switching off temporarily](#)

(Temporarily switch off Front Assist in the following situations)

[System limits](#)

[Front passenger front airbag](#)

(How to tell if the front passenger front airbag is on or off)

[Front passenger side](#)

(Front passenger side overview)

[Front seats](#)

(Manual controls on the driver and front passenger seats)

[Electrical controls](#)

(Electrical controls on the driver and front passenger seats)



[Front view](#)

[Fuel](#)

[Fuel capacities](#)

[Fuel consumption](#)

(Saving fuel and helping the environment)

[Driving efficiently](#)

(Saving fuel and helping the environment)

What increases fuel consumption?

[Indicator lights](#)

[Frequently asked questions \(FAQ\)](#)

(Indicator lights)

[Fuel container, portable](#)

(Refueling)

[Fuel filler cap](#)

(Refueling)

[Closing](#)

(Refueling)

[Opening](#)

(Refueling)

[Fuel filler flap](#)

(Emergency release for the fuel filler flap)

[Fuel gauge](#)

(Indicator lights and fuel gauge)

[Fuel tank cap](#)

(Refueling)

[Fueling](#)

(Refueling)

[Fuses](#)

[Color coding](#)

(Fuses in the vehicle)

[Fuse boxes](#)

(Fuses in the vehicle)

[Identifying a blown fuse](#)

(Replacing blown fuses)

[Preparations for replacement](#)

(Replacing blown fuses)



Types

(Fuses in the vehicle)

G

g-meter

(Performance Monitor sport gauges)

Gasoline

Fuel

(Gasoline)

Grades

(Gasoline)

Gear recommendation

Gearshift lever

(Manual transmission: Gearshift lever)

Generator

(Warning light)

Getting ready

(Getting ready and driving safely)

Glove compartment

(Interior and reading lights)

Gross vehicle weight

(Weights and axle weights)

G 12 plus

(Engine coolant specifications)

G 12 plus-plus

(Engine coolant specifications)

G 13

(Engine coolant specifications)

H

Hand brake

(Electronic parking brake (Golf R))

Hatch

(Trunk lid)

Head restraints



Headlights

(Turn signal lever and high beam switch)

Flasher

(Turn signal lever and high beam switch)

High beam switch

(Turn signal lever and high beam switch)

Not bright enough

(Frequently asked questions (FAQ))

Range adjustment

(Instrument panel lighting and headlight range adjustment)

Washer system

(Windshield wiper functions)

Heated seats

(Seat heating)

Heating system

(Heating and air conditioning)

Hill Hold

(Hill Start Assist (Hill Hold))

Hill Start Assist

(Hill Start Assist (Hill Hold))

Hood

(Opening or closing the engine compartment)

Horn

(Driver side overview)

|

Ice removal

(Cleaning windows and outside mirrors)

Identification number

(Important vehicle labels)

Ignition

(Starting and stopping the engine)

Ignition keys

(Remote control vehicle keys)

Ignition switch



Safety interlock

(Vehicle key positions in the ignition switch)

Unauthorized vehicle key

(Vehicle key positions in the ignition switch)

Immobilizer

(Starting and stopping the engine)

In an emergency

Breakdown

(Protecting yourself and the vehicle)

Checklist

(Protecting yourself and the vehicle)

Emergency flashers

(Protecting yourself and the vehicle)

Protecting yourself and the vehicle

Indicator lights

(Warning and indicator lights)

Adaptive chassis control DCC

(Indicator light)

Adaptive Cruise Control

(Display, warning and indicator lights)

Airbag system

Monitoring the Advanced Airbag System

PASSENGER AIR BAG light

(Monitoring the Advanced Airbag System)

Applying the brake

(Warning and indicator lights)

Auto Hold

(Indicator light)

Blind Spot Monitor

(Indicator lights)

Brake system

(Warning and indicator lights)

Catalytic converter

(Indicator lights)

Checking engine oil level

(Warning and indicator lights)



Depress brake pedal

(Indicator lights)

Driver door

(Indicator light in the driver door)

Emission control system

(Indicator lights)

Engine control

(Indicator lights)

Engine coolant

(Warning light and engine coolant temperature gauge)

Engine oil sensor

(Warning and indicator lights)

ESC

(Warning and indicator lights)

Fuel supply

(Indicator lights and fuel gauge)

Lane Assist

(Display and indicator lights)

Lights

(Indicator lights)

Overview

(Warning and indicator lights)

Rear Traffic Alert

(Indicator lights)

Refueling

(Indicator lights and fuel gauge)

Remote control vehicle key

(Indicator light in the remote control vehicle key)

Replacing light bulbs

(Indicator light)

Shifting

(Warning and indicator lights)

Starting assistance systems

(Indicator light)



Steering column lock

(Warning and indicator lights)

Tire Pressure Monitoring System (TPMS)

(Indicator light (telltale))

Windshield washer fluid level

(Indicator light)

Individual door unlocking

(Description of the power locking system)

Infotainment system

(Menu and system settings)

Air conditioning

(Operation via the Infotainment system)

Driving mode

(Adjusting the Custom driving mode)

Performance Monitor

Settings

(Menu and system settings)

Vehicle settings

(Vehicle settings menu)

Infotainment system settings

(Menu and system settings)

Infrared-reflecting windshield

(Windshield made of heat-insulating glass)

Inside mirror

Manually adjustable

(Inside mirror)

Self-dimming

(Inside mirror)

Inspection service

(Service reminder display)

Instrument cluster

(Instrument cluster and instrument panel)

Brightness

(Instrument panel lighting and headlight range adjustment)



Displays

Menu structure – overview

(Instrument overview)

Driver assistance systems button

Instruments

(Instrument overview)

Menu structure

(Menu structure – overview)

Service reminder display

Symbols

(Warning and indicator lights)

Using menus

(Using the instrument cluster menus)

Warning and indicator lights

Instrument panel

(Passenger compartment)

Airbag system

Airbag system

Care and cleaning of plastic components, wood trim, and instrument panel

(Airbag system)

Cleaning

(Care and cleaning of plastic components, wood trim, and instrument panel)

Overview

(Passenger compartment)

Instruments

(Instrument overview)

Interior lights

(Interior and reading lights)

J

Jack

(Changing a wheel)

Jump leads

(Jump-start terminal)

Earth connection

(Jump-start terminal)

Jump lead connection point



Jump-starting

Jumper cables

(Using jumper cables)

Attaching

(Using jumper cables)

Removing

(Using jumper cables)

K

Keyless Access

(Unlocking or locking the vehicle with)

Engine and ignition

Starting the engine

Stopping the engine

(Starting the engine)

Keyless Entry

(Unlocking or locking the vehicle with)

Keyless Exit

(Unlocking or locking the vehicle with)

Keyless Go

Unlocking or locking the vehicle with

Starter button

(Unlocking or locking the vehicle with)

Starter button

Unlocking or locking the vehicle

(Unlocking or locking the vehicle with)

Keys

(Remote control vehicle keys)

Kick-down feature

(Driving with automatic transmission)

L

Lane Assist

(Lane Keeping System (Lane Assist))

Automatic deactivation

(Driver information)

Display



Driver information

Function

(How Lane Assist works)

Indicator lights

(Display and indicator lights)

When to deactivate

(When to switch off Lane Assist)

Lane Keeping System

(Lane Keeping System (Lane Assist))

Lap timer

Lap times

(Lap timer)

Menu

(Lap timer)

Performance Monitor

Performance Monitor sport gauges

Performance Monitor lap timer and stopwatch

(Performance Monitor sport gauges)

Statistics

(Lap timer)

LATCH

(Child safety and child restraints)

Launch control program

(Driving with automatic transmission)

Leaving Home feature

(Coming Home/Leaving Home features (orientation lighting))

Lifting the vehicle

(Lift points for the vehicle)

Checklist

Lifting the vehicle with the vehicle jack (Golf)

Lifting the vehicle with the vehicle jack (Golf GTI, Golf R)

(Lifting the vehicle with the vehicle jack (Golf))

With the vehicle jack (Golf)

(Lifting the vehicle with the vehicle jack (Golf))

With the vehicle jack (Golf GTI, Golf R)

(Lifting the vehicle with the vehicle jack (Golf GTI, Golf R))



Light Assist

Adjusting the sensitivity

(Light Assist)

Malfunction

(Light Assist)

Switching on or off

(Light Assist)

Light bulb malfunction

(Replacing light bulbs)

Light bulb replacement

(Replacing light bulbs)

Lights

Acoustic warnings

(Switching lights on and off)

Adaptive Front Lighting System

(Lights and vision – features)

AUTO

(Lights and vision – features)

Coming Home/Leaving Home

(Coming Home/Leaving Home features (orientation lighting))

Daytime running lights (DRL)

(Lights and vision – features)

Features

(Lights and vision – features)

Fog lights

(Switching lights on and off)

Headlight range adjustment

(Instrument panel lighting and headlight range adjustment)

High beam switch

(Turn signal lever and high beam switch)

Indicator lights

Instrument cluster brightness

(Instrument panel lighting and headlight range adjustment)

Instruments and switches

(Instrument panel lighting and headlight range adjustment)



Light Assist

Light switch

(Switching lights on and off)

Low beams

(Switching lights on and off)

Parking lights

(Lights and vision – features)

Reading lights

(Interior and reading lights)

Replacing light bulbs

Static cornering lights

(Lights and vision – features)

Switching on and off

(Switching lights on and off)

Turn signal lever

(Turn signal lever and high beam switch)

Load rating code of the tires

(Tire labeling)

Loading

(Driving tips)

Driving with an open trunk lid

General instructions

(Driving tips)

Luggage compartment

Luggage compartment pass-through

Stowing luggage

Tie-downs

Trailer

(Loading the trailer)

Locking

(Description of the power locking system)

After airbag inflation

(Description of the power locking system)

From inside the vehicle

(Unlocking or locking the vehicle from the inside)

From outside the vehicle



Problems

(Frequently asked questions (FAQ))

Trunk lid

(Closing the trunk lid)

with Keyless Access

(Unlocking or locking the vehicle with)

Low beams

(Switching lights on and off)

Luggage compartment

(Interior and reading lights)

Cover

(Luggage compartment cover)

Luggage compartment light

(Interior and reading lights)

Pass-through

(Luggage compartment pass-through)

Variable luggage compartment floor

Luggage compartment floor

(Variable luggage compartment floor)

Luggage compartment lid

(Trunk lid)

Luggage rack

(Roof rack)

M

Malfunction

(Power windows – features)

Air conditioning

(Operation)

Automatic transmission

Automatic transmission malfunction

Blind Spot Monitor

(Blind Spot Monitor with Rear Traffic Alert)

Catalytic converter

(Indicator lights)

DSG®



Immobilizer

(Starting and stopping the engine)

Light Assist

Park Distance Control

(Park Distance Control (PDC))

Power outside mirrors

(Outside mirrors)

Power sunroof

Power windows

(Power windows – features)

Radio reception

Power outlets

Radio antenna and reception

(Power outlets)

Rain sensor

Tire Pressure Monitoring System (TPMS)

(Indicator light (telltale))

Manual air conditioning

(Heating and air conditioning)

Manual controls on the front seats

(Manual controls on the driver and front passenger seats)

Manual transmission

(Shifting)

Shifting

Towing

Towing on a commercial tow truck

Tips on towing

(Towing on a commercial tow truck)

Manually adjustable inside mirror

(Inside mirror)

Microfiber fabric

(Cleaning upholstery, fabric trim, and microfiber fabric)

Mirrors

Folding outside mirrors in

(Outside mirrors)

Inside mirror

Outside mirrors

Synchronous mirror adjustment



Mobile phone

(Using a mobile phone in a motor vehicle when it is not connected to a vehicle telephone antenna:
Some important things to know)

Modifications

(Repairs and technical modifications)

N

New engine

(Break-in period)

New tires

(New and replacement tires)

Noises

(Winter tires)

Adaptive Cruise Control (ACC)

Braking assistance systems

Engine

(Starting the engine)

Parking brake

(Electronic parking brake (Golf R))

Tires

(Winter tires)

Number of seats

(Adjusting the seating position)

O

Octane rating

(Gasoline)

Odometer

(Displays)

Oil

(Engine oil)

Oil dipstick

(Checking the engine oil level and adding oil)

Oil service

(Service reminder display)

Older tires



Opening

(Unlocking or locking the vehicle from the outside)

Doors

From inside the vehicle

(Unlocking or locking the vehicle from the inside)

From outside the vehicle

(Unlocking or locking the vehicle from the outside)

Power sunroof

(Opening or closing the power sunroof)

Trunk lid

(Opening the trunk lid)

Windows

(Opening or closing power windows)

with Keyless Access

(Unlocking or locking the vehicle with)

Opening the trunk lid from the inside

(Opening the trunk lid from inside the luggage compartment)

Operating fluids

(Operating fluids and equipment)

Outside mirrors

Folding in

(Outside mirrors)

Malfunction

(Outside mirrors)

Synchronous mirror adjustment

(Outside mirrors)

Towing a trailer

(Technical requirements)

Vehicle care

(Cleaning windows and outside mirrors)

Outside temperature display

(Displays)

Overview

(Side view)

Center console, lower section



[*Center console, upper section*](#)

(Upper center console)

[*Driver door*](#)

(Driver door overview)

[*Driver side*](#)

(Driver side overview)

[*Front passenger side*](#)

(Front passenger side overview)

[*Front view*](#)

[*Instruments*](#)

(Instrument overview)

[*Menu structure*](#)

(Menu structure – overview)

[*Rear view*](#)

[*Roof console*](#)

(Symbols on the roof console)

[*Side view*](#)

[*Turn signal lever and high beam switch*](#)

[*Warning and indicator lights*](#)

[*Owner's Manual*](#)

(Glove compartment)

P

[*Panic button on vehicle key*](#)

(Remote control vehicle keys)

[*Panoramic power-sliding sunroof*](#)

(Power sunroof)

[*Park Assist*](#)

[*Automatic brake intervention*](#)

(Park Assist automatic braking)

[*Driving out of a parking space*](#)

(Driving out of a parallel parking space using Park Assist)

[*Fault*](#)

(Park Assist)

[*Interrupting*](#)

(Description of the Park Assist system)

[*Parallel parking*](#)



Parking

(Parking while using the Park Assist system)

Parking perpendicular to the road

(Parking while using the Park Assist system)

Requirements for parking

(Parking while using the Park Assist system)

Special considerations

(Description of the Park Assist system)

Stopping

(Description of the Park Assist system)

Park Distance Control

(Park Distance Control (PDC))

Malfunction

(Park Distance Control (PDC))

Operating instructions

(Operation)

PDC

(Park Distance Control (PDC))

PDC menu

Signal chimes and screen display

(PDC signal chimes and displays)

Vehicle path display

Parking

(Braking and parking)

Parking brake

(Parking brake (Golf, Golf GTI))

Automatic release

(Electronic parking brake (Golf R))

Automatic switch-on

(Electronic parking brake (Golf R))

Emergency braking function

(Electronic parking brake (Golf R))

Golf, Golf GTI

(Parking brake (Golf, Golf GTI))

Golf R



Releasing

(Electronic parking brake (Golf R))

Setting

(Electronic parking brake (Golf R))

Parking lights

(Switching lights on and off)

Passenger compartment

Passenger front airbag

(Airbag system)

PASSENGER AIR BAG

(PASSENGER AIR BAG light)

PDC

(Park Distance Control (PDC))

Pedals

(Proper seating position)

Performance Monitor

Lap timer and stopwatch

(Performance Monitor lap timer and stopwatch)

Sport gauges

(Performance Monitor sport gauges)

Physical principle of a frontal collision

(Frontal collisions and laws of physics)

Pinch protection

(Power window pinch protection)

Power sunroof

(Pinch protection for the power sunroof)

Power windows

(Power window pinch protection)

Plenum chamber

(Cleaning the engine compartment)

Polishing

(Waxing and polishing vehicle paint)

Pollen filter

(Heating and air conditioning)

Pollutants filter



Power display

(Performance Monitor sport gauges)

Power locking system

Anti-theft alarm system

Description

(Description of the power locking system)

Indicator light in the driver door

Individual door unlocking

(Description of the power locking system)

Keyless Access

(Unlocking or locking the vehicle with)

Power locking button

(Unlocking or locking the vehicle from the inside)

Unlocking or locking from the inside

(Unlocking or locking the vehicle from the inside)

Unlocking or locking from the outside

(Unlocking or locking the vehicle from the outside)

Power outlets

Power sunroof

Convenience opening and closing

(Power sunroof – features)

Malfunction

(Power sunroof)

Opening or closing

(Opening or closing the power sunroof)

Pinch protection

(Pinch protection for the power sunroof)

Power washer

(Washing with a power washer)

Power windows

Convenience opening and closing

(Power windows – features)

Malfunction

(Power windows – features)

One-touch opening and closing

(Power windows – features)



Pinch protection

(Power window pinch protection)

Switches

(Opening or closing power windows)

Preparations

(Preparing to work in the engine compartment)

Adding engine coolant

(Checking engine coolant level and topping off)

Adding engine oil

(Checking the engine oil level and adding oil)

Changing a wheel

(Preparations for changing a wheel)

Checking engine coolant level

(Checking engine coolant level and topping off)

Checking engine oil level

(Checking the engine oil level and adding oil)

Tire mobility set

(Preparations)

Vehicle battery

(Checking the vehicle battery electrolyte level)

Working in the engine compartment

(Preparing to work in the engine compartment)

Preparatory activities

(Getting ready and driving safely)

Progressive steering

(Steering system information)

Push-button start

(Starter button)

Push-starting

(Starting and stopping the engine)

R

Radar sensor

Radio reception



Antenna

(Radio antenna and reception)

Malfunction

Power outlets

Radio antenna and reception

(Power outlets)

Rain sensor

Raising the vehicle

(Lift points for the vehicle)

With the vehicle jack (Golf)

(Lifting the vehicle with the vehicle jack (Golf))

With the vehicle jack (Golf GTI, Golf R)

(Lifting the vehicle with the vehicle jack (Golf GTI, Golf R))

Workshop lift

(Lift points for the vehicle)

Reading lights

(Interior and reading lights)

Rear lid

(Trunk lid)

Rear seat

(Folding the rear seat backrest forward and back into place)

Rear seat backrest

(Folding the rear seat backrest forward and back into place)

Rear Traffic Alert

(Blind Spot Monitor with Rear Traffic Alert)

Rear view

Rear View Camera system

Camera

Cleaning the camera lens

(Camera)

Display

(Operation)

Operating instructions

(Operation)

Parking

Requirements

(Special considerations)



(Manual controls)

Rearview mirror

(Inside mirror)

Recalibrating tire pressure

(Tire Pressure Monitoring System (TPMS) and recalibration through the Infotainment system)

Refueling

(At the gas station)

At the gas station

Checks while refueling

(Refueling checklist)

Fuel

(Refueling)

Fuel gauge

(Indicator lights and fuel gauge)

Indicator light

(Indicator lights and fuel gauge)

Release button

(Automatic transmission: Selector lever)

Remote control vehicle key

(Remote control vehicle keys)

Battery replacement

(Replacing the remote control vehicle key battery)

Indicator light

(Indicator light in the remote control vehicle key)

Synchronizing

(Synchronizing the remote control vehicle key)

Removing

(Removing and reinstalling the front head restraints)

Head restraints

Removing and reinstalling the front head restraints

Removing and reinstalling the rear head restraints

(Removing and reinstalling the front head restraints)

Jumper cables

(Using jumper cables)

Removing wax residue



Repairs

(Parts, accessories, repairs, and modifications)

Replacement keys

(Remote control vehicle keys)

Replacement parts

(Parts, accessories, repairs, and modifications)

Replacing light bulbs

Reporting Safety Defects

Requirements

(Special considerations)

Resetting tire pressure

(Tire Pressure Monitoring System (TPMS) and recalibration through the Infotainment system)

Retrofits

(Repairs and technical modifications)

Roof console

(Symbols on the roof console)

Roof rack

S

Safety belt height adjusters

Safety belt load limiter

(Safety belt retractor, pretensioner, load limiter)

Safety belt position

Safety belt pretensioner

(Safety belt retractor, pretensioner, load limiter)

Safety belt retractor

(Safety belt retractor, pretensioner, load limiter)

Safety belts

Belt position

(Safety belt position)

Belt status display

(Warning light)

Benefits

(Safety belts protect)

Checklist

(Using safety belts)

Cleaning



[Extender](#)

(Safety belt extender)

[Fastening](#)

(Fastening and unfastening safety belts)

[Lockable safety belt](#)

(Using safety belts)

[Not fastened](#)

(What happens to passengers not wearing a safety belt)

[Safety belt height adjusters](#)

[Safety belt load limiter](#)

(Safety belt retractor, pretensioner, load limiter)

[Safety belt pretensioner](#)

(Safety belt retractor, pretensioner, load limiter)

[Safety belt retractor](#)

(Safety belt retractor, pretensioner, load limiter)

[Twisted belt](#)

(Using safety belts)

[Unfastening](#)

(Fastening and unfastening safety belts)

[Using](#)

(Using safety belts)

[Warning light](#)

[Safety chains](#)

(Technical requirements)

[Safety features](#)

(Airbags and how they work)

[Sale of the vehicle](#)

(Operating your vehicle outside of the United States and Canada)

[Seat functions](#)

[Seat heating](#)

[Seating position](#)

(Examples of improper seating positions)

[Seats](#)

(Adjusting the seating position)

[Power seats won't work](#)

(Frequently asked questions (FAQ))



Selector lever

(Automatic transmission: Selector lever)

Selector lever lock

(Automatic transmission: Selector lever)

Self-dimming rearview mirror

(Inside mirror)

Service message, viewing

(Service reminder display)

Service position

(Windshield wiper service position)

Service reminder display

Setting the time

(Displays)

Settings

(Menu and system settings)

Air conditioning

(Operation)

Infotainment system

(Menu and system settings)

Menu and system settings

Presets

(Menu and system settings)

Shift paddles

(Shifting with Tiptronic)

Shifting

Automatic transmission

(Automatic transmission: Selector lever)

Emergency release for the selector lever lock

Gear recommendation

Gearshift lever (manual transmission)

(Manual transmission: Gearshift lever)

Manual transmission

(Manual transmission: Gearshift lever)

Selector lever (automatic transmission)

(Automatic transmission: Selector lever)



(Shifting with Tiptronic)

Shopping bag hooks

Side airbags

Side Curtain Protection airbags

(Side Curtain Protection airbags for 2-door vehicles)

Side view

Sitting

(Adjusting the seating position)

Adjusting the head restraints

(Adjusting the front and rear head restraints)

Adjusting the steering wheel position

Electrical controls on the front seats

(Electrical controls on the driver and front passenger seats)

Manual controls on the front seats

(Manual controls on the driver and front passenger seats)

Number of seats

(Adjusting the seating position)

Proper seating position

Removing and installing the head restraints

Removing and reinstalling the front head restraints

Removing and reinstalling the rear head restraints

(Removing and reinstalling the front head restraints)

Seat heating

Snow chains

All-wheel drive

(Snow chains)

Compact spare wheel

(Snow chains)

Snow removal

(Cleaning windows and outside mirrors)

Snow tires

(Winter tires)

Snowflake symbol

(Displays)

Sockets

(12 Volt sockets in the vehicle)

Spare parts



Spare wheel

(Spare wheel or compact spare wheel)

Driving tips

(Spare wheel or compact spare wheel)

Removing

(Spare wheel or compact spare wheel)

Special considerations

(Dimensions)

Car wash

(Washing the vehicle)

Component protection

Driving with a trailer

Folding outside mirrors in

(Outside mirrors)

Keyless Access

(Unlocking or locking the vehicle with)

Longer periods of non-use

(Power locking system)

Park Assist

(Description of the Park Assist system)

Parking

Dimensions

Braking and parking

Parking

(Dimensions)

Power washer

(Washing with a power washer)

Push-starting

(Starting and stopping the engine)

Radio reception

(Radio antenna and reception)

Rear View Camera system

(Special considerations)

Removing vehicle key

(Vehicle key positions in the ignition switch)

Switching off Auto Hold



Low-starting

(Starting and stopping the engine)

Towing

Towing

Tips on towing

(Towing)

Vehicle washing

(Washing the vehicle)

Vehicles with all-wheel drive (4MOTION)

Towing

Tips on towing

(Towing)

Washing the vehicle

(Unlocking or locking the vehicle with)

Water under vehicle

(Operation)

Wipers

(Windshield wiper lever)

Speed rating code letter

(Tire labeling)

Speed warning

(Driving data)

Sport gauges

(Performance Monitor sport gauges)

Stalling

(Protecting yourself and the vehicle)

Starter button

Starting assistance systems

(Indicator light)

Starting the engine

(Indicator lights)

Static cornering lights

(Lights and vision – features)

Steering

(Tire wear and damage)

Counter-steering assistance



Electromechanical

(Steering system information)

Indicator light

(Warning and indicator lights)

Progressive steering

(Steering system information)

Pulling to one side

(Tire wear and damage)

Servo steering

(Steering system information)

Steering column lock

Steering system information

Vibration

(Tire wear and damage)

Warning light

(Warning and indicator lights)

Steering wheel

(Adjusting the steering wheel position)

Adjusting

(Adjusting the steering wheel position)

Shift paddles (Tiptronic)

(Shifting with Tiptronic)

Stopping the engine

Stopwatch

(Performance Monitor sport gauges)

Storage areas

Storage compartments

(Interior and reading lights)

Cleaning

(Cleaning storage compartments and cup holders)

Coin holders (Golf, Golf GTI)

(Coin holders in the front center console (Golf, Golf GTI))

Driver side

(Storage compartment on the driver side)

Eyeglass storage compartment

(Eyeglass storage compartment in the overhead console)



[Front center console](#)

(Storage compartment in the front center console)

[Glove compartment](#)

[Other storage compartments](#)

[Overhead console](#)

(Eyeglass storage compartment in the overhead console)

[Owner's Manual](#)

(Glove compartment)

[Passenger side](#)

(Glove compartment)

[Storage compartment light](#)

(Interior and reading lights)

[Storage compartment under the front seat](#)

[Stowing luggage](#)

[Subwoofer](#)

(Removing the subwoofer)

[Reinstalling](#)

(Removing the subwoofer)

[Removing](#)

(Removing the subwoofer)

[Sun protection](#)

[Sun visors](#)

[Sunroof](#)

(Power sunroof)

[Suspected malfunction](#)

(Frequently asked questions (FAQ))

[Symbols](#)

(Warning and indicator lights)

[Systems](#)

(Lights and vision – features)

[Adaptive chassis control DCC](#)

(Driving Mode Selection)

[Adaptive Cruise Control \(ACC\)](#)

[Adaptive Front Lighting System](#)

(Lights and vision – features)

[Anti-Lock Brake System \(ABS\)](#)



Anti-Slip Regulation (ASR)

Braking assistance systems

Switching Anti-Slip Regulation (ASR) and ESC Sport mode on and off

(Braking assistance systems)

Automatic headlights

(Lights and vision – features)

Automatic Post-Collision Braking System

(Braking assistance systems)

Auto Hold

(Auto Hold (Golf R))

Blind Spot Monitor

(Blind Spot Monitor with Rear Traffic Alert)

Brake Assist (BAS)

(Braking assistance systems)

Cruise control

Driving Mode Selection

Electronic Differential Lock (EDL and XDL)

(Braking assistance systems)

Electronic Stability Control (ESC)

(Braking assistance systems)

ESC Sport

Braking assistance systems

Switching Anti-Slip Regulation (ASR) and ESC Sport mode on and off

(Braking assistance systems)

Front Assist

(Forward Collision Warning (Front Assist))

Hill Start Assist

(Hill Start Assist (Hill Hold))

Launch control program

(Driving with automatic transmission)

Light Assist

Park Distance Control

(Park Distance Control (PDC))

Rear Traffic Alert

(Blind Spot Monitor with Rear Traffic Alert)

Rear View Camera system

Tire Pressure Monitoring System (TPMS)



(Tire Pressure Monitoring System (TPMS))

T

Tachometer

(Instrument overview)

Technical data

Axle weight

(Weights and axle weights)

Curb weight

(Weights and axle weights)

Dimensions

Displacement

(Engine data)

Engine data

Engine oil capacity

(Engine oil capacities)

Engine oil specifications

Fuel capacities

Gross vehicle weight

(Weights and axle weights)

Output

(Engine data)

Roof load

(Securing a load on the roof rack)

Safety compliance label

(Important vehicle labels)

Tire inflation pressure

Vehicle identification label

(Important vehicle labels)

Washer fluid filling capacity

(Checking and refilling windshield washer fluid)

Weights

(Weights and axle weights)

Technical modifications

(Repairs and technical modifications)

Temperature gauge



Think Blue. Trainer.

Tie-downs

Tightening torque

(Wheel bolts)

Time

(Displays)

TIN

(Tire labeling)

Tiptronic

(Shifting with Tiptronic)

Tire damage

(Tire wear and damage)

Tire inflation pressure

Checking

(Tire inflation pressure)

Compact spare wheel

(Tire inflation pressure)

Spare wheel

(Tire inflation pressure)

Tire mobility set

Check after 10 minutes

(Check after 10 minutes of driving)

Contents

(Contents of the tire mobility set)

Inflating tire

(Sealing and inflating the tire)

Preparations

Sealing tire

(Sealing and inflating the tire)

See Tire mobility set

(Tire mobility set)

When not to use

(Tire mobility set)

Tire Pressure Monitoring System (TPMS)

(Tire inflation pressure)

Indicator light



Malfunction

(Indicator light (telltale))

Resetting the tire pressure

(Tire Pressure Monitoring System (TPMS) and recalibration through the Infotainment system)

Tire inflation pressure

Tire repair set

(Tire mobility set)

Tire wear

(Tire wear and damage)

Tires

(Tires and wheels)

Tires and wheels

Avoiding damage

(Tire and wheel handling)

Break-in period

(New and replacement tires)

Changing a wheel

Compact spare wheel

(Spare wheel or compact spare wheel)

Determine load limit

(Determining the correct load limit)

Embedded objects

(Tire wear and damage)

Imbalance

(Tire wear and damage)

Incorrect wheel alignment

(Tire wear and damage)

Labeling

(Tire labeling)

Load rating code of the tires

(Tire labeling)

New tires

(New and replacement tires)

Older tires

(Tire and wheel handling)



Rotating tires

(Tire and wheel handling)

Serial number

(Tire labeling)

Snow chains

Spare wheel

(Spare wheel or compact spare wheel)

Speed rating code

(Tire labeling)

Speed rating code letter

(Tire labeling)

Stowing the replaced wheel

(Spare wheel or compact spare wheel)

Technical data

(Tire labeling)

Tire and wheel handling

Tire damage

(Tire wear and damage)

Tire identification number (TIN)

(Tire labeling)

Tire inflation pressure

Tire inflation pressure in cold tires

Tire labeling

Tire pressure gauge

(Tire inflation pressure)

Tire storage

(Tire and wheel handling)

Tire wear

(Tire wear and damage)

Traction

(Tire labeling)

Tread depth

(Tread depth and tread wear indicators)

Tread wear indicator

(Tread depth and tread wear indicators)



Tire labeling

(Tire and wheel handling)

UTQG classification

Valve caps

(Tire inflation pressure)

Wheel balancing

(Tire wear and damage)

Wheel rims

When more than one tire is damaged

(Changing a wheel)

Winter tires

Tongue weight

(Loading the trailer)

Tools

(Vehicle tool kit)

Tow-starting

(Starting and stopping the engine)

Towing

Automatic transmission

Towing on a commercial tow truck

Tips on towing

(Towing on a commercial tow truck)

Driving tips

(Driving tips while towing)

Front towing eye

(Installing the front towing eye)

Manual transmission

Towing on a commercial tow truck

Tips on towing

(Towing on a commercial tow truck)

Rear towing eye

(Installing the rear towing eye)

Special considerations

(Towing)

Tow bar

Towing

Tips on towing

(Towing)



Tips on towing

(Towing)

Tow truck

(Towing on a commercial tow truck)

Towing prohibition

(Tips on towing)

Vehicles with all-wheel drive (4MOTION)

Towing

Tips on towing

(Towing)

With trailer hitch

(Tips on towing)

Towing a trailer

(Trailer towing)

Towing capacity

(Loading the trailer)

TPMS

(Tire Pressure Monitoring System (TPMS))

Trailer

(Trailer towing)

Connecting

(Hitching up and connecting a trailer)

Driving

(Driving with a trailer)

Driving with a trailer

Headlight settings

(Driving with a trailer)

Hitching

(Hitching up and connecting a trailer)

Loading

(Loading the trailer)

Outside mirrors

(Technical requirements)

Retrofitting a trailer hitch

Safety chains

Technical requirements



Taillights

[Technical requirements](#)

[Hitching up and connecting a trailer](#)

(Technical requirements)

[Technical requirements](#)

[Tongue weight](#)

(Loading the trailer)

[Towing](#)

(Trailer towing)

[Towing capacity](#)

(Loading the trailer)

[Trailer hitch](#)

(Trailer towing)

[Ball mount](#)

[Retrofit](#)

(Retrofitting a trailer hitch)

[See Trailer](#)

(Trailer towing)

[Transporting](#)

[Driving tips](#)

(Driving a loaded vehicle)

[Driving with a trailer](#)

[Driving with an open trunk lid](#)

[Luggage compartment pass-through](#)

[Roof rack](#)

[Roof rack](#)

[Securing a load on the roof rack](#)

(Roof rack)

[Shopping bag hooks](#)

[Stowing luggage](#)

[Tie-downs](#)

[Trailer loading](#)

(Loading the trailer)

[Trailer towing](#)

[Transporting children in vehicles](#)

(Important safety instructions for using child restraints)

[Trip odometer](#)

(Instrument overview)



Trunk lid

(Unlocking or locking the vehicle from the outside)

Closing and locking

(Closing the trunk lid)

Display in the instrument cluster

(Display)

Driving with an open trunk lid

Opening

(Opening the trunk lid)

Opening the trunk lid from inside the luggage compartment

Unlocking or locking

(Unlocking or locking the vehicle from the outside)

Turn signal lever

(Turn signal lever and high beam switch)

U

UCRA

(Child safety and child restraints)

Undercoating

Unidirectional tires

(Tire labeling)

Unlocking

(Unlocking or locking the vehicle from the outside)

From inside the vehicle

(Unlocking or locking the vehicle from the inside)

From outside the vehicle

(Unlocking or locking the vehicle from the outside)

Problems

(Frequently asked questions (FAQ))

Trunk lid

(Opening the trunk lid)

Vehicle

(Unlocking or locking the vehicle from the outside)

with Keyless Access

(Unlocking or locking the vehicle with)



Care

(Caring for upholstery)

Care and cleaning of leather upholstery

Caring for upholstery

Checklist

(Caring for upholstery)

Cleaning fabric trim

(Cleaning upholstery, fabric trim, and microfiber fabric)

Cleaning microfiber fabric

(Cleaning upholstery, fabric trim, and microfiber fabric)

Cleaning upholstery

(Cleaning upholstery, fabric trim, and microfiber fabric)

Leatherette

(Cleaning leatherette)

USB port

(Storage compartment in the front center console)

UTQG classification

V

Valve caps

(Tire inflation pressure)

Vanity mirror

(Sun visors)

Variable luggage compartment floor

Vehicle

(Unlocking or locking the vehicle from the outside)

Loading

(Driving tips)

Odd driving behavior

(Frequently asked questions (FAQ))

Protective action in case of breakdown

(Protecting yourself and the vehicle)

Stopping on a hill

(Parking)

Unlocking or locking from the inside



Unlocking or locking from the outside

(Unlocking or locking the vehicle from the outside)

Unlocking or locking the vehicle with Keyless Access

(Unlocking or locking the vehicle with)

Vehicle battery

(Power locking system)

Automatic load deactivation

(Charging, replacing, disconnecting, and connecting the vehicle battery)

Battery acid

(Checking the vehicle battery electrolyte level)

Battery drain

Automatic transmission: Selector lever

Charging, replacing, disconnecting, and connecting the vehicle battery

(Automatic transmission: Selector lever)

Charging

(Charging, replacing, disconnecting, and connecting the vehicle battery)

Checking acid level

(Checking the vehicle battery electrolyte level)

Connecting

(Charging, replacing, disconnecting, and connecting the vehicle battery)

Disconnecting

(Charging, replacing, disconnecting, and connecting the vehicle battery)

Drain

Power locking system

Vehicle key positions in the ignition switch

Starter button

Protecting yourself and the vehicle

(Power locking system)

Earth connection for jump leads

(Jump-start terminal)

Installation location

(Vehicle battery)

Jump-starting

(Using jumper cables)

Preparations

(Checking the vehicle battery electrolyte level)



Symbol explanation

(Vehicle battery)

Warning light

Vehicle care

(Light Assist)

Airbag module (instrument panel)

(Care and cleaning of plastic components, wood trim, and instrument panel)

Aluminum parts

(Caring for and cleaning chrome and aluminum parts)

Anodized surfaces

(Caring for and cleaning chrome and aluminum parts)

Camera view area

(Light Assist)

Car wash

(Washing the vehicle)

Caring for upholstery

Chrome parts

(Caring for and cleaning chrome and aluminum parts)

Cleaning the safety belts

(Cleaning the safety belts)

Cleaning storage compartments

(Cleaning storage compartments and cup holders)

Cleaning wheel rims

Cleaning wiper blades

(Cleaning and changing the windshield wiper blades)

Deicing door lock cylinders

Door and window seals

(Caring for rubber door and window seals)

Engine compartment

(Cleaning the engine compartment)

Exterior

(Exterior care and cleaning)

Fabric trim

(Cleaning upholstery, fabric trim, and microfiber fabric)

Heated seats



Instrument panel

(Care and cleaning of plastic components, wood trim, and instrument panel)

Interior

(Interior care and cleaning)

Leather

(Care and cleaning of leather upholstery)

Leatherette

(Cleaning leatherette)

Manual seats

(Cleaning upholstery, fabric trim, and microfiber fabric)

Microfiber fabric

(Cleaning upholstery, fabric trim, and microfiber fabric)

Non-heated seats

(Cleaning upholstery, fabric trim, and microfiber fabric)

Outside mirrors

(Cleaning windows and outside mirrors)

Plastic components

(Care and cleaning of plastic components, wood trim, and instrument panel)

Power seats

(Cleaning upholstery, fabric trim, and microfiber fabric)

Power washer

(Washing with a power washer)

Replacing wiper blades

(Cleaning and changing the windshield wiper blades)

Seats with airbag components

(Cleaning upholstery, fabric trim, and microfiber fabric)

Seats without airbag components

(Cleaning upholstery, fabric trim, and microfiber fabric)

Service position

(Windshield wiper service position)

Special considerations

Washing the vehicle

Washing with a power washer

(Washing the vehicle)

Undercoating



Vehicle paint

(Waxing and polishing vehicle paint)

Washing by hand

(Washing the vehicle)

Washing the vehicle

Windows

(Cleaning windows and outside mirrors)

Windshield-integrated antenna

(Radio antenna and reception)

Wood trim

(Care and cleaning of plastic components, wood trim, and instrument panel)

Vehicle identification label

(Important vehicle labels)

Vehicle identification number

(Important vehicle labels)

Vehicle keys

(Vehicle key set)

Assignment

(Remote control vehicle keys)

Battery replacement

(Replacing the remote control vehicle key battery)

Indicator light

(Indicator light in the remote control vehicle key)

Panic button

(Remote control vehicle keys)

Synchronizing

(Synchronizing the remote control vehicle key)

Vehicle labels

(Important vehicle labels)

Vehicle modifications

(Parts, accessories, repairs, and modifications)

Vehicle overview

(Side view)

Front view



[Warning and indicator lights](#)

[Vehicle path display](#)

[Vehicle settings](#)

(Vehicle settings menu)

[Vehicle tool kit](#)

[Contents](#)

[Storage](#)

[Vehicle washing](#)

(Washing the vehicle)

[Vehicles with all-wheel drive \(4MOTION\)](#)

(Towing)

[Volkswagen Information System](#)

[Displays](#)

(Menu structure – overview)

[Menu structure](#)

(Menu structure – overview)

W

[Warning and indicator lights](#)

[Warning chime](#)

(Warning light)

[Warning lights](#)

(Warning light)

[Adaptive Cruise Control](#)

(Display, warning and indicator lights)

[Alternator](#)

(Warning light)

[Applying the brake](#)

(Warning and indicator lights)

[Brake system](#)

(Warning and indicator lights)

[Depress brake pedal](#)

(Driver warnings and Autonomous Emergency Braking)

[Engine coolant](#)

(Warning light and engine coolant temperature gauge)

[Engine oil pressure](#)

(Warning and indicator lights)



[*Shifting*](#)

(Warning and indicator lights)

[*Steering column lock*](#)

(Warning and indicator lights)

[*Vehicle battery*](#)

(Warning light)

[*Washing*](#)

(Washing the vehicle)

[*Washing the vehicle*](#)

(Unlocking or locking the vehicle with)

Sensors

[*Park Distance Control \(PDC\)*](#)

[*Park Assist*](#)

(Park Distance Control (PDC))

[*Special considerations*](#)

(Unlocking or locking the vehicle with)

[*Washing with a power washer*](#)

[*Waxing the paint*](#)

(Waxing and polishing vehicle paint)

[*Weights*](#)

(Weights and axle weights)

[*What happens to passengers not wearing a safety belt*](#)

[*What if?*](#)

(Frequently asked questions (FAQ))

[*Wheel bolts*](#)

(Wheel bolt caps)

[*Cover caps*](#)

(Wheel bolt caps)

[*Tightening torque*](#)

(Wheel bolts)

[*Wheel change*](#)

(Changing a wheel)

[*Wheel covers*](#)

(Hubcaps)

[*Full wheel cover*](#)



Hubcaps

Wheel bolt caps

Wheel rims

Bolted decorative cover

(Wheel rims)

Bolted rim ring

(Wheel rims)

Cleaning

(Cleaning wheel rims)

Wheel trim

Windows

(Power windows)

Windshield

(Light Assist)

Checking for damage

(Light Assist)

Insulated

(Windshield made of heat-insulating glass)

Windshield washer

(Windshield wipers and washer)

Windshield washer fluid

(Indicator light)

Checking

(Checking and refilling windshield washer fluid)

Indicator light

Refilling

(Checking and refilling windshield washer fluid)

Windshield wipers

(Windshield wipers and washer)

Functions

(Windshield wiper functions)

Headlight washer system

(Windshield wiper functions)

Heated washer nozzles

(Windshield wiper functions)

Lifting the wiper blade



[Rain sensor](#)

[Service position](#)

(Windshield wiper service position)

[Special considerations](#)

(Windshield wiper lever)

[Windshield wiper lever](#)

[Windshield-integrated antenna](#)

(Radio antenna and reception)

[Winter operation](#)

(Power sunroof)

[Fuel consumption](#)

(Fuel-efficient driving)

[Headlight washer system](#)

(Windshield wiper functions)

[Heated washer nozzles](#)

(Windshield wiper functions)

[Power sunroof](#)

[Snow chains](#)

[Tire pressure](#)

(Tire inflation pressure)

[Trailer towing](#)

[Tread depth](#)

(Tread depth and tread wear indicators)

[Winter tires](#)

[Winter tires](#)

[All-wheel drive](#)



[Purchase Owner's Literature](#)

[Terms](#)

[Privacy](#)

* This Online Owner's Manual may not include Supplements issued after the publication of the physical Owner's Manual. Please consult your physical Owner's literature. In the event of a discrepancy between the Online Owner's Manual and physical Owner's literature, the physical Owner's literature controls.

"Volkswagen" and the Volkswagen logo are registered trademarks of Volkswagen AG. © 2018 Volkswagen of America, Inc.

(Cleaning and changing the windshield wiper blades)



Wrench symbol

(Service reminder display)

X

XDL

(Braking assistance systems)