



# Owner's Manual

2015 Audi A4 | S4

Audi  
Vorsprung durch Technik





2015 Audi A4 Sedan

2015 Audi S4 Sedan

2015 Audi allroad

## **Foreword**

Thank you for choosing an Audi - we value your trust in us.

Your new Audi will allow you to experience the best in groundbreaking technology and premium quality equipment a vehicle has to offer. We recommend that you read your Owner's Manual thoroughly so that you quickly become acquainted with your Audi and make use of all of its features.

In addition to explaining how the different features work, we provide many useful tips and information concerning your safety, how to care for your vehicle and how to maintain your vehicle's value. We also give you useful tips and information on how to drive your vehicle more efficiently and in an environmentally friendly manner.

In the Owner's Manual packet, you will also find an Owner's Manual for your Infotainment system and the vehicle maintenance schedule.

We hope you enjoy driving your Audi and we wish you safe and pleasant motoring.

**AUDI AG**

<b>Vehicle literature</b> .....	5	<b>Warm and cold</b> .....	78
		Climate controls .....	78
<b>About this Owner's Manual</b> ...	6	<b>On the road</b> .....	82
<b>Controls and equipment</b> .....	8	Steering .....	82
<b>Instruments and controls</b> .....	8	Ignition lock .....	82
General illustration .....	8	Convenience key .....	85
<b>Instruments and warning/ indicator lights</b> .....	10	Driver messages .....	86
Instruments .....	10	Electromechanical parking brake ....	87
Warning/indicator lights .....	13	Speed warning system .....	89
<b>Driver information display</b> .....	23	Cruise control .....	91
Introduction .....	23	<b>Transmission</b> .....	93
Trip computer .....	24	Manual transmission .....	93
Gearshift Indicator .....	26	multitronic, S tronic, tiptronic .....	93
Efficiency program .....	26	<b>Audi adaptive cruise control and braking guard</b> .....	101
Service interval display .....	28	Introduction .....	101
On-Board Diagnostic system (OBD) ...	29	General information .....	101
<b>Opening and closing</b> .....	31	Audi adaptive cruise control .....	103
Power locking system .....	31	Audi braking guard .....	107
Rear lid .....	38	Messages .....	109
Child safety locks .....	41	<b>Audi side assist</b> .....	111
Power windows .....	42	Lane change assistant .....	111
Sunroof .....	43	<b>Audi drive select</b> .....	115
Valet parking .....	45	Driving settings .....	115
Garage door opener (HomeLink) .....	45	<b>Park assist</b> .....	118
<b>Clear vision</b> .....	49	Parking system .....	118
Lights .....	49	Parking system (rear) .....	118
Interior lights .....	52	Parking system (rear, with rear view camera) .....	120
Vision .....	52	<b>Safety first</b> .....	126
Wiper and washer system .....	55	<b>Driving Safely</b> .....	126
Digital compass .....	58	General notes .....	126
<b>Seats and storage</b> .....	60	Proper occupant seating positions ...	127
General recommendations .....	60	Pedal area .....	131
Front seats .....	61	Stowing luggage .....	132
Head restraints .....	63	Reporting Safety Defects .....	134
Seat memory .....	64	<b>Safety belts</b> .....	136
Ashtray .....	65	General notes .....	136
Cigarette lighter .....	65	Why safety belts? .....	137
12-volt socket .....	66		
Storage .....	66		
Roof rack .....	69		
Luggage compartment .....	70		

Safety belts . . . . .	139	<b>Vehicle care</b> . . . . .	202
Safety belt pretensioners . . . . .	142	<b>Vehicle care and cleaning</b> . . . . .	202
<b>Airbag system</b> . . . . .	144	General information . . . . .	202
Important things to know . . . . .	144	Car washes . . . . .	202
Front airbags . . . . .	148	Cleaning and care information . . . . .	203
Monitoring the Advanced Airbag System . . . . .	154	<b>Fuel supply and filling your fuel tank</b> . . . . .	207
Side airbags . . . . .	159	Gasoline . . . . .	207
Side curtain airbags . . . . .	162	Fuel tank . . . . .	209
<b>Child Safety</b> . . . . .	165	<b>Checking and filling</b> . . . . .	212
Important things to know . . . . .	165	Engine hood . . . . .	212
Child safety seats . . . . .	171	Engine compartment . . . . .	214
Installing a child safety seat . . . . .	175	Engine oil . . . . .	214
LATCH Lower anchorages and tether for children . . . . .	179	Engine cooling system . . . . .	218
Additional Information . . . . .	183	Brake fluid . . . . .	221
<b>Vehicle operation</b> . . . . .	184	Battery . . . . .	222
<b>Intelligent technology</b> . . . . .	184	Windshield/headlight* washer container . . . . .	225
Notice about data recorded by the Event Data Recorder and vehicle control modules . . . . .	184	<b>Tires and wheels</b> . . . . .	227
Electronic Stabilization Control (ESC) .	185	Tires . . . . .	227
Braking . . . . .	188	Tire pressure monitoring system . . . . .	257
Electro-mechanical power assist, dynamic steering . . . . .	190	<b>Do-it-yourself service</b> . . . . .	260
Driving with your quattro . . . . .	190	<b>What do I do now?</b> . . . . .	260
Energy management . . . . .	191	Vehicle tool kit . . . . .	260
<b>Driving and environment</b> . . . . .	193	Space-saving spare tire (compact spare tire) . . . . .	260
The first 1,000 miles (1,500 km) and afterwards . . . . .	193	Inflatable spare tire . . . . .	261
Avoid damaging the vehicle . . . . .	193	Inflating inflatable spare tire . . . . .	262
Driving through water on roads . . . . .	193	Changing a wheel . . . . .	263
Catalytic converter . . . . .	194	<b>Fuses and bulbs</b> . . . . .	269
Shutting down vehicle . . . . .	195	Fuses . . . . .	269
Operate your vehicle economically and minimize pollution . . . . .	195	Bulbs . . . . .	272
allroad: Driving offroad . . . . .	197	<b>Emergency situations</b> . . . . .	274
<b>Trailer towing</b> . . . . .	199	General . . . . .	274
Driving with a trailer . . . . .	199	Starting by pushing or towing . . . . .	274
Trailer towing tips . . . . .	201	Starting with jumper cables . . . . .	274
		Use of jumper cables . . . . .	275
		Emergency towing with commercial tow truck . . . . .	276
		Lifting vehicle . . . . .	278

<b>Technical data</b> .....	280
<b>Technical Data</b> .....	<b>280</b>
Vehicle identification .....	280
Weights .....	280
Dimensions .....	281
Capacities .....	281
Gasoline engines .....	282
<b>Consumer Information</b> .....	<b>283</b>
Warranty coverages .....	283
Operating your vehicle outside the U.S.A. or Canada .....	283
Audi Service Repair Manuals and Literature .....	283
Maintenance .....	283
Additional accessories, modifications and parts replacement .....	285
Declaration of Compliance, Telecommunications and Electronic Systems .....	286
<b>Index</b> .....	<b>288</b>

In addition to this Owner's Manual, your Audi comes with a Warranty & Maintenance booklet.

Moreover, depending on the model and the equipment, there may be additional instruction booklets delivered with your vehicle (for example, Operating Instructions for your Sound System, Navigation System etc.).

If you are missing one of these publications, or if you believe that the information is not complete, contact your authorized Audi dealer for assistance.

### **The Warranty & Maintenance booklet**

explains how you can keep your Audi in top driving condition by having it serviced regularly and contains detailed information about the warranties covering your Audi. Always have the booklet with you when you take your vehicle to an authorized Audi dealer for service. Your Audi Service Advisor will record each scheduled service and can answer any questions you may have regarding how to maintain your vehicle.

### **In Canada,**

the vehicle literature is also available in French. To obtain a copy, contact your dealer or write to:

Au Canada, on peut se procurer un exemplaire en français de ce document auprès du concessionnaire ou de:

Audi Canada  
Client Assistance  
Assistance a la Clientele  
777 Bayly Street, West,  
Ajax, Ontario L1S 7G7

### **If you sell your Audi**

all literature should be left in the vehicle to make the Warranty terms as well as all operating, safety and maintenance information available to the next owner.

### **If you change your address or if you bought this Audi used**

be sure to send in a "Notice of Address Change" / "Notice of Used Car Purchase" post card. This card can be found in the Warranty & Maintenance booklet or obtained from your authorized Audi dealer.

**It is in your own interest that we are able to contact you should the need arise.**

This owner's manual contains important information, tips, suggestions, and warnings for the use of your vehicle.

Make sure that this owner's manual is always located in the vehicle. This is especially important if you allow other people to drive the vehicle, or if you sell it.

This owner's manual describes the **equipment range** specified for this model at the editorial deadline date. Some of the equipment described here will only be available at a later date, or only in specific markets.

Some sections in this owner's manual do not apply to all vehicles. In that case, the **range of applicability** is given at the beginning of the section, e. g., "Applies to vehicles: with advanced parking system". In addition, optional or vehicle-specific equipment is indicated by an asterisk "\*".

**Illustrations** may be different from those in your vehicle, and are intended to be viewed as a basic guide.

You will find a **table of contents** at the beginning of this book, which displays all topics described in this manual in order of appearance. You will find an alphabetical **index** at the end of this book.

All **directions**, such as "left", "right", "front", "back", are relative to the direction of travel.

- \* Optional or vehicle-specific equipment
- ▶ This section continues on the next page.

⇒ ⚠ Cross-reference to a "WARNING!" within a section. For indication with a page number, the corresponding "WARNING!" can be found outside of the section.

### **WARNING**

Text with this symbol contains important information on safety and how to reduce the risk of personal injury or death.

### **Note**

Text with this symbol draws your attention to potential sources of damage to your vehicle.

### **For the sake of the environment**

Text with this symbol contains information about the environment and how you can help protect it.

### **Tips**

Text with this symbol contains special tips and other information about getting the most out of your vehicle and its features.



## Instruments and controls

### General illustration

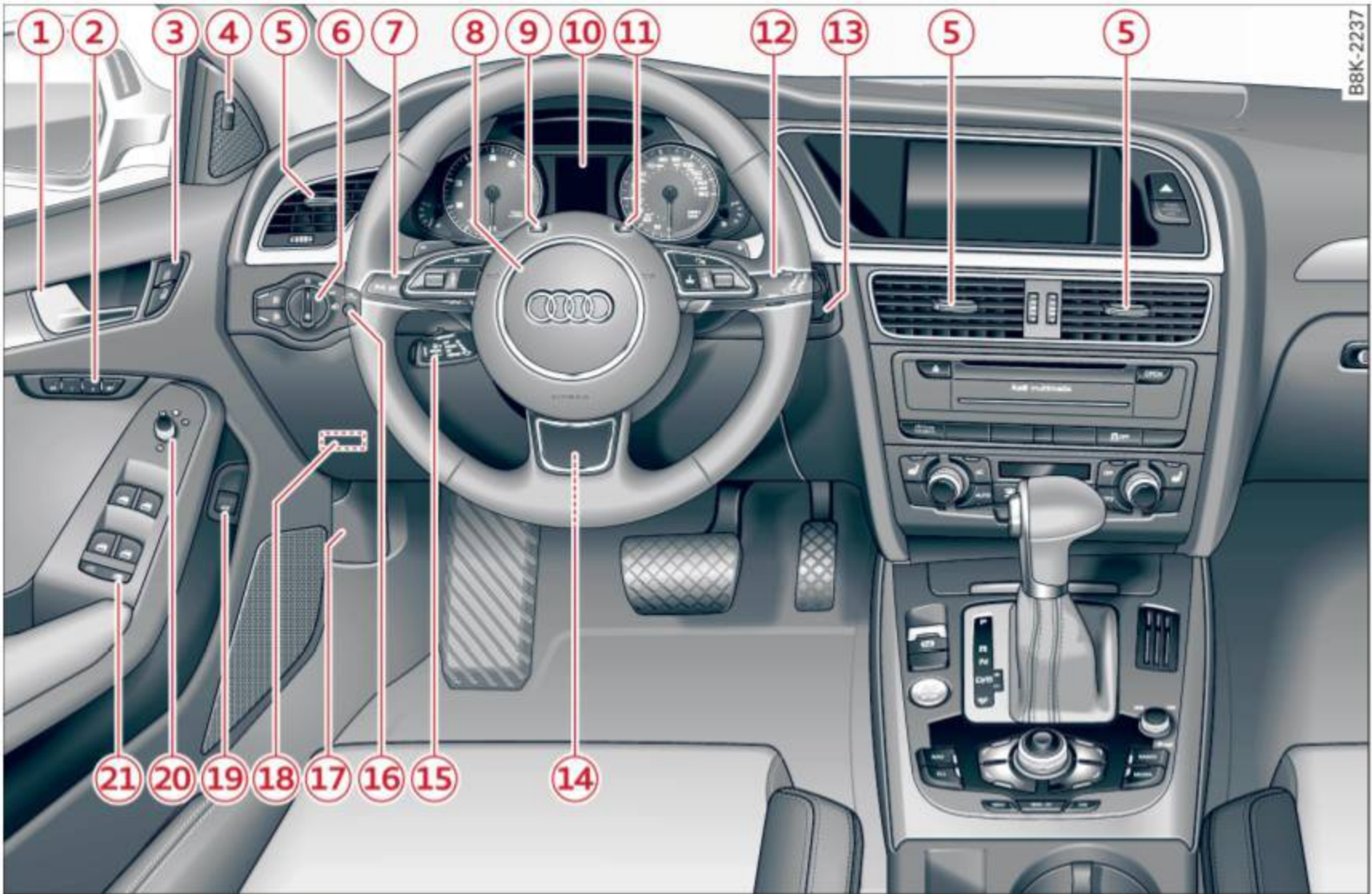

Fig. 1 Cockpit: left section

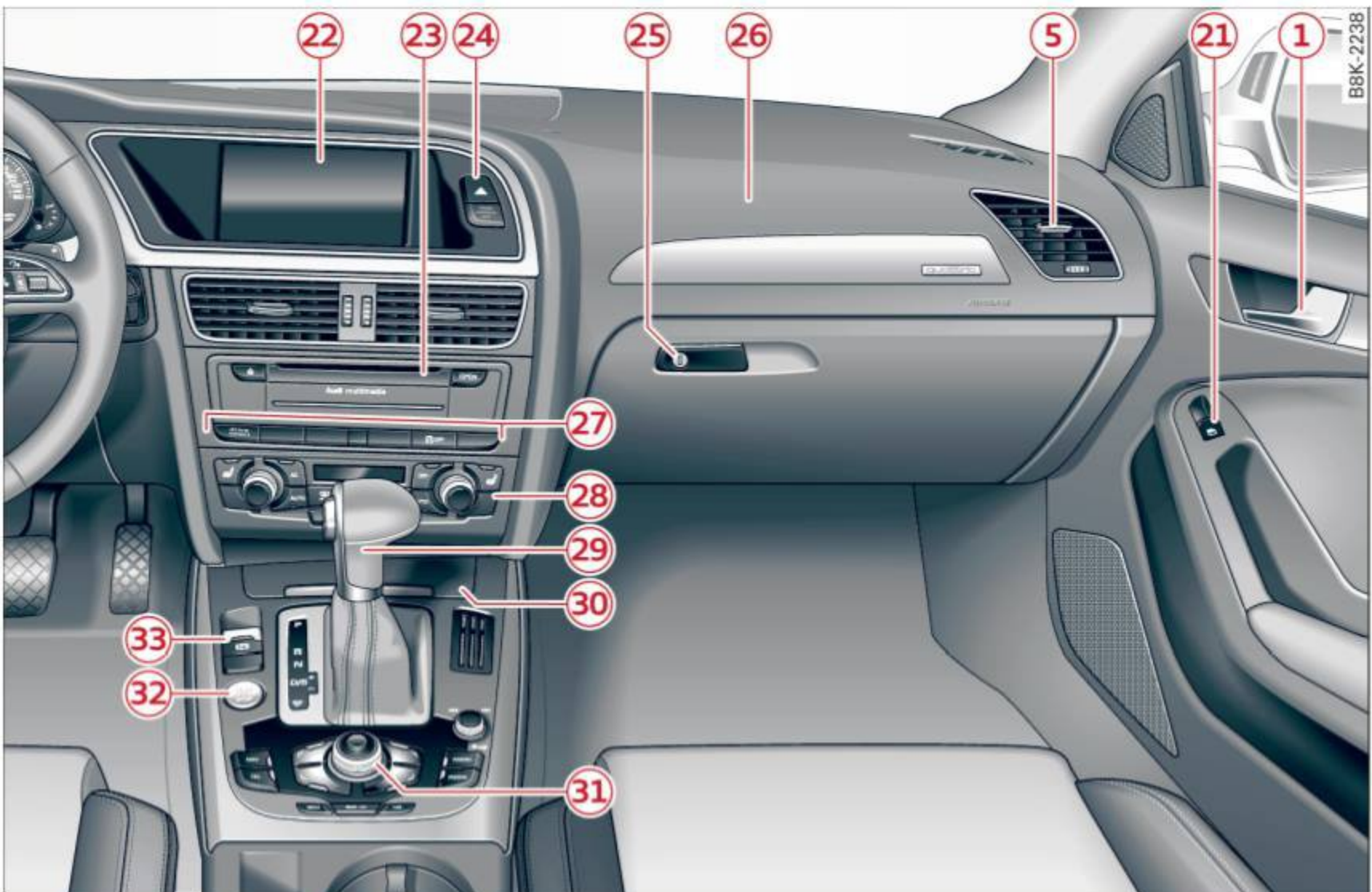

Fig. 2 Cockpit: right section

① Door handle		
② Memory buttons (driver's seat)	64	
③ Power locking switch	35	
④ Button for side assist	111	
⑤ Air outlets		
⑥ Light switch	49	
⑦ Control lever for:		
– Turn signal and high beam	50	
⑧ Multifunction steering wheel with:		
– Horn		
– Driver's airbag	148	
– Audio/video, telephone, navigation and voice recognition buttons		
– Rocker switches for tiptronic operation	98	
⑨ <b>SET</b> button	11	
⑩ Instrument cluster	10	
⑪ Reset button for trip odometer	12	
⑫ Switches for:		
– Windshield wiper/washer	55	
– Trip computer	24	
⑬ Ignition lock	82	
⑭ Adjustable steering column	82	
⑮ Control lever for:		
– Cruise control	91	
– adaptive cruise control	101	
⑯ Instrument lighting	52	
⑰ Release lever for the engine hood	212	
⑱ Data Link Connector for On Board Diagnostics (OBD II)	29	
⑲ Switch for unlocking the trunk lid	38	
⑳ Adjuster control for outside mirrors	52	
㉑ Power window switches	42	
㉒ Radio-Display <sup>1)</sup> or MMI-Display		
㉓ Depending on options:		
– Radio system		
– CD changer		
㉔ Emergency flasher	51	
㉕ Glove compartment (lockable)	67	
㉖ Front passenger's airbag	148	
㉗ Depending on options, switches for:		
– drive select	115	
– Electronic Stabilization Control	185	
– Rear window sun shade	55	
㉘ Deluxe automatic climate control	78	
㉙ Depending on options, selector lever or shift lever for:		
– Manual transmission	93	
– Automatic transmission	93	
㉚ Ashtray with cigarette lighter	65	
㉛ Depending on options:		
– MMI control console or		
– drive select	115	
– Electronic Stabilization Control button	185	
– Power switch for rear window sun shade	55	
㉜ <b>START ENGINE STOP</b> button	85	
㉝ Electromechanical parking brake	87	

### **i** Tips

- Some of the equipment or features shown in the general illustration may be standard equipment on your vehicle or may be optional equipment depending on your model. Always ask your authorized Audi dealer if you have a question about your vehicle.
- Operation of the Multi Media Interface (MMI) is described in a separate manual.

<sup>1)</sup> The image in the display will appear either in multiple colors or in a single color, depending on the vehicle equipment. The multi color image will be used in this Owner's Manual because both multi color and single color versions are almost identical.

## Instruments and warning/indicator lights

### Instruments

#### Instrument cluster and controls

The instrument cluster is your central source of information.

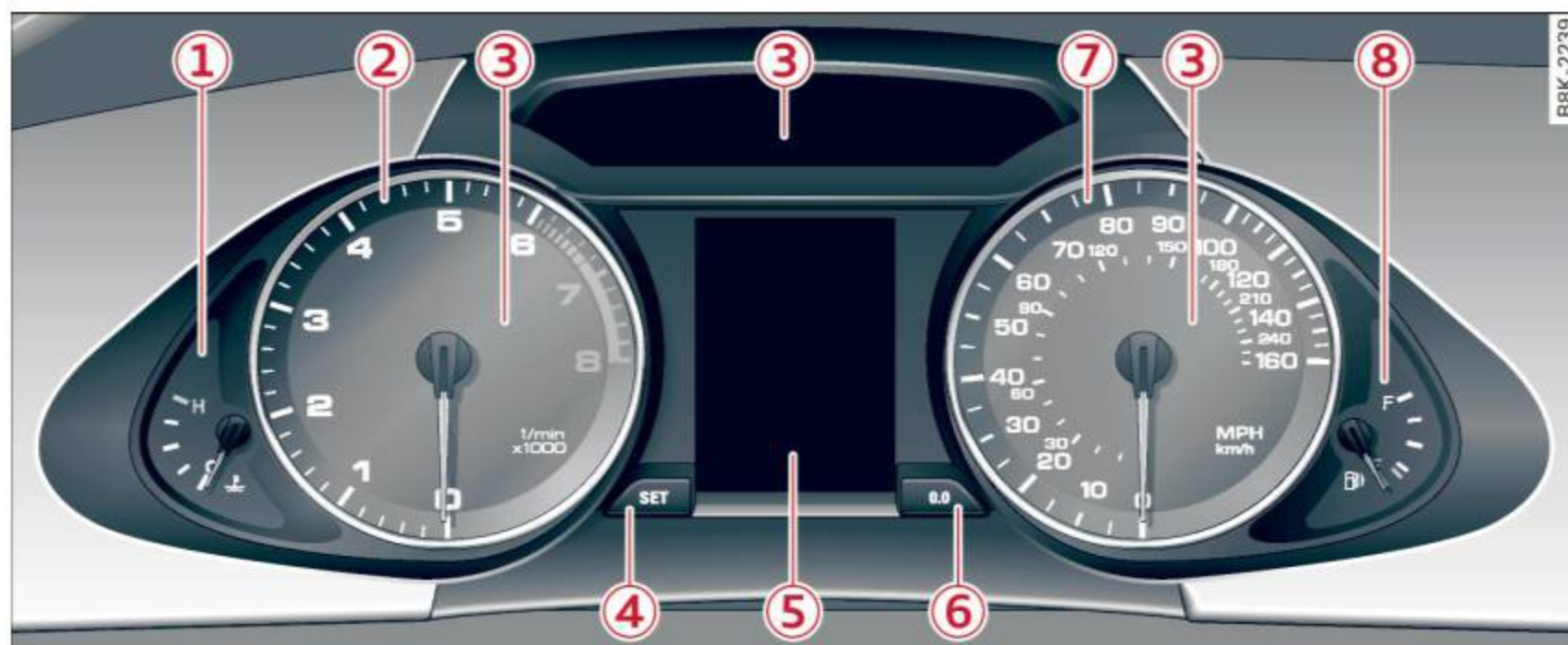

Fig. 3 Overview of the instrument cluster

①	Coolant temperature gauge . . .	10
②	Tachometer . . . . .	11
③	Warning/indicator lights . . . . .	13
④	SET button . . . . .	11
⑤	Display	
	– Driver information system . . .	23
	– Time and date display . . . . .	12
	– Odometer . . . . .	12
⑥	Reset button for trip odometer	12
⑦	Speedometer	
⑧	Fuel gauge . . . . .	12

#### **i** Tips

- When switching the ignition on, the needles in the instrument cluster swing upward briefly.
- The illumination for the instrument cluster lights up whenever you switch on the ignition with the **vehicle headlights off**. As the daylight fades, the instrument cluster illumination likewise dims automatically and will go out completely when the outside light is very low. This feature is meant to remind you to switch on the headlights when outside light conditions become poor.



#### Engine coolant temperature gauge

The engine coolant gauge ⇨ *page 10, fig. 3* ① only works when the ignition is on. To prevent damage to your engine, please note the following important points:

##### Engine cold

If the needle is at or close to the bottom of the gauge, the engine has not yet reached its operating temperature. Avoid high engine speeds, heavy engine loads, and heavy throttle applications.

##### Normal temperature

When the engine has reached its operating temperature, the needle will move to the middle of the gauge and remain there. If the engine is working hard at high outside temperatures, the needle may move higher on the gauge. This is not a cause for concern as long as the  warning light in the instrument cluster display does not illuminate. If the  warning light in the instrument cluster display flashes, this can mean one of two things: either the coolant *temperature* is too high, or the coolant *level* is too low ⇨ *page 17*

**! WARNING**

- Always observe the warning in ⇒ *page 212*, before opening the hood and checking the engine coolant level.
- Never open the engine hood if you see or hear steam, or if you see engine coolant dripping from the engine compartment. You could burn yourself. Let the engine cool off first so that you cannot hear or see any steam or engine coolant.

**! Note**

- Mounting additional lights or accessories in front of the air inlets reduces the cooling effect of the radiator. At high outside temperatures or high engine load, the engine could overheat.
- The front spoiler has been designed to properly distribute the cooling air when the vehicle is moving. If the spoiler is damaged, this could reduce the cooling effect and the engine could then overheat. Ask your authorized Audi dealer for assistance.

**Tachometer (engine rev counter)**

The tachometer indicates the engine RPM (revolutions per minutes).

If engine RPM drops below 1,500, you should downshift to the next lower gear. The red area at the end of the scale indicates maximum permissible engine RPM after the break-in period. Before reaching this area, move the selector lever to position D/S or ease your foot off the accelerator pedal.

**! Note**

The tachometer needle ② ⇒ *page 10, fig. 3* should only briefly be in the red zone: you could damage your engine! The beginning of the red zone varies depending on the engine.

**🌱 For the sake of the environment**

Upshifting early saves fuel and reduces engine noise.

**SET button**

Fig. 4 SET button in the instrument cluster

The **SET** button performs the following functions:

**Switching on time, date, temperature display and odometer**

The display appears for approximately 30 seconds when you press the **SET** button ⇒ *fig. 4* with the ignition off.

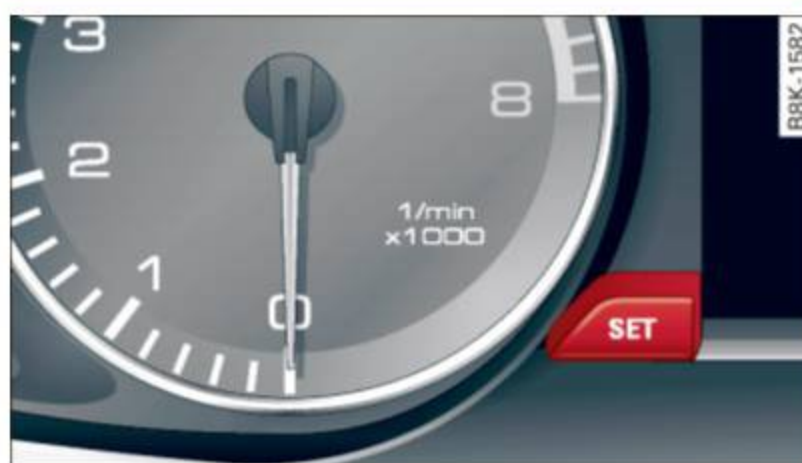
**Starting the Auto-Check sequence**

The Auto-Check system constantly monitors certain individual functions and components of the vehicle when the ignition is turned on and when the vehicle is moving.

With the ignition turned on, you can start the “Auto-Check sequence” by pressing the **SET** button. You can perform an Auto-Check sequence when the vehicle is stationary and the ignition is turned on or when the vehicle is moving slower than 3 mph (5 km/h).

In addition, the number of keys initialised for your vehicle is displayed. **L2 3/3** means that three keys have been initialised. This feature enables used car buyers to make sure they have received all of the keys.

If you are given only two keys, for instance, you should take the vehicle and the existing keys to an authorized Audi dealer to have the missing key disabled. It is also important to notify your insurance company about the loss.

**Setting the speed warning**

By pressing the **SET** button briefly, you can set threshold 1 of the speed warning while you are driving ⇒ *page 90*. By maintaining

pressure on the **SET** button, you delete the warning threshold.

### Digital clock with date display and Odometer

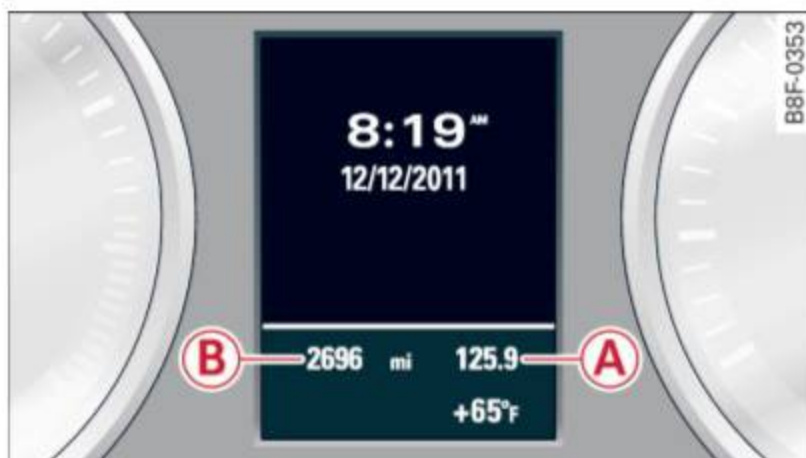

Fig. 5 Instrument cluster: odometer

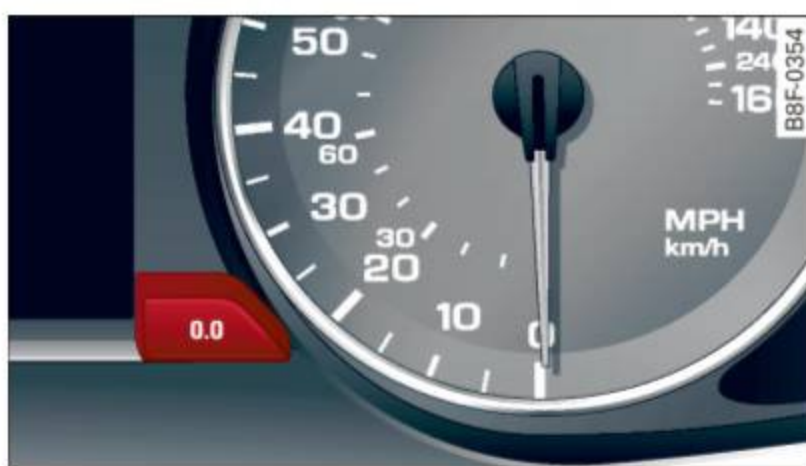



Fig. 6 Instrument cluster: reset button

### Digital clock/GPS controlled clock\*

Depending on the vehicle equipment level, you may choose between the quartz clock or the GPS controlled clock\*  in the radio or in the MMI\*. You can learn more about this in the MMI manual or in the radio user's manual.

### Odometer/trip odometer

The display of distance driven is shown in kilometers "km" or in miles "mi".

- USA models – Miles
- Canada models – Kilometers

The units of measure (kilometers/miles) can be changed in the radio or MMI\*. You can learn more about this in the MMI manual or in the radio user's manual.

The odometer **B** shows the total number of kilometers or miles that have been driven on the vehicle.

The trip odometer **A** shows the distance driven since it was last reset. It can be used to measure short distances. The last digit shows distances of 100 meters or 1/10 of a mile.

The trip odometer can be reset to zero by pressing the reset button **0.0** ⇒ *fig. 6*.

### Malfunction message

If there is a malfunction somewhere in the instrument cluster, **DEF** will appear in the trip odometer and will stay on. Contact your authorized Audi dealer to have the problem corrected.

### Immobilizer

When the ignition is switched on, the data on the ignition key are scanned automatically.

If an unauthorized key was used, **SAFE** is displayed permanently in the odometer display field. The vehicle cannot be operated ⇒ *page 32*.

### Tips

- When you switch off the ignition or open the driver door, the time, date, odometer and temperature are displayed for an additional 30 seconds.
- You can also call up the display with the **SET** button ⇒ *page 11* while the ignition is switched off.

### Fuel gauge

The fuel gauge works only when the ignition is on.

When the needle reaches the red area, the warning light  in the instrument cluster will illuminate ⇒ *page 21*. **Time to refuel!**

The total tank capacity of your vehicle is listed in ⇒ *page 281*.

### Note

Never run the tank completely dry! An irregular supply of fuel can cause engine

misfiring and fuel could enter into the exhaust system. The catalytic converter could then overheat and be damaged.

## Warning/indicator lights

### Description

The indicator lights in the instrument cluster blink or turn on. They indicate functions or malfunctions ⇒ .

Messages may appear with some indicator lights. A warning signal will sound at the same time. The messages disappear again after a short time. To display a message again, press the **SET** button ⇒ *page 11*. If several malfunctions occur, each of the indicator/warning lamps will be displayed in succession for about two seconds at a time.

Some indicators lights in the display can turn on in several colors.













### WARNING

- Failure to heed warning lights and other important vehicle information may result in serious personal injury or vehicle damage.
- Whenever stalled or stopped for repair, move the vehicle a safe distance off the road, stop the engine, and turn on the emergency flasher ⇒ *page 51*.
- The engine compartment of any motor vehicle is a potentially hazardous area. Before you check anything in the engine compartment, stop the engine and let it cool down. Always exercise extreme caution when working under the hood ⇒ *page 212*.

### Overview













Some indicator lights turn on briefly to check the function of that system when you switch the ignition on. These systems are marked with a ✓ in the following tables. If one of these indicator lights does not turn on, there is a malfunction in that system.



















### Red indicator lights

<b>BRAKE</b>	<b>USA models:</b> Brake system ✓ ⇒ <i>page 15</i>
	<b>Canada models:</b> Brake system ✓ ⇒ <i>page 15</i>
<b>PARK BRAKE</b>	<b>USA models:</b> Electromechanical parking brake ⇒ <i>page 16</i>
	<b>Canada models:</b> Electromechanical parking brake ⇒ <i>page 16</i>
	Safety belts ⇒ <i>page 16</i>
	Electromechanical steering ✓ ⇒ <i>page 190</i>
	Battery ⇒ <i>page 16</i>
	Engine oil pressure ⇒ <i>page 17</i>
	Engine oil level ⇒ <i>page 17</i>
	Engine cooling system ⇒ <i>page 17</i>
	Steering column lock ⇒ <i>page 18</i>
	Ignition lock ⇒ <i>page 18</i>
	<b>USA models:</b> Speed warning system ⇒ <i>page 89</i>
	<b>Canada models:</b> Speed warning system ⇒ <i>page 89</i>
	Adaptive cruise control ✓ ⇒ <i>page 104</i>





### Yellow indicator lights

	Electronic Stabilization Control (ESC) ✓ ⇒ <i>page 18</i>
---	--

	Electronic Stabilization Control (ESC) ✓ ⇒ page 18
<b>ESC OFF</b>	Electronic Stabilization Control (ESC) ⇒ page 185
<b>ABS</b>	<b>USA models:</b> Anti-lock braking system (ABS) defective ✓ ⇒ page 19
	<b>Canada models:</b> Anti-lock braking system (ABS) defective ✓ ⇒ page 19
<b>AIR BAG</b>	<b>USA models:</b> Safety systems ✓ ⇒ page 20
	<b>Canada models:</b> Safety systems ✓ ⇒ page 20
	Worn brake pads ⇒ page 20
	Electromechanical parking brake ⇒ page 16
	Tire pressure monitoring system ✓ ⇒ page 258
<b>TPMS</b>	Tire pressure monitoring system ⇒ page 258
<b>EPC</b>	Electronic power control ✓ ⇒ page 20
	Malfunction indicator Lamp (MIL) ✓ ⇒ page 20
	Engine speed limitation ⇒ page 20
	Engine oil level ⇒ page 17
	Engine oil sensor ⇒ page 21
	Battery ⇒ page 16
	Tank system ⇒ page 21

	Warm up engine* ⇒ page 208
	Windshield washer fluid level ⇒ page 21
	Windshield wipers ⇒ page 21
	Remote control key ⇒ page 85
	Battery in remote control key ⇒ page 33
	Defective light bulb warning ⇒ page 21
	Fog lights ⇒ page 21
	Rear fog light(s)* ⇒ page 21
	Headlight range control* ⇒ page 21
	Adaptive light* ⇒ page 22
	Light-/rain sensor* ⇒ page 22
	Adaptive dampers* ⇒ page 22
	Sport differential* ⇒ page 22
	Ignition lock ⇒ page 22
	Steering column lock ⇒ page 18
	Electromechanical steering, dynamic steering* ✓ ⇒ page 190
	Transmission - multitronic, tiptronic ⇒ page 99 - S tronic ⇒ page 99
	Transmission - S tronic ⇒ page 99

## Other indicator lights

	Turn signals ⇒ page 22
<b>CRUISE</b>	USA models: Cruise control ⇒ page 91
	Canada models: Cruise control ⇒ page 91
	Adaptive cruise control* ⇒ page 104
	Adaptive cruise control* ⇒ page 104
	High beam ⇒ page 50

**BRAKE** /  Brake system

The light illuminates when the ignition is switched on. It goes out after the engine has been started. This indicates that the brake warning light is functioning properly.

**If the brake warning light does not light up when the engine is cranking, there may be a malfunction in the electrical system. In this case, contact your authorized Audi dealer.**



If the brake system warning/indicator light turns on, there is a brake system malfunction.



**BRAKE** (USA models) /  (Canada models)  
**Stop vehicle and check brake fluid level**

If the indicator light turns on and the message appears, proceed as follows:

- ▶ Pull off the road.
- ▶ Stop the vehicle.
- ▶ Turn off the engine.
- ▶ Check the brake fluid level ⇒ page 221.
- ▶ Contact your nearest authorized repair facility if necessary.

**Warning! Fault in brake system. Contact dealer**

If the ABS indicator light **ABS** (USA models) /  (Canada models), the ESC indicator light  and the brake system indicator light

**BRAKE** (USA models) /  (Canada models) turn on and the message appears, the ABS, ESC and braking distribution are not working ⇒ .

Carefully drive to your authorized Audi dealer immediately to have the malfunction corrected ⇒ .

**BRAKE** (USA models) /  (Canada models)  
**Parking brake system fault! See owner's manual**

- If the indicator light and the message appear **when stationary or after switching the ignition on**, check if you can release the parking brake. After releasing the parking brake, carefully drive to your authorized Audi dealer immediately to have the malfunction corrected. If you cannot release the parking brake, seek professional assistance.
- If the indicator light and the message appear **while driving**, the emergency braking function may not be available. It may not be possible to set the parking brake or release it once it has been set. Seek professional assistance.

(USA models): If the warning light **BRAKE** and the warning light  appear together, immediately contact your authorized Audi dealer or qualified workshop to have all brake pads inspected ⇒ page 20.

When the light comes on, an audible warning signal is also given.

 **WARNING**

- Always observe the warnings in ⇒ page 212, before opening the hood and checking the brake fluid.
- Driving with low brake fluid is a safety hazard. Stop the car and get professional assistance.
- If the **BRAKE** (USA models) /  (Canada models) brake system indicator light turns on together with the ABS and ESC indicator lights, the ABS/ESC regulating function may have failed. Functions that stabilize the vehicle are no longer available. This could cause the vehicle to

swerve and increase the risk of sliding. Drive carefully to the nearest authorized Audi dealer or other qualified workshop and have the malfunction corrected.

- If the brake warning/indicator light does not go out after a few seconds and the parking brake is released, or lights up while you are driving, the fluid level in the brake fluid reservoir is too low. If you believe that it is safe to do so, proceed immediately at low speed to the nearest authorized Audi dealer or qualified workshop and have the brake system inspected.
- Always keep in mind that after several brake applications, you will need greater pressure on the brake pedal to stop your vehicle. Do not rely on strained brakes to respond with maximum stopping power in critical situations. You must allow for increased braking distances. The extra distance used up by fading brakes could lead to an accident.

### **Electromechanical parking brake**

The warning/indicator light monitors the electromechanical parking brake.

If the indicator light  (USA models) /  (Canada models) turns on, the parking brake was set.

The warning/indicator light will go out when the parking brake is released.

 (USA models) /  (Canada models) **Caution: Vehicle parked too steep**

If the indicator light blinks and the message appears, there is not enough braking power to keep the vehicle from rolling. The brakes have overheated. The vehicle could roll away even on a small incline.

### **Press brake pedal to release parking brake**

To release the parking brake, press the brake pedal and press the button  or start driving with starting assist at the same time

⇒ page 88.

### **Please release parking brake**

To release the parking brake manually, press the brake pedal and press the button  at the same time. The parking brake only releases automatically if the driver's safety belt is fastened.

### **Parking brake!**

If the  indicator light turns on and this message appears, there is a parking brake malfunction. Drive to your authorized Audi dealer or qualified workshop immediately to have the malfunction corrected.

### **Safety belts**

*This warning/indicator light reminds you to put on your safety belt.*

The  warning/indicator light illuminates when the ignition is switched on to remind the driver and (on USA models only) any front passenger to put on the safety belt. Additionally, an acoustic warning (gong) will also sound.

For more Information ⇒ page 136, *Safety belt warning light.*

### **Battery**

The  warning/indicator light illuminates when you switch on the ignition and must go out after the engine has started.

### **Alternator fault: Battery is not being charged**

If the indicator light turns on and the message appears, there is a malfunction in the generator or vehicle electrical system.

Drive to your authorized Audi dealer or qualified workshop immediately. Because the vehicle battery is discharging, turn off all unnecessary electrical equipment such as the radio. Seek professional assistance if the battery charge level is too low.

### **Low battery: Battery will be charged while driving**

If the indicator light turns on and the message appears, there may be limited starting ability.

If this message turns off after a little while, the battery charged enough while driving.

If the message does not turn off, have your authorized Audi dealer or qualified workshop correct the malfunction.

### Engine oil pressure





The red engine oil pressure warning symbol requires immediate service or repair. Driving with a low-oil-pressure indication is likely to inflict severe damage to the engine.

#### Turn off engine! Oil pressure too low

If the indicator light turns on and the message appears, the oil pressure is too low.

- ▶ Pull off the road.
- ▶ Stop the vehicle.
- ▶ Turn off the engine.
- ▶ **Check the engine oil level** ⇒ page 216.
- ▶ If the engine oil level is too low, add engine oil ⇒ page 216. Make sure that the oil pressure warning symbol  appears no longer in the display before you start driving again.
- ▶ If the engine oil level is correct and the indicator light still turns on, turn the engine off and do not continue driving. Seek professional assistance.

#### Tips

- The engine oil pressure symbol  is not an indicator for a low engine oil level. Do not rely on it. Instead, check the oil level in your engine at regular intervals, preferably each time you refuel, and always before going on a long trip.
- The yellow oil level warning indication  requires oil refill or workshop service without delay. Do not wait until the red oil pressure warning  starts to flash before you respond to the low oil level warning . By then, your engine may already have suffered serious damage.

### Engine oil level

#### WARNING: Please add oil immediately

If the indicator light and the message appear, add engine oil immediately ⇒ page 214.

#### Add oil, max XXXX l. You may cont. driv.

When the symbol  and driver message appear, add the amount of oil appearing in the display at the next opportunity ⇒ page 214.

### Engine cooling system

A malfunction in the engine cooling system must be repaired as soon as possible.

#### Turn off engine and check coolant level

If the indicator light turns on and the message appears, the coolant temperature is too high or the coolant level is too low.

- ▶ Pull off the road.
- ▶ Stop the vehicle.
- ▶ Turn off the engine.
- ▶ Check coolant level ⇒ page 218.
- ▶ Add coolant if necessary ⇒ page 219.
- ▶ Continue driving only after the engine coolant warning/indicator light goes out.
- ▶ Contact your authorized Audi dealer for assistance if necessary.

If the engine coolant level is correct, then the radiator fan may be the cause of the malfunction.

#### Coolant temperature! Let engine run with vehicle stationary

If the indicator light turns on and the message appears, let the engine run at idle for a few minutes to cool down.

#### WARNING

- If your vehicle should break down for mechanical or other reasons, park at a safe distance from moving traffic, turn off the engine and turn on the hazard warning lights ⇒ page 51, *Emergency flashers*.

- Never open the hood if you see or hear steam or coolant escaping from the engine compartment - you risk being scalded. Wait until you can no longer see or hear steam or coolant escaping.
- The engine compartment of any vehicle is a dangerous area. Before you perform any work in the engine compartment, turn off the engine and allow it to cool. Follow the warning stickers ⇒ *page 212*.

### Note

Do not continue driving if the  symbol illuminates. There is a malfunction in the engine cooling system – you could damage your engine.

### Steering column lock

#### Steering defective! Do not drive vehicle!

If the indicator light turns on and the message appears, there is an electronic steering column lock malfunction. You cannot switch the ignition on.

Do **not** tow your vehicle because it cannot be steered. Seek professional assistance.

#### Steering lock: Contact dealer!

If the indicator light turns on and the message appears, there is an electronic steering column lock malfunction.

Drive to your authorized Audi dealer immediately to have the malfunction corrected.

### WARNING

Your vehicle must not be towed in the event of a malfunction in the electronic steering column lock because it cannot be steered due to the locked steering. If it is towed with the steering locked, there is the risk of an accident.

### Ignition lock

#### Ignition lock defective. Contact dealer!

If the indicator light turns on and the message appears, do **not** switch the ignition off because you may not be able to switch it on again.

Drive to your authorized Audi dealer immediately to have the malfunction corrected.

On vehicles with convenience key\*, the engine should not be switched off using the **START ENGINE STOP** button because the engine cannot be started again after the ignition has been switched off.

### Tips

The symbol's appearance might be different in some models.



### Electronic Stabilization Control (ESC)

If the  indicator light blinks while driving, the ESC or ASR (Anti-Slip Regulation) is actively regulating.

If the  indicator light turns on, the system has switched the ESC off. In this case, you can switch the ignition off and then on to switch the ESC on again. The indicator light turns off when the system is functioning fully.

If the  indicator light turns on, ESC was restricted or switched off using the **ESC OFF** button ⇒ *page 185*.

#### **Stabilization control (ESC/ABS): Fault! See owner's manual**

If the indicator light  and the ABS indicator light  (USA models) /  (Canada models) turn on and the message appears, the ABS or electronic differential lock is malfunctioning. This also causes the ESC to malfunction. The brakes still function with their normal power, but ABS is not active.

Drive to your authorized Audi dealer immediately to have the malfunction corrected.

For more information about the ESC ⇒ *page 185*.

**! WARNING**

If the **BRAKE** (USA models)/ (Canada models) brake system indicator light turns on together with the ABS and ESC indicator lights, the ABS/ESC regulating function may have failed. Functions that stabilize the vehicle are no longer available. This could cause the vehicle to swerve and increase the risk of sliding. Drive carefully to the nearest authorized Audi dealer and have the malfunction corrected.

**i Tips**

For additional information on ESC and ABS, refer to  $\Rightarrow$  page 185.

**ABS /  Anti-lock braking system (ABS)**

*This warning/indicator light monitors the ABS and the electronic differential lock (EDL).*

The warning/indicator light **ABS** (USA models)/ (Canada models) will come on for a few seconds when the ignition is switched on. The light will go out after an automatic check sequence is completed.

**There is a malfunction in the ABS when:**

- The warning/indicator light does not illuminate when you switch the ignition on.
- The warning/indicator light does not go out after a few seconds.
- The warning/indicator light illuminates while driving.

The ESC indicator light also illuminates if there is a malfunction in the ABS. The message **Stabilization control (ESC): Fault! See owner's manual** also appears in the instrument cluster display and a warning tone sounds.

**The brake system will still respond even without the assistance of the ABS system. See your authorized Audi dealer as soon as possible to restore full braking performance.** For more information regarding the ABS  $\Rightarrow$  page 185.

**Malfunction in the brake system**



If the brake warning light  $\Rightarrow$  page 15 and the ABS warning illuminate *together* there may be a malfunction in the ABS, and there may also be a malfunction in the brake system itself  $\Rightarrow$  **! The ABS will not work and you will notice a change in braking response and performance.**

In the event of a **malfunction in the brake system** the warning/indicator light **BRAKE** (USA models)/ (Canada models) in the instrument cluster flashes  $\Rightarrow$  page 15.

**Malfunction in the electronic differential lock (EDL)**



The EDL works together with the ABS. The ABS warning light will come on if there is a malfunction in the EDL system  $\Rightarrow$  page 185. See your authorized Audi dealer as soon as possible.



**! WARNING**

- If the **ABS** (USA models)/ (Canada models) warning light does not go out, or if it comes on while driving, the ABS system is not working properly. The vehicle can then be stopped only with the standard brakes (without ABS). You will not have the protection ABS provides. Contact your authorized Audi dealer as soon as possible.
- *USA models:* If the **BRAKE** warning light and the **ABS** warning light come on together, the rear wheels could lock up first under hard braking. Rear wheel lock-up can cause loss of vehicle control and an accident. Have your vehicle repaired immediately by your authorized Audi dealer or qualified workshop. Drive slowly and avoid sudden, hard brake applications.
- *Canada models:* If the brake warning light  and the ABS warning light  come on together, the rear wheels could lock up first under hard braking. Rear wheel lock-up can cause loss of vehicle control and an accident. Have your

vehicle repaired immediately by your authorized Audi dealer or qualified workshop. Drive slowly and avoid sudden, hard brake applications.

### **Safety systems**

The  (USA models)/ (Canada models) indicator light monitors the safety systems (e.g. airbags, pretensioners) and illuminates for a few seconds each time you switch the ignition on.

If the  (USA models)/ (Canada models) indicator light does not go out, or if it illuminates while you are driving, or if it starts to blink, then there is a malfunction somewhere in the system. If the light does not illuminate when you switch the ignition on, this also means there is a malfunction.

### **WARNING**

If you have a malfunction in the safety systems, contact your authorized Audi dealer immediately. Otherwise the safety systems may not work properly in an accident.

### **Worn brake pads**

#### **Brake pads!**

If the warning light illuminates, immediately contact your authorized Audi dealer or qualified workshop to have all brake pads inspected. On USA models the warning light  comes on together with the warning light **BRAKE**. Both sets of brake pads on an axle must always be replaced at the same time.

### **WARNING**

Driving with bad brakes can cause a collision and serious personal injury.

- If the warning light  and the warning light **BRAKE**<sup>1)</sup> with the message **Brake pads!** comes on in the instrument cluster

display, immediately contact your authorized Audi dealer or qualified workshop to have all brake pads checked or replaced if necessary.

### **EPC Electronic power control**

*This warning/indicator light monitors the electronic power control.*

The  warning/indicator light (Electronic Power Control) illuminates when you switch the ignition on as a function check.

### **Tips**

If this warning/indicator light illuminates while you are driving, then there is a malfunction in the engine electronics. Have the malfunction corrected as soon as possible by your authorized Audi dealer or a qualified repair facility.

### **Malfunction Indicator Lamp (MIL)**

The Malfunction Indicator Lamp (MIL) is part of the On-Board Diagnostic (OBD II) system. The symbol  lights up when the ignition is switched on and will turn off after the engine has started and has settled at a constant idle speed. This indicates that the MIL is working properly.

The warning light illuminates when there is a malfunction in the engine electronic system. Contact your authorized Audi dealer and have the malfunction corrected.

An improperly closed fuel filler cap may also cause the MIL light to illuminate ⇒ *page 210*.

For more information ⇒ *page 29*.

### **Engine speed limitation**

Applies to vehicles: with engine speed limitation

 **Do not exceed max. engine speed of XXXX rpm**

1) **BRAKE**: USA models only

The  symbol illuminates when there is an engine control malfunction. The **EPC** indicator light in the instrument cluster also illuminates. The engine speed is limited to the speed displayed in the driver information system. Keep in mind that the engine speed will not exceed the value displayed in the driver information system, for example when downshifting.

Drive to your authorized Audi dealer immediately to have the malfunction corrected.

### Engine oil sensor

#### Oil level! Sensor defective

If the symbol illuminates, contact your authorized Audi dealer and have the oil sensor inspected. Until you have this done, check the oil level each time you refuel just to be on the safe side ⇒ *page 216*.

### Tank system

#### Please refuel

If the indicator light turns on for the first time and the message appears, there are about 2.1 - 2.4 gallons (7 - 9 liters) of fuel left in the tank. Time to refuel ⇒ *page 209*.

#### Fuel tank system malfunction! Contact dealer

If the indicator light turns on and this message appears, there is a malfunction in the tank system.

Drive to your authorized Audi dealer immediately to have the malfunction corrected.

### Windshield washer fluid level

#### Please refill washer fluid

If the symbol illuminates, add windshield washer fluid to the washer system and also to the headlight washer system\* ⇒ *page 225*.

### Windshield wipers



#### Windshield wiper defective

There is a malfunction with the windshield wipers.

Drive to your authorized Audi dealer immediately to have the malfunction corrected.

### Defective light bulb warning

If the  indicator light turns on, a bulb has failed. The message indicates the location of the bulb.

- If the  indicator light also turns on, then a fog light has failed. The position of the indicator light corresponds with the location on the vehicle.
- If the  indicator light also turns on, then a rear fog\* light has failed. The position of the indicator light corresponds with the location on the vehicle.

This warning can also occur if the light switch is in an unengaged position between two symbols.

#### Vehicle lights: System fault!

If the message appears, there is a malfunction in the headlights or light switch.

Drive to your authorized Audi dealer immediately to have the malfunction corrected.

#### WARNING

- Light bulbs are pressurized and could explode while they are being changed causing serious personal injury.
- Work with due care when handling the high-voltage section of gas discharge (xenon) lights\*. Failure to do so could result in death or serious injury.

#### Tips

Have the bulb replaced or the connection repaired by your authorized Audi Service department.

### Headlight range control

Applies to vehicles: with headlight range control

#### Headlight range control defective !

If the symbol  illuminates, the dynamic headlight range control is no longer working properly. Have the system checked and repaired at your authorized Audi dealer.

### Adaptive Light

Applies to vehicles: with adaptive light

#### Audi adaptive light: defective

If the indicator light turns on and this message appears, there is a malfunction in the adaptive light system. The headlights still function.

Go to an authorized dealership to have the headlights or the control unit for the adaptive light repaired.

### Light/rain sensor

Applies to vehicles: with light/rain sensor

#### Automatic headlights / automatic wipers defective

If the indicator light turns on and this message appears, the light/rain sensor is not functioning correctly.

For safety reasons the low beams are turned on permanently with the switch in **AUTO**. However, you can continue to turn the lights on and off using the light switch. You can still control all functions that are independent of the rain sensor through the windshield wiper lever.

Contact your authorized Audi dealer as soon as possible to have the problem corrected.

### Adaptive dampers

Applies to vehicles: with Audi drive select and adaptive dampers

#### Suspension: System fault!

If the  symbol in the display comes on, there is a malfunction in the adaptive dampers. Please go to an authorized Audi dealer or qualified workshop to have the malfunction repaired.

### Sport differential

Applies to vehicles: with Audi drive select and sport differential

#### **Sport differential: System fault!**

There is a malfunction with the sport differential.

Drive to your authorized Audi dealer immediately to have the malfunction corrected.

#### **Sport differential: Overheating**

The transmission temperature has increased significantly due to the sporty driving manner. Drive in a less sporty manner until the temperature returns to the normal range and the indicator light switches off.



### WARNING



Contact your authorized Audi dealer or qualified workshop if the sport differential is faulty or malfunctioning. The repair must be performed by trained personnel using the correct oil in order to ensure safety.

### Ignition lock

#### Ignition lock defective

There is a malfunction in the electronic ignition lock. Please go to an authorized Audi dealer or other qualified workshop to have the malfunction repaired.

### Turn signals

Whenever you use the left  or the right  turn signal, the indicator light blinks. When you use the emergency flashers, both indicator lights flash.

If one of the turn signal light bulbs burn out, the turn signal will blink twice as fast as normal. Carefully drive to your authorized Audi dealer immediately to have the malfunction corrected.

# Driver information display

## Introduction

The Driver information display inside the instrument cluster provides you, the driver, with important information.



Fig. 7 Instrument cluster: center display



Fig. 8 Wiper lever: controls for the menu display

### Center display

With the ignition on, the display in the Driver Information System shows the following information:

- CD\* inserted or Radio\* station set
- Outside temperature\*: At temperatures below 41 °F (+5 °C), a snowflake symbol appears in front of the temperature display ⇒ ⚠.
- Warning if one of the doors, front lid or engine compartment lid is not closed.

### Additional functions

You can open the following functions in the Driver Information System display by pressing the **RESET** button ⇒ fig. 8 one or more times:

Digital speedometer*	
Tire pressure monitoring*	⇒ page 257

Trip computer*	⇒ page 24
Efficiency program*	⇒ page 26
Service interval display	⇒ page 28
Speed warning	⇒ page 89
Gearshift selector positions Automatic transmission	⇒ page 94
Adaptive cruise control*	⇒ page 101

### Auto Check Control

Some functions and vehicle components are scanned for their operating status when you switch the ignition on and while you are driving. Malfunctions or required service procedures are signaled audibly and indicated by red and yellow illuminated symbols and reminders in the display.

**⚠ WARNING**

- Never rely exclusively on the outside temperature display to determine if a road surface is icy or not. Keep in mind that road surfaces, especially bridges and overpasses, could be ice covered and slippery even at an outside temperature above 41 °F (+5 °C).
- Always remember, even if the “snowflake” symbol (ice warning) does not appear in the display, black ice could be on the road.
- Always reduce your speed and drive with special care in cold weather conditions when the chance of encountering icy road surfaces increases.

**i Tips**

If the vehicle is stationary, or if you are driving at a very low speed, the temperature shown in the display might be slightly higher than the actual outside temperature. This is caused by the heat being radiated from the engine.

## Trip computer

### Introduction

Applies to vehicles: with trip computer

The trip computer gives you information on current and average fuel mileage, average speed, fuel range and driving time.



Fig. 9 Trip computer display: Average fuel mileage

The following information is continuously evaluated by the trip computer and can be displayed sequentially in the instrument cluster display:

### Fuel range

The estimated cruising range in miles (km) appears in the display. This tells you how far your vehicle will be able to travel on the current tank of fuel and with the same driving style. The display changes in increments of 5 miles (10 km).

The cruising range is calculated based on the fuel consumption for the last 18 miles (30 km). If you drive conservatively, the cruising range will increase.

### Average fuel mileage

The average fuel economy in MPG (l/100 km) since you last cleared the memory appears in this display. You can use this display to adjust your driving technique to achieve a desired mileage.

### Current fuel mileage

The instantaneous fuel consumption in miles per gallon (l/100 km) is shown in this display. You can use this display to adjust your driving technique to achieve a desired mileage.

Fuel consumption is recalculated at intervals of 33 yards (30 meters). This display switches to gallons/hour (liters/hour) when the vehicle is not moving.

### Average speed

The average speed in mph (km/h) since you last reset the memory appears in the display.

### Elapsed time

The length of time that you have been driving since you last reset the memory appears in this display.

### Distance

The distance that has been covered since the last time the memory was cleared appears in the display.

### Tips

- Fuel consumptions (average and current), range and speed are displayed in metric units on Canadian models.
- All stored values will be lost if the vehicle battery is disconnected.

### Memories

Applies to vehicles: with trip computer

The trip computer is equipped with two fully automatic memories as well as an efficiency program\*.

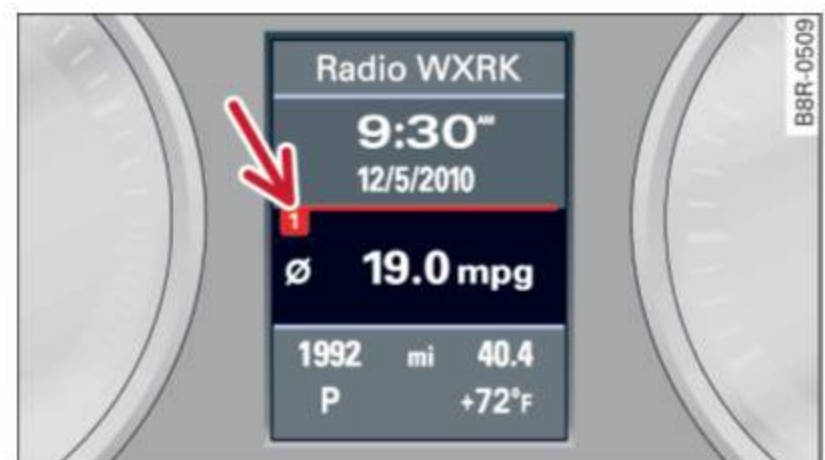



Fig. 10 Trip computer display: memory level 1

You can switch between the trip computer 1 and 2 and the efficiency program\* by pressing the **RESET** button  ⇒ page 25, fig. 11.

You can tell which memory level is currently active by the number or the sign in the display ►

⇒ *fig. 10*. The data from the single-trip memory (memory level 1) is being displayed if a **1** appears in the display. If a **2** is shown, then the data from the total-trip memory is being displayed (memory level 2). The fuel pump nozzle  indicates the efficiency program\* ⇒ *page 26*.

### Single-trip memory (Trip computer 1)

The single-trip memory stores the trip information from the time the ignition is turned on until it is turned off. If the trip is continued **within 2 hours** from the time the ignition was turned off, the new data will be included in the calculation of the current trip information. If the trip is interrupted for **more than 2 hours** the memory is reset automatically.

### Total-trip memory (Trip computer 2)

Unlike the single-trip memory, the total-trip memory is not reset automatically. This permits you to evaluate your driving data for the entire period between manual resets.

### Efficiency program\*

The efficiency program can help you to use less fuel ⇒ *page 26*.

## Operation

Applies to vehicles: with trip computer

*The trip computer is controlled by two switches on the windshield wiper lever.*

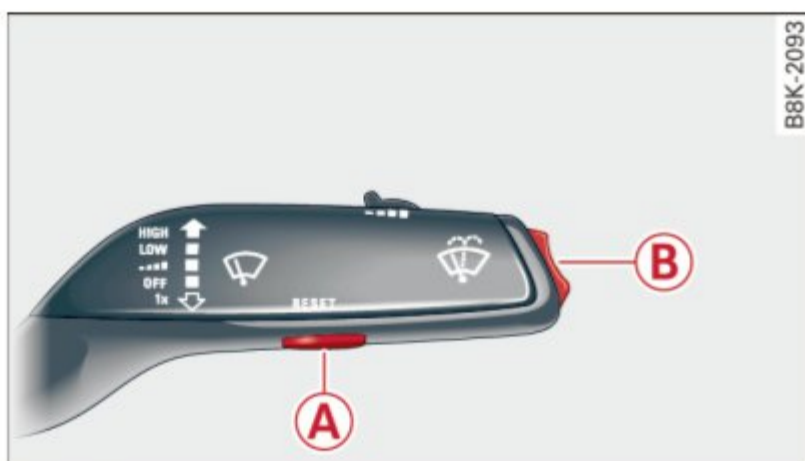

**Fig. 11** Windshield wiper lever: controls for the trip computer

### Operating

► To display the trip computer memory levels, press the **RESET** button **A** ⇒ *fig. 11* re-

peatedly until the desired memory level is shown in the display.

► To display trip information within a memory level, press the top or bottom part of the function selection switch **B**.

The trip computer will not operate unless the ignition is on. When you turn on the ignition, the function that was in use when you last turned the ignition off will be displayed.

In addition to information about the trip computer (trip computer 1, 2 and the efficiency program\*), information about other systems can also be shown in the display. To switch the display between the different information, tap the **RESET** button **A** briefly.

### Resetting values to zero

- Select a value in the desired trip computer or in the efficiency program\*.
- Press and hold the **RESET** button **A** for at least one second. All values in the selected trip computer or in the efficiency program\* are reset to zero.

If the data in trip computer 1 are deleted, then the values in the efficiency program\* will also be reset.

With some vehicle equipment levels, the values for the single trip or total trip memory can also be reset in the Infotainment system ⇒ *page 25*.

### Tips

All stored values will be lost if the vehicle battery is disconnected.

## Basic Settings for the trip computer

Applies to vehicles: with trip computer

*The radio or MMI\* operating unit is used for setting the trip computer's basic settings.*

► Select: Function button **CAR** > **Instrument cluster** > **On-board computer 1** or **On-board computer 2**.

The values in the single-trip or the total-trip memory can all be reset to zero at the same time under **Reset** in the menu.

In addition, you can determine what information from the trip computer should be shown in the instrument cluster display. If one of the pieces of driver information is turned **Off**, that driver information will not be shown in the display. The information will continue to be calculated by the trip computer and can be turned back **On** at any time.

**i Tips**

- This function is not available on all vehicles.
- The driving information in the efficiency program is also reset to zero with the single-trip memory.

## Gearshift Indicator

Applies to vehicles: with manual transmission and gearshift indicator

*This indicator can help conserve fuel.*



Fig. 12 Display: Gearshift indicator

In order to become familiar with the gearshift indicator, at first just drive the way you are used to. If the current gear - and the driving situation - is not the best one for conserving fuel, then the indicator will display the recommended gear. The display shows the current gear and the gear that is recommended ⇒ *fig. 12*.

- **Upshifting** The display will light up to the **right** of the gear currently selected if it is recommending a higher gear.

- **Downshifting:** The display will light up to the **left** of the gear currently selected if it is recommending a lower gear.

Sometimes the indicator will recommend skipping a gear (3 > 5).

If there is no gearshift recommendation, then just drive in the appropriate gear for conserving fuel.

**! Note**

This indicator can help you conserve fuel. This indicator is not meant to show you which gear you should always be in in all driving situations. Sometimes, in situations such as passing, driving through mountains or when towing a trailer, there won't be any gearshift recommendation.

**i Tips**

The display does not light up when the clutch pedal is being depressed.

## Efficiency program

### Description

Applies to vehicles: with trip computer with efficiency program

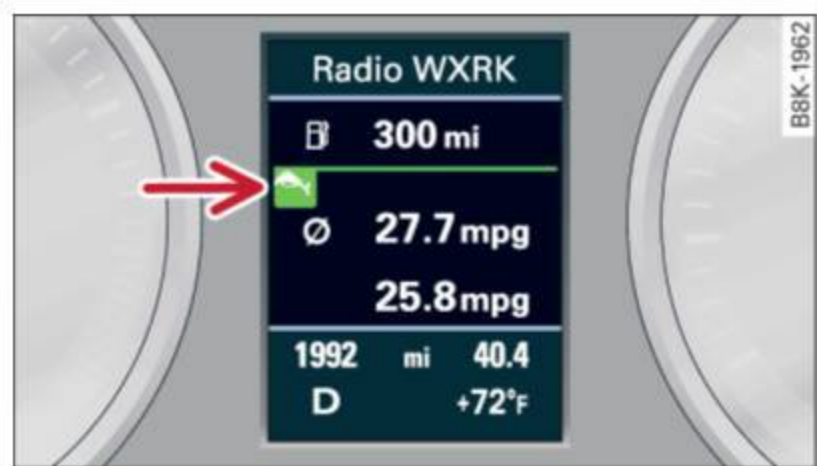

Fig. 13 Display: efficiency program

► Press the **RESET** button (A) ⇒ *page 25, fig. 11* repeatedly until the efficiency program appears in the display.

The efficiency program can help you to use less fuel. It evaluates driving information in reference to fuel consumption and shows other equipment influencing consumption as well as shift recommendations. Fuel economy ►

messages ⇒ *page 28* provide tips for efficient driving.

The efficiency program uses distance and consumption data from trip computer 1. If the data are deleted in the efficiency program, those values are also reset in trip computer 1.

**Enhanced shift indicator**

Applies to vehicles: with manual transmission and trip computer with efficiency program



Fig. 14 Display: enhanced shift indicator

- ▶ In the efficiency program, press the function selection switch ⇒ *page 25, fig. 11* (B) repeatedly until the enhanced shift indicator appears in the display.

The efficiency program also has an enhanced shift indicator. This enhanced shift indicator follows the same concept as the “standard” shift indicator ⇒ *page 26*. The selected and the recommended gears are highlighted in colors like a traffic light.

The color of the circle indicates if the most suitable gear is engaged or if you should shift up or down.

Green circle without or with a gear	No gear or the most suitable gear is engaged
Yellow circle ⇒ <i>fig. 14</i>	Shift up or down one gear
Red circle	Shift up two gears

**Note**

This enhanced shift indicator can help you conserve fuel. It is not designed to recommend the correct gear in all driving situations. Only the driver can decide which

gear is correct in certain driving situations such as when passing another vehicle, driving on hills or towing a trailer.

**Tips**

- The enhanced shift indicator display is different in vehicles with a monochrome display.
- The “standard” shift indicator\* disappears when the enhanced shift indicator is displayed.

**Other equipment**

Applies to vehicles: with trip computer with efficiency program

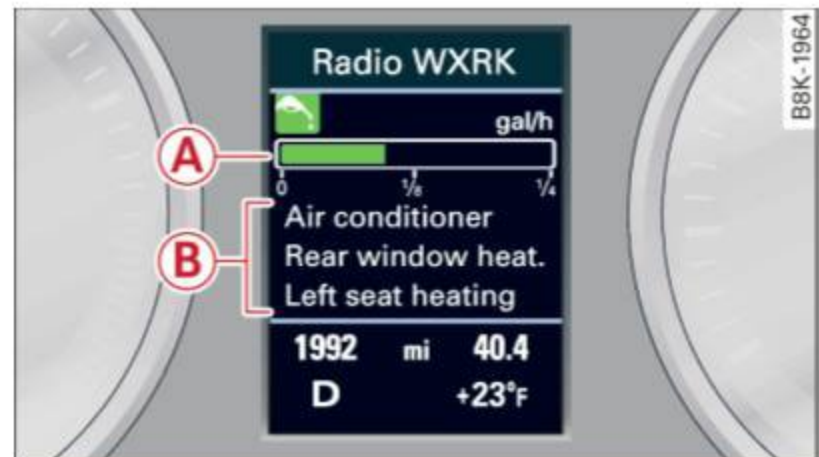

Fig. 15 Display: other equipment

- ▶ In the efficiency program, press the function selection switch ⇒ *page 25, fig. 11* (B) repeatedly until the other equipment appears in the display.

Other equipment that is currently affecting fuel consumption is listed in the efficiency program. The display shows up to three other items of equipment (B). The equipment using the most fuel is listed first. If more than three items using fuel are switched on, the equipment that is currently using the most fuel is displayed.

A scale (A) also shows the current total consumption of all other equipment.

## Fuel economy messages

Applies to vehicles: with trip computer with efficiency program

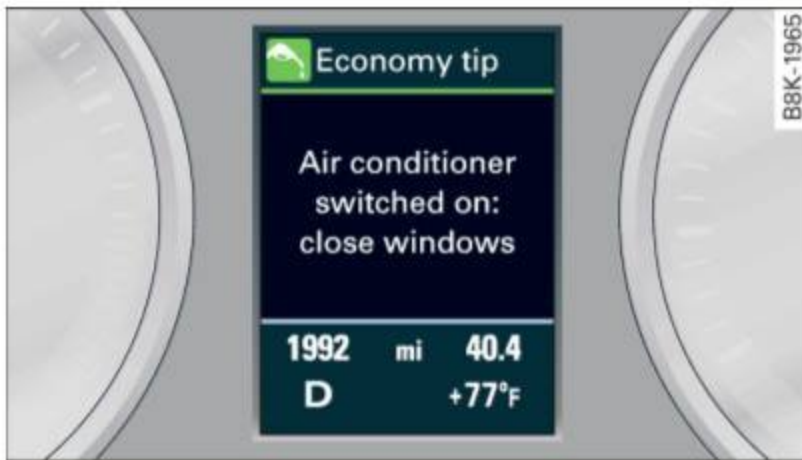

Fig. 16 Display: fuel economy message

Fuel economy messages are displayed when fuel consumption is increased by certain conditions. If you follow these fuel economy messages, you can reduce your vehicle's consumption of fuel. The messages appear automatically and are only displayed in the efficiency program. The fuel economy messages turn off automatically after a certain period of time.

- ▶ To turn a fuel economy message off immediately after it appears, press the **RESET** button ⇒ page 25, fig. 11 (A), or
- ▶ Press the function selection switch ⇒ page 25, fig. 11 (B).

### **i** Tips

- Once you have turned a fuel economy message off, it will only appear again after you turn the ignition on again.
- The fuel economy messages are not displayed in every instance, but rather in intervals over a period of time.

## Service interval display

The service interval display reminds you when your next service is due.



Fig. 17 Display: Service interval display

The schedule for the next oil change or inspection is calculated automatically and displayed accordingly. The display works in two stages:

### Service reminder

30 days before the next service is due, a service reminder appears in the display when you turn on the ignition ⇒ fig. 17.

After about 5 seconds the display switches back to normal. The distance and time remaining are updated each time the ignition is turned on until the date due for service is reached.

### Service due

When the due date for service is reached, the message **Service due!** appears in the instrument cluster immediately after you turn on the ignition. Additionally, a warning tone sounds. After about 5 seconds the display switches back to normal.

### Calling up the service schedules

If or when an oil change or inspection is due, can be shown in the radio or MMI\* display by selecting the service interval display in the car menu. Select **CAR** function button > **Service interval display** or **CAR** function button > **Car systems\*** control button > **Servicing & checks**.

## Resetting the service interval display

Your authorized Audi dealer will reset the corresponding service schedule after performing the appropriate service on your vehicle. You also have the possibility to reset the oil change schedule after having performed an oil change according to Audi specifications. Select **CAR** function button > **Service interval display** > **Reset oil change interval** or **CAR** function button > **Car systems\*** control button > **Servicing & checks** > **Reset oil change interval**.

### ! Note

- Only reset the oil change display when you have completed an oil change.
- If you disconnect the battery terminals, no calculations can be made for the service interval display during this time and no service reminder will appear. Remember that observing the proper service intervals is vitally important to extending the life of your vehicle, particularly the engine, and maintaining its value. Even if the mileage driven is low, the maximum period of one year from one service to the next must not be exceeded.

### i Tips

The information in the Service Reminder remains stored even when the vehicle battery is disconnected.

## On-Board Diagnostic system (OBD)

### Malfunction Indicator Lamp (MIL)

The Malfunction Indicator Lamp (MIL)  in the instrument cluster is part of the On-Board Diagnostic (OBD II) system.

The warning/indicator light illuminates when the ignition is switched on and goes out after the engine starts and the idle has stabilized. This indicates that the MIL is working properly.

If the light does not go out after the engine is started, or illuminates while you are driving, a malfunction may exist in the engine system. If the light illuminates, the catalytic converter could be damaged.

Continue driving **with reduced power** (avoiding sustained high speeds and/or rapid accelerations) and have the condition corrected. Contact your authorized Audi dealer.

If the light illuminates, the electronic speed limiter may also be malfunctioning. For more information ⇒ *page 30, Electronic speed limiter*.

**An improperly closed fuel filler cap may also cause the MIL light to illuminate** ⇒ *page 210*.

### On-Board Diagnostics

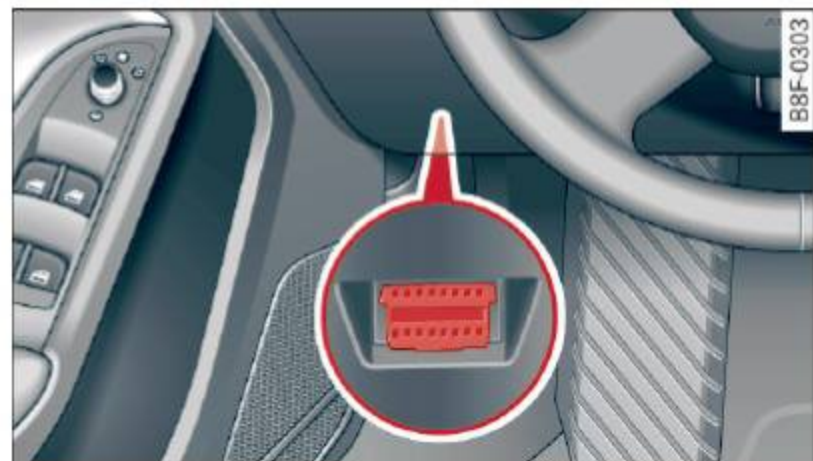

Fig. 18 Location of Data Link Connector (DLC)

On-Board Diagnostics monitors the components of your emission control system. Each monitored component in your engine system has been assigned a code. In case of a malfunction, the component will be identified and the fault stored as a code in the control module memory.

The MIL light may also illuminate if there is a leak in the on-board fuel vapor recovery system. If the light illuminates after a refueling, stop the vehicle and make sure the fuel filler cap is properly closed ⇒ *page 210*.

In order to make an accurate diagnosis, the stored data can only be displayed using special diagnostic equipment (generic scan tool for OBD).

In order to connect the special diagnostic equipment, push the plug into the Data Link Connector (DLC). The DLC is located to the right of the hood release ⇒ *fig. 18*.

Your authorized Audi dealer or qualified workshop can interpret the code and perform the necessary repair.

** WARNING**

Do not use the diagnostic connector for personal use. Incorrect usage can cause malfunctions, which can increase the risk of a collision!

**Electronic speed limiter**

Your vehicle may be factory equipped with tires that are rated for a maximum speed of 130 mph (210 km/h). This may be less than the maximum speed of your vehicle. To reduce the risk of sudden tire failure and loss of control if the vehicle is operated at excessive speeds, your vehicle has an electronic speed limiter. The electronic speed limiter prevents your vehicle from going faster than the tire speed rating. For more information ⇒ *page 248*.

If the engine control unit receives faulty vehicle roadspeed signals, the Malfunction Indicator Light (MIL)  will illuminate. If this occurs, contact the nearest authorized Audi dealer for assistance.

** WARNING**

Always observe the posted speed limits and adjust your speed to suit prevailing road, traffic and weather conditions. Never drive your vehicle faster than the maximum speed rating of the tires installed.

## Opening and closing

### Power locking system

#### General description

The power locking system locks or unlocks all doors and the rear lid simultaneously.

You can lock and unlock the vehicle centrally. You have the following choices:

- Remote master key ⇒ page 34,
- Door handles with convenience key\* ⇒ page 35,
- Lock cylinder at the driver's door ⇒ page 37, or
- Power locking switch inside ⇒ page 35.

#### Automatic locking

The automatic locking feature locks all the vehicle doors and the rear lid when you drive faster than 9 mph (15 km/h).

The car is unlocked again once the ignition key is removed. In addition, the vehicle can be unlocked if the opening function in the power locking system switch or at one of the door levers is actuated. The Auto Lock function can be turned on and off in the radio or MMI\* ⇒ page 36.

Additionally, in the event of a crash with airbag deployment the doors are automatically unlocked to allow access to the vehicle.

#### Selective unlocking

When you lock the vehicle, the power locking system will lock the doors and the rear lid. When unlocking, you can set in the radio or MMI\* whether *only* the driver's door or the entire vehicle should be unlocked ⇒ page 36.

#### Anti-theft alarm warning system

If the anti-theft alarm warning system detects a break-in into the vehicle, acoustic and visual warning signals are triggered.

The anti-theft warning system is activated automatically when you lock the vehicle. It is deactivated when unlocking using the remote

key, with the mechanical key, and when you switch on the ignition.

The alarm also turns off when the alarm cycle has expired.

#### Turn signals

When you unlock the vehicle, the turn signals flash twice, when you lock it once. If they do not flash, one of the doors, the luggage compartment lid or the hood is not locked or the ignition is still switched on.

#### Unintentionally locking yourself out

In the following cases there are safeguards to prevent you locking your remote master key in the vehicle:

- The vehicle does not lock with the power locking switch ⇒ page 35 if the driver's door is open.
- On vehicles with convenience key\*, if the most recently used master key is in the luggage compartment, the rear lid is automatically unlocked again after it is closed.

Do not lock your vehicle with the remote master key or convenience key\* until all doors and the rear lid are closed. In this way you avoid locking yourself out accidentally.

#### WARNING

- When you leave the vehicle, always remove the ignition key and take it with you. This will prevent passengers (children, for example) from accidentally being locked in the vehicle should they accidentally press the power locking switch in the front doors.
- Do not leave children inside the vehicle unsupervised. In an emergency it would be impossible to open the doors from the outside without the key.

#### Tips

- In the event of a crash with airbag deployment all locked doors will be automatically unlocked to give access to the vehicle occupants from the outside.

- If the power locking system should malfunction, you can lock the driver's door using the mechanical key ⇒ *page 37*.
- If the power locking system should fail, you can still open the fuel tank flap in an emergency ⇒ *page 211*.
- You are well advised not to keep valuables inside an unattended vehicle, visible or not. Even a properly locked vehicle cannot provide the security of a safe.
- If the LED in the upper edge of the driver's door panel comes on for about 30 seconds after the vehicle is locked, there is a malfunction in the power locking or the anti-theft warning system. Have the malfunction corrected by an authorized Audi dealership or qualified repair facility.

### Key set



Fig. 19 Key set

#### **A** Remote control key with mechanical key

You can centrally lock and unlock your vehicle and start the engine with the master key with remote control. A mechanical key is integrated in the master key ⇒ *page 33*.

#### **B** Emergency key

The emergency key is not intended for constant use. It should only be used in an emergency, for example, in place of the ignition key ⇒ *page 84*. Keep it in a safe place and do not carry it on your key ring.

### Key replacement

If you lose a key, contact your authorized Audi dealer immediately to have the *lost* key disabled. Be sure to bring all your keys with you.

### Number of keys

You can check the number of assigned keys to your vehicle ⇒ *page 11*. This allows you to make sure you have received all of the keys when you purchase a used vehicle.

### Data in the master key

During driving, service and maintenance-relevant data is continuously stored on your master key. Your Audi service adviser can read out this data and tell you about the work your vehicle needs. This applies also to vehicles with convenience key\*.

### Personal comfort settings

If two people use one vehicle, it is recommended that each person always uses “their own” master key. When the ignition is turned off or when the vehicle is locked, personal convenience settings for the following systems are stored and assigned to the remote master key.

- Climate control
- Power locking system
- Seat memory\*
- Parking system\*
- Adaptive cruise control\*
- Side assist\*
- Drive select\*

The stored settings are automatically recalled when you unlock the vehicle, when you open the doors or when you turn on the ignition.

#### **!** WARNING

- Do not leave your vehicle unattended with the key in the ignition lock. Entry by unauthorized persons could endanger you or result in theft or damage the vehicle.
- Do not leave children unattended in the vehicle, especially with access to vehicle

keys. Unguarded access to the keys provides children the opportunity to start the engine and/or activate vehicle systems such as the power windows etc. Unsupervised operation of any vehicle system by children can result in serious injury.

- Do not remove the key from the ignition lock until the vehicle has come to a complete stop. Otherwise the steering column lock could suddenly engage - causing the risk of an accident.

### **i** Tips

- The operation of the remote control key can be temporarily disrupted by interference from transmitters in the vicinity of the vehicle working in the same frequency range (e.g. a cell phone, radio equipment).
- For security reasons, replacement keys are only available from authorized Audi dealer.
- For Declaration of Compliance to United States FCC and Industry Canada regulations ⇒ *page 286*.

### Removing the mechanical key

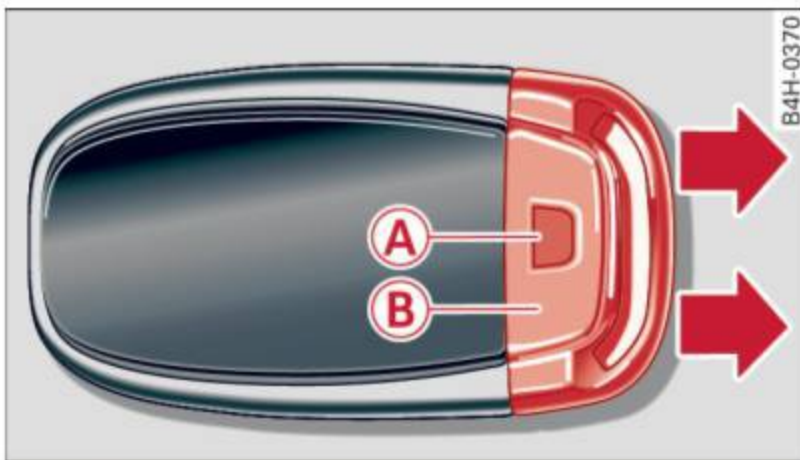

**Fig. 20** Remote master key: removing the mechanical key

- ▶ Press the release button **(A)** ⇒ *fig. 20*.
- ▶ Pull the mechanical key **(B)** out of the master key.

Using the mechanical key, you can:

- lock and unlock\* the glove compartment on the passenger's side ⇒ *page 67*.

- lock and unlock the lockable\* rear bench seat and pass-through\* ⇒ *page 71*.
- activate the child safety locks on the rear doors ⇒ *page 41*.
- lock and unlock the vehicle manually ⇒ *page 37* if this should not be possible with the master key.
- use the ignition key emergency release ⇒ *page 34*.

### Check light and battery in the master key

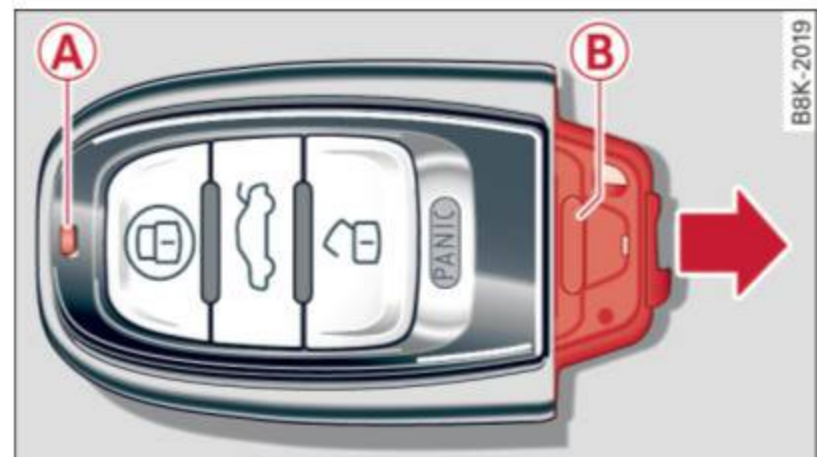

**Fig. 21** Remote master key: removing the battery holder

### Check light in the master key

The check light **(A)** ⇒ *fig. 21* in the master key provides information about different conditions.

- ▶ The check light turns on briefly once when a button is pressed, and during an “inquiry” by the convenience key system.
- ▶ If the check light does not come on, the battery is dead and has to be replaced. In addition, when the battery is dead the  indicator light appears in the instrument cluster display as well as the message **Please change key battery**.

### Master key battery replacement

- ▶ Remove the mechanical key ⇒ *page 33*.
- ▶ Press the release button **(B)** ⇒ *fig. 21* on the battery holder and at the same time pull the battery holder out of the master key in the direction of the arrow.
- ▶ Install the new battery CR 2032 with the “+” sign facing down.
- ▶ Push the battery holder carefully into the master key.

- ▶ Install the mechanical key.

### **For the sake of the environment**

Dispose of dead batteries properly so as not to pollute the environment.

### **Tips**

The replacement battery must be the same specification as the original.

### **Emergency unlocking of the ignition key**





*In the event of malfunctions in the electrical system, it may happen that you cannot remove the ignition key.*

- ▶ Remove the mechanical key ⇒ *page 33*.
- ▶ Lock the vehicle using the mechanical key ⇒ *page 37*.
- ▶ Have the electrical system inspected by an authorized Audi dealership.

### **Locking and unlocking the vehicle with the remote control**



**Fig. 22** Remote master key: function buttons

- ▶ Press button  to unlock the vehicle ⇒ *fig. 22*.
- ▶ Press button  to lock the vehicle ⇒  in *General description on page 31*.
- ▶ Press button  briefly to unlock the rear lid.
- ▶ Press the button  for at least one second to open the rear lid.
- ▶ Push the red **PANIC** button to activate the panic function. The horn sounds and the turn signals flash. Push the red **PANIC** button again to deactivate the panic function.

If the vehicle is unlocked and no door, the rear lid or the hood is opened within 60 seconds, the vehicle locks itself again automatically. This feature prevents the vehicle from being accidentally left unlocked over a long period of time.

It depends on the settings in the radio or MMI\* whether the entire vehicle is unlocked or only certain doors ⇒ *page 36*.

On vehicles with automatic transmission, the selector lever must be in the P position, otherwise the vehicle cannot be locked.

### **WARNING**

Read and follow all WARNINGS ⇒  in *General description on page 31*.

### **Tips**

- In order to make sure the locking function is working, you should always keep your eye on the vehicle to make sure it is properly locked.
- Do not use the remote control if you are inside the car, otherwise you may unintentionally lock the vehicle, and then you would set off the anti-theft alarm when you try to start the engine or open a door. In case this happens anyhow, push the unlock button .
- Use the panic function only if you are in an emergency situation.
- Additional remote control key functions ⇒ *page 42*.

## Locking and unlocking with convenience key

Applies to vehicles: with convenience key

The doors and the rear lid can be unlocked and locked without operating the master key.



Fig. 23 Door handle: locking the vehicle

### Unlocking vehicle

- ▶ Take hold of the door handle. The door is unlocked automatically.
- ▶ Pull the handle to open the door.

### Locking vehicle

- ▶ Move the selector lever to the P position (automatic transmission), otherwise the vehicle cannot be locked.
- ▶ To lock the vehicle, close the door and touch the sensor in the door handle **once** ⇒ *fig. 23* ⇒ ⚠ in *General description on page 31*. Do not reach inside the door handle.

The vehicle can be locked and unlocked at any door. The remote control key cannot be more than 1.5 m away from the door handle. It makes no difference whether the master key is in your jacket pocket or in your brief case.

If you grip the door handle while locking, this can adversely affect the locking function.

It is not possible to re-open the door for a brief period directly after closing it. This allows you to ensure that the doors are properly locked.

It depends on the settings in the radio or MMI\* whether the entire vehicle is unlocked or one of the doors ⇒ *page 36*.

## ⚠ WARNING

Read and follow all WARNINGS ⇒ ⚠ in *General description on page 31*.

## i Tips



If your vehicle has been standing for an extended period, please note the following:

- The proximity sensors are deactivated after a few days to save power. You then have to pull on the door handle once to unlock the vehicle and a second time to open the vehicle.
- To prevent the battery from being discharged and to preserve your vehicle's ability to start for as long as possible, the energy management system gradually switches off unnecessary convenience functions. It is possible that you will not be able to unlock your vehicle using these convenience functions.
- For Declaration of Compliance to United States FCC and Industry Canada regulations ⇒ *page 286*.

## Locking and unlocking the vehicle from inside



Fig. 24 Driver's door: power locking switch

- ▶ Press the button  to lock the vehicle ⇒ ⚠.
- ▶ Press the button  to unlock the vehicle ⇒ *fig. 24*.

If you lock the vehicle using the power locking switch, please note the following:

- If a door is open, the vehicle cannot be locked using the power locking system switch.

- You cannot open the doors or the rear lid from the *outside* (increased security, for example when you are stopped at a red light).
- The diodes in the power locking switch illuminate when all the doors are closed and locked.
- Front doors: you can unlock and open the doors from the inside by pulling on the door handle.
- Rear doors: pull the door handle *once* to release the lock. Pull the handle *again* to open the door.
- If you have a crash and the airbag is activated, the doors automatically unlock.

### **WARNING**



- The power locking switch works with the ignition off and automatically locks the entire vehicle when it is actuated.
- On a vehicle locked from the outside the power locking system switch is inoperative.
- Locked doors make it more difficult for emergency workers to get into the vehicle, which puts lives at risk. Do not leave anyone behind in the vehicle, especially children.

### **Tips**





Your vehicle is locked automatically at a speed of 9 mph (15 km/h) (Auto Lock) ⇒ *page 31*. You can unlock the vehicle again using the opening function in the power locking system switch .



## Setting power locking

*In the radio/MMI\*, you can set which doors the central locking system will unlock.*

- ▶ Select:  function button > **Central locking**. Or
- ▶ Select:  function button > **Car systems\*** control button > **Vehicle settings** > **(Central locking)\***.

**Single door unlocking/Unlock doors\*** - you can specify which doors unlock when you open the vehicle.

- Selecting **off/All** and pressing the  button on the remote control key unlocks the entire vehicle.
- Selecting **on/Driver** and pressing the  button on the remote control key once unlocks only the driver's door. In vehicles with a convenience key\*, only the door whose handle you pull will unlock. If you press the  button twice, the entire vehicle will unlock. If you press the  button, the entire vehicle will always lock.

**Luggage comp. lock/Lock exterior trunk handle** - If you select **On**, you can no longer open the luggage compartment using the rear lid handle ⇒ *page 38, fig. 27*. In this case, the rear lid can be opened with the  button on the master key ⇒ *page 34, fig. 22* or with the \* button in the driver's door ⇒ *page 39, fig. 29*.

**Fold mirrors\*** if you select **On**, the outside mirrors will fold in automatically when you press the  button on the remote control key ⇒ *page 52*.

**Tone when locking** - if you select **On**, a tone will sound when you lock the vehicle.

**Auto Lock/Lock when driving** - if you select **On**, the entire vehicle will lock automatically when the speed reaches 9 mph (15 km/h).

## Emergency locking

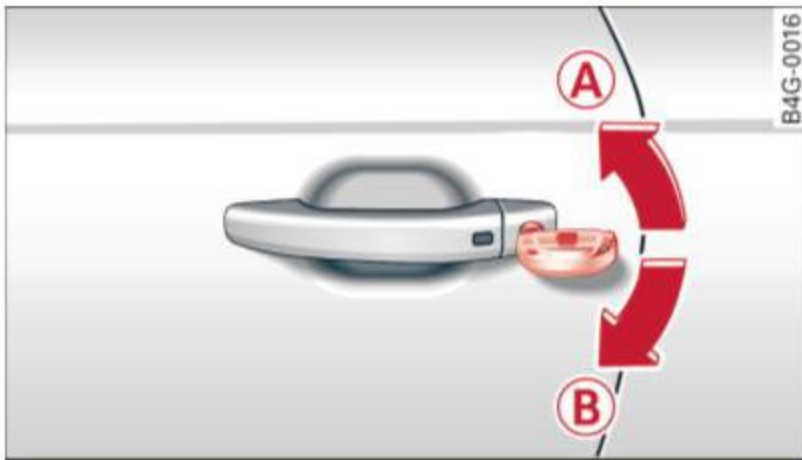

Fig. 25 Driver's door: lock cylinder



Fig. 26 Front passenger's door/rear doors\*: emergency lock

If the central locking system malfunctions, you must unlock/lock the doors separately using the emergency key or the mechanical key.

### Unlocking/locking the driver's door with the mechanical key

- ▶ Remove the mechanical key ⇒ page 33.
- ▶ To unlock the driver's door, turn the key to the open position **(A)** ⇒ fig. 25.
- ▶ To lock the driver's door, move the selector lever to the P position (automatic transmission) and turn the key **once** to the close position **(B)** ⇒ **!** in General description on page 31.

### Locking the front passenger's door/rear doors\* with the mechanical key

The emergency lock is located on the rear side of the front passenger's door and the rear doors. It is only visible when the door is open.

- ▶ Remove the mechanical key ⇒ page 33.
- ▶ Pull the cover cap out of the opening ⇒ fig. 26.

- ▶ Insert the key in the inside slot and turn it all the way to the right (right door) or left (left door).

Once the front passenger's door/rear doors\* have been closed, you cannot open them again from the outside. The door can be opened from the inside by pulling the door handle. If the child safety lock in a rear door\* is activated, you must first pull the door handle on the inside. Then you can open the door from the outside.

### **!** WARNING

Read and follow all WARNINGS ⇒ **!** in General description on page 31.

### **i** Tips

After the ignition is switched on, the power locking system switch and the unlocking button for the rear lid  in the door are enabled.

## Electronic immobilizer

*The immobilizer prevents your vehicle from being started by unauthorized persons.*

Inside the key there is a computer chip. This chip automatically activates/deactivates the electronic immobilizer.

### Applies to vehicles with ignition lock:

The electronic immobilizer deactivates automatically when you insert the remote control key into the ignition lock. It activates again automatically when you remove the remote control key from the ignition lock.

### Applies to vehicles with convenience key:

If the remote control key is located inside the vehicle and you press the **START ENGINE STOP** button, the electronic immobilizer deactivates automatically. If you switch the ignition off and remove the remote control key from the vehicle, the electronic immobilizer activates again automatically. ▶

**⚠ WARNING**

Always take the key with you when you leave the vehicle. The key can disarm the electronic engine immobilizer and permit an unauthorized person to start the engine and enable operation of the vehicle systems such as power window or power sunroof leading to serious personal injury.

**i Tips**

- The vehicle cannot be started if an unauthorized key is used. The vehicle may not start if another radio device such as a key for another vehicle or a transponder is located on the key ring.
- For Declaration of Compliance to United States FCC and Industry Canada regulations ⇒ *page 286*.

## Rear lid

### Opening/closing rear lid





Fig. 27 Rear lid: handle



Fig. 28 Sedan driver's door: remote rear lid release\*

### Opening the rear lid

- ▶ Press the button  on the remote control master key for at least one second. The rear lid unlocks and opens slightly. Or

- ▶ Press the handle on the rear lid ⇒ *fig. 27*. Or
- ▶ Sedan: Pull the release button  in the driver's door ⇒ *fig. 28*

### Closing the rear lid

- ▶ Pull the rear lid down at the grip on the inside and allow it to drop gently to close it ⇒ .

**⚠ WARNING**

- After closing the rear lid, always pull up on it to make sure that it is properly closed. Otherwise it could open suddenly when the vehicle is moving.
- To help prevent poisonous exhaust gas from being drawn into the vehicle, always keep the rear lid closed while driving. Never transport objects larger than those which fit completely into the luggage area, because then the rear lid cannot be fully closed.
- Never leave your vehicle unattended especially with the rear lid left open. A child could crawl into the car through the luggage compartment and pull the lid shut, becoming trapped and unable to get out. To reduce the risk of personal injury, never let children play in or around your vehicle. Always keep the rear lid as well as the vehicle doors closed when not in use.
- Always ensure that no one is within range of the rear lid when it is moving, in particular close to the hinges - fingers or hands can be pinched.

**i Tips**

When the vehicle is locked, the rear lid can be opened separately by pressing the button  on the master key. When you close the rear lid again, it locks automatically.

## Power opening/closing rear lid

Applies to vehicles: with automatic rear lid operation

The open position can be adjusted.





Fig. 29 Driver's door: Unlocking the rear lid



Fig. 30 Locking switch in the rear lid

### Opening rear lid

- ▶ Press the button  on the remote key for at least one second. Or
- ▶ Pull the unlock button  in the driver's door  $\Rightarrow$  fig. 29. Or
- ▶ Press the handle on the rear lid  $\Rightarrow$  page 38, fig. 27.

### Closing rear lid

- ▶ Press the close button in the open rear lid  $\Rightarrow$  fig. 30. The rear lid moves to the closed position by itself and soft close locks it automatically  $\Rightarrow$  .



### Saving the opening angle of the rear lid

- ▶ Bring the luggage compartment lid into the desired open position. The position can only be stored when the lid is above a certain height.
- ▶ Press and hold the  $\Rightarrow$  fig. 30 button for at least four seconds until the lights blink to store the desired open position.

- ▶ To set a higher open position, wait at least five seconds and then carefully press the luggage compartment lid upward.
- ▶ Press and hold the  $\Rightarrow$  fig. 30 button again for at least four seconds and this will store the new open position.

The settings in the radio or MMI\* determine if the rear lid can be opened using the handle  $\Rightarrow$  page 36.



**Opening** will be stopped immediately when:

- You press the  button on the remote control master key for at least one second, or
- You press the  button in the rear lid, or
- You push the handle in the rear lid, or
- You pull the  button in the driver's door, or
- When something blocks the rear lid or makes it difficult for the lid to move.

If you press one of the buttons  now, the rear lid will either open or close, depending on its angle.

If you pull lightly on its handle, the rear lid will close.

**Closing** will be stopped immediately when:

- You press the  button in the rear lid, or
- You push the handle in the rear lid, or
- You release the  button on the driver's door, or
- When something blocks the rear lid or makes it difficult for the lid to move.

If you press one of the buttons  now, the rear lid will either close or open, depending on its angle.

If you pull lightly on its handle, the rear lid will close.

You can manually stop the automatic opening/closing of the luggage compartment lid. The automatic closing process begins if you push down on the rear lid. ▶

### WARNING

- Never close the rear lid inattentively or without checking first. Although the closing force of the rear lid is limited, you can still seriously injure yourself or others.
- Always ensure that no one is within range of the rear lid when it is moving, in particular close to the hinges and the upper and lower edges - fingers or hands can be pinched.
- To help prevent poisonous exhaust gas from being drawn into the vehicle, always keep the rear lid closed while driving. Never transport objects larger than those which fit completely into the luggage area, because then the rear lid cannot be fully closed.
- Never leave your vehicle unattended especially with the rear lid left open. A child could crawl into the car through the luggage compartment and pull the lid shut, becoming trapped and unable to get out. To reduce the risk of personal injury, never let children play in or around your vehicle. Always keep the rear lid as well as the vehicle doors closed when not in use.
- If there is a luggage rack or bicycle rack mounted on the rear lid, it may not be able to open completely or an opened rear lid may close by itself because of the added weight. So the open rear lid must be supported or the weight must be removed from the luggage rack first.

### Tips

- When the vehicle is locked, the rear lid can be unlocked separately by pressing the button  on the master key. When the rear lid is closed again, it locks automatically.
- The following applies to vehicles equipped with the convenience key\* feature: if the remote control key is left in the luggage compartment, luggage compartment will automatically unlock itself af-

ter you lock the vehicle. This prevents you from unintentionally locking your key in the luggage compartment.

- If the vehicle battery charge drops below a certain level, you can still open or close the rear lid manually, however, you will need to apply more force to close it.

### Sedan: Rear lid emergency release

Applies to vehicles: with fixed rear seat backrest

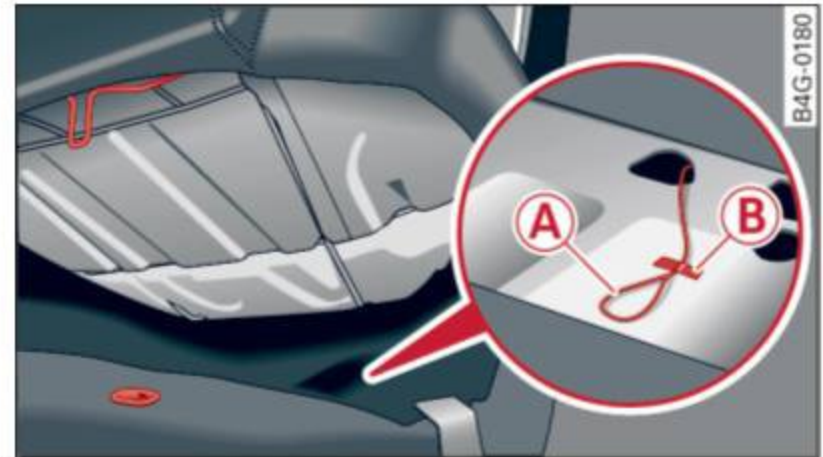

Fig. 31 Rear bench seat: emergency release cable

On vehicles with fixed seat backrest\*, the rear lid can be opened from the rear bench seat using the emergency release.

- ▶ Carefully pull the left side of the rear bench seat out of its retainer until you can reach the release cable ⇒ *fig. 31*.
- ▶ Remove the adhesive tape **(B)**.
- ▶ Pull on the loop **(A)** until the rear lid releases.
- ▶ Tape the release cable back in place and press the bench seat back into its retainer.

### WARNING

After opening the rear lid using the emergency release in vehicles with a fixed rear seat backrest, make sure the bracket under the rear bench seat ⇒ *fig. 31* locks securely into the mounting eyelet again.

### allroad: Rear lid emergency release

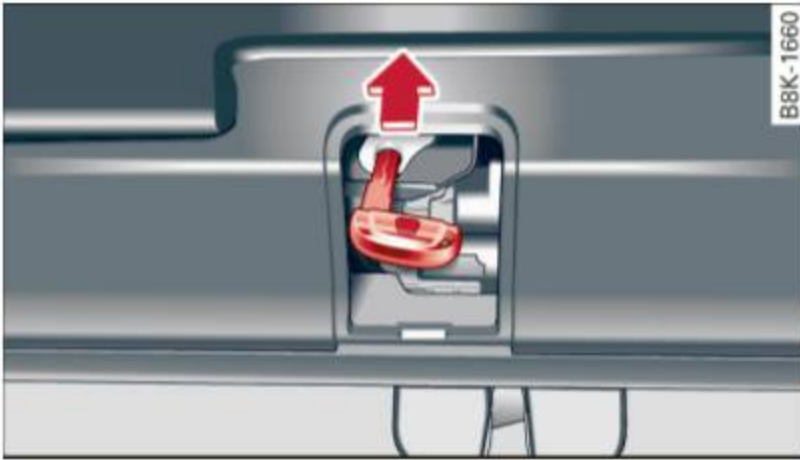

Fig. 32 Rear lid opening: access to the emergency release

The rear lid can be released in an emergency from inside the luggage compartment.

- ▶ Remove the cover from the luggage compartment lid.
- ▶ Remove the mechanical key ⇒ *page 33*.
- ▶ Press the lever in the direction of the arrow with the mechanical key until the luggage compartment lid releases.

### Sedan: Trunk escape handle

In case of an emergency, the luggage compartment lid can be opened from the inside using the trunk escape handle.



Fig. 33 Trunk escape handle: view from inside the closed rear lid

### To open luggage compartment lid

- ▶ Pull the handle down towards the bumper ⇒ *fig. 33*.

The trunk escape handle inside the luggage compartment lid is made of fluorescent material to glow in the dark.

### ! WARNING

The trunk escape handle is to be used only in an emergency.

### i Tips

The emergency release lever should *never* be used as a handle for closing the luggage compartment lid.

## Child safety locks

### Child safety locks in the rear doors

The child safety locks  prevent the rear doors from opening from the inside.



Fig. 34 Rear doors: child safety locks

The child safety lock is visible only when the door is open.

- ▶ Remove the mechanical key ⇒ *page 33*.
- ▶ To switch on the child safety lock, turn the key in the direction of the arrow.
- ▶ To switch off the child safety lock, turn the key in the opposite direction to the arrow.

When the child safety locks are activated, the inside door handles do not work and the doors can only be opened from the outside.

## Power windows

### Controls

The driver can control all power windows.

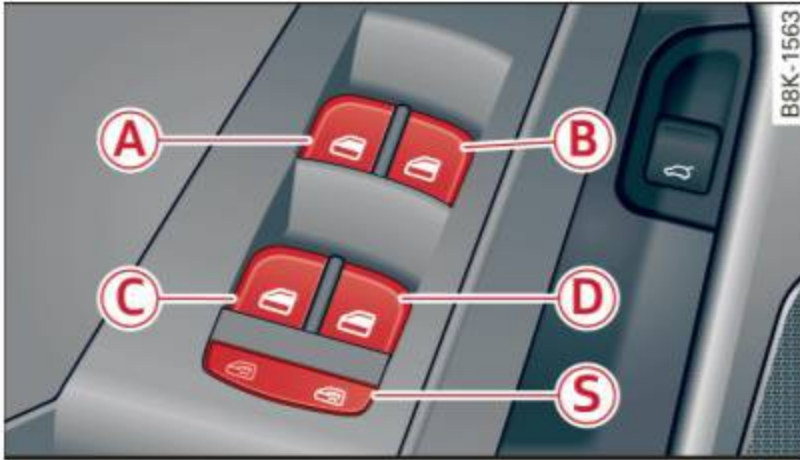

Fig. 35 Section of the driver's door: controls

All power window switches are provided with a **two-position function**:

### Opening the windows

- ▶ Press the switch to the **first stop** and hold it until the window reaches the desired position.
- ▶ Press the switch briefly to the **second stop** to automatically open the window.

### Closing the windows

- ▶ Pull the switch to the **first stop** and hold it until the window reaches the desired position.
- ▶ Pull the switch briefly to the **second stop** to automatically close the window.

### Power window switches

- (A) Driver's door
- (B) Passenger's door
- (C) Left rear door
- (D) Right rear door
- (S) Safety button

### Child safety locks

When the safety button (S) is pressed ⇒ fig. 35, the  symbol in the button lights up. The power window switches in the rear doors are switched off.

### WARNING

- When you leave your vehicle - even if only briefly - always remove the ignition key. This applies particularly when children remain in the vehicle. Otherwise the children could start the engine or operate electrical equipment (e.g. power windows). The power windows are functional until the driver's door or passenger's door has been opened.
- Pay close attention when closing the windows to prevent pinching of hands or limbs.
- When locking the vehicle from outside, the vehicle must be unoccupied since the windows can no longer be opened in an emergency.

### Tips

After the ignition has been switched off, the windows can still be opened or closed for about 10 minutes. The power windows are not switched off until the driver's door or passenger's door has been opened.

### Convenience opening/closing

The windows and the power sunroof can be opened and closed with the mechanical key or the emergency key.

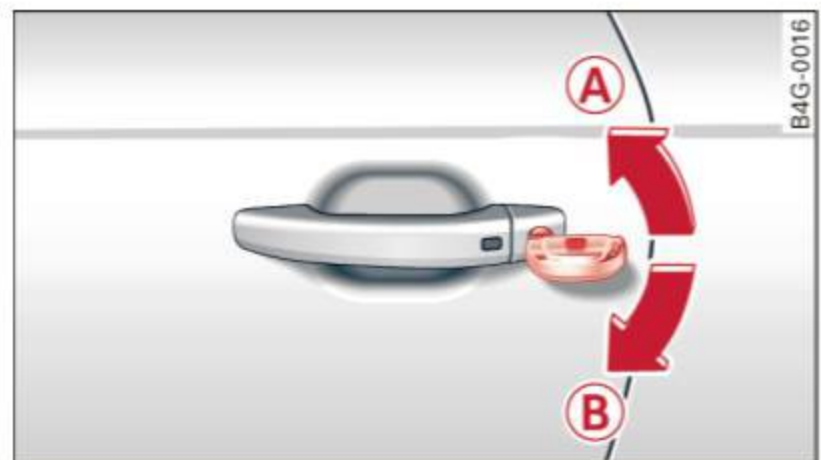



Fig. 36 Key turns for opening and closing

### Convenience opening feature

- ▶ Use the emergency key or pull the mechanical key out of the master key ⇒ page 33.
- ▶ Insert the key into the lock of the driver's door.

- ▶ Turn the key to position ⇒ *fig. 36* **A** until all the windows have reached the desired position and the power sunroof is open.

### Convenience closing feature

- ▶ Use the emergency key or pull the mechanical key out of the master key ⇒ *page 33*.
- ▶ Turn the key in the lock of the driver's door to the lock position **B** until the windows and the power sunroof are closed ⇒ .

For vehicles with Panoramic sliding sunroof\*: When you open or close the Panoramic sliding sunroof\*, the power sunshade will also open or close.

#### **WARNING**

- Never close the windows and the power sunroof inattentively and without checking - there is risk of injury.
- You must always watch when the windows are being raised so that no one can be trapped. If you release the key, the closing action is immediately canceled.
- Always read and heed WARNING ⇒  in *General description on page 31*.

### Correcting window regulator malfunction

*After disconnecting the vehicle battery, the one-touch up and down feature must be activated again.*

- ▶ Pull and hold the power window switch until the window is completely closed.
- ▶ Release the switch and pull the switch again for one second.

## Sunroof

### Operation sliding/tilting sunroof

Applies to vehicles: with sliding/tilting sunroof



**Fig. 37** Section of headliner: knob for sunroof

### Tilting

Requirement: the roof switch must be in the **0** position ⇒ *fig. 37*.

- ▶ To tilt it, briefly press the switch ⇒ *fig. 37*.
- ▶ To close it, briefly pull the switch ⇒ .
- ▶ To set an intermediate position, press/pull the switch until the roof reaches the desired position.

### Opening/sliding

- ▶ To slide the roof all the way open, turn the switch to the **1** position.
- ▶ To close the sunroof completely, turn the switch to **0** position ⇒ .
- ▶ To select a setting in between, turn the switch to the desired position.

The sunshade can be opened and closed manually in any position. When opening the sunroof, the sunshade is automatically opened.

After the ignition is switched off, you can still operate the sunroof for about 10 minutes. As soon as the driver's or passenger's door is opened, the switch is inoperative.

#### **WARNING**

Pay careful attention when closing the sunroof - otherwise serious injury could result! For this reason, always remove the ignition key when leaving the vehicle.

**! Note**

Always close your sunroof when leaving your vehicle. Sudden rain can cause damage to the interior equipment of your vehicle, particularly the electronic equipment.

**i Tips**

– Information on convenience opening/closing ⇒ *page 42*.

**Operation panorama sunroof**

Applies to vehicles: with panorama sunroof



Fig. 38 Section from headliner: knob for sunroof.

**Tilting**

- ▶ The sunroof can be tilted or closed only in switch position 0 ⇒ *fig. 38*
- ▶ To tilt it, briefly press the switch ⇒ *page 43, fig. 37*.
- ▶ To close it, briefly pull the switch ⇒ .
- ▶ To set an intermediate position, press/pull the switch until the roof reaches the desired position.

**Opening**

- ▶ To open the sunroof completely, turn and hold the switch against the resistance in position 1.
- ▶ To close the sunroof, turn the rotary switch to position 0 ⇒ .
- ▶ An intermediate position can be set by turning the rotary switch to the desired position.

**Opening/closing the sunshade**

- ▶ Press the switch 2 ⇒ *page 43, fig. 37* in the desired arrow direction.
- ▶ To stop the sunshade in an intermediate position, press the switch again.

After the ignition is switched off, you can still operate the sunroof for about 10 minutes. As soon as the driver's or passenger's door is opened, the switch is inoperative.

The power sunshade can also be closed when the sunroof is open.

**! WARNING**

Pay careful attention when closing the sunroof - otherwise serious injury could result! For this reason, always remove the ignition key when leaving the vehicle.

**! Note**

Always close your sunroof when leaving your vehicle. Sudden rain can cause damage to the interior equipment of your vehicle, particularly the electronic equipment.

**i Tips**

– Information on convenience opening/closing ⇒ *page 42*.

**Emergency closing of the sunroof**

If the sunroof detects an object in its path when it is closing, it will open again automatically. In this case, you can close the roof with the power emergency closing function.

- ▶ Within five seconds after the sunroof opens automatically, pull the switch until the roof closes.

## Valet parking

Applies to vehicles: with folding and lockable rear seatbacks

The valet parking feature protects the luggage compartment from unauthorized access.





Fig. 39 Glove compartment: valet parking button

You can switch the “valet parking function” on when someone else is parking your vehicle. When the function is switched on, the vehicle can be driven, locked and unlocked using the master key, but access to the luggage compartment is not permitted.

- ▶ Take the mechanical key out of the master key ⇒ *page 33*.
- ▶ Open the glove compartment ⇒ *page 67*.
- ▶ Activate ⇒ *fig. 39* the “valet parking” feature by pressing the **VALET** button. The indicator light in the switch illuminates.
- ▶ Close the glove compartment and lock it with the mechanical key.
- ▶ Lock both rear seatbacks with the mechanical key ⇒ *page 71*.
- ▶ Lock the luggage compartment pass-through with the mechanical key ⇒ *page 75*.
- ▶ Leave the master key with the service personnel for parking and keep the mechanical key with you.

The following buttons are deactivated when the valet parking function is switched on:

-  button in the driver's door
-  button on the master key
- Handle in the rear lid

When the valet parking feature is activated, the message **Valet parking activated** appears

in the instrument cluster display when you switch the ignition on.

## Garage door opener (HomeLink)

### Description

Applies to vehicles: with garage door opener (HomeLink)



Fig. 40 Garage door opener: examples of using with different systems

You can activate various systems such as garage doors, security systems and home lighting from inside your vehicle using the garage door opener (HomeLink). There are three buttons for this in the vehicle headliner that can be in used in place of up to three hand-held transmitters.

To operate systems using the garage door opener, the three buttons in the roof headliner must be programmed first.

### WARNING

Make sure no people or objects are in the immediate vicinity of the equipment when using or programming the garage door opener. People can be injured and objects can be damaged if they are caught in the equipment.

### Tips

- For security reasons, we recommend that you clear the programmed buttons before selling the vehicle.
- For additional information about HomeLink, visit [www.homelink.com](http://www.homelink.com).
- For Declaration of Compliance to United States FCC and Industry Canada regulations ⇒ *page 286*.

## Operation

Applies to vehicles: with garage door opener (HomeLink)



Fig. 41 Headliner: control unit

Requirement: The buttons in the roof headliner must be programmed ⇒ *page 46* or ⇒ *page 47* and the vehicle must be within range of the system, such as the garage door opener.

- ▶ Press the button to open the garage door. The LED **A** blinks or turns on.
- ▶ Press the button again to close the garage door.

### **i** Tips

To open or close the garage door, press the button, but do not hold it for longer than 10 seconds or the garage door opener module will switch to programming mode.

## Programming the buttons (version A)

Applies to vehicles: with garage door opener (HomeLink)

You can program both fixed code and rolling code systems using this procedure.

### Programming or reprogramming buttons

- ▶ Switch the ignition on.
- ▶ Press and hold the button in the roof headliner ⇒ *page 46, fig. 41* that you would like to program for at least 10 seconds. Or
- ▶ Select: **CAR** function button > **Car systems\*** control button > **Vehicle settings** > **Garage door opener** > **Program garage door opener**. If this path is not available, program the button as described in version B ⇒ *page 47*.
- ▶ Follow the instructions in the MMI.

## Erasing button programming

The programmed buttons cannot be erased individually. They must all be erased together. Reprogram the buttons if necessary.

- ▶ Select: **CAR** function button > **Car systems\*** control button > **Vehicle settings** > **Garage door opener** > **Clear program settings** > **Yes**.

## Displaying the version/status/country code

- ▶ Select: **CAR** function button > **Car systems\*** control button > **Vehicle settings** > **Garage door opener** > **Version information**.

### **i** Tips

- Programming through the MMI\* is not possible with all infotainment systems. If this is the case, program the buttons as described in version B ⇒ *page 47*.
- The required distance between the hand transmitter and the HomeLink module in the radiator grille ⇒ *page 47, fig. 42* depends on the system that you are programming.
- Depending on the model of the system, you may need to release the button on the remote control during programming and press it again. Hold each position you try for at least 15 seconds before trying another position. Keep the turn signals on your vehicle in view when doing this.
- After programming the garage door opener, it may be necessary to synchronize the motor with the system. Refer to the manufacturer's instructions.

## Programming the buttons (version B)

Applies to vehicles: with garage door opener (HomeLink)



Fig. 42 Distance between the radiator grille and the hand transmitter

### Programming the button: Part 1 with the controls

1. Switch the ignition on.
2. Press and hold both outer buttons in the roof headliner ⇒ *page 46, fig. 41* until the LED **A** turns off completely (after about 20 seconds). This procedure clears the standard codes that were set at the factory and does **not** need to be repeated again to program the other buttons.
3. Briefly press the button on the roof headliner that you would like to program.
4. Wait until the LED **A** begins to blink quickly. Programming mode is active for 5 minutes.
5. Move in front of your vehicle while holding the original remote control for the system that you would like to program to a button in the roof headliner.

### Programming the button: Part 2 at the radiator grille

6. Hold the remote control up to the radiator grille on your vehicle ⇒ *fig. 42*.
7. Press and hold the remote control until the turn signals on your vehicle blink. This may take up to 30 seconds.
8. If the emergency flashers blink three times, the programming was successful. If the emergency flashers only blink one time, the 5 minute time limit for the programming has ended or the programming was not successful. Repeat the programming from the third step, or try changing the distance to the radiator grille.

9. If the garage door or other system does not open using the buttons in the roof headliner even though the programming was successful, the system may use a rolling code instead of a fixed code. **Rolling code programming** must be performed ⇒ *page 48*.

The other two buttons in the roof headliner can be programmed according to the instructions above. Begin with the third step.

### Erasing button programming

The programmed buttons cannot be erased individually. They must all be erased together. Reprogram the buttons if necessary.

- ▶ Switch the ignition on.
- ▶ Press and hold both outer buttons in the roof headliner until the LED **A** turns off completely (after about 20 seconds).

### Reprogramming the buttons

- ▶ Switch the ignition on.
- ▶ To reprogram an individual button, press and hold the button until the LED **A** starts to flash quickly (after about 10 seconds). Release the button immediately. Programming mode is active for 5 minutes.
- ▶ Continue with the fifth step.

#### **i** Tips

- Programming using the buttons in the roof headliner is not possible with all Infotainment systems. If this is the case, program the buttons as described in version A ⇒ *page 46*.
- The required distance between the hand transmitter and the HomeLink module in the radiator grille ⇒ *fig. 42* depends on the system that you are programming.
- Depending on the model of the system, you may need to release the button on the remote control during programming and press it again. Hold each position you try for at least 15 seconds before trying another position. Keep the turn signals on your vehicle in view when doing this.

**Rolling code programming**

Applies to vehicles: with garage door opener (HomeLink)

*Rolling code programming is also needed for some systems.*

**Identifying a rolling code**

- ▶ Press and hold the button in the roof headliner that was already programmed.
- ▶ Watch the LED  ⇒ *page 46, fig. 41*. If the LED blinks quickly, the system (such as a garage door) is equipped with a rolling code.
- ▶ Program the rolling code as follows:

**Activating the motor unit in a system**

- ▶ Locate the programming button on the system's motor unit. The exact location and color of the button may vary depending on the brand of the system.
- ▶ Press the programming button on the garage door opener motor unit (this will usually activate an "indicator" on the motor unit). You now have approximately **30 seconds** to program the button in the roof headliner.

**Programming the button in the roof headliner**

- ▶ Press and hold the previously programmed button in the roof headliner for 2 seconds.
- ▶ To end rolling code programming, press and hold the button again for 2 seconds.
- ▶ With some systems, the button may need to be pressed a third time to end the programming process.

After programming, the system should detect the signal and begin moving when the button in the roof headliner is pressed. Now you may program the other buttons as needed.

 **Tips**

- The rolling code can be programmed more quickly and more easily with the help of a second person.
- If you have difficulty programming the rolling code, referring to the user guide for the system may help.

## Clear vision

### Lights

#### Switching the lights on and off

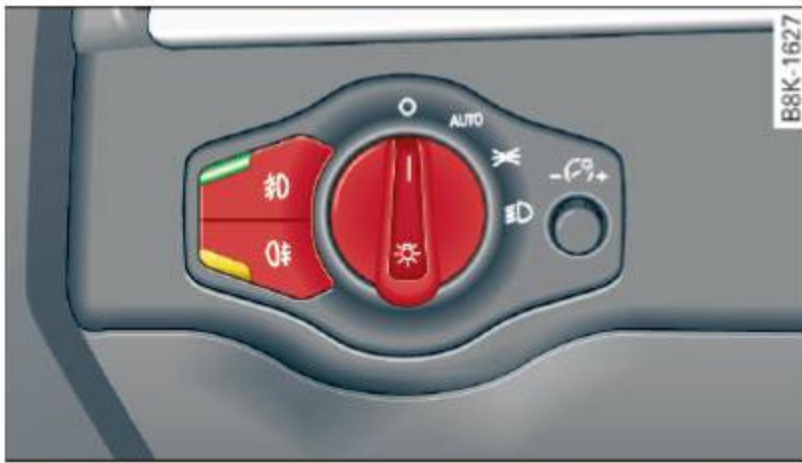





Fig. 43 Instrument panel: headlight control switch

#### Light switch

Turn the switch  $\Rightarrow$  *fig. 43* to the corresponding position. When the lights are switched on, the  $\Rightarrow$  symbol turns on.

0 - The lights are off or the daytime running lights are on:

- **USA models:** The daytime running lights are activated when the light switch  $\Rightarrow$  *fig. 43* is in the **0** position or the **AUTO** position (only in daylight conditions). The daytime running lights function can be turned on and off in the radio or MMI\* menu **Exterior lighting**  $\Rightarrow$  *page 50*,  $\Rightarrow$  .
- **Canada models:** The daytime running lights are activated when the light switch  $\Rightarrow$  *fig. 43* is in the **0** position,  $\Rightarrow$  position or the **AUTO** position (only in daylight conditions). The daytime running lights function cannot be turned off  $\Rightarrow$  .

AUTO\* - Automatic headlights switch on and off depending on brightness, for example in twilight, during rain or in tunnels  $\Rightarrow$  .

$\Rightarrow$  - Side marker lights

$\Rightarrow$  - Low beam headlights

#### Fog lights/rear fog light(s)\*

Press the appropriate button  $\Rightarrow$  *fig. 43*:

$\Rightarrow$  - Fog lights

$\Rightarrow$  - Rear fog light(s)

#### adaptive light\*

When switched on, adaptive light adapts to curves in the road depending on the vehicle speed and the steering angle. This provides better lighting through the curve. The system operates at speeds between approximately 6 mph (10 km/h) and 68 mph (110 km/h).

**Static cornering light\*** (vehicles with adaptive light) - the cornering light switches on at speeds up to approximately 25 mph (40 km/h) when a certain steering wheel angle is reached or when a turn signal is activated. The area to the side of the vehicle is illuminated better when turning.

The adaptive light and the cornering light only function when the switch is in the AUTO position (automatic headlights\*).

#### WARNING

- Daytime running lights and automatic headlights\* are only intended to assist the driver. They do not relieve the driver of his responsibility to check the headlights and to turn them on manually according to the current light and visibility conditions. For example, fog cannot be detected by the light sensors\*. So always switch on the headlights  $\Rightarrow$  under these weather conditions and when driving in the dark.
- Crashes can happen when you cannot see the road ahead and when you cannot be seen by other motorists. Always turn on the headlights so that you can see ahead and so that others can see your car from the back.
- Please obey all laws when using the lighting systems described here.

#### Note

The rear fog lights\* should only be turned on in accordance with traffic regulation, as the lights are bright for following traffic.  $\blacktriangleright$

### **i** Tips

- The light sensor\* for headlight control is located in the rear view mirror mount. You should therefore not apply any stickers to the windshield in this area in order to prevent malfunctions or failures.
- Some exterior lighting functions can be adjusted ⇒ *page 50*.
- When you remove your key from the ignition while the vehicle's lights are turned on, a buzzer sounds as long as the driver's door is open.
- In cool or damp weather, the inside of the headlights, turn signals and tail lights can fog over due to the temperature difference between the inside and outside. They will clear shortly after switching them on. This does not affect the service life of the lighting.
- In the event of a light sensor malfunction, the driver is notified in the instrument cluster display ⇒ *page 22*.

### Turn signals and high beam lever

The lever operates the turn signals, the high beams and the headlight flasher.

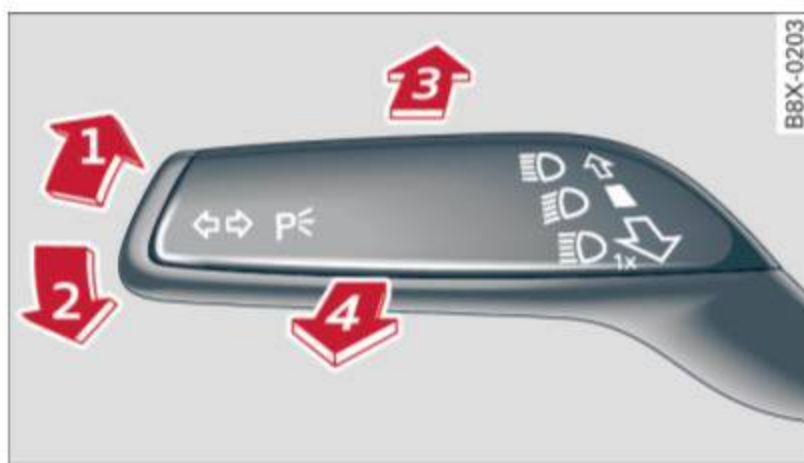

Fig. 44 Turn signal and high beam lever

### Turn signals ⇐⇒

The turn signals activate when you move the lever into a turn signal position when the ignition is switched on.

- ① - right turn signal
- ② - left turn signal

The turn signal blinks three times if you just tap the lever.





### High beams and headlight flasher

Move the lever to the corresponding position:

- ③ - high beams on
- ④ - high beams off or headlight flasher

The indicator light  in the instrument cluster turns on.

### Notes on these features

- The *turn signals* only work with the ignition turned on. The indicator lights  or  in the instrument cluster also blink.
- After you have turned a corner, the turn signal switches off automatically.
- The *high beam* works only when the headlights are on. The indicator light  in the instrument cluster illuminates when the high beams are on.
- The *headlight flasher* works only as long as you hold the lever - even if there are no lights switched on. The indicator light  in the instrument cluster illuminates when you use the headlight flasher.

### WARNING

Do not use the high beam or headlight flasher if you know that these could blind oncoming traffic.

### Adjusting exterior lighting

The functions are selected in the radio or MMI\*.

- ▶ Select: **CAR** function button > **Exterior lighting**. Or
- ▶ Select: **CAR** function button > **Car systems\*** control button > **Vehicle settings** > **Exterior lighting**.

### Coming home (light when leaving car)\*, Leaving home (light when unlocking car)\*

The **coming home** function illuminates the area around the vehicle when the ignition is switched off and the driver's door is opened. Depending on vehicle equipment, the function can be switched on and off or the length of time the lights remain on\* can be adjusted. ▶

The **leaving home** function illuminates the area around the vehicle when unlocking it. This function can be switched on and off.

The **coming home** and **leaving home** functions only operate when it is dark and the light switch is in the AUTO position  
⇒ page 49, fig. 43.

### Auto headlights\*

When the light switch is in the AUTO  
⇒ page 49 position, the switch-on point of the lights can be changed in the automatic driving light function.

### Daytime running lights

**USA models:** You can switch the daytime running lights **on** and **off**.

**Canada models:** The function cannot be turned off. It is activated automatically each time the ignition is switched on.

### Travel mode\*

The headlight beam is asymmetrical. This provides stronger illumination on the side of the road on which you are driving. If you are driving in a country that drives on the opposite side of the road from your own country, this will cause glare for oncoming drivers. To prevent glare:

- Travel mode must be selected in vehicles with Xenon headlights\*.
- In vehicles with halogen headlights, certain areas of the headlight lenses must be covered with waterproof adhesive covers that prevent light from passing through. For more information, please see your authorized Audi dealer or authorized repair facility.

#### **i** Tips

When travel mode is activated, a display in the driver information system indicates this each time you switch the ignition on.



### Emergency flashers



Fig. 45 Center console: emergency flasher switch

The emergency flashers makes other motorists aware that you or your vehicle are in an emergency situation.

- ▶ Press the switch  ⇒ fig. 45 to turn the emergency flashers on or off.

When the emergency flashers are on, all four turn signals blink at the same time. The turn signal indicator lights   in the instrument cluster, as well as the light in the emergency flasher switch  blink likewise.

You can indicate a lane change or a turn when the emergency flashers are switched on by using the turn signal lever. The emergency flashers stop temporarily.

The emergency flashers also work when the ignition is turned off.

The emergency flashers will turn on automatically if you are in an accident where the airbag has deployed.

#### **i** Tips

You should turn on the emergency flashers when:

- you are the last vehicle standing in a traffic jam so that any other vehicles coming can see you, or when
- your vehicle has broken down or you are in an emergency situation, or when
- your vehicle is being towed by a tow truck or if you are towing another vehicle behind you.

## Interior lights

### Front/rear interior lights



Fig. 46 Front headliner: interior lighting controls

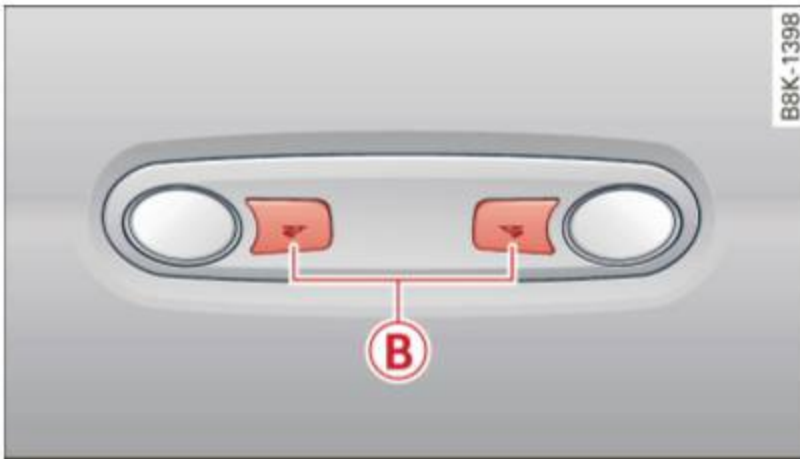

Fig. 47 Rear headliner: rear reading lights

#### **A** Interior lights

Press the switch ⇒ *fig. 46* in the corresponding position.

0 - Interior lights off

I - Interior lights on

If the switch is in the center position, the interior lighting is controlled automatically.

#### **B** Front/rear reading lights

To turn a reading light on/off, press the button  ⇒ *fig. 46* or ⇒ *fig. 47*.

The appearance and location of the rear reading lights may differ depending on the model.

### Instrument illumination

The basic brightness of the illumination for the instruments, the center console and the display can be adjusted.



Fig. 48 Instrument illumination

- ▶ Press the knob to release it.
- ▶ Turn the knob toward "-" or "+" to reduce or increase the brightness.
- ▶ Press the knob again to return it to its original position.

#### **i** Tips

The instrument illumination (for dials and needles) lights on when the ignition is switched on and the vehicle lights are turned off. As the daylight fades, the illumination of the dials likewise dims automatically and will go out completely when the outside light is very low. This feature is meant to remind you to switch on the headlights when outside light conditions become poor.

## Vision

### Adjusting the exterior mirrors



Fig. 49 Forward section of driver's armrest: power mirror controls

Turn the knob to the desired position:

↔ - In this position, you can adjust the driver's and front passenger's exterior mirrors by turning the knob in the desired direction.

☀ - The mirrors are heated depending on the outside temperature.

↔ - The exterior mirrors fold in\*. You can adjust whether or not the mirrors fold in automatically when locking the vehicle using the radio/MMI\* ⇒ *page 36*.

### Passenger exterior mirror tilt function\*

To help you see the curb when backing into a parking space, the surface of the mirror tilts slightly. The knob must be in the ↔ position for this to happen.

You can adjust the tilted mirror surface by turning the knob in the desired direction. When you move out of reverse and into another gear, the new mirror position is stored and assigned to the key you are using.

The mirror goes back into its original position once you drive forward faster than 9 mph (15 km/h) or switch the ignition off.

### WARNING

Curved mirror surfaces (convex or spherical\*) increase your field of view. Remember that vehicles or other objects will appear smaller and farther away than when seen in a flat mirror. If you use this mirror to estimate distances of following vehicles when changing lanes, you could estimate incorrectly and cause an accident.

### Note

- If the mirror housing is moved unintentionally (for example, while parking your vehicle), then you must first fold the mirror electrically. Do not readjust the mirror housing manually. You could damage the motor which controls the mirror.
- If you wash the vehicle in an automatic car wash, you must fold the exterior mirrors in to reduce the risk of damage to the mirrors. Never fold power folding ex-

terior mirrors\* by hand. Only fold them in and out using the power controls.

### Tips

- The exterior mirror settings are stored with the memory function\* ⇒ *page 64*.
- If there should be a malfunction in the electrical system, you can still adjust the exterior mirrors by pressing the edge of the mirror.

### Dimming the mirrors

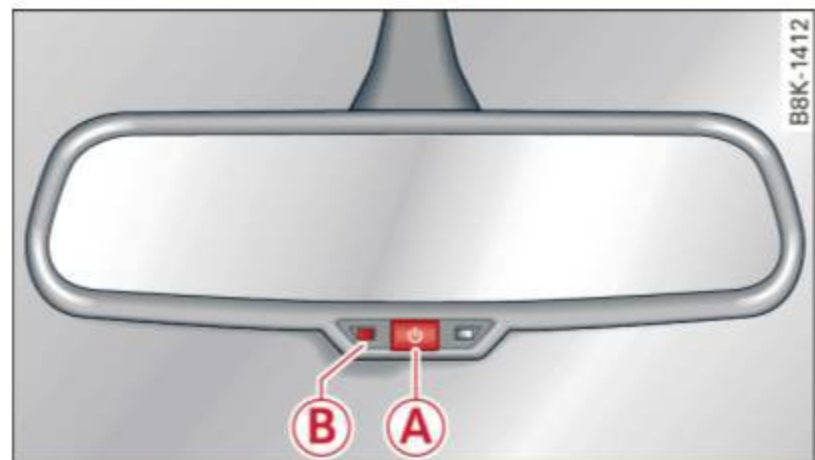

Fig. 50 Automatic dimming rearview mirror\*

### Manual dimming rearview mirror

- ▶ Pull the lever on the bottom of the mirror back.

### Automatic dimming rearview mirror\*

- ▶ Press the button (A) ⇒ *fig. 50*. The indicator light (B) turns on. The rearview and exterior\* mirrors dim automatically when light shines on them, for example from headlights on a vehicle to the rear.

### WARNING

- Electrolyte fluid can leak from automatic dimming mirrors if the glass is broken. Electrolyte fluid can irritate skin, eyes and respiratory system.
- Repeated or prolonged exposure to electrolyte can cause irritation to the respiratory system, especially among people with asthma or other respiratory conditions. Get fresh air immediately by leaving the vehicle or, if that is not possible, open windows and doors all the way.

- If electrolyte gets into the eyes, flush them thoroughly with large amounts of clean water for at least 15 minutes; medical attention is recommended.
- If electrolyte contacts skin, flush affected area with clean water for at least 15 minutes and then wash affected area with soap and water; medical attention is recommended. Thoroughly wash affected clothing and shoes before reuse.
- If swallowed and person is conscious, rinse mouth with water for at least 15 minutes. Do not induce vomiting unless instructed to do so by medical professional. Get medical attention immediately.

### ! Note

Liquid electrolyte leaking from broken mirror glass will damage any plastic surfaces it comes in contact with. Clean up spilled electrolyte immediately with clean water and a sponge.

### i Tips

- Switching off the dimming function of the inside rear view mirror also deactivates the automatic dimming function of the exterior mirrors.
- Automatic dimming for the mirror only operates properly if the sun shade\* for the rear window is not in use or the light striking the inside mirror is not hindered by other objects.
- The automatic dimming mirrors do not dim when the interior lighting is turned on or the reverse gear is selected.

### Sun visors



Fig. 51 Driver's side: sun visor

The sun visors for the driver and passenger can be pulled out of their brackets in the center of the vehicle and turned towards the doors ①. After the sun visor has been turned to the door, it can be extended lengthwise.

The mirror light switches on when the cover over the vanity mirror ② opens.

### Rear door sun shade

Applies to vehicles: with rear door sun shade



Fig. 52 Raised rear door sun shade

- Pull the shade out and hang it in the bracket on the upper door frame ⇒ fig. 52.

## Rear window sun shade

Applies to vehicles: with rear window sun shade



Fig. 53 With MMI: Button for rear window sun shade



Fig. 54 Without MMI: Button for rear window sun shade

- ▶ To extend/retract the sun shade, press the  button ⇒ *fig. 53* or ⇒ *fig. 54*.

You can adjust the settings for the rear sun shade so the shade retracts automatically when you select the reverse gear. To do this, select the **CAR** function button > **Windows** > **Rear blind** > **automatic** > **on** or **CAR** function button > **Car systems\*** control button > **Vehicle settings** > **Automatic rear blind** > **On**. The current setting is automatically stored and assigned to the remote key. The sun shade is extended again as soon as the vehicle is traveling forward at a speed greater than 9 mph (15 km/h) if the ignition has not been switched off in the meantime.

### WARNING

When lowering or raising the sunshade, make sure there is nothing in its way and that it has a free path to travel. This could cause personal injury.

### Tips

- Pressing the button  several times consecutively can trigger the overload protection. The sun shade can only be extended/retracted again after a brief waiting period.
- The rear window sun shade only functions when the vehicle interior is warmer than 14°F (-10°C).

## Wiper and washer system

### Switching the windshield wipers on

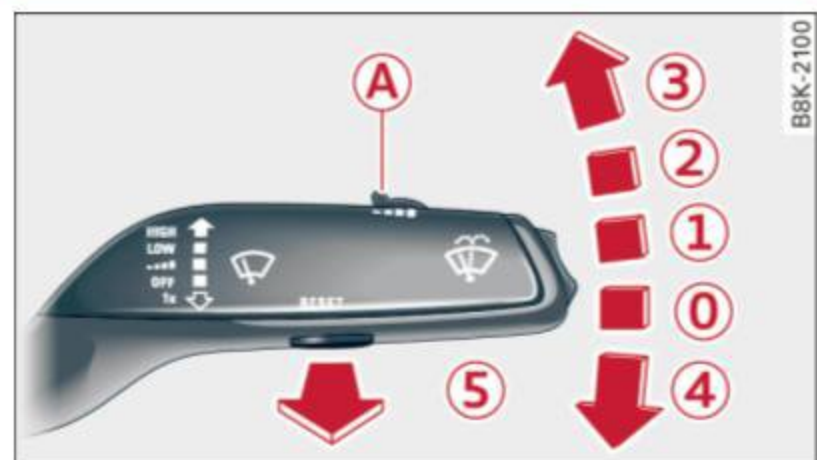

Fig. 55 Windshield wiper lever



Fig. 56 allroad: Rear wiper actuation

Move the windshield wiper lever to the corresponding position:

- ① - Windshield wiper off
- ① - Interval mode. To extend/shorten the wiper intervals, move the switch **A** to the left/right. In vehicles with a rain sensor\* the wipers turn on in the rain once the vehicle speed exceeds approximately 2 mph (4 km/h). The higher the sensitivity of the rain sensor\* is set (switch **A** to the right), the earlier the windshield wipers react to moisture on the windshield. In some models, you can switch

rain sensor mode off and switch intermittent mode on in the MMI\*. Select: **CAR** function button > **Car systems\*** control button > **Driver assist** > **Rain sensor**. In intermittent mode, you can adjust the interval time using the **A** switch.

**2** - Slow wiping

**3** - Fast wiping

**4** - Single wipe

**5** - Clean the windshield. To eliminate water droplets, the windshield wiper performs one afterwipe operation after several seconds while driving. You can switch this function off by moving the lever to position **5** within 10 seconds of the afterwipe operation. The afterwipe function is reactivated the next time the ignition is switched on.

allroad: The rear wiper automatically switches on when the reverse gear is engaged and the front windshield wipers are on and in operation.

Cleaning the headlights\*. The headlight washer system\* operates only when the headlights are on. If you move the lever to position **5**, the headlights are washed in intervals.

**6** - allroad: Wipe the rear window. The rear wiper moves about every 4 seconds.

**7** - allroad: Clean the rear window. The number of wiping operations depends on how long the lever is held in position **7**.

### WARNING

- The rain sensor is only intended to assist the driver. The driver is still responsible for manually switching the wipers on according to the visibility conditions.
- The windshield may not be treated with water-repelling windshield coating agents. Unfavorable conditions, such as wetness, darkness, low sun, can result in increased glare. Wiper blade chatter is also possible.
- Properly functioning windshield wiper blades are required for a clear view and

safe driving ⇒ *page 57, Replacing windshield wiper blades.*

### Note

- In the case of frost, check whether the windshield wiper blades are frozen to the windshield. Switching on the windshield wipers can damage the wiper blades!
- Prior to using a car wash, the windshield wiper system must be switched off (lever in position **0**). This helps to prevent unintentional switching on and damage to the windshield wiper system.

### Tips

- The windshield wipers are switched off when the ignition is turned off. Activate the windshield wipers after the ignition is switched back on by moving the windshield wiper lever to any position.
- Worn or dirty windshield wiper blades result in streaking. This can affect the rain sensor\* function. Check your windshield wiper blades regularly.
- The washer fluid nozzles of the windshield washer system are heated at low temperatures when the ignition is on.
- When stopping temporarily, (e.g. at a traffic light) the set speed of the windshield wipers is automatically reduced by one speed.

### Cleaning windshield wiper blades

Clean the windshield wiper blades when they begin to leave streaks. Use a soft cloth and glass cleaner to clean the windshield wiper blades.

#### Front wiper

- ▶ Place the windshield wiper arms in the service position. Refer to ⇒ *page 57*.
- ▶ Lift the wiper arm away from the front window. ▶

## Rear wiper\*

- ▶ Lift the wiper arm away from the rear window.

### WARNING

Dirty windshield wiper blades can impair your view. This can lead to accidents.

## Replacing windshield wiper blades

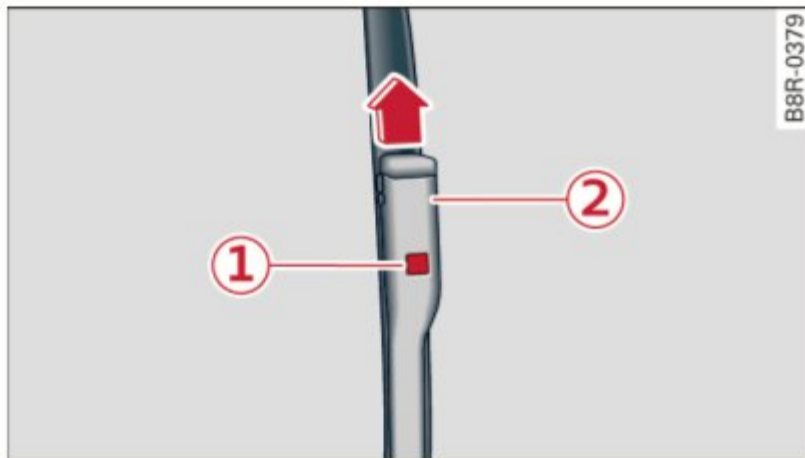

Fig. 57 Removing windshield wiper blade

## Wiper service position/blade replacement position

- ▶ Switch the ignition off and move the windshield wiper lever to position ④ ⇒ page 55, fig. 55. The windshield wipers move into the service position.
- ▶ To bring the wipers back into the original position, switch the ignition on and press the windshield wiper lever.

You can also turn the service position on or off in the radio/MMI\*:

- ▶ Switch the windshield wipers off (position ① ⇒ page 55, fig. 55).
- ▶ Select: **CAR** function button > **Windshield wipers** > **Service position** > **on/off**. Or
- ▶ Select: **CAR** function button > **Car systems\*** control button > **Servicing & checks** > **Wiper service position** > **On/Off**.

## Removing the wiper blade

- ▶ Lift the windshield wiper arm up from the windshield.
- ▶ Press the locking knob ① ⇒ fig. 57 on the wiper blade. Hold the wiper blade firmly.
- ▶ Remove the wiper blade in the direction of the arrow.

## Attaching the wiper blade

- ▶ Install the new wiper blade in the retainer on the wiper arm ② until you hear it click into place on the wiper arm.
- ▶ Place the wiper arm back on the windshield.
- ▶ Turn the service position off.

### WARNING

For your safety, you should replace the wiper blades once or twice a year. See your authorized Audi dealer for replacement blades.

### Note

- The windshield wiper blades must only be replaced when in the service position! Otherwise, you risk damaging the paint on the hood or the windshield wiper motor.
- You should not move your vehicle or press the windshield wiper lever when the wiper arms are folded away from the windshield. The windshield wipers would move back into their original position and could damage the hood and windshield.
- To help prevent damage to the wiper system, always loosen blades which are frozen to the windshield before operating wipers.
- To help prevent damage to wiper blades, do not use gasoline, kerosene, paint thinner, or other solvents on or near the wiper blades.
- To help prevent damage to the wiper arms or other components, do not attempt to move the wipers by hand.

### Tips

- Commercial hot waxes applied by automatic car washes affect the how easily the glass surface can be cleaned.
- You can also use the service position, for example, if you want to protect the windshield from icing by using a cover.

### Replacing the rear wiper blade

Applies to vehicles: with rear wiper



Fig. 58 Rear wiper: Removing the wiper blade

### Removing the wiper blade

- ▶ Fold the windshield wiper arm away from the windshield.
- ▶ Pull the wiper blade and holder out of the mount.

### Attaching the wiper blade

- ▶ Press the wiper blade holder in the arrow direction ⇒ fig. 58 into the mount.
- ▶ Fold the windshield wiper arm back onto the windshield.

### ! WARNING

For safety reasons, the windshield wiper blades should be replaced once or twice each year.

## Digital compass

### Switching the compass on and off

Applies to vehicles: with digital compass

The compass direction is shown in the rearview mirror.



Fig. 59 Rearview mirror: Digital compass activated

- ▶ To switch the compass on or off, press and hold the button **A** until the compass display in the mirror ⇒ fig. 59 appears or disappears.

The digital compass only works when the ignition is on. The directions are indicated with abbreviations: **N** (north), **NE** (northeast), **E** (east), **SE** (southeast), **S** (south), **SW** (southwest), **W** (west), **NW** (northwest).

### i Tips

To prevent inaccurate compass readings, do not bring any remote controls, electrical devices or metallic objects near the mirror.

### Adjusting the magnetic zone

Applies to vehicles: with digital compass

The magnetic zone must be adjusted correctly for the compass to read accurately.

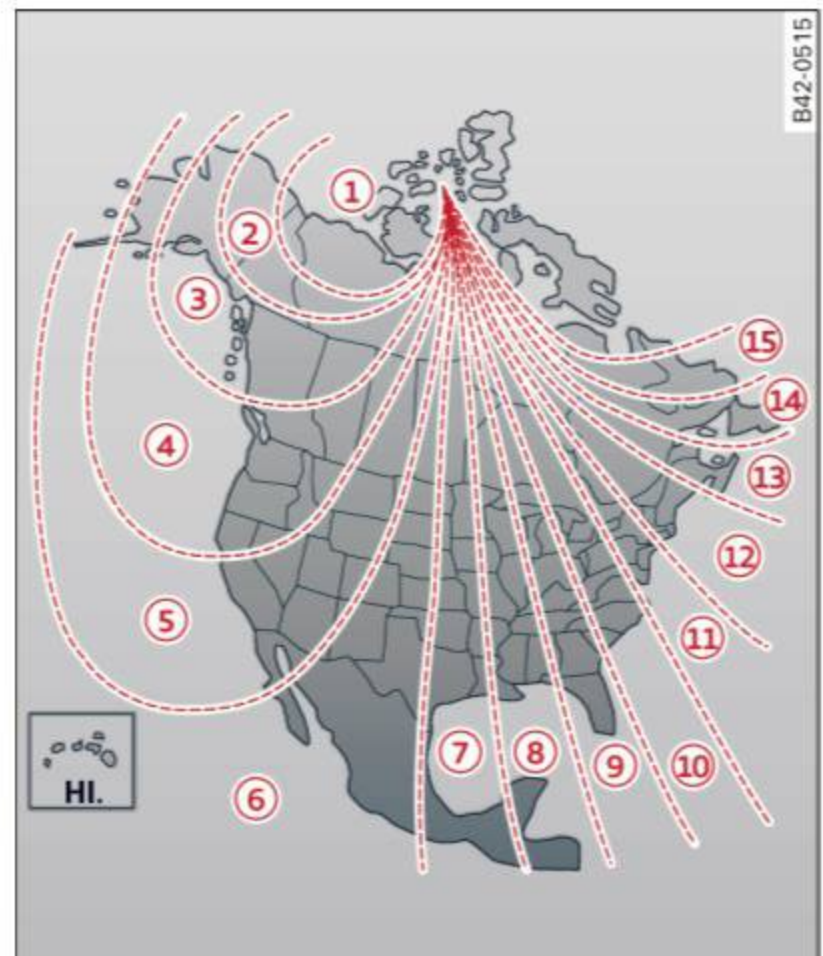

Fig. 60 North America: magnetic deflection zone boundaries

- ▶ Press and hold the button **A** ⇒ fig. 60 until the number of the magnetic zone appears in the rearview mirror.
- ▶ Press the button **A** repeatedly to select the correct magnetic zone. The selection mode turns off after a few seconds.

## Calibrating the compass

Applies to vehicles: with digital compass

*You must recalibrate the compass if it does not display the correct direction.*

- ▶ Press and hold the button **A** until a **C** appears in the rearview mirror.
- ▶ Drive in a circle at about 6 mph (10 km/h) until a direction is displayed in the rearview mirror.



### WARNING

- To avoid endangering yourself and other drivers, calibrate the compass in an area where there is no traffic.
- The digital compass is to be used as a directional aid only. Even though you may want to look at it while you are driving, you must still pay attention to traffic, road and weather conditions as well as other possible hazards.

## Seats and storage

### General recommendations

#### Why is your seat adjustment so important?

*The safety belts and the airbag system can only provide maximum protection if the front seats are correctly adjusted.*

There are various ways of adjusting the front seats to provide safe and comfortable support for the driver and the front passenger. Adjust your seat properly so that:

- you can easily and quickly reach all the switches and controls in the instrument panel
- your body is properly supported thus reducing physical stress and fatigue
- the safety belts and airbag system can offer maximum protection ⇒ *page 144.*

In the following sections, you will see exactly how you can best adjust your seats.

There are special regulations and instructions for installing a child safety seat on the front passenger's seat. Always follow the information regarding child safety provided in ⇒ *page 165, Child Safety.*

#### WARNING

Refer to ⇒ *page 126, Driving Safely* for important information, tips, suggestions and warnings that you should read and follow for your own safety and the safety of your passengers.

#### WARNING

Incorrect seating position of the driver and all other passengers can result in serious personal injury.

- Always keep your feet on the floor when the vehicle is in motion – never put your feet on top of the instrument panel, out of the window or on top of the seat cushion. This applies especially to the passen-

gers. If your seating position is incorrect, you increase the risk of injury in the case of sudden braking or an accident. If the airbag inflates and the seating position is incorrect, this could result in personal injury or even death.

- It is important for both the driver and front passenger to keep a distance of at least 10 inches (25 cm) between themselves and the steering wheel and/or instrument panel. If you're sitting any closer than this, the airbag system cannot protect you properly. In addition, the front seats and head restraints must be adjusted to your body height so that they can give you maximum protection.
- Always try to keep as much distance as possible between yourself and the steering wheel or instrument panel.
- Do not adjust the driver's or front passenger's seat while the vehicle is moving. Your seat may move unexpectedly, causing sudden loss of vehicle control and personal injury. If you adjust your seat while the vehicle is moving, you are out of position.

#### Driver's seat

*The correct seat position is important for safe and relaxed driving.*

We recommend that you adjust the driver's seat in the following manner:

- ▶ Adjust the seat in fore and aft direction so that you can easily push the pedals to the floor while keeping your knees slightly bent ⇒  in *Why is your seat adjustment so important?* on *page 60.*
- ▶ Adjust the seatback so that when you sit with your back against the seatback, you can still grasp the top of the steering wheel.
- ▶ Applies to vehicles with adjustable head restraints: Adjust the head restraint so the upper edge is as even as possible with the top of your head. If that is not possible, try to adjust the head restraint so that it is as

close to this position as possible  
⇒ page 63.

### **! WARNING**

Never place any objects in the driver's footwell. An object could get into the pedal area and interfere with pedal function. In case of sudden braking or an accident, you would not be able to brake or accelerate.

## Front passenger's seat

*Always move the front passenger seat into the rearmost position.*

To avoid contact with the airbag while it is deploying, do not sit any closer to the instrument panel than necessary and always wear the three-point safety belt provided adjusted correctly. We recommend that you adjust the passenger's seat in the following manner:

- ▶ Bring the backrest up to an (almost) upright position. **Do not** ride with the seat reclined.
- ▶ Applies to vehicles with adjustable head restraints: Adjust the head restraint so the upper edge is as even as possible with the top of your head. If that is not possible, try to adjust the head restraint so that it is as close to this position as possible  
⇒ page 63.
- ▶ Place your feet on the floor in front of the passenger's seat.

## Front seats

### Manual seat adjustment

Applies to vehicles: with manually adjustable seats

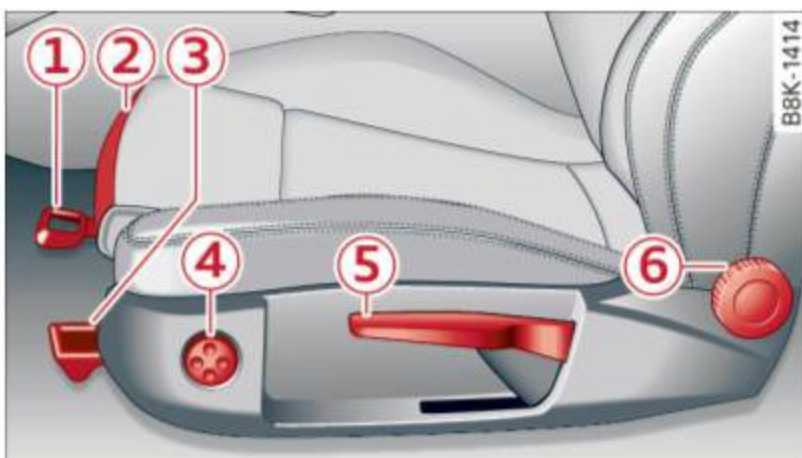

Fig. 61 Front seats: manual seat adjustment

### Controls

- ① - Moving the seat forward/back: pull the lever and slide the seat ⇒ **!.**
- ② - Lengthening/shortening the upper thigh support\*: lift the handle. A spring moves the support forward ⇒ **!.**
- ③ - Adjusting the angle\* of the seat surface: pull/press the lever ⇒ **!.**
- ④ - Adjusting the lumbar support\*: press the button in the corresponding position ⇒ **!.**
- ⑤ - Moving the seat up/down: pull/press the lever ⇒ **!.**
- ⑥ - Adjusting the backrest angle: turn the adjusting wheel ⇒ **!.**

### **! WARNING**

- Never adjust the driver's or front passenger's seat while the vehicle is moving. If you do this while the vehicle is moving, you will be out of position. Always adjust the driver's or front passenger's seat when the vehicle is not moving.
- Be careful when adjusting the seat height. Check to see that no one is in the way, or serious injury could result!
- To reduce the risk of injury in the case of sudden braking or accident, front passengers must never ride in a moving vehicle with the backrest reclined. Safety belts and the airbag system only offer maximum protection when the backrest is upright and the safety belts are properly positioned on the body. The more the backrest is reclined, the greater the risk of personal injury from an incorrect seating position and improperly positioned safety belts.

### Power seat adjustment

Applies to vehicles: with power adjustable seats

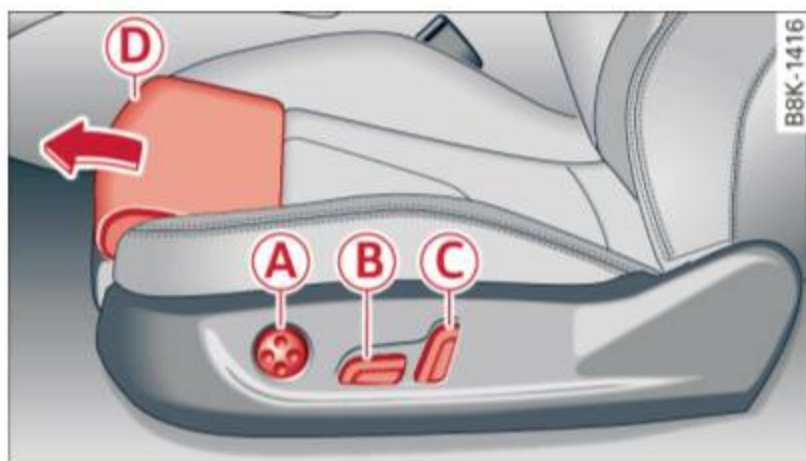

Fig. 62 Front seats: power seat adjustment

### Controls

- Ⓐ - Adjusting the lumbar support\*: press the button in the corresponding position ⇒ ⚠.
- Ⓑ - Moving the seat up/down: press the button up/down ⇒ ⚠.
- Ⓑ - Moving the seat forward/back: press the button forward/back ⇒ ⚠.
- Ⓒ - Adjusting the backrest angle: press the button forward/back ⇒ ⚠.
- Ⓒ - Raising/lowering\* the head restraints: press the button up/down ⇒ ⚠.
- Ⓓ - Lengthening/shortening the upper thigh support\*: lift the handle. A spring moves the front seat cushion forward ⇒ ⚠.

### ⚠ WARNING

- Never adjust the driver's or front passenger's seat while the vehicle is moving. If you do this while the vehicle is moving, you will be out of position. Always adjust the driver's or front passenger's seat when the vehicle is not moving.
- Be careful when adjusting the seat height. Check to see that no one is in the way, or serious injury could result!
- Because the seats can be electrically adjusted with the ignition off or with the ignition key removed, never leave children unattended in the vehicle. Unsupervised use of the electric seat adjustments may cause serious injury.

- To reduce the risk of injury in the case of sudden braking or accident, front passengers must never ride in a moving vehicle with the backrest reclined. Safety belts and the airbag system only offer maximum protection when the backrest is upright and the safety belts are properly positioned on the body. The more the backrest is reclined, the greater the risk of personal injury from an incorrect seating position and improperly positioned safety belts.

### Center armrest

The center armrest can be adjusted to several levels.

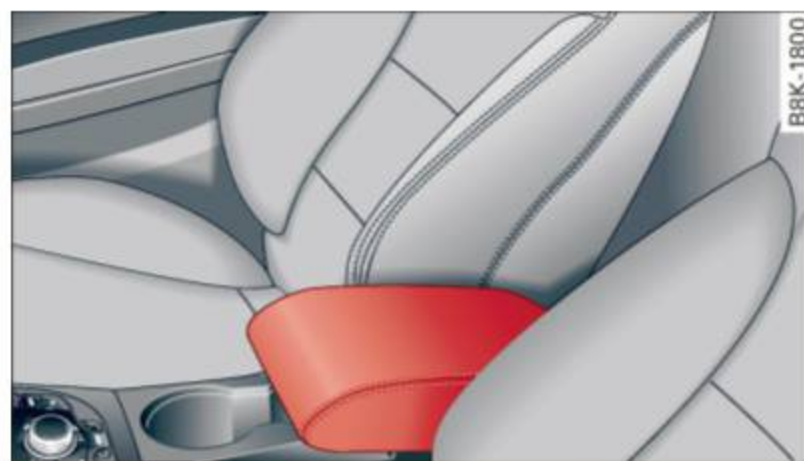

Fig. 63 Armrest between the driver's/front passenger's seats.

### Adjusting the center armrest

- ▶ To adjust the angle, raise the armrest from the starting position ⇒ fig. 63 detent by detent.
- ▶ To bring the armrest back into the starting position, raise it out of the top detent and fold it back down.

The armrest can slide forward and back.

## Head restraints

### Front head restraints

Applies to vehicles: with adjustable head restraints

Head restraints that are adjusted according to body size, along with the seat belt, offer effective protection.

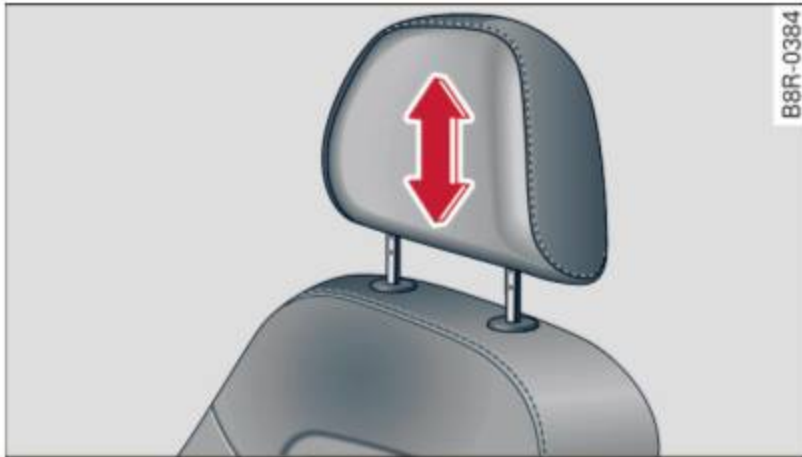

Fig. 64 Front seat: adjusting the head restraints

Adjust the head restraint so the upper edge is as even as possible with the top of your head. If that is not possible, try to adjust the head restraint so that it is as close to this position as possible ⇒ *page 63*.

- ▶ To adjust the height of the head restraint, grip the head restraint on the sides with both hands and slide it up/down until it locks into place ⇒ *fig. 64*.

Refer to ⇒ *page 130, Proper adjustment of head restraints* for guidelines on how to adjust the height of the front head restraints to suit the occupant's body size.

### WARNING

- Driving without head restraints or with head restraints that are not properly adjusted increases the risk of serious or fatal neck injury dramatically.
- Read and heed all WARNINGS ⇒ *page 130, Proper adjustment of head restraints*.

### Tips

Correctly adjusted head restraints and safety belts are an extremely effective combination of safety features.

### Rear head restraints

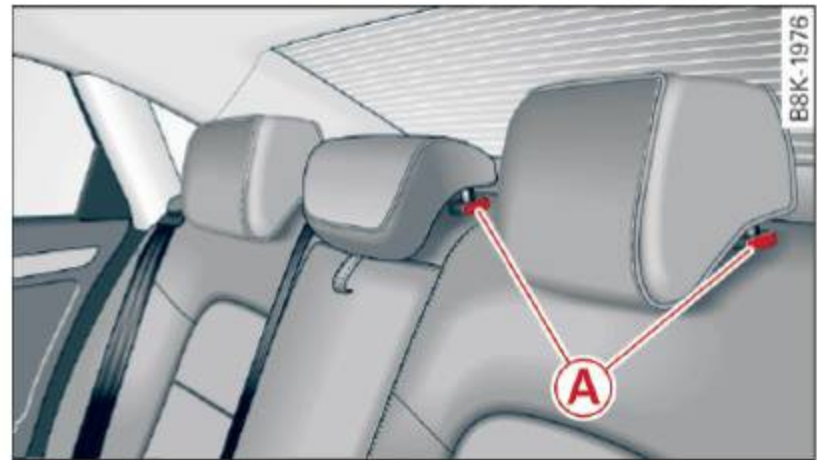

Fig. 65 Rear seat: head restraints

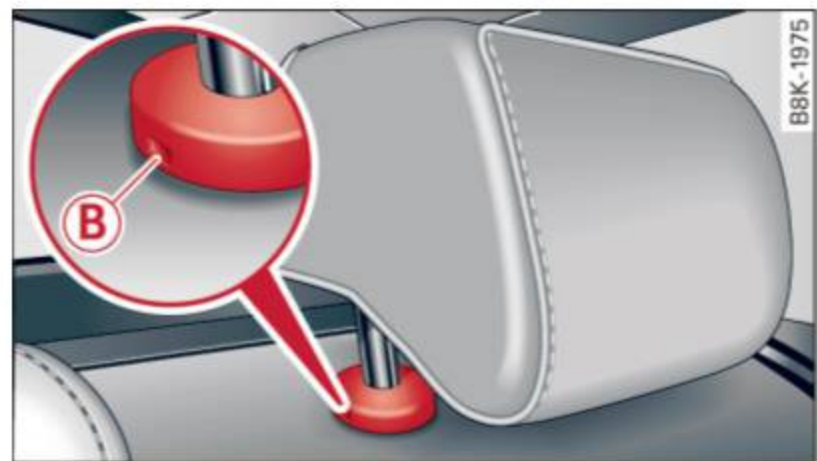





Fig. 66 Rear head restraints: release

If there is a passenger in the rear center seating position, slide the center head restraint upward at least to the next notch ⇒ .

### Adjusting the head restraints

- ▶ To move the head restraint up, hold it at the sides with both hands and slide it upward until you feel it click into place ⇒ .
- ▶ To move the head restraint down, press the button  ⇒ *fig. 65* and slide the head restraint downward.

### Removing the head restraints<sup>1)</sup>

- ▶ Fold the backrest forward ⇒ *page 71*.
- ▶ Move the head restraint upward as far as it can go.
- ▶ Press the release  ⇒ *fig. 66* with the mechanical key ⇒ *page 33* and the button  ▶

<sup>1)</sup> The head restraints cannot be removed from rear seats with fixed backrests.

⇒ *fig. 65*. Pull the head restraint out of the backrest at the same time ⇒ .

### Installing the head restraints

- ▶ Slide the posts on the head restraint down into the guides until you feel the posts click into place.
- ▶ Press the button  ⇒ *fig. 65* and slide the head restraint all the way down. You should not be able to pull the head restraint out of the backrest.

So that the driver can have a better view to the rear, the head restraints should be pushed down completely when the rear seats are not occupied.

#### **WARNING**

- Read and heed all WARNINGS ⇒ *page 130, Proper adjustment of head restraints*.
- Only remove the rear seat head restraints when necessary in order to install a child seat ⇒ *page 173*. Install the head restraint again immediately once the child seat is removed. Driving without head restraints or with head restraints that are not properly adjusted increases the risk of serious or fatal neck injury dramatically.

#### **Tips**

Correctly adjusted head restraints and safety belts are an extremely effective combination of safety features.

## Seat memory

### Description

Applies to vehicles: with memory function

The memory function allows you to quickly and easily store and recall personal seating profiles for the driver. The memory function is operated through the master key and the memory buttons in the driver's door.

The driver's seating profile is stored and assigned to the master key each time the vehicle is locked. When you open the door, the seat

profile is automatically recalled. If two people use one vehicle, it is recommended that each person always uses "their own" master key.



Up to 2 seat profiles can be stored in the memory buttons in the driver's door. Once they are stored, these seat profiles can be selected at any time.

In addition to the driver's seat settings, you can also store and access the exterior mirror adjustment settings\* using the remote control key or memory button.

### Remote control key

Applies to vehicles: with seat memory

To assign the driver's seat settings to the remote control key when locking the vehicle, the function must be activated in the radio or MMI\*

- ▶ Select:  function button > **Seat adjustment** > **Driver's seat** > **Remote control key** > **on**. Or
- ▶ Select:  function button > **Car systems\*** control button > **Vehicle settings** > **Seats** > **Driver's seat** > **Remote control key** > **On**.

#### **Tips**

If you do not want another driver's settings to be assigned to the remote key, switch off the memory function using the radio or MMI\* or the  button ⇒ *page 64*.

### Memory buttons

Applies to vehicles: with seat memory



**Fig. 67** Driver's door: memory function buttons

The memory buttons are located in the driver's door.

### Switching the memory function on/off

- ▶ Press the **OFF** button to switch the memory function on/off. The word **OFF** lights up when the memory function is switched off. Seat profiles are neither stored nor recalled.

### Storing a seat profile

- ▶ Press the **SET** button. When the word **SET** lights up, the memory is ready to store settings.
- ▶ Press a memory button (**1** or **2**) briefly. A tone confirms that the settings were stored.

### Accessing a seat profile

- ▶ If the driver's door is open and the ignition is switched off, press the memory button.
- ▶ If the driver's door is closed or the ignition is switched on, press and hold the memory button until the seat adjustment is complete.

#### WARNING

- For safety reasons, the seat setting can only be recalled when the vehicle is stationary - otherwise you risk having an accident.
- In an emergency the recall procedure can be cancelled by pressing the **OFF** switch or by tapping the memory buttons.

## Ashtray



Fig. 68 Center console: ashtray

### Opening/closing

- ▶ To open the ashtray, slide the cover up ⇒ *fig. 68*.
- ▶ To close the ashtray, press down on the cover.

### Emptying the ashtray

- ▶ To remove the insert, slide the latch to the right ⇒ *fig. 68* -arrow-.
- ▶ To install the insert, press it down into the mount.

#### WARNING

Never put waste paper in the ashtray. Hot ashes or other hot objects in the ashtray could set waste paper on fire.

## Cigarette lighter



Fig. 69 Front center console: cigarette lighter

- ▶ Press the cigarette lighter in.
- ▶ Remove the cigarette lighter when it pops out.

The cigarette lighter should only be used as a power source for the compressor from the inflatable spare kit\* when absolutely necessary.

#### WARNING

The cigarette lighter only works when the ignition is switched on. Incorrect usage can lead to serious injuries or burns. For this reason, children should never be left unattended in the vehicle because this increases the risk of injury.

## 12-volt socket

Applies to vehicles: with 12-volt socket

Electrical accessories can be connected to the 12-volt socket.



Fig. 70 allroad Luggage compartment side trim: socket



Fig. 71 Center console: socket

- ▶ Open the socket cover ⇒ *fig. 71*.
- ▶ Insert the plug of the electrical device into the socket.

The 12-volt socket can be used for electrical accessories. The power input must not exceed 120 watts.

There is an additional 12-volt socket in the center console.

Before you purchase any accessories, always read and follow the information in ⇒ *page 285, Additional accessories and parts replacement*.

### WARNING

The socket and the electrical accessories connected to it operate only when the ignition is switched on. Incorrect usage can lead to serious injuries or burns. For this reason, children should never be left unat-

tended in the vehicle because this increases the risk of injury.

### Note

- Never connect equipment that generates electrical current, such as a solar panel or battery charger, to the 12-volt socket. This could damage the vehicle's electrical system.
- To avoid damaging the socket, only use plugs that fit properly.

### Tips

When the engine is off and accessories are still plugged in and are on, the vehicle battery can still be drained.

## Storage

### General overview

### WARNING

- Always remove objects from the instrument panel. Any items not put away could slide around inside the vehicle while driving or when accelerating or when applying the brakes or when driving around a corner.
- When you are driving make sure that anything you may have placed in the center console or other storage locations cannot fall out into the footwells. In case of sudden braking you would not be able to brake, depress the clutch or accelerate.
- Any pieces of clothing that you have hung up must not interfere with the driver's view. The coat hooks are designed only for lightweight clothing. Never hang any clothing with hard, pointed or heavy objects in the pockets on the coat hooks. During sudden braking or in an accident - especially if the airbag is deployed - these objects could injure any passengers inside the vehicle.

## Cupholder

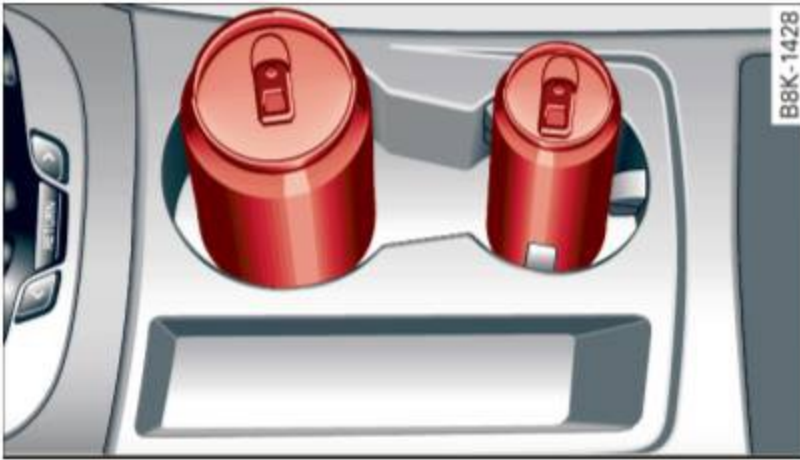

Fig. 72 Center console: front cupholder

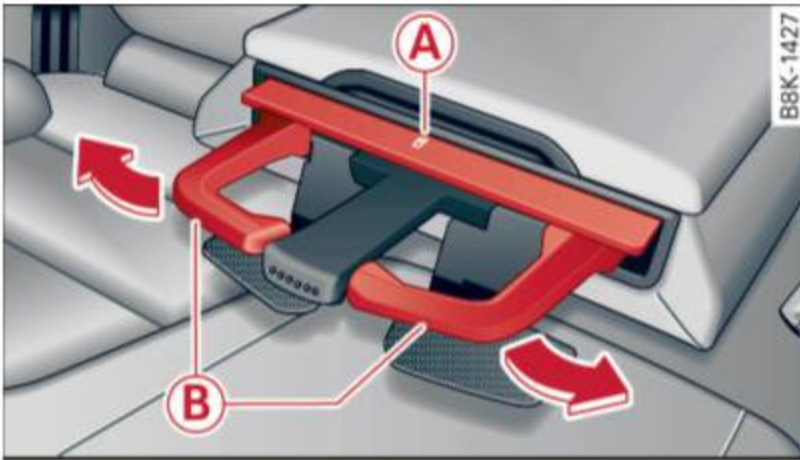



Fig. 73 Rear armrest: rear cupholder

### Opening rear cupholders

- ▶ To open the cupholder, press on the symbol  ⇒ fig. 73.
- ▶ To adjust the arm , swing it in the direction of the arrow.
- ▶ Place the beverage in the holder and release the arm. The arm swings back by itself and automatically secures the beverage.

### Closing cupholders

- ▶ To close the cupholder, press on the center section between the two arms and push the cupholder in the slot as far as it will go.

### WARNING

Spilled hot liquid can cause an accident and personal injury.

- Never carry any beverage containers with hot liquids, such as hot coffee or hot tea, in the vehicle while it is moving. In case of an accident, sudden braking or other vehicle movement, hot liquid could spill, causing scalding burns. Spilled hot liquid can also cause an accident and personal injury.

- Use only soft cups in the cupholder. Hard cups and glasses can cause injury in an accident.
- Never use the cupholder or adapter as an ashtray - risk of fire.

### Note

Only drink containers with lids should be carried in the cupholder. Liquid could spill out and damage your vehicle's electronic equipment or stain the upholstery, etc.

## Glove compartment

The glove compartment is illuminated and can be locked.



Fig. 74 Glove compartment

- ▶ To open the glove compartment, pull the handle in the direction of the arrow ⇒ fig. 74 and swing the cover down to open.
- ▶ To close the glove compartment, push the glove compartment lid upward until the lock engages.

The glove compartment can be locked using the mechanical key ⇒ page 33.

On the right side in the glove compartment is a holder with the key body into which the emergency key must be clipped to be able to start the vehicle.

### WARNING

To reduce the risk of personal injury in an accident or sudden stop, always keep the glove compartment closed while driving.

### Additional storage

There are a variety of storage compartments and fasteners in various places in the vehicle.

- In the roof headliner above the rearview mirror.
- On the back of the front seat. The compartment can hold a maximum weight of 1 kg.
- On the left and right of the luggage compartment, behind the side trim.
- Garment hooks on the pillars in the rear of the vehicle.

#### **WARNING**

- When driving, do not leave any hard objects on the rear window shelf or allow your pet to sit on the shelf. They could become a hazard for vehicle occupants in the event of sudden braking or a crash.
- Always remove objects from the instrument panel. Any items not stored could slide around inside the vehicle while driving or when accelerating or when applying the brakes or when driving around a corner.
- When you are driving make sure that anything you may have placed in the center console or other storage locations cannot fall out into the footwells. In case of sudden braking you would not be able to brake or accelerate.
- Any articles of clothing that you have hung up must not interfere with the driver's view. The coat hooks are designed only for lightweight clothing. Never hang any clothing with hard, pointed or heavy objects in the pockets on the coat hooks. During sudden braking or in an accident - especially if the airbag is deployed - these objects could injure any passengers inside the vehicle.
- To reduce the risk of personal injury in an accident or sudden stop, always keep the glove compartment closed while driving.
- Read and follow all WARNINGS  
⇒ *page 161, Important safety instructions on the side airbag system.*

- Hang clothes in such a way that they do not impair the driver's vision.
- The coat hooks must only be used for lightweight clothing. Do not leave any heavy or sharp edged objects in the pockets which may interfere with the side curtain airbag deployment and can cause personal injury in a crash.
- Do not use coat hangers for hanging clothing on the coat hooks as this can interfere with proper deployment of the side curtain airbags in an accident.
- Do not hang heavy objects on the coat hooks, as they could cause personal injury in a sudden stop.
- Always keep the compartment above the rearview mirror closed while driving to reduce the risk of injury in the event of sudden braking maneuvers or a collision.

#### **Note**

Objects located on the rear shelf that rub against the rear window could damage the heating wires for the rear window defogger.

#### **Tips**

- A vent slot is located between the shelf and the rear window. Do not block the vent with any items you may place on the rear window shelf.
- Do not place bulky items on the rear window shelf as they could restrict or block the driver's vision in the rear view mirror.

## Roof rack

### Description and mounting locations

Additional cargo can be carried with a roof luggage rack.

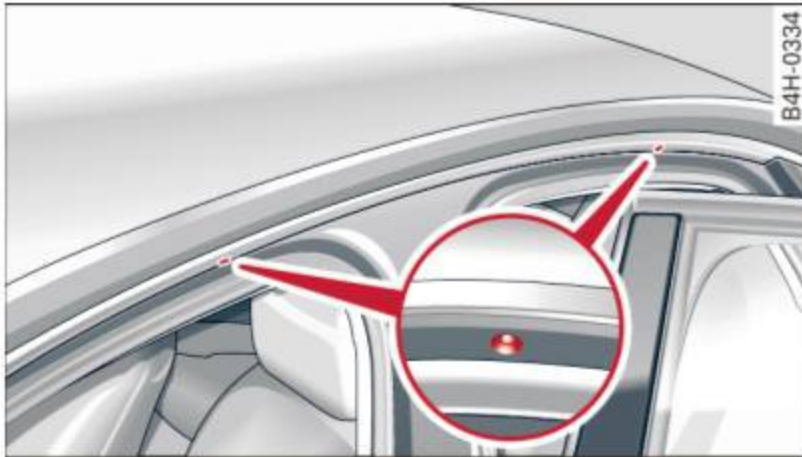

Fig. 75 Sedan: Roof rack attachment points

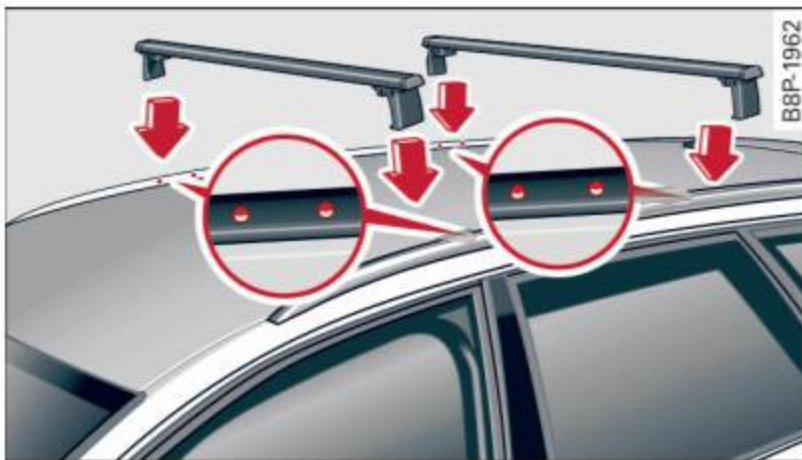

Fig. 76 allroad: Roof rack attachment points

- ▶ Always read and follow the instructions provided by the roof rack manufacturer when installing the roof rack system.

If luggage or cargo is to be carried on the roof, you must observe the following:

- Only use roof racks approved for your vehicle. These approved roof racks are the basis for a complete roof rack system. Additional attachments or carrier systems are needed to transport luggage and sports equipment. We recommend using roof racks from the Audi original accessories program.
- When installing the roof rack, make sure it is only mounted on the designated locations on the roof ⇒ *fig. 75* or ⇒ *fig. 76*.
- We recommend that you keep the installation instructions for your roof rack system together with your Owner's literature in the vehicle.

### When should the roof rack be removed?

- Before going through an automatic car wash (it is best to ask the car wash operator for advice).
- When not in use, to reduce fuel consumption, wind noise and to guard against theft.

#### WARNING

- Use of an unapproved roof rack or incorrect mounting of an approved roof rack can cause the roof rack or the items attached to it to fall off the roof onto the road.
- Objects falling from the roof of a vehicle can cause a crash and personal injury.
- Only mount the roof rack on the designated locations on the roof ⇒ *fig. 75*.
- The roof rack system must be installed exactly according to the instructions provided.
- When driving with a roof rack system, changes to the center of gravity and wind resistance can change the vehicle handling and lead to a collision. Always adapt your driving and your speed to the current conditions.

#### Note

- Your vehicle warranty does not cover any damages to the vehicle caused by using roof racks or mounting structures not approved by Audi for your vehicle. The same applies to damage resulting from incorrect roof rack installation.
- Always check the roof rack mountings and hardware before each trip and during a trip to make sure everything is securely tightened. If necessary, retighten the mountings and check the entire system from time to time.
- After mounting a roof rack system, or when you transport objects on the roof of your vehicle, the height of the vehicle is naturally increased. Be careful when driving under low bridges or in parking garages for example. This could cause

damage to the load and even the vehicle itself.

- Make sure that the open rear lid and the sunroof do not come into contact with objects on the roof.

### Loading the roof rack

*Always distribute loads evenly. Make sure anything on the roof rack is securely tied down.*

- ▶ Always distribute the loads on the roof rack evenly.
- ▶ Always attach items to the roof rack securely before you drive off.

The maximum permissible roof weight is **200 lb (90 kg)**. The roof weight is the total of the weight of the roof rack, the attachments and the cargo you are carrying. You must also not exceed the maximum load weight for the roof rack you are using.

When using a roof rack system which has a lower load carrying capacity, you must not use up the total maximum permissible load carrying capacity specified above. Instead, you should load the roof rack system only to the maximum capacity specified by the manufacturer of the roof rack system.

#### **WARNING**

Weak, damaged or improper straps used to secure items to the roof rack can fail during hard braking or in a collision and cause serious personal injury.

- Make sure the roof rack is installed exactly as specified above ⇒ *page 69*.
- Always use suitable mounting straps for securing items to the roof rack to help prevent items from shifting or flying forward.
- Items on the roof rack must always be securely mounted.
- The use of a roof rack can negatively affect the way a vehicle handles. Cargo that is large, heavy, bulky, long or flat will have a greater negative influence on

the vehicle's aerodynamics, center of gravity and overall handling. Always drive slowly, avoid sudden braking and maneuvers when transporting cargo on the roof of your vehicle.

- Never exceed the maximum permissible load carrying capacity of the roof of your vehicle, the permissible axle weights and the permissible total weight of your vehicle ⇒ *page 280, Weights*.

#### **Note**

Make sure that the opened rear lid does not come in contact with the cargo on the roof.

#### **For the sake of the environment**

As a result of the increased wind resistance created by a roof rack, your vehicle is using fuel unnecessarily. So remove the roof rack after using it.

## Luggage compartment

### General information

#### **WARNING**

Read and follow the important safety precautions on ⇒ *page 132, Stowing luggage*.

## Luggage compartment cover

Applies to vehicles: with luggage compartment cover

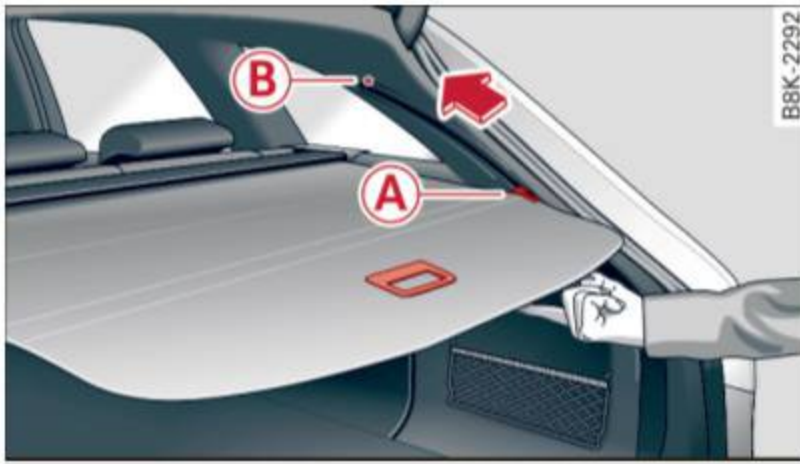

Fig. 77 Luggage compartment: cover hanging in position (A)

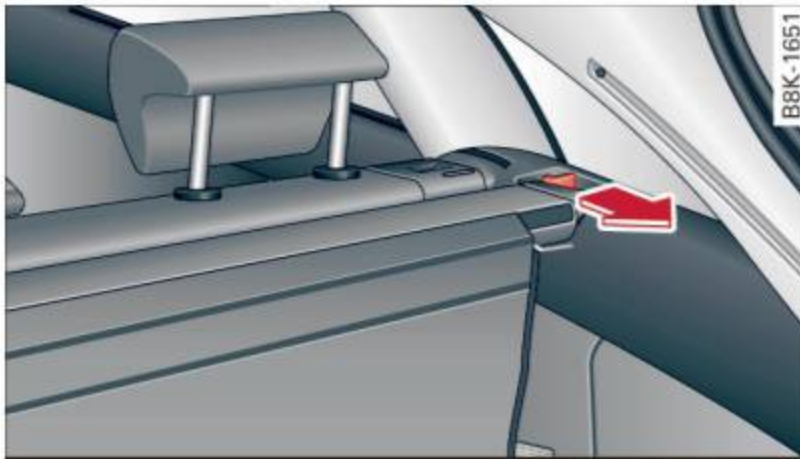

Fig. 78 Right front section of the luggage compartment: removing the luggage compartment cover

The luggage compartment cover can be hung in position (A) or in the comfort position (B) ⇒ fig. 77.

### Extending/Retracting

You can only extend and retract the cover in the (A) position.

- ▶ Pull the cover out and attach it in position (A) in the mounting eyelets in the side trim.

### Comfort position

In position (B), the cover does not need to be removed to unload the luggage compartment.

- ▶ To move to position (B), tilt the end of the cover upward from the bottom when the cover is extended. It will then move into position (B) by itself ⇒ fig. 77.

### Removing

- ▶ Pull the lever in the direction of the arrow ⇒ fig. 78 while lifting the cover out.

## Installing

- ▶ Place the left side of the cover in the mount on the side trim.
- ▶ Press the cover down into the right mount until it locks into place.

### ! WARNING

Whenever driving, never place any hard or heavy objects on the luggage compartment or allow pets to sit on the luggage compartment cover. They could become a hazard to vehicle occupants in the event of sudden braking or in an accident.

### ! Note

Let the luggage compartment cover roll up slowly to avoid damage.

## Enlarging the luggage compartment

Applies to vehicles: with folding rear seatback

*The rear seat backrests can be folded forward either separately or together.*

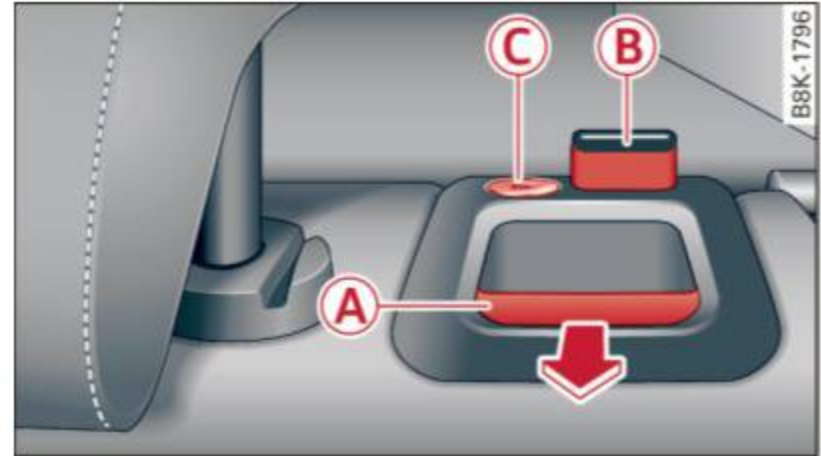

Fig. 79 Backrest: release lever, securing knob and latch\*

### Folding the backrest forward

- ▶ Pull the release lever (A) ⇒ fig. 79 in the direction of the arrow and fold the backrest forward.

### Folding the backrest back into the upright position

- ▶ Fold the backrest back up again until it latches and the red marking (B) is no longer visible ⇒ !.

Sedan: You can lock the backrest when it is latched in place using the mechanical key ▶

⇒ page 33 © ⇒ fig. 79. This prevents any access to the luggage compartment from the vehicle interior.

You can only enlarge the luggage compartment if the backrest is not locked.

### WARNING

- The backrest must always be securely latched so that the safety belt of the center seating position can work properly to help protect the occupant.
- The backrest must be securely latched in position so that no items contained in the luggage compartment can slide forward upon sudden braking.
- Always check whether the latch is fully engaged by pulling the seatback forward.
- Never allow safety belts to become damaged by being caught in door or seat hardware.
- Torn or frayed safety belts can tear and damaged belt hardware can break in a crash. Inspect the belts periodically. Belts showing damage to webbing, bindings, buckles, or retractors must be replaced.

### Note

- If you move the front seat back when the rear seat backrest is folded forward, you could damage the head restraints on the rear seat.
- Slide the belt guide on the outside safety belt all the way up before folding the backrest back forward. Make sure the seat belt is not pinched or damaged when the rear seat backrest is folded back. Other objects should be removed from the rear seat bench to protect the seatback from damage.

### Partition net (seatback in upright position)

Applies to vehicles: with partition net

The partition net is designed to prevent loose objects from flying forward into the passenger compartment (e.g. under sudden braking).

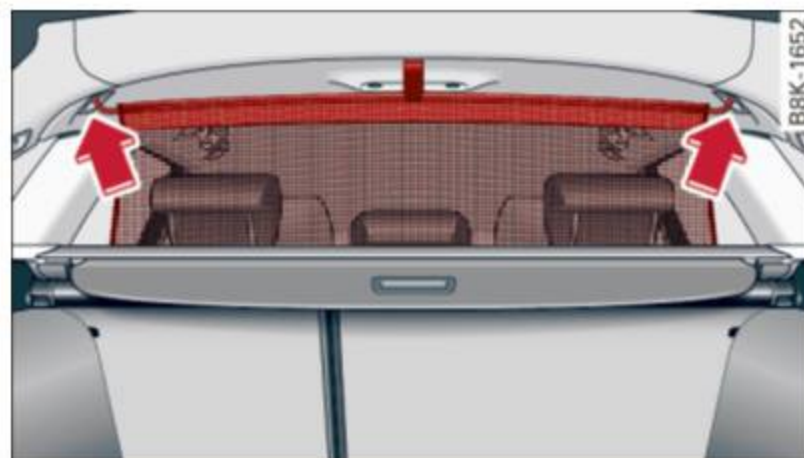

Fig. 80 Behind the backrest: hanging the partition net



Fig. 81 Behind the backrest: removing the partition net

### Hanging

- ▶ Pull the net upward. Hang the crossbar in the rear eyelets **over the rear bench seat** ⇒ fig. 80 -arrow-.

### Removing

- ▶ Tilt the seatback forward.
- ▶ Press the left and right release knobs ⇒ fig. 81 -arrow- and pull the net upward and out.

### Installing

- ▶ Tilt the seatback forward ⇒ page 71.
- ▶ Move the partition net left and right in the retaining clamp.
- ▶ Press the partition net down diagonally at the left and right until it locks into place and the red markings on the buttons are no longer visible.

**! Note**

Let the partition net roll up slowly to prevent damage.

**Partition net (seatback tilted forward)**

Applies to vehicles: with partition net

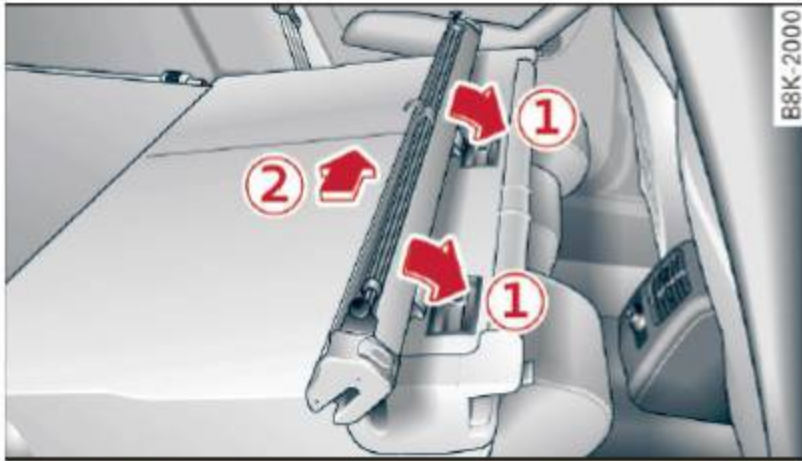

Fig. 82 Folded backrest: installing the partition net

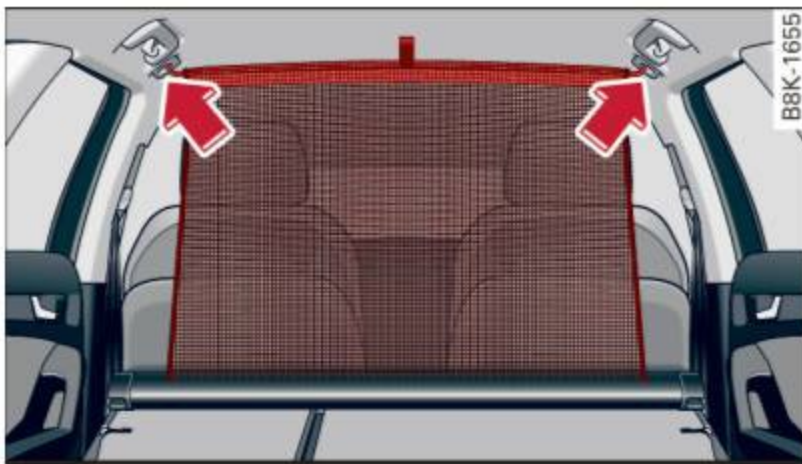

Fig. 83 Folded backrest: hanging the partition net

**Installing**

- ▶ Tilt the seatback forward ⇒ page 71.
- ▶ Affix the partition net to the recesses on the retaining rails ① ⇒ fig. 82 and slide it towards the left side of the vehicle until it latches ②.

**Hanging**

- ▶ Pull the net upward and hang the crossbar in the front eyelets **over the front seats** ⇒ fig. 83 -arrow-.

**Removing**

- ▶ Slide the partition net to the right and lift it out of the retaining rails ⇒ fig. 82.

**! Note**

– You must remove the partition net before folding the backrest back into the upright position.

– Let the partition net roll up slowly to prevent damage.

**Cargo net**

Applies to vehicles: with cargo net

*The cargo net prevents small objects from sliding.*

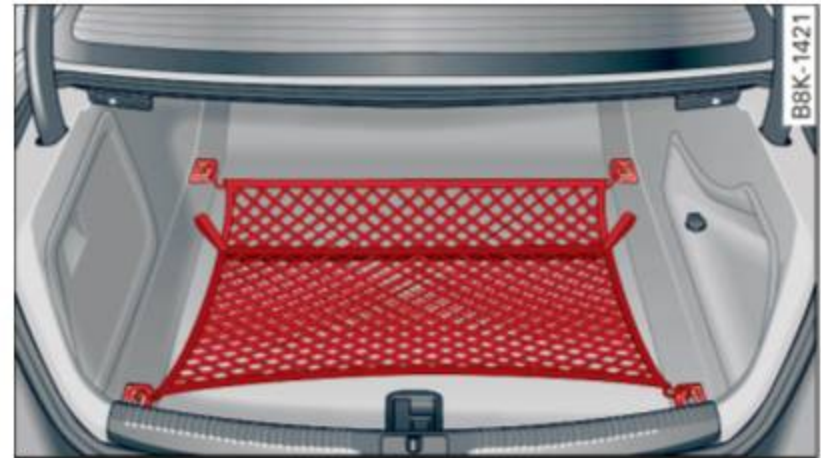

Fig. 84 Luggage compartment: cargo net stretched out



Fig. 85 Luggage compartment: cargo net at the top of the luggage compartment

**Net stretched out**

- ▶ First hang the first hooks in the mounting eyelets and then hang the rear hooks ⇒ fig. 84.

**Net at the top of the luggage compartment**

- ▶ Hang the hooks on the cargo net in the tie-downs on the floor at the rear of the luggage compartment ⇒ fig. 85.
- ▶ Fold down the bag hooks at the upper area of the luggage compartment down, pull the net up and hang the eyelets on the net on the hooks.

You can also use the hooks ⇒ fig. 85 to hang light purses, bags, etc.

If nothing is hung on the hooks, they will fold back in by themselves.

In a collision, the laws of physics mean that even smaller items that are loose in the vehicle will turn into heavy missiles that can cause serious injury. Items in the vehicle pick up kinetic energy which varies with the vehicle and the weight of the item. Vehicle speed is the most significant factor.

For example, in a frontal collision at a speed of 30 mph (48 km/h), the forces acting on a 10-lb (5 kg) object are about *20 times* the normal weight of the item. This means that the weight of the item would suddenly be the equivalent of about 200 lbs (90 kg). One can easily imagine the injuries that an item of that weight flying freely through the passenger compartment can cause in a collision at a speed considered relatively low.

### **WARNING**

Weak, damaged or improper straps used to secure items to tie-downs can fail during hard braking or in a collision and cause serious personal injury.

- Always use suitable retaining straps and properly secure items to the tie-downs in the luggage compartment to help prevent items from shifting or flying forward.
- Never attach a child seat tether strap to a tie-down.
- For strength-related reasons, the mounting hooks can only be used to secure objects weighing up to 10 lb. (5 kg). Heavier objects will not be adequately secured – there is a risk of injury.

## **Tie-downs**

Applies to vehicles: with tie-downs

*Four tie-downs for securing luggage pieces and two for hanging bags, sacks, etc. are located in the luggage compartment.*

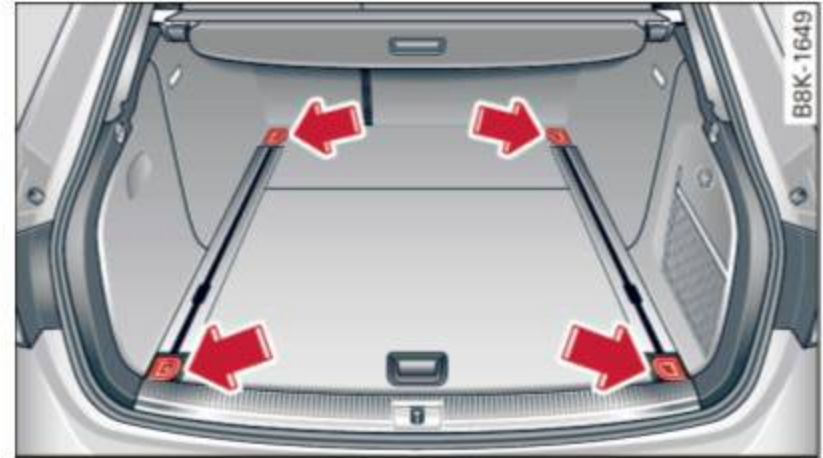

**Fig. 86** Luggage compartment: tie-downs

- ▶ Secure objects using elastic cords attached to the tie-downs\* ⇒ *fig. 86*.
- ▶ Read and heed all WARNINGS ⇒ *page 132, Stowing luggage*.

## **Bag hooks**

Applies to vehicles: with bag hooks

*Light objects can be secured on the hooks.*



**Fig. 87** Right side of the luggage compartment: bag hooks

You can also use the hooks to hang light purses, bags, etc.

### **WARNING**

The hooks can hold a maximum weight of 3 kg. Heavier objects are not adequately secured. There is risk of personal injury.

### Luggage compartment covering (reversible mat)

Applies to vehicles: with luggage compartment covering

The reversible mat protects the luggage compartment and bumper from dirt and scratches.



Fig. 88 Luggage compartment: reversible mat with backrest folded forward

You can use the reversible mat with the dirt-resistant side or the decorative side. After loading or unloading, fold up the reversible mat and close the luggage compartment lid. Only store the reversible mat if it is dry.

### Securing attachments

Applies to vehicles: with securing attachments

The securing attachments prevent objects in the luggage compartment from sliding back and forth.

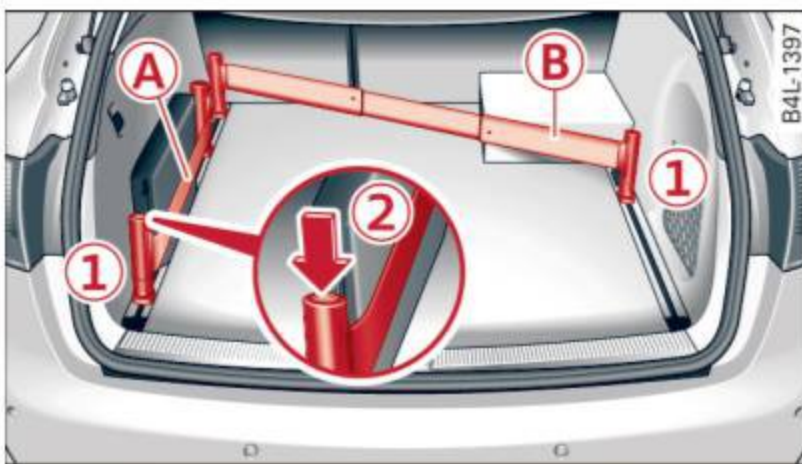

Fig. 89 Luggage compartment: securing attachments

Make sure the backrests are folded upright and the partition net is installed ⇒ ⚠.

### Installing securing strap (A)

- ▶ Set the holder for the securing strap in the opening of the track system.
- ▶ Push the holder down (1) and slide it into the desired position.

- ▶ Check that the holder has latched into place.
- ▶ Push the knob on the front side of the holder (2) to tighten the strap.

### Installing telescoping rod (B)

- ▶ Insert both brackets for the telescoping rods into the openings in the rails.
- ▶ Push the holder down (1) and slide it into the desired position.
- ▶ Check that the holder has latched into place.

The securing strap can also be attached as needed on the right side of the track system instead of the telescoping track ⇒ fig. 89.

### ⚠ WARNING

- The backrest must be securely latched in position so that no items contained in the luggage compartment can slide forward upon sudden braking.
- Loose items inside the passenger compartment, can fly forward in a crash or sudden maneuver and injure occupants.

### Ski sack

Applies to vehicles: with ski sack

Long objects such as skis or snowboards can be transported in the ski sack.



Fig. 90 Backrest: pass-through cover

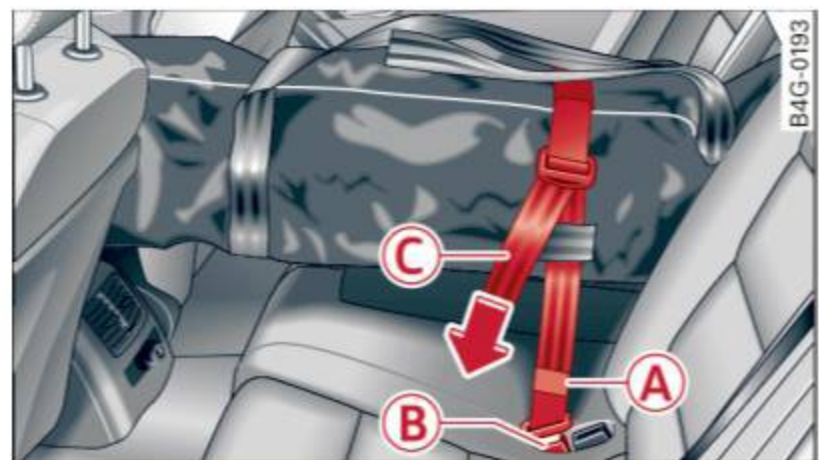





Fig. 91 Rear bench seat: securing the ski sack

## Loading

- ▶ Fold the rear seat center armrest down.
- ▶ Fold the pass-through cover  
⇒ *fig. 90 -arrow-* down.
- ▶ Slide the ski sack from the luggage compartment through the pass-through with the zipper at the rear ⇒ .

## Securing

- ▶ Insert the ski sack strap  ⇒ *fig. 91* in the center buckle .
- ▶ Pull the safety belt taut on the free end of the belt .

### WARNING

- The ski sack is intended only for the transportation of skis and other light objects. To reduce the risk of serious personal injury, never transport heavy or pointed objects in the ski sack.
- When braking rapidly or during an accident, the load could be displaced and cause injury to occupants.
- Sharp edges on the load must be covered for protection. Always fasten the belt tightly around the sack and its contents ⇒ *fig. 91*.
- For safety reasons, do not transport more than two pairs of skis in the ski sack.
- You must secure the ski sack with the strap after loading.
- Make sure that all objects you are transporting in the pass-through are secured. Otherwise they could slide around during sudden braking maneuvers and cause injuries.

### Tips

- Never stow the ski sack away when it is still wet or damp (for example, snow melting from skis). Allow it to dry completely before stowing it away.
- When transporting skis or snowboards, tighten the securing strap between the bindings.

- Position skis in the ski sack with the pointed ends facing the front and ski poles with the pointed ends facing the rear.
- Sedan: You can lock or unlock the pass-through using the mechanical key. This prevents any access to the luggage compartment from the vehicle interior.

### Reversible cargo area floor (dirt collector)

Applies to vehicles: with reversible cargo area floor

You can transport dirty or damp objects in the reversible cargo area floor



Fig. 92 Luggage compartment: cargo area floor



Fig. 93 Luggage compartment: cargo area floor reversed

### Reversing the cargo area floor

- ▶ Lift the cargo area floor using the handle  
⇒ *fig. 92 -arrow-*.
- ▶ Flip the floor over and install it.

### Parcel shelf

The parcel shelf behind the rear seatback can be used to carry light items of clothing. ▶

 **WARNING**

No heavy or hard objects should be placed on the parcel shelf. They are a hazard to the vehicle occupants during sudden braking. There is a risk of injury.

 **Note**

Please make sure that the heating wires for the rear window defogger are not damaged by abrasive objects.

 **Tips**

To ensure problem-free ventilation, the ventilation slots between the rear window and the parcel shelf must not be covered.

## Warm and cold

### Climate controls

#### Description

The climate control system warms, cools and adds humidity to the air in the vehicle interior. It is the most effective when the windows and sunroof are closed. If there is a build-up of heat inside the vehicle, ventilation can help to speed up the cooling process.

In all heating mode functions except *defrost*, the blower only switches to a higher speed once the engine coolant has reached a certain temperature.

Condensation from the cooling system can drip and form a puddle of water under the vehicle. This is normal and does not mean there is a leak.

#### Pollutant filter

The pollutant filter removes pollutants such as dust and pollen from the air.

The air pollutants filter must be changed at the intervals specified in your Warranty & Maintenance booklet, so that the air conditioner can properly work.

If you drive your vehicle in an area with high air pollution, the filter may need to be changed more frequently than specified in your Audi Warranty & Maintenance booklet. If in doubt, ask your authorized Audi Service Advisor for advice.

#### Key coded settings

The climate control settings are automatically stored and assigned to the remote control key that is in use.

#### WARNING

Reduced visibility is dangerous and can cause accidents.

- For safe driving it is very important that all windows be free of ice, snow and condensation.
- Completely familiarize yourself with the proper use and function of the heating and ventilation system and especially how to defog and defrost the windows.
- Never use the windshield wiper/washer system in freezing weather until you have warmed the windshield first, using the heating and ventilation system. The washer solution may freeze on the windshield and reduce visibility.

#### Note

- If you suspect that the air conditioner has been damaged, switch the system off to avoid further damage and have it inspected by a qualified dealership.
- Repairs to the Audi air conditioner require special technical knowledge and special tools. Contact an authorized Audi dealer for assistance.

#### For the sake of the environment

By reducing the amount of fuel you use, you also reduce the amount of pollutants emitted into the air.

#### Tips

- Keep the air intake slots (in front of the windshield) free from ice, snow and debris in order to maintain the proper function of the climate control system.
- The energy management system may switch the seat heating\* or rear window defroster off temporarily. These systems are available again as soon as the energy balance has been restored.
- Air escapes through vents under the rear window. When placing items of clothing on the luggage compartment cover, ensure that the openings are not covered.

## Operation

We recommend pressing the **AUTO** button and setting the temperature to 72 °F (22 °C).



Fig. 94 Automatic climate control system: control



Fig. 95 3-zone deluxe automatic climate control\*: controls

Press the buttons to turn the functions on or off. Use the dials to adjust the temperature, the blower speed and the air distribution. The LED in a button will light up when the function is switched on. The settings are displayed for a few seconds in the radio or MMI\* display.

In vehicles with a 3-zone deluxe automatic climate control systems\*, the driver and front passenger side can be adjusted separately. The settings are also displayed in the climate control system display.

### **OFF** Switching the climate control system on/off

The **OFF** button switches the climate control system on or off. It also switches on when you

press the knob. Airflow from outside is blocked when the climate control system is switched off.

### **A/C** Switching cooling mode on/off

The air is not cooled and humidity is not removed when cooling mode is switched off. This can cause fog on the windows. Cooling mode switches off automatically when the outside temperature is below zero.

### **Recirculation** Switching recirculation mode on/off

In recirculation mode, the air inside the vehicle is circulated and filtered. This prevents the unfiltered air outside the vehicle from entering the vehicle interior. We recommend

switching recirculation mode on when driving through a tunnel or when sitting in traffic

⇒ .

The **AUTO** button or  **FRONT** button switches recirculation mode off.

### **Switching automatic mode on**

Automatic mode maintains a constant temperature inside the vehicle. Air temperature, airflow and air distribution are controlled automatically.

### **Adjusting the temperature**

Temperatures between 60 °F (+16 °C) and 84 °F (+28 °C) can be set. Outside of this range, **LO** or **HI** will appear in the climate control system display. At both of these settings, the climate control system runs continuously at maximum cooling or heating power. There is no temperature regulation.

### **Adjusting the airflow**

You can adjust the airflow manually to suit your needs. To have the airflow regulated automatically, press the **AUTO** button.

### **Adjusting the air distribution**

You can manually select the vents where the air will flow. To have the air distribution regulated automatically, press the **AUTO** button.

### **Adjusting seat heating\***

Pressing the button switches the seat heating on at the highest setting (level 3). The LEDs indicate the temperature level. To reduce the temperature, press the button again. To switch the seat heating off, press the button repeatedly until the LED turns off.

After 10 minutes, the seat heating automatically switches from level 3 to level 2.

### **FRONT** **Switch the defroster on/off**

The windshield and side windows are defrosted or cleared of condensation as quickly as possible. The maximum amount of air flows mainly from the vents below the windshield. Recirculation mode switches off. The tempera-

ture should be set to 72 °F (22 °C) or higher. The temperature is controlled automatically.

The **AUTO** button switches the defroster off.

### **REAR** **Switching rear window heater on/off**

The rear window heater only operates when the engine is running. It switches off automatically after a few minutes, depending on the outside temperature.

To prevent the rear window heater from switching off automatically, press and hold the  **REAR** button for more than 2 seconds. This remains stored until the ignition is switched off.

### **Air vents**

You can open and close the center and rear air vents using the thumbwheels. The levers adjust the direction of the airflow from the vents.

In vehicles with a 3-zone deluxe automatic climate control system\*, you can adjust the air temperature in the rear by turning the thumbwheel toward the red side to make it warmer or toward the blue side to make it cooler.

### **WARNING**

- Do not use the recirculation for extended periods of time. The windows could fog up since no fresh air can enter the vehicle. If the windows fog up, press the air recirculation button again immediately to switch off the air recirculation function or select defrost.
- Individuals with reduced sensitivity to pain or temperature could develop burns when using the seat heating function. To reduce the risk of injury, these individuals should not use seat heating.

### **Note**

To avoid damage to the heating elements in the seats, do not kneel on the seats or place heavy loads on a small area of the seat.

## Setup

The basic climate control settings can be adjusted in the radio or MMI\*.

- ▶ Select: **CAR** function button > **A/C** control button. Or
- ▶ Select: **CAR** function button > **Car systems\*** control button > **AC**.

### Automatic recirculation\*

When switched on, automatic recirculation controls the recirculation mode automatically. If the windows fog up, press the **FRONT** button.

### Synchronization\*

When synchronization is switched on, the same settings are applied to both the driver and front passenger, except for the seat heating/ventilation\*. Synchronization switches off when you adjust the settings on the front passenger's side.

You can also switch synchronization on by pressing and holding the knob on the driver's side.

### Supplementary heater

The supplementary heater warms the interior of vehicles with flexible fuel engines more quickly. The supplementary heater is controlled automatically in the **Auto** setting.

## On the road

### Steering

#### Manually adjustable steering wheel

The steering wheel position is fully adjustable up and down and forward and back.



Fig. 96 Lever under the steering column

First, adjust the driver's seat correctly.

- ▶ Pull the lever ⇒ *fig. 96* ⇒ ⚠.
- ▶ Move the steering wheel to the desired position.
- ▶ Push the lever against the steering column until it locks.

There must be at least 10 inches (25 cm) between your chest and the center of the steering wheel. If you cannot sit more than 10 inches (25 cm) from the steering wheel, see if adaptive equipment is available to help you reach the pedals and increase the distance from the steering wheel.

For detailed information on how to adjust the driver's seat, see ⇒ *page 62*.

#### ⚠ WARNING

Improper use of steering wheel adjustment and improper seating position can cause serious personal injury.

- Adjust the steering wheel column only when the vehicle is not moving to prevent loss of vehicle control.
- Adjust the driver's seat or steering wheel so that there is a minimum of 10 inches (25 cm) between your chest and the steering wheel ⇒ *page 127, fig. 139*. If you cannot maintain this minimum dis-

tance, the airbag system cannot protect you properly.

- If physical limitations prevent you from sitting 10 inches (25 cm) or more from the steering wheel, check with your authorized Audi dealer to see if adaptive equipment is available.
- If the steering wheel is aligned with your face, the supplemental driver's airbag cannot provide as much protection in an accident. Always make sure that the steering wheel is aligned with your chest.
- Always hold the steering wheel with your hands at the 9 o'clock and 3 o'clock positions to reduce the risk of personal injury if the driver's airbag deploys.
- Never hold the steering wheel at the 12 o'clock position or with your hands inside the steering wheel rim or on the steering wheel hub. Holding the steering wheel the wrong way can cause serious injuries to the hands, arms and head if the driver's airbag deploys.

## Ignition lock

#### Starting engine with the key

Applies to vehicles: with ignition lock

The ignition is switched on and the engine started with the ignition key.



Fig. 97 Ignition key

#### Starting the engine

- ▶ Insert the key into the ignition lock.
- ▶ *Manual transmission:* Fully depress the clutch pedal and move the shift lever to the neutral position.

- ▶ **Automatic transmission:** Step on the brake pedal and move the selector lever to the P or N position.
- ▶ Press the key ⇒ *fig. 97* - the engine will start.

### Switching the ignition on/off

If you would like to switch the ignition on without starting the engine, follow these steps:

- ▶ Insert the key into the ignition lock.
- ▶ Press the key briefly **without** pressing the clutch pedal (for manual transmissions) or the brake pedal (for automatic transmissions).
- ▶ To switch the ignition off, press the key again.

When starting the engine, major electrical loads are switched off temporarily.

You can only remove the key with the ignition switched off.

If the engine should not start immediately, the starting process is automatically stopped after a short time. Repeat starting procedure.

### WARNING

- Never allow the engine to run in confined spaces - danger of asphyxiation.
- Never remove the ignition key from the ignition lock while the vehicle is moving. Otherwise, the steering lock could suddenly engage and you would not be able to steer the vehicle.
- Always take the key with you whenever you leave your vehicle. Otherwise, the engine could be started or electrical equipment such as the power windows could be operated. This can lead to serious injury.
- Never leave children or persons requiring assistance unattended in the vehicle. The doors can be locked using the remote transmitter, preventing people from escaping from the vehicle on their own in the event of an emergency. Depending on the time of year, people inside the ve-

hicle can be exposed to very high or very low temperatures.

### Note

Avoid high engine rpm, full throttle and heavy engine loads until the engine has reached operating temperature - otherwise you risk engine damage.

### For the sake of the environment

Do not let the engine run while parked to warm up. Begin driving immediately. This reduces unnecessary emissions.

### Tips

- If the key cannot be removed from the ignition lock, you have to pull the mechanical key out of the master key in order to be able to lock the vehicle ⇒ *page 34*.
- After starting a cold engine, there may be a brief period of increased noise because the oil pressure must first build up in the hydraulic valve adjusters. This is normal and not a cause for concern.
- If you leave the vehicle with the ignition switched on, the ignition will switch off after a certain period of time. Please note that electrical equipment such as exterior lights will switch off as well when that happens.

## Starting the vehicle with the emergency key

Applies to vehicles: with ignition lock

You can use the emergency key as an ignition key in an emergency.

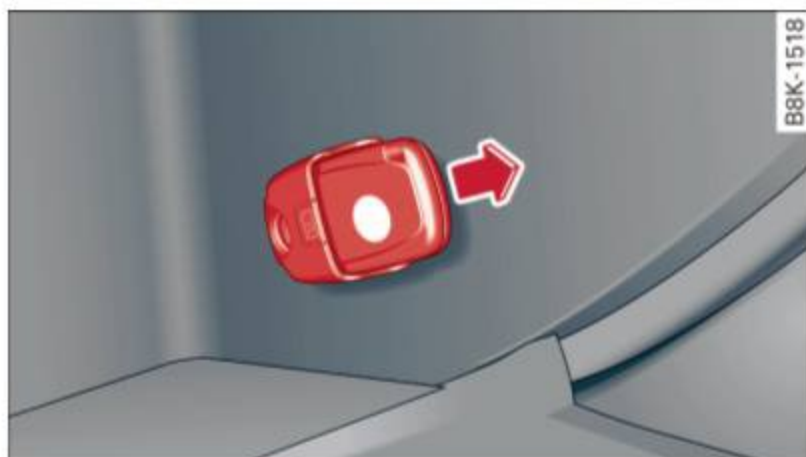

Fig. 98 Glove compartment: Adapter for emergency key

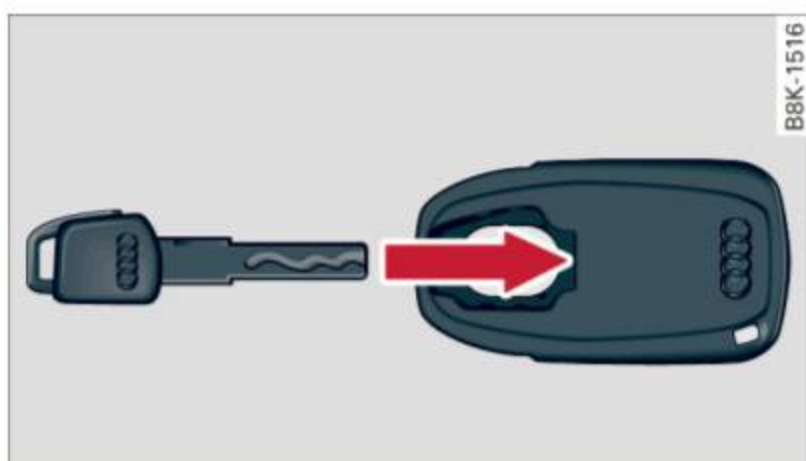

Fig. 99 Insert emergency key into the adapter

- ▶ Take the adapter for the emergency key out of the glove compartment ⇒ *fig. 98*.
- ▶ Push the emergency key ⇒ *fig. 99* fully into the adapter. Make sure that the Audi rings are facing up.
- ▶ Press the emergency key in the adapter down until it latches audibly.
- ▶ Insert the adapter with the emergency key forward into the ignition switch. The engine can now be started as usual.

## Stopping the engine

Applies to vehicles: with ignition lock

- ▶ Bring the vehicle to a full stop.
- ▶ *Automatic transmission*: Move the selector lever to the P or N position.
- ▶ Press on the ignition key. The engine is turned off.
- ▶ You can now remove the key.

## Steering lock

The steering locks when you remove the ignition key. The locked steering helps prevent vehicle theft.

## Emergency off

If it is necessary in unusual circumstances, the engine can be switched off while the vehicle is moving. The engine will be switched off if you press on the key for an extended period.

### WARNING

- Never turn off the engine before the vehicle has come to a complete stop. The full function of the brake booster and the power steering is not guaranteed. You must use more force to turn or brake if necessary. Because you cannot steer and brake as you usually would, this could lead to crashes and serious injuries.
- For safety reasons, you should always park your vehicle with the selector lever in P. Otherwise, the vehicle could inadvertently roll away.
- The radiator fan can continue to run for up to 10 minutes even after you have turned off the engine and removed the ignition key. The radiator fan can also turn on again if the engine coolant heats up because of intense sunlight or heat build-up in the engine compartment.
- Always take the key with you whenever you leave your vehicle. Otherwise, the engine could be started or electrical equipment such as the power windows could be operated. This can lead to serious injury.
- Never leave children or persons requiring assistance unattended in the vehicle. The doors can be locked using the remote transmitter, preventing people from escaping from the vehicle on their own in the event of an emergency. Depending on the time of year, people inside the vehicle can be exposed to very high or very low temperatures.

## ! Note

If the engine has been under heavy load for an extended period, heat builds up in the engine compartment after the engine is switched off - there is a risk of damaging the engine. Allow the engine to run at idle for about two minutes before switching it off.

## Convenience key

### Starting the engine

Applies to vehicles: with convenience key

The **START ENGINE STOP** button switches the ignition on and starts the engine.



Fig. 100 Center console: START ENGINE STOP button

### Starting the engine

- ▶ **Manual transmission:** Fully depress the clutch pedal and move the shift lever to the neutral position.
- ▶ **Automatic transmission:** Step on the brake pedal and move the selector lever to P or N ⇒ .
- ▶ Press on the **START ENGINE STOP** button ⇒ *fig. 100* - the engine will start.

### Switching the ignition on/off

If you would like to switch the ignition on without starting the engine, follow these steps:

- ▶ Press the **START ENGINE STOP** button **without** pressing the clutch pedal (for manual transmissions) or the brake pedal (for automatic transmissions).
- ▶ To switch the ignition off, press the button again.

If the engine should not start immediately, the starting process is automatically stopped after a short time. Repeat starting procedure.

When starting the engine, major electrical loads are switched off temporarily.

After a cold engine is started, there may be a brief period of increased noise because oil pressure must first build up in the hydraulic valve adjusters. This is normal and not a cause for concern.

## WARNING

- Never allow the engine to run in confined spaces - danger of asphyxiation.
- Never turn off the engine until the vehicle has come to a complete stop.
- Always take the key with you whenever you leave your vehicle. Otherwise, the engine could be started or electrical equipment such as the power windows could be operated. This can lead to serious injury.
- Never leave children or persons requiring assistance unattended in the vehicle. The doors can be locked using the remote transmitter, preventing people from escaping from the vehicle on their own in the event of an emergency. Depending on the time of year, people inside the vehicle can be exposed to very high or very low temperatures.

## ! Note

- Avoid high engine rpm, full throttle and heavy engine loads until the engine has reached operating temperature - otherwise you risk engine damage.

## For the sake of the environment

Do not let the engine run while parked to warm up. Begin driving immediately. This reduces unnecessary emissions.

## Tips

- After starting a cold engine, there may be a brief period of increased noise because the oil pressure must first build up

in the hydraulic valve adjusters. This is normal and not a cause for concern.

- If you leave the vehicle with the ignition switched on, the ignition will switch off after a certain period of time. Please note that electrical equipment such as exterior lights will switch off as well when that happens.

### Switching engine off

Applies to vehicles: with convenience key

- ▶ Bring your vehicle to a complete stop.
- ▶ Automatic transmission: Move the selector lever to the P or N position.
- ▶ Press the **START ENGINE STOP** button  
⇒ page 85, fig. 100.

### Steering lock

The steering locks when you turn the engine off using the **START ENGINE STOP** button and open the driver's door. The locked steering helps prevent vehicle theft.

### Emergency off

If necessary, the engine can be switched off with the selector lever in the R or D/S positions. To do so, step on the brake pedal and press and hold the **START ENGINE STOP** button. Vehicle speed must be less than 6 mph (10 km/h).

### WARNING

- Never turn off the engine before the vehicle has come to a complete stop. The full function of the brake booster and the power steering is not guaranteed. You must use more force to turn or brake if necessary. Because you cannot steer and brake as you usually would, this could lead to crashes and serious injuries.
- For safety reasons, you should always park your vehicle with the selector lever in P. Otherwise, the vehicle could inadvertently roll away.
- The radiator fan can continue to run for up to 10 minutes even after you have turned off the engine and removed the

ignition key. The radiator fan can also turn on again if the engine coolant heats up because of intense sunlight or heat build-up in the engine compartment.

- Always take the key with you whenever you leave your vehicle. Otherwise, the engine could be started or electrical equipment such as the power windows could be operated. This can lead to serious injury.

### Note

If the engine has been under heavy load for an extended period, heat builds up in the engine compartment after the engine is switched off - there is a risk of damaging the engine. Allow the engine to run at idle for about two minutes before switching it off.

## Driver messages

### Ignition is on

This message appears and a warning tone sounds if you open the driver's door when the ignition is switched on.

### No key identified

This message appears when the **START ENGINE STOP** button is pressed if there is no master key inside the vehicle or if the system does not recognize it. For example, the master key cannot be recognized if it is covered by an object (e.g. aluminum brief case) which *screens* the radio signal. Electronic devices such as cell phones can also interfere with the radio signal.

### Press brake pedal to start engine

This message appears if you do not press the brake pedal to start the engine in a vehicle with an automatic transmission.

### Press clutch pedal to start engine

This message appears if you do not press the clutch pedal to start the engine in a vehicle with a manual transmission.

### Shift to N or P to start engine

This message appears when attempting to start the engine if the selector lever for the automatic transmission is not in the P or N position. The engine can only be started with the selector in these positions.

### Is the key in the vehicle?

This message appears if the master key is removed from the vehicle with the engine running. If the master key is no longer in the vehicle, you cannot switch on the ignition after stopping the engine and you also cannot start the engine again. Moreover, you cannot lock the vehicle from the outside with the key.

### Shift to P otherwise vehicle can roll away. Doors do not lock if lever is not in P.

This message appears for safety reasons along with a warning signal. It appears if the selector lever for the automatic transmission is not in the P position when switching off the ignition. Move the selector lever to the P position, otherwise the vehicle is not secured against rolling away. You also cannot lock the vehicle using the locking button\* on the door handle or using the remote key.

### Convenience key defective! Use ignition lock

This message appears if the engine must be started or stopped using the ignition key and not the **START ENGINE STOP** button.

## Electromechanical parking brake

### Operation

The electromechanical parking brake replaces the hand brake.

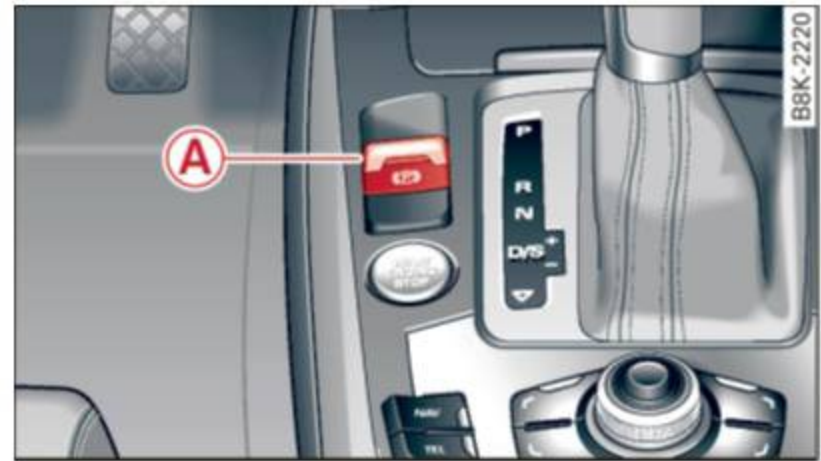







Fig. 101 Center console: Parking brake

- ▶ Pull on the switch  ⇒ *fig. 101* to apply the parking brake. The indicator lights in the switch and  (USA models)/ (Canada models) in the instrument cluster illuminate.
- ▶ With the ignition switched on, step on the brake pedal or the accelerator pedal and press the switch  at the same time to release the parking brake. The indicator lights in the switch and  (USA models)/ (Canada models) in the instrument cluster go out.

Your vehicle is equipped with an electromechanical parking brake. The parking brake is designed to prevent the vehicle from rolling unintentionally and replaces the hand brake.

In addition to the normal functions of a traditional hand brake, the electromechanical parking brake provides various convenience and safety functions.

### When starting from rest

- The integral starting assist helps you when driving by automatically releasing the parking brake ⇒ *page 88, Starting from rest.*
- When starting on inclines, the starting assist prevents the vehicle from unintentionally rolling back. The braking force of the parking brake is not released until sufficient ▶

driving force has been built up at the wheels.

### Emergency brake function

An emergency brake ensures that the vehicle can be slowed down even if the *normal* brakes fail ⇒ *page 89, Emergency braking*.



#### WARNING

If a gear or a drive range (automatic transmission) is engaged with the vehicle stationary and the engine running, you must in no instance accelerate or release the clutch\* carelessly. Otherwise the vehicle will start to move immediately - risk of an accident.

#### Tips

- If the parking brake is applied with the ignition switched off, the indicator lights in the switch and **PARK** (USA models)/ (Canada models) in the instrument cluster will go out after a certain period of time.
- Occasional noises when the parking brake is applied and released are normal and are not a cause for concern.
- When the vehicle is parked, the parking brake goes through a self-test cycle at regular intervals. Any associated noises are normal.

### Parking

- ▶ Press the brake pedal to stop the vehicle.
- ▶ Pull the switch  ⇒ *page 87, fig. 101* to set the parking brake.
- ▶ Automatic transmission: Move the selector lever to P.
- ▶ Turn the engine off ⇒ .
- ▶ Manual transmission: Shift into 1st gear.
- ▶ When on inclines or declines, turn the steering wheel so that the vehicle will roll into the curb if it begins to move.

#### WARNING

- When you leave your vehicle - even if only briefly - always remove the ignition key. This applies particularly when children remain in the vehicle. Otherwise the children could start the engine, release the parking brake or operate electrical equipment (e.g. power windows). There is the risk of an accident.
- When the vehicle is locked, no one - particularly not children should remain in the vehicle. Locked doors make it more difficult for emergency workers to get into the vehicle - putting lives at risk.

### Starting from rest

*The starting assist function ensures that the parking brake is released automatically upon starting.*

### Stopping and applying parking brake

- ▶ Pull the switch  ⇒ *page 87, fig. 101* to apply the parking brake.

### Starting and automatically releasing the parking brake

- ▶ When you start to drive as usual, the parking brake is automatically released and your vehicle begins to move.

When stopping at a traffic signal or stopping in city traffic on vehicles with an automatic transmission, the parking brake can be applied. The vehicle does not have to be held with the footbrake. The parking brake eliminates the tendency to creep with a drive range engaged. As soon as you drive off as usual, the parking brake is released automatically and the vehicle starts to move.

### Starting on slopes



When starting on inclines, the starting assist prevents the vehicle from unintentionally rolling back. The braking force of the parking brake is not released until sufficient driving force has been built up at the wheels. ►

### Tips

For safety reasons, the parking brake is released automatically only when the driver's safety belt is engaged in the buckle.

### Starting off with a trailer



To prevent rolling back unintentionally on an incline, do the following:



- ▶ Keep the switch  ⇒ page 87, fig. 101 pulled and depress the accelerator. The parking brake stays applied and prevents the vehicle from rolling backward.
- ▶ You can release the switch  once you are sure that you are developing enough driving force at the wheels by depressing the accelerator.



Depending on the weight of the rig (vehicle and trailer) and the severity of the incline, you may roll backwards as you start. You can prevent rolling backwards by holding the parking brake switch  pulled out and accelerating - just as you would when starting on a hill with a conventional hand brake.

### Emergency braking

In the event that the conventional brake system fails or locks.

- ▶ In an emergency, pull the switch  ⇒ page 87, fig. 101 and continue to pull it to slow your vehicle down with the parking brake.
- ▶ As soon as you release the switch  or accelerate, the braking process stops.

If you pull the switch  and hold it above a speed of about 5 mph (8 km/h), the emergency braking function is initiated. The vehicle is braked at all four wheels by activating the hydraulic brake system. The brake performance is similar to making an emergency stop ⇒ .

In order not to activate the emergency braking by mistake, an audible warning tone (buzzer) sounds when the switch  is pulled. As soon as the switch  is released, or the accel-

erator pedal is depressed, emergency braking stops.

### WARNING

Emergency braking should only be used in an emergency, when the normal foot brake has failed or the brake pedal is obstructed. Using the parking brake to perform emergency braking will slow your vehicle down as if you had made a full brake application. The laws of physics cannot be suspended even with ESC and its associated components (ABS, ASR, EDS). In corners and when road or weather conditions are bad, a full brake application can cause the vehicle to skid or the rear end to break away - risking an accident.

## Speed warning system

### Overview



The speed warning system helps you to keep your driving speed below a set speed limit.

The speed warning system warns if the driver exceeds a previously stored maximum speed. A warning tone will sound as soon as the vehicle speed exceeds the set speed by about 3 mph (3 km/h). At the same time, a warning symbol appears in the display. The symbol's appearance might be different in some models.

The speed warning system has one or two\* warning thresholds that function independently of each other and that have somewhat different purposes:

### Speed warning 1

You can use speed warning 1 to set the maximum speed while you are driving. This setting will remain in effect until you turn off the ignition, assuming that you have not changed or reset the setting.

The  (USA models) /  (Canada models) speed warning symbol in the warning 1 display appears when you exceed the maximum



speed. It goes out when the speed falls below the stored maximum speed.

The speed warning symbol will also go out if the speed *exceeds* the stored maximum speed by more than about 25 mph (40 km/h) for at least 10 seconds. The stored maximum speed is deleted.

Setting speed warning 1 ⇒ *page 90*.

### Speed warning 2\*

Storing warning 2 is recommended if you *always* want to be reminded of a certain speed, for example when you are traveling in a country that has a general maximum speed limit, or if you do not want to exceed a specified speed for winter tires.

The  (USA models) /  (Canada models) speed warning 2 symbol appears in the display when you exceed the stored speed limit. Unlike warning 1, it will not go out until the vehicle speed drops below the stored speed limit.

Setting speed warning 2 ⇒ *page 90*.

#### Tips

Even though your vehicle is equipped with a speed warning system, you should still watch the speedometer to make sure you are not driving faster than the speed limit.

### Speed warning 1: setting a speed limit

Warning threshold 1 is set by the **SET** button.





Fig. 102 SET button in the instrument cluster

### Storing the maximum speed

- ▶ Drive at the desired maximum speed.
- ▶ Press the **SET** button in the instrument panel display ⇒ *fig. 102* for 1 second.

### Resetting the maximum speed

- ▶ Drive the vehicle at a speed of at least 3 mph (5 km/h)
- ▶ Press the **SET** button for more than 2 seconds.

The  (USA models) /  (Canada models) speed warning symbol will appear briefly in the display when you release the **SET** button to indicate that the maximum speed has been stored successfully.

The maximum speed remains stored until it is changed by pressing the **SET** button again briefly or until it is deleted by a lengthy push on the button.

### Speed warning 2: setting a speed limit

Applies to vehicles: with trip computer

*The radio or MMI\* control unit is used to set, change or delete warning threshold 2.*

- ▶ Select: **CAR** function button > **Instrument cluster** > **Speed warning**. Or
- ▶ Select: **CAR** function button > **Car systems\*** control button > **Driver assist** > **Speed warning**.

Warning threshold 2 can be set in the speed range starting from 20 mph to 150 mph (30 km/h to 240 km/h). Settings can each be adjusted in intervals of 6 mph (10 km/h).

## Cruise control

### Switching on

The cruise control system makes it possible to drive at a constant speed starting at 20 mph (30 km/h).



Fig. 103 Control lever with push-button

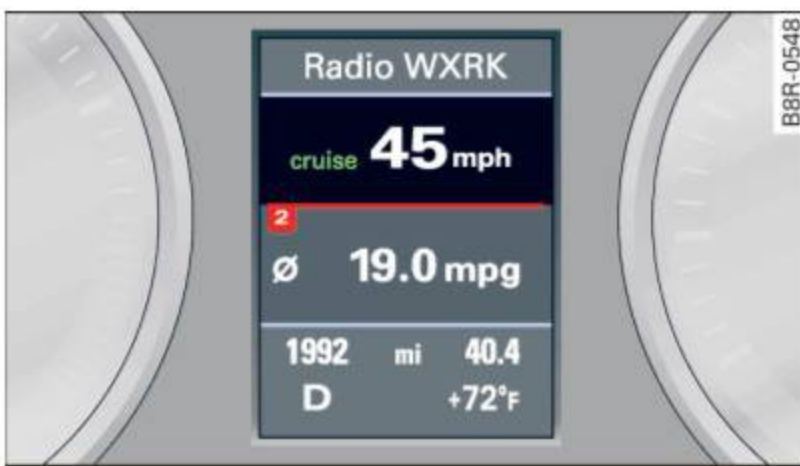



Fig. 104 Display: Selected speed

- ▶ Pull the lever to position ① ⇒ fig. 103 to switch the system on.
- ▶ Drive at the speed to be controlled.
- ▶ Press button A to set that speed.

The stored speed and the green symbol **CRUISE** (US model) /  (Canadian model) are shown in the display ⇒ fig. 104. The display may vary, depending on the type of display in your vehicle.

The speed is kept constant by modifying engine power or through an active brake intervention.

### WARNING





- Always pay attention to the traffic around you when the cruise control is in operation. You are always responsible for your speed and the distance between your vehicle and other vehicles.

- For reasons of safety, cruise control should not be used in the city, in stop-and-go traffic, on twisting roads and when road conditions are poor (such as ice, fog, gravel, heavy rain and hydroplaning) - risk of accident.
- Turn off the cruise control temporarily when entering turn lanes, highway exit lanes or in construction zones.
- Please note that inadvertently “resting” your foot on the accelerator pedal causes the cruise control not to brake. This is because the cruise control is overridden by the driver's acceleration.
- If a brake system malfunction such as overheating occurs when the cruise control system is switched on, the braking function in the system may be switched off. The other cruise control functions remain active as long as the indicator light **CRUISE** (US models) /  (Canadian models) is on.

### Tips

- Vehicles with manual transmission: You can attain the set speed only if the gear that is currently engaged will allow it, or if it does not tax the engine and allows it to run smoothly. Therefore shift into a higher or lower gear in a timely manner.
- The brake lights illuminate as soon as the brakes apply automatically.

### Changing speed

- ▶ To increase/decrease the speed in increments, tap the lever in the / direction ⇒ page 91, fig. 103.
- ▶ To increase/decrease the speed quickly, hold the lever in the / direction until the desired speed is displayed.

You can also press the accelerator pedal down to increase your speed, e.g. if you want to pass someone. The speed you saved earlier will resume as soon as you let off of the accelerator pedal.

If, however, you exceed your saved speed by 6 mph (10 km/h) for longer than 5 minutes, the cruise control will be turned off temporarily. The green symbol in the display turns white. The saved speed remains the same.

### Presetting your speed

*You can preset your desired speed while the vehicle is not moving.*

- ▶ Switch on the ignition.
- ▶ Pull lever into position ① ⇒ *page 91, fig. 103.*
- ▶ Press the lever in the ⊕ or ⊖ direction to increase or decrease your speed.
- ▶ Release the lever to save that speed.

This function makes it possible, for example, to save the speed you want before driving on the highway. Once on the highway, activate the cruise control by pulling the lever toward ①.

### Switching off

#### Temporary deactivation

- ▶ Press the brake pedal, or
- ▶ *Manual transmission:* Keep the clutch pedal pressed down *longer*, or
- ▶ Press the lever into position ② (not clicked into place) ⇒ *page 91, fig. 103*, or
- ▶ Drive for longer than 5 minutes at more than 6 mph (10 km/h) above the stored speed.

#### Switching off completely

- ▶ Press lever into position ② (clicked into place), or
- ▶ Switch the ignition off.

The speed you saved will be retained if the cruise control has been switched off temporarily. To resume the saved speed, let up on the brake or clutch pedal and pull the lever to position ①.

Switching the ignition off erases the saved speed.



#### WARNING

You should only return to the saved speed if it is not too fast for the current traffic conditions - risk of an accident!

## Transmission

### Manual transmission

#### Gearshift lever

Applies to vehicles: with manual transmission

*The clutch pedal must be depressed all the way before you can start the engine.*

The manual transmission in your Audi is equipped with an *interlock-feature*.

- ▶ Depress the clutch pedal all the way.
- ▶ Start the engine with the gearshift lever in Neutral and the clutch pedal depressed.

#### ! Note

Always depress the clutch pedal fully when changing gears. Do not hold the vehicle on a hill with the clutch pedal partially depressed. This may cause premature clutch wear or damage.

#### i Tips

- Resting your hand on the gearshift lever knob while driving will cause premature wear in the transmission.
- The back-up lights go on when you shift into Reverse with the ignition on.

#### Gearshift pattern (6-speed manual transmission)

Applies to vehicles: with manual transmission

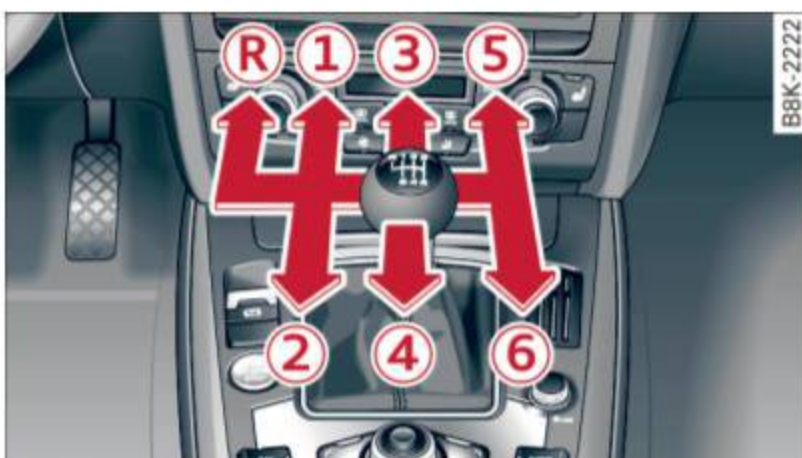

Fig. 105 Gearshift pattern: 6-speed manual transmission

#### Engaging reverse gear (R)

- ▶ Move the shift lever all the way to the left, press it down, then push it forward.

Especially after driving forward, stop the vehicle completely, shift into *Neutral* and rest the shift lever briefly in *Neutral* before shifting into *Reverse*.

### multitronic, S tronic, tiptronic

#### Introduction

Applies to vehicles: with multitronic/S tronic/tiptronic

The automatic transmission is controlled electronically. The transmission upshifts or downshifts automatically depending on which drive program is selected.

When a **moderate driving style** is used, the transmission selects the most economical driving mode. It will then change up early and delay the downshifts to give better fuel economy.

The transmission switches to a sporty mode after a kick-down or when the driver uses a **sporty driving style** characterized by quick accelerator pedal movements, heavy acceleration, frequent changes in speed and traveling at the maximum speed.

If desired, the driver can also select the gears *manually (tiptronic mode)* ⇒ page 93.

Various automatic transmissions may be installed, depending on the model:

#### multitronic transmission

The multitronic transmission is a continuously variable transmission. Power is transferred using a multidisk clutch. In contrast to conventional automatic transmissions using shifting operations, the transmission ratio in the continuously variable transmission is changed continuously. This optimizes the comfort level and conserves fuel.

#### S tronic transmission

The S tronic is a dual-clutch transmission. Power is transferred using two clutches that work independently from one another. They replace the torque converter used in conventional automatic transmissions and allow the

vehicle to accelerate without a noticeable interruption in traction.

### tiptronic transmission

In the tiptronic transmission, power is transferred by a torque converter.

#### Selector lever positions

Applies to vehicles: with multitronic/S tronic/tiptronic

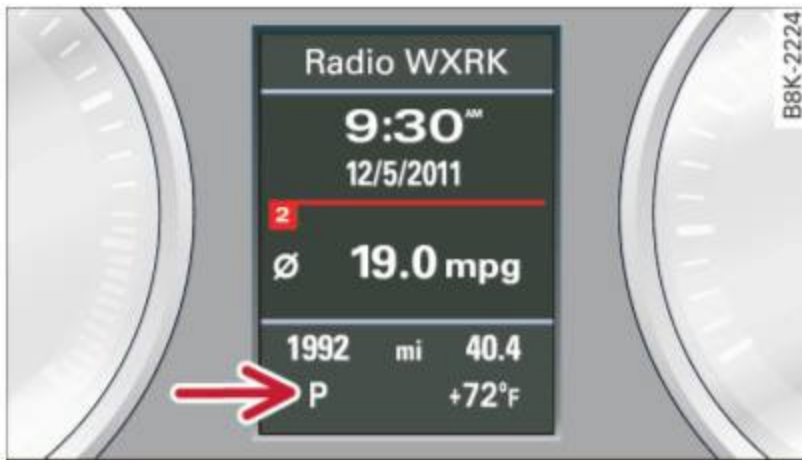

Fig. 106 Display in the instrument cluster: selector lever in position P

The selector lever position engaged appears next to the selector lever as well as in the instrument cluster display.

### P - Park

In this selector lever position the transmission is mechanically locked. Engage P only when the vehicle is *completely stopped* ⇒ ⚠ in *Driving the automatic transmission on page 96*.

To shift in or out of position P, you must *first* press and hold the brake pedal *and then* press the release button in the selector lever handle while moving the selector lever to or from P. You can shift out of this position only with the ignition on.

### R - Reverse

Select R only when the vehicle is at a *full stop* and the engine is running at idle speed ⇒ ⚠ in *Driving the automatic transmission on page 96*.

Before you move the selector lever to R, press *both* the release button in the handle of the selector lever *and* the brake pedal at the same time.

When the ignition is on, the backup lights illuminate when the selector lever is moved into R.

### N - Neutral

The transmission is in neutral in this position. Shift to this position for standing with the brakes applied ⇒ ⚠ in *Driving the automatic transmission on page 96*.

When the vehicle is stationary or at speeds below 1 mph (2 km/h), you must always apply the footbrake before and while moving the lever out of N.

### D/S - Normal position for driving forward

In the D/S position, the transmission can be operated either in the normal mode D or in the sport mode S. To select the sport mode S, pull the selector lever back briefly. Pulling the lever back again will select the normal mode D. The instrument cluster display shows the selected driving mode.

In the **normal mode** D, the transmission automatically selects the suitable gear ratio. It depends on engine load, vehicle speed and driving style.

Select the **sport mode** S for sporty driving. The vehicle makes full use of the engine's power. Shifting may become noticeable when accelerating.

When the vehicle is stationary or at speeds below 1 mph (2 km/h), you must always apply the foot brake before and while moving the lever to D/S out of N.

#### ⚠ WARNING

Read and follow all WARNINGS ⇒ ⚠ in *Driving the automatic transmission on page 96*.

#### ! Note

Coasting downhill with the transmission in N and the engine not running will result in damage to the automatic transmission and possibly the catalytic converter.

### **i** Tips

- On vehicles with drive select\*, you can adjust the sporty shift characteristics in the **Dynamic** driving mode. S will appear in the instrument cluster display instead of D.
- If you accidentally select N while driving, take your foot off the accelerator pedal immediately and wait for the engine to slow down to idle before selecting D/S.
- If there is a power failure, the selector lever will not move out of the P position. The emergency release can be used if this happens ⇒ *page 100*.

### Automatic Shift Lock (ASL)

Applies to vehicles: with multitronic/S tronic/tiptronic

The Automatic Shift Lock safeguards you against accidentally shifting into a forward or the reverse gear and causing the vehicle to move unintentionally.

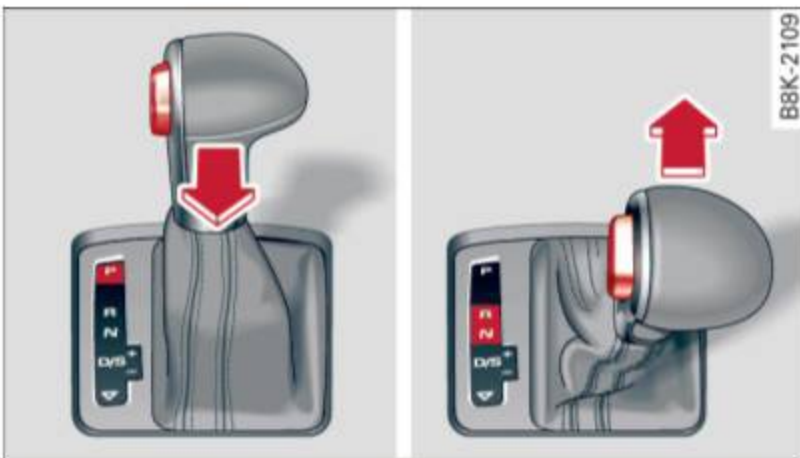

**Fig. 107** Shift gate: selector lever lock positions and release button highlighted

The selector lever lock is released as follows:

- ▶ Turn the ignition on.
- ▶ Step on the brake pedal. *At the same time* press and hold the release button on the side of the gear selector knob ⇒ *fig. 107* with your thumb until you have moved the selector lever to the desired position.

### Automatic selector lever lock

The selector lever is locked in the P and N positions when the ignition is turned on. You must press the brake pedal and the release button to select another position. As a reminder to the driver, the following warning

appears in the instrument cluster display when the selector is in P and N:

### When stationary apply brake pedal while selecting gear

The Automatic Shift Lock only functions when the vehicle is stationary or at speeds below 1 mph (2 km/h).

At speeds above about 1 mph (2 km/h) the Automatic Shift Lock is automatically deactivated in the N position.

A time delay element prevents the selector lever from locking when it is moved through the N position (going from R to D/S). The locking element will lock the selector lever if the lever is left in N (Neutral) for more than approximately 2 seconds, without the brake pedal being pressed.

### Release button

The release button on the selector lever prevents the lever from being accidentally shifted into certain positions. Depending on the direction of the shift, the selector lever locks at different positions. The positions are highlighted in the illustration ⇒ *fig. 107*.

### Ignition key safety interlock

The key cannot be removed from the ignition unless the selector lever is in the P park position. When the ignition key is removed, the selector lever will be locked in the P position.

### Driving the automatic transmission

Applies to vehicles: with multitronic/S tronic/tiptronic



**Fig. 108** Shift gate on the center console: selector lever with release button

### Starting the engine

- ▶ The selector lever must be in P or N.

### Starting off

- ▶ Press and hold the brake pedal.
- ▶ Press and hold the release button in the selector lever handle, select the desired selector lever position such as D/S and release the button.
- ▶ Wait briefly until the transmission has shifted (you will feel a slight movement).
- ▶ Remove your foot from the brake pedal and accelerate.

### Stopping temporarily



- ▶ Keep the vehicle stationary using the braking pedal, for example at traffic lights.
- ▶ Do not press the accelerator pedal when doing this.
- ▶ To prevent the vehicle from rolling when you start driving, set the parking brake when stopping on steep inclines ⇒ .
- ▶ The parking brake will release automatically and the vehicle will start moving once you press the accelerator pedal.

### Stopping/parking

If the selector lever is not in the P position when you open the driver's door, the vehicle could roll. The message **Transmission: Car may roll! Shift to park!** appears.

- ▶ Press and hold the brake pedal until the vehicle has come to a complete stop.
- ▶ Apply the parking brake ⇒ *page 88, Parking*.
- ▶ Select the P selector lever position ⇒ .

### Stopping on an incline

- ▶ *Always* press the brake pedal to hold the vehicle in place and prevent it from "rolling back" ⇒ . Do **not** try to prevent the vehicle from "rolling back" when a gear is engaged by increasing the engine speed ⇒ .

### Starting on an incline

- ▶ Activate the parking brake.
- ▶ With the driving gear selected, press the accelerator pedal carefully. The parking brake

will release automatically if your seat belt is fastened.

Under certain circumstances, such as driving in the mountains, it may be useful to switch temporarily to the manual shift program in order to adjust the gears to the driving conditions by hand ⇒ *page 98*.

On slopes, activate the parking brake first and then move the selector lever to the P position. This prevents too much stress from being placed on the locking mechanism.

Vehicles with multitronic transmission: Your vehicle is equipped with **hill hold assist** allowing you to start while on an incline. The system is activated when the brake pedal is pressed down and held **for a few seconds**. The brake pressure will hold for *a moment* after the brake pedal loosens to prevent the vehicle from rolling backwards while starting up.

#### **WARNING**

- The vehicle can also roll when the engine is stopped.
- Unintended vehicle movement can cause serious injury.
- Never leave your vehicle with the engine running while in gear. If you must leave your vehicle when the engine is running, activate the parking brake and move the selector lever to P.
- Power is still transmitted to the wheels when the engine is running at idle. To prevent the vehicle from "creeping", you must keep your foot on the brake when the engine is running and the selector lever is in D/S or R or "tiptronic" mode is selected.
- Do not press the accelerator pedal when changing the selector lever position while the vehicle is stationary and the engine is running.
- Never shift into R or P while driving.
- Before driving down a steep slope, reduce your speed and shift into a lower gear with "tiptronic".

- Do not ride the brakes or press the brake pedal too often or too long when driving down a hill. Constant braking causes the brakes to overheat and substantially reduces braking performance, increases braking distance or causes complete failure of the brake system.
- To prevent the vehicle from rolling back when stopping on inclines, always hold it in place with the brake pedal or parking brake.
- Never hold the vehicle on an incline with a slipping clutch. The clutch opens automatically when it becomes too hot from the overload. An indicator lamp  illuminates and a driver message appears ⇒ *page 99* when the clutch is overloaded.
- If the engine must remain running, never have any driving position engaged when checking under the hood. Make sure the selector lever has securely engaged and is locked in P with the parking brake set ⇒ *page 212*. Otherwise, any increase in engine speed may set the vehicle in motion, even with the parking brake applied.

### Note

- S tronic- and tiptronic transmission: When stopping on an incline, do not try to hold the vehicle in place by pressing the accelerator pedal while a driving gear is selected. This can cause the transmission to overheat and can damage it. Activate the parking brake or press the brake pedal to prevent the vehicle from rolling.
- S tronic- and tiptronic transmission: Allowing the vehicle to roll when the engine is stopped and the selector lever is in N will damage the transmission because it is not lubricated under those circumstances.

### Tips

For safety reasons, the parking brake is released automatically only when the driver's safety belt is engaged in the buckle.

## Hill descent control

Applies to vehicles: with multitronic/S tronic/tiptronic

*The hill descent control system assists the driver when driving down declines.*

Hill descent control is activated when the selector lever is in D/S and you press the brake pedal. The transmission automatically selects a gear that is suitable for the incline. Hill descent control tries to maintain the speed achieved at the time of braking, within physical and technical limitations. It may still be necessary to adjust the speed with the brakes.

Hill descent control switches off once the decline levels out or you press the accelerator pedal.

On vehicles with the cruise control system\* ⇒ *page 91*, hill descent control is also activated when the speed is set.

### WARNING

Hill descent control cannot overcome physical limitations, so it may not be able to maintain a constant speed under all conditions. Always be ready to apply the brakes.

### Manual shift program

Applies to vehicles: with multitronic/S tronic/tiptronic

Using the manual shift program you can manually select gears.



Fig. 109 Center console: shifting the gears manually

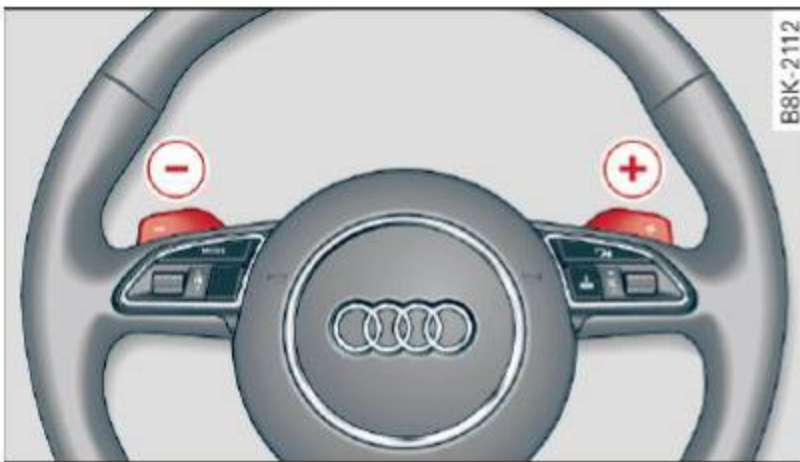

Fig. 110 Steering wheel: shift paddles\*

### Gear selection with selector lever

The tiptronic mode can be selected either with the vehicle stationary or on the move.

- ▶ Push the selector lever to the right from D/S. An M appears in the instrument cluster display as soon as the transmission has shifted.
- ▶ To upshift, push the selector lever forward to the plus position ⊕ ⇒ fig. 109.
- ▶ To downshift, push the lever to the minus position ⊖.

### Gear selection with shift paddles\*

The shift paddles are activated when the selector lever is in D/S or the tiptronic manual shift program.

- ▶ To upshift, touch the shift paddle on the right ⊕ ⇒ fig. 110.
- ▶ To downshift, touch the shift paddle on the left ⊖.
- ▶ If you do not press a shift paddle within a short time while in the D/S position, the

transmission will return to automatic mode. To keep shifting using the shift paddles, move the selector lever to the right out of the D/S position.

The transmission automatically shifts up or down before critical engine speed is reached.

The transmission only allows manual shifting when the engine speed is within the permitted range.

### **i** Tips

- When you shift into the next lower gear, the transmission will downshift only when there is no possibility of over-revving the engine.
- When the kick-down comes on, the transmission will shift down to a lower gear, depending on vehicle and engine speeds.
- Tiptronic is inoperative when the transmission is in the fail-safe mode.

### Kick-down

Applies to vehicles: with multitronic/S tronic/tiptronic

*Kick-down enables maximum acceleration.*

### Applies to vehicles with a multitronic transmission

When you depress the accelerator pedal beyond the resistance point, the transmission downshifts into a lower gear ratio depending on the vehicle speed and engine speed. As long as the accelerator pedal is depressed, the engine speed is automatically regulated for maximum acceleration.

### Applies to vehicles with a S tronic-/tiptronic transmission

When you depress the accelerator pedal beyond the resistance point, the automatic transmission downshifts into a lower gear, depending on vehicle speed and engine speed. The upshift into the next higher gear takes place once the maximum specified engine speed is reached.

**! WARNING**





Please note that the drive wheels can spin if kick-down is used on a smooth slippery road - there is a risk of skidding.

**Launch Control Program**

Applies to vehicles: with S tronic

*The Launch Control Program provides the best acceleration possible when starting from a stop.*

Requirement: The engine must be at operating temperature and the steering wheel must not be turned.

- ▶ Sedan: Press the  button ⇒ *page 187* while the engine is running. The  indicator light illuminates in the instrument cluster and **Stabilization control (ESC): Sport. Warning! Restricted stability** appears in the driver information system display.
- ▶ allroad: Press the  button ⇒ *page 187* while the engine is running. The  indicator light illuminates in the instrument cluster and **Stabilization control (ESC): Offroad. Warning! Restricted stability** appears in the driver information system display.
- ▶ Move the selector lever to the D/S position to select sport mode (S) or select the **dynamic** driving mode in drive select\* ⇒ *page 116*.
- ▶ Press the brake pedal strongly with your left foot and hold it down for at least 1 second.
- ▶ At the same time, press the accelerator pedal down completely with your right foot until the engine reaches and maintains a high RPM.
- ▶ Remove your foot from the brake pedal within 5 seconds ⇒ .

**! WARNING**

- Always adapt your driving to the traffic flow.
- Only use the Launch Control Program when road and traffic conditions allow it and other drivers will not be endangered

or annoyed by your driving and the vehicle's acceleration.

- Please note that the driving wheels can spin and the vehicle can break away when sport mode/offroad mode is switched on, especially when the road is slippery.
- Once you have accelerated, you should switch sport mode/offroad mode off by pressing the  button.

**i Tips**

- The transmission temperature may increase significantly after using the Launch Control Program. If that happens, the program may not be available for a few minutes. It will be available again after a cool-down period.
- When accelerating using the Launch Control program, all vehicle parts are subject to heavy loads. This can result in increased wear.

**Transmission malfunction**

Applies to vehicles: with multitronic/S tronic/tiptronic

**! Transmission: Press brake pedal and select gear again.**

Press the brake pedal and select the desired selector lever position again. You can then continue driving.

**! Transmission overheating: Please drive conservatively.**

The transmission temperature has increased significantly due to the sporty driving manner. Drive in a less sporty manner until the temperature returns to the normal range and the indicator light switches off.

**! Transmission malfunction: You can continue driving**

There is a system malfunction in the transmission. You may continue driving. Drive to your authorized Audi dealer or qualified repair facility soon to have the malfunction corrected. ▶

### Transmission malfunction: Limited driving functionality

There is a system malfunction in the transmission. The transmission is switching to emergency mode. This mode only shifts into certain gears or will no longer shift at all. The engine may stall. Drive to your authorized Audi dealer or qualified repair facility immediately to have the malfunction corrected.

### Transmission malfunction: No reverse You can continue driving

S tronic transmission: There is a system malfunction in the transmission. The transmission is switching to emergency mode. This mode only shifts into certain gears or will no longer shift at all. The engine may stall. You cannot engage the reverse gear. Drive to your authorized Audi dealer or qualified repair facility immediately to have the malfunction corrected.

### Transmission malfunction: Stop vehicle and shift to park.

Do not continue driving. Select the P selector lever position and see your authorized Audi dealer or qualified repair facility for assistance.

#### Note

If the transmission switches to emergency mode, you should take the vehicle to an authorized Audi dealership as soon as possible to have the condition corrected.

### Selector lever emergency release

Applies to vehicles: with multitronic/S tronic/tiptronic

*If the vehicle's power supply fails, the selector lever can be released in an emergency.*

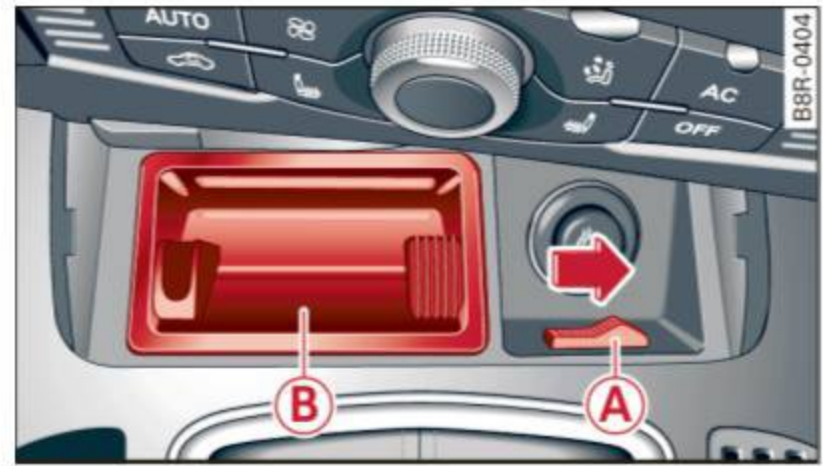

Fig. 111 Front center console: Removing the ashtray insert



Fig. 112 Selector lever emergency release

- ▶ To access the emergency release mechanism, remove the ashtray insert **B** using the release switch **A** ⇒ *fig. 111*.
- ▶ Loosen and remove the cap in the ashtray mount.
- ▶ You now have access to a pin. Using a screwdriver or similar object, press the pin down and hold it in that position ⇒ *fig. 112*.
- ▶ Now press the release button and move the selector lever to the N position.

The selector lever can only be moved from the P position if the key is in the lock and the ignition is switched on. If the power supply fails (for example, the battery is discharged) and the vehicle must be pushed or towed, move the selector lever to the N position first using the emergency release.

# Audi adaptive cruise control and braking guard

## Introduction

Applies to vehicles: with Audi adaptive cruise control

The adaptive cruise control system assists the driver by regulating vehicle speed and helping to maintain a set distance to the vehicle ahead, within the limits of the system. If the system detects a moving vehicle up ahead, adaptive cruise control can brake and then accelerate your vehicle. This helps to make driving more comfortable on long highway stretches.

The braking guard system can warn you about an impending collision and initiate braking maneuvers ⇒ *page 107*.

Adaptive cruise control and braking guard have technical limitations that you must know, so please read this section carefully, understand how the system works and use them properly at all times.

## General information

### General information

Applies to vehicles: with Audi adaptive cruise control



**Fig. 113** Front of the vehicle: Position of radar sensor

The area that contains the radar sensor ⇒ *fig. 113* must never be covered by stickers or other objects or obstructed with dirt, insects, snow or ice that will interfere with the adaptive cruise control system and braking guard. For information on cleaning, refer to ⇒ *page 202*. The same applies for any modifications made in the front area.

The function of the adaptive cruise control system and braking guard is limited under some conditions:

- Objects can only be detected when they are within sensor range ⇒ *page 103, fig. 116*.
- The system has a limited ability to detect objects that are a short distance ahead, off to the side of your vehicle or moving into your lane.
- Some kinds of vehicles are hard to detect; for example motorcycles, vehicles with high ground clearance or overhanging loads may be detected when it is too late or they may not be detected at all.
- When driving through curves ⇒ *page 102*.
- Stationary objects ⇒ *page 102*.

### WARNING

Always pay attention to traffic when adaptive cruise control is switched on and braking guard is active. As the driver, you are still responsible for starting and for maintaining speed and distance to other objects. Braking guard is used to assist you. The driver must always take action to avoid a collision. The driver is always responsible for braking at the correct time.

- Improper use of adaptive cruise control can cause collisions, other accidents and serious personal injury.
- Never let the comfort and convenience that adaptive cruise control and braking guard offer distract you from the need to be alert to traffic conditions and the need to remain in full control of your vehicle at all times,
- Always remember that the adaptive cruise control and braking guard have limits – they will not slow the vehicle down or maintain the set distance when you drive towards an obstacle or something on or near the road that is not moving, such as vehicles stopped in a traffic jam, a stalled or disabled vehicle. If registered by the radar sensor, vehicles or obstacles that are not moving can trigger a collision warning and if

confirmed by the video camera, an acute collision warning.

- For safety reasons, do not use adaptive cruise control when driving on roads with many curves, when the road surface is in poor condition and/or in bad weather (such as ice, fog, gravel, heavy rain and hydroplaning). Using the system under these conditions could result in a collision.
- Switch adaptive cruise control off temporarily when driving in turning lanes, on expressway exits or in construction zones. This prevents the vehicle from accelerating to the set speed when in these situations.
- The adaptive cruise control system will not brake by itself if you put your foot on the accelerator pedal. Doing so can override the speed and distance regulation.
- When approaching stationary objects such as stopped traffic, adaptive cruise control will not respond and braking guard will have limited function.
- The adaptive cruise control system and braking guard do not react to people, animals, objects crossing the road or oncoming objects.
- The function of the radar sensor can be affected by reflective objects such as guard rails, the entrance to a tunnel, heavy rain or ice.
- Never follow a vehicle so closely that you cannot stop your vehicle safely. The adaptive cruise control cannot slow or brake the vehicle safely when you follow another vehicle too closely. Always remember that the automatic braking function cannot bring the vehicle to a sudden or emergency stop under these conditions.
- To prevent unintended operation, always switch ACC off when it is not being used.

### ! Note

The sensor can be displaced by impacts or damage to the bumper, wheel housing and underbody. That could affect the adaptive

cruise control system and braking guard. Have your authorized Audi dealer or authorized Audi Service Facility check their function.

### In curves

Applies to vehicles: with Audi adaptive cruise control

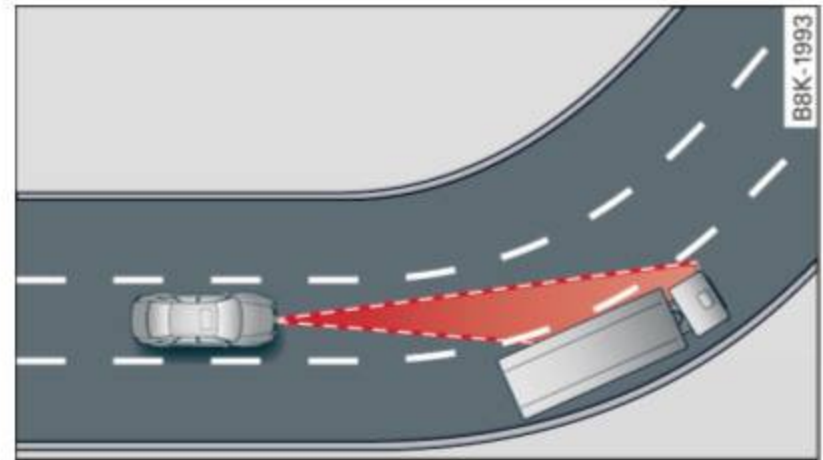

Fig. 114 Example: driving into a curve

When driving into a curve ⇒ *fig. 114* and out of a curve, the adaptive cruise control may react to a vehicle in the next lane and apply the brakes. You can override or prevent the braking by pressing the accelerator pedal briefly.

### Stationary objects

Applies to vehicles: with Audi adaptive cruise control

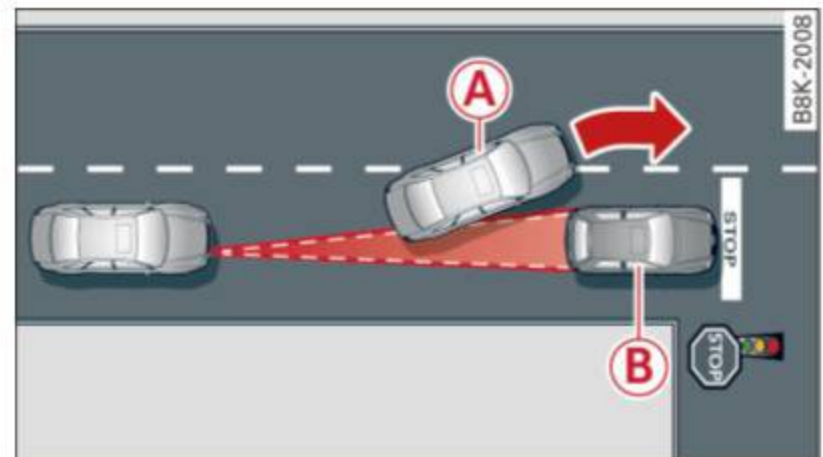

Fig. 115 Example: object changing lanes and stationary object

The adaptive cruise control system only reacts to objects that are moving or that the system has already detected as moving. For example, if a vehicle **A**, which has already been detected by the adaptive cruise control, turns or changes lanes and another stationary vehicle **B** is located in front of that vehicle, the system will not react to the stationary vehicle.

### Vehicles with manual transmission

Applies to vehicles: with Audi adaptive cruise control

The adaptive cruise control is available from the 2nd gear through the 6th gear in the customary RPM.

When the adaptive cruise control is turned on, you must press the clutch to shift gears (as usual). When shifting normally or when pressing the clutch, the adaptive cruise control remains turned on.

After you have engaged the gear, you do **not** need to press the gas pedal. The adaptive cruise control accelerates automatically if necessary.

If you press down on the clutch for too long or shift/couple improperly, the adaptive cruise control may turn off automatically.

#### Tips

You cannot turn on the adaptive cruise control during a shifting operation.

## Audi adaptive cruise control

### Description

Applies to vehicles: with Audi adaptive cruise control

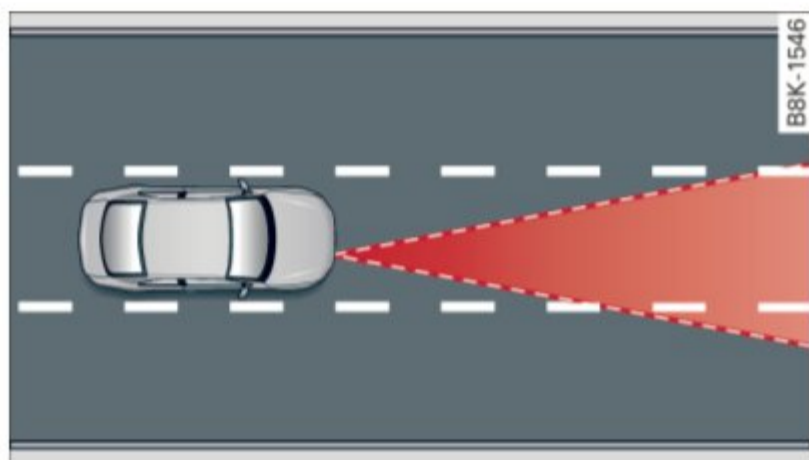

Fig. 116 Detection range

### What can Audi adaptive cruise control do?

The adaptive cruise control works in conjunction with a radar sensor installed in the front of the vehicle ⇒ *page 101, fig. 113*, which is subject to designated system limits ⇒ *page 103*. Stationary objects are disregarded.

On open roads with no traffic, adaptive cruise control works like a regular cruise control system. The stored speed is maintained. When approaching a moving vehicle detected up ahead, the adaptive cruise control system automatically slows down to match that vehicle's speed and then maintains the distance that the driver previously stored. As soon as the system does not detect a vehicle up ahead, adaptive cruise control accelerates back up to the stored speed.

### Which functions can be controlled?

When you switch adaptive cruise control on, you can set the current speed as the “control speed” ⇒ *page 104, Switching on and off*.

When driving, you can stop cruise control ⇒ *page 105* or change the speed ⇒ *page 105* at any time.

You can also set the distance to the object ahead and set the adaptive cruise control driving program ⇒ *page 106*.

## Switching on and off

Applies to vehicles: with Audi adaptive cruise control

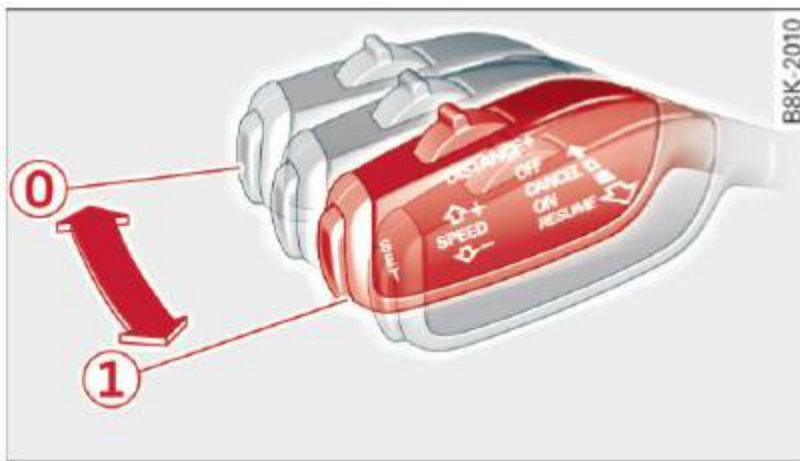

Fig. 117 Selector lever: switching on/off



Fig. 118 Instrument cluster: Audi adaptive cruise control

You can set any speed between 20 mph and 95 mph (30 and 150 km/h).

Indicator lamps and messages in the instrument cluster display inform you about the current system status and settings.

## Switching Audi adaptive cruise control on

- Pull the lever toward you into position ① ⇒ fig. 117. **ACC standby** appears in the instrument cluster display.

## Setting the speed and activating regulation

- To set the current speed, press the **SET** button ⇒ page 11, fig. 4. The set speed is

shown in the tachometer ① and is also shown briefly in the display ② ⇒ fig. 118.

## Switching Audi adaptive cruise control off

- Push the lever away from you into position ② until it clicks into place. The message **ACC off** appears.

## ③ Indicator lights

**③** - Adaptive cruise control is switched on. No vehicles are detected up ahead. The stored speed is maintained.

**③** - A moving vehicle is detected up ahead. The adaptive cruise control system regulates the speed and distance to the moving vehicle ahead and accelerates/brakes automatically.

**③** - When automatic braking is not able to keep enough distance to a previously detected moving vehicle up ahead, you must take control and brake ⇒ page 107, *Request for driver intervention*.

## ④ Display

If adaptive cruise control is not shown in the display, you can call it up with the **RESET** button ⇒ page 23.

Based on the symbols in the display, you can determine if the system is maintaining a distance to the vehicle ahead and what that distance is.

**No vehicle** - No vehicle ahead was detected.

**White vehicle** - A vehicle ahead was detected.

**Red vehicle** - Prompt for the driver to take action ⇒ page 107.

Both **arrows** on the **scale** ④ indicate the distance to the vehicle ahead. No arrow appears when the vehicle is on an open road and there is no object ahead. If an object is detected ahead, the arrow moves on the scale.

The green zone on the scale shows the stored distance. For information on changing the stored distance, refer to ⇒ page 106. If the distance selected is too close or may soon become too close, the arrows move into the red zone on the scale.

**! WARNING**

Improper use of the adaptive cruise control can cause collisions, other accidents and serious personal injuries.

- Pressing the **SET** button when driving at speeds below 20 mph (30 km/h), will automatically accelerate the vehicle to 20 mph (30 km/h), which is the minimum speed that can be set.

**i Tips**

- If you switch the ignition or the adaptive cruise control off, the set speed is erased from the system memory.
- The electronic stabilization control (ESC) and the anti-slip-regulation (ASR) are automatically turned on when the adaptive cruise control is turned on. Both systems cannot be turned off if the adaptive cruise control is turned on.

**Changing the speed**

Applies to vehicles: with Audi adaptive cruise control



Fig. 119 Selector lever: changing the speed

- ▶ To increase or reduce the speed in increments, **tap** the lever up or down.
- ▶ To increase or reduce the speed quickly, **hold** the lever up or down until the red LED **A** reaches the desired speed ⇒ page 104, fig. 118.

Following any changes, the new stored speed will be displayed briefly in the display **D** ⇒ page 104, fig. 118.

**Interrupting cruise control**

Applies to vehicles: with Audi adaptive cruise control

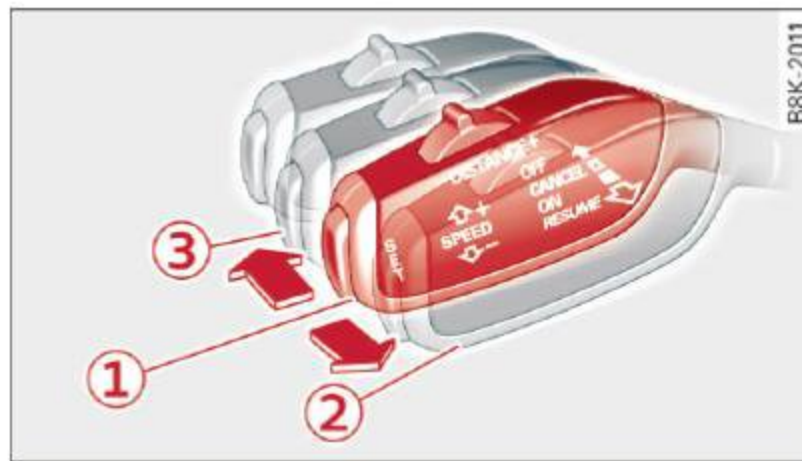

Fig. 120 Selector lever

Requirement: adaptive cruise control must be switched on ⇒ fig. 120 **1**.

**Overriding cruise control**

- ▶ To accelerate manually, press the accelerator pedal. The message **ACC override** appears.
- ▶ To resume adaptive cruise control, remove your foot from the gas pedal. The system returns again to the speed that was saved before.
- ▶ You can save a new speed at any time by pressing the **SET** button ⇒ page 11, fig. 4.

**Canceling cruise control while driving**

- ▶ Move the lever into position **3**. The message **ACC standby** appears. Or
- ▶ press the brake pedal.
- ▶ To resume the stored speed, move the lever into position **2**.

**! WARNING**

Never resume the stored speed if the speed is too high for prevailing road, traffic or weather conditions.

## Setting the distance

Applies to vehicles: with Audi adaptive cruise control

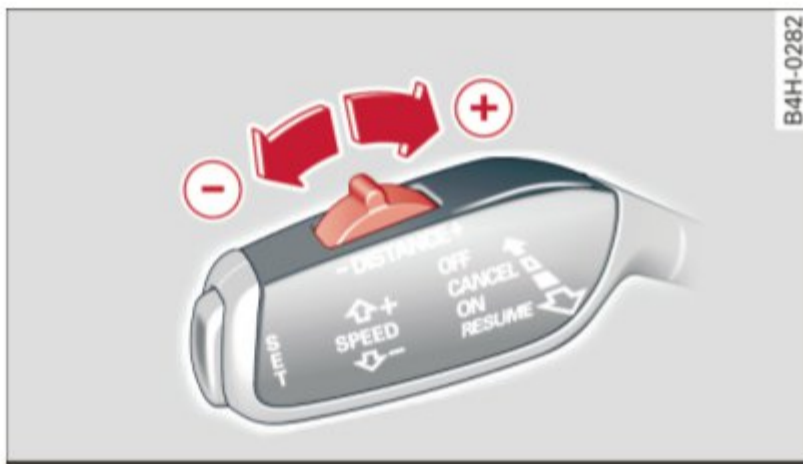

Fig. 121 Selector lever: setting the distance

- ▶ Tap the switch to display the current set distance ⇒ *fig. 121*.
- ▶ To increase or reduce the distance by increments, tap the switch again to the left or right. The distance between the two vehicles will change in the instrument cluster display.

When approaching a moving vehicle up ahead, the adaptive cruise control system brakes to match that object's speed and then maintains the stored distance. If the vehicle ahead accelerates, adaptive cruise control will also accelerate up to the stored speed.

The higher the speed, the greater the distance in yards (meters) ⇒ ⚠. The **Distance 3** setting is recommended.

The distances provided are specified values. Depending on the driving situation and the how the vehicle ahead is driving, the actual distance may be more or less than these target distances.

The various symbols for the time increments appear briefly in the information line ⓐ ⇒ *page 104, fig. 118* when you change the settings.

☞☞☞ **Distance 1:** This setting corresponds to a distance of 92 feet/28 meters when traveling at 62 mph (100 km/h), or a time interval of 1 second.

☞☞☞☞ **Distance 2:** This setting corresponds to a distance of 118 feet/36 meters when traveling at 62 mph (100 km/h), or a time interval of 1.3 seconds.

☞☞☞☞☞ **Distance 3:** This setting corresponds to a distance of 164 feet/50 meters when traveling at 62 mph (100 km/h), or a time interval of 1.8 seconds.

☞☞☞☞☞☞ **Distance 4:** This setting corresponds to a distance of 210 feet/64 meters when traveling at 62 mph (100 km/h), or a time interval of 2.3 seconds.

### ⚠ WARNING

Following other vehicles too closely increases the risk of collisions and serious personal injury.

- Setting short distances to the traffic ahead reduces the time and distance available to bring your vehicle to a safe stop and makes it even more necessary to pay close attention to traffic.
- Always obey applicable traffic laws, use good judgment, and select a safe following distance for the traffic, road and weather conditions.

### ⓘ Tips

- **Distance 3** is set automatically each time you switch the ignition on.
- Your standard settings are automatically stored and assigned to the remote control key being used.

## Setting the driving program

Applies to vehicles: with Audi adaptive cruise control

Depending on the selected driving program and distance, driving behavior when accelerating will vary from dynamic to comfortable.

### Setting the driving program for vehicles without Audi drive select\*

- ▶ In the radio/MMI\*, select: **CAR** function button > **Adaptive cruise control** > **Driving prog.** > **comfort, standard** or **dynamic**. Or
- ▶ Select: **CAR** function button > **Car systems\*** control button > **Driver assist** > **Adaptive cruise control** > **Driving program\*** > **Comfort, Standard** or **Dynamic**.

## Setting the driving mode for vehicles with Audi drive select\*

Refer to ⇒ page 116.

### Tips

Your settings are automatically stored and assigned to the remote control key being used.

### Request for driver intervention

Applies to vehicles: with Audi adaptive cruise control



Fig. 122 Instrument cluster: request for driver intervention

In certain situations, the system will prompt you to take action. This could happen, for example, if braking by the adaptive cruise control system is not enough to maintain enough distance to the vehicle ahead.

The instrument cluster will warn you about the danger ⇒ fig. 122:

- A red vehicle is pictured in the display.
- The text **DISTANCE!** appears in the status bar.
- The red indicator light  blinks.
- In addition, a warning tone sounds.

## Audi braking guard

### Description

Applies to vehicles: with Audi adaptive cruise control





Fig. 123 Instrument cluster: approach warning

Braking guard uses a radar sensor. It also functions within the limits of the system when adaptive cruise control is switched off.

### What can Audi braking guard do?

When detected in time, the system can assess situations when a vehicle ahead brakes suddenly or if your own vehicle is traveling at a high speed and approaching a vehicle up ahead that is moving more slowly. Braking guard does not react if it cannot detect the situation.

The system advises you of various situations:

- The **distance warning** is given if you are too close to the vehicle ahead for a long time. If the vehicle ahead brakes sharply, you will not be able to avoid a collision. The indicator light  in the display comes on.
- The **approach warning** is given when a detected vehicle up ahead in your lane is moving much more slowly than you are or if it brakes sharply. When this warning is given, it may only be possible to avoid a collision by swerving or braking sharply. The indicator light  and indicator in the display will warn you about the danger ⇒ fig. 123. You will also hear an acoustic signal.

If you do not react fast enough or do not react at all to the situation, Braking guard will intervene by braking and the message **braking guard intervention** will appear. ▶

- If a collision is imminent, the system will first provide an **acute warning** by briefly and sharply applying the brakes.
- If you do not react to the acute warning, braking guard can brake within the limits of the system. This reduces the vehicle speed in the event of a collision.
- At speeds under 20 mph (30 km/h), the system can initiate a complete deceleration shortly before a collision<sup>1)</sup>.
- If the braking guard senses that you are not braking hard enough when a collision is imminent, it can increase the braking force.

### Which functions can be controlled?

You can switch braking guard and the distance/approach warning on or off in the radio or MMI ⇒ *page 108, Settings in the radio/MMI*.

#### **WARNING**

Lack of attention can cause collisions, other accidents and serious personal injuries. The braking guard is an assist system and cannot prevent a collision by itself. The driver must always intervene. The driver is always responsible for braking at the correct time.

- Always pay close attention to traffic, even when the braking guard is switched on. Be ready to intervene and be ready to take complete control whenever necessary. Always keep the safe and legal distance between your vehicle and vehicles up ahead.
- Braking guard works within limits and will not respond outside the system limits, for example when approaching a stopped vehicle or stationary obstacle (end of a traffic jam or vehicle that has broken down in traffic).
- Always remember that the radar sensor for the braking guard works only within defined detection and range limits that

may prevent the proper detection of other vehicles.

- The radar sensor's function and range can be reduced by rain, snow and heavy spray. Moving vehicles up ahead may not be promptly detected or may not be detected at all.
- Reflective surfaces including crash barriers or tunnel entrances may impair the function of the radar sensor.

#### **Tips**

- You can cancel the braking that is initiated by the system by braking yourself, by accelerating noticeably or by swerving.
- Braking guard error messages ⇒ *page 109*.
- Keep in mind that braking guard can brake unexpectedly. Always secure any cargo or objects that you are transporting to reduce the risk of damage or injury.

### Settings in the radio/MMI

Applies to vehicles: with Audi adaptive cruise control

- ▶ Select: **CAR** function button > **Car systems\*** control button > **Driver assist** > **Audi braking guard**. Or
- ▶ Select: **CAR** function button > **Audi braking guard**.

**System** - Switch Audi braking guard **On** and **Off**. When you switch the ignition on, the message **Audi braking guard off** appears if the system is switched off.

**Early warning** - The distance and approach warnings in the display can be switched **On/Off**.

#### **Tips**

- Your settings are automatically stored and assigned to the remote control key being used at the times the settings are made.

<sup>1)</sup> This is not available in some countries.

- If you restrict or switch off the ESC, the braking guard also switches itself off ⇒ *page 187*.
- Switch braking guard off when you are loading the vehicle onto a vehicle carrier, train, ship or other type of transportation. This can prevent undesired warnings from the braking guard system.

## Messages

Applies to vehicles: with Audi adaptive cruise control

### Braking guard: Off

This driver message appears if the system is turned off via the radio/MMI\*. Otherwise, if the system is turned off, the information appears every time shortly after the start of the trip.

The driver message also appears if the system is not available due to a malfunction or if the ESC is not switched on ⇒ *page 187*. If this is the case, the system will not provide warnings about a possible collision.

### Braking guard: Activated

This driver message appears if sharp brake pressure was applied due to an acute warning.

•••

Three white dots appear if a setting cannot be selected with the operating lever. For example, this happens if you want to raise/lower the speed even though there was no previously saved speed.

### ACC: Deactivation

The driver message appears in vehicles with manual transmission. If the clutch pedal was pressed down for too long, the adaptive cruise control turns off. A chime sounds as a reminder.

### ACC: Sensor blocked

This message appears if the sensor view is obstructed, for example by leaves, snow, heavy spray or dirt. Clean the sensor ⇒ *page 101, fig. 113*.

### ACC: not available

The driver message appears if there is a malfunction. The adaptive cruise control turns off. A chime sounds as a reminder. Have the system checked by an authorized Audi dealer or authorized Audi Service Facility.

### ACC: unavailable

The driver message appears if, for example, the brake temperature is too high. The adaptive cruise control is temporarily unavailable. A chime sounds as a reminder.

### Engine speed!

This driver message appears in vehicles with manual transmission if the driver had not upshifted or downshifted in time while using adaptive cruise control braking or accelerating, causing the vehicle to exceed or not reach the permitted limit speed. The adaptive cruise control turns off. A chime sounds as a reminder.

### Shift lever position!

Vehicles with an automatic transmission: the driver message appears if the selector lever is shifted to the N position. The adaptive cruise control is not available while in this position.

Vehicles with manual transmission: the driver message appears for vehicles with manual transmission if there is no forward gear engaged, meaning if the reverse gear or the 1st gear is engaged or if the selector lever is in the neutral position. The adaptive cruise control is not available while in this position.

### Stabilization control (ESC)

This message appears if the electronic stabilization control (ESC) is taking action to stabilize the vehicle. The adaptive cruise control turns off. A chime sounds as a reminder.

### Speed too low

This message appears if the current speed is too low **to set** or **to maintain** the desired speed.

The speed being saved must be at least 20 mph (30 km/h). The cruise control is turned off for speeds lower than 12 mph

(20 km/h). The adaptive cruise control remains turned on for speeds above 95 mph (150 km/h) (override). It will stabilize again at 95 mph (150 km/h) when the driver takes his foot off of the gas pedal.

### **Parking brake!**

The driver message appears when the parking brake is activated. Adaptive cruise control is turned off. A chime sounds as a reminder.

## Audi side assist

### Lane change assistant

#### Description

Applies to vehicles: with Audi side assist

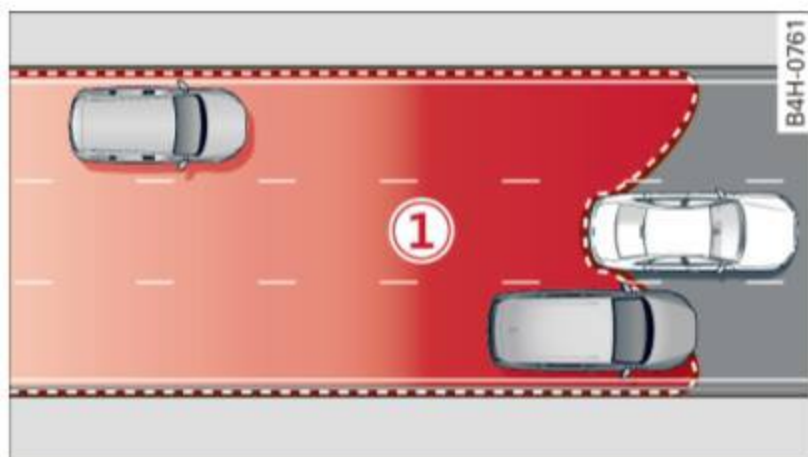

Fig. 124 Sensor detection range



Fig. 125 Display on the exterior mirror

Side assist helps you monitor your blind spot and traffic behind your vehicle. Within the limits of the system, it warns you about vehicles that are coming closer or that are traveling with you within sensor range ① ⇒ fig. 124: if a lane change is classified as critical, the display ② in the exterior mirror ⇒ fig. 125 turns on.

The display in the left exterior mirror provides assistance when making a lane change to the left, while the display in the right exterior mirror provides assistance when making a lane change to the right.

#### Information stage

As long as you do not activate the turn signal, side assist *informs* you about vehicles that are detected and classified as critical. The display in the respective mirror turns on, but is dim.

The display remains dim intentionally in the information stage so that your view toward the front is not disturbed.

#### Warning stage

If you activate the turn signal, side assist *warns* you about vehicles that are detected and classified as critical. The display in the respective mirror blinks brightly. If this happens, check traffic by glancing in the rearview mirror and over your shoulder ⇒ ⚠ in *General information on page 112*.

#### **i** Tips

- You can adjust the brightness of the display ② ⇒ *page 113*.
- Please refer to the instructions for towing a trailer located in ⇒ *page 112*.

## General information

Applies to vehicles: with Audi side assist

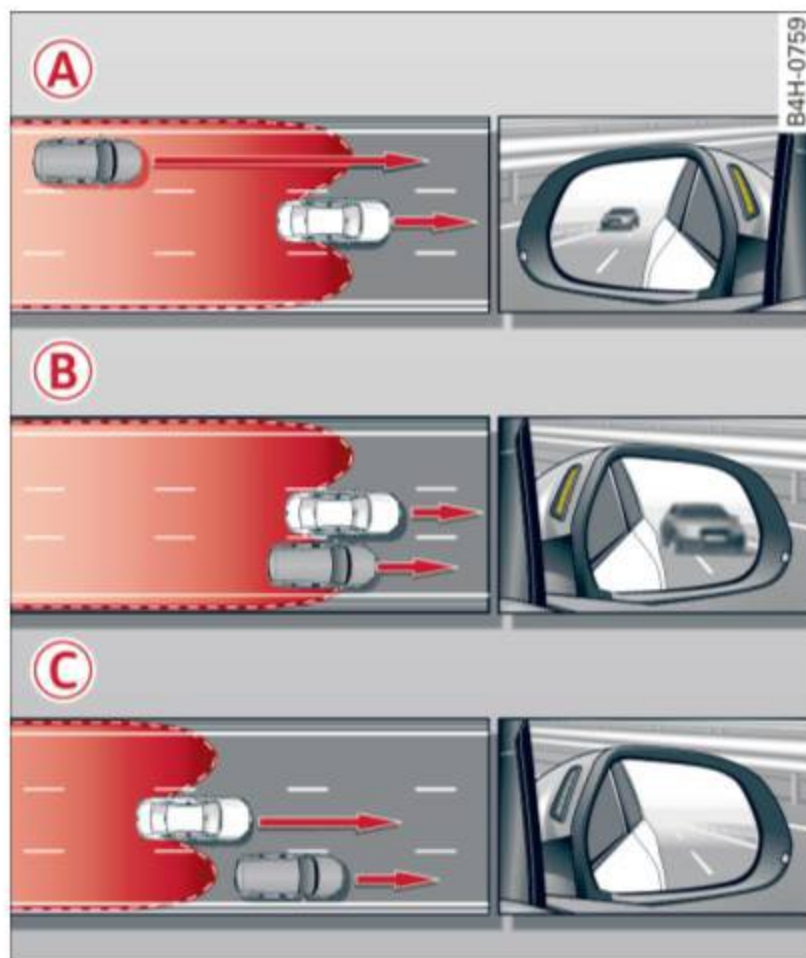

Fig. 126 Driving situations



Fig. 127 Rear of the vehicle: position of the sensors

Side assist functions at speeds above approximately 19 mph (30 km/h).

### A Vehicles that are approaching

In certain cases, a vehicle will be classified as critical for a lane change even if it is still somewhat far away. The faster a vehicle approaches, the sooner the display in the exterior mirror will turn on.

### B Vehicles traveling with you

Vehicles traveling with you are indicated in the exterior mirror if they are classified as critical for a lane change. All vehicles detected by side assist are indicated by the time they enter your “blind spot”, at the latest.

### C Vehicles left behind

If you slowly pass a vehicle that side assist has detected (the difference in speed between the vehicle and your vehicle is less than 9 mph (15 km/h)), the display in the exterior mirror turns on as soon as the vehicle enters your blind spot.

The display will not turn on if you quickly pass a vehicle that side assist has detected (the difference in speed between the vehicle and your vehicle is greater than 9 mph (15 km/h)).

### Functional limitations

The radar sensors are designed to detect the left and right adjacent lanes when the road lanes are the normal width. In certain situations, the display in the exterior mirror may turn on even though there is no vehicle located in the area that is critical for a lane change. For example:

- if the lanes are narrow or if you are driving on the edge of your lane. If this is the case, the system may have detected the vehicle in another lane that is *not* adjacent to your current lane.
- if you are driving through a curve. Side assist may react to a vehicle that is one lane over from the adjacent lane.
- if side assist reacts to other objects (such as high or displaced guard rails).
- In poor weather conditions. The side assist functions are limited.

Do not cover the radar sensors ⇒ *fig. 127* with stickers, deposits, bicycle wheels or other objects, because this will affect the function. Do not use side assist when towing a trailer. For information on cleaning, refer to ⇒ *page 202*.

### ! WARNING

- Always pay attention to traffic and to the area around your vehicle. Side assist cannot replace a driver's attention. The driver alone is always responsible for lane changes and similar driving maneuvers.

- Improper reliance on the side assist system can cause collisions and serious personal injury:
  - Never rely only on side assist when changing lanes.
  - Always check rear view mirrors to make sure that it is safe to change lanes.
- Side assist cannot detect all vehicles under all conditions- danger of accident!
- Please note that side assist indicates there are approaching vehicles, or vehicles in your blind spot, only after your vehicle has reached a driving speed of at least 19 mph (30 km/h).
- In certain situations, the system may not function or its function may be limited. For example:
  - if vehicles are approaching or being left behind very quickly. The display may not turn on in time.
  - in poor weather conditions such as heavy rain, snow or heavy mist.
  - on very wide lanes, in tight curves or if there is a rise in the road surface. Vehicles in the adjacent lane may not be detected because they are outside of the sensor range.

### Note

The sensors can be displaced by impacts or damage to the bumper, wheel housing and underbody. This can affect the system. Have your authorized Audi dealer or authorized Audi Service Facility check their function.

### Tips

- If the window glass in the driver's door or front passenger's door has been tinted, the display in the exterior mirror may be misinterpreted.
- For Declaration of Compliance to United States FCC and Industry Canada regulations ⇒ *page 286*.

## Activating and deactivating

Applies to vehicles: with Audi side assist



Fig. 128 Driver's door: Side assist button

- ▶ Press the button ⇒  in *General information on page 112* to switch the system on/off. The LED in the button turns on when side assist is switched on.

## Adjusting the display brightness

Applies to vehicles: with Audi side assist

*The signal brightness can be set in the radio or MMI\*.*

- ▶ Select: **CAR** function button > **Audi side assist**.
- ▶ Select: **CAR** function button > **Car systems\*** control button > **Driver assist** > **Audi side assist**.

The display brightness adjusts automatically to the brightness of the surroundings, both in the information and in the warning stage. In very dark or very bright surroundings, the display is already set to the minimum or maximum level by the automatic adjustment. In such cases, you may notice no change when adjusting the brightness, or the change may only be noticeable once the surroundings change.

Adjust the brightness to a level where the display in the information stage will not disrupt your view forward. If you change the brightness, the display in the exterior mirror will briefly show the brightness level in the information stage. The brightness of the warning stage is linked to the brightness in the information stage and is adjusted along with the information stage adjustment.

**i** Tips

- Side assist is not active while you are making the adjustment.
- Your settings are automatically stored and assigned to the remote control key being used.

**Driver messages**

Applies to vehicles: with Audi side assist

If side assist switches off by itself, the LED in the button turns off and a message will appear in the instrument cluster display:

**Audi side assist unavailable: Sensors blocked**

The radar sensors' vision is affected. Do not cover the area in front of the sensors with bike wheels, stickers, dirt or other objects. Clean the area in front of the sensors, if necessary  
⇒ *page 112, fig. 127.*

**Audi side assist: Currently unavailable**

Side assist cannot be switched on temporarily because there is a malfunction (for example, the battery charge level may be too low).

**Audi side assist: System fault!**

The system cannot guarantee that it will detect vehicles correctly and it is switched off. The sensors have been displaced or are faulty. Have the system checked by an authorized Audi dealer or authorized Audi Service Facility soon.

**Audi side assist: Unavailable when towing**

Side assist switches off automatically when a factory-installed trailer hitch is connected to the electrical connector on the trailer. There is no guarantee the system will switch off when using a retrofitted trailer hitch. Do not use side assist when towing a trailer.

# Audi drive select

## Driving settings

### Introduction

Applies to vehicles: with Audi drive select

Drive select provides the possibility to experience different types of vehicle settings in one vehicle. For instance, using the three **Comfort**, **Auto** and **Dynamic** modes, the driver can switch from a sporty to a comfortable driving mode with the press of a button.

Additionally, in vehicles with MMI\*, the vehicle setup for **Individual**\* mode can be customized by you. This makes it possible to combine settings such as a sporty engine tuning with comfortable steering.

### WARNING

Improper use of the Audi drive select can cause collisions, other accidents and serious personal injury.

### Description

Applies to vehicles: with Audi drive select

The vehicle setup in each mode depends on the vehicle's features. However, the engine, automatic transmission\* and steering are always involved.

#### Engine and automatic transmission\*

Depending on the mode, the engine and the automatic transmission respond quicker or in a more balanced manner to accelerator pedal movements. In the sporty dynamic mode, the automatic transmission shifts at higher RPMs.

#### Steering

The steering adapts in terms of steering effort and steering ratios. Indirect steering that moves easily, like the steering in comfort mode, is best suited to long drives on a highway. In contrast, dynamic mode provides sporty, direct steering.

The following applies to vehicles with dynamic steering\*: the steering ratio changes based on vehicle speed in order to maintain optimum

steering effort for the driver at all times. This sets the steering to be less sensitive at higher speeds in order to provide improved vehicle control. At reduced speeds, however, steering is more direct in order to keep the steering effort as minimal as possible when the driver is maneuvering the vehicle. At low and average speeds, dynamic steering additionally provides more responsive steering performance.

#### Adaptive dampers\*

The adaptive dampers\* use sensors to record information regarding steering movements, braking and acceleration operations by the driver, road surface, driving speed, and load. This makes it possible to adapt damping to the driving situation virtually in real time. Drive select also makes it possible to satisfy the desire for sporty suspension (Dynamic) and comfortable suspension (Comfort) without giving up balanced tuning (Auto).

#### Sport differential\*

As a component of the all wheel drive system (quattro) ⇨ *page 190*, the sport differential\* distributes the driving power to the rear axle depending on the situation. The distribution of power varies depending on the mode selected. The goal is a high level of agility and ability to accelerate on curves. The vehicle is very responsive to steering.

#### Audi adaptive cruise control\*

The behavior when accelerating can be adjusted from comfortable to sporty, depending on the drive select mode. Adaptive cruise control also responds to the driving behavior of the vehicle ahead in a more conservative or sporty manner.

#### Engine sound\*

The sound of the engine is adapted to the selected mode and ranges from subtle to sporty.

### Tips

- In some models, the maximum vehicle speed can only be reached in the **Auto** and **Dynamic** modes.

- For vehicles with an automatic transmission, selecting the **Dynamic** mode results in sporty shifting characteristics. The S gear position engages automatically.
- In vehicles that have dynamic steering\*, operating noise is heard when starting or stopping the engine. This does not indicate a problem.

### Selecting the driving mode

Applies to vehicles: with Audi drive select

You can choose between **Comfort, Auto, Dynamic and Individual\*** modes.



Fig. 129 Center console: Control for Audi drive select

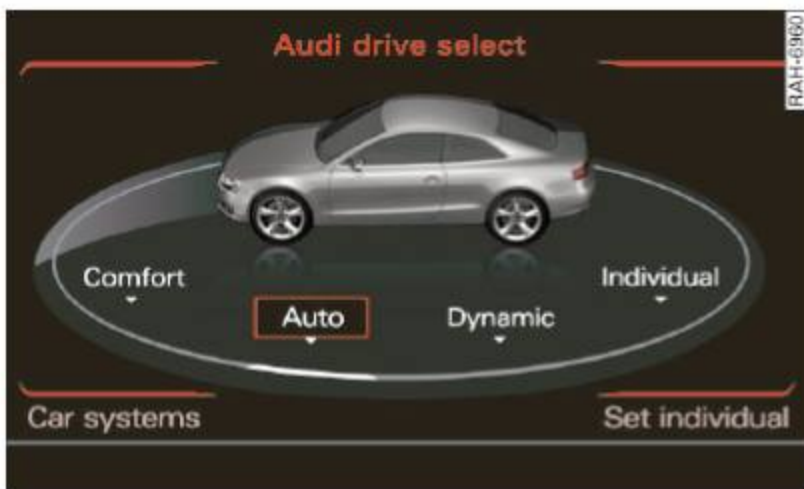

Fig. 130 MMI\*: Audi drive select

- ▶ To set the mode, press the <sup>drive select</sup> button ⇒ *fig. 129* multiple times until the desired mode is displayed in the instrument cluster. Or
- ▶ In the MMI\*, select: **CAR** function button > **Comfort, Auto, Dynamic or Individual\***.

In vehicles without the MMI\*, the <sup>drive select</sup> button is found underneath the shift/selector lever.

You can change the driving mode when the vehicle is stationary or while driving. If traffic permits, after changing modes, briefly take your foot off the accelerator pedal so that the recently selected mode is also activated for the engine and transmission.

**Comfort** - provides a comfort-oriented vehicle setup and is suited for long drives on highways.

**Auto** - provides an overall comfortable yet dynamic driving feel and is suited for every day use.

**Dynamic** - gives the driver a sporty driving feel and is suited to a sporty driving style.

**Individual\*** - ⇒ *page 116*.

#### WARNING

Pay attention to traffic when operating drive select to prevent potential risk of an accident.

### Adjusting the Individual mode

Applies to vehicles: with MMI and Audi drive select

You can personally specify the vehicle setup in the MMI\*.

- ▶ Select the **CAR** function button > **Set individual** control button. Once you select the menu, you will automatically drive in the **individual** mode.

The equipment in your vehicle will determine which settings you can adjust. The following table provides an overview of the characteristics of each driving mode.

Systems	Comfort	Auto	Dynamic
Engine/Transmission	balanced	balanced	sporty
Steering	comfortable	balanced	sporty

Systems	Comfort	Auto	Dynamic
Dynamic steering*	comfortable/indirect	balanced/direct	sporty/direct
Adaptive dampers*	comfortable	balanced	sporty
Sport differential*	balanced	agile	sporty
Adaptive cruise control*	comfortable	balanced	sporty
Engine sound*	subtle	subtle/sporty <sup>a)</sup>	sporty

a) Subtle in the driving position D and sporty in the driving position S.

### Tips

Your **Individual\*** mode settings are automatically stored and assigned to the remote control key being used.

## Park assist

### Parking system

Applies to vehicles: with parking system

*Different park assist systems may be used for parking or maneuvering, depending on the vehicle's features.*

#### Parking system (rear)\*:

For the *parking system (rear)*, the acoustic park assist system is installed in the rear of the vehicle ⇒ *page 118*.

The rear parking assist system uses ultrasonic sensors to determine the distance of the vehicle from a detected obstacle. There are a total of four sensors located on the rear bumper (two in the middle and two on the sides).

#### Parking system (rear, with rear view camera)\*:

For the *parking system (rear, with rear view camera)*, the rear acoustic park assist system is integrated in the rear of the vehicle and the rear view camera is integrated in the rear lid ⇒ *page 121*.

The *parking system (rear, with rear view camera)* uses ultrasonic sensors to determine the distance of the vehicle from a detected obstacle. There are a total of four sensors located on the rear bumper (two in the middle and two on the sides).

#### WARNING

Make sure the sensors are not covered by stickers, deposits or any other obstructions as it may impair the sensor function. For information on cleaning, refer to ⇒ *page 202*.

## Parking system (rear)

### Rear acoustic park assist

Applies to vehicles: with parking system (rear)

*The rear acoustic park assist warns you of obstacles or objects behind your car.*

#### Description

The rear acoustic parking assist system determines the distance of the vehicle from an obstacle using ultrasonic sensors. There are 4 sensors in the rear bumper.

The range at which the sensors start to measure is **about**:

To the side	2 ft (0.60 m)
Center rear	5.2 ft (1.60 m)

#### Activation

Acoustic parking assist is activated automatically when **reverse gear** is engaged. A brief tone confirms that the system is activated.

#### Warning tones

Distance warning is given by warning tones which are generated by the rear signal generator. The volume and the pitch of the warning tones can be adjusted in the MMI\* ⇒ *page 119*.

#### Reversing

Distance warning when reversing starts when an obstacle is detected in the range of the parking assist system. As the distance decreases, the time interval between the audible tones becomes shorter.

When the distance is less than 1ft (0.30 m), the tone becomes continuous. At this point you should stop backing up.

Please note that low objects already signalled by a warning can disappear from the system's detection range and will not continue to be signalled.

If the distance to an obstacle remains the same, the volume of the distance warning is gradually reduced after about 4 seconds (this does not apply in the continuous tone range). ►

Approaching another obstacle will result in the distance warning sounding at the normal volume again.

### Malfunctions in the system

If a warning tone is audible for about five seconds when you turn on the ignition, there is a malfunction in the system. Have the problem corrected by your authorized Audi dealer.

Keep the sensors in the rear bumper clean and free from ice so that the acoustic park assist system can function properly.

#### WARNING

- Sensors have dead spaces in which objects cannot be detected. Be especially alert for small children and animals, since they are not always detected by the sensors.
- The acoustic parking system is not a substitute for the driver's own caution and alertness. Ultimate responsibility always remains with the driver during parking and similar maneuvers. Always watch where you are driving.
- You should always adjust the volume and frequency of the warning tones so that you can easily hear the acoustic distance warning even if the radio is playing, the air-conditioner blower is on High or there is a high level of outside noise.
- Check the settings whenever anyone else has driven the vehicle before you.

#### Note

- Remember that low obstacles for which a warning has already been issued may “dive” below the system's sensing zone if the vehicle is being backed up closer. In this case, the warning sound shutting off does **not** indicate that you have cleared the obstacle. Instead, impact is imminent.
- Objects such as trailer hitches, chains, narrow posts or fences covered by a thin layer of paint may not always be detect-

ed by the system. They can still damage your vehicle without warning.

#### Tips

Keep the sensors in the rear bumper clean and free of snow and ice so that the acoustic parking assist system can function properly.

### Adjusting the warning tones

Applies to vehicles: with parking system (rear)

*The warning tones can be adjusted in the MMI\*.*

- ▶ Select: **CAR** function button > **Parking system**. Or
  - ▶ Select: **CAR** function button > **Car systems\*** control button > **Driver assist** > **Parking aid**.
- **Rear volume** - rear sensor volume
  - **Rear frequency** - rear sensor frequency
  - **Music volume while parking** - when the parking system is switched on, the volume of the active audio source is lowered.

The newly adjusted value is briefly heard from the signal generator. The settings are automatically stored and assigned to the master key with remote control.

## Parking system (rear, with rear view camera)

### Introduction

Applies to vehicles: with parking system (rear, with rear view camera)

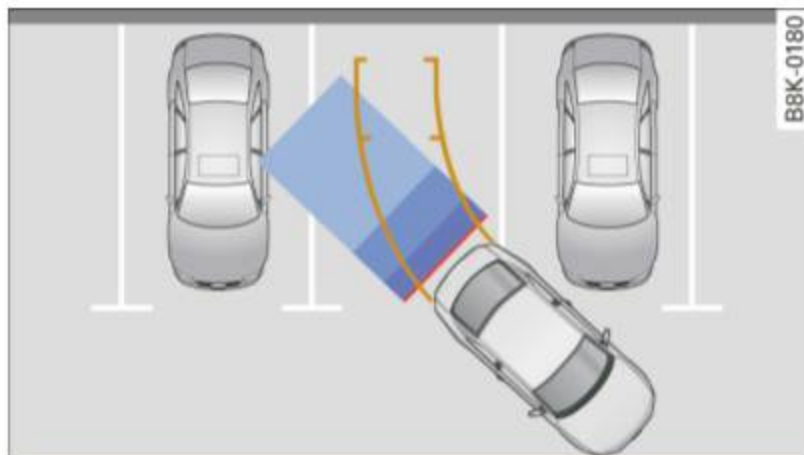

Fig. 131 Parking mode 1: reverse parking

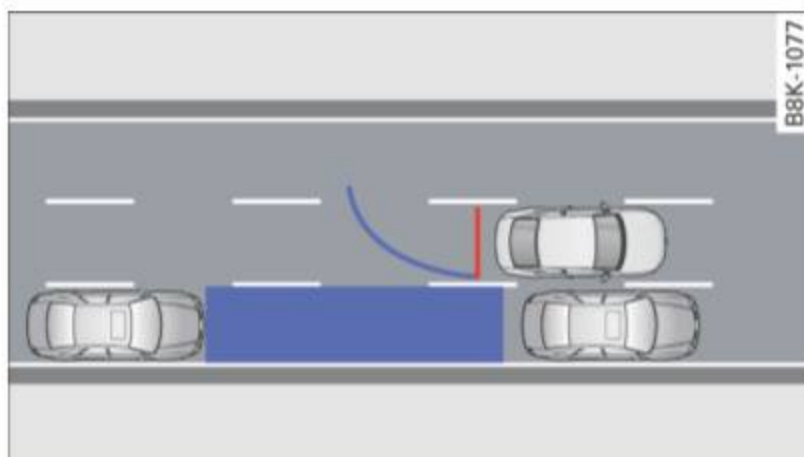

Fig. 132 Parking mode 2: parallel parking

Vehicles with the parking system are equipped with a **rear view camera** in addition to the acoustic parking system.

You can choose between two modes to assist you with parking. For example, you can use “parking mode 1” when parking in a parking space or garage ⇒ *fig. 131*. When you want to park parallel to the edge of the street, select “parking mode 2” ⇒ *fig. 132*.

The rear acoustic park assist system is integrated in the rear of the vehicle and the rear view camera is integrated in the rear lid ⇒ *page 121*.

### WARNING

- The rear view camera has blind spots, in which objects cannot be detected. Be especially careful to check for small children and animals before backing up. Small children and animals will not always be detected by the sensors.

### General Information

Applies to vehicles: with parking system (rear, with rear view camera)



Fig. 133 Covered area ① and uncovered area ② of the rear view camera



Fig. 134 Trunk lid: Location of the rear view camera

### Sensors in the bumper

Sensors are located in the rear bumpers. If these detect an obstacle, audible signals warn you. The range at which the sensors begin to measure is approximately:

To the side	2 ft (0.60 m)
Center rear	5.2 ft (1.60 m)

Distance warning when reversing starts when an obstacle is detected in the range of the parking assist system. As the distance decreases, the time interval between the audible tones becomes shorter.

When the distance is less than 1ft (0.30 m), the tone becomes continuous. At this point you should stop backing up.

If the distance to an obstacle stays the same, the volume of the distance signal chime is gradually reduced after about 4 seconds (does ►

not affect the continuous signal tone). Approaching another obstacle will cause the distance signal to sound again at the normal volume.

### Rear view camera coverage area

The MMI display shows the area covered by the rear view camera ⇒ *fig. 133* ①. Objects that are not in the area covered ② are not shown on the MMI display.

We recommend that you practice parking with the rear view camera in a traffic-free location or parking lot to become familiar with the system, the orientation lines, and their function. When doing this, there should be good light and weather conditions.

In the MMI display, objects or vehicles appear closer or further away if:

- you are driving in reverse gear from a level surface onto an incline, or a downward slope,
- you are driving in reverse gear toward protruding objects,
- the vehicle is carrying too much load in the rear.

The accuracy of the orientation lines and blue surfaces diminishes if:

- the rear view camera does not provide a reliable image, for example, in poor visibility conditions or if the lens is dirty,
- the image on the screen is not visible due to sun glare and reflection.

### Caring for the rear view camera lens

The rear view camera is located above the rear license plate bracket. For the parking assist to operate, the lens ⇒ *fig. 134* must be kept clean:

- Dampen the lens with a household alcohol-based glass cleaner, and clean the lens with a dry cloth ⇒ ⚠.
- Remove snow with a hand brush and ice preferably with a de-icing spray ⇒ ⚠.

### ⚠ WARNING

- The parking aid cannot replace the driver's attention. The driver alone is responsible for parking and similar driving maneuvers.
- Always keep your eyes on the vehicle's surroundings, using the rear view mirror as well.
- Do not allow yourself to be distracted from traffic by the rear view camera pictures.
- If the position and the installation angle of the camera has changed, for example, after a rear end collision, do not continue to use the system for safety reasons. Have it checked by a qualified dealership.

### ⚠ Note

- Low obstacles already signaled by a warning can disappear from the system's detection range as they are approached and will not continue to be signaled. Objects such as barrier chains, trailer draw bars, thin painted vertical poles or fences may not be detected by the system, posing risk of damage.
- Never use warm or hot water to remove snow or ice from the rear view camera lens - danger of crack formation on the lens!
- When cleaning the lens, never use products that are abrasive.

### Switching on/off

Applies to vehicles: with parking system (rear, with rear view camera)

*The rear view camera switches on automatically together with the acoustic park assist when you put the vehicle in reverse.*

### Switching on

- ▶ Put the vehicle in reverse gear, the acoustic parking system with rear view camera is activated automatically. Activation of the acoustic parking system is confirmed by a brief acknowledgement sound. ▶

### Switching off

- ▶ Drive faster than 9 mph (15 km/h), or
- ▶ take the vehicle out of reverse gear. The acoustic parking system is immediately deactivated, and the rear view camera picture is deactivated automatically after a period of about 15 seconds, or
- ▶ switch off the ignition.

The delay in deactivating the camera provides an uninterrupted view behind the vehicle especially when maneuvering in tight parking spaces and prevents the picture from turning off the every time you shift out of reverse.

If the warning message appears in the display but not the rear view camera picture, read and confirm the warning message. The acoustic distance signal is always active.

If you press a function button on the MMI control console, the rear view camera picture disappears. The rear view camera picture reappears the next time you park.

Further information on the warning message and the MMI control console can be found in the MMI instruction booklet.

#### WARNING

- Only use the rearview camera to assist you if it shows a good, clear picture. For example, the image may be affected by the sun shining into the lens, dirt on the lens or if there is a defect.
- Use the rearview camera only with the rear lid completely closed. Make sure any objects you may have mounted on the rear lid do not block the rearview camera.

#### Tips

- The rear view camera picture is available as soon as the MMI Display or the MMI is switched on, or the start-up phase is completed.
- The sensors must be kept clean and free of snow and ice for the park assist to operate.

- You can change the volume and pitch of the signals as well as the display  
⇒ page 124.
- What appears in the display is time-delayed.

### Reverse Parking

Applies to vehicles: with parking system (rear, with rear view camera)

*Parking mode 1 can be used when parking in a garage or parking space.*

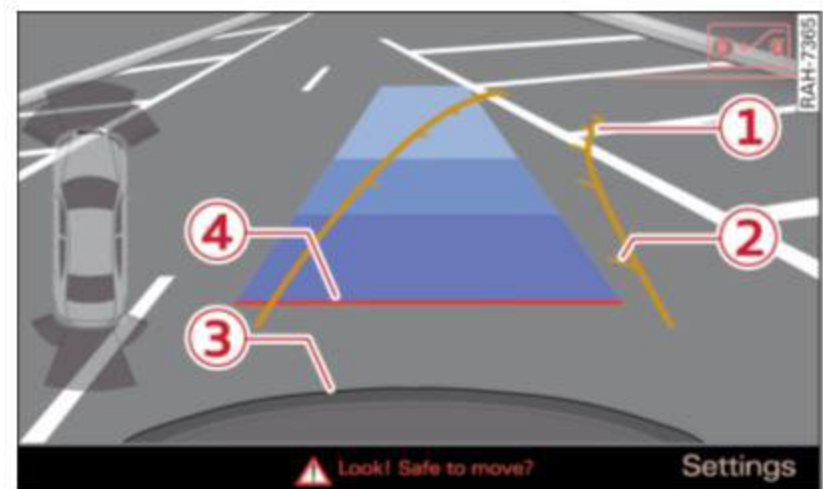

Fig. 135 MMI Display: Aiming at a parking spot

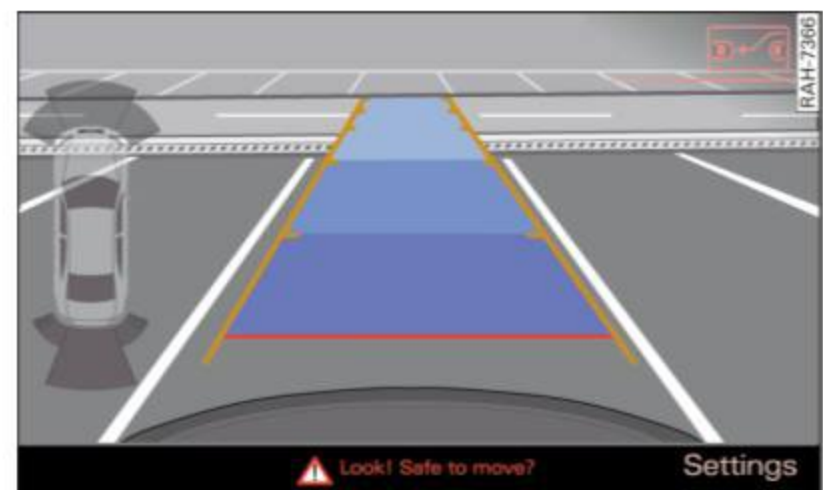



Fig. 136 MMI Display: Aligning the vehicle

- ▶ Switch the MMI on and select the reverse gear.
- ▶ Turn the steering wheel until the orange orientation lines ① appear in the parking spot ⇒ fig. 135. Use the markings ② to help you estimate the distance from an obstacle. Each marking corresponds to 3 ft (1 m). The blue area represents an extension of the vehicle's outline by approximately 16 ft (5 m) to the rear.
- ▶ While driving in reverse gear, adjust the steering wheel angle to fit the parking space with the aid of the orange orientation lines ⇒ . ③ marks the rear bumper. You should stop driving in reverse as soon as and no

later than when the red orientation line ④ abuts an object ⇒ ⚠!

### ⚠ WARNING

- The rear view camera does not show the entire area behind the vehicle ⇒ *page 120, fig. 133*. Watch out especially for small children and animals. The rear view camera cannot always detect them, posing risk of an accident!
- Please note that objects not touching the ground can appear to be further away than they really are (for example, the bumper of a parked vehicle, a trailer hitch, or the rear of a truck). In this case, you should not use the help lines to help with parking, which poses danger of an accident!

### ! Note

- Low obstacles already signaled by a warning can disappear from the system's detection range as they are approached and will not continue to be signaled. Objects such as barrier chains, trailer draw bars, thin painted vertical poles or fences may not be detected by the system, posing risk of damage.
- In the MMI display, the direction of travel of the vehicle rear is represented depending on the steering wheel angle. The vehicle front swings out more than the vehicle rear. Maintain plenty of distance from an obstacle so that your outside mirror or a corner of your vehicle does not collide with any obstacles - danger of accident!

### Parallel Parking

Applies to vehicles: with parking system (rear, with rear view camera)

*Use parking mode 2 to help you park on the edge of a street.*

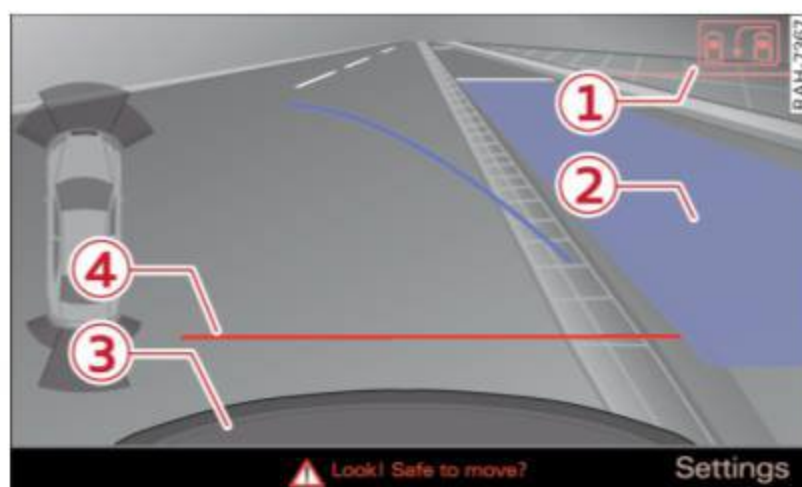

Fig. 137 MMI Display: blue surface in the parking spot

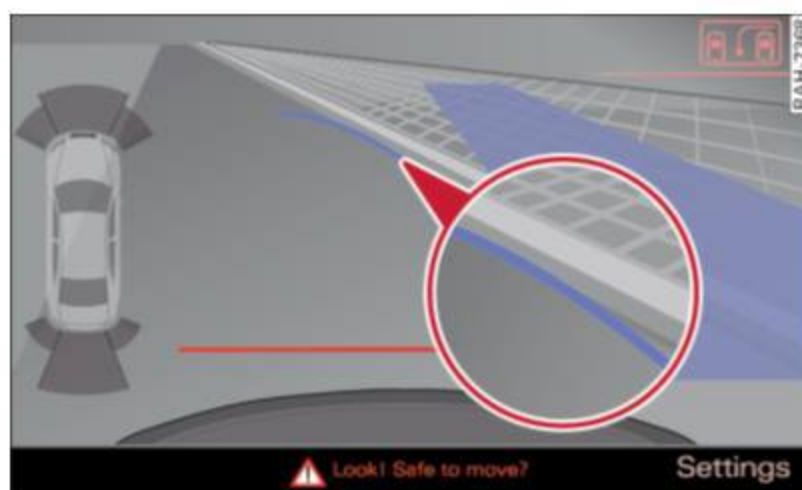

Fig. 138 MMI Display: Blue curve on the curb

The following steps apply only when there is no obstacle (such as a wall) near the parking spot. Otherwise, please read the “Tips on Parking Next to Obstacles” ⇒ *page 124*.

- ▶ Activate the turn signal.
- ▶ Position your vehicle parallel to the edge of the street, approximately 3 ft (1 m) from a parked vehicle.
- ▶ Switch the MMI on and select the reverse gear. The parking aid turns on and parking mode 1 appears on the display.
- ▶ Press the **Mode** ⇒ *fig. 137* ① control button on the MMI control console. Parking mode 2 appears.
- ▶ Back up in reverse gear and align your vehicle so that the blue area ② borders on the rear end of the vehicle or on the parking spot line. The blue area represents an extension of the vehicle's outline by approximately 16 ft (5 m) to the rear. The long side of

the blue area should be on the curb. The entire blue area must fit into the parking spot.

- ▶ While the vehicle is stationary, turn the steering wheel to the right as far as it will go.
- ▶ Back into the parking spot. Stop the vehicle as soon as the blue curve touches the curb ⇒ *fig. 138*.
- ▶ While the vehicle is stationary, turn the steering wheel to the left as far as it will go.
- ▶ Continue to back up into the parking spot until the vehicle is parked parallel to the curb. ③ marks the rear bumper. You should stop driving in reverse as soon as and no later than when the red orientation line ④ abuts an object ⇒ ⚠! Keep an eye on the front of your vehicle while doing this ⇒ ⚠!

### Parking next to obstacles

When there is an obstacle (such as a wall) next to the parking spot, choose a spot with more space on the sides. Position the long side of the blue area so that there is sufficient space from the curb. The area must not be on the curb. You will also need to start turning the steering wheel much earlier. There should be a sufficient amount of space between the curb and the blue curve, and the blue curve ⇒ *fig. 138* must **not** touch the curb.

#### WARNING

- The rear view camera does not show the entire area behind the vehicle ⇒ *page 120, fig. 133*. Watch out especially for small children and animals. The rear view camera cannot always detect them, posing risk of an accident!
- Please note that objects not touching the ground can appear to be further away than they really are (for example, the bumper of a parked vehicle, a trailer hitch, or the rear of a truck). In this case, you should not use the help lines to help with parking, which poses danger of an accident!

#### Note

In the MMI display, the direction of travel of the vehicle rear is represented depending on the steering wheel angle. The vehicle front swings out more than the vehicle rear. Maintain plenty of distance from an obstacle so that your outside mirror or a corner of your vehicle does not collide with any obstacles - danger of accident!

#### Tips

The left or right orientation lines and surfaces will be displayed, depending on the turn signal being used.

### Adjusting the display and warning tones

Applies to vehicles: with parking system (rear, with rear view camera)

*The display and warning tones are adjusted in the radio or MMI\*.*

- ▶ Select: **CAR** function button > **Parking system**. Or
- ▶ Select: **CAR** function button > **Car systems\*** control button > **Driver assist** > **Parking aid**.

#### Display

- **Off** - when the parking system is switched on, only audible signals are given.
- **On** - when the parking system is switched on, the picture from the rear view camera is displayed.

#### Warning tones

- **Rear volume** - rear sensor volume
- **Rear frequency** - rear sensor frequency
- **Music volume while parking** - when the parking system is switched on, the volume of the active audio source is lowered.

The newly adjusted value is briefly heard from the signal generator. The settings are automatically stored and assigned to the remote control key. ▶

**! WARNING**

- Always make sure that the volume and frequency of the warning tones is adjusted so that you can easily hear the acoustic distance signal even if the radio is playing, the air-conditioner blower is on High or there is a high level of outside noise.
- Check the settings whenever someone else has driven the vehicle before you.

**i Tips**

- The warning tones can also be adjusted directly from the rear view camera image. Simply press the Settings\* control button.
- Changed settings are activated when parking assist is switched on again.

**Error messages**

Applies to vehicles: with parking system (rear, with rear view camera)

If a warning tone is audible for about five seconds when you turn on the ignition, there is a malfunction in the system. Have the problem corrected by your authorized Audi dealer.

Keep the sensors in the rear bumper clean and free from ice so that the acoustic park assist system can function properly.

## Driving Safely

### General notes

#### Safe driving habits

*Please remember - safety first!*

This chapter contains important information, tips, instructions and warnings that you need to read and observe for your own safety, the safety of your passengers and others. We have summarized here what you need to know about safety belts, airbags, child restraints as well as child safety. Your safety is for us *priority number 1*. Always observe the information and warnings in this section - for your own safety as well as that of your passengers.

The information in this section applies to all model versions of your vehicle. Some of the features described in this sections may be standard equipment on some models, or may be optional equipment on others. If you are not sure, ask your authorized Audi dealer.

#### WARNING

- Always make sure that you follow the instructions and heed the WARNINGS in this Manual. It is in your interest and in the interest of your passengers.
- Always keep the complete Owner's Literature in your Audi when you lend or sell your vehicle so that this important information will always be available to the driver and passengers.
- Always keep the Owner's literature handy so that you can find it easily if you have questions.

#### Safety equipment

*The safety features are part of the occupant restraint system and work together to help reduce the risk of injury in a wide variety of accident situations.*

Your safety and the safety of your passengers should not be left to chance. Advances in technology have made a variety of features available to help reduce the risk of injury in an

accident. The following is a list of just a few of the safety features in your Audi:

- sophisticated safety belts for driver and all passenger seating positions,
- belt force limiters for the front seats,
- belt pretensioners for the seats,
- head restraints for each seating position,
- front airbags,
- side airbags in the front seats,
- side curtain airbags,
- special LATCH anchorages for child restraints,
- adjustable steering column.

These individual safety features, can work together as a system to help protect you and your passengers in a wide range of accidents. These features cannot work as a system if they are not always correctly adjusted and correctly used.

#### Safety is everybody's responsibility!

#### Important things to do before driving

*Safety is everybody's job! Vehicle and occupant safety always depends on the informed and careful driver.*

For your safety and the safety of your passengers, **before driving always:**

- ▶ Make sure that all lights and signals are operating correctly.
- ▶ Make sure that the tire pressure is correct.
- ▶ Make sure that all windows are clean and afford good visibility to the outside.
- ▶ Secure all luggage and other items carefully ⇒ *page 66*.
- ▶ Make sure that nothing can interfere with the pedals.
- ▶ Adjust front seat, head restraint and mirrors correctly for your height.
- ▶ Instruct rear seat passengers to adjust the head restraints according to their height.
- ▶ Make sure to use the right child restraint correctly to protect children ⇒ *page 165, Child Safety*.

- ▶ Sit properly in your seat and make sure that your passengers do the same ⇒ *page 60, Seats and storage.*
- ▶ Fasten your safety belt and wear it properly. Also instruct your passengers to fasten their safety belts properly ⇒ *page 136.*

### What impairs driving safety?

Safe driving is directly related to the condition of the vehicle, the driver as well as the driver's ability to concentrate on the road without being distracted.

The driver is responsible for the safety of the vehicle and all of its occupants. If your ability to drive is impaired, safety risks for everybody in the vehicle increase and you also become a hazard to everyone else on the road ⇒ ⚠.

Therefore:

- ▶ Do not let yourself be distracted by passengers or by using a cellular telephone.
- ▶ NEVER drive when your driving ability is impaired (by medications, alcohol, drugs, etc.).
- ▶ Observe all traffic laws, rules of the road and speed limits and plain common sense.
- ▶ ALWAYS adjust your speed to road, traffic and weather conditions.
- ▶ Take frequent breaks on long trips. Do not drive for more than two hours at a stretch.
- ▶ Do NOT drive when you are tired, under pressure or when you are stressed.

### ⚠ WARNING

Impaired driving safety increases the risk of serious personal injury and death whenever a vehicle is being used.

## Proper occupant seating positions

### Proper seating position for the driver

The proper driver seating position is important for safe, relaxed driving.

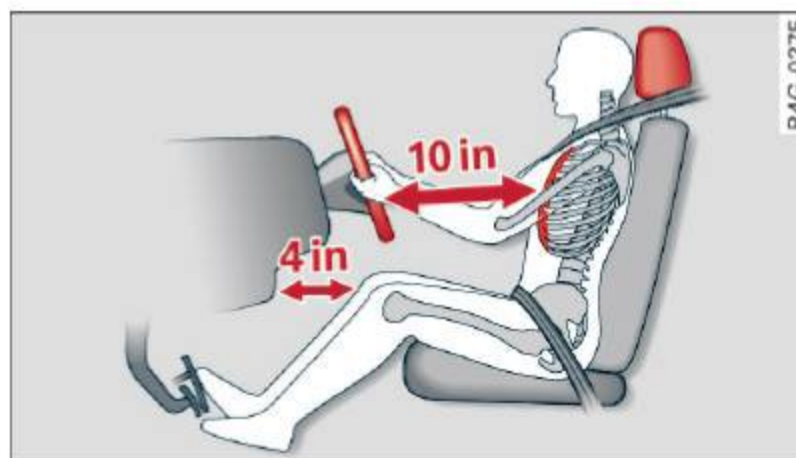

Fig. 139 Correct seating position

For your own safety and to reduce the risk of injury in the event of an accident, we recommend that you adjust the driver's seat to the following position:

- ▶ Adjust the driver's seat so that you can easily push the pedals all the way to the floor while keeping your knee(s) slightly bent ⇒ ⚠.
- ▶ Adjust the angle of the seatback so that it is in an upright position so that your back comes in full contact with it when you drive.
- ▶ Adjust the steering wheel so that there is a distance of at least 10 inches (25 cm) between the steering wheel and your breast bone ⇒ *fig. 139*. If not possible, see your authorized Audi dealer about adaptive equipment.
- ▶ Adjust the steering wheel so that the steering wheel and airbag cover points at your chest and not at your face.
- ▶ Grasp the top of the steering wheel with your elbow(s) slightly bent.
- ▶ Applies to vehicles with adjustable head restraints: Adjust the head restraint so the upper edge is as even as possible with the top of your head. If that is not possible, try to adjust the head restraint so that it is as close to this position as possible.
- ▶ Fasten and wear safety belts correctly ⇒ *page 139.*

- ▶ Always keep both feet in the footwell so that you are in control of the vehicle at all times.

For detailed information on how to adjust the driver's seat, see ⇒ *page 62*.

### **WARNING**

Drivers who are unbelted, out of position or too close to the airbag can be seriously injured by an airbag as it unfolds. To help reduce the risk of serious personal injury:

- Always adjust the driver's seat and the steering wheel so that there are at least 10 inches (25 cm) between your breastbone and the steering wheel.
- Always hold the steering wheel on the outside of the steering wheel rim with your hands at the 9 o'clock and 3 o'clock positions to help reduce the risk of personal injury if the driver's airbag inflates.
- Never hold the steering wheel at the 12 o'clock position or with your hands at other positions inside the steering wheel rim or on the steering wheel hub. Holding the steering wheel the wrong way can cause serious injuries to the hands, arms and head if the driver's airbag deploys.
- Pointing the steering wheel toward your face decreases the ability of the supplemental driver's airbag to protect you in a collision.
- Always sit in an upright position and never lean against or place any part of your body too close to the area where the airbags are located.
- Before driving, always adjust the front seats and head restraints properly and make sure that all passengers are properly restrained.
- Never adjust the seats while the vehicle is moving. Your seat may move unexpectedly and you could lose control of the vehicle.
- Never drive with the backrest reclined or tilted far back! The farther the backrests are tilted back, the greater the risk of in-

jury due to incorrect positioning of the safety belt and improper seating position.

- Children must always ride in child safety seats ⇒ *page 165*. Special precautions apply when installing a child safety seat on the front passenger seat ⇒ *page 144*.

### **Proper seating position for the front passenger**

*The proper front passenger seating position is important for safe, relaxed driving.*

For your own safety and to reduce the risk of injury in the event of an accident, we recommend that you adjust the seat for the front passenger to the following position:

- ▶ Move the front passenger seat back as far as possible. There must be a minimum of 10 inches (25 cm) between the breastbone and the instrument panel ⇒ .
- ▶ Adjust the angle of the seatback so that it is in an upright position and your back comes in full contact with it whenever the vehicle is moving.
- ▶ Applies to vehicles with adjustable head restraints: Adjust the head restraint so the upper edge is as even as possible with the top of your head. If that is not possible, try to adjust the head restraint so that it is as close to this position as possible.
- ▶ Keep both feet flat on the floor in front of the front passenger seat.
- ▶ Fasten and wear safety belts correctly ⇒ *page 139*.

For detailed information on how to adjust the front passenger's seat, see ⇒ *page 60*.

### **WARNING**

Front seat passengers who are unbelted, out of position or too close to the airbag can be seriously injured or killed by the airbag as it unfolds. To help reduce the risk of serious personal injury:

- Passengers must always sit in an upright position and never lean against or place any part of their body too close to the area where the airbags are located.
- Passengers who are unbelted, out of position or too close to the airbag can be seriously injured by an airbag as it unfolds with great force in the blink of an eye.
- Always make sure that there are at least 10 inches (25 cm) between the front passenger's breastbone and the instrument panel.
- Each passenger must always sit on a seat of their own and properly fasten and wear the safety belt belonging to that seat.
- Before driving, always adjust the front passenger seat and head restraint properly.
- Always keep your feet on the floor in front of the seat. Never rest them on the seat, instrument panel, out of the window, etc. The airbag system and safety belt will not be able to protect you properly and can even increase the risk of injury in a crash.
- Never drive with the backrest reclined or tilted far back! The farther the backrests are tilted back, the greater the risk of injury due to incorrect positioning of the safety belt and improper seating position.
- Children must always ride in child safety seats ⇒ *page 165*. Special precautions apply when installing a child safety seat on the front passenger seat ⇒ *page 144*.

### Proper seating positions for passengers in rear seats

*Rear seat passengers must sit upright with both feet on the floor consistent with their physical size and be properly restrained whenever the vehicle is in use.*

To reduce the risk of injury caused by an incorrect seating position in the event of a sudden braking maneuver or an accident, your pas-

sengers on the rear bench seat must always observe the following:

- ▶ Make sure that the seatback is securely latched in the upright position ⇒ *page 71*.
- ▶ If there is a passenger on the rear center seating position, slide the center head restraint upward at least to the next notch.
- ▶ Keep both feet flat in the footwell in front of the rear seat.
- ▶ Fasten and wear safety belts properly ⇒ *page 139*.
- ▶ Make sure that children are always properly restrained in a child restraint that is appropriate for their size and age ⇒ *page 165*.



#### WARNING

Passengers who are improperly seated on the rear seat can be seriously injured in a crash.

- Each passenger must always sit on a seat of their own and properly fasten and wear the safety belt belonging to that seat.
- Safety belts only offer maximum protection when the seatback is securely latched in the upright position and the safety belts are properly positioned on the body. By not sitting upright, a rear seat passenger increases the risk of personal injury from improperly positioned safety belts!
- Always adjust the head restraint properly so that it can give maximum protection.

### Proper adjustment of head restraints

Applies to vehicles: with adjustable head restraints

*Correctly adjusted head restraints are an important part of your vehicle's occupant restraint system and can help to reduce the risk of injuries in accident situations.*



Fig. 140 Head restraint: viewed from the front

The head restraints must be correctly adjusted to achieve the best protection.

- ▶ Adjust the head restraints so the upper edge is as even as possible with the top of your head. If that is not possible, try to adjust the head restraint so that it is as close to this position as possible ⇒ *fig. 140*.
- ▶ If there is a passenger on the rear center seating position, slide the center head restraint upward at least to the next notch.

Adjusting head restraints ⇒ *page 63*.

#### WARNING

All seats are equipped with head restraints. Driving without head restraints or with head restraints that are not properly adjusted increases the risk of serious or fatal neck injury dramatically. To help reduce the risk of injury:

- Always drive with the head restraints in place and properly adjusted.
- Every person in the vehicle must have a properly adjusted head restraint.
- Always make sure each person in the vehicle properly adjusts their head restraint. Adjust the head restraints so the upper edge is as even as possible with the top of your head. If that is not possible, try to adjust the head restraint so

that it is as close to this position as possible.

- Never attempt to adjust head restraint while driving. If you have driven off and must adjust the driver headrest for any reason, first stop the vehicle safely before attempting to adjust the head restraint.
- Children must always be properly restrained in a child restraint that is appropriate for their age and size ⇒ *page 165*.

### Examples of improper seating positions

*The occupant restraint system can only reduce the risk of injury if vehicle occupants are properly seated.*

Improper seating positions can cause serious injury or death. Safety belts can only work when they are properly positioned on the body. Improper seating positions reduce the effectiveness of safety belts and will even increase the risk of injury and death by moving the safety belt to critical areas of the body. Improper seating positions also increase the risk of serious injury and death when an airbag deploys and strikes an occupant who is not in the proper seating position. A driver is responsible for the safety of all vehicle occupants and especially for children. Therefore:

- ▶ Never allow anyone to assume an incorrect seating position when the vehicle is being used ⇒ .

The following bulletins list only some sample positions that will increase the risk of serious injury and death. Our hope is that these examples will make you more aware of seating positions that are dangerous.

#### **Therefore, whenever the vehicle is moving:**

- never stand up in the vehicle
- never stand on the seats
- never kneel on the seats
- never ride with the seatback reclined
- never lie down on the rear seat
- never lean up against the instrument panel ►

- never sit on the edge of the seat
- never sit sideways
- never lean out the window
- never put your feet out the window
- never put your feet on the instrument panel
- never rest your feet on the seat cushion or back of the seat
- never ride in the footwell
- never ride in the cargo area

### WARNING

Improper seating positions increase the risk of serious personal injury and death whenever a vehicle is being used.

- Always make sure that all vehicle occupants stay in a proper seating position and are properly restrained whenever the vehicle is being used.

## Pedal area

### Pedals

*The pedals must always be free to move and must never be interfered with by a floor mat or any other object.*

Make sure that all pedals move freely without interference and that nothing prevents them from returning to their original positions.

Only use floor mats that leave the pedal area free and can be secured with floor mat fasteners.

If a brake circuit fails, increased brake pedal travel is required to bring the vehicle to a full stop.

### WARNING

Pedals that cannot move freely can cause loss of vehicle control and increase the risk of serious injury.

- Never place any objects in the driver's footwell. An object could get into the pedal area and interfere with pedal function. In case of sudden braking or an accident, you would not be able to brake or accelerate!

- Always make sure that nothing can fall or move into the driver's footwell.

### Floor mats on the driver side

*Always use floor mats that can be securely attached to the floor mat fasteners and do not interfere with the free movement of the pedals.*

- ▶ Make sure that the floor mats are properly secured and cannot move and interfere with the pedals ⇒ .

Use only floor mats that leave the pedal area unobstructed and that are firmly secured so that they cannot slip out of position. You can obtain suitable floor mats from your authorized Audi dealer.

Floor mat fasteners are installed in your Audi.

Floor mats used in your vehicle must be attached to these fasteners. Properly securing the floor mats will prevent them from sliding into positions that could interfere with the pedals or impair safe operation of your vehicle in other ways.

### WARNING

Pedals that cannot move freely can result in a loss of vehicle control and increase the risk of serious personal injury.

- Always make sure that floor mats are properly secured.
- Never place or install floor mats or other floor coverings in the vehicle that cannot be properly secured in place to prevent them from slipping and interfering with the pedals or the ability to control the vehicle.
- Never place or install floor mats or other floor coverings on top of already installed floor mats. Additional floor mats and other coverings will reduce the size of the pedal area and interfere with the pedals.
- Always properly reinstall and secure floor mats that have been taken out for cleaning.

- Always make sure that objects cannot fall into the driver footwell while the vehicle is moving. Objects can become trapped under the brake pedal and accelerator pedal causing a loss of vehicle control.

## Stowing luggage

### Loading the luggage compartment

All luggage and other objects must be properly stowed and secured in the luggage compartment.

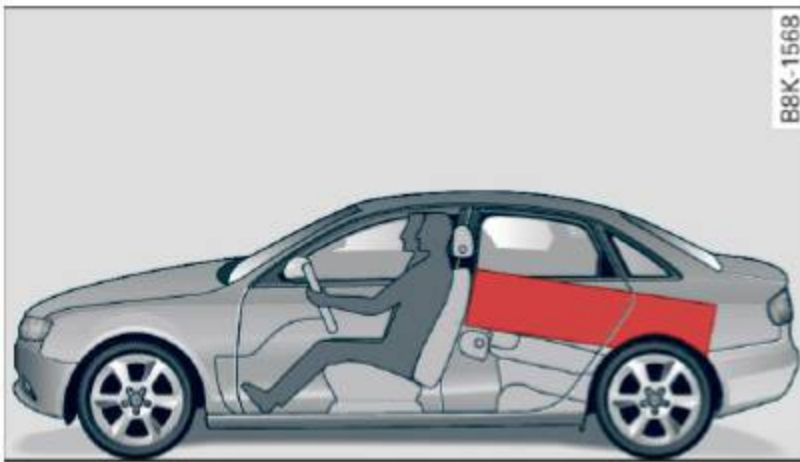

**Fig. 141** Safe load positioning: place heavy objects as low and as far forward as possible.

Loose items in the luggage compartment can shift suddenly, changing vehicle handling characteristics. Loose items can also increase the risk of serious personal injury in a sudden vehicle maneuver or in a collision.

- ▶ Distribute the load evenly in the luggage compartment.
- ▶ Always place and properly secure heavy items in the luggage compartment as low and as far forward as possible ⇒ *fig. 141*.
- ▶ Secure the load with the cargo net\* or with non-elastic straps secured to the tie-downs\* ⇒ *page 73* ⇒ *page 74*.
- ▶ Make sure that the rear seatback is securely latched in place.

### WARNING

Improperly stored luggage or other items can fly through the vehicle causing serious personal injury in the event of hard braking or an accident. To help reduce the risk of serious personal injury:

- Always put objects, for example, luggage or other heavy items in the luggage compartment.
- Always secure objects in the luggage compartment using the tie-down eyelets and suitable straps.

### WARNING

Heavy loads will influence the way your vehicle handles. To help reduce the risk of a loss of control leading to serious personal injury:

- Always keep in mind when transporting heavy objects, that a change in the center of gravity can also cause changes in vehicle handling:
  - Always distribute the load as evenly as possible.
  - Place heavy objects as far forward in the luggage compartment as possible.
- Never exceed the Gross Axle Weight Rating or the Gross Vehicle Weight Rating specified on the safety compliance sticker on the left door jamb. Exceeding permissible weight standards can cause the vehicle to slide and handle differently.
- Please observe information on safe driving ⇒ *page 126*.

### WARNING

- To help prevent poisonous exhaust gas from being drawn into the vehicle, always keep the rear lid closed while driving.
- Never transport objects larger than those fitting completely into the luggage area because the rear lid cannot be fully closed.
  - If you absolutely must drive with the rear lid open, observe the following notes to reduce the risk of poisoning:
    - Close all windows,
    - Close the sunroof,
    - Open all air outlets in the instrument panel,
    - Switch off the air recirculation,
    - Set the fresh air fan to the highest speed.

**! WARNING**

Always make sure that the doors, all windows, the sunroof and the rear lid are securely closed and locked to reduce the risk of injury when the vehicle is not being used.

- After closing the rear lid, always make sure that it is properly closed and locked.
- Never leave your vehicle unattended especially with the rear lid left open. A child could crawl into the vehicle through the luggage compartment and close the rear lid becoming trapped and unable to get out. Being trapped in a vehicle can lead to serious personal injury.
- Never let children play in or around the vehicle.
- Never let passengers ride in the luggage compartment. Vehicle occupants must always be properly restrained in one of the vehicle's seating positions.

**i Tips**

- Air circulation helps to reduce window fogging. Stale air escapes to the outside through vents in the trim panel. Be sure to keep these slots free and open.
- The tire pressure must correspond to the load. The tire pressure is shown on the tire pressure label. The tire pressure label is located on the driver's side B-pillar. The tire pressure label lists the recommended cold tire inflation pressures for the vehicle at its maximum capacity weight and the tires that were on your vehicle at the time it was manufactured. For recommended tire pressures for normal load conditions, please see chapter [⇒ page 234](#).

**Tie-downs**

Applies to vehicles: with tie-downs

*The luggage compartment is equipped with four tie-downs to secure luggage and other items.*

Use the tie-downs to secure your cargo properly [⇒ page 132, Loading the luggage compartment](#).

In a collision, the laws of physics mean that even smaller items that are loose in the vehicle will become heavy missiles that can cause serious injury. Items in the vehicle possess energy which vary with vehicle speed and the weight of the item. Vehicle speed is the most significant factor.

For example, in a frontal collision at a speed of 30 mph (48 km/h), the forces acting on a 10-lb (4.5 kg) object are about 20 times the normal weight of the item. This means that the weight of the item would suddenly be about 200 lbs. (90 kg). You can imagine the injuries that a 200 lbs. (90 kg) item flying freely through the passenger compartment could cause in a collision like this.

**! WARNING**

Weak, damaged or improper straps used to secure items to tie-downs can fail during hard braking or in a collision and cause serious personal injury.

- Always use suitable mounting straps and properly secure items to the tie-downs in the luggage compartment to help prevent items from shifting or flying forward as dangerous missiles.
- When the rear seat backrest is folded down, always use suitable mounting straps and properly secure items to the tie-downs in the luggage compartment to help prevent items from flying forward as dangerous missiles into the passenger compartment.
- Never attach a child safety seat tether strap to a tie-down.

## Reporting Safety Defects

### Applicable to U.S.A.

If you believe that your vehicle has a defect which could cause a crash or could cause injury or death, you should immediately inform the National Highway Traffic Safety Administration (NHTSA) in addition to notifying Audi of America, Inc.

If NHTSA receives similar complaints, it may open an investigation, and if it finds that a safety defect exists in a group of vehicles, it may order a recall and remedy campaign. However, NHTSA cannot become involved in individual problems between you, your dealer, or Audi of America, Inc.

To contact the NHTSA, you may either call:

Tel.: 1-888-327-4236 (TTY:  
1-800-424-9153) or  
1-800-424-9393

or you may write to:

NHTSA

U.S. Department of Transportation

1200 New Jersey Ave., S.E.  
West Building  
Washington, DC 20590

You can also obtain other information about motor vehicle safety from:

<http://www.safercar.gov>

### Applicable to Canada

If you live in Canada and you believe that your vehicle has a defect that could cause a crash, injury or death, you should immediately inform Transport Canada, Defect Investigations and Recalls. You should also notify Audi Canada.

Canadian customers who wish to report a safety-related defect to Transport Canada, Defect Investigations and Recalls, may either call Transport Canada toll-free at:

Tel.: 1-800-333-0510 or  
Tel.: 1-819-994-3328 (Ottawa region and from other countries)

TTY for hearing impaired: Tel.:  
1-888-675-6863



or contact Transport Canada by mail at:

Transport Canada  
Motor Vehicle Safety Investigations Laboratory  
80 Noel Street  
Gatineau, QC  
J8Z 0A1

For additional road safety information, please visit the Road Safety website at:

<http://www.tc.gc.ca/eng/roadsafety/menu.htm>

## Safety belts

### General notes

#### Always wear safety belts!

*Wearing safety belts correctly saves lives!*

This chapter explains why safety belts are necessary, how they work and how to adjust and wear them correctly.

- ▶ Read all the information that follows and heed all of the instructions and WARNINGS.

#### WARNING

Not wearing safety belts or wearing them improperly increases the risk of serious personal injury and death.

- Safety belts are the single most effective means available to reduce the risk of serious injury and death in automobile accidents. For your protection and that of your passengers, always correctly wear safety belts when the vehicle is moving.
- Pregnant women, injured, or physically impaired persons must also use safety belts. Like all vehicle occupants, they are more likely to be seriously injured if they do not wear safety belts. The best way to protect a fetus is to protect the mother - throughout the entire pregnancy.

#### Number of seats

Your Audi has a total of five seating positions: two in the front and three in the rear. Each seating position has a safety belt.

#### WARNING

Not wearing safety belts or wearing them improperly increases the risk of serious personal injury and death.

- Never strap more than one person, including small children, into any belt. It is especially dangerous to place a safety belt over a child sitting on your lap.
- Never let more people ride in the vehicle than there are safety belts available.

- Be sure everyone riding in the vehicle is properly restrained with a separate safety belt or child restraint.

#### Safety belt warning light

*Your vehicle has a warning system for the driver and (on USA models only) front seat passenger to remind you about the importance of buckling-up.*



**Fig. 142** Safety belt warning light in the instrument cluster - enlarged

#### Before driving off, always:

- ▶ Fasten your safety belt and make sure you are wearing it properly.
- ▶ Make sure that your passengers also buckle up and properly wear their safety belts.
- ▶ Protect your children with a child restraint system appropriate for the size and age of the children.

The  warning light in the instrument cluster lights up when the ignition is switched on as a reminder to fasten the safety belts. In addition, you will hear a warning tone for a certain period of time.

**Fasten your safety belt now and make sure that your passengers also properly put on their safety belts.**

## Why safety belts?

### Frontal collisions and the law of physics

Frontal crashes create very strong forces for people riding in vehicles.

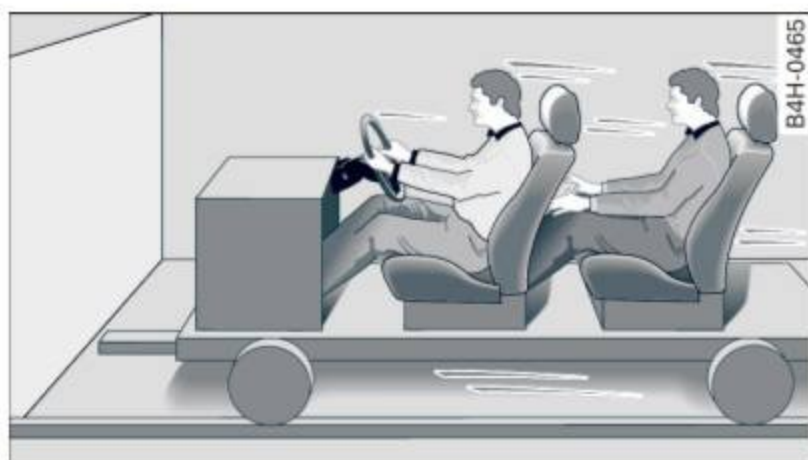

**Fig. 143** Unbelted occupants in a vehicle heading for a wall



**Fig. 144** The vehicle crashes into the wall

The physical principles are simple. Both the vehicle and the passengers possess energy which varies with vehicle speed and body weight. Engineers call this energy “kinetic energy.”

The higher the speed of the vehicle and the greater the vehicle's weight, the more energy that has to be “absorbed” in the crash.

Vehicle speed is the most significant factor. If the speed doubles from 15 to 30 mph (25 to 50 km/h), the energy increases 4 times!

Because the passengers of this vehicle are not using safety belts ⇒ *fig. 143*, they will keep moving at the same speed the vehicle was moving just before the crash, until something stops them - here, the wall ⇒ *fig. 144*.

The same principles apply to people sitting in a vehicle that is involved in a frontal collision. Even at city speeds of 20 to 30 mph (30 to 50 km/h), the forces acting on the body can

reach one ton (2,000 lbs. or 1,000 kg) or more. At greater speeds, these forces are even higher.

People who do not use safety belts are also not attached to their vehicle. In a frontal collision they will also keep moving forward at the speed their vehicle was travelling just before the crash. Of course, the laws of physics don't just apply to frontal collisions, they determine what happens in all kinds of accidents and collisions.

### What happens to occupants not wearing safety belts?

*In crashes unbelted occupants cannot stop themselves from flying forward and being injured or killed. Always wear your safety belts!*



**Fig. 145** A driver not wearing a safety belt is violently thrown forward

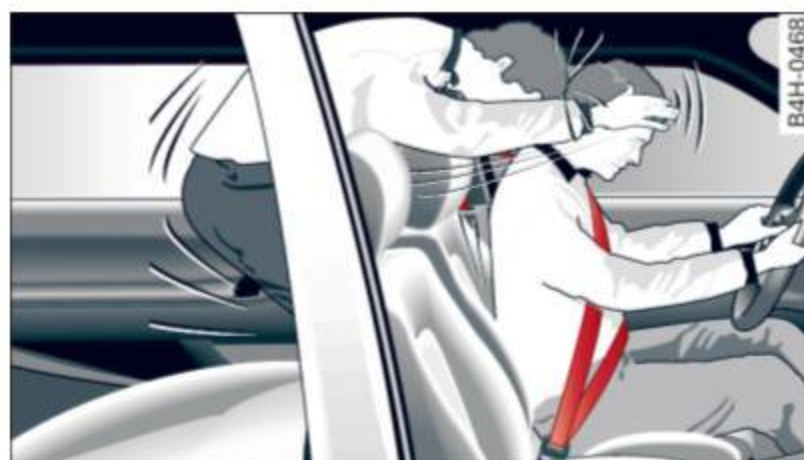

**Fig. 146** A rear passenger not wearing a safety belt will fly forward and strike the driver

Unbelted occupants are not able to resist the tremendous forces of impact by holding tight or bracing themselves. Without the benefit of safety restraint systems, the unrestrained occupant will slam violently into the steering wheel, instrument panel, windshield, or whatever else is in the way ⇒ *fig. 145*. This impact ▶

with the vehicle interior has all the energy they had just before the crash.

Never rely on airbags alone for protection. Even when they deploy, airbags provide only additional protection. Airbags are not supposed to deploy in all kinds of accidents. Although your Audi is equipped with airbags, all vehicle occupants, including the driver, must wear safety belts correctly in order to minimize the risk of severe injury or death in a crash.

Remember too, that airbags will deploy only once and that your safety belts are always there to offer protection in those accidents in which airbags are not supposed to deploy or when they have already deployed. Unbelted occupants can also be thrown out of the vehicle where even more severe or fatal injuries can occur.

It is also important for the rear passengers to wear safety belts correctly. Unbelted passengers in the rear seats endanger not only themselves but also the driver and other passengers ⇒ *fig. 146*. In a frontal collision they will be thrown forward violently, where they can hit and injure the driver and/or front seat passenger.

### Safety belts protect

*People think it's possible to use the hands to brace the body in a minor collision. It's simply not true!*



**Fig. 147** Driver is correctly restrained in a sudden braking maneuver

Safety belts used properly can make a big difference. Safety belts help to keep passengers in their seats, gradually reduce energy levels

applied to the body in an accident, and help prevent the uncontrolled movement that can cause serious injuries. In addition, safety belts reduce the danger of being thrown out of the vehicle.

Safety belts attach passengers to the car and give them the benefit of being slowed down more gently or “softly” through the “give” in the safety belts, crush zones and other safety features engineered into today’s vehicles. By “absorbing” the kinetic energy over a longer period of time, the safety belts make the forces on the body more “tolerable” and less likely to cause injury.

Although these examples are based on a frontal collision, safety belts can also substantially reduce the risk of injury in other kinds of crashes. So, whether you’re on a long trip or just going to the corner store, always buckle up and make sure others do, too. Accident statistics show that vehicle occupants properly wearing safety belts have a lower risk of being injured and a much better chance of surviving an accident. Properly using safety belts also greatly increases the ability of the supplemental airbags to do their job in a collision. For this reason, wearing a safety belt is legally required in most countries including much of the United States and Canada.

Although your Audi is equipped with airbags, you still have to wear the safety belts provided. Front airbags, for example, are activated only in some frontal collisions. The front airbags are not activated in all frontal collisions, in side and rear collisions, in roll overs or in cases where there is not enough deceleration through impact to the front of the vehicle. The same goes for the other airbag systems in your Audi. So, always wear your safety belt and make sure everybody in your vehicle is properly restrained!

## Important safety instructions about safety belts

*Safety belts must always be correctly positioned across the strongest bones of your body.*

- ▶ Always wear safety belts as illustrated and described in this chapter.
- ▶ Make sure that your safety belts are always ready for use and are not damaged.

### WARNING

Not wearing safety belts or wearing them improperly increases the risk of serious personal injury and death. Safety belts can work only when used correctly.

- Always fasten your safety belts correctly before driving off and make sure all passengers are correctly restrained.
- For maximum protection, safety belts must always be positioned properly on the body.
- Never strap more than one person, including small children, into any belt.
- Never place a safety belt over a child sitting on your lap.
- Always keep feet in the footwell in front of the seat while the vehicle is being driven.
- Never let any person ride with their feet on the instrument panel or sticking out the window or on the seat.
- Never remove a safety belt while the vehicle is moving. Doing so will increase your risk of being injured or killed.
- Never wear belts twisted.
- Never wear belts over rigid or breakable objects in or on your clothing, such as eye glasses, pens, keys, etc., as these may cause injury.
- Never allow safety belts to become damaged by being caught in door or seat hardware.
- Do not wear the shoulder part of the belt under your arm or otherwise out of position.

- Several layers of heavy clothing may interfere with correct positioning of belts and reduce the overall effectiveness of the system.
- Always keep belt buckles free of anything that may prevent the buckle from latching securely.
- Never use comfort clips or devices that create slack in the shoulder belt. However, special clips may be required for the proper use of some child restraint systems.
- Torn or frayed safety belts can tear, and damaged belt hardware can break in an accident. Inspect belts regularly. If webbing, bindings, buckles, or retractors are damaged, have belts replaced by an authorized Audi dealer.
- Safety belts that have been worn and loaded in an accident must be replaced with the correct replacement safety belt by an authorized Audi dealer. Replacement may be necessary even if damage cannot be clearly seen. Anchorages that were loaded must also be inspected.
- Never remove, modify, disassemble, or try to repair the safety belts yourself.
- Always keep the belts clean. Dirty belts may not work properly and can impair the function of the inertia reel ⇒ *table Cleaning interior on page 204.*

## Safety belts



### Fastening safety belts

*Safety first - everybody buckle up!*



**Fig. 148** Belt buckle and tongue on the driver's seat

To provide maximum protection, safety belts must always be positioned correctly on the wearer's body.

- ▶ Adjust the front seat and head restraint properly ⇒ *page 60, Seats and storage*.
- ▶ Make sure the seatback of the rear seat bench is in an upright position and securely latched in place before using the belt ⇒ .
- ▶ Hold the belt by the tongue and pull it evenly across the chest and pelvis ⇒ .
- ▶ Insert the tongue into the correct buckle of your seat until you hear it latch securely ⇒ *fig. 148*.
- ▶ Pull on the belt to make sure that it is securely latched in the buckle.

### Automatic safety belt retractors

Every safety belt is equipped with an automatic belt retractor on the shoulder belt. This feature locks the belt when the belt is pulled out fast, during hard braking and in an accident. The belt may also lock when you drive up or down a steep hill or through a sharp curve. During normal driving the belt lets you move freely.

### Safety belt pretensioners

The safety belts are equipped with a belt pretensioner that helps to tighten the safety belt and remove slack when the pretensioner is activated. The function of the pretensioner is monitored by a warning light ⇒ *page 20*.

### Convertible locking retractor

Every safety belt except the one on the driver seat is equipped with a convertible locking retractor that **must** be used when the safety belt is used to attach a child safety seat. Be sure to read the important information about this feature ⇒ *page 175*.

#### WARNING

Improperly positioned safety belts can cause serious injury in an accident ⇒ *page 140, Safety belt position*.

- Safety belts offer optimum protection only when the seatback is upright and

belts are properly positioned on the body.

- Always make sure that the rear seat backrest to which the center rear safety belt is attached is securely latched whenever the rear center safety belt is being used. If the backrest is not securely latched, the passenger will move forward with the backrest during sudden braking, in a sudden maneuver and especially in a crash.
- Never attach the safety belt to the buckle for another seat. Attaching the belt to the wrong buckle will reduce safety belt effectiveness and can cause serious personal injury.
- A passenger who is not properly restrained can be seriously injured by the safety belt itself when it moves from the stronger parts of the body into critical areas like the abdomen.
- Always lock the convertible locking retractor when you are securing a child safety seat in the vehicle ⇒ *page 177*.

### Safety belt position

*Correct belt position is the key to getting maximum protection from safety belts.*

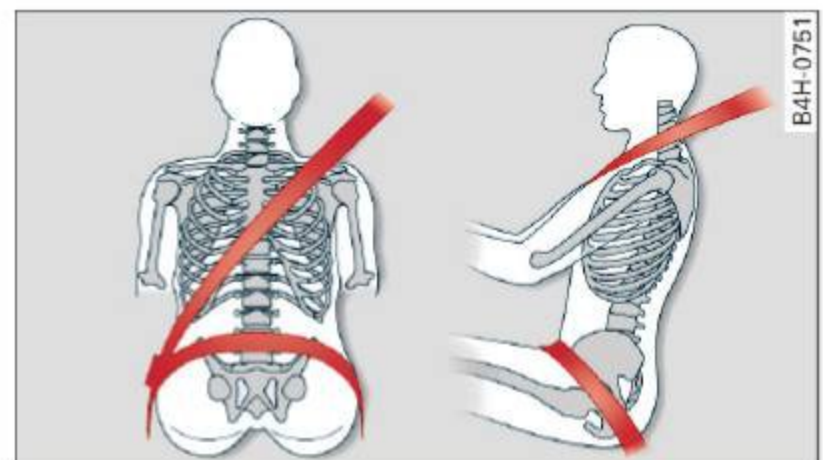

**Fig. 149** Safety belt position

Standard features on your vehicle help you adjust the position of the safety belt to match your body size.

- belt height adjustment for the front seats,
- automatic belt height adjustment for the rear seats.

**! WARNING**

Improperly positioned safety belts can cause serious personal injury in an accident.

- The shoulder belt should lie as close to the center of the collar bone as possible and should fit well on the body. Hold the belt above the latch tongue and pull it evenly across the chest so that it sits as low as possible on the pelvis and there is no pressure on the abdomen. The belt should always fit snugly ⇒ *fig. 149*. Pull on the belt to tighten if necessary.
- The lap belt portion of the safety belt must be positioned as low as possible across pelvis and never over the abdomen. Make sure the belt lies flat and snug ⇒ *fig. 149*. Pull on the belt to tighten if necessary.
- A loose-fitting safety belt can cause serious injuries by shifting its position on your body from the strong bones to more vulnerable, soft tissue and cause serious injury.
- Always read and heed all WARNINGS and other important information ⇒ *page 139*.

**Pregnant women must also be correctly restrained**

*The best way to protect the fetus is to make sure that expectant mothers always wear safety belts correctly - throughout the pregnancy.*



**Fig. 150** Safety belt position during pregnancy

To provide maximum protection, safety belts must always be positioned correctly on the wearer's body ⇒ *page 140*.

- ▶ Adjust the front seat and head restraint correctly ⇒ *page 60, Seats and storage*.
- ▶ Make sure the seatback of the rear seat bench is in an upright position and securely latched in place before using the belt.
- ▶ Hold the belt by the tongue and pull it evenly across the chest and pelvis ⇒ *fig. 150*, ⇒ **!**.
- ▶ Insert the tongue into the correct buckle of your seat until you hear it latch securely ⇒ *page 139, fig. 148*.
- ▶ Pull on the belt to make sure that it is securely latched in the buckle.

**! WARNING**

Improperly positioned safety belts can cause serious personal injury in an accident.

- Expectant mothers must always wear the lap portion of the safety belt as low as possible across the pelvis and below the rounding of the abdomen.
- Always read and heed all WARNINGS and other important information ⇒ **!** in *Fastening safety belts on page 140*.

**Unfastening safety belts**

*Unbuckle the safety belt with the red release button only after the vehicle has stopped.*



**Fig. 151** Releasing the tongue from the buckle

- ▶ Push the red release button on the buckle ⇒ *fig. 151*. The belt tongue will spring out of the buckle ⇒ **!**.

- ▶ Let the belt wind up on the retractor as you guide the belt tongue to its stowed position.

### WARNING

Never unfasten safety belt while the vehicle is moving. Doing so will increase your risk of being injured or killed.

### Adjusting safety belt height

With the aid of the safety belt height adjustment, the three point safety belt strap routing can be fitted to the shoulder area, according to body size.

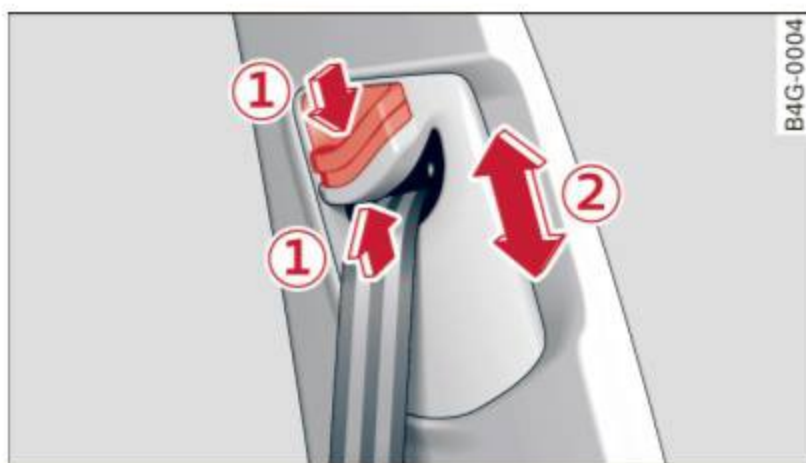





Fig. 152 Safety belt height adjustment for the front seats – loop-around fittings

The shoulder belt should lie as close to the center of the collar bone as possible and should fit well on the body ⇒  in *Safety belt position on page 141*.

- ▶ Push the loop-around fittings **up** ⇒ fig. 152 , or
- ▶ squeeze together the  button, and push the loop-around fittings **down** .
- ▶ Pull the belt to make sure that the upper attachment is properly engaged.

### WARNING

Always read and heed all WARNINGS and other important information ⇒ page 139.

### Tips

With the front seats, the height adjustment of the seat can also be used to adjust the position of the safety belts.

### Improperly worn safety belts

*Incorrectly positioned safety belts can cause severe injuries.*

Wearing safety belts improperly can cause serious injury or death. Safety belts can only work when they are correctly positioned on the body. Improper seating positions reduce the effectiveness of safety belts and will even increase the risk of injury and death by moving the safety belt to critical areas of the body. Improper seating positions also increase the risk of serious injury and death when an airbag deploys and strikes an occupant who is not in the correct seating position. A driver is responsible for the safety of all vehicle occupants and especially for children. Therefore:

- ▶ Never permit anyone to assume an incorrect sitting position in the vehicle while traveling ⇒ .

### WARNING

Improperly worn safety belts increase the risk of serious personal injury and death whenever a vehicle is being used.

- Always make sure that all vehicle occupants are correctly restrained and stay in a correct seating position whenever the vehicle is being used.
- Always read and heed all WARNINGS and other important information ⇒ page 139.

## Safety belt pretensioners

### How safety belt pretensioners work

*In front, side and rear-end collisions above a particular severity, safety belts are tensioned automatically.*

The safety belts are equipped with safety belt pretensioners. The system is activated by sensors in front, side and rear-end collisions of great severity. This tightens the belt and takes up belt slack ⇒  in *Service and disposal of* ▶

safety belt pretensioner on page 143. Taking up the slack helps to reduce forward occupant movement during a collision.

### Note

Never let the belt remain over a rear seat-back that has been folded forward.

### Tips

The safety belt pretensioner can only be activated once.

- In minor frontal and side collisions, in rear-end collisions, in a rollover and in accidents involving very little impact force, the safety belt pretensioner are not activated.
- In the case of a side crash, the safety belt pretensioners will activate on the driver's or front passenger's sides only, depending on which side of the vehicle the crash occurs.
- When the safety belt pretensioners are activated, a fine dust is released. This is normal and is not caused by a fire in the vehicle.
- The relevant safety requirements must be observed when the vehicle or components of the system are scrapped. An authorized Audi dealer or qualified workshop is familiar with these regulations and will be pleased to pass on the information to you.
- Be sure to observe all safety, environmental and other regulations if the vehicle or individual parts of the system, particularly the safety belt or airbag, are to be disposed. We recommend you have your authorized Audi dealer perform this service for you.

### Service and disposal of safety belt pretensioner

The safety belt pretensioners are parts of the safety belts on your Audi. Installing, removing, servicing or repairing of belt pretensioners can damage the safety belt system and

prevent it from working correctly in a collision.

There are some important things you have to know to make sure that the effectiveness of the system will not be impaired and that discarded components do not cause injury or pollute the environment.

### WARNING

Improper care, servicing and repair procedures can increase the risk of personal injury and death by preventing a safety belt pretensioner from activating when needed or activating it unexpectedly:

- The belt pretensioner system can be activated only once. If belt pretensioners have been activated, the system must be replaced.
- Never repair, adjust, or change any parts of the safety belt system.
- Safety belt systems including safety belt pretensioners cannot be repaired. Special procedures are required for removal, installation and disposal of this system.
- For any work on the safety belt system, we strongly recommend that you see your authorized Audi dealer or qualified technician who has an Audi approved repair manual, training and special equipment necessary.

### For the sake of the environment

Undeployed airbag modules and pretensioners might be classified as Perchlorate Material - special handling may apply, see [www.dtsc.ca.gov/hazardouswaste/perchlorate](http://www.dtsc.ca.gov/hazardouswaste/perchlorate). When the vehicle or parts of the restraint system including airbag modules safety belts with pretensioners are scrapped, all applicable laws and regulations must be observed. Your authorized Audi dealer is familiar with these requirements and we recommend that you have your dealer perform this service for you.

## Airbag system

### Important things to know

#### Importance of wearing safety belts and sitting properly

*Airbags are only supplemental restraints. For airbags to do their job, occupants must always properly wear their safety belts and be in a proper seating position.*

For your safety and the safety of your passengers, before driving off, always:

- ▶ Adjust the driver's seat and steering wheel properly ⇒ *page 127*,
- ▶ Adjust the front passenger's seat properly ⇒ *page 61*,
- ▶ Wear safety belts properly ⇒ *page 139*,
- ▶ Always properly use the proper child restraint to protect children ⇒ *page 165*.

In a collision airbags must inflate within the blink of an eye and with considerable force. The supplemental airbags can cause injuries if the driver or the front seat passenger is not seated properly. Therefore in order to help the airbag to do its job, it is important, both as a driver and as a passenger to sit properly at all times.

By keeping room between your body and the steering wheel and the front of the passenger compartment, the airbag can inflate fully and completely and provide supplemental protection in certain frontal collisions ⇒ *page 127*, *Proper occupant seating positions*. For details on the operation of the seat adjustment controls ⇒ *page 62*.

It's especially important that children are properly restrained ⇒ *page 165*.

There is a lot that the driver and the passengers can and must do to help the individual safety features installed in your Audi work together as a system.

Proper seating position is important so that the front airbag on the driver side can do its job. If you have a physical impairment or con-

dition that prevents you from sitting properly on the driver seat with the safety belt properly fastened and reaching the pedals, special modifications to your vehicle may be necessary.

Contact your authorized Audi dealer, or call Audi Customer Relations at 1-800-822-2834.

When the airbag system deploys, a gas generator will fill the airbags, break open the padded covers, and inflate between the steering wheel and the driver and between the instrument panel and the front passenger. The airbags will deflate immediately after deployment so that the front occupants can see through the windshield again without interruption.

All of this takes place in the blink of an eye, so fast that many people don't even realize that the airbags have deployed. The airbags also inflate with a great deal of force and nothing should be in their way when they deploy. Front airbags in combination with properly worn safety belts slow down and limit the occupant's forward movement. Together they help to prevent the driver and front seat passenger from hitting parts of the inside the vehicle while reducing the forces acting on the occupant during the crash. In this way they help to reduce the risk of injury to the head and upper body in the crash. Airbags do not protect the arms or the lower parts of the body.

Both front airbags will not inflate in all frontal collisions. The triggering of the airbag system depends on the vehicle deceleration rate caused by the collision and registered by the electronic control unit. If this rate is below the reference value programmed into the control unit, the airbags will not be triggered, even though the car may be badly damaged as a result of the collision. Vehicle damage, repair costs or even the lack of vehicle damage is not necessarily an indication of whether an airbag should inflate or not.

It is not possible to define a range of vehicle speeds that will cover every possible kind and ►

angle of impact that will always trigger the airbags, since the circumstances will vary considerably between one collision and another. Important factors include, for example, the nature (hard or soft) of the object which the car hits, the angle of impact, vehicle speed, etc. The front airbags will also not inflate in side or rear collisions, or in roll-overs.

**Always remember:** Airbags will deploy only once, and only in certain kinds of collisions. Your safety belts are always there to offer protection in those situations in which airbags are not supposed to deploy, or when they have already deployed; for example, when your vehicle strikes or is struck by another after the first collision.

This is just one of the reasons why an airbag is a supplementary restraint and is not a substitute for a safety belt. The airbag system works most effectively when used with the safety belts. Therefore, always properly wear your safety belts ⇒ *page 136*.

### WARNING

- Sitting too close to the steering wheel or instrument panel will decrease the effectiveness of the airbags and will increase the risk of personal injury in a collision.
- Never sit closer than 10 inches (25 cm) to the steering wheel or instrument panel.
  - If you cannot sit more than 10 inches (25 cm) from the steering wheel, investigate whether adaptive equipment may be available to help you reach the pedals and increase your seating distance from the steering wheel.
  - If you are unrestrained, leaning forward, sitting sideways or out of position in any way, your risk of injury is much higher.
  - You will also receive serious injuries and could even be killed if you are up against the airbag or too close to it when it inflates - even with an Advanced Airbag.
  - To reduce the risk of injury when an airbag inflates, always wear safety belts properly ⇒ *page 139, Safety belts*.

- Always make certain that children age 12 or younger always ride in the rear seat. If children are not properly restrained, they may be severely injured or killed when an airbag inflates.
- Never let children ride unrestrained or improperly restrained in the vehicle. Adjust the front seats properly.
- Never ride with the backrest reclined.
- Always sit as far as possible from the steering wheel or the instrument panel ⇒ *page 127*.
- Always sit upright with your back against the backrest of your seat.
- Never place your feet on the instrument panel or on the seat. Always keep both feet on the floor in front of the seat to help prevent serious injuries to the legs and hips if the airbag inflates.
- Never recline the front passenger's seat to transport objects. Items can also move into the area of the side airbag or the front airbag during braking or in a sudden maneuver. Objects near the airbags can become projectiles and cause injury when an airbag inflates.

### WARNING

- Airbags that have deployed in a crash must be replaced.
- Use only original equipment airbags approved by Audi and installed by a trained technician who has the necessary tools and diagnostic equipment to properly replace any airbag in your vehicle and assure system effectiveness in a crash.
  - Never permit salvaged or recycled airbags to be installed in your vehicle.

### Child restraints on the front seat – some important things to know

- ▶ Be sure to read the important information and heed the WARNINGS for important details about children and Advanced Airbags ⇒ *page 165*.

Even though your vehicle is equipped with an Advanced Airbag System, make certain that all children, especially those 12 years and younger, always ride in the back seat properly restrained for their age and size. The airbag on the passenger side makes the front seat a potentially dangerous place for a child to ride. The front seat is not the safest place for a child in a forward-facing child safety seat. It can be a very dangerous place for an infant or a child in a rearward-facing seat.

The Advanced Airbag System in your vehicle has been certified to comply with the Requirements of United States Federal Motor Vehicle Safety Standard 208 as applicable at the time your vehicle was manufactured.

The Standard requires the front airbag on the passenger side to be turned off (“suppressed”) if a child up to about one year of age restrained in one of the rear-facing or forward-facing infant restraints listed in Federal Motor Vehicle Safety Standard 208 with which the Advanced Airbag System in your vehicle was certified has been installed on the front passenger seat. For a listing of the child restraints that were used to certify compliance with the US Safety Standard ⇒ *page 167*.

The **PASSENGER AIR BAG OFF** light in the instrument panel tells you when the front Advanced Airbag on the passenger side has been turned off by the electronic control unit.

Each time you turn on the ignition, the **PASSENGER AIR BAG OFF** light will come on for a few seconds and:

- will stay on if the front passenger seat is not occupied,
- will stay on if there is a small child or child restraint on the front passenger seat,
- will go off if the front passenger seat is occupied by an adult as registered by the weight-sensing mat ⇒ *page 154, Monitoring the Advanced Airbag System*.

The **PASSENGER AIR BAG OFF** light comes on when the control unit detects a total weight on the front passenger seat that requires the front airbag to be turned off.

If the total weight on the front passenger seat is more than that of a typical 1 year-old child but less than the weight of a small adult, the front airbag on the passenger side can deploy (the **PASSENGER AIR BAG OFF** light does not come on). If the **PASSENGER AIR BAG OFF** light does not come on, the front airbag on the passenger side has not been turned off by the electronic control unit and can deploy if the control unit senses an impact that meets the conditions stored in its memory.

**For example, the airbag may deploy if:**

- a small child that is heavier than a typical 1 year-old child is on the front passenger seat (regardless of whether the child is in one of the child safety seats listed ⇒ *page 167*), or
- a child who has outgrown child restraints is on the front passenger seat.

If the front passenger airbag is turned off, the **PASSENGER AIR BAG OFF** light comes on in the instrument cluster and stays on.

The front airbag on the passenger side may *not* deploy (the **PASSENGER AIR BAG OFF** light does not illuminate and stay lit) even if a small adult or teenager, or a passenger who is not sitting upright with their back against a non-reclined backrest with their feet on the vehicle floor in front of the seat is on the front passenger seat ⇒ *page 127, Proper seating position for the driver*.

If the front passenger airbag deploys, the Federal Standard requires the airbag to meet the “low risk” deployment criteria to reduce the risk of injury through interaction with the airbag. “Low risk” deployment occurs in those crashes that take place at lower decelerations as defined in the electronic control unit ⇒ *page 155, PASSENGER AIR BAG OFF light*.

Always remember, a child safety seat or infant carrier installed on the front seat may be struck and knocked out of position by the rapidly inflating passenger’s airbag in a frontal collision. The airbag could greatly reduce the effectiveness of the child restraint and even seriously injure the child during inflation. ►

For this reason, and because the back seat is the safest place for children - when properly restrained according to their age and size - we strongly recommend that children always sit in the back seat ⇒ *page 165, Child Safety*.

### WARNING

A child in a rearward-facing child safety seat installed on the front passenger seat will be seriously injured and can be killed if the front airbag inflates - even with an Advanced Airbag System.

- The inflating airbag will hit the child safety seat or infant carrier with great force and will smash the child safety seat and child against the backrest, center armrest, door or roof.
- Always install rear-facing child safety seats on the rear seat.
- If you must install a rearward facing child safety seat on the front passenger seat because of exceptional circumstances and the **PASSENGER AIR BAG OFF** light does not come on and stay on, immediately install the rear-facing child safety seat in a rear seating position and have the airbag system inspected by your authorized Audi dealer.
- Forward-facing child safety seats installed on the front passenger's seat may interfere with the deployment of the airbag and cause serious personal injury to the child.

### WARNING

If, in exceptional circumstances, you must install a forward-facing child restraint on the front passenger's seat:

- Always make sure the forward-facing seat has been designed and certified by its manufacturer for use on a front seat with a passenger front and side airbag.
- Never put the forward-facing child restraint up against or very near the instrument panel.
- Always move the passenger seat into its rearmost position in the seat's fore and

aft adjustment range, as far away from the airbag as possible before installing the forward-facing child restraint. The backrest must be adjusted to an upright position.

- Make sure that the **PASSENGER AIR BAG OFF** light comes on and stays on all the time whenever the ignition is switched on.

### WARNING

To reduce the risk of serious injury, make sure that the **PASSENGER AIR BAG OFF** light will be displayed whenever a child restraint is installed on the front passenger seat and the ignition is switched on.

- If the **PASSENGER AIR BAG OFF** light does not stay on, perform the checks described ⇒ *page 154, Monitoring the Advanced Airbag System*.
- Take the child restraint off the front passenger seat and install it properly at one of the rear seat positions if the **PASSENGER AIR BAG OFF** light does not stay on.
- Have the airbag system inspected by your authorized Audi dealer immediately.
- Always carefully follow instructions from child restraint manufacturers when installing child restraints.

### WARNING

If, in exceptional circumstances, you must install a forward or rearward-facing child restraint on the front passenger's seat:

- Improper installation of child restraints can reduce their effectiveness or even prevent them from providing any protection.
- An improperly installed child restraint can interfere with the airbag as it deploys and seriously injure or even kill the child - even with an Advanced Airbag System.
- Always carefully follow the manufacturer's instructions provided with the child safety seat or carrier.

- Never place additional items on the seat that can increase the total weight registered by the weight-sensing mat and can cause injury in a crash.

## Front airbags

### Description of front airbags

The airbag system can provide supplemental protection to properly restrained front seat occupants.



Fig. 153 Location of driver airbag: in steering wheel



Fig. 154 Location of front passenger's airbag: in the instrument panel

Your vehicle is equipped with an “Advanced Airbag System” in compliance with United States Federal Motor Vehicle Safety Standard (FMVSS) 208 as applicable at the time your vehicle was manufactured. The safety belts for the seats have “pretensioners” that help to take slack out of the belt system. The pretensioners are also activated by the electronic control unit for the airbag system.

The front safety belts also have load limiters to help reduce the forces applied to the body in a crash.

The airbag for the driver is in the steering wheel hub ⇒ *fig. 153* and the airbag for the

front passenger is in the instrument panel ⇒ *fig. 154*. The general location of the airbags is marked “AIRBAG”.

There is a lot you need to know about the airbags in your vehicle. We urge you to read the detailed information about airbags, safety belts and child safety in this and the other chapters that make up the owner's literature. Please be sure to heed the WARNINGS - they are extremely important for your safety and the safety of your passengers, especially infants and small children.

### WARNING

- Never rely on airbags alone for protection.
- Even when they deploy, airbags provide only supplemental protection.
- Airbags work most effectively when used with properly worn safety belts.
- Therefore, always wear your safety belts and make sure that everybody in your vehicle is properly restrained.

### WARNING

- A person on the front passenger seat, especially infants and small children, will receive serious injuries and can even be killed by being too close to the airbag when it inflates.
- Although the Advanced Airbag System in your vehicle is designed to turn off the front passenger airbag if an infant or a small child is on the front passenger seat, nobody can absolutely guarantee that deployment under these special conditions is impossible in all conceivable situations that may happen during the useful life of your vehicle.
- The Advanced Airbag System can deploy in accordance with the “low risk” option under the U.S. Federal Standard if a child that is heavier than the typical one-year old child is on the front passenger seat and the other conditions for airbag deployment are met.

- Accident statistics have shown that children are generally safer in the rear seat area than in the front seating position.
- For their own safety, all children, especially 12 years and younger, should always ride in the back properly restrained for their age and size.

### Advanced front airbag system

Your vehicle is equipped with a front Advanced Airbag System in compliance with United States Federal Motor Vehicle Safety Standard 208 as applicable at the time your vehicle was manufactured.

The front Advanced Airbag System supplements the safety belts to provide additional protection for the driver's and front passenger's heads and upper bodies in frontal crashes. The airbags inflate only in frontal impacts when the vehicle deceleration is high enough.

The front Advanced Airbag System for the front seat occupants is not a substitute for your safety belts. Rather, it is part of the overall occupant restraint system in your vehicle. Always remember that the airbag system can only help to protect you, if you are sitting upright, wearing your safety belt and wearing it properly. This is why you and your passengers must always be properly restrained, not just because the law requires you to be.

The Advanced Airbag System in your vehicle has been certified to meet the “low risk” requirements for 3 and 6 year-old children on the passenger side and very small adults on the driver side. The low risk deployment criteria are intended to help reduce the risk of injury through interaction with the front airbag that can occur, for example, by being too close to the steering wheel and instrument panel when the airbag inflates.

In addition, the system has been certified to comply with the “suppression” requirements of the Safety Standard, to turn off the front airbag for infants 12 months old and younger who are restrained on the front passenger

seat in child restraints that are listed in the Standard ⇒ *page 167, Child restraints and Advanced Airbags.*

“Suppression” requires the front airbag on the passenger side to be turned off if:

- a child up to about one year of age is restrained on the front passenger seat in one of the rear-facing or forward-facing infant restraints listed in Federal Motor Vehicle Safety Standard 208 with which the Advanced Airbag System in your vehicle was certified. For a listing of the child restraints that were used to certify your vehicle's compliance with the US Safety Standard ⇒ *page 167,*
- weight less than a threshold level stored in the control unit is detected on the front passenger seat.

When a person is detected on the front passenger seat, weighing more than the total weight of a child that is about 1 year old restrained in one of the rear-facing or forward-facing infant restraints (listed in Federal Motor Vehicle Safety Standard 208 with which the Advanced Airbag System in your vehicle was certified), the front airbag on the passenger side may or may not deploy.

The **PASSENGER AIR BAG OFF** light comes on when the electronic control unit detects a total weight on the front passenger seat that requires the front airbag to be turned off. If the **PASSENGER AIR BAG OFF** light does not come on, the front airbag on the passenger side has not been turned off by the control unit and can deploy if the control unit senses an impact that meets the conditions stored in its memory.

If the total weight on the front passenger seat is more than that of a typical 1 year-old, but less than the weight of a small adult, the front airbag on the passenger side may deploy (the **PASSENGER AIR BAG OFF** light does not come on).

**For example, the airbag may deploy if:** ►

- a small child that is heavier than a typical 1 year-old child is on the front passenger seat (regardless of whether the child is in one of the child safety seats listed ⇒ *page 167*),
- a child who has outgrown child restraints is on the front passenger seat.

If the front passenger airbag is turned off, the **PASSENGER AIR BAG OFF** light in the center of the instrument panel will come on and stay on.

The front airbag on the passenger side may *not* deploy (the **PASSENGER AIR BAG OFF** light does not illuminate and stay lit) if:

- a small adult or teenager is on the front passenger seat
- a passenger who is not sitting upright with their back against a non-reclined backrest with their feet on the vehicle floor in front of the seat is on the front passenger seat.

If the front passenger airbag deploys, the Federal Standard requires the airbag to meet the “low risk” deployment criteria to help reduce the risk of injury through interaction with the airbag. “Low risk” deployment occurs in those crashes that take place at lower decelerations as defined in the electronic control unit. ⇒ *page 154*

**Always remember:** Even though your vehicle is equipped with Advanced Airbags, the safest place for children is properly restrained on the back seat. Please be sure to read the important information in the sections that follow and be sure to heed all of the WARNINGS.

### **WARNING**

To reduce the risk of injury when an airbag inflates, always wear safety belts properly.

- If you are unrestrained, leaning forward, sitting sideways or out of position in any way, your risk of injury is much higher.
- You will also receive serious injuries and could even be killed if you are up against the airbag or too close to it when it inflates - even with an Advanced Airbag ⇒ *page 144*.

### **WARNING**

A child in a rearward-facing child safety seat installed on the front passenger seat will be seriously injured and can be killed if the front airbag inflates - even with an Advanced Airbag System.

- Although the Advanced Airbag System in your vehicle is designed to turn off the front airbag when a rearward-facing child restraint has been installed on the front passenger seat, nobody can absolutely guarantee that deployment is impossible in all conceivable situations that may happen during the useful life of your vehicle.
- The inflating airbag will hit the child safety seat or infant carrier with great force and will smash the child safety seat and child against the backrest, center armrest, door, or roof.
- Always install rearward-facing child restraints in the back seat.
- If you must install a rearward facing child safety seat on the front passenger seat because of exceptional circumstances and the **PASSENGER AIR BAG OFF** light does not come on and stay on, immediately install the rear-facing child safety seat in a rear seating position and have the airbag system inspected by your authorized Audi dealer.

### **WARNING**

If, in exceptional circumstances, you must install a forward-facing child restraint on the front passenger's seat:

- Always make sure the forward-facing seat has been designed and certified by its manufacturer for use on a front seat with a passenger front and side airbag.
- Never put the forward-facing child restraint up against or very near the instrument panel.
- Always move the passenger seat into its rearmost position in the seat's fore and aft adjustment range, as far away from the airbag as possible, before installing

the forward-facing child restraint. The backrest must be adjusted to an upright position.

- Make sure that the **PASSENGER AIR BAG OFF** light comes on and stays on all the time whenever the ignition is switched on.

### Advanced Airbag System components

The front passenger seat in your vehicle has a lot of very important parts of the Advanced Airbag System in it. These parts include the weight-sensing mat, sensors, wiring, brackets, and more. The function of the system in the front passenger seat is checked by the electronic control unit when the ignition is on. The control unit monitors the Advanced Airbag System and turns the airbag indicator light on when a malfunction in the system components is detected. The function of the airbag indicator light is described in greater detail below. Because the front passenger seat contains important parts of the Advanced Airbag System, you must take care to prevent it from being damaged. Damage to the seat may prevent the Advanced Airbag for the front passenger seat from doing its job in a crash.

#### The front Advanced Airbag System consists of the following:

- Crash sensors in the front of the vehicle that measure vehicle acceleration/deceleration to provide information to the Advanced Airbag System about the severity of the crash.
- An electronic control unit, with integrated crash sensors for front and side impacts. The control unit “decides” whether to fire the front airbags based on the information received from the crash sensors. The control unit also “decides” whether the safety belt pretensioners should be activated.
- An Advanced Airbag with gas generator and control valve for the driver inside the steering wheel hub.

- An Advanced Airbag with gas generator and control valve inside the instrument panel for the front passenger.
- A weight-sensing mat under the upholstery padding of the front passenger seat cushion that measures the total weight on the seat. The information registered is sent continuously to the electronic control unit to regulate deployment of the front Advanced Airbag on the passenger side.
- An airbag monitoring system and indicator light in the instrument cluster ⇒ *page 154*.
- A sensor in each front seat registers the distance between the respective seat and the steering wheel or instrument panel. The information registered is sent continuously to the electronic control unit to regulate deployment of the front Advanced Airbags.
- The **PASSENGER AIR BAG OFF** light comes on and stays on in the center of the instrument panel ⇒ *page 155, fig. 156* and tells you when the front Advanced Airbag on the passenger side has been turned off.
- A sensor below the safety belt latch for the front seat passenger to measure the tension on the safety belt. The tension on the safety belt and the weight registered by the weight-sensing mat help the control unit “decide” whether the front airbag for the front passenger seat should be turned off or not ⇒ *page 145, Child restraints on the front seat – some important things to know*.
- A sensor in the safety belt latch for the driver and for the front seat passenger that senses whether that safety belt is latched or not and transmits this information to the electronic control unit.



#### WARNING

Damage to the front passenger seat can prevent the front airbag from working properly.

- Improper repair or disassembly of the front passenger and driver seat will prevent the Advanced Airbag System from functioning properly.

- Repairs to the front passenger seat must be performed by qualified and properly trained workshop personnel.
- Never remove the front passenger or driver seat from the vehicle.
- Never remove the upholstery from the front passenger seat.
- Never disassemble or remove parts from the seat or disconnect wires from it.
- Never carry sharp objects in your pockets or place them on the seat. If the weight-sensing mat in the passenger seat is punctured it cannot work properly.
- Never carry things on your lap or carry objects on the passenger seat. Such items can increase the weight registered by the weight-sensing mat and send the wrong information to the airbag control unit.
- Never store items under the front passenger seat. Parts of the Advanced Airbag System under the passenger seat could be damaged, preventing them and the airbag system from working properly.
- Never place seat covers or replacement upholstery that have not been specifically approved by Audi on the front seats.
- Seat covers can prevent the Advanced Airbag System from recognizing child restraints or occupants on the front passenger seat and prevent the side airbag in the seat backrest from deploying properly.
- Never use cushions, pillows, blankets or similar items on the front passenger seat. The additional padding will prevent the weight-sensing mat in the seat from accurately registering the child restraint or person on the seat and prevent the Advanced Airbag System from functioning properly.
- If you must use a child restraint on the front passenger seat and the child restraint manufacturer's instructions require the use of a towel, foam cushion or something else to properly position the child restraint, make certain that the

**PASSENGER AIR BAG OFF** light comes on and stays on whenever the child restraint is installed on the front passenger seat.

- If the **PASSENGER AIR BAG OFF** light does not come on and stay on, immediately install child restraint in a rear seating position and have the airbag system inspected by your authorized Audi dealer.

### How the Advanced Airbag System components work together

The front Advanced Airbag System and the side airbags supplement the protection offered by the front three-point safety belts with pretensioners and load limiters and the adjustable head restraints to help reduce the risk of injury in a wide range of accident and crash situations. Be sure to read the important information about safety and heed the **WARNINGS** in this chapter.

Deployment of the Advanced Airbag System and the activation of the safety belt pretensioners depend on the deceleration measured by the crash sensors and registered by the electronic control unit. Crash severity depends on speed and deceleration as well as the mass and stiffness of the vehicle or object involved in the crash.

On the passenger side, regardless of safety belt use, the airbag will be turned off if the weight on the passenger seat is less than the amount programmed in the electronic control unit. The front airbag on the passenger side will also be turned off if one of the child safety seats that has been certified under Federal Motor Vehicle Safety Standard 208 has been recognized on the seat. The **PASSENGER AIR BAG OFF** light comes on and stays on to tell you when the front Advanced Airbag on the passenger side has been turned off  
 ⇒ *page 145, Child restraints on the front seat – some important things to know.* ►

**! WARNING**

To reduce the risk of injury when an airbag inflates, always wear safety belts properly.

- If you are unrestrained, leaning forward, sitting sideways or out of position in any way, your risk of injury is much higher.
- You will also receive serious injuries and could even be killed if you are up against the airbag or too close to it when it inflates - even with an Advanced Airbag  
⇒ page 144.

**More important things to know about front airbags**

Fig. 155 Inflated front airbags

Safety belts are important to help keep front seat occupants in the proper seated position so that airbags can unfold properly and provide supplemental protection in a frontal collision.

The front airbags are designed to provide additional protection for the chest and face of the driver and the front seat passenger when:

- safety belts are worn properly,
- the seats have been positioned so that the occupant is properly seated as far as possible from the airbag,
- and the head restraints have been properly adjusted.

Because airbags inflate in the blink of an eye with great force, things you have on your lap or have placed on the seat could become dangerous projectiles, and be pushed into you if the airbag inflates.

When an airbag deploys, fine dust is released. This is normal and is not caused by a fire in

the vehicle. This dust is made up mostly of a powder used to lubricate the airbags as they deploy. It could irritate skin.

It is important to remember that while the supplemental airbag system is designed to reduce the likelihood of serious injuries, other injuries, for example swelling, bruising and minor abrasions, can also happen when airbags inflate. Airbags do not protect the arms or the lower parts of the body. Front airbags only supplement the three point safety belts in some frontal collisions in which the vehicle deceleration is high enough to deploy the airbags.

**Front airbags will not deploy:**

- if the ignition is switched off when a crash occurs,
- in side collisions,
- in rear-end collisions,
- in rollovers,
- when the crash deceleration measured by the airbag system is less than the minimum threshold needed for airbag deployment as registered by the electronic control unit.

**The front passenger airbag will also not deploy:**

- when the front passenger seat is not occupied,
- when the weight on the front passenger seat as sensed by the Advanced Airbag System indicates that the front airbag on the passenger side has to be turned off by the electronic control unit (the **PASSENGER AIR BAG OFF** light comes on and stays on).

**! WARNING**

Sitting in the wrong position can increase the risk of serious injury in crashes.

- To reduce the risk of injury when the airbags inflate, the driver and passengers must always sit in an upright position, must not lean against or place any part of their body too close to the area where the airbags are located.

- Occupants who are unbelted, out of position or too close to the airbag can be seriously injured by an airbag as it unfolds with great force in the blink of an eye ⇒ page 145.

### WARNING

A child in a rearward-facing child safety seat installed on the front passenger seat will be seriously injured and can be killed if the front airbag inflates - even with an Advanced Airbag System.

- The inflating airbag will hit the child safety seat or infant carrier with great force and will smash the child safety seat and child against the backrest, center armrest, door or roof.
- Always install rear-facing child safety seats on the rear seat.
- If you must install a rearward facing child safety seat on the front passenger seat because of exceptional circumstances and the **PASSENGER AIR BAG OFF** light does not come on and stay on, immediately install the rear-facing child safety seat in a rear seating position and have the airbag system inspected by your authorized Audi dealer.

### WARNING

Objects between you and the airbag will increase the risk of injury in a crash by interfering with the way the airbag unfolds or by being pushed into you as the airbag inflates.

- Never hold things in your hands or on your lap when the vehicle is in use.
- Never transport items on or in the area of the front passenger seat. Objects could move into the area of the front airbags during braking or other sudden maneuver and become dangerous projectiles that can cause serious personal injury if the airbags inflate.
- Never place or attach accessories or other objects (such as cupholders, telephone brackets, large, heavy or bulky ob-

jects) on the doors, over or near the area marked “AIRBAG” on the steering wheel, instrument panel, seat backrests or between those areas and yourself. These objects could cause injury in a crash, especially when the airbags inflate.

- Never recline the front passenger's seat to transport objects. Items can also move into the area of the side airbag or the front airbag during braking or in a sudden maneuver. Objects near the airbags can become projectiles and cause injury, particularly when the seat is reclined.

### WARNING

The fine dust created when airbags deploy can cause breathing problems for people with a history of asthma or other breathing conditions.

- To reduce the risk of breathing problems, those with asthma or other respiratory conditions should get fresh air right away by getting out of the vehicle or opening windows or doors.
- If you are in a collision in which airbags deploy, wash your hands and face with mild soap and water before eating.
- Be careful not to get the dust into your eyes, or into any cuts or scratches.
- If the residue should get into your eyes, flush them with water.

## Monitoring the Advanced Airbag System

### Airbag monitoring indicator light

*Two separate indicators monitor the function of the Advanced Airbag System: the airbag monitoring indicator light and the **PASSENGER AIR BAG OFF** light.*

The Advanced Airbag System (including the electronic control unit, sensor circuits and system wiring) is monitored continuously to make sure that it is functioning properly

whenever the ignition is on. Each time you turn on the ignition, the **AIR BAG** airbag monitoring indicator light will come on for a few seconds (self diagnostics).

### The system must be inspected when the **AIR BAG** indicator light :

- does not come on when the ignition is switched on,
- does not go out a few seconds after you have switched on the ignition, or
- comes on while driving.

If an airbag system malfunction is detected, the indicator light will first start flashing to catch the driver's attention and then stay on continuously to serve as a constant reminder to have the system inspected immediately.

If a malfunction occurs that turns the front airbag on the passenger side off, the **PASSENGER AIR BAG OFF** light will come on and stay on whenever the ignition is on.

#### **WARNING**

An airbag system that is not functioning properly cannot provide supplemental protection in a frontal crash.

- If the airbag indicator light ⇒ *page 20* comes when the vehicle is being used, have the system inspected immediately by your authorized Audi dealer. It is possible that the airbag will inflate when it is not supposed to, or will not inflate when it should.

### PASSENGER AIR BAG OFF light



**Fig. 156** Section from the instrument panel: PASSENGER AIR BAG OFF light

The **PASSENGER AIR BAG OFF** light is located in the center of the instrument panel ⇒ *fig. 156*.

The **PASSENGER AIR BAG OFF** light will come on and stay on to tell you when the front Advanced Airbag on the passenger side has been turned off by the electronic control unit. Each time you turn on the ignition, the **PASSENGER AIR BAG OFF** light will flash for a few seconds and:

- will stay on if the front passenger seat is not occupied,
- will stay on if there is a small child or child restraint on the front passenger seat,
- will go out if the front passenger seat is occupied by an adult as registered by the weight-sensing mat.

The **PASSENGER AIR BAG OFF** light must come on and stay on if the ignition is on and

- a car bed has been installed on the front seat, or
- a rearward-facing child restraint has been installed on the front passenger seat, or
- a forward-facing child restraint has been installed on the front passenger seat, or
- the weight registered on the front passenger seat is equal to or less than the combined weight of a typical 1 year-old restrained in one of the rear-facing or forward-facing infant restraints listed in Federal Motor Vehicle Safety Standard 208 with which the Advanced Airbag System in your vehicle was certified.

If the front passenger seat is not occupied, the front airbag will not deploy, and the **PASSENGER AIR BAG OFF** light will stay on. Never install a rearward-facing child restraint on the front passenger seat, the safest place for a child in any kind of child restraint is at one of the seating positions on the rear seat ⇒ *page 145, Child restraints on the front seat – some important things to know* and ⇒ *page 165, Child Safety*.

**If the PASSENGER AIR BAG OFF light comes on** when one of the conditions listed above is met, be sure to check the light regularly to

make certain that the **PASSENGER AIR BAG OFF** light stays on continuously whenever the ignition is on. If the **PASSENGER AIR BAG OFF** light does not appear and not stay on all the time, stop as soon as it is safe to do so and

- reactivate the system by turning the ignition off and then turning it on again;
- remove and reinstall the child restraint. Make sure that the child restraint is properly installed and that the safety belt for the front passenger seat has been correctly routed around the child restraint as described in the child restraint manufacturer's instructions;
- make sure that the convertible locking retractor on the safety belt for the front passenger seat has been activated and that the safety belt has been pulled tight. The belt must not be loose or have loops of slack so that the sensor below the safety belt latch on the seat can do its job ⇒ *page 175*.
- make sure that things that may increase the weight of the child and child safety seat are not being transported on the front passenger seat;
- make sure that the safety belt tension sensor is not blocked. Shake the safety belt latch on the front passenger seat back and forth;
- If a strap or tether is being used to tie the child safety seat to the front passenger seat, make sure that it is not so tight that it causes the weight-sensing mat to measure more weight than is actually on the seat.

**If the PASSENGER AIR BAG OFF light still does not come on** and does not stay on continuously (when the ignition is switched on),

- take the child restraint off the front passenger seat and install it properly at one of the rear seat positions. Have the airbag system inspected by your authorized Audi dealer immediately.
- move the child to a rear seat position and make sure that the child is properly restrained in a child restraint that is appropriate for its size and age.

The **PASSENGER AIR BAG OFF** light should NOT come on when the ignition is on and an adult is sitting in a proper seating position on the front passenger seat. If the **PASSENGER AIR BAG OFF** light comes on and stays on or flashes for about 5 seconds while driving, under these circumstances, make sure that:

- the adult on the front passenger seat is properly seated on the center of the seat cushion with his or her back up against the backrest and the backrest is not reclined ⇒ *page 127, Proper occupant seating positions*,
- the adult is not taking weight off the seat by holding on to the passenger assist handle above the front passenger door or supporting their weight on the armrest,
- the safety belt is being properly worn and that there is not a lot of slack in the safety belt webbing,
- accessory seat covers or cushions or other things that may cause an incorrect reading or impression on the weight-sensing mat under the upholstery of the seat have been removed from the front passenger seat,
- a safety belt extender has not been left in the safety belt latch for the front passenger seat.

In addition to the **PASSENGER AIR BAG OFF** light in the center of the instrument panel, the message **PASSENGER AIR BAG OFF** or **PASSENGER AIR BAG ON** will briefly appear in the instrument cluster display. This is to inform the driver of the current front passenger airbag status.

### Important safety instructions on monitoring the Advanced Airbag System

#### WARNING

An airbag system that is not functioning properly cannot provide supplemental protection in a frontal crash.

- If the airbag indicator light ⇒ *page 20* comes when the vehicle is being used, have the system inspected immediately by your authorized Audi dealer. It is

possible that the airbag will inflate when it is not supposed to, or will not inflate when it should.

### WARNING

If the front airbag inflates, a child without a child restraint, in a rearward-facing child safety seat or in a forward-facing child restraint that has not been properly installed will be seriously injured and can be killed.

- Even though your vehicle is equipped with an Advanced Airbag System, make certain that all children, especially 12 years and younger, always ride on the back seat properly restrained for their age and size.
- Always install forward or rear-facing child safety seats on the rear seat – even with an Advanced Airbag System.
- If you must install a rearward-facing child safety seat on the front passenger seat because of exceptional circumstances and the **PASSENGER AIR BAG OFF** light does not appear and stay on, immediately install the rear-facing child safety seat in a rear seating position and have the airbag system inspected by your authorized Audi dealer.
- A tight tether or other strap on a rearward-facing child restraint attached to the front passenger seat can put too much pressure on the weight-sensing mat in the seat and register more weight than is actually on the seat. The heavier weight registered can make the system work as though an adult were on the seat and deploy the Advanced Airbag when it must be suppressed causing serious or even fatal injury to the child.
- If, in exceptional circumstances, you must install a forward-facing child restraint on the front passenger seat, always move the seat into its rearmost position in the seat's fore and aft adjustment range, as far away from the airbag as possible. The backrest must be adjusted to an upright position. Make sure that

the **PASSENGER AIR BAG OFF** light comes on and stays on all the time whenever the ignition is switched on.

### WARNING

- If the **PASSENGER AIR BAG OFF** light does not go out when an adult is sitting on the front passenger seat after taking the steps described above, make sure the adult is properly seated and restrained at one of the rear seating positions.
- Have the airbag system inspected by your authorized Audi dealer before transporting anyone on the front passenger seat.

### Tips

If the weight-sensing mat in the front passenger seat detects an empty seat, the front airbag on the passenger side will be turned off, and **PASSENGER AIR BAG OFF** will stay on.

### Repair, care and disposal of the airbags

Parts of the airbag system are installed at many different places on your Audi. Installing, removing, servicing or repairing a part in an area of the vehicle can damage a part of an airbag system and prevent that system from working properly in a collision.

There are some important things you have to know to make sure that the effectiveness of the system will not be impaired and that discarded components do not cause injury or pollute the environment.

### WARNING

Improper care, servicing and repair procedures can increase the risk of personal injury and death by preventing an airbag from deploying when needed or deploying an airbag unexpectedly:

- Never cover, obstruct, or change the steering wheel horn pad or airbag cover or the instrument panel or modify them in any way.

- Never attach any objects such as cupholders or telephone mountings to the surfaces covering the airbag units.
- For cleaning the horn pad or instrument panel, use only a soft, dry cloth or one moistened with plain water. Solvents or cleaners could damage the airbag cover or change the stiffness or strength of the material so that the airbag cannot deploy and protect properly.
- Never repair, adjust, or change any parts of the airbag system.
- All work on the steering wheel, instrument panel, front seats or electrical system (including the installation of audio equipment, cellular telephones and CB radios, etc.) must be performed by a qualified technician who has the training and special equipment necessary.
- For any work on the airbag system, we strongly recommend that you see your authorized Audi dealer or qualified workshop.
- Never modify the front bumper or parts of the vehicle body.
- Always make sure that the side airbag can inflate without interference:
  - Never install seat covers or replacement upholstery over the front seatbacks that have not been specifically approved by Audi.
  - Never use additional seat cushions that cover the areas where the side airbags inflate.
  - Damage to the original seat covers or to the seam in the area of the side airbag module must always be repaired immediately by an authorized Audi dealer.
- The airbag system can be activated only once. After an airbag has inflated, it must be replaced by an authorized Audi dealer or qualified technician who has the technical information, training and special equipment necessary.
- The airbag system can be deployed only once. After an airbag has been deployed, it must be replaced with new replace-

ment parts designed and approved especially for your Audi model version. Replacement of complete airbag systems or airbag components must be performed by qualified workshops only. Make sure that any airbag service action is entered in your Audi Warranty & Maintenance booklet under *AIRBAG REPLACEMENT RECORD*.

- In accidents when an airbag is deployed, the vehicle battery separates the alternator and the starter from the vehicle electrical system for safety reasons with a pyrotechnic circuit interrupter.
  - Work on the pyrotechnic circuit interrupter must only be performed by a qualified dealer - risk of an accident!
  - If the vehicle or the circuit interrupter is scrapped, all applicable safety precautions must be followed.



#### For the sake of the environment

Undeployed airbag modules and pretensioners might be classified as Perchlorate Material -special handling may apply, see [www.dtsc.ca.gov/hazardouswaste/perchlorate](http://www.dtsc.ca.gov/hazardouswaste/perchlorate). When the vehicle or parts of the restraint system including airbag modules safety belts with pretensioners are scrapped, all applicable laws and regulations must be observed. Your authorized Audi dealer is familiar with these requirements and we recommend that you have your dealer perform this service for you.

#### Other things that can affect Advanced Airbag performance

Changing the vehicle's suspension system can change the way that the Advanced Airbag System performs in a crash. For example, using tire-rim combinations not approved by Audi, lowering the vehicle, changing the stiffness of the suspension, including the springs, suspension struts, shock absorbers etc. can change the forces that are measured by the airbag sensors and sent to the electronic control unit. Some suspension changes can, for

example, increase the force levels measured by the sensors and make the airbag system deploy in crashes in which it would not deploy if the changes had not been made. Other kinds of changes may reduce the force levels measured by the sensors and prevent the airbag from deploying when it should.

### WARNING

Changing the vehicle's suspension including use of unapproved tire-rim combinations can change Advanced Airbag performance and increase the risk of serious personal injury in a crash.

- Never install suspension components that do not have the same performance characteristics as the components originally installed on your vehicle.
- Never use tire-rim combinations that have not been approved by Audi.

### WARNING

Items stored between the safety belt buckle and the center console can cause the sensors in the buckle to send the wrong information to the electronic control module and prevent the Advanced Airbag System from working properly.

- Always make sure that nothing can interfere with the safety belt buckles and that they are not obstructed.

## Side airbags

### Description of side airbags

*The airbag system can provide supplemental protection to properly restrained occupants.*



**Fig. 157** Side airbag location in the driver's seat

The side airbags are located in the sides of the front seat backrests ⇒ *fig. 157* and the rear backrest facing the doors. They are identified by the word "AIRBAG".

### The side airbag system basically consists of:

- the electronic control module and external side impact sensors
- the two airbags located in the sides of the front backrests and the two airbags\* located in the rear backrest
- the airbag warning light in the instrument cluster.

The airbag system is monitored electronically to make certain that it is functioning properly at all times. Each time you turn on the ignition, the airbag system indicator light will come on for a few seconds (self diagnostics).

The side airbag system supplements the safety belts and can help to reduce the risk of injury to the driver's and front passenger's upper torso on the side of the vehicle that is struck in a side collision. The airbag deploys only in side impacts and only when the vehicle acceleration registered by the control unit is high enough. If this rate is below the reference value programmed into the control unit, the side airbags will not be triggered, even though the car may be badly damaged as a result of the collision. It is not possible to define an airbag triggering range that will cover every possible angle of impact, since the circumstances will vary considerably between one collision and another. Important factors include, for example, the nature (hard or soft) of the impacting object, the angle of impact, vehicle speed, etc. ⇒ *page 161, Important safety instructions on the side airbag system.*

Aside from their normal safety function, safety belts work to help keep the driver or front passenger in position in the event of a side collision so that the side airbags can provide protection.

The airbag system is *not* a substitute for your safety belt. Rather, it is part of the overall occupant restraint system in your vehicle. Always remember that the side airbag system

can only help to protect you if you are wearing your safety belt and wearing it properly. This is another reason why you should always wear your safety belts, not just because the law requires you to do so ⇒ *page 136, General notes*.

It is important to remember that while the supplemental side airbag system is designed to reduce the likelihood of serious injuries, other injuries, for example, swelling, bruising, and minor abrasions can also be associated with deployed side airbags. Remember too, side airbags will deploy only once and only in certain kinds of accidents - your safety belts are always there to offer protection.

Vehicle damage, repair costs or even the lack of vehicle damage are not necessarily an indication of over-sensitive or failed airbag activation. In some collisions, both front and side airbags may inflate. Remember too, that airbags will deploy only once and only in certain kinds of collisions - your safety belts are always there to offer protection in those accidents in which airbags are not supposed to deploy or when they have already deployed.

#### The side airbag system will not deploy:

- when the ignition is turned off
- in side collisions when the acceleration measured by the sensor is too low
- in front-end collisions
- in rear-end collisions
- in rollovers.

In some types of accidents the front airbags, side curtain airbags and side airbags may be triggered together.

#### WARNING

- Safety belts and the airbag system will only provide protection when occupants are in the proper seating position ⇒ *page 161*.
- If the airbag indicator light ⇒ *page 20* comes when the vehicle is being used, have the system inspected immediately by your authorized Audi dealer. It is pos-

sible that the airbag will inflate when it is not supposed to, or will not inflate when it should.

#### How supplemental side airbags work

*Side airbags deploy instantly and can help reduce the risk of upper torso injuries for occupants who are properly restrained.*

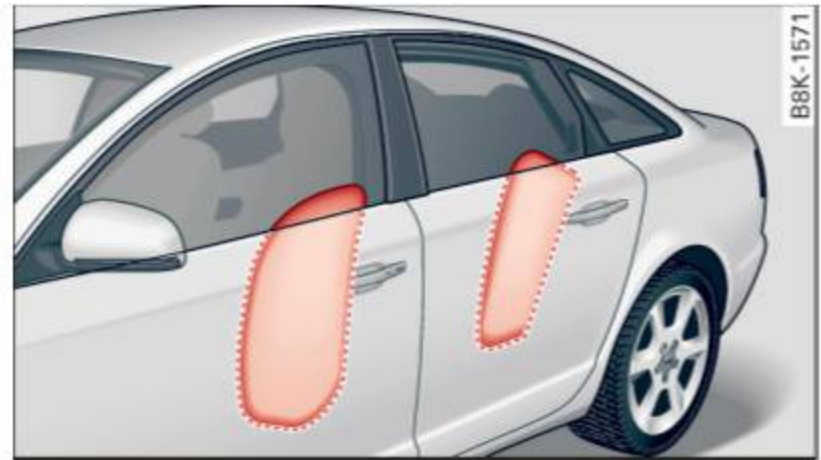

Fig. 158 Inflated side airbags on left side of vehicle

When the system is triggered, the airbag is filled with propellant gas and breaks through a seam in the seat surface area marked "AIR-BAG". It expands between the side trim panel and the passenger. In order to help provide this additional protection, the side airbag must inflate within a fraction of a second at very high speed and with great force. The supplemental side airbag could injure you if your seating position is not proper or upright or if items are located in the area where the supplemental side airbag expands. This applies especially to children ⇒ *page 165, Child Safety*. Supplemental side airbags inflate between the occupant and the door panel on the side of the vehicle that is struck in certain side collision ⇒ *fig. 158*.

Although they are not a soft pillow, they can "cushion" the impact and in this way they can help to reduce the risk of injury to the upper part of the body.

A fine dust may develop when the airbag deploys. This is normal and does not mean there is a fire in the vehicle.

## Important safety instructions on the side airbag system

*Airbags are only supplemental restraints. Always properly wear safety belts and ride in a proper seating position.*

There is a lot that you and your passengers must know and act accordingly to help the safety belts and airbags do their job to provide supplemental protection.

### WARNING

An inflating side airbag can cause serious or fatal injury. Improperly wearing safety belts and improper seating positions increase the risk of serious personal injury and death whenever a vehicle is being used.

- In order to reduce the risk of injury when the supplemental side airbag inflates:
  - Always sit in an upright position and never lean against the area where the supplemental side airbag is located.
  - Never let a child or anyone else rest their head against the side trim panel in the area where the supplemental side airbag inflates.
  - Always make sure that safety belts are worn correctly,
  - Do not let anyone sitting in the front seat put their hand or any other parts of their body out of the window.
- Always make sure that the side airbag can inflate without interference.
  - Never install seat covers or replacement upholstery over the front seat-backs that have not been specifically approved by Audi.
  - Never use additional seat cushions that cover the areas where the side airbags deploy.
  - Damage to the original seat covers or to the seam in the area of the side airbag module must always be repaired immediately by an authorized Audi dealer.

- Objects between you and the airbag can increase the risk of injury in an accident by interfering with the way the airbag unfolds or by being pushed into you as the airbag inflates.
- Never place or attach accessories or other objects (such as cupholders, telephone brackets, or even large, bulky objects) on the doors, over or near the area marked “AIRBAG” on the seat backrests.
- Such objects and accessories can become dangerous projectiles and cause injury when the supplemental side airbag deploys.
- Never carry any objects or pets in the deployment space between them and the airbags or allow children or other passengers to travel in this position.
- Always use the built-in coat hooks only for lightweight clothing. Never leave any heavy or sharp-edged objects in the pockets that may interfere with side airbag deployment and can cause personal injury in an accident.
- Always prevent the side airbags from being damaged by heavy objects knocking against or hitting the sides of the seat-backs.
- The airbag system can only be triggered once. If the airbag has been triggered, the system must be replaced by an authorized Audi dealership.
- Damage (cracks, deep scratches etc.) to the original seat covers or to the seam in the area of the side airbag module must always be repaired immediately by an authorized Audi dealer.
- If children are seated improperly, their risk of injury increases in the case of an accident ⇒ *page 165, Child Safety*.
- Never attempt to modify any components of the airbag system in any way.
- In a side collision, side airbags will not function properly if sensors cannot correctly measure increasing air pressure inside the doors when air escapes through

larger, unclosed openings in the door panel.

- Never drive with interior door trim panels removed.
- Never drive when parts have been removed from the inside door panel and the openings they leave have not been properly closed.
- Never drive when loudspeakers in the doors have been removed unless the speaker holes have been properly closed.
- Always make certain that openings are covered or filled if additional speakers or other equipment is installed in the inside door panels.
- Always have work on the doors done by an authorized Audi dealer or qualified workshop.

## Side curtain airbags

### Description of side curtain airbags

*The side curtain airbag system can provide supplemental protection to properly restrained occupants.*



**Fig. 159** Side curtain system, driver's side: side curtain airbag location

The side curtain airbags are located on both sides of the interior above the front and rear side windows ⇒ *fig. 159*. They are identified by the word “AIRBAG” on the windshield frame and the center roof pillar.

The side curtain airbag system supplements the safety belts and can help to reduce the risk of injury for occupants' heads and upper torso on the side of the vehicle that is struck

in a side collision. The side curtain airbag inflates in side impacts and only when the vehicle acceleration registered by the control unit is high enough. If this rate is below the reference value programmed into the control unit, the side airbags will not be triggered, even though the car may be badly damaged as a result of the collision. It is not possible to define an airbag triggering range that will cover every possible angle of impact, since the circumstances will vary considerably between one collision and another. Important factors include, for example, the nature (hard or soft) of the impacting object, the angle of impact, vehicle speed, etc. ⇒ *page 163, How side curtain airbags work.*

Aside from their normal safety function, safety belts work to help keep the driver or front passenger in position in the event of a collision so that the side curtain airbags can provide protection.

The airbag system is not a substitute for your safety belt. Rather, it is part of the overall occupant restraint system in your vehicle. Always remember that the airbag system can only help to protect you if you are wearing your safety belt and wearing it properly. This is another reason why you should always wear your safety belts, not just because the law requires you to do so ⇒ *page 136, General notes.*

It is important to remember that while the side curtain airbag system is designed to help reduce the likelihood of serious injuries, other injuries, for example, swelling, bruising, and minor abrasions can also be associated with these airbags. Remember too, these airbags will deploy only once and only in certain kinds of accidents - your safety belts are always there to offer protection.

### The side curtain airbag system basically consists of:

- The electronic control module and external side impact sensors
- The side curtain airbags above the front and rear side windows

- The airbag indicator light in the instrument panel

The airbag system is monitored electronically to make certain it is functioning properly at all times. Each time you turn on the ignition, the airbag system indicator light will come on for a few seconds (self diagnostics).

#### The side curtain airbag is not activated:

- if the ignition is turned off,
- in side collisions when the acceleration measured by the sensor is too low,
- in rear-end collisions,
- in rollovers.

#### WARNING

- Safety belts and the airbag system will only provide protection when occupants are in the proper seating position ⇒ *page 60, Seats and storage.*
- If the airbag indicator light ⇒ *page 20* comes when the vehicle is being used, have the system inspected immediately by your authorized Audi dealer. It is possible that the airbag will inflate when it is not supposed to, or will not inflate when it should.

#### How side curtain airbags work

Side curtain airbags can work together with side airbags to help reduce the risk of head and upper torso injuries for occupants who are properly restrained.

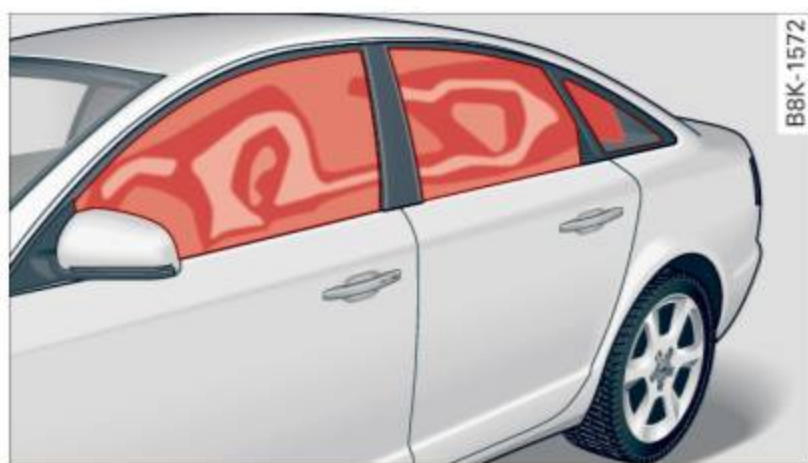

**Fig. 160** Illustration of principle: Inflated side curtain airbags on the left side

The side curtain airbags inflate between the occupant and the windows on the side of the

vehicle that is struck in a side collision ⇒ *fig. 160.*

When the system is triggered, the side curtain airbag is filled with propellant gas and breaks through a seam above the front and rear side windows identified by the AIRBAG label. In order to help provide this additional protection, the side curtain airbag must inflate within the blink of an eye at very high speed and with great force. The side curtain airbag could injure you if your seating position is not proper or upright or if items are located in the area where the supplemental side curtain airbag inflates. This applies especially to children ⇒ *page 165.*

Although they are not a soft pillow, side curtain airbags can “cushion” the impact and in this way they can help to reduce the risk of injury to the head and the upper part of the body.

A fine dust may develop when the airbag deploys. This is quite normal and does not mean there is a fire in the vehicle.

#### Important safety instructions on the side curtain airbag system

*Airbags are only supplemental restraints. Always properly wear safety belts and ride in a proper seating position.*

There is a lot that you and your passengers must know and do to help the safety belts and airbags do their job to provide supplemental protection.

#### WARNING

- Improperly wearing safety belts and improper seating positions increase the risk of serious personal injury and death whenever a vehicle is being used.
- Never let occupants place any parts of their bodies in the area from which the side curtain airbags inflate.
  - Always make sure that the side curtain airbags can inflate without interference. Unsuitable accessories fitted inside the

expansion range of a head airbag can dangerously interfere with its function. A deploying head airbag develops enough force to catapult any piece of add-on component out of its path of inflation and into the passenger compartment. An occupant hit by such a projectile can suffer serious injury or death ⇒ *page 286, Technical Modifications.*

- Do not swivel the sun visors to the side if you have any objects clipped onto them (for example pens). If the airbag should deploy, you could be injured by these objects.
- Use the built-in coat hooks only for lightweight clothing. Never leave any heavy or sharp-edged objects in the pockets that may interfere with airbag deployment and can cause personal injury in an accident.
- Never use hangers to hang clothing from the hooks.
- Only use factory-installed sun shades or, in the case of shades installed after the vehicle leaves the factory, only Audi roll-up sunscreens may be used ⇒ *page 285, Additional accessories and parts replacement.*
- Always sit in proper seating position and wear safety belts while traveling so that the side curtain airbags can help provide protection.
- The airbag system can only be triggered once. If the airbag has been triggered, the system must be replaced by an authorized Audi dealer or qualified workshop.
- Always have work involving the side curtain airbag system, removal and installation of the airbag components, or other repairs performed by an authorized Audi dealer or qualified workshop. Otherwise the airbag system may not work correctly.
- Never attempt to modify any components of the airbag system in any way.

## Child Safety

### Important things to know

#### Introduction

*The rear seat is generally the safest place in a collision.*

The physical principles of what happens when your vehicle is in a crash apply also to children ⇒ *page 137, What happens to occupants not wearing safety belts?*. But unlike adults their muscles and bones are not fully developed. In many respects children are at greater risk of serious injury in crashes than adults.

Because children's bodies are not fully developed, they require restraint systems especially designed for their size, weight, and body structure. Many countries and all states of the United States and provinces of Canada have laws requiring the use of approved child restraint systems for infants and small children.

In a frontal crash at a speed of 20-35 mph (30-56 km/h) the forces acting on a 13-pound (6 kg) infant will be more than 20 times the weight of the child. This means the weight of the child would suddenly be more than 260 pounds (120 kg). Under these conditions, only an appropriate child restraint properly used can reduce the risk of serious injury. Child restraints must be used properly to be effective. Used improperly, they can increase the risk of serious injury in an accident.

Consult the child safety seat manufacturer's instructions to be sure the seat is right for your child's size ⇒ *page 168, Important safety instructions for using child safety seats*. Please be sure to read and heed all of the important information and WARNINGS about child safety, Advanced Airbags, and the installation of child restraints in this chapter.

There is a lot you need to know about the Advanced Airbags in your vehicle and how they work when infants and children in child restraints are on the front passenger seat. Because of the large amount of important infor-

mation, we cannot repeat it all here. We urge you to read the detailed information in this owner's manual about airbags and the Advanced Airbag System in your vehicle and the very important information about transporting children on the front passenger seat. Please be sure to heed the WARNINGS - they are extremely important for your safety and the safety of your passengers, especially infants and small children.

#### WARNING

- Accident statistics have shown that children are generally safer in the rear seat area than in the front seating position. Always restrain any child age 12 and under in the rear.
- All vehicle occupants and especially children must be restrained properly whenever riding in a vehicle. An unrestrained or improperly restrained child could be injured by striking the interior or by being ejected from the vehicle during a sudden maneuver or impact. An unrestrained or improperly restrained child is also at greater risk of injury or death through contact with an inflating airbag.
- A suitable child restraint properly installed and used at one of the rear seating positions provides the highest degree of protection for infants and small children in most accident situations.

#### WARNING

- Children on the front seat of any car even with Advanced Airbags can be seriously injured or even killed when an airbag inflates. A child in a rearward-facing child safety seat installed on the front passenger seat will be seriously injured and can be killed if the front airbag inflates.
- The inflating airbag will hit the child safety seat or infant carrier with great force and will smash the child safety seat and child against the backrest, center armrest or door.
  - Always install rearward-facing child safety seats on the rear seat.

- If you must install a rearward facing child safety seat on the front passenger seat in exceptional circumstances and the **PASSENGER AIR BAG OFF** light does not come on and stay on, immediately install the rearward-facing child safety seat in a rear seating position and have the airbag system inspected immediately by your authorized Audi dealer.

### **WARNING**

If, in exceptional circumstances, you must install a forward-facing child restraint on the front passenger's seat:

- Always make sure the forward-facing seat has been designed and certified by its manufacturer for use on a front seat with a passenger front and side airbag.
- Always follow the manufacturer's instructions provided with the child safety seat or carrier.
- Always move the passenger seat into its rearmost position in the seat's fore and aft adjustment range, as far away from the airbag as possible before installing the child restraint. The backrest must be adjusted to an upright position.
- Always make sure that the **PASSENGER AIR BAG OFF** light comes on and stays on all the time whenever the ignition is switched on.

### **Tips**

Always replace child restraints that were installed in a vehicle during a crash. Damage to a child restraint that is not visible could cause it to fail in another collision situation.

### **Advanced front airbag system and children**

Your vehicle is equipped with a front “Advanced Airbag System” in compliance with United States Federal Motor Vehicle Safety Standard (FMVSS) 208 as applicable at the time your vehicle was manufactured.

The Advanced Airbag system in your vehicle has been certified to meet the “low-risk” requirements for 3- and 6-year old children on the passenger side and small adults on the driver side. The low risk deployment criteria are intended to reduce the risk of injury through interaction with the airbag that can occur, for example, by being too close to the steering wheel and instrument panel when the airbag inflates. In addition, the system has been certified to comply with the “suppression” requirements of the Safety Standard, to turn off the front airbag for infants up to 12 months who are restrained on the front passenger seat in child restraints that are listed in the Standard.

Even though your vehicle is equipped with an Advanced Airbag system, all children, especially those 12 years and younger, should always ride in the back seat properly restrained for their age and size. The airbag on the passenger side makes the front seat a potentially dangerous place for a child to ride. The front seat is not the safest place for a child in a forward-facing child safety seat. It can be a very dangerous place for an infant or a larger child in a rearward-facing seat.

### **Advanced Airbags and the weight-sensing mat in the front seat**

The Advanced Airbag System in your vehicle detects the presence of an infant or child in a child restraint on the front passenger seat using the weight-sensing mat in the seat cushion and the sensor below the safety belt latch on the front passenger seat that measures the tension on the safety belt.

The weight-sensing mat measures total weight of the child and the child safety seat and a child blanket on the front passenger seat. The weight on the front passenger seat is related to the design of the child restraint and its “footprint”, the size and shape of the bottom of the child restraint as it sits on the seat. The weight of a child restraint and its “footprint” vary for different kinds of child restraints and for the different models of the

same kind of child restraint offered by child restraint manufacturers.

The weight ranges for the individual types, makes and models of child restraints that the NHTSA has specified in the Safety Standard together with the weight ranges of typical infants and typical 1 year-old child have been stored in the control unit of the Advanced Airbag System. When a child restraint is being used on the front passenger seat with a typical 1 year-old child, the Advanced Airbag System compares the weight measured by the weight sensing mat with the information stored in the electronic control unit.

The electronic control unit also registers the tension on the front passenger safety belt. The tension on the safety belt for the front passenger seat will be different for an adult who is properly using the safety belt as compared to the tension on the belt when it is used to attach a child restraint to the seat. The sensor below the latch for the safety belt for the front seat passenger measures the tension on the belt. The input from this sensor is then used with the weight to “decide”, whether there is a child restraint with a typical 1 year-old child on the front passenger seat and whether or not the airbag must be turned off.

**Child restraints and Advanced Airbags**

Regardless of the child restraint that you use, make sure that it has been certified to meet United States Federal Motor Vehicle Safety Standards and has been certified by its manufacturer for use with an airbag. Always be sure that the child restraint is properly installed at one of the rear seating positions. If in exceptional circumstances you must use it on the front passenger seat, carefully read all of the information on child safety and Advanced Airbags and heed all of the applicable WARNINGS. Make certain that the child restraint is correctly recognized by the weight-sensing mat inside the front passenger seat, that the front passenger airbag is turned off and that

the airbag status is always correctly signaled by the **PASSENGER AIR BAG OFF** light.

Many types and models of child restraints have been available over the years, new models are introduced regularly incorporating new and improved designs and older models are taken out of production. Child restraints are not standardized. Child restraints of the same type typically have different weights and sizes and different 'footprints,' the size and shape of the bottom of the child restraint that sits on the seat, when they are installed on a vehicle seat. These differences make it virtually impossible to certify compliance with the requirements for advanced airbags with each and every child restraint that has ever been sold in the past or will be sold over the course of the useful life of your vehicle.

For this reason, the United States National Highway Traffic Safety Administration has published a list of specific type, makes and models of child restraints that must be used to certify compliance of the Advanced Airbag System in your vehicle with the suppression requirements of Federal Motor Vehicle Safety Standard 208. These child restraints are:

**Subpart A – Car bed child restraints**

Model	Manufactured on or after
Angel Guard Angel Ride AA2403FOF	September 25, 2007

**Subpart B – Rear-facing child restraints**

Model	Manufactured on or after
Century SmartFit 4543	December 1, 1999
Cosco Arriva 22-013PAW and base 22-999WHO	September 25, 2007
Evenflo Discovery Adjust Right 212	December 1, 1999
Evenflo First Choice 204	December 1, 1999
Graco Infant 8457	December 1, 1999

Model	Manufactured on or after
Graco Snugride	September 25, 2007
Peg Perego Primo Viaggio SIP IMUN00US	September 25, 2007

### Subpart C – Forward-facing and convertible child restraints

Model	Manufactured on or after
Britax Roundabout E9L02xx	September 25, 2007
Cosco Touriva 02519	December 1, 1999
Cosco Summit Deluxe High Back Booster 22-262	September 25, 2007
Cosco High Back Booster 22-209	September 25, 2007
Evenflo Tribute V 379xxxx	September 25, 2007
Evenflo Medallion 254	December 1, 1999
Evenflo Generations 352xxxx	September 25, 2007
Graco ComfortSport	September 25, 2007
Graco Toddler Safety Seat Step 2	September 25, 2007
Graco Platinum Cargo	September 25, 2007

#### WARNING

To reduce the risk of serious injury, make sure that the **PASSENGER AIR BAG OFF** light comes on and stays on whenever a child restraint is installed on the front passenger seat and the ignition is switched on.

- Take the child restraint off the front passenger seat and install it properly at one of the rear seat positions if the **PASSENGER AIR BAG OFF** light does not stay on.
- Have the airbag system inspected by your authorized Audi dealer immediately.

#### Tips

The child seats listed in categories A to C have been statically tested by Audi only for the Advanced Airbag function.

#### Important safety instructions for using child safety seats

*Correct use of child safety seats substantially reduces the risk of injury in an accident!*

As the driver, you are responsible for the safety of everybody in the vehicle, especially children:

- ▶ Always use the right child safety seat for each child and always use it properly ⇒ *page 171*.
- ▶ Always carefully follow the child safety seat manufacturer's instructions on how to route the safety belt properly through the child safety seat.
- ▶ When using the vehicle safety belt to install a child safety seat, you must first activate the convertible locking retractor on the safety belt to prevent the child safety seat from moving ⇒ *page 175*.
- ▶ Push the child safety seat down with your full weight to get the safety belt really tight so that the seat cannot move forward or sideways more than one inch (2.5 cm).
- ▶ If a strap or tether is being used to tie the child safety seat to the front passenger seat, make sure that it is not so tight that it causes the weight-sensing mat to measure more weight than is actually on the seat.
- ▶ Secure unused safety belts on the rear seat ⇒ *page 170*.

Always remember: Even though your vehicle is equipped with an Advanced Airbag system, all children, especially those 12 years and younger, should always ride in the back seat properly restrained for their age and size. ▶

**! WARNING**

Not using a child safety seat, using the wrong child safety seat or improperly installing a child restraint increases the risk of serious personal injury and death.

- All vehicle occupants and especially children must always be restrained properly whenever riding in a vehicle.
  - An unrestrained or improperly restrained child can be injured or killed by being thrown against the inside of the vehicle or by being ejected from it during a sudden maneuver or impact.
  - An unrestrained or improperly restrained child is at much greater risk of injury or death by being struck by an inflating airbag.
- Commercially available child safety seats are required to comply with U.S. Federal Motor Vehicle Safety Standard (FMVSS) 213 (in Canada CMVSS 213).
  - When buying a child restraint, select one that fits your child and the vehicle.
  - Only use child restraint systems that fully contact the flat portion of the seat cushion. The child restraint must not tip or lean to either side. Audi does not recommend using child safety seats that rest on legs or tube-like frames. They do not provide adequate contact with the seat.
  - Always heed all legal requirements pertaining to the installation and use of child safety seats and carefully follow the instructions provided by the manufacturer of the seat you are using.
- Never allow children under 57 inches (1.45 meters) to wear a normal safety belt. They must always be restrained by a proper child restraint system. Otherwise, they could sustain injuries to the abdomen and neck areas during sudden braking maneuvers or accidents.
- Never let more than one child occupy a child safety seat.

- Never let babies or older children ride in a vehicle while sitting on the lap of another passenger.
  - Holding a child in your arms is never a substitute for a child restraint system.
  - The strongest person could not hold the child with the forces that exist in an accident. The child will strike the interior of the vehicle and can also be struck by the passenger.
  - The child and the passenger can also injure each other in an accident.
- Never install rearward-facing child safety seats or infant carriers on the front passenger seat. A child will be seriously injured and can be killed when the passenger airbag inflates – even with an Advanced Airbag System.
  - The inflating airbag will hit the child safety seat or infant carrier with great force and will smash the child safety seat and child against the backrest, center arm rest, door or roof.
  - Always install rearward-facing child safety seats or infant carriers on the rear seat.
- Forward-facing child safety seats installed on the front passenger's seat can interfere with the airbag when it inflates and cause serious injury to the child. Always install forward-facing child safety seats on the rear seat.
- If exceptional circumstances require the use of a forward-facing child restraint on the front passenger's seat, the child's safety and well-being require that the following special precautions be taken:
  - Make sure the forward-facing seat has been designed and certified by its manufacturer for use on a front seat with a passenger front and side airbag.
  - Always carefully follow the manufacturer's instructions provided with the child safety seat or carrier.
  - Always move the front passenger seat into the rearmost position of the passenger seat's fore and aft adjustment

range, and as far away from the airbag as possible before installing the child restraint.

- Always make sure that nothing prevents the front passenger's seat from being moved to the rearmost position in its fore and aft adjustment range.
- Always make sure that the backrest is in the upright position.
- Always buckle the child safety seat firmly in place even if a child is not sitting in it. A loose child safety seat can fly around during a sudden stop or in a collision.
- Always read and heed all WARNINGS whenever using a child restrained in a vehicle is being used ⇒ *page 136, Safety belts*, ⇒ *page 144, Airbag system* and ⇒ *page 165, Child Safety*.

### WARNING

- To reduce the risk of serious injury, make sure that the **PASSENGER AIR BAG OFF** light comes on and stays on whenever a child restraint is installed on the front passenger seat and the ignition is switched on.
- Take the child restraint off the front passenger seat and install it properly at one of the rear seat positions if the **PASSENGER AIR BAG OFF** light does not stay on.
  - Have the airbag system inspected by your authorized Audi dealer immediately.

### Secure unused safety belts on the rear seat



**Fig. 161** Schematic overview: keep unused safety belts away from children in child safety seats. **(A)** - outer rear safety belt, **(B)** - center rear safety belt

If a child safety seat is used on the rear bench, especially with LATCH universal lower anchorages, the unused safety belts **must** be secured so that the child in the child restraint cannot reach them ⇒ .

- Guide the safety belt webbings **(A)** and **(B)** behind the head restraint of the seat where the child restraint is installed ⇒ *fig. 161*. When doing so, do not engage the convertible locking retractor! You should not hear a “clicking” sound when winding up the safety belt.
- Let the belt retractor wind up the safety belt webbing.

### WARNING

A child in a child safety seat installed with the LATCH lower anchorages or with the standard safety belt or a child in a booster seat on the rear seat could play with unused rear seat safety belts and become entangled. This could cause the child serious personal injury and even death.

- Always secure unused rear seat safety belts out of reach of children in child seats such as by properly routing them around the head restraint of the seat where the child restraint is installed.
- Never activate the convertible locking retractor when routing the safety belts around the head restraints.
- Never let anyone sit at the center rear seating position if the center rear safety belt has been routed around a rear head restraint.

## Child safety seats

### Infant seats

Babies and infants up to about one year old and 20 lbs. or 9 kg need special rearward-facing child restraints that support the back, neck and head in a crash.

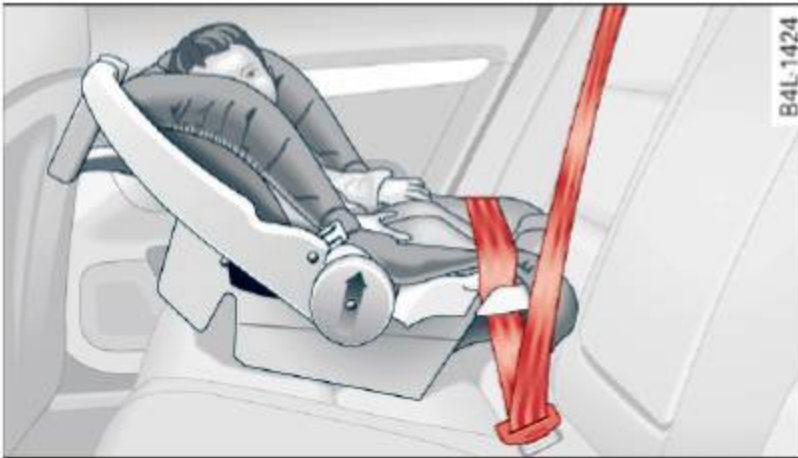

**Fig. 162** Schematic overview: rearward-facing infant seat, properly installed on the rear seat

- ▶ When using the vehicle safety belt to install a child safety seat, you must first activate the convertible locking retractor on the safety belt to prevent the child safety seat from moving ⇒ *page 175* or install the seat using the LATCH attachments.
- ▶ Push the child safety seat down with your full weight to get the safety belt really tight so that the seat cannot move forward or sideways more than one inch (2.5 cm).
- ▶ Secure unused safety belts on the rear seat ⇒ *page 170*.

Infants up to about one year (20 lbs. or 9 kg) are best protected in special infant carriers and child safety seats designed for their age group. Many experts believe that infants and small children should ride only in special restraints in which the child faces the back of the vehicle. These infant seats support the baby's back, neck and head in a crash ⇒ *fig. 162*.

The airbag on the passenger side makes the front seat a potentially dangerous place for a child to ride. The front seat is not the safest place for a child in a forward-facing child seat. It is a very dangerous place for an infant or a larger child in a rearward-facing seat.

### WARNING

Not using a child safety seat, using the wrong child safety seat or improperly installing a child restraint increases the risk of serious personal injury and death in a crash.

- Never install rearward-facing child safety seats or infant carriers on the front passenger seat - even with an Advanced Airbag System. A child will be seriously injured and can be killed when the inflating airbag hits the child safety seat or infant carrier with great force and smashes the child safety seat and child against the backrest, center armrest, door or roof ⇒ *page 145, Child restraints on the front seat - some important things to know*.
- Always install rearward-facing child safety seats or infant carriers on the rear seat.
- Never install a rearward-facing child restraint in the forward-facing direction. Such restraints are designed for the special needs of infants and very small children and cannot protect them properly if the seat is forward-facing.
- If you must install a rearward facing child safety seat on the front passenger seat because of exceptional circumstances and the **PASSENGER AIR BAG OFF** light does not come on and stay on, immediately install the rearward-facing child safety seat in a rear seating position and have the airbag system inspected by your authorized Audi dealer.
- Always read and heed all WARNINGS whenever using a child restrained in a vehicle is being used ⇒ *page 136, Safety belts*, ⇒ *page 144, Airbag system* and ⇒ *page 165, Important things to know*.

### Convertible child safety seats

Properly used convertible child safety seats can help protect toddlers and children over age one who weigh between 20 and 40 lbs. (9 and 18 kg) in a crash.



**Fig. 163** Schematic overview: installation of the attachments applicable to a LATCH seat

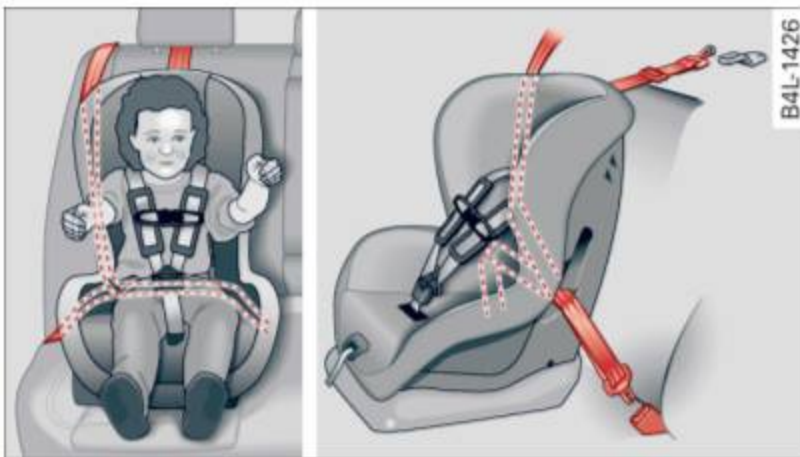

**Fig. 164** Schematic overview: installation of the seat using the vehicle's safety belt system

- ▶ When using the vehicle safety belt to install a child safety seat, you must first activate the convertible locking retractor on the safety belt to prevent the child safety seat from moving ⇒ *page 175* or install the seat using the LATCH attachments.
- ▶ Push the child safety seat down with your full weight to get the safety belt really tight so that the seat cannot move forward or sideways more than one inch (2.5 cm) ⇒ *page 175*.
- ▶ If the child safety seat is equipped with a tether strap, attach it to the tether anchors ⇒ *page 181*.
- ▶ Secure unused safety belts on the rear seat ⇒ *page 170*.

A toddler or child is usually too large for an infant restraint if it is more than one year old and weighs more than 20 lbs. (9 kg).

Toddlers and children who are older than one year up to about 4 years old and weigh more than 20 lbs. (9 kg) up to 40 lbs. (18 kg) must always be properly restrained in a child safety seat certified for their size and weight ⇒ *fig. 163* and ⇒ *fig. 164*.

The airbag on the passenger side makes the front seat a potentially dangerous place for a child to ride. The front seat is not the safest place for a child in a forward-facing child safety seat. It is a very dangerous place for an infant or a larger child in a rearward-facing seat.

### WARNING

- Not using a child safety seat, using the wrong child safety seat or improperly installing a child restraint increases the risk of serious personal injury and death in a collision or other emergency situation.
- Children on the front seat of any car, even with Advanced Airbags, can be seriously injured or even killed when an airbag inflates. A child in a rearward-facing child safety seat installed on the front passenger seat will be seriously injured and can be killed if the front airbag inflates – even with an Advanced Airbag System.
  - The inflating airbag will hit the child safety seat or infant carrier with great force and will smash the child safety seat and child against the backrest, center armrest, door or roof.
  - Always install rearward-facing child safety seats on the rear seat.
  - If you must install a rearward facing child safety seat on the front passenger seat because of exceptional circumstances and the **PASSENGER AIR BAG OFF** light does not come on and stay on, immediately install the rearward-facing child safety seat in a rear seating position and have the airbag system inspected by your authorized Audi dealer.
  - The rear side of the child safety seat should be positioned as close as possible

to the backrest on the vehicle seat. Adjust or remove the rear seat head restraint if it is difficult to install the child seat with the head restraint in place ⇒ *page 63*. Install the head restraint again immediately once the child seat is removed. Driving without head restraints or with head restraints that are not properly adjusted increases the risk of serious or fatal neck injury dramatically.

- Always read and heed all WARNINGS whenever using a child restrained in a vehicle is being used ⇒ *page 136, Safety belts*, ⇒ *page 144, Airbag system* and ⇒ *page 165, Important things to know*.

### WARNING

If exceptional circumstances require the use of a forward-facing child restraint on the front passenger's seat, the child's safety and well-being require that the following special precautions be taken:

- Make sure the forward-facing seat has been designed and certified by its manufacturer for use on a front seat with a passenger front and side airbag.
- Always follow the manufacturer's instructions provided with the child safety seat or infant carrier.
- Always move the front passenger seat into the rearmost position of the passenger seat's fore and aft adjustment range, and as far away from the airbag as possible before installing the child restraint.
- Always make sure that nothing prevents the front passenger's seat from being moved to the rearmost position in its fore and aft adjustment range.
- Always make sure the backrest is in an upright position.
- Make sure that the **PASSENGER AIR BAG OFF** light comes on and stays on all the time whenever the ignition is switched on.
- If the light does not stay on, perform the checks ⇒ *page 154, Monitoring the Advanced Airbag System*.

- Take the child restraint off the front passenger seat and install it properly at one of the rear seat positions if the **PASSENGER AIR BAG OFF** light does not stay on whenever the ignition is switched on.

### Booster seats and safety belts

*Properly used booster seats can help protect children weighing between about 40 lbs. and 80 lbs. (18 kg and 36 kg) who are less than 4 ft. 9 in. (57 inches/1.45 meters) tall.*



**Fig. 165** Rear seat: child properly restrained in a booster seat

The vehicle's safety belts alone will not fit most children until they are at least 4 ft. 9 in. (57 inches/1.45 meters) tall and weigh about 80 lbs. (36 kg). Booster seats raise these children up so that the safety belt will pass properly over the stronger parts of their bodies and the safety belt can help protect them in a crash.

- ▶ Do not use the convertible locking retractor when using the vehicle's safety belt to restrain a child on a booster seat.
- ▶ The shoulder belt must lie as close to the center of the child's collar bone as possible and must lie flat and snug on the upper body. It must never lie across the throat or neck. The lap belt must lie across the pelvis and never across the stomach or abdomen. Make sure the belt lies flat and snug. Pull on the belt to tighten if necessary.
- ▶ If you must transport an older child in a booster seat on the front passenger seat, you can use the safety belt height adjustment to help adjust the shoulder portion properly.

- ▶ Secure unused safety belts on the rear seat  
⇒ *page 170*.

Children up to about 40 lbs. (18 kg) are best protected in child safety seats designed for their age and weight. Experts say that the skeletal structure, particularly the pelvis, of these children is not fully developed, and they must not use the vehicle safety belts without a suitable child restraint.

It is usually best to put these children in appropriate booster seats. Be sure the booster seat meets all applicable safety standards.

Booster seats raise the seating position of the child and reposition both the lap and shoulder parts of the safety belt so that they pass across the child's body in the right places. The routing of the belt over the child's body is very important for the child's protection, whether or not a booster seat is used. Children age 12 and under must always ride in the rear seat.

Children who are at least 4 ft. 9 in. (57 inches/1.45 meters) tall can generally use the vehicle's three point lap and shoulder belts. Never use the lap belt portion of the vehicle's safety belt alone to restrain any child, regardless of how big the child is. Always remember that children do not have the pronounced pelvic structure required for the proper function of lap belt portion of the vehicle's three point lap and shoulder belts. The child's safety absolutely requires that a lap belt portion of the safety belt be fastened snugly and as low as possible around the pelvis. Never let the lap belt portion of the safety belt pass over the child's stomach or abdomen.

In a crash, airbags must inflate within a blink of an eye and with considerable force. In order to do its job, the airbag needs room to inflate so that it will be there to protect the occupant as the occupant moves forward into the airbag.

A vehicle occupant who is out of position and too close to the airbag gets in the way of an inflating airbag. When an occupant is too close, he or she will be struck violently and

will receive serious or possibly even fatal injury.

In order for the airbag to offer protection, it is important that all vehicle occupants, especially any children, who must be in the front seat because of exceptional circumstances, be properly restrained and as far away from the airbag as possible. By keeping room between the child's body and the front of the passenger compartment, the airbag can inflate completely and provide supplemental protection in certain frontal collisions.

### **WARNING**

Not using a booster seat, using the booster seat improperly, incorrectly installing a booster seat or using the vehicle safety belt improperly increases the risk of serious personal injury and death in a collision or other emergency situation. To help reduce the risk of serious personal injury and/or death:

- The shoulder belt must lie as close to the center of the child's collar bone as possible and must lie flat and snug on the upper body. It must never lie across the throat or neck. The lap belt must lie across the pelvis and never across the stomach or abdomen. Make sure the belt lies flat and snug. Pull on the belt to tighten if necessary.
- Failure to properly route safety belts over a child's body will cause severe injuries in an accident or other emergency situation ⇒ *page 136*.
- The rear side of the child safety seat should be positioned as close as possible to the backrest on the vehicle seat. Adjust or remove the rear seat head restraint if it is difficult to install the child seat with the head restraint in place ⇒ *page 63*. Install the head restraint again immediately once the child seat is removed. Driving without head restraints or with head restraints that are not properly adjusted increases the risk of serious or fatal neck injury dramatically.

- Children on the front seat of any car, even with Advanced Airbags, can be seriously injured or even killed when an airbag inflates.
- Never let a child stand or kneel on any seat.
- Never let a child ride in the cargo area of your vehicle.
- Always remember that a child leaning forward, sitting sideways or out of position in any way during an accident can be struck by a deploying airbag. This will result in serious personal injury or death.
- If you must install a rearward facing child safety seat on the front passenger seat because of exceptional circumstances the **PASSENGER AIR BAG OFF** light must come on and stay on, whenever the ignition is switched on.
- If you must install a booster seat on the front passenger seat because of exceptional circumstances the **PASSENGER AIR BAG OFF** light must come on and stay on, whenever the ignition is switched on.
- Take the child restraint off the front passenger seat and install it properly at one of the rear seat positions if the **PASSENGER AIR BAG OFF** light does not stay on whenever the ignition is switched on.
- Always read and heed all WARNINGS whenever using a child restrained in a vehicle is being used ⇒ *page 136, Safety belts*, ⇒ *page 144, Airbag system* and ⇒ *page 165, Important things to know*.

## Installing a child safety seat

### Securing a child safety seat using a safety belt

*Safety belts for the rear seats and the front passenger's seat can be locked with the convertible locking retractor to properly secure child safety seats.*

The safety belts emergency locking retractors for the rear seats safety belts and for the

front passenger's seat safety belt have a convertible locking retractor for child restraints. The safety belt must be locked so that belt webbing cannot unreel. The retractor can be activated to lock the safety belt and prevent the safety belt webbing from loosening up during normal driving. A child safety seat can only be properly installed when the safety belt is locked so that the child and child safety seat will stay in place.

Always remember: Even though your vehicle is equipped with an Advanced Airbag system, all children, especially those 12 years and younger, should always ride in the back seat properly restrained for their age and weight.

### WARNING

Improperly installed child safety seats increase the risk of serious personal injury and death in a collision.

- Always make sure that the safety belt retractor is locked when installing a child safety seat. An unlocked safety belt retractor cannot hold the child safety seat in place during normal driving or in a crash.
- Always buckle the child safety seat firmly in place even if a child is not sitting in it. A loose child safety seat can fly around during a sudden stop or in a collision.
- Always make sure that the rear seat backrest to which the center rear safety belt is attached is securely latched whenever the rear center safety belt is being used to secure a child restraint.
- If the backrest is not securely latched, the child and the child restraint will be thrown forward together with the backrest and will strike parts of the vehicle interior. The child can be seriously injured or killed.
- Never install rearward-facing child safety seats or infant carriers on the front passenger seat. A child will be seriously injured and can be killed when the passenger airbag inflates.

- The inflating airbag will hit the child safety seat or infant carrier with great force and will smash the child safety seat and child against the backrest, center armrest, door or roof.
- Always install rearward-facing child safety seats or infant carriers on the rear seat.
- Forward-facing child safety seats or infant carriers installed on the front passenger's seat may interfere with the deployment of the airbag and cause serious injury to the child.
- It is safer to install a forward-facing child safety seat on the rear seat.
- Always read and heed all WARNINGS whenever using a child restrained in a vehicle is being used ⇒ *page 165*. Special precautions apply when installing a child safety seat on the front passenger seat ⇒ *page 145, Child restraints on the front seat – some important things to know*.

### WARNING

- Always take special precautions if you must install a forward or rearward-facing child restraint on the front passenger's seat in exceptional situations:
- Whenever a forward or rearward-facing child restraint is installed on the front passenger seat, the **PASSENGER AIR BAG OFF** light must come on and stay on whenever the ignition is switched on.
  - If the **PASSENGER AIR BAG OFF** light does not come on and stay on, perform the checks described ⇒ *page 154, Monitoring the Advanced Airbag System*.
  - Take the child restraint off the front passenger seat and install it properly at one of the rear seat positions if the **PASSENGER AIR BAG OFF** light does not stay on whenever the ignition is switched on.
  - Improper installation of child restraints can reduce their effectiveness or even prevent them from providing any protection.

- An improperly installed child restraint can interfere with the airbag as it deploys and seriously injure or even kill the child.
- Always carefully follow the manufacturer's instructions provided with the child safety seat or carrier.
- Never place additional items on the seat that can increase the total weight registered by the weight-sensing mat and can cause injury in a crash.

### WARNING

Forward-facing child restraints:

- Always make sure the forward-facing seat has been designed and certified by its manufacturer for use on a front seat with a passenger front and side airbag.
- Never put the forward-facing child restraint up, against or very near the instrument panel.
- Always move the passenger seat into its rearmost position in the seat's fore and aft adjustment range, as far away from the airbag as possible before installing the forward-facing child restraint. The backrest must be adjusted to an upright position.
- Make sure that the **PASSENGER AIR BAG OFF** light comes on and stays on all the time whenever the ignition is switched on.

### WARNING

Rearward-facing child restraints:

- A child in a rearward-facing child safety seat installed on the front passenger seat will be seriously injured and can be killed if the front airbag inflates - even with an Advanced Airbag System.
- The inflating airbag will hit the child safety seat or infant carrier with great force and will smash the child safety seat and child against the backrest, center armrest, door or roof.

- Always be especially careful if you must install a rearward facing child safety seat on the front passenger seat in exceptional circumstances.
- A tight tether strap on a rearward-facing child restraint attached to the front passenger seat can put too much pressure on the weight-mat in the seat and register a heavier weight in the Advanced Airbag System. The heavier weight registered can make the system work as though an adult were on the seat and deploy the Advanced Airbag when it must be suppressed causing serious or even fatal injury to the child.
- Make sure that the **PASSENGER AIR BAG OFF** light comes on and stays on all the time whenever the ignition is switched on.
- If the **PASSENGER AIR BAG OFF** light does not come on and stay on, immediately install the rearward-facing child safety seat in a rear seating position and have the airbag system inspected by your authorized Audi dealer.

### Activating the convertible locking retractor

*Use the convertible locking retractor to secure a child restraint.*

Always heed the child safety seat manufacturer's instructions when installing a child restraint in your vehicle. To activate the convertible locking retractor:

- ▶ Place the child restraint on a seat, preferably on the rear seat.
- ▶ Slowly pull the belt **all the way out**.
- ▶ Route it around or through the child restraint belt path ⇒ .
- ▶ Push the child safety seat down with your full weight to get the safety belt really tight.
- ▶ Insert the belt tongue into the buckle for that seating position.
- ▶ Guide the safety belt back into the retractor until the belt lies flat and snug on the child safety seat.

- ▶ You should hear a “clicking” noise as the belt winds back into the inertia reel. Test the convertible locking retractor by pulling on the belt. You should no longer be able to pull the belt out of the retractor. The convertible locking retractor is now activated.
- ▶ Make sure that the red release button is facing away from the child restraint so that it can be unbuckled quickly.
- ▶ Pull on the belt to make sure the safety belt is properly tight and fastened so that the seat cannot move forward or sideways more than one inch (2.5 cm).

### WARNING

Using the wrong child restraint or an improperly installed child restraint can cause serious personal injury or death in a crash.

- Always make sure that the safety belt retractor is locked when installing a child safety seat. An unlocked safety belt retractor cannot hold the child safety seat in place during normal driving or in a crash.
- Always buckle the child safety seat firmly in place even if a child is not sitting in it. A loose child safety seat can fly around during a sudden stop or in a crash.
- Always make sure the seat backrest to which the child restraint is installed is in an upright position and securely latched into place and cannot fold forward. Otherwise, the seatback with the child safety seat attached to it could fly forward in the event of an accident or other emergency situation.
- Always read and heed all WARNINGS whenever using a child restrained in a vehicle is being used ⇒ *page 165*. Special precautions apply when installing a child safety seat on the front passenger seat ⇒ *page 145, Child restraints on the front seat – some important things to know*.

### Deactivating the convertible locking retractor

*The convertible locking retractor for child restraints will be deactivated automatically when the belt is wound all the way back into the retractor.*

- ▶ Press the red button on the safety belt buckle. The belt tongue will pop out of the buckle.
- ▶ Guide the safety belt all the way back into its stowed position.

Always let the safety belt retract completely into its stowed position. The safety belt can now be used as an ordinary safety belt without the convertible locking retractor for child restraints.

If the convertible locking retractor should be activated inadvertently, the safety belt must be unfastened and guided completely back into its stowed position to deactivate this feature. If the convertible locking retractor is not deactivated, the safety belt will gradually become tighter and uncomfortable to wear.



#### WARNING

Improperly installed child safety seats increase the risk of serious personal injury and death in a collision.

- Never unfasten the safety belt to deactivate the convertible locking retractor for child restraints while the vehicle is moving. You would not be restrained and could be seriously injured in an accident.
- Always read and heed all WARNINGS whenever using a child restrained in a vehicle is being used ⇒ *page 165*. Special precautions apply when installing a child safety seat on the front passenger seat ⇒ *page 145, Child restraints on the front seat – some important things to know*.

## LATCH Lower anchorages and tether for children

### Child Restraint System anchors and how are they related to child safety

To provide a simpler and more practicable way to attach the child restraint on the vehicle seat, Federal regulations require special lower anchorages in vehicles and devices on new child restraints to attach to the vehicle anchorages.

The combination of the tether anchorages and the lower anchorages is now generally called the **LATCH** system for “**L**ower **A**nchorages and **T**ethers for **C**hildren.”

Forward-facing child restraints manufactured after September 1, 1999, are required by U.S. federal regulations to comply with new child head movement performance requirements. These new performance requirements make a tether necessary on most new child seats.

Installing a child restraint that requires a top tether without one can seriously impair the performance of the child restraint and its ability to protect the child in a collision. Installing a child restraint that requires a top tether without the top tether may be a violation of state law.

Child restraint manufacturers offer LATCH lower anchorages on their child seats with hook-on or push-on connectors attached to adjustable straps.

In addition to the LATCH lower anchorages, these child restraint systems usually require the use of tether straps to help keep the child restraint firmly in place.

#### **WARNING**

Improper installation of child restraints will increase the risk of injury and death in a crash.

- Always follow the instructions provided by the manufacturer of the child re-

straint you intend to install in your vehicle.

- Never install a child restraint without a properly attached top tether strap if the child restraint manufacturer's instructions require the top tether strap to be used.
- Improper use of child restraint LATCH lower anchorage points can lead to injury in a collision. The LATCH lower anchorage points are designed to withstand only those loads imposed by correctly fitted child restraints.
- Never mount two child restraint systems on one LATCH lower anchorage point.
- Never secure or attach any luggage or other item to the LATCH lower anchorages.

#### **Tips**

In Canada, the terms “top tether” with “lower universal anchorages” (or “lower universal anchorage bars”) are used to describe the system.

- In other countries, the term “ISOFIX” is used to describe the lower anchorages.

#### **Location**

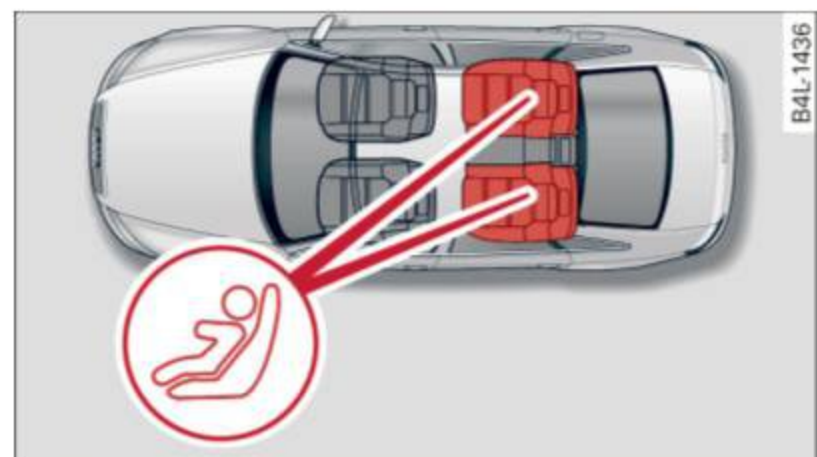

**Fig. 166** Schematic overview: LATCH anchorage point locations

The illustration shows the seating locations in your vehicle which are equipped with the lower anchorages system.

### Description

The lower anchorage positions are marked for quick locating.

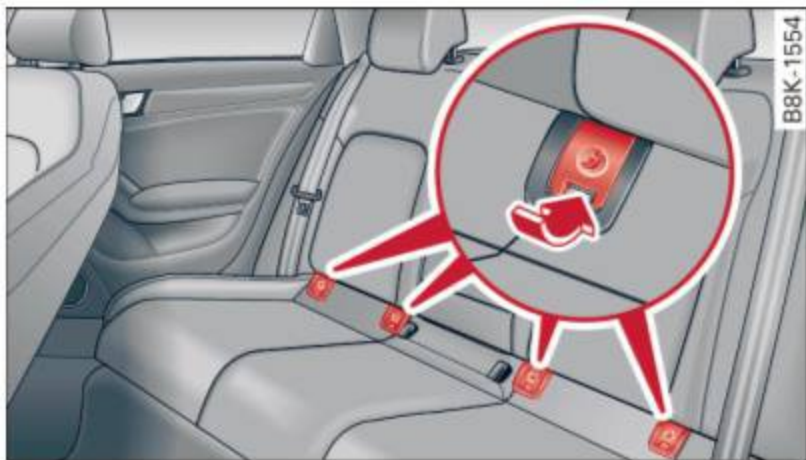

Fig. 167 Lower anchorages, covers marked

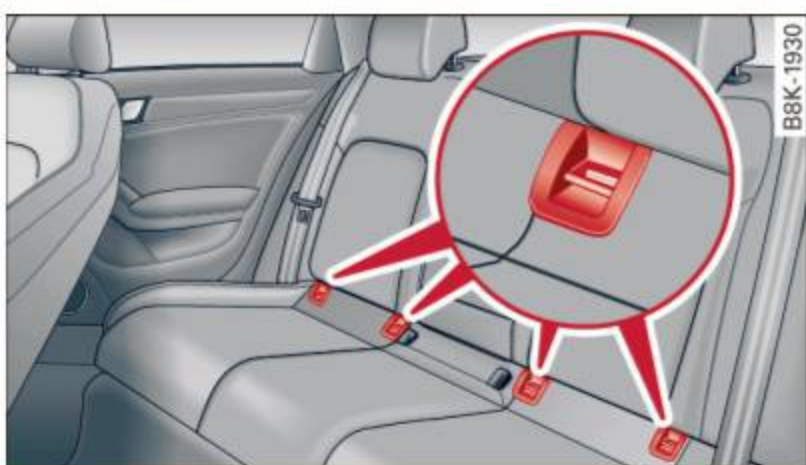

Fig. 168 Rear seats: lower anchorage bracket locations

### Lower anchorages

The lower anchorage attachment points are located on the rear end of the rear seatback.

Remove the covers ⇒ *fig. 167* to access the lower anchorage attachment points.

The lower anchorage attachment points are visible ⇒ *fig. 168*.

Lower anchorages secure the child restraint in the seat without using the vehicle's safety belts. Anchorages provide a secure and easy-to-use attachment and minimize the possibility of improper child restraint installation.

All child restraints manufactured after September 1, 2002, must have lower anchorage attachments for the *LATCH* system.

Remember that the lower anchorage points are only intended for installation and attachment of child restraints specifically certified for use with *LATCH* lower anchorages. Child restraints that are not equipped with the lower anchorage attachments can still be instal-

led in compliance with the child restraint manufacturer's instructions on using vehicle safety belts.

### ! WARNING

Improper use of *LATCH* lower anchorages can cause serious personal injury in an accident.

- Always carefully follow the child restraints manufacturer's instructions for proper installation of the child restraint and proper use of the lower anchorages or safety belts in your vehicle.
- Never secure or attach any luggage or other items to the *LATCH* lower anchorages.
- Always read and heed the important information about child restraints in this chapter and **WARNINGS** ⇒ *page 165, Child Safety*.

### Installing a child restraint with *LATCH* lower anchorages

Whenever you install a child restraint always follow the child restraint manufacturer's instructions.

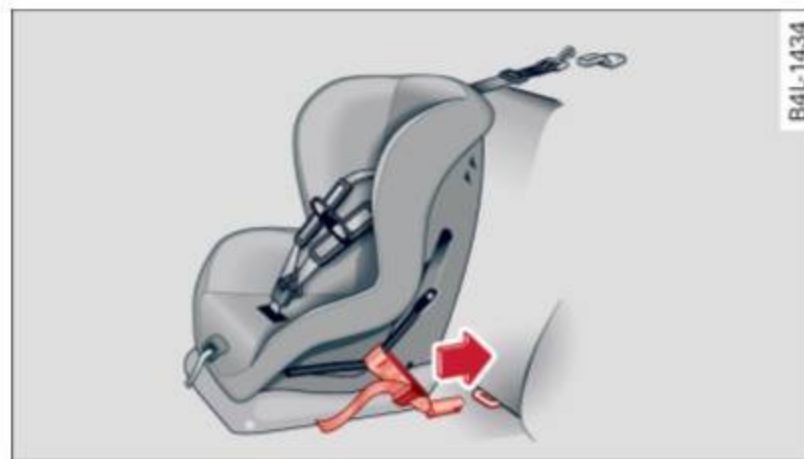

Fig. 169 Lower anchorages: proper mounting

### Mounting

- ▶ Make sure the seatback of the rear seat bench is in the upright position and securely latched in place.
- ▶ Attach both hook-on connectors with the spring catch release on the child safety seat onto the *LATCH* lower anchorage so that the connectors lock into place ⇒ *fig. 169*.

- ▶ Pull on the connector attachments to make sure they are properly attached to the LATCH lower anchorage.
- ▶ Pull straps tight following the child restraint manufacturer's instructions.

**Releasing**

- ▶ Loosen the tension on the straps following the child restraint manufacturer's instructions.
- ▶ Depress the spring catches to release the anchorage hooks from the lower anchorages.

Remember: Use tether straps to help keep the child restraint firmly in place.

**! WARNING**

Improper use of the LATCH system can increase the risk of serious personal injury and death in an accident.

- These anchors were developed only for child safety seats using the "LATCH" system.
- Never attach other child safety seats, belts or other objects to these anchors.
- Always make sure that you hear a click when latching the seat in place. If you do not hear a click the seat is not secure and could fly forward and hit the interior of the vehicle, or be ejected from the vehicle.

**! WARNING**

Improper installation of child restraints will increase the risk of injury in an accident.

- Always follow the child restraint system manufacturer's instructions for proper installation of the child restraint system and proper use of tether straps as well as the lower anchorages or safety belts in your vehicle.
- Always read and heed the important information and WARNINGS about child safety and the installation of child restraint systems ⇒ *page 165, Child Safety*.

**Tether anchors and tether straps**



**Fig. 170** Sedan Tether anchors: recess flaps behind the rear seatbacks

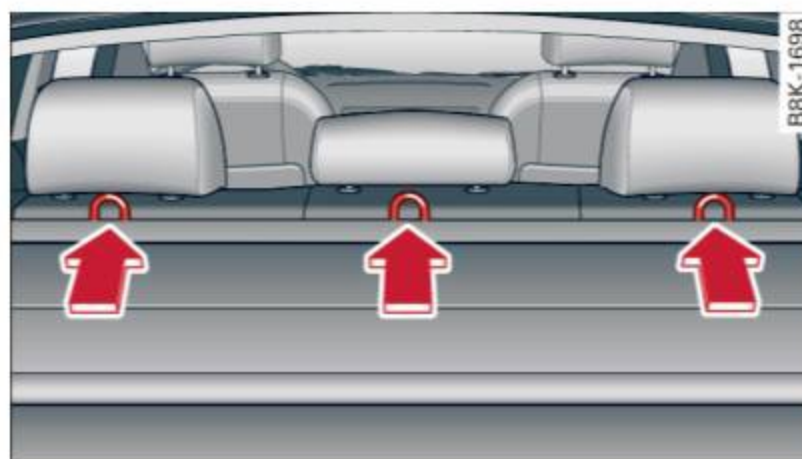

**Fig. 171** allroad Tether anchors: attachment hook locations behind the rear seatbacks

Sedan: The tether anchors for the rear seating positions are located in recesses in the rear window shelf ⇒ *fig. 170*.

allroad: The tether anchors for the rear seating positions are located on the backside of the rear seatbacks ⇒ *fig. 171*.

A tether is a straight or V-shaped strap that attaches the top part of a child restraint to special anchorage points in the vehicle.

The purpose of the tether is to reduce the forward movement of the child restraint in a crash, in order to help reduce the risk of head injury that could be caused by striking the vehicle interior.

Forward facing child restraints manufactured after September 1, 1999, are required by U.S. federal regulations to comply with child head movement performance requirements. These new performance requirements make a tether necessary on most new child safety seats. ▶

## WARNING

Improper installation of child restraints will increase the risk of injury and death in a crash.

- Always follow the instructions provided by the manufacturer of the child restraint you intend to install in your Audi.
- Improper use of child restraint anchors (including tether anchors) can lead to injury in a collision. The anchors are designed to withstand only those loads imposed by correctly fitted child restraints.
- Never mount two child restraint systems on one LATCH lower anchor point.
- Never attach two child restraint systems to one tether strap or tether anchorage.
- Never attach a tether strap to a tie-down hook in the luggage compartment.
- Never use child restraint tether anchorages to secure safety belts or other kinds of occupant restraints.
- Never secure or attach any luggage or other items to the LATCH lower anchorages or to the tether anchors.
- If a tether or other strap is used to attach a child restraint to the front passenger seat, make sure that it is not so tight, that it causes the weight-sensing mat to measure more weight than is actually on the seat.
- The heavier weight registered can make the Advanced Airbag System work as though an adult were on the seat and deploy the Advanced Airbag when it must be suppressed causing serious or even fatal injury to the child.
- If you must install a rearward facing child safety seat on the front passenger seat because of exceptional circumstances and the **PASSENGER AIR BAG OFF** light does not come on and stay on, immediately install the rear-facing child safety seat in a rear seating position and have the airbag system inspected by your authorized Audi dealer.

## Installing the upper tether strap on the anchorage

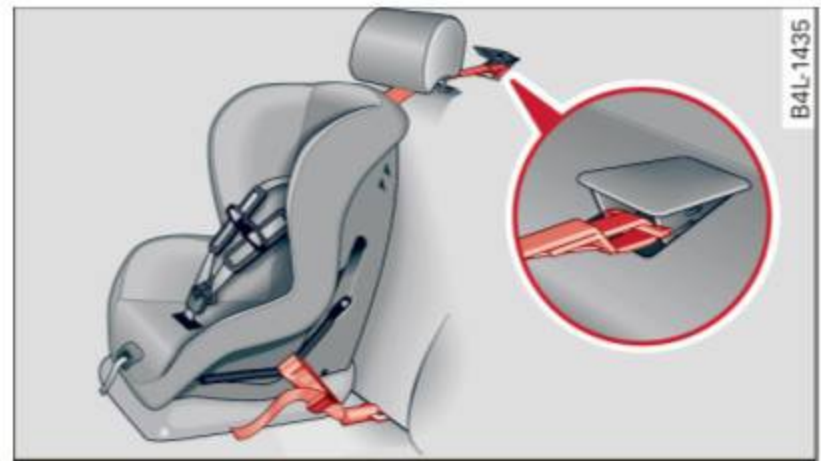

**Fig. 172** Sedan Tether strap: proper routing and mounting

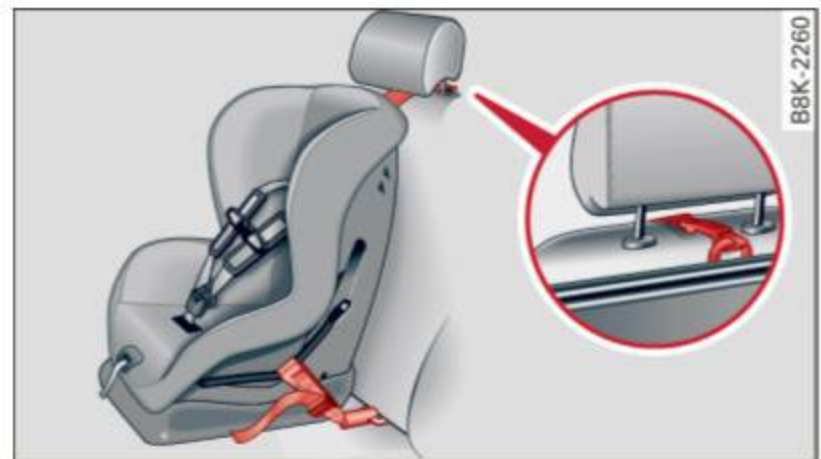

**Fig. 173** allroad Tether strap: proper routing and mounting

## Installing the tether strap

- ▶ Release or deploy the tether strap on the child restraint according to the child restraint manufacturer's instructions.
- ▶ Guide the upper tether strap **under** the rear head restraint ⇒ *fig. 172* or ⇒ *fig. 173* (raise the head restraint if necessary).
- ▶ Sedan: Tilt the recess flap up to expose the anchor bracket.
- ▶ Sedan: Attach the tether strap anchorage hook into the opening of the tether anchorage.
- ▶ allroad: Slide the tether strap hook over the anchor bracket.
- ▶ Pull on the tether strap hook so that the spring catch of the hook engages.
- ▶ Tighten the tether strap firmly following the child restraint manufacturer's instructions.

## Releasing the tether strap

- ▶ Loosen the tension following the child restraint manufacturer's instructions.
- ▶ Depress the spring catch on the hook and release it from the anchorage.

**! Note**

If you leave the child restraint with the tether strap firmly installed for several days, this could leave a mark on the upholstery on the seat cushion and backrest in the area where the tether strap was installed. The upholstery would also be permanently stretched around the tether strap. This applies especially to leather seats.

**Using tether straps on rearward-facing child restraints**

Currently, few rearward-facing child restraint systems come with a tether. Please read and heed the child restraint system manufacturer's instructions carefully to determine how to properly install the tether.

**! WARNING**

A child in a rearward-facing child safety seat installed on the front passenger seat will be seriously injured and can be killed if the front airbag inflates - even with an Advanced Airbag System.

- The inflating airbag will hit the child safety seat or infant carrier with great force and will smash the child safety seat and child against the backrest, center armrest, or door.
- A tight tether or other strap on a rearward-facing child restraint attached to the front passenger seat can put too much pressure on the weight-mat in the seat and register a heavier weight in the Advanced Airbag System. The heavier weight registered can make the system work as though an adult were on the seat and deploy the Advanced Airbag when it must be suppressed causing serious or even fatal injury to the child.
- If you must install a rearward facing child safety seat on the front passenger seat because of exceptional circumstances and the **PASSENGER AIR BAG OFF** light does not come on and stay on, im-

mediately install the rearward-facing child safety seat in a rear seating position and have the airbag system inspected by your authorized Audi dealer.

**Additional Information****Sources of information about child restraints and their use**

There are a number of sources of additional information about child restraint selection, installation and use:

NHTSA advises that the best child safety seat is the one that fits your child and fits in your vehicle, and that you will use correctly and consistently.

Try before you buy!

**U.S National Highway Traffic Safety Administration**

Tel.: 1-888-327-4236 (TTY: 1-800-424-9153)  
www.nhtsa.gov

**National SAFE KIDS Campaign**

Tel.: (202) 662-0600  
www.safekids.org

**Safety BeltSafe U.S.A**

Tel.: (800) 745-SAFE (English)  
Tel.: (800) 747-SANO (Spanish)  
www.carseat.org

**Transport Canada Information Centre**

Tel.: 1-800-333-0371 or call  
1-613-998-8616 if you are in the Ottawa area  
<http://www.tc.gc.ca/eng/roadsafety/menu.htm>

**Audi Customer Relations**

Tel.: (800) 822-2834

## Intelligent technology

### Notice about data recorded by the Event Data Recorder and vehicle control modules

#### Event Data Recorder

This vehicle is equipped with an Event Data Recorder (EDR). The main purpose of an EDR is to record, in certain crash or near crash-like situations, such as an airbag deployment or hitting a road obstacle, data that will assist in understanding how a vehicle's systems performed. The EDR is designed to record data related to vehicle dynamics and safety systems for a short period of time, typically 30 seconds or less. The EDR in this vehicle is designed to record such data as:

- How various systems in your vehicle were operating;
- Whether or not the driver and passenger safety belts were buckled/fastened;
- How far (if at all) the driver was depressing the accelerator and/or brake pedal; and,
- How fast the vehicle was traveling.

These data can help provide a better understanding of the circumstances in which crashes and injuries occur. NOTE: EDR data are recorded by your vehicle only if a non-trivial crash situation occurs; no data are recorded by the EDR under normal driving conditions and no personal data (e.g., name, gender, age, and crash location) are recorded. However, other parties, such as law enforcement, could combine the EDR data with the type of personally identifying data routinely acquired during a crash investigation.

To read data recorded by an EDR, special equipment is required, and access to the vehicle or the EDR is needed. In addition to the vehicle manufacturer, other parties, such as law enforcement, that have the special equipment, can read the information if they have access to the vehicle or the EDR.

Some state laws restrict the retrieval or downloading of data stored by EDRs installed in a vehicle for the express purpose of retrieving data after an accident or crash event without the owner's consent.

Audi will not access the EDR and/or similar data or give it to others -

- unless the vehicle owner (or lessee if the vehicle has been leased) agrees; or
- upon the official request by the police; or
- upon the order of a court of law or a government agency; or
- for the defense of a lawsuit through the judicial discovery process.
- Audi may also use the data for research about vehicle operation and safety performance or provide the data to a third party for research purposes without identifying the specific vehicle or information about the identity of its owner or lessee and only after the recorded vehicle data has been accessed.

#### Vehicle control modules

Your vehicle is also equipped with a number of electronic control modules for various vehicle systems, such as engine management, emission control, airbags, and safety belts.

These electronic control modules record data during normal vehicle operation that may be needed by trained technicians for diagnostic and repair purposes. The recording capability of these modules is limited to data (no sound is recorded). Only a small amount of data is actually recorded over a very limited period of time, or stored when a system fault is detected by a control module. Some of the data stored may relate to vehicle speed, direction, or braking, as well as restraint system use and performance in the event of a crash. Stored data can also only be read and downloaded with special equipment that is directly connected to the vehicle. ►

**i Tips**

Your vehicle may be equipped with Audi connect. Your use of certain Audi connect features requires wireless services that are provided by a third party wireless telecommunications provider. For details regarding how information obtained through Audi connect is collected, processed, transmitted, used, and shared, please see your contract with the wireless telecommunications provider and the "About Audi connect" tab in your vehicle's MMI\*:

**[MENU]** button > **Audi connect** > **About Audi connect**.

## Electronic Stabilization Control (ESC)

### Description

ESC helps to improve road holding and vehicle dynamics to help reduce the probability of skidding and loss of vehicle control. It works only when the engine is running. ESC detects certain difficult driving situations, including when the vehicle is beginning to spin (yaw) out of control and helps you to get the vehicle back under control by selectively braking the wheels, and/or reducing engine power and providing steering assistance to help hold the vehicle on the driver's intended course. The indicator light  in the instrument cluster blinks when ESC is taking action to help you control the vehicle.

ESC has limitations. It is important to remember that ESC cannot overcome the laws of physics. It will not always be able to help out under all conditions you may come up against. For example, ESC may not always be able to help you master situations where there is a sudden change in the coefficient of friction of the road surface. When there is a section of dry road that is suddenly covered with water, slush or snow, ESC cannot perform the same way it would on the dry surface. If the vehicle hydroplanes (rides on a cushion of water instead of the road surface), ESC will not be able to help you steer the vehicle because con-

tact with the pavement has been interrupted and the vehicle cannot be braked or steered. During fast cornering, particularly on winding roads, ESC cannot always deal as effectively with difficult driving situations than at lower speeds. When towing a trailer, ESC is not able to help you regain control as it would if you were not towing a trailer.

Always adjust your speed and driving style to road, traffic and weather conditions. ESC cannot override the vehicle's physical limits, increase the available traction, or keep a vehicle on the road if road departure is a result of driver inattention. Instead, ESC improves the possibility of keeping the vehicle under control and on the road during extreme maneuvers by using the driver's steering inputs to help keep the vehicle going in the intended direction. If you are traveling at a speed that causes you to run off the road before ESC can provide any assistance, you may not experience the benefits of ESC.

ESC is switched on all the time. In certain situations when you need less traction, you can switch off ASR by pressing the button  ⇒ *page 187, fig. 174* or ⇒ *page 187, fig. 175*. Be sure to switch ASR on again when you no longer need less traction.

The following systems are integrated in the ESC:

### Anti-lock braking system (ABS)

ABS prevents the wheels from locking up when braking. The vehicle can still be steered even during hard braking. Apply steady pressure to the brake pedal. Do not pump the pedal. A pulsing in the brake pedal indicates that the system is helping you to brake the vehicle.

### Brake assist system

The brake assist system can decrease braking distance. It increases braking power when the driver presses the brake pedal quickly in emergency situations. You must press and hold the brake pedal until the situation is over. In vehicles with adaptive cruise control\*, the brake assist system is more sensitive if the

distance detected to the vehicle ahead is too small.

### Anti-slip regulation (ASR)

ASR reduces engine power when the drive wheels begin to spin and adapts the force to the road conditions. This makes it easier to start, accelerate and drive up hills.

### Electronic differential lock (EDL)

The EDL brakes wheels that are spinning and transfers the drive power to the other drive wheel or wheels if the vehicle is equipped with all-wheel drive\*. This function is not available at higher speeds.

In extreme cases, EDL automatically switches off to help keep the brake on the braked wheel from overheating. EDL will switch on again automatically when conditions have returned to normal.

### Steering recommendation

The ESC helps to stabilize the vehicle by changing the steering torque.

In vehicles with dynamic steering\*, ESC also helps to stabilize the steering in critical situations.



### Electronic interaxle differential lock\*/selective wheel torque control\*

The electronic interaxle differential lock (front wheel drive) or the selective wheel torque control (all wheel drive) operates when driving through curves. The front wheel on the inside of the curve or both wheels on the inside of the curve are braked selectively as needed. This allows more precise driving in curves. The applicable system may not activate when driving in wet or snowy conditions.

### WARNING

- The ESC and its integrated systems cannot overcome the laws of physics. This is especially important on slippery or wet roads. If the systems begin acting to stabilize your vehicle, you should immediately change your speed to match the road and traffic conditions. Do not let the increased safety provided by these systems tempt you to take risks. Doing so will increase the risk of a loss of vehicle control, collision and serious personal injuries.
- Always adapt your speed to road, traffic and weather conditions. The risk of losing control of the vehicle increases when driving too fast, especially through curves and on slippery or wet roads, and when driving too close to vehicles up ahead. The ESC and its integrated systems cannot always prevent collisions - there is still a risk of accidents!
- Always accelerate with special care on even, smooth surfaces such as those that are wet or covered with ice and snow. The drive wheels can spin even with these assistance systems that cannot always help to reduce the risk of loss of vehicle control.

### Tips

- ABS and ASR only work correctly when all four wheels are equipped with identical tires. Different tire sizes can lead to a reduction in engine power.
- You may hear noises when the systems described are working.
- If the indicator light  or **ABS** (USA models)/ (Canada models) appears, there may be a malfunction ⇒ *page 18*, ⇒ *page 19*.

Switching on/off

ESC turns on automatically when you start the engine.



Fig. 174 Version A: lower center console, ESC OFF button



Fig. 175 Version B: upper center console, ESC OFF button

The ESC is designed to function in levels. Depending on the level that is selected, the stabilization function of the ESC is limited or switched off. The amount of stabilization control will differ depending on the level.





The following situations are exceptions where it may be useful to switch on sport mode (Sedan) or offroad mode (allroad) to allow the wheels to spin:

- Rocking the vehicle to free it when it is stuck
- Driving in deep snow or on loose ground
- Driving with snow chains
- allroad: Driving on rough terrain when much of the car's weight is lifted off the wheels (axle articulation)
- allroad: Driving downhill while braking on loose ground

Sedan: ESC levels

	Sport mode on	ESC/ASR off	Sport mode off or ESC/ASR on
<b>Behavior</b>	The ESC and ASR stabilization functions are limited ⇒	The stabilization function is not available ⇒ . ESC and ASR are switched off.	The full stabilization function of the ESC and ASR is available again.
<b>Operation</b>	Press the  button briefly.	Press and hold the  button longer than 3 seconds.	Press the  button again.
<b>Indicator lights</b>	turns on.	and <b>ESC OFF</b> turn on.	turns off or  and <b>ESC OFF</b> turn off.
<b>Driver messages</b>	<b>Stabilization control (ESC): Sport. Warning! Restricted stability</b>	<b>Stabilization control (ESC): off. Warning! Restricted stability</b>	<b>Stabilization control (ESC): On</b>

## allroad: ESC levels

	Offroad mode on	Offroad mode off
<b>Behavior</b>	The ESC and ASR stabilization functions are limited ⇒  .	The full stabilization function of the ESC and ASR is available again.
<b>Operation</b>	Press the  button.	Press the  button again.
<b>Indicator lights</b>	 turns on.	 turns off.
<b>Driver messages</b>	<b>Stabilization control (ESC): Offroad. Warning! Restricted stability</b>	<b>Stabilization control (ESC): On</b>

It is only possible to turn off the ASR up to 30 mph (50 km/h) for vehicles with front wheel drive. At about 45 mph (70 km/h) it automatically turns on again. It is possible to turn off the ASR at any speed for vehicles with all wheel drive.

 **WARNING**

You should only switch sport mode/off-road mode on or switch ESC/ASR off if your driving abilities and road conditions permit.

- The stabilization function is limited when sport mode/offroad mode is switched on. The driving wheels could spin and the vehicle could swerve, especially on slick or slippery road surfaces.
- allroad: You should only switch offroad mode on when driving offroad.
- Sedan: There is no vehicle stabilization when ESC/ASR are switched off.

 **Tips**

ESC/ASR cannot be switched off or sport mode/offroad mode cannot be switched on when cruise control or adaptive cruise control\* is switched on.

## Braking

*What affects braking efficiency?*

### New brake pads

During the first 250 miles (400 km), new brake pads do not possess their full braking effect, they have to be “broken in” first ⇒ . You can compensate for this slightly reduced

braking power by pushing harder on the brake pedal. Avoid heavy braking loads during the break-in period.

### Operating conditions and driving habits

The brakes on today’s automobiles are still subject to wear, depending largely on operating conditions and driving habits ⇒ . On vehicles that are either driven mostly in stop-and-go city traffic or are driven hard, the brake pads should be checked by your authorized Audi dealer more often than specified in the **Warranty & Maintenance booklet**. Failure to have your brake pads inspected can result in reduced brake performance.

On steep slopes, you should use the braking effect of the engine. This way, you prevent unnecessary wear on the brake system. If you must use your brakes, do not hold the brakes down continuously. Pump the brakes at intervals.

### Operating noise

Noises may occur when braking depending on the speed, braking force and outside conditions such as temperature and humidity.

### Effect of water and road salt

In certain situations, for example after driving through water, in heavy rain, after overnight condensation or after washing your car, the braking effect can be reduced by moisture or ice on the brake rotors and brake pads. The brakes must be dried first with a few careful brake applications.

At higher speeds and with the windshield wipers turned on, the brake pads press against

the brake rotors for a short amount of time. This occurs at regular intervals without the driver noticing and provides for better brake response time under wet conditions.

The effectiveness of the brakes can be reduced when the vehicle is driven on a salt-covered road and the brakes are not used. Likewise, you clean off accumulated salt coating from brake discs and pads with a few cautious applications of the brake ⇒ ⚠.

### Corrosion

There may be a tendency for dirt to build up on the brake pads and corrosion to form on the discs if the car is not driven regularly or only for short trips with little use of the brakes.

If the brakes are not used frequently, or if corrosion has formed on the discs, it is advisable to clean off the pads and discs by braking firmly a few times from a moderately high speed ⇒ ⚠.

### Faults in the brake system

If you should notice a *sudden* increase in brake pedal travel, then one of the two brake circuits may have failed ⇒ ⚠.

### Low brake fluid level

Malfunctions can occur in the brake system if the brake fluid level is too low. The brake fluid level is monitored electronically.

### Brake booster

The brake booster increases the pressure that you generate with the brake pedal. It works only when the engine is running ⇒ ⚠.

### Brake lining wear status

Brake lining wear may be checked by visual inspection of the condition of the brake pads through the openings in the wheel. If necessary, the wheel may be removed for this inspection ⇒ *page 263, Changing a wheel.*

## ⚠ WARNING

- New brake pads don't have the best stopping power and must be "broken-in" during the initial 100 to 150 miles (150 to 200 kilometers) of normal city driving. You can compensate for this by pressing the brake pedal more firmly. This also applies later when new pads are installed.
- You should perform braking maneuvers for the purpose of cleaning the brake system only if road conditions permit. Other road users must not be put at risk - you may cause an accident!
- Before descending a steep grade, reduce speed and shift transmission into a lower gear or lower driving range. Do not ride the brakes or hold the pedal down too long or too often. This could cause the brakes to get hot and diminish braking efficiency.
- Do not "ride the brakes" by resting your foot on the pedal when you do not intend to brake. This may cause the brakes to overheat, premature wear and increased stopping distance.
- Under certain climatic and operating conditions such as passing through water, driving in heavy rain or after washing the vehicle, the effectiveness of the brakes can be reduced. In winter, ice can accumulate on the brake pads, linings, discs and drums. Carefully apply brakes for a test. Brakes will dry and ice coatings will be cleaned off after a few careful brake applications.
- Driving for an extended period of time on salt-covered roads without using your brakes can also affect braking efficiency. Clean off accumulated salt coating from brake discs and pads with a few careful brake applications.
- If you damage the front spoiler, or if you install a different spoiler, be sure the air flow to the front brakes is not obstructed. Otherwise the brake system could

overheat reducing the effectiveness of the entire brake system.

- Failure of one brake circuit will impair the braking capability resulting in an increased stopping distance. Avoid driving the vehicle and have it towed to the nearest authorized Audi dealer or qualified workshop.
- Never let the vehicle roll to a stop with the engine shut off.
- If the brake booster is not working, the brake pedal must be pressed considerably harder to make up for the lack of booster assistance.

## Electro-mechanical power assist, dynamic steering

*The electro-mechanical power assist helps the driver when steering.*

Power steering adapts *electronically* based on the vehicle speed.

### Indicator lights and messages

#### **Steering defective! Do not drive vehicle!**

If this indicator light turns on and stays on and this message appears, the power steering may have failed.

Do **not** continue driving. See your authorized Audi dealer or a qualified repair facility for assistance.

#### **Dynamic steering: System fault! You can continue driving**

If the indicator light turns on and the message appears, the steering may be more difficult to move or more sensitive than usual. The steering wheel may also be at an angle when driving straight.

Drive slowly to your authorized Audi dealer or qualified workshop to have the malfunction corrected.



#### **Dynamic steering: initializing**

If this driver message appears and the indicator light is flashing on the instrument panel, dynamic steering\* is being reinitialized. After starting the engine, the steering wheel will move slightly. Re-initialization might be necessary if the steering wheel was moved hard to the left and right while the vehicle was not moving. The display goes out as soon as initialization is complete.

#### **WARNING**

Have the dynamic steering\* system malfunction repaired as soon as possible by an authorized Audi dealer or qualified workshop - risk of accident!

#### **Tips**

- If the  or  indicator light only stays on for a short time, you may continue driving.
- The dynamic steering\* stability systems are not available in the event of a system malfunction.
- For additional information on dynamic steering\*, refer to ⇨ *page 115*.

## Driving with your quattro

Applies to vehicles: with all-wheel drive

*With all-wheel drive, all four wheels are driven.*

### General information

With all-wheel drive, power is distributed to all four wheels. This happens automatically depending on your driving style and the road conditions at the time. See also ⇨ *page 185*.

A center differential distributes the driving power variably to the front and rear axle. It works together with selective wheel torque control, which activates when driving through curves ⇨ *page 186*. With the sport differential\*, power distribution to the rear wheels is variable and can be adjusted with drive select ⇨ *page 115*.

The all-wheel drive concept is designed for high engine power. Your vehicle is exceptionally powerful and has excellent driving characteristics both under normal driving conditions and on snow and ice. Always read and follow safety precautions ⇒ .

### Winter tires

When driving in the winter, your vehicle with all-wheel drive has an advantage, even with regular tires. In winter road conditions it may be advisable to mount winter tires (or all-season tires) for improved driveability and braking: these tires must be mounted on **all four wheels**. See also ⇒ *page 254, Winter tires*.

### Tire chains

Where tire chains are mandatory on certain roads, this normally also applies to vehicles with all-wheel drive ⇒ *page 255, Snow chains*.

### Replacing wheels/tires

Vehicles with all-wheel drive must always have tires of the same size. Also avoid tires with different tread depths. For details see *page 248, New tires and replacing tires and wheels*.

### Off-Road driving?

Your Audi does not have enough ground clearance to be used as an off-road vehicle. It is therefore best to avoid rough tracks and uneven terrain as much as possible. Also refer to ⇒ *page 193*.

#### **WARNING**

Always adjust your driving to road and traffic conditions. Do not let the extra safety afforded by all-wheel drive tempt you into taking extra risks.

- Although the all-wheel drive is very effective, always remember that braking capacity is limited by tire traction. You should therefore not drive at excessive speeds on icy or slippery road surfaces.
- On wet road surfaces, be careful not to drive too fast because the front wheels

could begin to slide on top of the water (aquaplaning). If this should occur, you will have no warning from a sudden increase in engine speed as with a front-wheel drive vehicle. Always drive at speeds which are suited to the road conditions – risk of crash.

## Energy management

### Starting ability is optimized

*Energy management controls the distribution of electrical energy and thus optimizes the availability of electrical energy for starting the engine.*

If a vehicle with a conventional energy system is not driven for a long period of time, the battery is discharged by idling current consumers (e.g. immobilizer). In certain circumstances it can result in there being insufficient energy available to start the engine.

Intelligent energy management in your vehicle handles the distribution of electrical energy. Starting ability is markedly improved and the life of the battery is extended.

Basically, energy management consists of **battery diagnosis**, **idling current management** and **dynamic energy management**.

### Battery diagnosis

Battery diagnosis continuously determines the state of the battery. Sensors determine battery voltage, battery current and battery temperature. This determines the current state of charge and the power of the battery.

### Idling current management

Idling current management reduces energy consumption while the vehicle is standing. With the ignition switched off, it controls the energy supply to the various electrical components. Data from battery diagnosis is considered.

Depending on the battery's state of charge, individual consumers are gradually turned off ▶

to prevent excessive discharge of the battery and thus maintain starting capability.

### **Dynamic energy management**

While the vehicle is being driven, dynamic energy management distributes the energy generated according to the needs of the individual components. It regulates consumption, so that more electrical energy is not being used than is being generated and ensures an optimal state of charge for the battery.

#### **i Tips**

- But even energy management cannot negate the limits of physics. Consider that the power and life of a battery are limited.
- If starting ability is threatened, the indicator light  appears ⇒ *page 16*.

### **What you should know**

*The highest priority is given to maintaining starting capability.*

The battery is severely taxed in short-distance driving, in city traffic and during the cold time of year. Abundant electrical energy is required, but only a little is generated. It is also critical if the engine is not running and electrical components are turned on. In this instance energy is being consumed but none is being generated.

It is in precisely these situations that you will notice energy management actively regulating the distribution of energy.

### **Vehicle stands for an extended period**

If you do not drive your vehicle over a period of several days or weeks, electrical components are gradually cut back or switched off. This reduces energy consumption and maintains starting capability over a longer period. Some of the convenience functions may not operate, such as the interior lights or the power seat adjustment. The convenience functions will be available again when you switch on the ignition and start the engine.

### **With the engine turned off**

If you listen to the radio, for example, with the engine turned off or use other MMI functions, the battery is being discharged.

If starting capability is jeopardized due to energy consumption, the following warning appears in the MMI display:

**Please start the engine soon or the system will be turned off.**

The warning indicates that the system will be turned off automatically after 3 minutes. If you wish to continue using the functions, you have to start the engine.

### **With the engine running**

Although electrical energy is generated when the vehicle is being driven, the battery can become discharged. This happens mostly when little energy is being generated and a great deal consumed and the battery's state of charge is not optimal.

To bring the energy balance back into equilibrium, consumers which require especially large amounts of energy are temporarily cut back or switched off. Heating systems in particular require a great deal of energy. If you notice, for example, that the heated seats\* or the heated rear window are not heating, they have been temporarily cut back or switched off. These systems will be available again as soon as the energy balance has been restored.

You will also notice that engine idle speed has been increased slightly. This is normal and not a cause for concern. By increasing engine idle speed the additional energy required is generated and the battery is charged.

## Driving and environment

### The first 1,000 miles (1,500 km) and afterwards

#### New engine

The engine needs to be run-in during the first 1,000 miles (1,500 km).

#### For the first 600 miles (1,000 kilometers):

- ▶ Do not use full throttle.
- ▶ Do not drive at engine speeds that are more than 2/3 of the maximum permitted RPM.

#### From 600 to 1,000 miles (1,000 to 1,500 kilometers):

- ▶ Speeds can *gradually* be increased to the maximum permissible road or engine speed.

#### During and after break-in period

- ▶ Do not rev the engine up to high speeds when it is cold. This applies whether the transmission is in N (Neutral) or in gear.

#### After the break-in period

- ▶ Do not exceed maximum engine speed under any circumstances.
- ▶ Upshift into the next higher gear *before* reaching the red area at the end of the tachometer scale ⇒ *page 10*.

During the first few hours of driving, the engine's internal friction is higher than later when all the moving parts have been broken in. How well this break-in process is done depends to a considerable extent on the way the vehicle is driven during the first 1,000 miles (1,500 kilometers).

#### Note

Extremely high engine speeds are automatically reduced. However, these rpm limits are programmed for an engine well run-in, not a new engine.



#### For the sake of the environment

Do not drive with unnecessarily high engine speeds - upshifting early saves fuel, reduces noise and protects the environment.

#### New tires

If your vehicle is running on new tires, drive very carefully for the first 350 miles (500 kilometers) after fitting.



#### WARNING

New tires tend to be slippery and must also be "broken-in". Be sure to remember this during the first 350 miles (500 kilometers). Brake gently. Avoid following closely behind other vehicles or other situations that might require sudden, hard braking.

## Avoid damaging the vehicle

When you are driving on poor roads, or over curbs, steep ramps, etc., make certain that low-lying parts such as spoilers and exhaust system parts do not bottom out and get damaged.

This is especially true for vehicles with low-slung chassis (sports chassis)\* and fully loaded vehicles.

## Driving through water on roads

Note the following to avoid vehicle damage when driving through water, for example on flooded roads:

- The water must not be any higher than the bottom of the vehicle body.
- Do not drive faster than walking speed. ▶

**⚠ WARNING**

After driving through water, mud, slush, etc., the brakes may be slow to take effect because of wet brake rotors and pads. Dry the brakes first by braking carefully to restore the full braking effect.

**! Note**

Vehicle components such as the engine, transmission, suspension or electrical system can be severely damaged by driving through water.

**i Tips**

- Check the depth of the water before driving through it.
- Do not stop the vehicle, drive in reverse or switch the engine off when driving through water.
- Keep in mind that oncoming vehicles may create waves that raise the water level and make it too deep for your vehicle to drive through safely.
- Avoid driving through salt water because it can cause corrosion.

## Catalytic converter

*It is very important that your emission control system (catalytic converter) is functioning properly to ensure that your vehicle is running in an environmentally sound manner.*

- ▶ Always use lead-free gasoline ⇒ *page 207, Fuel supply.*
- ▶ Never run the tank down all the way to empty.
- ▶ Never put too much motor oil in your engine ⇒ *page 216,  Adding engine oil .*
- ▶ Never try to push- or tow-start your vehicle.

The catalytic converter is an efficient “clean-up” device built into the exhaust system of the vehicle. The catalytic converter burns many of the pollutants in the exhaust gas before they are released into the atmosphere.

The exclusive use of unleaded fuel is critically important for the life of the catalytic converter and proper functioning of the engine.

**⚠ WARNING**

- The temperature of the exhaust system is high, both when driving and after stopping the engine.
- Never touch the exhaust tail pipes once they have become hot. This could result in burns.
- Do not park or operate the vehicle in areas where the hot exhaust system may come in contact with dry grass, brush, fuel spill or other material which can cause a fire.
- Do not apply additional undercoating or rustproofing on or near the exhaust manifold, exhaust pipes, catalytic converter or heat shields. During driving, the substance used for undercoating could overheat and cause a fire.

**! Note**

- Be aware that just one tank filling with **leaded** fuel will already seriously degrade the performance of the catalytic converter.
- Do not exceed the correct engine oil level ⇒ *page 216.*
- Do not drive until the fuel tank becomes completely empty. The engine could misfire. Unburned fuel could also get into the exhaust system and this could cause the catalytic converter to overheat.
- Do not turn off the ignition while the vehicle is moving.
- Do not continue to operate your vehicle under these conditions, as otherwise fuel can reach the catalytic converter. This could result in overheating of the converter, requiring its replacement.
- To assure efficient operation of the Emission Control System: ▶

- Have your vehicle maintained properly and in accordance with the service recommendations in your Warranty & Maintenance booklet.
- Lack of proper maintenance as well as improper use of the vehicle will impair the function of the emission control system and could lead to damage.



### For the sake of the environment

Even when the Emission Control System is operating properly, the exhaust gas can have a sulfur-like exhaust gas smell under some operating states. This depends on the sulfur content of the fuel being used. Using a different brand of fuel may help, or filling the tank with lead-free super grade gasoline.

## Shutting down vehicle

If you would like your vehicle to remain inoperative for a longer period of time, contact an Audi or other specialized dealer. They can advise you on necessary precautions e.g. corrosion prevention, maintenance and storage. Pay attention to additional information concerning the battery. Refer to ⇒ page 222.

## Operate your vehicle economically and minimize pollution

### General

*Your personal style of driving will determine the economy of your vehicle, as well as exhaust and noise levels.*

Fuel economy, environmental impact, and wear on your engine, brakes and tires largely depend on three factors:

- your personal driving style
- operating conditions
- technical limitations

If you anticipate what you need to do next and drive economically, you can easily cut your fuel consumption by 10-15 percent. This sec-

tion will give you some tips on how you can help the environment and your pocketbook.

### Tips

The consumption estimates as published by ENVIRONMENTAL PROTECTION AGENCY (EPA) and Transport Canada may not correspond to your actual consumption on the road, which will vary depending upon vehicle load and speed, road and weather conditions, trip length, etc.

### Drive smoothly and keep a lookout ahead

*Vehicles use the most fuel when they are accelerating.*

- ▶ Avoid unnecessary accelerating and braking.

Vehicles use the most fuel when they are accelerating. If you anticipate what is going to happen next, you will need to brake less and, thus, accelerate less. Let the vehicle coast whenever possible - for example when you see that the next traffic light is red.

### Avoid full throttle

*Driving at moderate speeds saves fuel and improves your mileage.*

- ▶ Try and keep well below your car's maximum speed.

Accelerating gently reduces fuel consumption, engine wear, and does not disturb the environment.

Fuel consumption, exhaust emissions and engine noise increase disproportionately at high speeds. If you drive at approximately three quarters of top speed, fuel consumption will be reduced by one half. Never drive faster than the posted speed limit and weather conditions permit.

### Reducing unnecessary idling

*Even when your car is just idling it burns up fuel.*

- ▶ Shut the engine off when you are not driving the vehicle.
- ▶ Do not warm up the vehicle by letting the engine run at idle.

It makes sense to shut off the engine in traffic jams, when waiting for trains to pass at railroad crossings, or at traffic lights that have long waits on red. Turning the engine off for just 30-40 seconds saves more fuel than is burned starting the engine again.

It takes a long time for the engine to warm up fully when it is running at idle. However, wear and noxious emissions are especially high when the engine is warming up. So you should drive away as soon as you start the engine and avoid running at high rpms while the engine is still warming up.

#### Note

Do not leave engine idling unattended after starting. If warning lights should come on to indicate improper operation, they would go unheeded. Extended idling also produces heat, which could result in overheating or other damage to the vehicle or other property.

### Regular maintenance

*A badly tuned engine unnecessarily wastes a lot of fuel.*

- ▶ Have your vehicle serviced at regular intervals.

By having your vehicle regularly serviced by an authorized Audi dealer helps to ensure that it runs properly and economically. The condition of your vehicle not only affects its safety and ability to hold its value, it also affects **fuel consumption**.

**Check your oil each time you fill your tank.**

The amount of oil used is related to engine load and speed.

It is normal for the oil consumption of a new engine to reach its lowest value after a certain mileage has been driven.

You must drive your vehicle about 3,000 miles (5,000 kilometers) before you can properly assess oil consumption.

This also applies to fuel consumption and engine output.

#### Note

- Have your vehicle maintained properly and in accordance with the service recommendations in your Warranty & Maintenance booklet. Lack of proper maintenance as well as improper use of the vehicle will impair the function of the emission control system and could lead to damage.
- Do not alter or remove any component of the Emission Control System unless approved by the manufacturer.
- Do not alter or remove any device, such as heat shields, switches, ignition wires, valves, which are designed to protect your vehicle's Emission Control System and other important vehicle components.

### Fewer short trips

*Fuel consumption will always be relatively high on short trips.*

- ▶ Try to avoid driving short distances with a cold engine.

The engine and catalytic converter have to reach their optimal **operating temperature** to reduce fuel consumption and noxious emissions effectively.

Just after starting, a cold engine in a mid-size car only achieves a fuel economy of 6-8 miles per gallon (30-40 l/100 km). After about a half a mile, fuel economy climbs to 12 mpg (20 l/100 km). After about 2.5 miles (4 km), ▶

the engine is at its proper operating temperature and fuel economy has reached a normal level. So you can see that you should avoid short trips whenever possible.

The **outside temperature** is also critical in this regard. Your car consumes more fuel in the winter than in the summer.

## allroad: Driving offroad

### General information

Applies to vehicles: allroad

When driving offroad, the functions for the electronic stabilization control (ESC) are expanded. The ESC-Offroad-Mode can be activated in driving situations in which a wheel lock or a differential lock function is needed ⇒ *page 187*. In addition, your Audi provides continuous all wheel drive.

**Your Audi is however, not an offroad vehicle. Never drive the vehicle in terrain which is not suitable for the vehicle, or which exceeds your driving skills. Never take any unnecessary risks!**

### After driving offroad

- After driving offroad, remove branches and other debris from the radiator grille, underbody, and wheels. Look especially for objects (stones) that have been caught in the tire tread.
- Clean the body and the vehicle underbody and inspect the vehicle for possible damages.
- Clean off the dirty windows, headlights, tail lights and the license plate.
- Perform a brake test (especially after driving through water).

### WARNING

- Be especially aware and attentive when driving under difficult conditions. Damages to the vehicle and injuries may occur when driving at an excessively high speed or with incorrect driving maneuvers.

- Always adjust your speed and handling to the roads, terrain, traffic and weather conditions. Drive especially slow if offroad with low visibility.
- Please note that the wheels can spin and the vehicle can break away when the ESC Offroad Mode is switched off, especially when the road is slippery.
- Driving stability is reduced in the ESC Offroad mode.



### For the sake of the environment

Avoid harming the environment and take nature into consideration.



### Tips

Only drive where it is allowed and always stay on the provided roads and paths.

### Driver messages

Applies to vehicles: allroad

*There is only one right way to drive in difficult conditions: slowly and with caution!*

When driving offroad, observe the following:

- ▶ Never drive the vehicle in terrain which is not suitable for the vehicle, or which exceeds your driving skills. Never take any unnecessary risks!
- ▶ Drive slowly and cautiously!
- ▶ Pay attention to the **ground clearance** of your vehicle! This may vary depending on the load and composition of the ground and the environment. The driver is therefore responsible for deciding whether a vehicle can handle a specific situation.
- ▶ Activate the **ESC-Offroad-Mode** ⇒ *page 187* as needed.

### Difficult terrain

Never drive in areas that are not familiar to you and drive slowly when offroad and be prepared and expect the unexpected (e.g. potholes, boulders, tree stumps, etc.)

To prevent the vehicle from bottoming and avoid damage to the underbody, you should drive straight across severe bumps in the

ground with only one side of the vehicle so that only two of your wheels cross the bumps.

Drive quickly through sandy or marshy offroad sections and do not stop, if at all possible.

### **Driving through water on roads**

Read the information on ⇒ *page 193*.

# Trailer towing

## Driving with a trailer

### General information

Your Audi was designed primarily for passenger transportation.

If you plan to tow a trailer, please remember that the additional load will affect durability, economy and performance.

Trailer towing not only places more stress on the vehicle, it also calls for more concentration from the driver.

For this reason, always follow the operating and driving instructions provided and use common sense.

### Technical requirements

#### Trailer hitch

Use a weight-carrying hitch conforming to the gross trailer weight. The hitch must be suitable for your vehicle and trailer and must be mounted securely on the vehicle's chassis at a *technically sound* location. Use only a trailer hitch with a removable ball mount. Always check with the trailer hitch manufacturer to make sure that you are using the correct hitch.

#### Do not use a bumper hitch.

The hitch must be installed in such a way that it does not interfere with the impact-absorbing bumper system. No modifications should be made to the vehicle exhaust and brake systems. From time to time, check that all hitch mounting bolts remain securely fastened.

When you are not towing a trailer, remove the trailer hitch ball mount. This prevents the hitch from causing damage should your vehicle be struck from behind ⇒ ⚠.

#### Trailer brakes

If your trailer is equipped with a braking system, check to be sure that it conforms to all regulations.

The trailer hydraulic brake system must not be directly connected to the vehicle's hydraulic brake system ⇒ ⚠.

#### Safety chains

Always use safety chains between your vehicle and the trailer.

#### Trailer lights

Trailer lights must meet all regulations. Be sure to check with your authorized Audi dealer for correct wiring, switches, and relays.

#### Mirrors

If you are unable to see the traffic behind you using the regular outside mirrors, then you *must* install extended mirrors. It is important that you *always* have clear vision to the rear.

#### ⚠ WARNING

- If a trailer has electrical brakes please note that these brakes are not activated by the factory-fitted control unit - risk of accident!
- After removing the trailer hitch, do not store it in your vehicle. In case of sudden braking, the hitch could fly forward and injure you or your passengers.

### Operating instructions

#### Maximum trailer weight

A trailer for your vehicle is limited to a typical class 1 or class 2 trailer.

#### Trailer load distribution

Be sure the load in the trailer is held securely in place to prevent it from shifting forward, backward or sideways.

#### Never allow a passenger to ride in a trailer

⇒ ⚠ in *Driving instructions on page 200*.

#### Engine cooling system

Towing a trailer makes the engine work harder. It is important that the cooling system's performance is up to the additional load. Make sure that the cooling system has enough fluid. ▶

### Tire pressure

When towing a trailer, inflate the tires of your vehicle to the cold tire pressure listed under “Full load” on the label located on the driver's side B-pillar (visible when the door is open). Inflate trailer tires to trailer and tire manufacturers' specifications.

### Lights

The headlight settings should be checked with the trailer attached before driving off. Check to make sure both vehicle and trailer lights are working properly.

### Safety chains

Be sure trailer safety chains are properly connected from the trailer to the hitch on the vehicle. Leave enough slack in the chains to permit turning corners. When you install safety chains, make sure they will not drag on the road when you are driving.

The chains should cross under the trailer tongue to prevent it from dropping in case of separation from the hitch.

### Driving instructions

*Driving with a trailer always requires extra care and consideration.*

To obtain the best possible handling of vehicle and trailer, please note the following:

- ▶ Do not tow a loaded trailer when your car itself is not loaded.
- ▶ Be especially careful when passing other vehicles.
- ▶ Observe speed limits.
- ▶ Do not drive at the maximum permissible speed.
- ▶ Always apply brakes early.
- ▶ Monitor the temperature gauge.

### Weight distribution

Towing a loaded trailer with an empty car results in a highly unstable distribution of weight. If this cannot be avoided, drive at very low speeds only to avoid the risk of losing steering control.

A “balanced” rig is easier to operate and control. This means that the tow vehicle should be loaded to the extent possible and permissible, while keeping the trailer as light as possible under the circumstances. Whenever possible, transfer some cargo to the luggage compartment of the tow vehicle while observing tongue load requirements and vehicle loading considerations.

### Speed

The higher the speed, the more difficult it becomes for the driver to control the rig. Do not drive at the maximum permissible speed. Reduce your speed even more if load, weather or wind conditions are unfavorable - particularly when going downhill.

Reduce vehicle speed **immediately** if the trailer shows the slightest sign of swaying. **Do not try to stop the swaying by accelerating.**

Observe speed limits. In some areas, speeds for vehicles towing trailers are lower than for regular vehicles.

Always apply brakes early. When driving downhill, shift into a lower gear to use the engine braking effect to slow the vehicle. Use of the brakes alone can cause them to overheat and fail.

### Coolant temperature

The coolant temperature gauge ⇒ *page 10* must be observed carefully. If the needle moves close to the upper end of the scale, reduce speed immediately and/or turn off the air conditioner.

If the coolant temperature warning light  in the instrument cluster starts flashing, pull off the road, stop and let the engine *idle* for about two minutes to prevent heat build-up.

### WARNING

Anyone not properly restrained in a moving vehicle is at a much greater risk in an accident. Never let anyone ride in your car who is not properly wearing the restraints provided by Audi.

## Trailer towing tips

### Important to know

Your vehicle handles differently when towing a trailer because of the additional weight and different weight distribution. Safety, performance and economy will greatly depend on how carefully you load your trailer and operate your rig.

Before you actually tow your trailer, practice turning, stopping and backing up in an area away from traffic. Keep practicing until you have become completely familiar with the way your vehicle-trailer combination behaves and responds.

Backing up is difficult and requires practice. Backing up with a trailer generally requires steering action opposite to that when backing up your vehicle without a trailer.

Maintain a greater distance between your vehicle and the one in front of you. You will need more room to stop. To compensate for the trailer, you will need a larger than normal turning radius.

When passing, remember that you cannot accelerate as fast as you normally would because of the added load. Make sure you have enough room to pass. After passing, allow plenty of room for your trailer before changing lanes again.

Avoid jerky starts, sharp turns or rapid lane changes.

### Tips

- Do not tow a trailer during the break-in period of your vehicle.
- If you tow a trailer, your Audi may require more frequent maintenance due to the extra load ⇨ [page 283](#).

### Parking on a slope

*Do not park on a slope with a trailer. If it cannot be avoided, do so only after doing the following:*

#### When parking:

- ▶ Apply the foot brake.
- ▶ Have someone place chocks under both the vehicle and the trailer wheels.
- ▶ With chocks in place, slowly release the brakes until the wheel chocks absorb the load.
- ▶ Turn the wheels towards the curb.
- ▶ Apply the parking brake.
- ▶ Place an automatic transmission\* in P, respectively a manual transmission in first or reverse gear.

#### When restarting after parking:

- ▶ Apply the foot brake.
- ▶ Start the engine.
- ▶ Move the selector lever to D/S, respectively a manual transmission in first gear.
- ▶ Release the parking brake and slowly pull out and away from the wheel chocks.
- ▶ Stop and have someone retrieve the wheel chocks.

### Tips

If you move the selector lever of the automatic transmission\* to P before applying the parking brake and before blocking the wheels, you may have to use more force later to move the lever out of the P position.

## Vehicle care and cleaning

### General information

Regular, proper care helps to maintain your vehicle's value. It can also be a requirement when submitting warranty claims for corrosion damage and paint defects on the body.

The required cleaning and care products can be obtained from your authorized Audi dealer or qualified workshop. Read and follow the instructions for use on the packaging.



#### WARNING

- Using cleaning and care products incorrectly can be dangerous to your health.
- Always store cleaning and care products out of reach of children to reduce the risk of poisoning.



#### For the sake of the environment

- Preferably use environmentally-friendly products when buying cleaning agents.
- Do not dispose of leftover cleaning and care products with household trash.

### Car washes

The longer deposits remain on the vehicle, the more the surface can be damaged. High temperatures such as those caused by sunlight increase the damaging effects.

Before washing, wet heavy deposits with plenty of water.

Stubborn deposits such as bird droppings or tree sap are best removed with plenty of water and a microfiber cloth.

Also, wash the underside of your vehicle once road salt stops being used for the season.

#### Pressure washers

When washing your vehicles with a pressure washer, always follow the operating instructions provided with the pressure washer. This is especially important in regard to the pres-

sure and spraying distance. Do not aim the spray directly at seals on side windows, doors, the hood, the rear lid or the sunroof\* or at tires, rubber hoses, insulating material, sensors\* or camera lenses\*. Keep a distance of at least 16 inches (40 cm).

Do not remove snow and ice with a pressure washer.

Never use rotary nozzles or high pressure nozzles.

The water temperature must not be above 140 °F (60 °C).

#### Automatic car washes

Spray off the vehicle before washing.

Make sure that the windows and roof\* are closed and the windshield wipers are off. Follow instructions from the car wash operator, especially if there are accessories attached to your vehicle.

If possible, use car washes that do not have brushes.

#### Washing by hand

Clean the vehicle starting from the top and working down using a soft sponge or cleaning brush. Use solvent-free cleaning products.

#### Washing vehicles with matte finish paint by hand

To avoid damaging the paint when washing, first remove dust and large particles from your vehicle. Insects, grease spots and fingerprints are best removed with a special cleaner for matte finish paint.

Apply the product using a microfiber cloth. To avoid damaging the paint surface, do not use too much pressure.

Rinse the vehicle thoroughly with water. Then clean using a neutral shampoo and a soft microfiber cloth.

Rinse the vehicle thoroughly again and let it air dry. Remove any water residue using a shammy.

**! WARNING**

- Only wash the vehicle when the ignition is off and follow the instructions from the car wash operator to reduce the risk of accidents.
- To reduce the risk of cuts, protect yourself from sharp metal components when washing the underbody or the inside of the wheel housings.
- After washing the vehicle, the braking effect may be delayed due to moisture on the brake rotors or ice in the winter. The brakes must be dried first with a few careful brake applications.

**! Note**

- If you wash the vehicle in an automatic car wash, you must fold the exterior mirrors in to reduce the risk of damage to the mirrors. Power folding exterior mirrors\* must only be folded in and out using the power folding function.
- To prevent paint damage, do not wash the vehicle in direct sunlight.

- To reduce the risk of damage to the surface, do not use insect removing sponges, kitchen sponges or similar items.
- Matte finish painted vehicle components:
  - To reduce the risk of damage to the surface, do not use polishing agents or hard wax.
  - Never use car wash cycles that apply protective wax. It can destroy the matte finish effect.
  - Do not place any stickers or magnetic signs on vehicle parts painted with matte finish paint. The paint could be damaged when the stickers or magnets are removed.

**🌳 For the sake of the environment**

Only wash the vehicle in facilities specially designed for that purpose. This will reduce the risk of dirty water contaminated with oil from entering the sewer system.

## Cleaning and care information

When cleaning and caring for individual vehicle components, refer to the following tables. The information contained there is simply recommendations. For questions or for components that are not listed, refer to an authorized Audi dealer or qualified workshop. Also follow the information found in ⇒ **!**

### Cleaning exterior

Component	Situation	Solution
<b>Wiper blades</b>	Dirty	⇒ page 56, <i>Cleaning windshield wiper blades</i>
<b>Headlights/ tail lights</b>	Dirty	Soft sponge with a mild soap solution <sup>a)</sup>
<b>Sensors/ camera lenses</b>	Dirty	Sensors: soft cloth with a solvent-free cleaning product Camera lenses: soft cloth with an alcohol-free cleaning solution
	Snow/ice	Hand brush/solvent-free de-icing spray
<b>Wheels</b>	Road salt	Water
	Brake dust	Acid-free special cleaning solution
<b>Exhaust tail pipes</b>	Road salt	Water, cleaning solution suitable for stainless steel, if necessary

Component	Situation	Solution
<b>Decorative parts/trim</b>	Dirty	Mild soap solution <sup>a)</sup> , a cleaning solution suitable for stainless steel, if necessary
<b>Paint</b>	Paint damage	Refer to the paint number on the vehicle data label, repair with touch up paint ⇒ <i>page 280</i>
	Spilled fuel	Rinse with water immediately
	Rust film	Rust film remover, then protect with hard wax; for questions, refer to an authorized Audi dealer or qualified workshop
	Corrosion	Have it removed by an authorized Audi dealer or qualified workshop
	Water no longer beads on the surface of clean paint	Protect with hard wax (at least twice per year)
	No shine even though paint has been protected/paint looks poor	Treat with suitable polish; then apply paint protectant if the polish that was used does not contain any protectant
	Deposits such as insects, bird droppings, tree sap and road salt	Dampen with water immediately and remove with a microfiber cloth
	Grease-based contaminants such as cosmetics or sun-block	Remove immediately with a mild soap solution <sup>a)</sup> and a soft cloth
<b>Carbon parts</b>	Dirty	Clean the same way as painted parts ⇒ <i>page 202, Car washes</i>

<sup>a)</sup> Mild soap solution: maximum two tablespoons neutral soap in 1 quart (1 liter) of water

### Cleaning interior

Component	Situation	Solution
<b>Windows</b>	Dirty	Glass cleaner, then wipe dry
<b>Decorative parts/trim</b>	Dirty	Mild soap solution <sup>a)</sup>
<b>Plastic parts</b>	Dirty	Damp cloth
	Heavily soiled	Mild soap solution <sup>a)</sup> , solvent-free plastic cleaning solution, if necessary
<b>Displays</b>	Dirty	Soft cloth with LCD cleaner
<b>Controls</b>	Dirty	Soft brush, then a soft cloth with a mild soap solution <sup>a)</sup>
<b>Safety belts</b>	Dirty	Mild soap solution <sup>a)</sup> , allow to dry before letting them retract

Component	Situation	Solution
<b>Textiles, Vinyl, Alcantara</b>	Stains adhering to the surface	Vacuum cleaner
	Water-based stains such as coffee, tea, blood, etc.	Absorbent cloth and mild soap solution <sup>a)</sup>
	Oil-based stains such as oil, make-up, etc.	Apply a mild soap solution <sup>a)</sup> , blot away the dissolved oil or dye, treat afterward with water, if necessary
	Special stains such as ballpoint pen, nail polish, latex paint, shoe polish, etc.	Special stain remover, blot with absorbent material, treat afterward with mild soap solution <sup>a)</sup> , if necessary
<b>Natural leather</b>	Fresh stains	Cotton cloth with a mild soap solution <sup>a)</sup>
	Water-based stains such as coffee, tea, blood, etc.	Fresh stains: absorbent cloth Dried stains: stain remover suitable for leather
	Oil-based stains such as oil, make-up, etc.	Fresh stains: absorbent cloth and stain remover suitable for leather dried stains: Oil cleaning spray
	Special stains such as ballpoint pen, nail polish, latex paint, shoe polish, etc.	Stain remover suitable for leather
	Care	Regularly apply conditioning cream that protects from light and penetrates into the material. Use specially-colored conditioning cream, if necessary.
<b>Carbon parts</b>	Dirty	Clean the same way as plastic parts

<sup>a)</sup> Mild soap solution: maximum two tablespoons neutral soap in 1 quart (1 liter) of water

 **WARNING**

The windshield may not be treated with water-repelling windshield coating agents. Unfavorable conditions such as wetness, darkness, or low sun can result in increased glare. Wiper blade chatter is also possible.

 **Note**

- **Headlights/tail lights**
  - Never clean headlights or tail lights with a dry cloth or sponge.

- Do not use any cleaning product that contains alcohol, because they could cause cracks to form.
- **Wheels**
  - Never use any paint polish or other abrasive materials.
  - Damage to the protective layer on the rims such as stone chips or scratches must be repaired immediately.
- **Sensors/camera lenses**
  - Never use warm or hot water to remove snow or ice from the camera lens. This could cause the lens to crack.

- Never use abrasive cleaning materials or alcohol to clean the camera lens. This could cause scratches and cracks.
- **Windows**
  - Remove snow and ice on windows and exterior mirrors with a plastic scraper. To avoid scratches, move the scraper only in one direction and not back and forth.
  - Never remove snow or ice from windows and mirrors using warm or hot water because this could cause cracks to form.
  - To avoid damage to the rear window defogger, do not apply any stickers on the heating wires on the inside of the window.
- **Decorative parts/trim**
  - Never use chrome care or cleaning products.
- **Paint**
  - To reduce the risk of scratches, the vehicle must be free of dirt and dust before polishing or waxing.
  - To prevent paint damage, do not polish or wax the vehicle in direct sunlight.
  - To reduce the risk of paint damage, do not polish away rust film.
  - Remove cosmetics and sunblock immediately. Otherwise, the paint could be damaged.
- **Displays**
  - To avoid scratches, do not use dry cleaning methods on displays.
- **Controls**
  - Make sure that no fluids enter the controls, because this could cause damage.
- **Safety belts**
  - Do not remove the safety belts to clean them.
  - Never clean safety belts or their components chemically or with corrosive fluids or solvents and never allow sharp objects to come into contact with the safety belts. This could cause damage to the belt webbing.

- If there is damage to the webbing, the connections, the retractors or the buckles, have them replaced by an authorized Audi dealer or qualified workshop.
- **Textiles/Vinyl/Alcantara**
  - Never treat Vinyl/Alcantara with leather care products, solvents, floor polish, shoe polish, stain remover or similar products.
  - To avoid damage, have stubborn stains removed by an authorized Audi dealer or qualified workshop.
  - Never use steam cleaners, brushes, hard sponges, etc. when cleaning.
  - Do not turn on the seat heating\* to dry the seat.
  - Objects with sharp edges such as zippers, rivets on clothing or belts can cause damage to the surface.
  - Open hook and loop fasteners, for example on clothing, can damage seat covers. Make sure hook and loop fasteners are closed.
- **Natural leather**
  - Never treat leather with solvents, floor polish, shoe polish, stain remover or similar products.
  - Objects with sharp edges such as zippers, rivets on clothing or belts can cause damage to the surface.
  - Never use steam cleaners, brushes, hard sponges, etc. when cleaning.
  - Do not turn on the seat heating\* to dry the seat.
  - To help prevent the leather from fading, do not leave the vehicle in direct sunlight for long periods of time. If leaving the vehicle parked for long periods of time, you should cover the leather to protect it from direct sunlight.

### Tips

- Insects are easier to remove from paint that has been freshly waxed.
- Regular waxing can prevent rust film from forming.

# Fuel supply and filling your fuel tank

## Gasoline

### Fuel supply

*Using the right fuel helps keep the environment clean and prevents engine damage.*

### Fuel recommendation

The fuel recommended for your vehicle is **unleaded premium** grade gasoline. Audi recommends using TOP TIER Detergent Gasoline with a minimum octane rating of 91 AKI (95 RON). For more information on TOP TIER Detergent Gasoline, please go to the official website ([www.toptiergas.com](http://www.toptiergas.com)).

The recommended gasoline octane rating for your engine can also be found on a label located on the inside of the fuel filler flap. This rating may be specified as AKI or RON.

Your vehicle may also be operated using unleaded regular gasoline with a minimum octane rating of 87 AKI/91 RON. However, using 87 AKI/91 RON octane fuel will slightly reduce engine performance.

**Use unleaded gasoline only.** Unleaded gasoline is available throughout the USA, Canada, and in most European countries. We recommend that you do not take your vehicle to areas or countries where unleaded gasoline may not be available.

For more information on refueling your vehicle, see ⇒ *page 209*.

### Octane rating

Octane rating indicates a gasoline's ability to resist engine damaging "knock" caused by premature ignition and detonation. Therefore, buying the correct grade of gasoline is very important to help prevent possible engine damage and a loss of engine performance.

Gasoline most commonly used in the United States and Canada has the following octane ratings that can usually be found on the filler pump:

– Premium Grade: 91 - 96 AKI

– Regular Grade: 87 - 90 AKI

Explanation of the abbreviations:

AKI = **A**nti **K**nock **I**ndex =  $(R+M)/2 = (RON + MON)/2$

RON = **R**esearch **O**ctane **N**umber

MON = **M**otor **O**ctane **N**umber.

### ! Note

- Do not use any fuel with octane ratings lower than 87 AKI or 91 RON otherwise expensive engine damage will occur.
- Do **not** use leaded gasoline. The use of leaded gasoline will severely damage your vehicle's catalytic converter and its ability to control exhaust emissions.

### Blended gasoline

#### Use of gasoline containing alcohol or MTBE (methyl tertiary butyl ether)

You may use unleaded gasoline blended with alcohol or MTBE (commonly referred to as oxygenates) if the blended mixture meets the following criteria:

#### Blend of gasoline methanol (wood alcohol or methyl alcohol)

- Anti-knock index must be 87 AKI or higher.
- Blend must contain no more than 3% methanol.
- Blend must contain more than 2% co-solvents.

#### Blend of gasoline and ethanol (grain alcohol or ethyl alcohol)

- Anti-knock index must be 87 AKI or higher.
- Blend must not contain more than 15% ethanol.
- Vehicles with flexible fuel engine: blend must not contain more than 85% ethanol.

#### Blend of gasoline and MTBE

- Anti-knock index must be 87 AKI or higher.
- Blend must contain not more than 15% MTBE.

### Seasonally adjusted gasoline

Many gasoline grades are blended to perform especially well for winter or summer driving. During seasonal change-over, we suggest that you fill up at busy gas stations where the seasonal adjustment is more likely to be made in time.

#### Note

- Fuels containing a high percentage of ethanol such as E50 and E85 may only be used in vehicles with flexible fuel engines. Using high ethanol fuel in vehicles not equipped with flexible fuel engines can cause severe engine damage.
- Methanol fuels which do not meet these requirements may cause corrosion and damage to plastic and rubber components in the fuel system.
- Do not use fuels that fail to meet the specified criteria in this chapter.
- If you are unable to determine whether or not a particular fuel blend meets the specifications, ask your service station or its fuel supplier.
- Do not use fuel for which the contents cannot be identified.
- Fuel system damage and performance problems resulting from the use of fuels different from those specified are not the responsibility of Audi and are not covered under the New Vehicle or the Emission Control System Warranties.
- If you experience a loss of fuel economy or driveability and performance problems due to the use of one of these fuel blends, we recommend that you switch to unblended fuel.

### Ethanol fuel (Bio-ethanol)

Applies to vehicles: with flexible fuel engine

*You can recognize vehicles with a flexible fuel engine by looking at the label on the inside of the fuel filler flap.*

Vehicles with flexible fuel engines may be operated with bio-ethanol fuels such as E85

(85% ethanol and 15% gasoline) or with unleaded gasoline (91 AKI/ROZ 95). The vehicle may also be operated with a mixture of these fuels.

Your fuel consumption will increase when using bio-ethanol fuels due to the lower amount of energy contained per unit volume in ethanol.

### Warming up the flexible fuel engine in low temperatures

Due to the chemical composition of bio-ethanol, a certain amount of fuel ends up in the engine oil when driving short distances in very low temperatures. This fuel evaporates again when the engine is warmed up.

#### Please warm up engine.

If the driver message appears in the instrument cluster display, drive with a warm engine to reduce the oil level.

#### Note

- Never fill with methanol or with a higher percentage of bio-ethanol than 85% (E85). A higher percentage of bio-ethanol in the fuel can cause damage to the engine or to the fuel system.
- If you use only E85, it is recommended to fill the fuel tank completely with unleaded premium grade gasoline every 5,000 miles.
- If you experience starting, rough idle or hesitation driveability problems, fill the fuel tank completely with unleaded premium grade gasoline and drive it normally until the gasoline is used. See your authorized Audi dealer if the problem persists.
- Inform your authorized Audi dealer that you are operating or have operated the vehicle with E85.
- Read and follow the information and tips about gasoline ⇒ page 207.

**i Tips**

It may take longer to start the engine when the outside temperature is very cold. If possible, use winterized fuel if temperatures are below freezing.

**Gasoline additives**

A major concern among many auto manufacturers is carbon deposit build-up caused by the type of gasoline you use.

Although gasoline grades differ from one manufacturer to another, they have certain things in common. All gasoline grades contain substances that can cause deposits to collect on vital engine parts, such as fuel injectors and intake valves. Although most gasoline brands include additives to keep engine and fuel systems clean, they are not equally effective.

Audi recommends using TOP TIER Detergent Gasoline. For more information on TOP TIER Detergent Gasoline, please go to the official website ([www.toptiergas.com](http://www.toptiergas.com)).

After an extended period of using inadequate fuels, built-up carbon deposits can rob your engine of peak performance.

**! Note**

- Damage or malfunction due to poor fuel quality is not covered by the Audi New Vehicle Limited Warranty.
- Do not add aftermarket fuel additive products to your fuel tank.

**Fuel tank****Fuel filler neck**

The fuel filler neck is located on the right rear side panel behind the fuel filler flap.

If the power locking system should fail, you can still open the flap manually - for detailed instructions see ⇒ *page 211*.

You can find the fuel tank capacity of your vehicle in ⇒ *page 281*.

The label on the inside of the fuel filler flap tells you the correct fuel for your vehicle. For more information about fuel specifications, see ⇒ *page 207*.

Your vehicle fuel tank has an on-board refueling vapor recovery system. This feature helps to prevent fuel vapors from escaping from the tank and polluting the environment while you refuel your vehicle. In order to fill the tank properly while protecting the environment, please follow this refueling procedure carefully.

**! WARNING**

Under normal operating conditions, never carry additional fuel containers in your car. Gas canisters and other containers used to transport fuel can be dangerous. Such containers, full or empty, may leak and could cause a fire in a collision. If you must transport fuel to use for your lawn mower, snow blower, etc., be very careful and always observe local and state laws regarding the use, transportation and storage of such fuel containers. Make certain the container meets industry standards (ANSI/ASTM F852 - 86).

**! Note**

Never drive your vehicle until the fuel tank is completely empty. The irregular supply of fuel can cause misfiring. Gasoline could enter the exhaust system and damage the catalytic converter.

## Refuelling

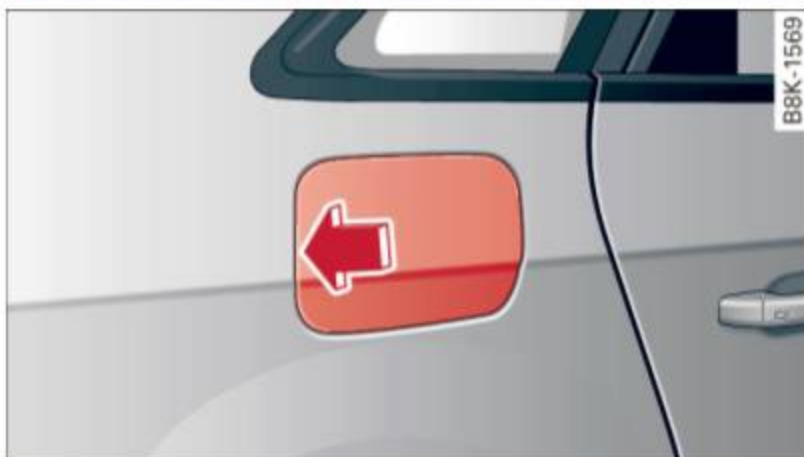

**Fig. 176** Right rear vehicle side: Opening the fuel filler flap



**Fig. 177** Fuel filler flap with attached fuel cap

When activating the central locking, the fuel filler flap is automatically unlocked or locked. Refuel the vehicle with the ignition turned *off*.

### Taking the fuel cap off

- ▶ Turn off the ignition.
- ▶ Press the left side of the fuel filler flap to open it ⇒ *fig. 176* -arrow-.
- ▶ Unscrew fuel cap counter-clockwise and hang it on the fuel filler flap ⇒ *fig. 177*.

### Refuelling procedure

- ▶ Insert the fuel nozzle from the gasoline pump into the fuel filler neck as far as it will go.
- ▶ Select a medium refuelling rate so that the nozzle switches off automatically when the tank is full.

### Putting the fuel cap back on

- ▶ After filling your tank, twist the fuel cap clockwise as far as it will go.
- ▶ Close the fuel filler flap.

To avoid fuel spilling or evaporating from the fuel tank always close fuel cap properly and completely.

### WARNING

Improper refueling or handling of fuel can cause fire, explosion and severe burns.

- Fuel is highly flammable and can cause severe burns and other injuries.
- Failure to shut the engine off while refueling and/or to insert the pump nozzle fully into the fuel filler neck could cause fuel to spray out of filler neck or to overflow. Fuel spray and overflowing fuel can cause a fire.
- Never use a cellular telephone while refueling. The electromagnetic radiation can cause sparks that can ignite fuel vapors and cause a fire.
- Never get back into your vehicle while refueling. If in exceptional circumstances you must get back in your vehicle while refueling, make certain that you close the door and touch metal to discharge static electricity before touching the filler nozzle again. Static electricity can cause sparks that can ignite fuel vapors released during refueling.
- Never smoke or have an open flame anywhere in or near your vehicle when refueling or filling a portable fuel container.
- For your safety, we strongly recommend that you do not travel with a portable fuel container in your vehicle. The container, full or empty may leak and could cause a fire, especially in a crash.
- If, under exceptional circumstances, you must transport a portable fuel container, please observe the following:
  - Never fill a portable fuel container while it is anywhere in or on the vehicle (for example, in the luggage compartment, or on the trunk). Static electricity can build up while filling and can ignite fuel vapors causing a fire.
  - Always place a portable fuel container on the ground before filling.

- Always keep the filler nozzle completely inside the portable container before and during filling.
- If filling a portable container made of metal, the filler nozzle must always be in contact with the container. This will help prevent static electricity from discharging and cause a fire.
- Never spill fuel inside the vehicle or luggage compartment. Fuel vapors are highly flammable.
- Always observe local and state/provincial laws regarding the use, storage and transportation of fuel containers.
- Make certain the fuel container meets industry standards (ANSI / ASTM F852-86).

### Note

If any fuel has spilled onto the car, it should be removed immediately to prevent damage to the paint.

### For the sake of the environment

As soon as the correctly operated nozzle switches off automatically for the first time, the tank is full. Do not try to add more fuel because fuel may spill out. In addition, the expansion space in the fuel tank will be filled - causing the fuel to overflow when it becomes warm and pollute the environment.

### Tips

- Running your engine while refuelling may cause vapors to escape or even cause fuel to spill out of the tank. This would then shut off the fuel nozzle before the tank is full.
- Do not refuel your vehicle with the ignition turned on. The fuel gauge may otherwise not indicate the correct fuel level after refuelling.
- The fuel filler flap of your vehicle is not locked when you lock the vehicle from the inside.

### Unlocking the fuel filler flap by hand

You can open the fuel filler flap by hand if the power locking system should fail.



Fig. 178 Sedan Luggage compartment: opening the side trim



Fig. 179 Luggage compartment: Emergency opening of fuel filler flap

The emergency opening mechanism is located behind the right side trim panel in the luggage compartment.

### Opening the side trim

- ▶ Sedan: Insert a tool such as a screwdriver ⇒ *page 260* or the emergency key into the right side of the upper gap ⇒ *fig. 178*.
- ▶ Sedan: Pry upward to release the trim.
- ▶ allroad: Open the right side trim panel.

### Fuel filler door emergency release

- ▶ Loosen the strap from its bracket and pull on it ⇒ *fig. 179*. You can now open the fuel filler flap as usual ⇒ *page 210*.

## Checking and filling

### Engine hood

#### Releasing and opening the engine hood

The engine hood is released from inside the vehicle.

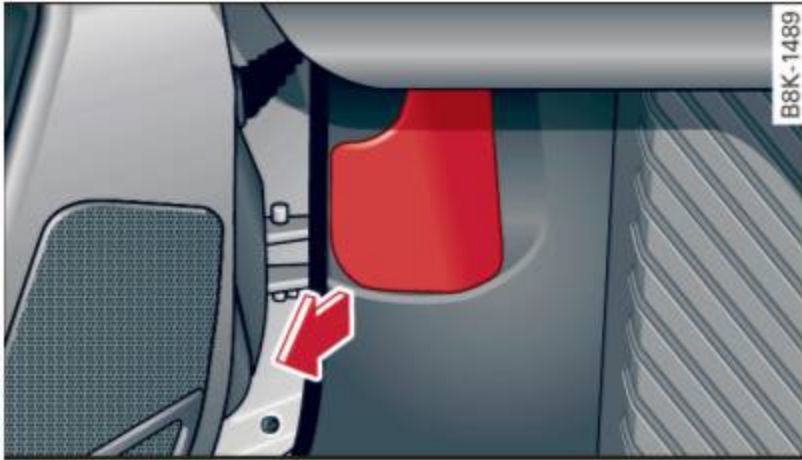

Fig. 180 Driver's side footwell: engine hood release lever



Fig. 181 Release lever under the engine hood

Before opening the engine hood, make sure that the windshield wipers are flat against the windshield. Otherwise, they could damage the paint on the hood.

- ▶ With the driver's door open, pull the lever under the instrument panel in the direction of the arrow ⇒ *fig. 180*.
- ▶ Raise the hood slightly ⇒ ⚠
- ▶ Press the rocker switch under the hood upward ⇒ *fig. 181*. This releases the catch.
- ▶ Open the hood.

#### ⚠ WARNING

- Hot engine coolant can burn you.
- To reduce the risk of being burned, never open the hood if you see or hear steam or coolant escaping from the engine compartment. Wait until no steam or

coolant can be seen or heard before carefully opening the hood.

#### Closing the engine hood

- ▶ Pull the hood down until the pressure from the struts is reduced.
- ▶ Let the hood *drop down* and latch in place. *Do not try to push it shut*; it may fail to engage ⇒ ⚠.

#### ⚠ WARNING

A hood that is not completely latched could fly up and block your view while driving.

- When you close the engine hood, check it to make sure the safety catch has properly engaged. The hood should be flush with the surrounding vehicle body parts.
- If you notice while driving that the hood is not secured properly, stop at once and close it.

#### Working in the engine compartment

Be especially careful whenever you work in the engine compartment.

Whenever you must perform any work in the engine compartment, for example checking and filling different fluids, there is a risk of injury, burns and accidents. To prevent personal injury always observe the following **WARNINGS**. The engine compartment of any vehicle is a hazardous area ⇒ ⚠.

#### ⚠ WARNING

To help avoid injury, before you check anything under the hood:

- Turn off the engine.
- Remove the ignition key.
- Apply the parking brake.
- Move selector lever of automatic transmission to “P” (Park); put manual transmission in Neutral.
- Always let the engine cool down. Hot components will burn skin on contact.

- To reduce the risk of being burned, never open the hood if you see or hear steam or coolant escaping from the engine compartment. Wait until no steam or coolant can be seen or heard before carefully opening the hood.
- Keep children away from the engine compartment.
- Never spill fluids on hot engine components. They can cause a fire.
- Never touch the radiator fan. The auxiliary electric fan is temperature controlled and can switch on suddenly.
- Never open the coolant reservoir cap when the engine is still warm. The coolant system is pressurized and hot coolant could spray out.
- Protect your face, hands and arm from steam or hot engine coolant by placing a thick rag over the cap when you open the coolant reservoir.
- Do not remove the engine cover under any circumstances. This increases the risk of burns.
- If work on the fuel system or the electrical system is necessary:
  - Always disconnect the battery.
  - Never smoke or work near heaters or open flames. Fluids in the engine compartment could start a fire.
  - Keep an approved fire extinguisher immediately available.
- To avoid electrical shock and personal injury while the engine is running or being started, never touch:
  - Ignition cables
  - Other components of the high voltage electronic ignition system.
- If you must perform a check or repair with the engine running:
  - First, fully apply the parking brake, move selector lever of automatic trans-

mission to “P” (Park); put manual transmission in Neutral.

- Always use extreme caution to prevent clothing, jewelry, or long hair from getting caught in the radiator fan, V-belts or other moving parts, or from contacting hot parts. Tie back hair before starting, and do not wear clothing that will hang or droop into the engine.
- Minimize exposure to emission and chemical hazards ⇒ .

### **WARNING**

California Proposition 65 Warning:

- Engine exhaust, some of its constituents, and certain vehicle components contain or emit chemicals known to the State of California to cause cancer and birth defects and reproductive harm. In addition, certain fluids contained in vehicles and certain products of component wear contain or emit chemicals known to the State of California to cause cancer and birth defects or other reproductive harm.
- Battery posts, terminals and related accessories contain lead and lead compounds, chemicals known to the State of California to cause cancer and reproductive harms. Wash hands after handling.

### **Note**

When adding fluids, always make sure that they are poured into the proper container or filler opening, otherwise serious damage to vehicle systems will occur.

### **For the sake of the environment**

To detect leaks in time, inspect the vehicle floor pan from underneath regularly. If you see spots from oil or other vehicle fluids, have your vehicle inspected by an authorized Audi dealer.

## Engine compartment

### Engine compartment

These are the most important items that you can check.

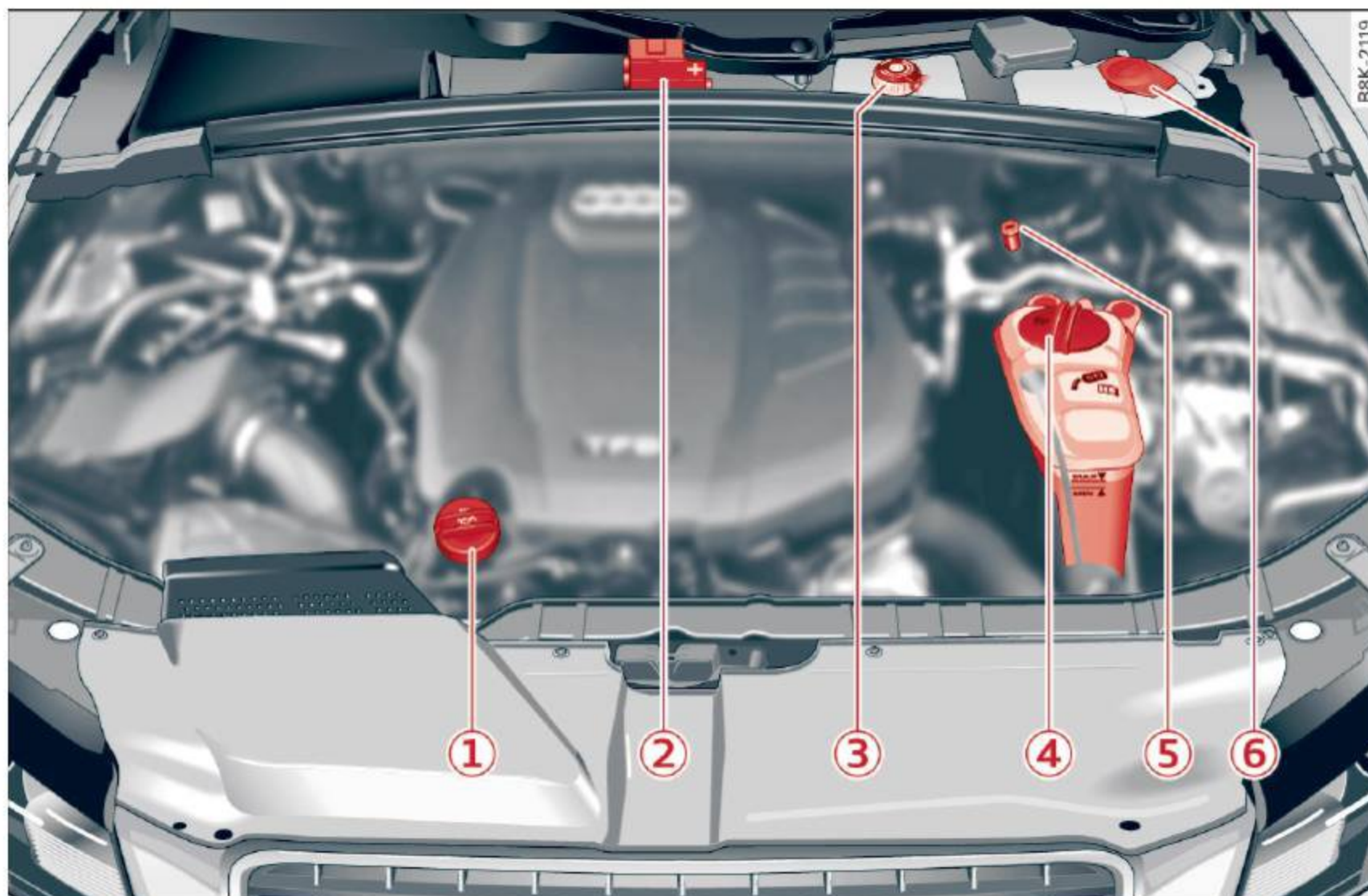



Fig. 182 Typical layout for containers and engine oil filler cap

- ① Engine oil filler cap (🛢️) ..... 216
- ② Jump start point (+) under a cover ..... 224, 275
- ③ Brake fluid reservoir (🚰) ..... 221
- ④ Coolant expansion tank (🌊) ... 219
- ⑤ Jump start point (-) with hex head screw ..... 224, 275
- ⑥ Windshield/headlight\* washer container (🚿) ..... 225

The position of the engine oil filling hole ⇒ *fig. 182* (item ③) can differ depending on the engine design.

#### **WARNING**

Before you check anything in the engine compartment, always read and heed all WARNINGS ⇒  in *Working in the engine compartment* on page 212.

## Engine oil

### Engine oil specifications

The engine oil used must conform to exact specifications.

The service interval display in the instrument cluster of your vehicle will inform you when it is time for an oil change. We recommend that you have your oil changed by an authorized Audi Service Advisor.

If you have to top off the oil between oil changes, use the Audi oil quality standard specified in the table.

	Audi oil quality standard
<b>Gasoline engine</b>	VW 502 00 or VW 504 00

Using the proper engine oil is important for the functionality and service life of the engine. Your engine was factory-filled with a high-quality oil which can usually be used throughout the entire year.

**Note**

Your Limited New Vehicle Warranty does not cover damage or malfunctions due to failure to follow recommended maintenance and use requirements as set forth in the Audi Owner's Manual and Warranty & Maintenance booklet.

- Use only a high quality engine oil that expressly complies with the Audi oil quality standard specified for your vehicle's engine. Using any other oil can cause serious engine damage.
- Do not mix any lubricants or other additives into the engine oil. Doing so can cause engine damage.

**Tips**

If you need to add oil and there is none available that meets the Audi oil quality standard your engine requires, you may add a total of no more than 0.5 quart/liter of a high-quality "synthetic" oil that meets the following specifications.

- Vehicles with gasoline engine: ACEA A3 or API SM with a viscosity grade of SAE 0W-30, SAE 5W-30 or SAE 5W-40.
- For more information about engine oil that has been approved for your vehicle, please contact either your authorized Audi dealer or Audi Customer Relations at 1 (800) 822-2834 or visit our web site at [www.audiusa.com](http://www.audiusa.com) or [www.audicanada.ca](http://www.audicanada.ca).

**Engine oil consumption**

*The engine in your vehicle depends on an adequate amount of oil to lubricate and cool all of its moving parts.*

In order to provide effective lubrication and cooling of internal engine components, all internal combustion engines consume a certain

amount of oil. Oil consumption varies from engine to engine and may change significantly over the life of the engine. Typically, engines with a specified break-in period (see ⇒ *page 193*) consume more oil during the break-in period than they consume after oil consumption has stabilized.

Under normal conditions, the rate of oil consumption depends on the quality and viscosity of the oil, the RPM (revolutions per minute) at which the engine is operated, the ambient temperature and road conditions. Further factors are the amount of oil dilution from water condensation or fuel residue and the oxidation level of the oil. As any engine is subject to wear as mileage builds up, the oil consumption may increase over time until replacement of worn components may become necessary.

With all these variables coming into play, no standard rate of oil consumption can be established or specified. There is no alternative to regular and frequent checking of the oil level, see **Note**.

If the yellow engine oil level warning symbol  in the instrument cluster lights up, you should check the oil level as soon as possible ⇒ *page 216*. Top off the oil at your earliest convenience ⇒ *page 216*.

**WARNING**

Before you check anything in the engine compartment, always read and heed all WARNINGS ⇒  *in Working in the engine compartment on page 212*.

**Note**

Driving with an insufficient oil level is likely to cause severe damage to the engine.

**Tips**

- The oil pressure warning display  is not an indicator of the oil level. Do not rely on it. Instead, check the oil level in your engine at regular intervals, preferably each time you refuel, and always before going on a long trip.

- If you have the impression your engine consumes excessive amounts of oil, we recommend that you consult an authorized Audi dealer to have the cause of your concern properly diagnosed. Keep in mind that the accurate measurement of oil consumption requires great care and may take some time. An authorized Audi dealer has instructions about how to measure oil consumption accurately.

### Checking the engine oil level



Fig. 183 MMI Display: Oil level indicator

#### Read oil level

- ▶ Park your vehicle so that it is horizontally level.
- ▶ Shut the engine off when it is at operating temperature.
- ▶ Switch only the ignition back on.
- ▶ Wait approx. two minutes.
- ▶ Select: Function button **CAR** > **Oil level**. Or
- ▶ Select: Function button **CAR** > **Car systems\*** control button > **Servicing & checks** > **Oil level**.
- ▶ Read the oil level in the MMI\* Display ⇒ *fig. 183*. Add engine oil if the bar of the oil level indicator is near “min” ⇒ *page 216*

Depending on the way the vehicle is driven and the operating conditions, oil consumption can be up to a 1/2 quart per 600 miles (0.5 liter per 1,000 km). Consumption may be higher within the first 3,000 miles (5,000 km).

#### **i** Tips

The oil level indicator in the MMI\* Display is only an information display. If the oil level is too low, a minimum oil warning ap-

pears in the instrument cluster. Add oil ⇒ *page 216*. If the hood has been opened, the current oil level is shown in the instrument cluster the next time the ignition is switched on.

### Adding engine oil



Fig. 184 Engine compartment: Cover on the oil filler neck

- ▶ Before you check anything in the engine compartment, **always read and heed all WARNINGS** ⇒ in *Working in the engine compartment on page 212*.
- ▶ Shut the engine off.
- ▶ Unscrew the cap to the engine oil filling hole ⇒ *fig. 184*, ⇒ *page 214*, *fig. 182*.
- ▶ Carefully top off with 0.5 quarts (0.5 liters) of the appropriate oil ⇒ *page 214*.
- ▶ Check the oil level again after two minutes ⇒ *page 216*, *Checking the engine oil level*.
- ▶ Top off the oil again, if necessary.
- ▶ Screw the cap back on the filling hole.

#### WARNING

- While topping off, the oil must not come in contact with hot engine parts - fire hazard!
- The oil filler cap must be properly secured to prevent oil from being sprayed on the hot engine and exhaust system when the engine is running - fire hazard!
- If your skin has come in contact with the engine oil, you must subsequently cleanse it thoroughly.

#### Note

- Check the oil level using the radio or MMI\*. If the message **Please reduce oil**

**level** appears, contact your authorized Audi dealer or qualified workshop to have excess oil extracted if necessary.

- **Audi does not recommend the use of oil additives. They may damage the engine and adversely affect your New Vehicle Warranty.**



**For the sake of the environment**

- Under no circumstances can the oil come in contact with the sewage network or the soil.
- Observe and follow legal regulations when disposing of empty oil containers.

**Changing the engine oil**

*We recommend that have your oil changed by an authorized Audi dealer or a qualified service station.*

Before you check anything in the engine compartment, **always read and heed all WARNINGS** ⇒ in *Working in the engine compartment on page 212.*

The engine oil must be changed according to the intervals specified in your Warranty & Maintenance booklet. This is very important because the lubricating properties of oil diminish gradually during normal vehicle use.

Under some circumstances the engine oil should be changed more frequently. Change oil more often if you drive mostly short distances, operate the vehicle in dusty areas or under predominantly stop-and-go traffic conditions, or have your vehicle where temperatures remain below freezing for extended periods.

Detergent additives in the oil will make fresh oil look dark after the engine has been running for a short time. This is normal and is not a reason to change the oil more often than recommended.

Because of the problem of proper disposal, along with the special tools and necessary expertise required, we strongly recommend that

you have your oil changed by an authorized **Audi dealer** or a qualified service station.

**If you choose to change your oil yourself,** please note the following important information:



**WARNING**

To reduce the risk of personal injury if you must change the engine oil in your vehicle yourself:

- Wear eye protection.
- To reduce the risk of burns from hot engine oil, let the engine cool down to the touch.
- When removing the oil drain plug with your fingers, stay as far away as possible. Always keep your forearm parallel to the ground to help prevent hot oil from running down your arm.
- Drain the oil into a container designed for this purpose, one large enough to hold at least the total amount of oil in your engine.
- Engine oil is poisonous. Keep it well out of the reach of children.
- Continuous contact with used engine oil is harmful to your skin. Always protect your skin by washing oil off thoroughly with soap and water.



**Note**

Never mix oil additives with your engine oil. These additives can damage your engine and adversely affect your Audi Limited New Vehicle Warranty.



**For the sake of the environment**

- Before changing your oil, first make sure you know where you can properly dispose of the used oil.
- Always dispose of used engine oil properly. Do not dump it on garden soil, wooded areas, into open streams or down sewage drains.
- Recycle used engine oil by taking it to a used engine oil collection facility in your area, or contact a service station.

## Engine cooling system

### Coolant

*The engine coolant performs two functions: it keeps the engine from overheating and it protects the engine from freezing in the winter.*

The cooling system is sealed and generally requires little attention.

The cooling system has been filled at the factory with a permanent coolant which does not need to be changed. The coolant consists of a mixture of specially conditioned water and the manufacturer's glycol-based coolant additive G13 antifreeze with anticorrosion additives (50% for USA models; 60% for Canadian models). This mixture both assures the necessary frost protection and protects metal components in the engine's cooling system from corrosion and scaling. It also raises the boiling point of the coolant.

Do not reduce the concentration of the coolant in the summer by adding plain water. **The proportion of coolant additive must be at least 50% but not more than 60%** to maintain antifreeze protection and cooling efficiency. If the coolant frost protection is too low, the coolant could freeze and damage the vehicle heating and engine cooling system.

For year-round driving, antifreeze is added at the factory for temperatures down to:

- - 31 °F ( - 35 °C) USA
- - 40 °F ( - 40 °C) Canada.

If you must add coolant, use a mixture of water and coolant additive. Mixing the coolant additive with distilled water is recommended.

#### **WARNING**

Before you check anything in the engine compartment, always read and heed all **WARNINGS** ⇒  *in Working in the engine compartment on page 212.*

#### **Note**

- Before winter sets in, have the coolant checked to see if the coolant additive in

your vehicle is sufficient to meet the climate conditions. This is especially important if you live in a region where the winter is extremely cold. If necessary, increase the proportion of coolant additive to 60%.

- When adding coolant additive to your cooling system, remember:
  - We recommend using only coolant additive G12++ or G13 for your vehicle. This coolant additive is available at authorized Audi dealers. Other types of antifreeze can significantly reduce corrosion protection. The resulting corrosion can cause a loss of coolant and serious engine damage.
  - Do not add any type of radiator leak sealant to your vehicle's engine coolant. Adding radiator repair fluid may adversely affect the function and performance of your cooling system and could result in damage not covered by your New Vehicle Limited Warranty.

### Checking the engine coolant level

*The engine coolant level can be checked with a quick glance.*



**Fig. 185** Engine compartment: Cover on the coolant expansion tank

- ▶ Before you check anything in the engine compartment, **always read and heed all WARNINGS** ⇒  *in Working in the engine compartment on page 212.*
- ▶ Park your vehicle on a level surface.
- ▶ Turn off the ignition.
- ▶ Read the engine coolant level from the coolant expansion tank ⇒ *fig. 185, ⇒ page 214, fig. 182.* With a cold engine, the coolant

level should be between the “MIN” and “MAX” markings. When the engine is warm, the level may be slightly above the “MAX” marking.

The location of the coolant expansion tank can be seen in the engine compartment illustration ⇒ *page 214*.

To obtain an accurate reading, the engine must be switched off.

The expansion tank in your vehicle is equipped with an electric coolant level sensor.

When the coolant level is too low, the warning light in the Auto-Check System ⇒ *page 17* will blink until you add coolant and the level has been restored to normal. Even though there is an electric coolant level sensor, we still recommend you check the coolant level from time to time.

### Coolant loss

Coolant loss may indicate a **leak** in the cooling system. In the event of coolant loss, the cooling system should be inspected immediately by your authorized Audi dealer. It is not enough merely to add coolant.

In a **sealed** system, losses can occur only if the boiling point of the coolant is exceeded as a result of overheating.

### WARNING

The cooling system is under pressure and can get very hot. Reduce the risk of scalding from hot coolant by following these steps.

- Turn off the engine and allow it to cool down.
- Protect your face, hands and arms from escaping fluid and steam by covering the cap with a large, thick rag.
- Turn the cap slowly and very carefully in a counter-clockwise direction while applying light, downward pressure on the top of the cap.
- To avoid being burned, do not spill anti-freeze or coolant on the exhaust system

or hot engine parts. Under certain conditions, the ethylene glycol in engine coolant can catch fire.

### Note

Do not add any type of radiator leak sealant to your vehicle's engine coolant. Adding radiator repair fluid may adversely affect the function and performance of your cooling system and could result in damage not covered by your New Vehicle Limited Warranty.

### Adding coolant

*Be very careful when adding engine coolant.*

Before you check anything in the engine compartment, **always read and heed all WARNINGS** ⇒  *in Working in the engine compartment on page 212*.

Requirement: There must be a residual amount of coolant in the expansion tank ⇒ .

- ▶ Turn off the engine.
- ▶ Let the engine cool down.
- ▶ Place a thick rag over the coolant expansion tank ⇒ *page 218, fig. 185* and **carefully** turn the cap counter-clockwise ⇒ .
- ▶ Add coolant mixed in the correct ratio ⇒ *page 218, Coolant* up to the MAX marking.
- ▶ Make sure that the fluid level remains stable. Add more coolant if necessary.
- ▶ Twist the cap on again *tightly*.

Replacement engine coolant must conform to exact specifications ⇒ *page 218, Coolant*.

We recommend using only coolant additive G12++, G13 or in an emergency G12+. Do **not** use a different additive. In an emergency use plain water until you can get the correct additive and can restore the correct ratio. This should be done as soon as possible.

If you have lost a considerable amount of coolant, then you should add cold antifreeze and cold water only when the engine is cold.

Always use *new* engine coolant when refilling. ▶

Do not fill coolant above the “MAX” mark. Excess coolant will be forced out through the pressure relief valve in the cap when the engine becomes hot.

### **WARNING**

- The cooling system is under pressure and can get very hot. Reduce the risk of scalding from hot coolant by following these steps.
- Turn off the engine and allow it to cool down.
- Protect your face, hands and arms from escaping fluid and steam by covering the cap with a large, thick rag.
- Turn the cap slowly and very carefully in a counter-clockwise direction while applying light, downward pressure on the top of the cap.
- To avoid being burned, do not spill antifreeze or coolant on the exhaust system or hot engine parts. Under certain conditions, the ethylene glycol in engine coolant can catch fire.
- Antifreeze is poisonous. Always store antifreeze in its original container and well out of the reach of children.
- If you drain the coolant, it must be caught and safely stored in a proper container clearly marked “poison”.

### **Note**

- Do not add coolant if the expansion tank is empty. Air could enter the cooling system and damage the engine. If this is the case, do not continue driving. Seek professional assistance.
- Coolant pollutes the environment and could cause an engine fire. Excess coolant will be forced out through the pressure relief valve in the cap when the engine becomes hot.
- If, in an emergency, only water can be added, the correct ratio between water and antifreeze ⇒ *page 218* must be restored as soon as possible.



### **For the sake of the environment**

Drained coolant should not be reused. Always dispose of used coolant while observing all environmental regulations.

### **Radiator fan**

*The radiator fan switches on automatically by itself.*

The radiator fan is driven by the engine via the V-belt. The viscous clutch regulates the speed of the fan according to the temperature of the coolant.

An auxiliary electric radiator fan\* switches on and off depending on coolant temperature and other vehicle operating conditions.

After you switch the engine off, the auxiliary fan can continue running for up to 10 minutes - even with the ignition off. It can even switch on again later by itself ⇒ , if

- the temperature of the engine coolant rises due to the heat build-up from the engine in the engine compartment, or
- the engine compartment heats up because the vehicle is parked in intense sunlight.



### **WARNING**

- To reduce the risk of personal injury never touch the radiator fan.
- The auxiliary electric fan is temperature controlled and can switch on suddenly even when the engine is not running.
- The auxiliary radiator fan switches on automatically when the engine coolant reaches a certain temperature and will continue to run until the coolant temperature drops.

## Brake fluid

### Checking brake fluid level

The brake fluid level can be checked with a quick glance.



**Fig. 186** Engine compartment: Cover on the brake fluid reservoir

Before you check anything in the engine compartment, **always read and heed all WARNINGS** ⇒ in *Working in the engine compartment* on page 212.

- ▶ Read the brake fluid level from the brake fluid reservoir ⇒ *fig. 186*, ⇒ *page 214*, *fig. 182*. The brake fluid level must be between the “MIN” and “MAX” markings.

The brake fluid reservoir is located at the rear partition of the engine compartment on the left side ⇒ *page 214*.

The fluid level may drop *slightly* after some time due to the automatic adjustment of the brake pads. This is not cause for alarm.

If the brake fluid level falls *considerably* below the “MIN” mark, the brake warning/indicator light (U.S. models: **BRAKE**, Canadian models: ) will come on ⇒ *page 15*. Do not continue to operate the vehicle. The complete brake system should be thoroughly checked by an authorized Audi dealer or qualified workshop and the cause corrected. If the brake fluid level is too low, the brake warning/indicator light will illuminate. Contact an authorized Audi dealer **immediately**.

### Tips

The brake fluid reservoir is located underneath the cover.

### Changing brake fluid

Have the brake fluid changed by an experienced technician.

Brake fluid absorbs moisture from the air. If the water content in the brake fluid is too high, corrosion in the brake system may result after a period of time. The boiling point of the brake fluid will also decrease considerably and decrease braking performance.

Therefore, the brake fluid must be changed **every two years**. Always use new brake fluid which conforms to Federal Motor Vehicle Standard “FMVSS 116 DOT 4”.

The brake fluid reservoir can be difficult to reach, therefore, we recommend that you have the brake fluid changed by your authorized **Audi dealer**. Your dealer has the correct tools, the right brake fluid and the know-how to do this for you.

### WARNING

- Brake fluid is poisonous. It must be stored only in the closed original container out of the reach of children!
- Brake failure can result from old or inappropriate brake fluid. Observe these precautions:
  - Use only brake fluid that meets SAE specification J 1703 and conforms to Federal Motor Vehicle Standard 116. Always check with your authorized Audi dealer to make sure you are using the correct brake fluid. The correct type of brake fluid is also indicated on the brake fluid reservoir.
  - The brake fluid must be new. Heavy use of the brakes can cause a vapor lock if the brake fluid is left in the system too long. This can seriously affect the efficiency of the brakes as well as your safety. This could result in an accident.

### Note

Brake fluid will damage the paint of your vehicle.

**For the sake of the environment**

Because of the problem of proper disposal of brake fluid as well as the special tools required and the necessary expertise, we recommend that you have the brake fluid changed by your authorized Audi dealer.

## Battery

### General information

Under **normal** operating conditions, the battery in your Audi does not need any maintenance. With *high* outside temperatures or long daily drives we recommend that you have the electrolyte level checked by an authorized Audi dealer or qualified workshop. The electrolyte level should also be checked each time the battery is charged ⇒ *page 224*.

Have the battery checked when you take your vehicle in for service. You are well advised to replace a battery that is older than 5 years.

With certain types of airbag deployment, the battery is disconnected from the vehicle electrical system for safety reasons ⇒  in *Repair, care and disposal of the airbags on page 157*.

### Disconnecting the battery terminals

Some vehicle functions (power window regulators, for example) are lost if the battery terminals are disconnected. These functions have to be relearned after the battery terminals are connected again. To prevent this, the battery should only be disconnected from the vehicle electrical system when absolutely necessary for repairs.

### Vehicles not driven for long periods

If you do not drive your vehicle over a period of several days or weeks, electrical components are gradually cut back or switched off. This reduces energy consumption and maintains starting capability over a longer period ⇒ *page 191*.

Some of the convenience functions may not operate, such as the interior lights or the

power seat adjustment. The convenience functions will be available again when you turn on the ignition and start the engine.

### Winter operation

During the winter months, battery capacity tends to decrease as temperatures drop. This is because more power is also consumed while starting, and the headlights, rear window defogger, etc., are used more often.

Avoid unnecessary power consumption, particularly in city traffic or when traveling only short distances. Let your authorized Audi dealer check the capacity of the vehicle battery before winter sets in ⇒ *page 224*. A well charged battery will not only prevent starting problems when the weather is cold, but will also last longer.



### Tips

If your vehicle is left standing for several weeks at extremely low temperatures, the vehicle battery should be removed and stored where it will not freeze. This will prevent it from being damaged and having to be replaced.

### Working on the battery

*Be especially careful when working on or near the battery.*

The battery is located in the luggage compartment under the floor. Before you check anything in the luggage compartment, **read and heed all WARNINGS** ⇒ .





Always heed the **safety warnings**, when working on the vehicle battery or the vehicle electrical system to prevent injury.

**The following WARNINGS are very important when working on the battery:**

**Always heed the following WARNING SYMBOLS and safety precautions when working on the battery.**



**Always wear eye protection.**

	<b>Battery acid contains sulfuric acid. Always wear gloves and eye protection.</b>
	<b>No</b> - sparks - flames - smoking.
	<b>When a battery is charged, it produces hydrogen gas which is explosive and could cause personal injury.</b>
	<b>Always keep the battery well out of reach of children.</b>

 **WARNING**

- Whenever working on the battery or on the electrical system, there is the risk of injury, accident and even fire. Read and heed the following WARNINGS:
- Always wear eye protection. Do not let battery acid or any lead particles get on your skin or clothing. Shield your eyes. Explosive gases can cause blindness or other injury.
  - Battery acid contains sulfuric acid. Sulfuric acid can cause blindness and severe burns.
  - Always wear gloves and eye protection. Do not tilt the battery because acid could leak out of the ventilation openings.
  - If you get battery acid in your eyes or on your skin, immediately rinse with cold water for several minutes and get medical attention.
  - If you should ingest any battery acid, seek medical attention immediately.
  - Do not expose the battery to an open flame, electric sparks or an open light.
  - Do not smoke.
  - Do not interchange the positive and negative cables.
  - When working on the battery, be sure not to short-circuit the terminals with tools or other metal objects. This would cause the battery to heat up very quickly, which could lead to damage or explosion and personal injury.

- When a battery is charged, it produces hydrogen gas which is explosive and could cause personal injury.
- Always keep the battery well out of the reach of children.
- Before work is done on the electrical system, disconnect the negative ground cable.
- Before performing any work on the electrical system, switch off the engine and ignition as well as any electrical equipment. The negative cable on the battery must be disconnected. If you are just going to replace a light bulb, then it is enough to switch off the lights.
- Before disconnecting the battery, switch off the anti-theft alarm system! Otherwise you will set off the alarm.
- When disconnecting the battery, first disconnect the negative cable and then the positive cable.
- Before reconnecting the battery, make sure all electrical consumers are switched off. Reconnect the positive cable first and then the negative cable. Never interchange the cables - this could start a fire!
- Never charge a frozen or a thawed-out battery. It could explode! If a battery has frozen, then it must be replaced. A discharged battery can freeze over at 32°F (0°C).
- Make sure the vent hose is always attached to the opening on the side of the battery.
- Never use batteries which are damaged. There is the danger of an explosion! Always replace a damaged battery.

 **WARNING**

- California Proposition 65 Warning:
- Battery posts, terminals and related accessories contain lead and lead compounds, chemicals known to the State of California to cause cancer and reproductive problems. Wash hands after handling.

**! Note**

- Do not disconnect the vehicle battery when the ignition is switched on or when the engine is running, otherwise, you will damage electronic components in the electrical system.
- If your vehicle is going to stand for a long period of time without being driven, protect the battery from “freezing”, otherwise it will be damaged and will then have to be replaced.

**Battery charging**

Starting the engine requires a well charged battery.

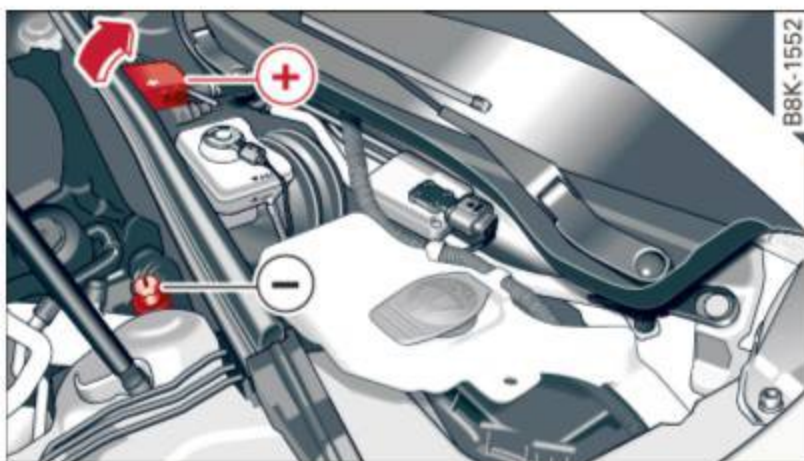

Fig. 187 Engine compartment: Connectors for charger and jumper cables

**Always read and heed all WARNINGS** below ⇒ **!** and ⇒ **!** in *Working on the battery* on page 223.

- ▶ Turn off the ignition and all electrical consumers.
- ▶ Make sure the area is well ventilated when you charge the battery.
- ▶ Open the engine hood ⇒ page 212.
- ▶ Open the cover on the positive pole ⇒ fig. 187.
- ▶ Connect the charger connectors according to the instructions to the **jump start bolts**. (Bolts under the cover = “positive”, Bolts with hex head = “negative”).
- ▶ Only now plug the mains lead for the charging equipment into the wall outlet and turn it on ⇒ **!**.
- ▶ **Make sure the charging rate is not over 30 amps/14.8 Volt.**

- ▶ When the battery is fully charged: Turn the charging equipment off and remove the mains lead from the wall outlet.
- ▶ Now remove the clamps for the charging equipment.
- ▶ Close the cover on the positive pole.
- ▶ Close the hood ⇒ page 212.

A discharged battery can **freeze** at temperatures of only 32 °F (0 °C). Allow a frozen battery to thaw completely before attempting to charge it ⇒ **!**. However, we recommend not using a thawed battery again because the battery casing can be cracked due to ice formation and can leak battery acid.

**Battery charging (Maximum charging rate of 30 amps/14.8 Volt)**

When charging at *low* voltages (e.g. with a **trickle charger**), the battery cables do not have to be disconnected first. The battery caps should *not* be opened when charging a battery.

It is not necessary to remove the battery from the luggage compartment.

**Fast charging the battery (charging rate above 14.8 Volts)**

For technical reasons do not use a battery charger that uses voltage greater than 14.8 Volts to charge your vehicle's battery.

**! WARNING**

- Charging a battery can be dangerous.
- Always follow the operating instructions provided by the battery charger manufacturer when charging your battery.
  - Never charge a frozen battery. It may explode because of gas trapped in the ice. Allow a frozen battery to thaw out first.
  - Do not reuse batteries which were frozen. The battery housing may have cracked and weakened when the battery froze.
  - Charge the battery in a well ventilated area. Keep away from open flame or electrical spark. Do not smoke. Hydrogen gas generated by the battery is explosive.

- To reduce the danger of explosion, never connect or disconnect charger cables while the charger is operating.
- Fast charging a battery is dangerous and should only be attempted by a competent technician with the proper equipment.
- Battery acid that may spill during charging should be washed off with a solution of warm water and baking soda to neutralize the acid.

### ! Note

Never use a fast charger as a booster to start the engine. This will seriously damage sensitive electronic components, such as control units, relays, radio, etc., as well as the battery charger.

## Battery replacement

*The new battery must have the same specifications and dimensions as the original equipment battery.*

Intelligent energy management in your vehicle is responsible for distributing the electrical energy throughout your vehicle ⇒ *page 191*. The intelligent energy management system will keep the engine battery charged better than vehicles without this system. To make sure the additional electrical energy is available once again after you have changed the battery, we recommend that you install batteries of the same type and manufacture only (the same as those installed at the time your vehicle was delivered). Specifications are listed on the battery housing. Your authorized Audi dealer must code the battery in the energy management system to enable you to use the energy management functions correctly after replacing the battery.

If it is not possible to use a battery of this type, the new battery must have the same capacity, voltage (12-volts), amperage, construction and plug sealing.

When installing the battery, make sure the ignition and all electrical consumers are turned off.

### ! Note

Make sure the ventilation hose on the side of the battery is connected, otherwise fumes or battery acid can leak out.

### 🌳 For the sake of the environment

Because of the problem of proper disposal of a battery, we recommend your authorized Audi dealer change the battery for you. Batteries contain sulfuric acid and lead and must always be disposed of properly in compliance with all environmental regulations. Disposing of vehicle batteries improperly is very dangerous to the environment.

## Windshield/headlight\* washer container



**Fig. 188** Engine compartment: Cover on the windshield and headlight\* washer fluid container

The washer fluid container is marked with the symbol  on its cap ⇒ *fig. 188*, ⇒ *page 214*, *fig. 182*.

- ▶ Before you check anything in the engine compartment, **always read and heed all WARNINGS** ⇒  in *Working in the engine compartment on page 212*.
- ▶ Lift the filler cap tongue to add washer fluid. You can fill the container to the top.
- ▶ Press the cap back onto the filler neck after filling the container.

You can find the reservoir **capacity** in the table in ⇒ *page 281*. ▶

Clean water should be used when filling up. If possible, use soft water to prevent scaling on the washer jets. Always add a glass cleaner solution (with frost protection in the winter).



### Note

Do not mix engine coolant antifreeze or any other additives to fill up the windshield washer reservoir.

## Tires and wheels

### Tires

#### General notes

*Tires may be the least appreciated and most abused parts of a motor vehicle.*

Tires may be the least appreciated and most abused parts of a motor vehicle. Tires are, however, one of the most important parts of a vehicle, particularly considering the comparatively small patch of rubber on each tire that assures that all-important contact between you, your vehicle and the road.

Maintaining the correct tire pressure, making sure that your vehicle and its tires do not have to carry more weight than they can safely handle, avoiding damage from road hazards and regularly inspecting tires for damage including cuts, slashes irregular wear and overall condition are the most important things that you can do to help avoid sudden tire failure including tread separation and blow-outs.

### Avoiding damage

If you have to drive over a curb or similar obstacle, drive very slowly and as close as possible at a right angle to the curb.

Always keep chemicals including grease, oil, gasoline and brake fluid off the tires.

Inspect the tires regularly for damage (cuts, cracks or blisters, etc.). Remove any foreign bodies embedded in the treads.

### Storing tires

Mark tires when you remove them to indicate the direction of rotation. This ensures you to be able to mount them correctly when you reinstall them.

When removed, the wheels or tires should be stored in a cool, dry and preferably dark place.

Store tires in a vertical position if they are not mounted on rims, in a horizontal position if they are mounted on rims.

### New tires

New tires have to be broken in ⇒ ⚠.

The tread depth of new tires may vary, according to the type ▶

and make of tire and the tread pattern.

### Hidden damage

Damage to tires and rims is often not readily visible. If you notice unusual vibration or the vehicle pulls to one side, this may indicate that one of the tires has been damaged. The tires must be checked immediately by an authorized Audi dealer or qualified workshop.

### Unidirectional tires

A unidirectional tire can be identified by arrows on the sidewall, that point in the direction the tire is designed to rotate. You must follow the specified direction of rotation. This is necessary so that these tires can develop their optimum characteristics regarding grip, road noise, wear and hydroplaning resistance. For more information ⇒ *page 267*.



#### WARNING

New tires or tires that are old, worn or damaged cannot provide maximum control and braking ability.

–New tires tend to be slippery and must also be broken-in. To reduce the risk of losing control, a collision and serious personal injuries, drive with special care for the first 350 miles (560 km).

–Driving with worn or damaged tires can lead to loss of control, sudden tire failure, including a blowout and sudden deflation, crashes and serious personal injuries. Have worn or damaged tires replaced immediately.

–Tires age even if they are not being used and can fail suddenly, especially at high speeds. Tires that are more than 6 years old can only be used in an emergency and then with special care and at low speed.

–Never mount used tires on your vehicle if you are not sure of their “previous history.” Old used tires may have been damaged even though the damage cannot be seen that can lead to sudden tire failure and loss of vehicle control.

–If you notice unusual vibration or if the vehicle pulls to one side when driving, always stop as soon as it is safe to do so and check the wheels and tires for damage.

**!** Note

–Please note that summer and winter tires are designed for the conditions that are typical in those seasons. Audi recommends using winter tires during the winter months. Low temperatures significantly decrease the elasticity of summer tires, which affects traction and braking ability.

If summer tires are used in very cold temperatures, cracks can form on the tread bars, resulting in permanent tire damage that can cause loud driving noise and unbalanced tires. Audi is not responsible for this type of damage.

–Burnished, polished or chromed rims must not be used in winter road conditions. The surface of the rims does not have sufficient corrosion protection for this and could be permanently damaged by road salt or similar substances.

## Glossary of tire and loading terminology

### Accessory weight

means the combined weight (in excess of those standard items which may be replaced) of automatic transmission, power steering, power brakes, power windows, power seats, radio, and heater, to the extent that these items are available as factory-installed equipment (whether installed or not).

### Aspect ratio

means the ratio of the height to the width of the tire in percent. Numbers of 55 or lower indicate a low sidewall for improved steering response and better overall handling on dry pavement.

**Bead**

means the part of the tire that is made of steel wires, wrapped or reinforced by ply cords and that is shaped to fit the rim.

**Bead separation**

means a breakdown of the bond between components in the bead.

**Cord**

means the strands forming the plies in the tire.

**Cold tire inflation pressure**

means the tire pressure recommended by the vehicle manufacturer for a tire of a designated size that has not been driven for more than a couple of miles (kilometers) at low speeds in the three hour period before the tire pressure is measured or adjusted.

**Curb weight**

means the weight of a motor vehicle with standard equipment including the maximum capacity of fuel, oil, and coolant, air conditioning and additional weight of optional equipment.

**Extra load tire**

means a tire design to operate at higher loads and at higher inflation pressures than the corresponding standard tire. Extra load tires may be identified as “XL”, “xl”, “EXTRA LOAD”, or “RF” on the sidewall.

**Gross Axle Weight Rating (“GAWR”)**

means the load-carrying capacity of a single axle system, measured at the tire-ground interfaces.

**Gross Vehicle Weight Rating (“GVWR”)**

means the maximum total loaded weight of the vehicle.

**Groove**

means the space between two adjacent tread ribs.

**Load rating (code)**

means the maximum load that a tire is rated to carry for a given inflation pressure. You may not find this information on all tires because it is not required by law. ▶

**Maximum load rating**

means the load rating for a tire at the maximum permissible inflation pressure for that tire.

**Maximum loaded vehicle weight**

means the sum of:

- (a) Curb weight
- (b) Accessory weight
- (c) Vehicle capacity weight, and
- (d) Production options weight

**Maximum (permissible) inflation pressure**

means the maximum cold inflation pressure to which a tire may be inflated. Also called “maximum inflation pressure.”

**Normal occupant weight**

means 150 lbs. (68 kilograms) times the number of occupants seated in the vehicle up to the total seating capacity of your vehicle.

**Occupant distribution**

means distribution of occupants in a vehicle.

**Outer diameter**

means the overall diameter of an inflated new tire.

**Overall width**

means the linear distance between the exteriors of the sidewalls of an inflated tire, including elevations due to labeling, decorations, or protective bands or ribs.

**Ply**

means a layer of rubber-coated parallel cords.

**Production options weight**

means the combined weight of those installed regular production options weighing over 5 lbs. (2.3 kg) in excess of those standard items which they replace, not previously considered in curb weight or accessory weight, including heavy duty brakes, ride levelers, roof rack, heavy duty battery, and special trim.

**Radial ply tire**

means a pneumatic tire in which the ply cords that extend to the beads are laid at substantially 90 degrees to the centerline of the tread. ▶

**Recommended inflation pressure**

see ⇒ *page 230, Cold tire inflation pressure.*

**Reinforced tire**

means a tire design to operate at higher loads and at higher inflation pressures than the corresponding standard tire. Reinforced tires may be identified as “XL”, “xl”, “EXTRA LOAD”, or “RF” on the sidewall.

**Rim**

means a metal support for a tire or a tire and tube assembly upon which the tire beads are seated.

**Rim diameter**

means nominal diameter of the bead seat. If you change your wheel size, you will have to purchase new tires to match the new rim diameter.

**Rim size designation**

means rim diameter and width.

**Rim width**

means nominal distance between rim flanges.

**Sidewall**

means that portion of a tire between the tread and bead.

**Speed rating (letter code)**

means the speed at which a tire is designed to be driven for extended periods of time. The ratings range from 93 mph (150 km/h) to 186 mph (298 km/h) ⇒ *page 250*. You may not find this information on all tires because it is not required by law.

The speed rating letter code, where applicable, is molded on the tire sidewall and indicates the maximum permissible road speeds ⇒ *▲ in Winter tires on page 255.*

**Tire pressure monitoring system\***

means a system that detects when one or more of a vehicle's tires are underinflated and illuminates a low tire pressure warning telltale.

**Tread**

means that portion of a tire that comes into contact with the road. ▶

## Tread separation

means pulling away of the tread from the tire carcass.

## Treadwear indicators (TWI)

means the projections within the principal grooves designed to give a visual indication of the degrees of wear of the tread. See ⇒ *page 245, Tread Wear Indicator (TWI)* for more information on measuring tire wear.

## Uniform Tire Quality Grading

is a tire information system developed by the United States National Highway Traffic Safety Administration (NHTSA) that is designed to help buyers make relative comparisons among tires. The UTQG is not a safety rating and not a guarantee that a tire will last for a prescribed number of miles (kilometers) or perform in a certain way. It simply gives tire buyers additional information to combine with other considerations, such as price, brand loyalty and dealer recommendations. Under UTQG, tires are graded by the tire manufacturers in three areas: treadwear, traction, and temperature resistance. The

UTQG information on the tires, molded into the sidewalls.

## U.S. DOT Tire Identification Number (TIN)

This is the tire's "serial number". It begins with the letters "DOT" and indicates that the tire meets all federal standards. The next two numbers or letters indicate the plant where it was manufactured, and the last four numbers represent the week and year of manufacture. For example,

### DOT ... 2214 ...

means that the tire was produced in the 22nd week of 2014. The other numbers are marketing codes that may or may not be used by the tire manufacturer. This information is used to contact consumers if a tire defect requires a recall.

## Vehicle capacity weight

means the rated cargo and luggage load plus 150 lbs. (68 kilograms) times the vehicle's total seating capacity as listed on the label located on the driver's side B-pillar. ▶

### Vehicle maximum load on the tire

means that load on an individual tire that is determined by distributing to each axle its share of the maximum loaded vehicle weight and dividing by two.

### Vehicle normal load on the tire

means that load on an individual tire that is determined by

distributing to each axle its share of the curb weight, accessory weight, and normal occupant weight (distributed in accordance with table below ⇒ page 234) and dividing by two.

### Occupant loading and distribution for vehicle normal load for various designated seating capacities

Designated seating capacity, number of occupants	Vehicle normal load, number of occupants	Occupant distribution in a normally loaded vehicle
5	3	2 in front, 1 in back seat

### Cold tire inflation pressure

Tire pressure affects the overall handling, performance and safety of a vehicle.

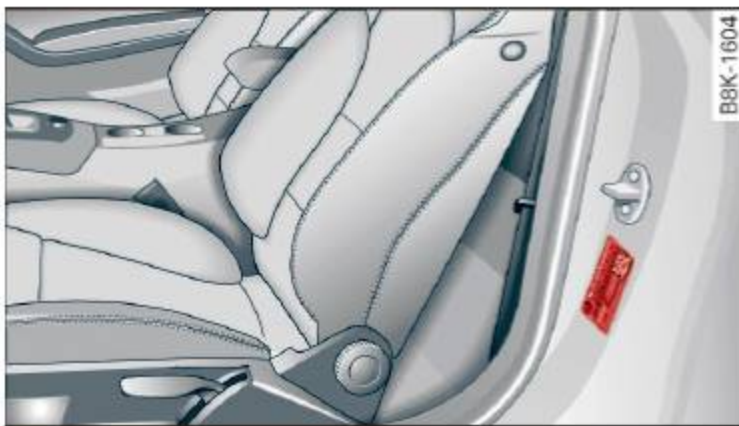

Fig. 189 Tire pressure label: located on driver's side B-pillar

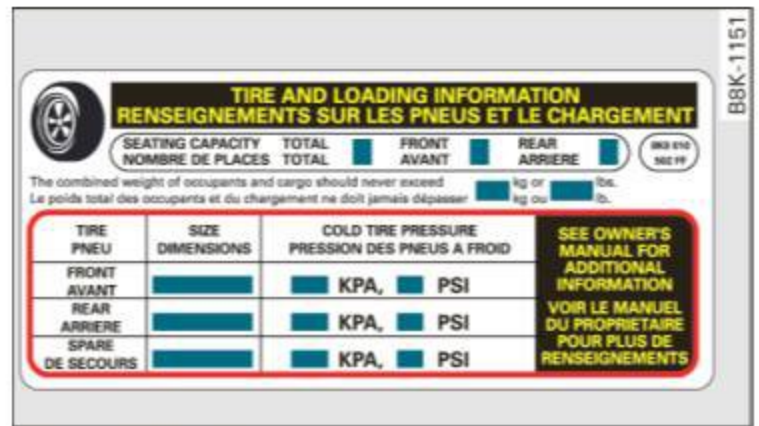

Fig. 190 Tire pressure label

Tire pressure generally refers to the amount of air in a tire that it needs it to do its job and safely carry the combined load of the entire vehicle and its contents. Tire pressure is measured in kilopascals (kPa), the international measuring unit and in pounds per square inch (PSI). Tire pressure is based in part on the vehicle's design and load limit – the greatest amount of weight that the vehicle can carry safely and the tire size. The proper tire pressure is frequently referred to as the “recommended cold tire inflation pressure.” Air in the tires expands when the tire heats up because of internal friction when it flexes in use. The tire pressure is higher when the tire has warmed up than when it is “cold.” It is the inflation pressure in a “cold” tire that counts. Therefore, you should never let air out of a warm tire to match “cold tire inflation pressure” recommendations. The tires would then be underinflated and could fail suddenly.

Maintaining proper tire pressure is one of the most impor-

tant things you can do to help avoid sudden tire failure. Underinflated tires are a major cause of sudden tire failure. Keeping tires at the right pressure is also important for safe and responsive vehicle handling, traction, braking and load carrying. **Tire pressures are particularly important when the vehicle is being driven at higher speeds, and then especially when heavily loaded even within the permissible load-carrying capacities approved for your vehicle.**

The recommended tire pressures for your Audi depend on the kind of tires on your vehicle and the number of passengers and/or amount of luggage you will be transporting.

The tire pressure label is located on the driver's side B-pillar. The tire pressure label lists the recommended cold tire inflation pressures for the vehicle at its maximum capacity weight and tires that were on your vehicle at the time it was manufactured.

**If you wish to improve comfort when operating the vehicle at normal load (up to 3 occupants), you can adjust tire pressures to those specified for normal vehicle load. Before operating the vehicle at maximum load, you must increase the tire pressures to those specified for maximum vehicle load** ⇒ ⚠.

Bear in mind that the tire pressure monitoring system\* can only monitor the tire pressures you have stored. The system does not recognize the load condition of your vehicle.

The effectiveness of the tire pressure monitoring system\* will be impaired if you store normal load pressures but then operate the vehicle at its maximum load ⇒ ⚠.

See the illustration ⇒ *fig. 189* for the location of the label on driver's side B-pillar (color of the actual label and exact location on the vehicle will vary slightly).

Note that the following table is accurate at the time of going to press and is subject to change. In the event of discrepancies, the tire pressure label is located on the driver's side B-pillar always takes precedence.

The table below lists the recommended cold tire inflation pressures for the Audi model covered by your Owner's Literature at the vehicle's capacity weight and the tire sizes installed on the respective models as original equipment, or as a factory option. ▶

Model Engine	Tire designation	Tire pressure							
		normal load condition (up to 3 occupants)				full load condition			
		front		rear		front		rear	
		PSI	kPA	PSI	kPA	PSI	kPA	PSI	kPA
A4 Sedan: 2.0 liter 4-cylinder	225/55 R16 95H All Season	32	220	29	200	33	230	35	240
	245/45 R17 95H All Season	32	220	29	200	33	230	35	240
	245/40 R18 93Y High Performance	32	220	29	200	33	230	35	240
	225/50 R17 94H All Season	33	230	30	210	35	240	36	250
	245/40 R18 93H All Season	33	230	32	220	36	250	38	260
	255/35 R19 96Y XL High Performance	32	220	30	210	35	240	35	240
allroad: 2.0 liter 4-cylinder	225/55 R17 97H All Season	30	210	30	210	33	230	36	250
	245/45 R18 100H All Season	32	220	32	220	33	230	36	250
	245/45 R18 96Y High Performance	30	210	30	210	33	230	36	250
	245/40 R19 98Y XL High Performance	32	220	29	200	35	240	38	260
S4 Sedan: 3.0 liter 6-cylinder	245/40 R18 93H All Season	36	250	32	220	41	280	41	280
	245/40 R18 93Y High Performance	39	270	35	240	41	280	41	280
	255/35 R19 96Y XL High Performance	39	270	33	230	41	280	41	280
XL = reinforced or extra load tire. It may also appear as xl, EXTRA LOAD, or RF on the tire side-wall.									

The correct tire pressure for the *spare wheel* is located on a label on the driver's side B-pillar. Because technical changes may be made to vehicle equipment during the model year, always compare the tire size designa-

tion on the tire pressure label on your vehicle with the tires on your vehicle. Make sure that the tire size information on the vehicle label is the same as the size of the tires on the vehicle. This is especially important if the vehicle belongs to someone ▶

else or you bought the vehicle with different rims/tires or you bought the vehicle as a previously owned vehicle.

Remember, your safety and that of your passengers also depends on making sure that load limits are not exceeded. Vehicle load includes everybody and everything in and on the vehicle. These load limits are technically referred to as the vehicle's Gross Vehicle Weight Rating ("GVWR"). The Gross Axle Weight Rating ("GAWR") is the maximum load that can be applied at each of the vehicle's two axles. The Gross Vehicle Weight Rating and the Gross Axle Weight Rating are listed on the safety compliance sticker label located on the driver's side B-pillar. The tire pressure label on your Audi lists the maximum combined weight of all of the occupants and luggage or other cargo that the vehicle can carry. For the location of the tire pressure label

⇒ *fig. 189.*

 **WARNING**

Overloading a vehicle can cause loss of vehicle control, a crash or other accident, serious personal injury, and even death.

- Carrying more weight than your vehicle was designed to carry will prevent the vehicle from handling properly and increase the risk of a loss of vehicle control.
- The brakes on a vehicle that has been overloaded may not be able to stop the vehicle within a safe distance.
- Tires on a vehicle that has been overloaded can fail suddenly causing loss of control and a crash.
- Always make sure that the total load being transported – including the weight of a trailer hitch and the tongue weight of a loaded trailer – does not make the vehicle heavier than the vehicle's Gross Vehicle Weight Rating.

 **WARNING**

– Incorrect tire pressures and/or underinflation can

lead to a serious or fatal accident.

- Incorrect tire pressures and/or underinflation cause increased tire wear and can affect the handling of the vehicle.
- Incorrect tire pressures and/or underinflation can also lead to sudden tire failure, including a blowout and sudden deflation, causing loss of vehicle control.

### Checking tire pressure

*The correct tire pressure for the tires originally installed on your vehicle is listed on the tire pressure label located on driver's side B-pillar.*

The recommended tire pressures are on the tire pressure label and in the table ⇒ *page 234, Cold tire inflation pressure*. This means that the pressure must be checked and adjusted when the tire has not been driven for more than a couple of miles (kilometers) at low speeds during the previous three hours. Air in the tires expands when the tire heats up as

a result of internal friction as it flexes in use. The tire pressure is higher when the tire has warmed up than when it is “cold.”

It is the inflation pressure in a “cold” tire that counts. Therefore, you should never let air out of a warm tire to match “Cold tire inflation pressure” recommendations ⇒ *page 234*. The tires would then be underinflated and could fail suddenly.

The tire pressure label on your Audi lists the recommended cold tire inflation pressures at maximum capacity for the new, original equipment tires that were on your vehicle at the time it was manufactured. For the location of the label ⇒ *page 234, fig. 189*.

Most tires lose air naturally over time. They can also lose some air if you drive over a pothole or hit a curb while parking. It is usually not possible to see whether the radial tires used today are underinflated just by looking at them. ▶

Therefore, be sure to check tire pressures at least once a month and always before going on a long trip. Make sure to take the number of people and the amount of luggage into account when adjusting tire pressure for a trip – even one that you would not consider to be “long.” See ⇒ *page 242, Tires and vehicle load limits* for more important information.

Always use an accurate tire pressure gauge when checking and adjusting inflation pressures. Check all of the tires and be sure not to forget the spare tire. If the pressure in any tire is too high when the tire is “cold”, let air out of the tire slowly with the edge of the tire gauge and keep checking the pressure until you reach the pressure that is correct for the load (passengers and luggage) and kind of driving you plan to do.

If the pressure in any tire is too low, note the difference between the pressure in the cold tire and the pressure you need and add the air that you need to reach the correct pressure for the vehicle load (passengers

and luggage) for the tires on your vehicle as listed on the on your vehicle and in this manual and the kind of driving you plan to do.

**Never exceed the maximum inflation pressure listed on the tire sidewall for any reason.**

Remember that the vehicle manufacturer, not the tire manufacturer, determines the correct tire pressure for the tires on your vehicle.

It is important to check the tire pressure when the tires are cold.

–Read the required tire pressure from the tire pressure label. The tire pressure label is located on the driver's side B-pillar. The tire pressure label lists the recommended cold tire inflation pressures for the vehicle at its maximum capacity weight and the tires that were on your vehicle at the time it was manufactured. For recommended tire pressures for normal load conditions, please see chapter ⇒ *page 234.* ▶

- Turn the valve stem cap counter-clockwise to remove it from the tire valve.
- Place the air pressure gauge on the valve.
- The tire pressures should only be checked and adjusted when the tires are cold. The slightly raised pressures of warm tires must not be reduced.
- Adjust the tire pressure to the load you are carrying.
- Reinstall the valve stem cap on the valve.

### When should I check the tire pressure?

The correct tire pressure is especially important at high speeds. The pressure should therefore be checked at least once a month and always before starting a journey. Do not forget to check the tire pressure for the spare wheel.

### When should I adjust the tire pressures?

Adjust the tire pressure to the load you are carrying. After changing a wheel **or** replacing wheels you have to adjust the tire pressures on all wheels. In addition, you must then initial-

ize the new tire pressures in the tire pressure monitoring system\* ⇒ *page 257*.

#### WARNING

Incorrect tire pressures and/or underinflation can lead sudden tire failure, loss of control, collision, serious personal injury or even death.

- When the  warning symbol appears in the instrument cluster, stop and inspect the tires.
- Incorrect tire pressure and/or underinflation can cause increased tire wear and can affect the handling of the vehicle and stopping ability.
- Incorrect tire pressures and/or underinflation can also lead to sudden tire failure, including a blowout and sudden deflation, causing loss of vehicle control.
- The driver is responsible for the correct tire pressures for all tires on the vehicle. The applicable pressure values are located on a sticker on the driver's side B-pillar.

- Only when all tires on the vehicle are filled to the correct pressure, the tire pressure monitoring system\* can work correctly.
- The use of incorrect tire pressure values can lead to accidents or other damage. Therefore it is essential that the driver observe the specified tire pressure values for the tires and the correct pressures for the function of the tire pressure monitoring system\*.
- Always inflate tires to the recommended and correct tire pressure before driving off.
- Driving with underinflated tires bend more, letting them get too hot resulting in tread separation, sudden tire failure and loss of control.
- Excessive speed and/overloading can cause heat build-up, sudden tire failure and loss of control.
- If the tire pressure is too low or too high, the tires will wear prematurely and

the vehicle will not handle well.

- If the tire is not flat and you do not have to change a wheel immediately, drive at reduced speed to the nearest service station to check the tire pressure and add air as required.

 **Note**

Driving without valve stem caps can cause damage to the tire valves. To prevent this, always make sure that factory installed valve stem caps on all wheels are securely mounted on the valve.

 **For the sake of the environment**

Underinflated tires will also increase the fuel consumption.

### **Tires and vehicle load limits**

There are limits to the amount of load or weight that any vehicle and any tire can carry. A vehicle that is overloaded will not handle well and is more difficult to stop. Overloading can not only lead to loss of vehicle control, but can also damage important parts of the vehicle ►

and can lead to sudden tire failure, including a blowout and sudden deflation that can cause the vehicle to crash.

Your safety and that of your passengers also depends on making sure that load limits are not exceeded. Vehicle load includes everybody and everything in and on the vehicle. These load limits are technically referred to as the vehicle's **Gross Vehicle Weight Rating** ("GVWR").

The "GVWR" includes the weight of the basic vehicle, all factory installed accessories, a full tank of fuel, oil, coolant and other fluids plus maximum load. The maximum load includes the number of passengers that the vehicle is intended to carry ("seating capacity") with an assumed weight of 150 lbs. (68 kg) for each passenger at a designated seating position and the total weight of any luggage in the vehicle. If you tow a trailer, the weight of the trailer hitch and the tongue weight of the loaded trailer must be included as part of the vehicle load.

The **Gross Axle Weight Rating** ("GAWR") is the maximum load that can be applied at each of the vehicle's two axles.

The Gross Vehicle Weight Rating and the Gross Axle Weight Rating are listed on the safety compliance sticker label located on the driver's side B-pillar. Your Audi has 5 seating positions, 2 in the front and 3 in the rear for total seating capacity of 5. Each seating position has a seat belt ⇒ *page 136, Safety belts*.

The fact that there is an upper limit to your vehicle's Gross Vehicle Weight Rating means that the total weight of whatever is being carried in the vehicle (including the weight of a trailer hitch and the tongue weight of the loaded trailer) is limited. The more passengers in the vehicle or passengers who are heavier than the standard weights assumed mean that less weight can be carried as luggage.

The tire pressure label on your Audi also lists the maximum combined weight of all of the

occupants and luggage or other cargo that the vehicle can carry. For the location of the label ⇒ *page 234, fig. 189.*

 **WARNING**

Overloading a vehicle can cause loss of vehicle control, a crash or other accident, serious personal injury, and even death.

- Carrying more weight than your vehicle was designed to carry will prevent the vehicle from handling properly and increase the risk of the loss of vehicle control.
- The brakes on a vehicle that has been overloaded may not be able to stop the vehicle within a safe distance.
- Tires on a vehicle that has been overloaded can fail suddenly, including a blow-out and sudden deflation, causing loss of control and a crash.
- Always make sure that the total load being transported – including the weight of a trailer hitch and the tongue weight of a loaded trailer – does not make the vehicle

heavier than the vehicle's Gross Vehicle Weight Rating.

### Determining correct load limit

Use the example below to calculate the total weight of the passengers and luggage or other things that you plan to transport so that you can make sure that your vehicle will not be overloaded.

#### Steps for Determining Correct Load Limit

1. Locate the statement “THE COMBINED WEIGHT OF OCCUPANTS AND CARGO SHOULD NEVER EXCEED XXX KG OR XXX LBS” on your vehicle's placard (tire inflation pressure label) ⇒ *page 234, fig. 189.*
2. Determine the combined weight of the driver and passengers that will be riding in your vehicle.
3. Subtract the combined weight of the driver and passengers from “XXX” kilograms or “XXX” pounds

shown on the sticker  
 ⇒ page 234, fig. 189.

4. The resulting figure equals the available amount of cargo and luggage load capacity. For example, if the “XXX” amount equals 1400 lbs. and there will be five 150 lbs. passengers in your vehicle, the amount of available cargo and luggage load capacity is 650 lbs. ( $1400 - 750$  ( $5 \times 150$ ) = 650 lbs.)
5. Determine the combined weight of luggage and cargo being loaded on the vehicle. That weight may not safely exceed the available cargo and luggage load capacity calculated in Step 4.
6. If your vehicle will be towing a trailer, load from your trailer will be transferred to your vehicle. Consult this manual to determine how this reduces the available cargo and luggage load capacity of your vehicle.
  - ▶ Check the tire sidewall (⇒ page 248, fig. 193) to determine the designated load rating for a specific tire.

## Tire service life

The service life of tires depends on a lot of different things including proper installation and balancing, correct tire pressure and driving style.



**Fig. 191** Tire tread: tread wear indicators (TWI)



**Fig. 192** Rotating tires for more even wear

## Tread Wear Indicator (TWI)

The original tires on your vehicle have 1/16 inch (1.6 mm) high “wear indicators” ⇒ fig. 191 running across the tread. Depending on the make, there will be six to eight of them evenly placed around the tire. Marks on the tire sidewall (for example “TWI” or other

symbols) indicate the positions of the tread wear indicators. Worn tires must be replaced. Different figures may apply in other countries ⇒ .

### **Tire pressure**

Incorrect tire pressure causes premature wear and can cause sudden tire blow-out. For this reason, tire pressure must be checked at least once a month ⇒ *page 239*.

### **Driving style**

Driving fast around curves, heavy acceleration and hard braking increase tire wear.

### **Rotating tires for more even wear**

For all four tires on your vehicle to have the same service life, we recommend that the front and rear tires are rotated according to the tire manufacturer's suggested tire rotation intervals. Please remember the following:

–Tire rotation intervals may differ from the vehicle service intervals outlined in your Maintenance and Warranty Booklet.

–The longer one tire is used in one location on the vehicle, the more it wears at certain points; therefore, we recommend that you follow the tire manufacturer's suggested tire rotation intervals.

–Vehicles with front-wheel drive experience more tread wear on the front wheels compared to all wheel drive (quattro).

–Please rotate tires as shown ⇒ *fig. 192*.

–Extra care must be taken when rotating direction-specific tires ⇒ *page 267*.

### **Wheel balancing**

The wheels on new vehicles are balanced. However, various situations during everyday driving can cause them to become unbalanced, resulting in vibrations you can usually feel through the steering wheel.

Unbalanced wheels must be rebalanced to avoid excessive wear on steering, suspension and tires. A wheel must also be rebalanced when a new tire is installed. ►

## Incorrect wheel alignment

Incorrect wheel alignment can cause excessive tire wear, impairing the safety of the vehicle. If tires show excessive wear, have the wheel alignment checked by an authorized Audi dealer or qualified workshop.

## All wheel drive

Vehicles with quattro must always have tires of the same size, construction and tread type. For details see  
⇒ *page 190*.

### WARNING

Sudden tire failure can lead to loss of control, a crash and serious personal injury!

- Never drive a vehicle when the tread on any tire is worn down to the wear indicators.
- Worn tires are a safety hazard, they do not grip well on wet roads and increase your risk of “hydroplaning” and loss of control.
- Always keep chemicals that can cause tire damage, such as grease, oil, gasoline and brake fluid away from tires.

- Tires age even if they are not being used and can fail suddenly, especially at high speeds. Tires that are more than 6 years old can only be used in an emergency and then with special care and at lower speeds.
- Never mount used tires on your vehicle if you are not sure of their “previous history.” Old used tires may have been damaged even though the damage cannot be seen that can lead to sudden tire failure and loss of vehicle control.

## New tires and replacing tires and wheels

*New tires and wheels have to be broken in.*

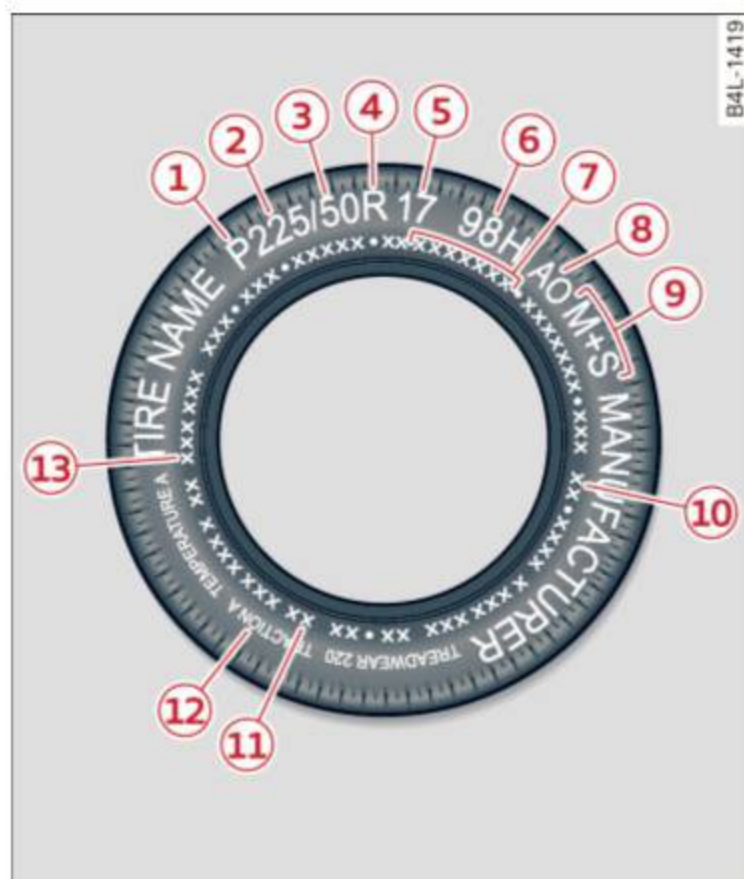

**Fig. 193** Tire specification codes on the sidewall of a tire

No.	Description
①	Passenger car tire (where applicable)
②	Nominal width of tire in millimeters
③	Ratio of height to width (aspect ratio)
④	Radial
⑤	Rim diameter code
⑥	Load index and speed rating
⑦	U.S. DOT tire identification number

No.	Description
⑧	Audi Original tire
⑨	Sever snow conditions
⑩	Tire ply composition and materials used
⑪	Maximum load rating
⑫	Treadwear, traction and temperature grades
⑬	Maximum permissible inflation pressure

The tires and rims are essential parts of the vehicle's design. The tires and rims approved by Audi are specially matched to the characteristics of the vehicle and can make a major contribution to good road holding and safe handling when in good condition and properly inflated ⇒ ⚠.

We recommend that all work on tires and wheels be performed by an authorized Audi dealer. They are familiar with recommended procedures and have the necessary special tools and spare parts as well as the proper facilities for disposing of the old tires.

Authorized Audi dealers have the necessary information

about technical requirements for installing or changing tires and rims.

## Replacing tires and wheels

Tires should be replaced at least in pairs and not individually (for example both front tires or both rear tires together).

Be sure to read and heed the information to the tire pressure monitoring system\*  
⇒ *page 257*.

Always buy replacement radial tires that have the same specifications as the tires approved for your vehicle by Audi. Replacement tires must always have the same load rating specification as the original equipment or approved optional tires listed in the table ⇒ *page 234*.

Audi-approved specification tires are specially matched to your vehicle and its load limits, and can contribute to the important roadholding, driving characteristics, and safety of the vehicle. The table (⇒ *page 234*) lists specifications of the tires approved for

the Audi models covered by your Owner's Literature.

The tire pressure label located on driver's side B-pillar (⇒ *page 234, fig. 190*) lists the specifications of the original equipment tires installed on your vehicle at the time it was manufactured.

Federal law requires tire manufacturers to place standardized information on the sidewall of all tires ⇒ *fig. 193*. This information identifies and describes the fundamental characteristics, the quality grade of the tire and also provides a tire identification number for safety standard certification and in case of a recall.

## Tire specifications

Knowledge of tire specifications makes it easier to choose the correct tires. Radial tires have the tire specifications marked on the sidewall, for example:

**P255 / 35 R19 96Y XL**

This contains the following information: ▶

- P** Indicates the tire is for passenger cars (where applicable)
- 255** Nominal tire width in mm of the tire from sidewall edge to sidewall edge. In general, the larger the number, the wider the tire
- 35** Height/width ratio in percent (aspect ratio)
- R** Tire construction: **R**adial
- 19** Rim diameter code (in inches)
- 96** Load rating code
- Y** Speed rating letter code
- XL** (or “xl”, “EXTRA LOAD”, or “RF”) Indicates that the tire is a “Reinforced” or an “Extra Load” tire
- M+S** (or “M/S”) Indicates that the tire has some mud and snow capability

The tires could also have the information of direction of rotation ⇒ *page 228*.

### Tire manufacturing date

The manufacturing date is also indicated on the tire sidewall

(possibly only on the *inner* side of the wheel):

“DOT ... 2214 ... ” means, for example, that the tire was produced in the 22nd week of 2014.

### Speed rating (letter code)

The speed rating letter code on the wheels indicates the maximum permissible road speeds ⇒ *Δ in Winter tires on page 255*.

- P up to 93 mph (150 km/h)
- Q up to 99 mph (158 km/h)
- R up to 106 mph (170 km/h)
- S up to 110 mph (180 km/h)
- T up to 118 mph (190 km/h)
- U up to 124 mph (200 km/h)
- H up to 130 mph (210 km/h)
- V up to 149 mph (240 km/h)<sup>1)</sup>
- Z over 149 mph (240 km/h)<sup>1)</sup>
- W up to 168 mph (270 km/h)<sup>1)</sup>
- Y up to 186 mph (298 km/h)<sup>1)</sup>

Your vehicle is normally factory equipped with tires, which possess excellent driving characteristics and give your Audi ►

<sup>1)</sup> For tires with a maximum speed capability over 149 mph (240 km/h), tire manufacturers sometimes use the letters “ZR.”

optimum driving comfort. An electronic speed limiter ⇒ *page 30* will normally prevent your vehicle from going faster than the tire speed rating ⇒ .

### **U.S. DOT Tire Identification Number (TIN) and tire manufacture date**

This is the tire's "serial number". It begins with the letters "DOT" and indicates that the tire meets all federal standards. The next two numbers or letters indicate the plant where it was manufactured, and the last four numbers represent the week and year of manufacture. For example, the numbers 2214 mean that the tire was produced in the 22nd week of 2014. The other numbers are marketing codes that may or may not be used by the tire manufacturer. This information is used to contact consumers if a tire defect requires a recall.

### **Audi Original tire**

Tires with the identification "AO" or "RO" have been specially matched with your Audi. We recommend using only these

tires because they meet the highest standards regarding safety and driving characteristics when used correctly. Your authorized Audi dealer will gladly provide you with more information.

### **Tire ply composition and materials used**

The number of plies indicates the number of layers of rubber-coated fabric in the tire. In general, the greater the number of plies, the more weight a tire can support. Tire manufacturers also must indicate the materials in the tire, which include steel, nylon, polyester, and others.

### **Maximum Load Rating**

This number indicates the maximum load in kilograms and pounds that can be carried by the tire.

### **Tire quality grading for treadwear, traction, and temperature resistance**

Tread wear, traction and temperature grades ⇒ *page 254*. ▶

## Maximum Permissible Inflation Pressure

This number is the greatest amount of air pressure that should ever be put in the tire under normal driving conditions.

### WARNING

- Using incorrect or unmatched tires and / or wheels or improper tire and wheel combinations can lead to loss of control, collision and serious personal injury.
- Always use tires, rims and wheel bolts that meet the specifications of original factory-installed tires or other combinations that have been specifically approved by the vehicle manufacturer.
- Tires age even if they are not being used and can fail suddenly, especially at high speeds. Tires that are more than 6 years old can only be used in an emergency and then with special care and at lower speeds.
- Never mount used tires on your vehicle if you are not

sure of their “previous history.” Old used tires may have been damaged even though the damage cannot be seen that can lead to sudden tire failure and loss of vehicle control.

- All four wheels must be fitted with radial tires of the same type, size (rolling circumference) and the same tread pattern. Driving with different tires reduces vehicle handling and can lead to a loss of control.
- If the spare tire is not the same as the tires that are mounted on the vehicle - for example with winter tires - only use the spare tire for a short period of time and drive with extra care. Refit the normal road wheel as soon as safely possible.
- Never drive faster than the maximum speed for which the tires on your vehicle are rated because tires that are driven faster than their rated speed can fail suddenly.
- Overloading tires cause heat build-up, sudden tire failure, including a blowout

and sudden deflation and loss of control.

- Temperature grades apply to tires that are properly inflated and not over or underinflated.
- For technical reasons it is not always possible to use wheels from other vehicles – in some cases not even wheels from the same vehicle model.
- If you install wheel trim discs on the vehicle wheels, make sure that the air flow to the brakes is not blocked. Reduced airflow to the brakes can them to overheat, increasing stopping distances and causing a collision.
- Run flat tires may only be used on vehicles that were equipped with them at the factory. The vehicle must have a chassis designed for run flat tires and a factory-installed tire pressure monitoring system\* that indicates a loss of tire pressure. Incorrect use of run flat tires can lead to vehicle damage or accidents. Check

with an authorized Audi dealer or tire specialist to see if your vehicle can be equipped with run flat tires. If run flat tires are used, they must be installed on all four wheels. Mixing tire types is not permitted.

#### Note

- For technical reasons, it is not generally possible to use the wheel rims from other vehicles. This can hold true for wheels of the same vehicle type.
- If the spare tire is different from the tires that you have mounted on your vehicle (for example winter tires or wide profile tires), then use the spare tire for a short period of time only and drive with extra care. Replace the flat tire with the tire matching the others on your vehicle as soon as possible.
- Never drive without the valve stem cap. The valves could get damaged.

**For the sake of the environment**

Dispose of old tires in accordance with the local requirements.

**Uniform tire quality grading**

- Tread wear
- Traction AA A B C
- Temperature A B C

Quality grades can be found where applicable on the tire side wall between tread shoulder and maximum section width ⇒ *page 248, fig. 193.*

**For example:** Tread wear **200**, Traction **AA**, Temperature **A**.

All passenger car tires must conform to Federal Safety Requirements in addition to these grades.

**Tread wear**

The *tread wear* grade is a comparative rating based on the wear rate of the tire when tested under controlled conditions on a specified government test course.

For example, a tire graded 150 would wear one and one half (1 1/2) times as well on the government course as a tire graded 100.

The relative performance of tires depends upon the actual conditions of their use, however, and may depart significantly from the norm due to variations in driving habits, service practices and differences in road characteristics and climate.

**Traction**

The *traction* grades, from highest to lowest, are AA, A, B and C. Those grades represent the tire's ability to stop on wet pavement as measured under controlled conditions on specified government test surfaces of asphalt and concrete. A tire marked C may have poor traction performance ⇒

**Temperature**

The *temperature* grades are A (the highest), B, and C, representing the tire's resistance to the generation of heat and its ability to dissipate heat when tested under controlled conditions on a specified indoor laboratory test wheel.

Sustained high temperature can cause the material of the tire to degenerate and reduce tire life, and excessive temperature can lead to sudden tire failure ⇒ .

The grade C corresponds to a level of performance which all passenger car tires must meet under the Federal Motor Vehicle Safety Standard No. 109. Grades B and A represent higher levels of performance on the laboratory test wheel than the minimum required by law.

**WARNING**

The traction grade assigned to this tire is based on straight-ahead braking traction tests, and does not include acceleration, cornering, hydroplaning or peak traction characteristics.

**WARNING**

The temperature grade for this tire is established for a tire that is properly inflated and not overloaded. Excessive speed, underinflation, or excessive loading, either separately or in combination, can cause heat buildup and possible tire failure.

**Winter tires**

*Winter tires can improve vehicle handling on snow and ice. At temperatures below 45 °F (7 °C) we recommend changing to winter tires.*

In some heavy snow areas, local governments may require true winter or “snow” tires, those with very deeply cut tread. These tires should only be used in pairs and be installed on all four wheels. Make sure you purchase snow tires that are the same size and construction type as the other tires on your vehicle. ►

Your vehicle is equipped with all wheel drive, this will improve traction during winter driving, even with the standard tires. However, we strongly recommend that you always equip all four wheels on your vehicle with correctly fitted winter tires or all-season tires, when winter road conditions are expected. This also improves the vehicle's braking performance and reduces stopping distances.

Summer tires provide less grip on ice and snow.

Winter tires (snow tires) must always be fitted on all four wheels.

Ask your authorized Audi dealer or qualified workshop for permitted **winter tire sizes**. Use only radial winter tires.

Winter tires lose their effectiveness when the tread is worn down to a depth of 0.157 inch (4 mm).

Only drive with winter tires under winter conditions. Summer tires handle better when there is no snow or ice on the roads and the temperature is above 45 °F (7 °C).

If you have a flat tire, see notes on spare wheel ⇒ *page 248*.

Please always remember that winter tires may have a lower speed rating than the tires originally installed on your vehicle at the time it was manufactured. Please see ⇒ *page 250, Speed rating (letter code)* for a listing of the speed rating letter codes and the maximum speed at which the tires can be driven.

The speed rating letter code (⇒ *page 232*) is on the side wall of the tire ⇒ *page 248*.

### WARNING

Winter tires have maximum speed limits that may be lower than your vehicle's maximum speed. Always know the maximum speed before driving off. Never drive faster than the speed permitted for your specific winter tires. This will cause damage to the tires leading to an accident and serious personal injury to you and your passengers.

### WARNING

Driving faster than the maximum speed for which the winter tires on your vehicle were designed can cause tire failure including a blowout and sudden deflation, loss of control, crashes and serious personal injuries. Have worn or damaged tires replaced immediately.

- Winter tires have maximum speed rating that may be lower than your vehicle's maximum speed.
- Never drive faster than the speed for which the winter or other tires installed on your vehicle are rated.

### WARNING

Always adjust your driving to the road and traffic conditions. Never let the good acceleration of the winter tires and all wheel drive tempt you into taking extra risks. Always remember:

- When braking, an all wheel drive vehicle handles in the same way as a front drive vehicle.
- Drive carefully and reduce your speed on icy and slippery roads, even winter tires cannot help under black ice conditions.

### For the sake of the environment

Use summer tires when weather conditions permit. They are quieter, do not wear as quickly and reduce fuel consumption.

### Snow chains

Snow chains may be fitted only to the front wheels, and only to certain tire sizes. Ask your authorized Audi dealer on which tire sizes snow chains can be used.

The snow chains must have low-profile links and must not be thicker than 0.53 inch (13.5 mm), including the lock.

Remove wheel center covers and trim discs before putting snow chains on your vehicle ⇒ . For safety reasons cover caps must then ►

be fitted over the wheel bolts. These are available from authorized Audi dealers.

### WARNING

Using the wrong snow chains for your vehicle or installing them incorrectly can increase the risk of loss of control leading to serious personal injury.

- Snow chains are available in different sizes. Always make sure to follow the instructions provided by the snow chain manufacturer.
- When driving with snow chains never drive faster than the speed permitted for your specific snow chains.
- Always observe local regulations.

### Note

- Remove snow chains before driving on roads not covered with snow to avoid damaging tires and wearing the snow chains down unnecessarily.
- Snow chains, which come into direct contact with the wheel rim, can scratch or damage it. Therefore, make sure that the snow chains are suitably covered. Check the position of the snow chains after driving a few yards and correct if necessary. Follow the instructions from the snow chain manufacturer when doing so.

### Tips

Where snow chains are mandatory on certain roads, this normally also applies to vehicles with all wheel drive.

## Wheel bolts

*Wheel bolts must always be tightened to the correct torque.*

The design of wheel bolts is matched to the factory installed rims. If different rims are fitted, the correct wheel bolts with the right length and correctly shaped bolt heads must be used. This ensures that wheels are fitted securely and that the brake system functions correctly.

In certain circumstances, you may not use wheel bolts from a different vehicle – even if it is the same model ⇒ *page 285*.

### WARNING

Improperly tightened or maintained wheel bolts can become loose causing loss of control, a collision and serious personal injury.

- Always keep the wheel bolts and the threads in the wheel hubs clean so the wheel bolts can turn easily and be properly tightened.
- Never grease or oil the wheel bolts and the threads in the wheel hubs. They can become loose while driving if greased or oiled, even if tightened to the specified torque.
- Only use wheel bolts that belong to the rim being installed.
- Never use different wheels bolts on your vehicle.
- Always maintain the correct tightening torque for the wheel bolts to reduce the risk of a wheel loss. If the tightening torque of the wheel bolts is too low, they can loosen and come out when the vehicle is moving. If the tightening torque is too high, the wheel bolts and threads can be damaged and the wheel can become loose.

### Note

The specified torque for the wheel bolts is 90 ft lbs. (120 Nm) with a tolerance of ± 7,4 ft lbs. (± 10 Nm). Torque wheel bolts diagonally. After changing a wheel, the torque must be checked as soon as possible with a torque wrench – preferably by an authorized Audi dealer or qualified workshop.

## Low aspect ratio tires

Your Audi is factory-equipped with low aspect ratio tires. These tires have been thoroughly tested and been selected specifically for your model for their superb performance, road feel ►

and handling under a variety of driving conditions. Ask your authorized Audi dealer for more details.

The low aspect ratio of these tires is indicated by a numeral of **55 or less** in the tire's size designation. The numeral represents the ratio of the tire's sidewall height in relation to its tread width expressed in percentage. Conventional tires have a height/width ratio of 60 or more.

**The performance of low-aspect-ratio tires is particularly sensitive to improper inflation pressure. It is therefore important that low aspect ratio tires are inflated to the specified pressure and that the inflation pressure is regularly checked and maintained. Tire pressures should be checked at least once a month and always before a long trip**  
⇒ *page 239, Checking tire pressure.*

### What you can do to avoid tire and rim damage

Low aspect ratio tires can be damaged more easily by impact with potholes, curbs, gullies or ridges on the road, particularly if the tire is underinflated.

In order to minimize the occurrence of impact damage to the tires of your vehicle, we recommend that you observe the following precautions:

- Always maintain recommended inflation pressures. Check your tire pressure every 2,000 miles (3,000 km) and add air if necessary.
- Drive carefully on roads with potholes, deep gullies or ridges. The impact from driving through or over such obstacles can damage your tires. Impact with a curb may also cause damage to your tires.
- After any impact, immediately inspect your tires or have them inspected by the nearest authorized Audi dealer. Replace a damaged tire as soon as possible.
- Inspect your tires every 2,000 miles (3,000 km) for damage and wear. Damage is not always easy to see. Damage can lead to loss of air and underinflation, which could eventu-

ally cause tire failure. If you believe that a tire may have been damaged, replace the tire as soon as possible.

- These tires may wear more quickly than others.
- Please also remember that, while these tires deliver responsive handling, they may ride less comfortably and make more noise than other choices.

### Reduced performance in winter/cold season conditions

All tires are designed for certain purposes. The low aspect ratio, ultra high performance tires originally installed on your vehicle are intended for maximum dry and wet road performance and handling. They are not suitable for cold, snowy or icy weather conditions. If you drive under those circumstances, you should equip your vehicle with all-season or winter tires, which offer better traction under those conditions. We suggest you use the recommended snow or all-season tires specified for your vehicle, or their equivalent.

Refer to ⇒ *page 254* for more detailed information regarding winter tires.

## Tire pressure monitoring system

### (!) General notes

Applies to vehicles: with tire pressure monitoring system

Each tire, including the spare (if provided), should be checked monthly when cold and inflated to the inflation pressure recommended by the vehicle manufacturer on the vehicle placard or tire inflation pressure label. (If your vehicle has tires of a different size than the size indicated on the vehicle placard or tire inflation pressure label, you should determine the proper tire inflation pressure for those tires).

As an added safety feature, your vehicle has been equipped with a tire pressure monitoring system (TPMS) that illuminates a low tire pressure telltale when one or more of your tires is significantly under-inflated. ▶

Accordingly, when the low tire pressure telltale illuminates, you should stop and check your tires as soon as possible, and inflate them to the proper pressure. Driving on a significantly under-inflated tire causes the tire to overheat and can lead to tire failure. Under-inflation also reduces fuel efficiency and tire tread life, and may affect the vehicle's handling and stopping ability.

Please note that the TPMS is not a substitute for proper tire maintenance, and it is the driver's responsibility to maintain correct tire pressure, even if under-inflation has not reached the level to trigger illumination of the TPMS low tire pressure telltale.

Your vehicle has also been equipped with a TPMS malfunction indicator to indicate when the system is not operating properly. The TPMS malfunction indicator is combined with the low tire pressure telltale. When the system detects a malfunction, the telltale will flash for approximately one minute and then remain continuously illuminated. This sequence will continue upon subsequent vehicle start-ups as long as the malfunction exists.

When the malfunction indicator is illuminated, the system may not be able to detect or signal low tire pressure as intended. TPMS malfunctions may occur for a variety of reasons, including the installation of replacement or alternate tires or wheels on the vehicle that prevent the TPMS from functioning properly. Always check the TPMS malfunction telltale after replacing one or more tires or wheels on your vehicle to ensure that the replacement or alternate tires and wheels allow the TPMS to continue to function properly.

### Tire pressure indicator appears

Applies to vehicles: with tire pressure monitoring system

*The tire pressure indicator in the instrument cluster informs you if the tire pressure is too low or if there is a system malfunction.*

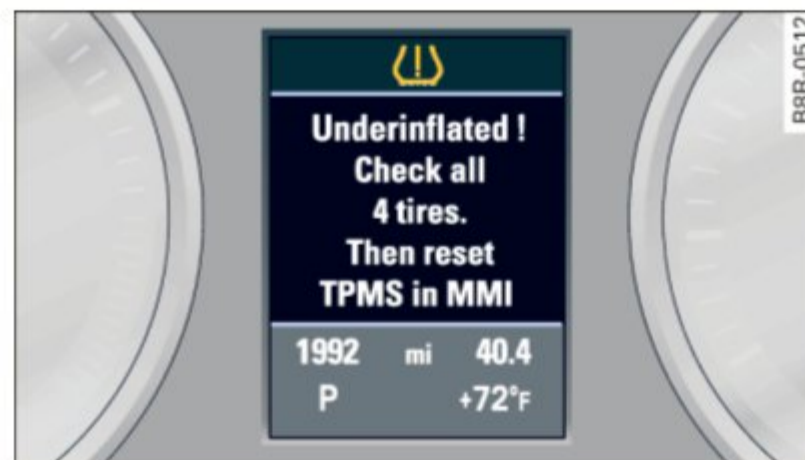



Fig. 194 Display: underinflation warning

Using the ABS sensors, the tire pressure monitoring system compares the tire tread circumference and vibration characteristics of the individual tires. If the pressure decreases in one or more tires, this is indicated in the instrument cluster with a  warning symbol and a message  $\Rightarrow$  *fig. 194*. The driver message in the display goes out after 5 seconds. The driver message can be displayed again by pressing the **SET** button. If only one tire is affected, the display will indicate its position.



The tire pressure monitoring system must be reset via radio or MMI\* each time the pressures are adjusted (e. g. when switching between partial and full load pressure) or after changing or replacing a tire on your vehicle  $\Rightarrow$  *page 259*. The TPMS indicator only monitors the tire pressure that you have previously stored. You can find the recommended tire pressures for your vehicle on the label on driver's side B-pillar  $\Rightarrow$  *page 234*.

Tire tread circumference and vibration characteristics can change and cause a tire pressure warning if:

- the tire pressure in one or more tires is too low,
- the tire has structural damage,
- the tire pressure was changed, wheels rotated or replaced but the TPMS was not reset  $\Rightarrow$  *page 259*,

- the spare tire\*/inflatable spare tire\* is mounted.

### Warning symbols

 Loss of pressure in at least one tire ⇒ . Check the tire or tires and replace or repair if necessary. The indicator light  in the instrument cluster also illuminates ⇒ *page 13*. Check/correct the pressures of all four tires and reset TPMS via radio or MMI\*.

### **TPMS** (Tire Pressure Monitoring System) **Tire pressure: System malfunction!**

If **TPMS** appears after switching the ignition on or while driving and the indicator light  in the instrument cluster blinks for approximately one minute and then stays on, there is a system malfunction. Attempt to store the correct tire pressure ⇒ *page 259*. If the indicator light does not turn off or if it turns on shortly thereafter, immediately drive your vehicle to an authorized Audi dealer or authorized repair facility to have the malfunction corrected.

### **WARNING**

- If the tire pressure indicator appears in the instrument cluster display, one or more of your tires is significantly under-inflated. Reduce your speed immediately and avoid any hard steering or braking maneuvers. Stop as soon as possible and check the tires and their pressures. Inflate the tire pressure to the proper pressure as indicated on the vehicle's tire pressure label ⇒ *page 234*. Driving on a significantly under-inflated tire causes the tire to overheat and can lead to tire failure. Under-inflation also is likely to impair the vehicle's handling and stopping ability.
- The driver is responsible for maintaining the correct tire pressures. You must check the tire pressures regularly.
- Under certain conditions (such as a sporty driving style, winter conditions or unpaved roads), the pressure monitor indicator may be delayed.

- Ask your authorized Audi dealer if run-flat tires may be used on your vehicle.



### **Tips**

- The tire pressure monitoring system may stop working when there is an ESC malfunction.
- Using snow chains may result in a system malfunction.
- The tire pressure monitoring system on your Audi was developed using tires with the "AO" or "RO" identification on the tire sidewall ⇒ *page 248*. We recommend using these tires.

### **Reset tire pressure monitoring system**

Applies to vehicles: with tire pressure monitoring system

*If the tire pressure is adjusted, wheels are rotated or changed, the TPMS must be reset via radio or MMI\*.*

- ▶ Before storing the new tire pressures, check that the current pressures on all four tires correspond to the specified values and adapt the pressures to the current load ⇒ *page 234*.
- ▶ Switch on the ignition.
- ▶ Select: the  function button > **Tire pressure monitoring** > **Store now**. Or
- ▶ Select: the  function button > **Car systems\*** control button > **Servicing & checks** > **Tire pressure monitoring** > **Store tire pressures** > **Yes, store now**.

### **Tips**

Do not store the tire pressure if there are snow chains on the tire. Otherwise, a system malfunction may occur.

## What do I do now?

### Vehicle tool kit

The tools are stored underneath the floor panel in the luggage compartment.

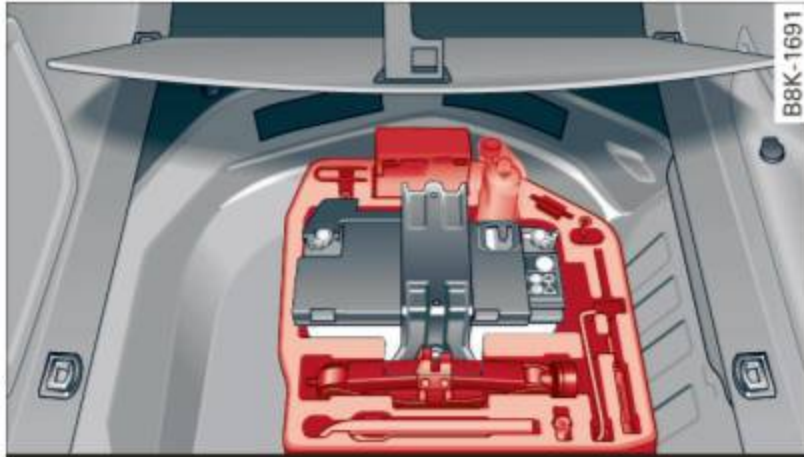

Fig. 195 Sedan Luggage compartment: tool kit

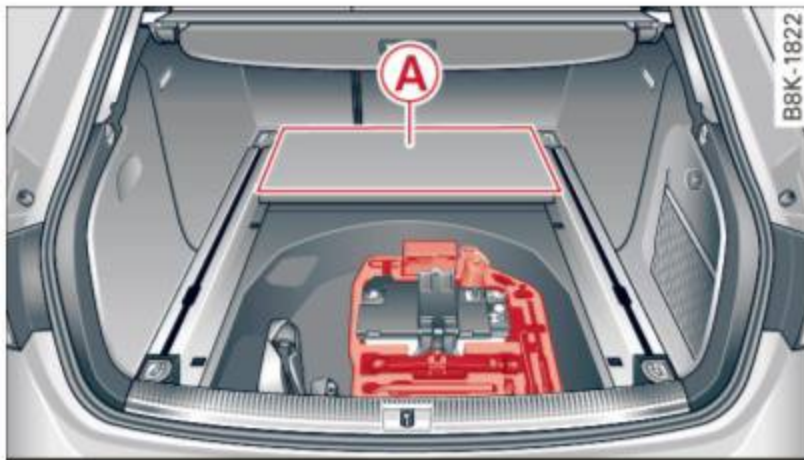

Fig. 196 allroad Luggage compartment: tool kit

When you need access to the vehicle tool kit or jack\*, you will need to take out the spare tire and cover ⇒ *page 260*.

Depending on your vehicle's equipment, the tool kit may also be located under the cargo floor cover **A** ⇒ *fig. 196* behind the seat backrest.

The vehicle tool kit includes:

- Hook for removing wheel covers\*
- Alignment pin for changing the wheel
- Screwdriver with reversible blade
- Tool for changing light bulbs
- Reversible bit (reversible Torx bit for changing light bulbs)
- Rod for jack
- Jack\*
- Lug wrench
- Towing eye

Some of the vehicle items listed above are provided on certain models only or are optional extras.

Before returning the jack\* to its place, retract the jack arm fully.

#### WARNING

- Never use the screw driver hex head to tighten wheel bolts, since the bolts cannot attain the necessary tightening torque if you use the hex head, potentially causing an accident.
- The factory-supplied jack is intended only for your vehicle model. Under no circumstances should it be used to lift heavy vehicles or other loads; you risk injuring yourself.
- Never start the engine when the vehicle is raised, which could cause an accident.
- Support the vehicle securely with appropriate stands if work is to be performed underneath the vehicle; otherwise, there is a potential risk for injury.

### Space-saving spare tire (compact spare tire)

Applies to vehicles: with space-saving spare tire

The spare tire/wheel is located in the luggage compartment under the cargo floor cover. It is intended for short-term use only.



Fig. 197 Spare tire

#### Removing the spare tire

- ▶ Lift the cargo floor by the plastic handle ⇒ *fig. 197*.
- ▶ Hook the handle into the luggage compartment weather strip.

- ▶ Turn the large screw ⇒ *fig. 197* counter-clockwise.
- ▶ Take out the spare tire.
- ▶ Always store the vehicle tool kit, the jack\*, and the replaced tire in the luggage compartment ⇒ *page 132*.
- ▶ Unhook the cargo floor before closing the rear lid.

### Using the spare tire (compact spare tire)

The compact spare tire is only intended for emergencies until you can reach a repair shop. Replace it as quickly as possible with a standard wheel and tire.

There are some restrictions on the use of the compact spare tire. The compact spare tire has been designed specifically for your type of vehicle. It must not be swapped with a compact spare tire from another type of vehicle.

### Snow chains

For technical reasons, the use of snow chains on the compact spare tire is **not permitted**.

If you do have to drive with snow chains and a *front tire* fails, mount the spare wheel with tire instead of a rear tire. Install the snow chains on the rear tire and use it to replace the defective front tire.

### WARNING

- Never use the spare tire if it is damaged or if it is worn down to the tread wear indicators.
- If the spare tire is more than 6 years old, use it only in an emergency and with extreme caution and careful driving.
- The spare tire is intended only for temporary and short-term use. It should be replaced as soon as possible with the normal wheel and tire.
- After mounting the compact spare tire, the tire pressure must be checked as soon as possible. The tire pressure of the compact spare tire must be 4.2 bar; otherwise, you risk having an accident.
- Do not drive faster than 50 mph (80 km/h). You risk having an accident.

- Avoid full-throttle acceleration, heavy braking, and fast cornering. You risk having an accident.
- Never drive using more than one spare wheel and tire. You risk having an accident.
- Normal summer or winter tires must not be mounted on the compact spare wheel rim.
- For technical reasons, the use of tire chains on the spare tire is not permitted. If it is necessary to drive with tire chains, the spare wheel must be mounted on the front axle in the event of a flat in a rear tire. The newly available front wheel must then be installed in place of the rear wheel with the flat tire. Installing the tire chain before mounting the wheel and tire is recommended.
- Loose items in the passenger compartment can cause serious personal injury during hard braking or in an accident. Never store the spare tire or jack and tools in the passenger compartment.

## Inflatable spare tire

Applies to vehicles: with inflatable spare tire

*The inflatable spare tire expands to its full diameter when it is inflated.*



Fig. 198 Inflatable spare tire with compressor

### Removing inflatable spare tire

- ▶ Lift up the cargo floor using the handle.
- ▶ Turn the large screw ⇒ *fig. 198* counter-clockwise.
- ▶ Take out the inflatable spare tire. ▶

- ▶ Always store the vehicle tool kit, the jack\* and the replaced tire in the luggage compartment ⇒ *page 132*.

### Stowing the inflatable spare tire

- ▶ Release the air by unscrewing the valve stem.
- ▶ Screw the valve stem back in afterwards.
- ▶ Wait a few hours before placing the wheel in the spare wheel well ⇒ .
- ▶ Secure the wheel with the large screw.
- ▶ Fold the cargo floor back down.

### After using the inflatable spare wheel

The inflatable spare tire can be re-used as long as it is not damaged and is not worn down to the tread wear indicators ⇒ .

When you let the air out of the inflatable spare tire, it does not assume its folded shape again for several hours. Until then, it cannot be placed back in the spare wheel well and stowed securely.

#### WARNING

- Never use the spare tire if it is damaged or if it is worn down to the tread wear indicators.
- If the inflatable spare tire is more than 6 years old, use it only in an emergency and with extreme caution and careful driving.
- The inflatable spare tire is intended only for temporary and short-term use. It should be replaced as soon as possible with the normal wheel and tire.
- The tire pressure value for the inflatable spare tire is located on the driver's side B-pillar ⇒ *page 234, fig. 190*.
- Maximum permissible speed is 50 mph (80 km/h).
- Avoid full-throttle acceleration, heavy braking, and fast cornering.
- When the air is let out of the inflatable spare wheel, it does not assume its folded shape for several hours. Until then, it cannot be placed back in the spare wheel well and stowed securely.

- Never drive with more than one inflatable spare tire.
- For technical reasons, the use of tire chains on the inflatable spare tire is not permitted. If it is necessary to drive with tire chains, the inflatable spare wheel must be mounted on the rear axle in the event of a flat in a front tire. The newly available rear wheel must then be installed in place of the front wheel with the flat tire. Installing the tire chain before mounting the wheel and tire is recommended.
- Loose items in the passenger compartment can cause serious personal injury during hard braking or in an accident. Never store the inflatable spare tire or jack\* and tools in the passenger compartment.

#### Note

- The inflatable spare tire has been developed specifically for this vehicle model. It must not be exchanged or used for other vehicle models. Similarly, inflatable tires from other vehicle models must not be used.
- Normal summer or winter tires must not be installed on the inflatable tire rim.

## Inflating inflatable spare tire

Applies to vehicles: with inflatable spare tire

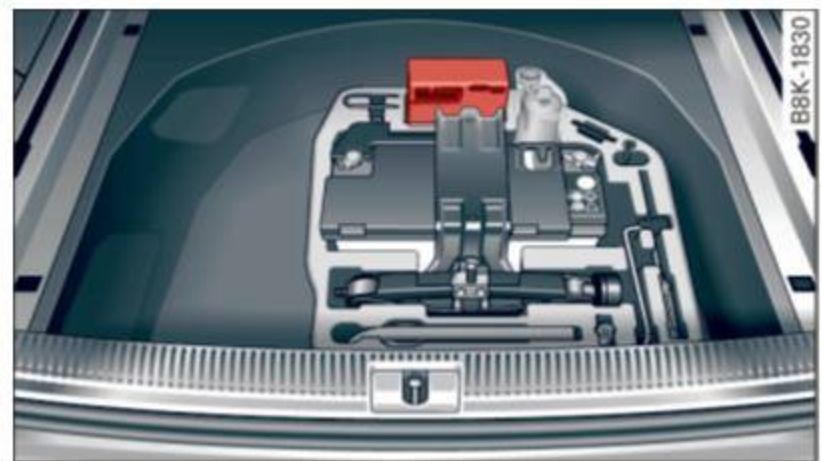

Fig. 199 Luggage compartment: compressor

- ▶ Remove the cover for the vehicle tools and remove the compressor. For some vehicle models, the compressor is located in a holder under the spare tire.

- ▶ Unscrew the valve stem from the spare tire.
- ▶ Screw the tire filler hose from the compressor firmly onto the valve of the spare tire.
- ▶ Insert the plug from the compressor into a socket of the vehicle ⇒ *page 66*.
- ▶ Switch the compressor on.
- ▶ Let the compressor run until the value specified on the tire pressure label is reached ⇒ *page 234, fig. 190*. Switch the compressor off after running for 12 minutes at the most - danger of overheating!

### WARNING

The compressor and the tire filler hose can become extremely hot while they are running - danger of burns!



### Note

Switch the compressor off after running for 12 minutes at the most - danger of overheating! Allow the compressor to cool down for a few minutes before you use it again.

## Changing a wheel

### Before changing a wheel

*Observe the following precautions for your own and your passenger's safety when changing a wheel.*

- ▶ After you experience a tire failure, pull the car well away from moving traffic and try to reach **level** ground before you stop ⇒ .
- ▶ All passengers should **leave the car** and move to a safe location (for instance, behind the guardrail) ⇒ .
- ▶ Engage the **parking brake** to prevent your vehicle from rolling unintentionally ⇒ .
- ▶ Shift into **1st gear** on vehicles with manual transmission, or move the **selector lever to the P position** on vehicles with automatic transmission.
- ▶ If you are towing a trailer: unhitch the trailer from your vehicle.
- ▶ Take the **jack** ⇒ *page 260* and the **spare tire** ⇒ *page 261* out of the luggage compartment.

### WARNING

You or your passengers could be injured while changing a wheel if you do not follow these safety precautions:

- If you have a flat tire, move a safe distance off the road. Turn off the engine, turn the emergency flashers on and use other warning devices to alert other motorists.
- Make sure that passengers wait in a safe place away from the vehicle and well away from the road and traffic.
- To help prevent the vehicle from moving suddenly and possibly slipping off the jack, always fully set the parking brake and block the wheel diagonally opposite the wheel being changed with the folding chocks or other objects. When one front wheel is lifted off the ground, placing the Automatic Transmission in “P” (Park) will *not* prevent the vehicle from moving.
- Before you change a wheel, be sure the ground is level and firm. If necessary, use a sturdy board under the jack.
- Always store the vehicle tool kit, the jack\* and the replaced tire in the luggage compartment ⇒ *page 132*.

### Note

If you are changing the wheel on a steep incline, use a rock or similar object to block the opposite wheel to prevent the vehicle from moving.

### Tips

Obey all laws.

### Changing a wheel

*When you change a wheel, follow the sequence described below step-by-step and in exactly that order.*

1. Remove the **decorative wheel cover\*** or the **wheel bolt caps\***. For more details see ▶

also ⇒ page 264, *Decorative wheel covers* or ⇒ page 264, *Wheels with wheel bolt caps*.

2. Loosen the **wheel bolts** ⇒ page 265.
3. Locate the proper mounting point for the jack and align the jack below that point ⇒ page 265.
4. **Lift** the car with the jack ⇒ page 265.
5. Remove the **wheel with the flat tire** and then install the **spare tire** ⇒ page 266.
6. Tighten all wheel bolts lightly.
7. **Lower** the vehicle with the jack.
8. Use the wheel bolt wrench and **firmly** tighten all wheel bolts in a crisscross pattern ⇒ page 265.
9. Replace the **decorative wheel cover\*** or the **wheel bolt caps\***.

### **WARNING**

Always read and follow all WARNINGS and information ⇒  in *Raising the vehicle on page 266* and ⇒ page 267.

### After changing a wheel

A wheel change is not complete without the doing the following.

- ▶ Always store the vehicle tool kit, the jack\*, and the replaced tire in the luggage compartment ⇒ page 132.
- ▶ Check the **tire pressure** of the spare tire as soon as possible.
- ▶ As soon as possible, have the **tightening torques** on all wheel bolts checked with a torque wrench. The correct tightening torque is 90 ft lbs. (120 Nm).
- ▶ Have the flat tire **replaced** as soon as possible.

### **Tips**

- If you notice that the wheel bolts are corroded and difficult to turn while changing a tire, they should be replaced before you check the tightening torque.
- Drive at reduced speed until you have the tightening torques checked.

### Decorative wheel covers

Applies to vehicles: with decorative wheel covers

*The decorative wheel covers must be removed first to access the wheel bolts.*

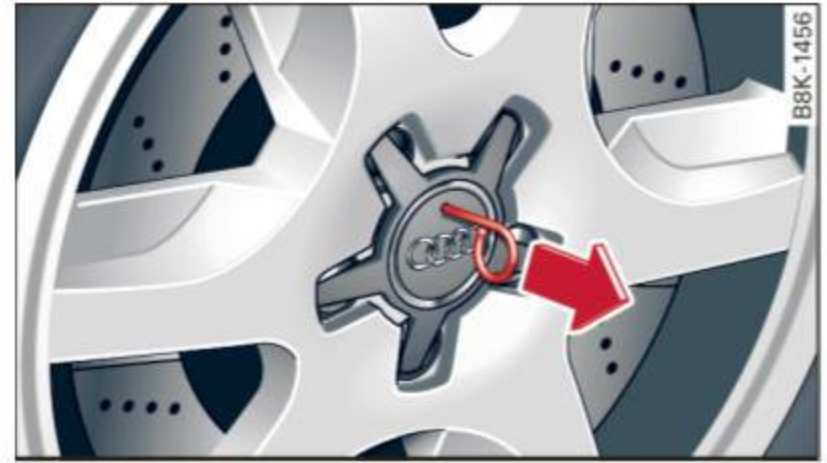

Fig. 200 Changing a wheel: removing the wheel cover

### Removing

- ▶ Insert the **hook** provided with the vehicle tool kit in the hole in the hub.
- ▶ Pull off the **decorative wheel cover** ⇒ fig. 200.

### Wheels with wheel bolt caps

Applies to vehicles: with wheel bolts with caps

*The caps must be removed first from the wheel bolts before the bolts can be unscrewed.*



Fig. 201 Changing a wheel: removing the wheel bolt caps

### Removing

- ▶ Push the **plastic clip** provided with the vehicle tool kit over the wheel bolt cap until it engages.
- ▶ Pull on the **plastic clip** to remove the cap ⇒ fig. 201.

### Refitting

- ▶ Place the caps over the wheel bolts and push them back on.

The caps are to protect and keep the wheel bolts clean.

### Loosening and tightening the wheel bolts

The wheel bolts must be loosened before raising the vehicle.



Fig. 202 Changing a wheel: loosening the wheel bolts

### Loosening

- ▶ Install the **wheel bolt wrench** over the wheel bolt and push it down as far as it will go.
- ▶ Take tight hold of the *end* of the wrench handle and turn the wheel bolts **counter-clockwise** about *one single* turn in the direction of arrow ⇒ *fig. 202*.

### Tightening

- ▶ Install the **wheel bolt wrench** over the wheel bolt and push it down as far as it will go.
- ▶ Take tight hold of the *end* of the wrench handle and turn each wheel bolt **clockwise** until it is seated.

### ⚠ WARNING

- Do not use force or hurry when changing a wheel - you can cause the vehicle to slip off the jack and cause serious personal injuries.
- *Do not* loosen the wheel bolts *more than one turn* before you raise the vehicle with the jack. - You risk an injury.

### i Tips

- Never use the hexagonal socket in the handle of the screwdriver to loosen or tighten the wheel bolts.
- If a wheel bolt is very tight, you may find it easier to loosen by carefully pushing down on the end of the wheel bolt wrench with *one foot only*. As you do so, hold on to the car to keep your balance and take care not to slip.

### Raising the vehicle

The vehicle must be lifted with the jack first before the wheel can be removed.

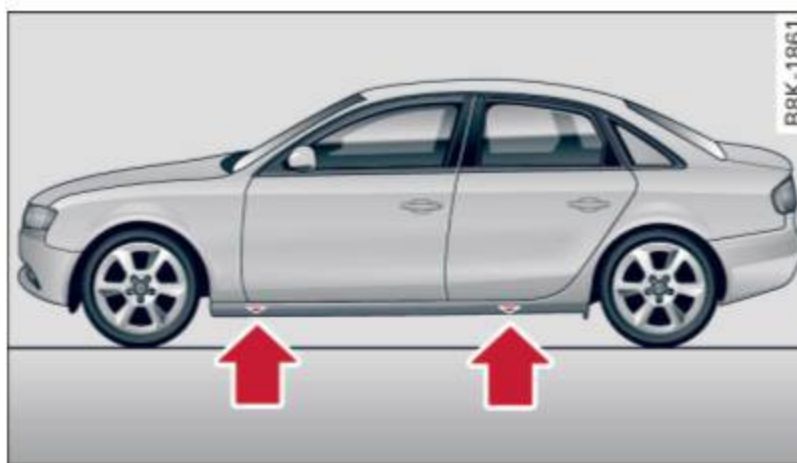

Fig. 203 Sill panels: markings

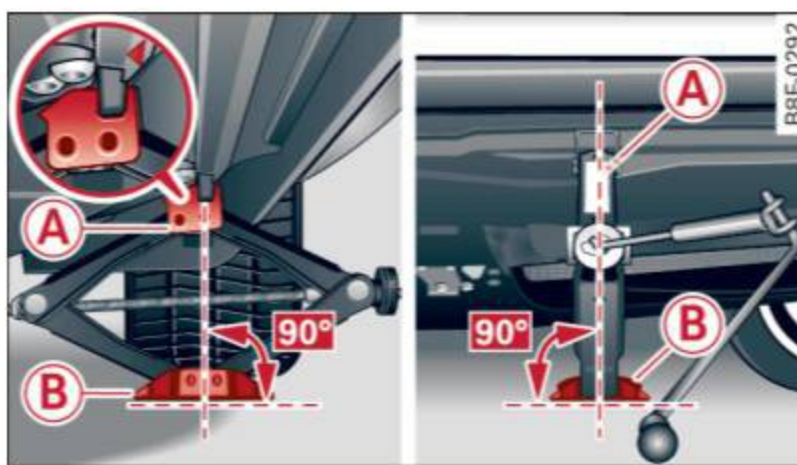

Fig. 204 Sill: positioning the vehicle jack

The location of the jack point is indicated by an indentation on the underside of the vehicle ⇒ *fig. 203*.

- ▶ Activate the **parking brake** to prevent the vehicle from rolling unintentionally.
- ▶ Shift into **1st gear** on vehicles with manual transmission or move the selector lever to the P position on vehicles with automatic transmission.
- ▶ Find the **marking** (imprint) on the sill that is nearest the wheel that will be changed

⇒ *fig. 203*. Behind the marking, there is a **lifting point** on the sill for the vehicle jack.

- ▶ Turn the **vehicle jack** located under the lifting point on the sill to raise the jack until the jaw ⇒ *fig. 204* (A) covers the **notch** on the vehicle ⇒ ⚠ ⇒ ⚠.
- ▶ Align the vehicle jack so the jaw (A) covers the notch and the base plate (B) is flat on the floor. The base plate (B) must be *vertical* under the lifting point (A).
- ▶ Install the rod on the vehicle jack: Insert the rod into the opening on the handwheel. Turn the rod left or right to secure it.
- ▶ Continue raising the jack with the rod until the wheel lifts off the ground slightly.

Position the vehicle jack **only** under the designated lifting points on the sill ⇒ *fig. 203*.

There is exactly *one* location for each wheel. The jack must not be positioned at any other location ⇒ ⚠ ⇒ ⚠.

**Soft ground** under the jack can cause the vehicle to slip off the jack. Always place the jack on firm ground. Use a flat, stable support if necessary. Use a non-slip surface such as a rubber mat on a **slippery surface** such as tile.

### ⚠ WARNING

- You or your passengers could be injured while changing a wheel if you do not follow these safety precautions:
  - Position the vehicle jack only at the designated lifting points and align the jack. Otherwise, the vehicle jack could slip and cause an injury if it does not have sufficient hold on the vehicle.
  - A soft or unstable surface under the jack may cause the vehicle to slip off the jack. Always provide a firm base for the jack on the ground. If necessary, use a sturdy board under the jack.
  - On hard, slippery surface (such as tiles) use a rubber mat or similar to prevent the jack from slipping.
- To help prevent injury to yourself and your passengers:

- Do not raise the vehicle until you are sure the jack is securely engaged.
- Passengers must not remain in the vehicle when it is jacked up.
- Make sure that passengers wait in a safe place away from the vehicle and well away from the road and traffic.
- Make sure jack position is correct, adjust as necessary and then continue to raise the jack.

### ⚠ Note

Do not lift the vehicle by the sill. Position the vehicle jack only at the designated lifting points on the sill. Otherwise, your vehicle will be damaged.

## Taking the wheel off/installing the spare tire

Follow these instructions step-by-step for changing the wheel.



**Fig. 205** Changing a wheel: using the screwdriver handle (with the blade removed) to turn the bolts



**Fig. 206** Changing a wheel: alignment pin inside the top hole

After you have loosened all wheel bolts and raised the vehicle off the ground, remove and replace the wheel as follows: ▶

## Removing the wheel

- ▶ Remove the topmost wheel bolt completely with the **hexagonal socket** in the screwdriver handle (vehicle tool kit) ⇒ *fig. 205* and set it aside on a *clean* surface.
- ▶ Screw the threaded end of the **alignment pin** from the tool kit hand-tight into the empty bolt hole ⇒ *fig. 206*.
- ▶ Then remove the other wheel bolts as described above.
- ▶ Take off the wheel leaving the alignment pin in the bolt hole ⇒ .

## Putting on the spare tire

- ▶ allroad: Inflate the inflatable spare tire ⇒ *page 262*
- ▶ Push the spare tire over the alignment pin.
- ▶ Screw on the wheel bolts and tighten them *slightly* using the hexagonal socket.
- ▶ Remove the alignment pin and insert and tighten the remaining wheel bolt slightly like the rest.
- ▶ Turn the jack handle counter-clockwise to lower the vehicle until the jack is fully released.
- ▶ Use the wheel bolt wrench to tighten all wheel bolts firmly ⇒ *page 265*. Tighten them *in a crisscross pattern*, from one bolt to the (approximately) opposite one, to keep the wheel centered.
- ▶ Perform the steps required after changing the wheel ⇒ *page 264, After changing a wheel*.

The hexagonal socket makes it easier to remove the wheel bolts from the rim. Care should be taken when removing the reversible blade.

### Note

When removing or installing the wheel, the rim could hit the brake rotor and damage the rotor. Work carefully and have a second person to help you.

### Tips

- When mounting tires with **unidirectional tread design** make sure the tread pat-

tern is pointed the right way

⇒ *page 267*.

- The wheel bolts should be clean and easy to turn. Check for dirt and corrosion on the mating surfaces of both the wheel and the hub. Remove all dirt from these surfaces before remounting the wheel.
- Do not use the hexagonal socket in the screwdriver handle to loosen or tighten the wheel bolts.

## Tires with unidirectional tread design

*Tires with unidirectional tread design must be mounted with their tread pattern pointed in the right direction.*

## Using a spare tire with a tread pattern intended for use in a specific direction

When using a spare tire with a tread pattern intended for use in a specific direction, please note the following:

- The direction of rotation is marked by an **arrow on the side of the tire**.
- If the spare tire has to be installed in the incorrect direction, use the spare tire only temporarily since the tire will not be able to achieve its optimum performance characteristics with regard to aquaplaning, noise and wear.
- We recommend that you pay particular attention to this fact during wet weather and that you adjust your speed to match road conditions.
- Replace the flat tire with a new one and have it installed on your vehicle as soon as possible to restore the handling advantages of a unidirectional tire.

## Notes on wheel changing

Please read the information ⇒ *page 248, New tires and replacing tires and wheels* if you are going to use a spare tire which is different from the tires on your vehicle.

After you change a tire: 

- Check the tire pressure on the spare immediately after installation.
- Have the wheel bolt tightening torque checked with a torque wrench as soon as possible by your authorized Audi dealer or qualified workshop.
- With steel and alloy wheel rims, the wheel bolts are correctly tightened at a torque of 90 ft lbs. (120 Nm).
- If you notice that the wheel bolts are corroded and difficult to turn while changing a tire, they should be replaced before you check the tightening torque.
- Replace the flat tire with a new one and have it installed on your vehicle as soon as possible. Remount the wheel cover.

Until then, drive with extra care and at reduced speeds.

system\* will have to be replaced by qualified workshop.

#### WARNING

- If you are going to equip your vehicle with tires or rims which differ from those which were factory installed, then be sure to read the information ⇒ *page 248, New tires and replacing tires and wheels.*
- Always make sure the damaged wheel or even a flat tire and the jack and tool kit are properly secured in the luggage compartment and are not loose in the passenger compartment.
- In an accident or sudden maneuver they could fly forward, injuring anyone in the vehicle.
- Always store damaged wheel, jack and tools securely in the luggage compartment. Otherwise, in an accident or sudden maneuver they could fly forward, causing injury to passengers in the vehicle.

#### Note

Do not use commercially available tire sealants. Otherwise, the electrical components of the tire pressure monitoring system\* will no longer work properly and the sensor for the tire pressure monitoring

# Fuses and bulbs

## Fuses

### Replacing a fuse

Fuses that have blown will have metal strips that have burned through.

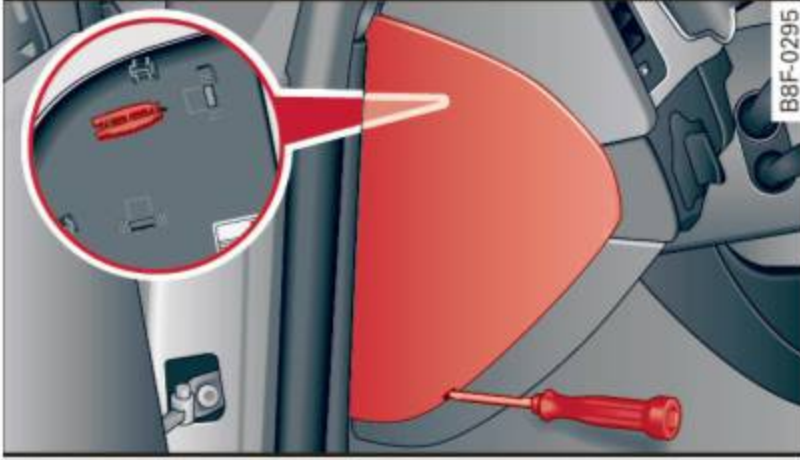

Fig. 207 Left cockpit: fuse panel cover

The fuses are located at the front left and right of the cockpit and behind the trim on the right side of the luggage compartment.

- ▶ Turn off the ignition and the affected electrical consumers.
- ▶ Check the following table to see which fuse belongs to the consumer.
- ▶ Remove the appropriate cover ⇒ *fig. 207* or ⇒ *page 211, fig. 178*.
- ▶ To remove the purple plastic clip if necessary <sup>1)</sup>, hold onto it at the small side and pull it out of the fuse panel ⇒ *page 269, fig. 208*.
- ▶ Remove the clamp from the rear side of the fuse cover ⇒ *fig. 207*.
- ▶ Remove the fuse using the clamp and replace the blown fuse with an identical new one.

### WARNING

Do not repair fuses and never replace a blown fuse with one that has a higher amp rating. This can cause damage to the electrical system and a fire.

### Note

If a new fuse burns out again after shortly have you have installed it, have the electrical system checked by your authorized Audi dealer.

### Tips

- The following table does not list fuse locations that are not used.
- Some of the equipment items listed are optional or only available on certain model configurations.

### Left cockpit fuse assignment

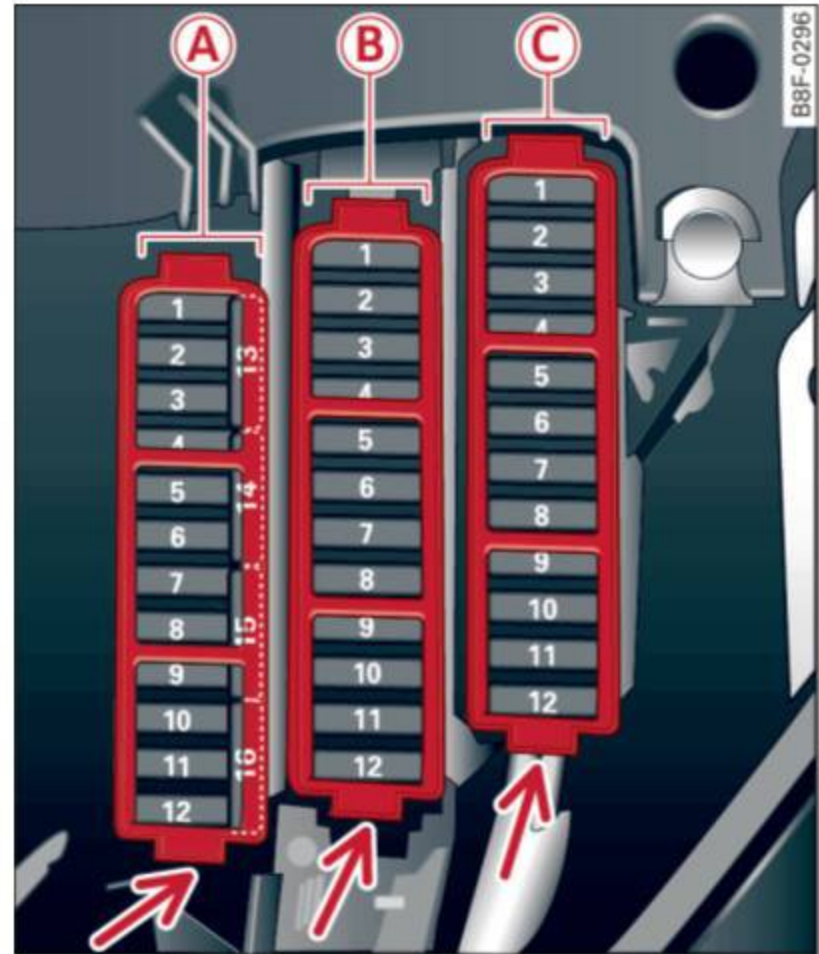

Fig. 208 Left cockpit: fuse panel with plastic clip

### Fuse panel **A** (black)

No.	Consumer	Amps
1	Dynamic steering	5
2	Electronic Stabilization Control (module)	5

<sup>1)</sup> You can dispose of the plastic clip after removing it.

No.	Consumer	Amps
3	A/C system pressure sensor, electromechanical parking brake, HomeLink, automatic dimming interior rear view mirror, air quality/outside air sensor, Electronic Stabilization Control (button)	5
5	Sound actuator	5
6	Headlight range control/headlight (cornering light)	5/7,5
7	Headlight (cornering light)	7,5
8	Control modules (electromechanical parking brake, shock absorber, quattro sport), DCDC converter	5
9	Adaptive cruise control	5
10	Shift gate/clutch sensor	5
11	Side assist	5
12	Headlight range control, parking system	5
13	Airbag	5
14	Rear wiper (allroad)	15
15	Auxiliary fuse (instrument panel)	10
16	Auxiliary fuse terminal 15 (engine area)	40

#### Fuse panel **(B)** (brown)

No.	Consumer	Amps
2	Brake light sensor	5
3	Fuel pump	25
4	Clutch sensor	5
5	Left seat heating with/without seat ventilation	15/30
6	Electronic Stabilization Control (electric)	5
7	Horn	15
8	Front left door (window regulator, central locking, mirror, switch, lighting)	30
9	Windshield wiper motor	30
10	Electronic Stabilization Control (valves)	25

No.	Consumer	Amps
11	Two-door models: rear left window regulator; Four-door models: rear left door (window regulator, central locking, switch, lighting)	30
12	Rain and light sensor	5

#### Fuse panel **(C)** (red)

No.	Consumer	Amps
3	Lumbar support	10
4	Dynamic steering	35
5	Interior lighting (Cabriolet)	5
6	Windshield washer system, headlight washer system	35
7	Vehicle electrical system control module 1	20
8	Vehicle electrical system control module 1	30
9	Left rear window regulator motor (Cabriolet)/sunroof	7,5/20
10	Vehicle electrical system control module 1	30
11	Right rear window regulator (Cabriolet)/sun shade motor	7,5/20
12	Anti-theft alarm warning system	5

**Right cockpit fuse assignment**

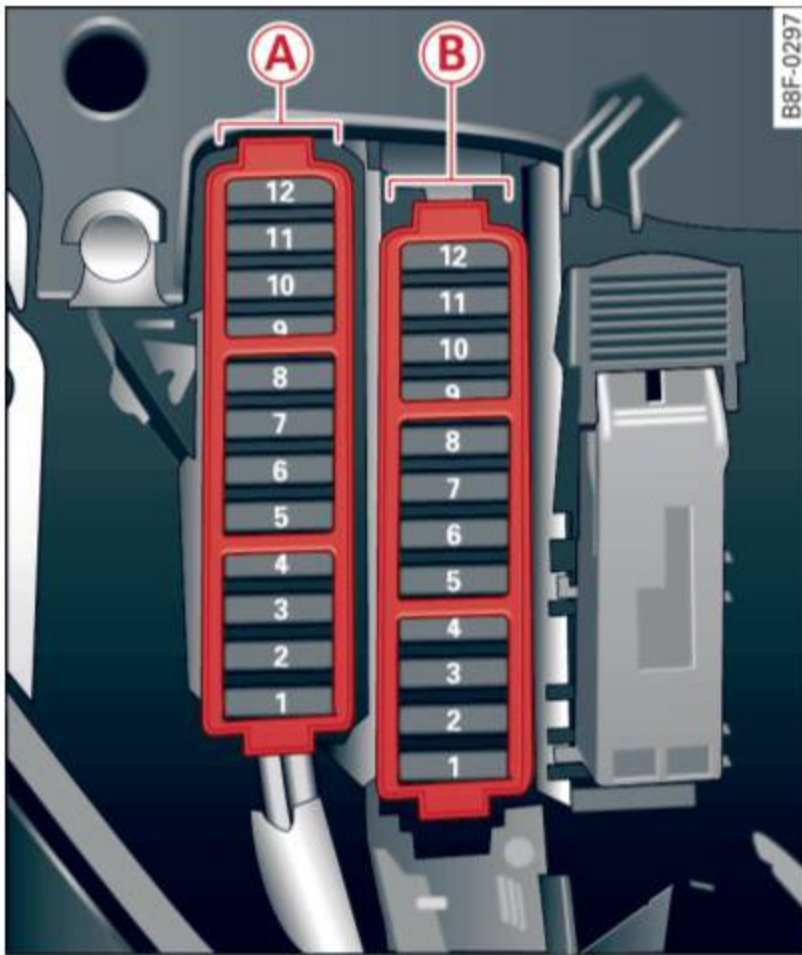

Fig. 209 Right cockpit: fuse panel with plastic clip

**Fuse panel A (black)**

No.	Consumer	Amps
5	Steering column switch module	5
7	Terminal 15 diagnostic connector	5
8	Gateway (Databus diagnostic interface)	5
9	Supplementary heater	5

**Fuse panel B (brown)**

No.	Consumer	Amps
1	CD/DVD player	5
2	Wi-Fi	5
3	MMI/Radio	5/20
4	Instrument cluster	5
5	Gateway (instrument cluster control module)	5
6	Ignition lock	5
7	Light switch	5
8	Climate control system blower	40
9	Steering column lock	5

No.	Consumer	Amps
10	Climate control system	10
11	Terminal 30 diagnostic connector	10
12	Steering column switch module	5

**Right luggage compartment fuse assignment**

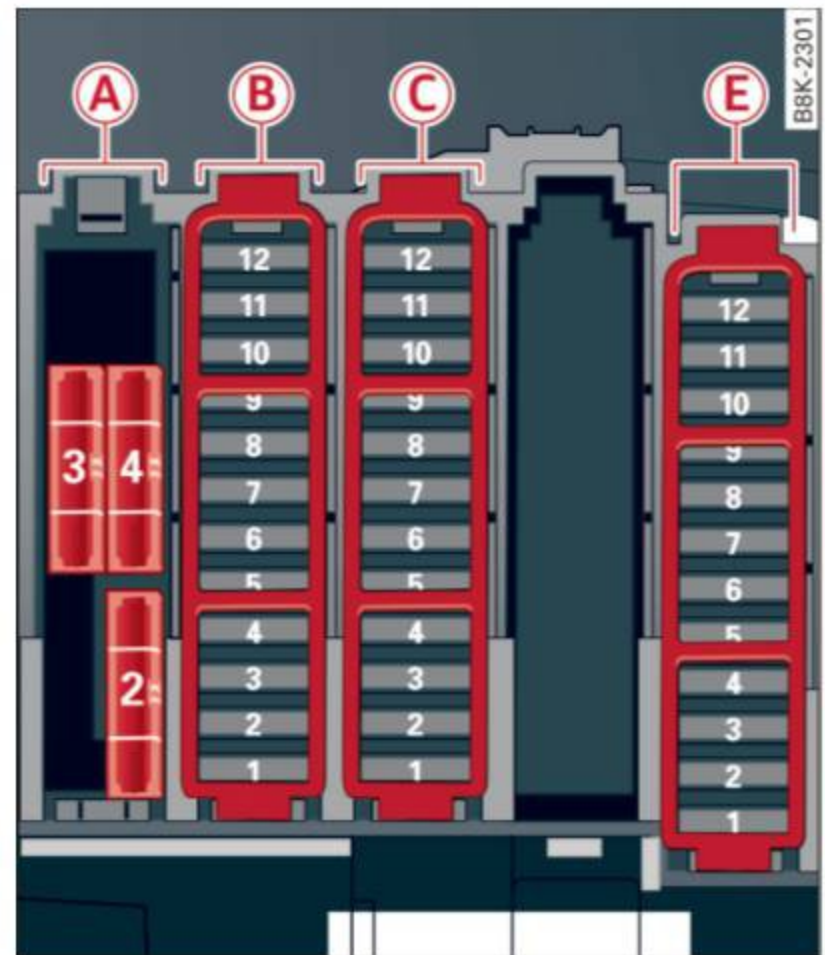

Fig. 210 Right luggage compartment: fuse panel with plastic clip

**Fuse panel A (black)**

No.	Consumer	Amps
2	Rear window heater (Cabriolet)	30
3	Power top latch (Cabriolet)	30
4	Power top hydraulics (Cabriolet)	50

**Fuse panel B (black)**

No.	Consumer	Amps
1	Luggage compartment lid control module (allroad)/ Power top control module (Cabriolet)	30/10
2	Retractable rear spoiler (RS 5 Coupe)	10

No.	Consumer	Amps
5	Electromechanical parking brake	5
6	Electronic damping control	15
7	Electromechanical parking brake	30
8	Rear exterior lighting	30
9	quattro sport	35
10	Rear exterior lighting	30
11	Central locking	20
12	Terminal 30	5

### Fuse panel **C** (brown)

No.	Consumer	Amps
1	Luggage compartment lid control module (allroad)	30
2	12-volt socket, cigarette lighter	20
3	DCDC converter path 1	40
4	DCDC converter path 2, sound amplifier, radio	30
6	Right upper cabin heating (Cabriolet)	30
7	Electromechanical parking brake	30
9	Right front door (window regulator, central locking, mirror, switch, lighting)	30
10	Left upper cabin heating (Cabriolet)	30
11	Two-door models: rear right window regulator; Four-door models: rear right door (window regulator, central locking, switch, lighting)	30
12	Cell phone prep	5

### Fuse panel **E** (black)

No.	Consumer	Amps
1	Right front seat heating	15
4	MMI	7,5
5	Radio	5
6	Rear view camera	5

No.	Consumer	Amps
7	Rear window heater (all-road)	30
8	Rear Seat Entertainment	5

## Bulbs

### Replacing bulbs

*For your safety, we recommend that you have your authorized Audi dealer replace any bulbs for you.*

It is becoming increasingly more and more difficult to replace vehicle light bulbs since in many cases, other parts of the car must first be removed before you are able to get to the bulb. This applies especially to the light bulbs in the front of your car which you can only reach through the engine compartment.

Sheet metal and bulb holders can have sharp edges that can cause serious cuts, parts must be correctly taken apart and then properly put back together to help prevent breakage of parts and long term damage from water that can enter housings that have not been properly resealed.

For your safety, we recommend that you have your authorized Audi dealer replace any bulbs for you, since your dealer has the proper tools, the correct bulbs and the expertise.

### Gas discharge lamps (Xenon lights)\*:

Due to the high electrical voltage, have the bulbs replaced by a qualified technician. Headlights with Xenon light are identified by the high voltage sticker.

### WARNING

Changing Xenon lamps without the necessary equipment can cause serious personal injury.

- Bulbs are pressurized and can explode when being changed. Potential risk of injury!

- On vehicles equipped with gas discharge bulbs (Xenon light)\* life-threatening injuries can result from improper handling of the high-voltage portions of such lamps!
- Only your authorized Audi dealer or qualified workshop should change the bulbs in gas discharge lamps. There are parts with sharp edges on the openings and on the bulb holders that can cause serious cuts. If you are uncertain about what to do, have the work performed by an authorized Audi dealer or qualified workshop. Serious personal injury may result from improperly performed work.

### Tips

- If you still prefer to replace the light bulbs yourself, be aware that the engine compartment is a hazardous area to work in ⇒ *page 212* ⇒ .
- It is best to ask your authorized Audi dealer whenever you want to change a bulb.

## Emergency situations

### General

This chapter is intended for trained emergency crews and working personnel who have the necessary tools and equipment to perform these operations.

### Starting by pushing or towing

#### Note

Vehicles with an automatic transmission cannot be started by pushing or towing.

### Starting with jumper cables

*If necessary, the engine can be started by connecting it to the battery of another vehicle.*

If the engine should fail to start because of a discharged or weak battery, the battery can be connected to the battery of *another* vehicle, using a **pair of jumper cables** to start the engine.

#### Jumper cables

Use *only* jumper cables of sufficiently large **cross section** to carry the starter current safely. Refer to the manufacturer's specifications.

Use only jumper cables with *insulated* terminal clamps which are distinctly marked:

**plus (+) cable** in most cases colored **red**

**minus (-) cable** in most cases colored **black**.

#### WARNING

Batteries contain electricity, acid, and gas. Any of these can cause very serious or fatal injury. Follow the instructions below for safe handling of your vehicle's battery.

- Always shield your eyes and avoid leaning over the battery whenever possible.

- A discharged battery can freeze at temperatures just below 32 °F (0 °C). Before connecting a jumper cable, you must thaw the frozen battery completely, otherwise it could explode.
- Do not allow battery acid to contact eyes or skin. Flush any contacted area with water immediately.
- Improper use of a booster battery to start a vehicle may cause an explosion.
- Vehicle batteries generate explosive gases. Keep sparks, flame and lighted cigarettes away from batteries.
- Do not try to jump start any vehicle with a low acid level in the battery.
- The voltage of the booster battery must also have a 12-Volt rating. The capacity (Ah) of the booster battery should not be lower than that of the discharged battery. Use of batteries of different voltage or substantially different "Ah" rating may cause an explosion and personal injury.
- Never charge a frozen battery. Gas trapped in the ice may cause an explosion.
- Never charge or use a battery that has been frozen. The battery case may have been weakened.
- Use of batteries of different voltage or substantially different capacity (Ah) rating may cause an explosion and injury. The capacity (Ah) of the booster battery should not be lower than that of the discharged battery.
- Before you check anything in the engine compartment, always read and heed all WARNINGS ⇒ *page 212*.

#### Note

- Applying a higher voltage booster battery will cause expensive damage to sensitive electronic components, such as control units, relays, radio, etc.
- There must be no electrical contact between the vehicles as otherwise current could already start to flow as soon as the positive (+) terminals are connected.

**i Tips**

The discharged battery must be properly connected to the vehicle's electrical system. When jump starting or charging the battery, never connect the negative ground cable to the battery negative post because the battery manager system must be able to detect the battery's state of charge. Always connect the negative ground cable to the negative ground post of the battery manager control unit.

**Use of jumper cables**

Make sure to connect the jumper cable clamps in exactly the order described below!

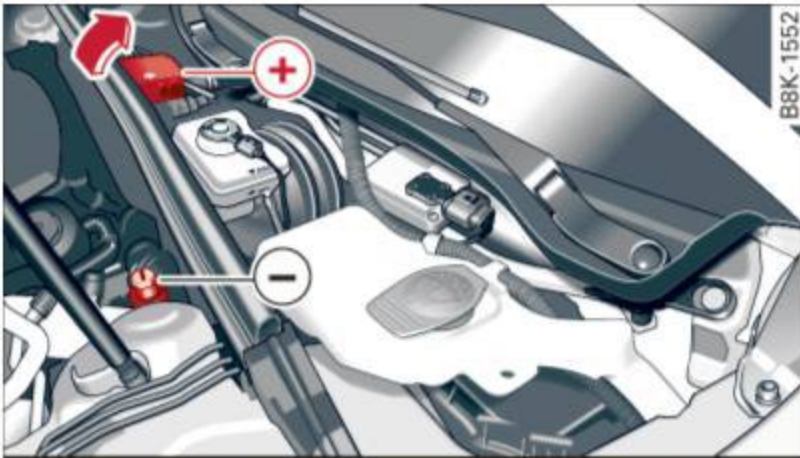

Fig. 211 Engine compartment: Connectors for jumper cables and charger

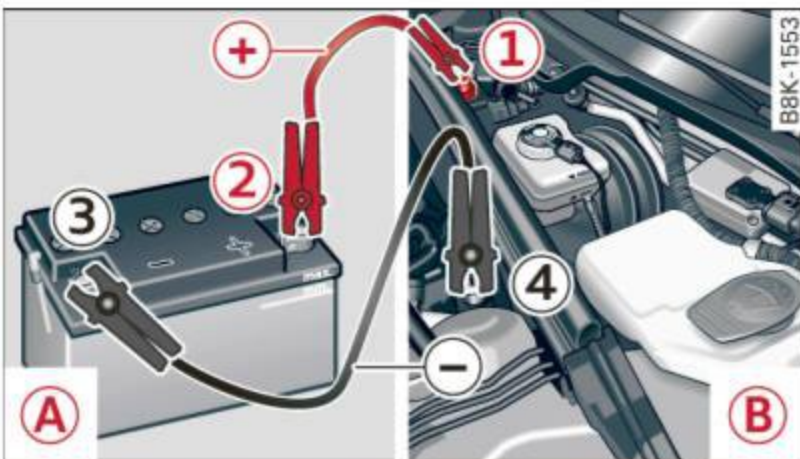

Fig. 212 Jump starting with the battery of another vehicle: (A) booster battery, (B) discharged vehicle battery

The procedure described below for connecting jumper cables is intended to provide a jump start for your vehicle.

**Vehicle with discharged battery:**

- ▶ Turn off lights and accessories, move lever of automatic transmission to N (Neutral) or P (Park) and set parking brake.

**Connect POSITIVE (+) to POSITIVE (+) (red)**

- ▶ Remove the cover above the jump start connection.
  - ▶ Open the cover on the positive pole ⇒ fig. 211.
1. Connect one end of the red positive cable on the **jump start bolt** ⇒ fig. 212 (1) (Bolts under cover = "positive") of the vehicle to be started (B).
  2. Connect the other end to the positive terminal (2) of the booster battery (A).

**Connect NEGATIVE (-) to NEGATIVE (-) (black)**

3. Connect one end of the black negative cable to the negative terminal (3) of the booster battery (A).
4. Connect the other end to the **jump start bolt** (4) (Bolts with hex head = "negative") of the vehicle to be started (B).

**Starting the engine**

- ▶ Start the engine of the vehicle with the booster battery (A). Run the engine at a moderate speed.
- ▶ Start engine with discharged vehicle battery (B) in the usual manner.
- ▶ If the engine fails to start: do not keep the starter cranking for longer than 10 seconds. Wait for about 30 seconds and then try again.
- ▶ With engine running, remove jumper cables from both vehicles in the exact reverse order.
- ▶ Close the cover on the positive pole.

The battery is vented to the outside to prevent gases from entering the vehicle interior. Make sure that the jumper clamps are well connected with their *metal parts in full contact* with the battery terminals.

**⚠ WARNING**

To avoid serious personal injury and damage to the vehicle, heed all warnings and instructions of the jumper cable manufacturer. If in doubt, call for road service.

- Jumper cables must be long enough so that the vehicles do not touch.
- When connecting jumper cables, make sure that they cannot get caught in any moving parts in the engine compartment.
- Do not bend over the batteries - danger of chemical burns!
- The battery cell locking screws must be tightened securely.
- Before you check anything in the engine compartment, always read and heed all WARNINGS ⇒ *page 212*.

### Note

Improper hook-up of jumper cables can ruin the generator.

- Always connect POSITIVE (+) to POSITIVE (+), and NEGATIVE (-) to NEGATIVE (-) ground post of the battery manager control unit.
- Check that all screw plugs on the battery cells are screwed in firmly. If not, tighten plugs prior to connecting clamp on negative battery terminal.
- Please note that the procedure for connecting a jumper cable as described above applies specifically to the case of your vehicle being jump started. When you are giving a jump start to another vehicle, do *not* connect the negative (-) cable to the negative (-) terminal on the discharged battery  ⇒ *fig. 212*. Instead, securely connect the negative (-) cable to either a solid metal component that is firmly bolted to the engine block or to the engine block itself. If the battery that is being charged does not vent to the outside, escaping battery gas could ignite and explode!

## Emergency towing with commercial tow truck

### General hints

*Your Audi requires special handling for towing.*

The following information is to be used by commercial tow truck operators who know how to operate their equipment safely.

- **Never tow your Audi, towing will cause damage to the engine and transmission.**
- **Never wrap the safety chains or winch cables around the brake lines.**
- **To prevent unnecessary damage, your Audi must be transported with a flat bed truck.**
- **To load the vehicle on to the flat bed, use the towing loop found in the vehicle tools and attach to the front or rear anchorage** ⇒ *page 277* and ⇒ *page 277*.



### WARNING

A vehicle being towed is not safe for passengers. Never allow anyone to ride in a vehicle being towed, for any reason.

### Front towing loop

Do not install the front towing loop until it is needed.



Fig. 213 Front bumper: removing the cover cap



Fig. 214 Front bumper: screwing in the towing loop

The towing loop fits into the threaded hole located on the right side of the front bumper and covered by a small cover when not in use.

- ▶ Remove the towing loop from the vehicle toolkit ⇒ *page 260*.
- ▶ Press the cover in by applying short strong pressure to the bottom part to release it from the bumper ⇒ *fig. 213*.
- ▶ Screw the towing loop tightly into the threaded hole as far as it will go ⇒ *fig. 214* and tighten it with the wheel wrench.

When it is no longer needed, unscrew the towing loop and put it back into the vehicle toolkit. Be sure to have the towing loop stored in the vehicle at all times.

#### WARNING

If the towing loop is not screwed in as far as it will go, the thread can pull out when the vehicle is towed - potential risk of an accident.

### Rear towing loop

Do not install the rear towing loop until it is needed.



Fig. 215 Rear bumper: cover



Fig. 216 Rear bumper: Screwing in towing loop

On the right side of the rear bumper there is a threaded hole for the towing loop. The threaded hole is protected by a cover.

- ▶ Remove the towing loop from the vehicle toolkit ⇒ *page 260*.
- ▶ Press the cover in by applying short strong pressure to the bottom part to release it from the bumper ⇒ *fig. 215*.
- ▶ Screw the towing loop tightly into the threaded hole as far as it will go ⇒ *fig. 216* and tighten it with the wheel wrench.

Unscrew the towing loop again after use and install the cover in the bumper. Install the cover in the bumper. Return the towing loop to the toolkit. Be sure to have the towing loop stored in the vehicle at all times.

#### WARNING

If the towing loop is not screwed in as far as it will go, the thread can pull out when the vehicle is towed - potential risk of an accident.

### Loading the vehicle onto a flat bed truck

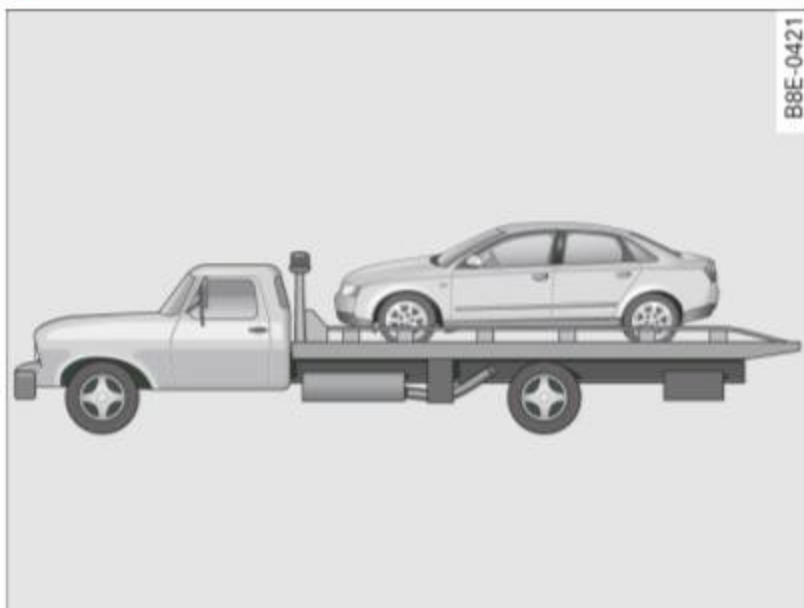

Fig. 217 Vehicle on flat bed truck

#### Front hook up

- ▶ Align the vehicle with the centerline of the car carrier ramp.
- ▶ Attach the winch hook to the front towline eye previously installed.

#### Rear hook up

- ▶ Align the vehicle with the centerline of the car carrier ramp.
- ▶ Attach the winch hook to the rear towline eye previously installed.

#### Tips

Check carefully to make sure the hook-up is secure before moving the car up the flat-bed truck ramp.

## Lifting vehicle

### Lifting with workshop hoist and with floor jack

The vehicle may only be lifted at the lifting points illustrated.

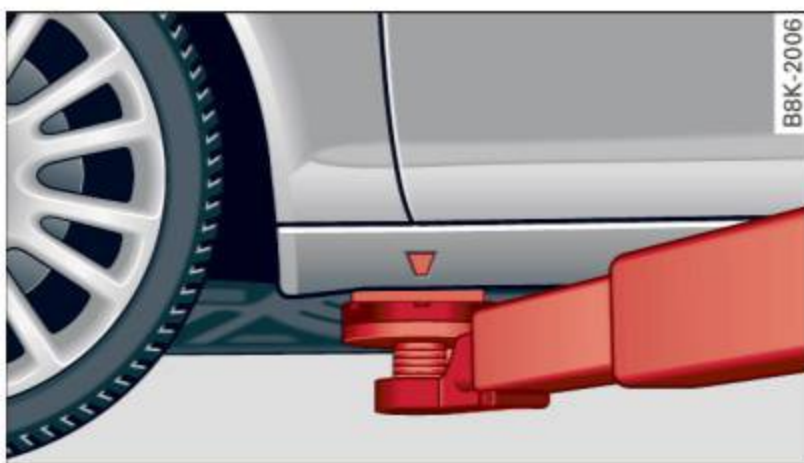

Fig. 218 Front lifting point

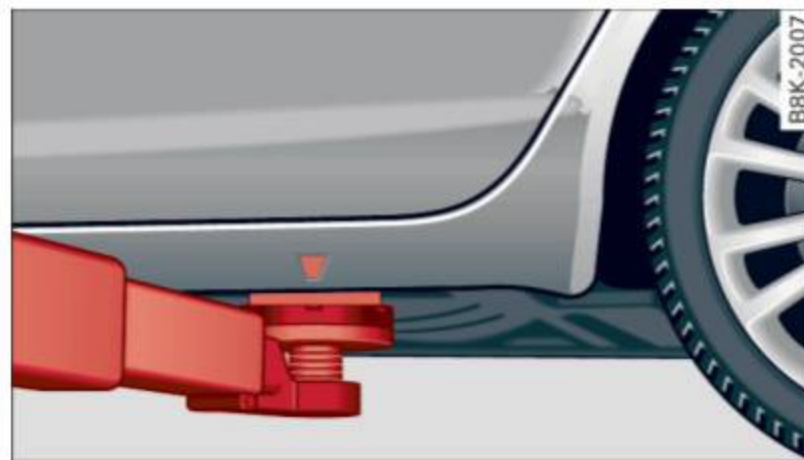



Fig. 219 Rear lifting point

- ▶ Read and heed WARNING .
- ▶ Locate lifting points  $\Rightarrow$  fig. 218 and  $\Rightarrow$  fig. 219.
- ▶ Adjust lifting arms of workshop hoist or floor jack to match vehicle lifting points.
- ▶ Insert a rubber pad between the floor jack/workshop hoist and the lifting points.

**If you must lift your vehicle with a floor jack to work underneath, be sure the vehicle is safely supported on stands intended for this purpose.**

#### Front lifting point

The lifting point is located on the floor pan reinforcement about at the same level as the jack mounting point  $\Rightarrow$  fig. 218. **Do not lift the vehicle at the vertical sill reinforcement.**

#### Rear lifting point

The lifting point is located on the vertical reinforcement of the lower sill for the onboard jack  $\Rightarrow$  fig. 219.

#### Lifting with vehicle jack

Refer to  $\Rightarrow$  page 265.

#### WARNING

- To reduce the risk of serious injury and vehicle damage.
- Always lift the vehicle only at the special workshop hoist and floor jack lift points illustrated  $\Rightarrow$  fig. 218 and  $\Rightarrow$  fig. 219.
- Failure to lift the vehicle at these points could cause the vehicle to tilt or fall from a lift if there is a change in vehicle weight distribution and balance.

This might happen, for example, when heavy components such as the engine block or transmission are removed.

- When removing heavy components like these, anchor vehicle to hoist or add corresponding weights to maintain the center of gravity. Otherwise, the vehicle might tilt or slip off the hoist, causing serious personal injury.

### Note

- Be aware of the following points before lifting the vehicle:
  - **The vehicle should never be lifted or jacked up from underneath the engine oil pan, the transmission housing, the front or rear axle or the body side members. This could lead to serious damage.**
  - **To avoid damage to the underbody or chassis frame, a rubber pad must be inserted between the floor jack and the lift points.**
  - **Before driving over a workshop hoist, check that the vehicle weight does not exceed the permissible lifting capacity of the hoist.**
  - **Before driving over a workshop hoist, ensure that there is sufficient clearance between the hoist and low parts of the vehicle.**

## Technical Data

### Vehicle identification

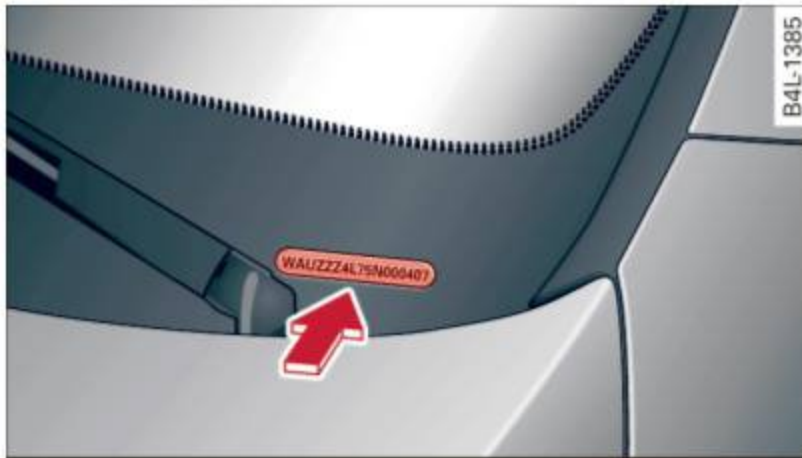

Fig. 220 Vehicle Identification Number (VIN) plate: location on driver's side dash panel

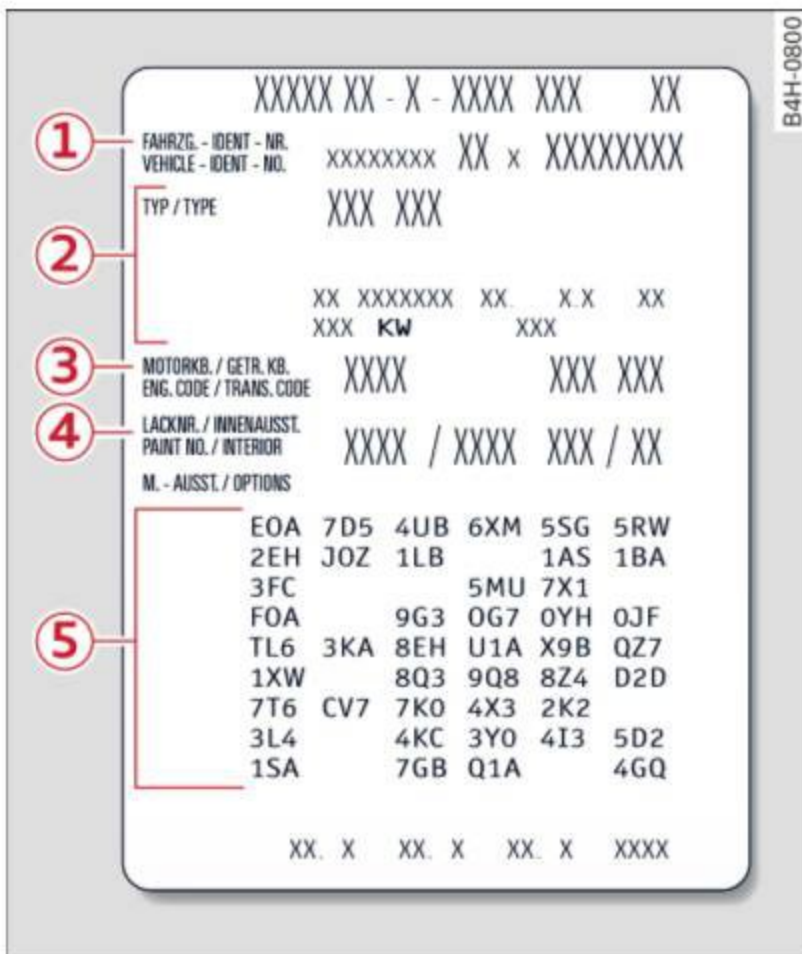

Fig. 221 The vehicle identification label: inside the luggage compartment

#### Vehicle Identification Number (VIN)

The Vehicle Identification Number is located in different places:

- under the windshield on the driver's side  
⇒ *fig. 220*.
- in the radio or in the MMI\*: Select:  CAR function button > **Vehicle ID number (VIN)** or select:  CAR function button > **Car systems\*** control button > **Servicing & checks** > **VIN number**.
- on the vehicle identification label.

#### Vehicle identification label

The vehicle identification label is located in the luggage compartment near the battery.

The label ⇒ *fig. 221* shows the following vehicle data:

- ① Vehicle Identification Number (VIN)
- ② Vehicle type, engine output, transmission
- ③ Engine and transmission code
- ④ Paint number and interior
- ⑤ Optional equipment numbers

The information of the vehicle identification label can also be found in your Warranty & Maintenance booklet.

#### Safety compliance sticker

The safety compliance sticker is your assurance that your new vehicle complies with all applicable Federal Motor Vehicle Safety Standards which were in effect at the time the vehicle was manufactured. You can find this sticker on the door jamb on the driver's side. It shows the month and year of production and the vehicle identification number of your vehicle (perforation) as well as the Gross Vehicle Weight Rating (GVWR) and the Gross Axle Weight Rating (GAWR).

#### High voltage warning label

The high voltage warning label is located in the engine compartment next to the engine hood release. The spark ignition system complies with the Canadian standard ICES-002.

## Weights

#### Gross Vehicle Weight Rating

The Gross Vehicle Weight Rating (GVWR), and the Gross Axle Weight Rating (GAWR) for front and rear are listed on a sticker on the door jamb on the driver's side.

The Gross Vehicle Weight Rating includes the weight of the basic vehicle plus full fuel tank, oil and coolant, plus maximum load, which includes passenger weight (150 lbs/68 kg per designated seating position) and luggage weight ⇒ ⚠.

### Gross Axle Weight Rating

The Gross Axle Weight Rating is the maximum load that can be applied at each axle of the vehicle ⇒ ⚠.

### Vehicle capacity weight

The vehicle capacity weight (max. load) is listed on the driver's side B-pillar.

#### ⚠ WARNING

- The actual Gross Axle Weight Rating at the front and rear axles should not exceed the permissible weights, and their combination must not exceed the Gross Vehicle Weight Rating.

- Exceeding permissible weight ratings can result in vehicle damage, accidents and personal injury.

#### ! Note

- The vehicle capacity weight figures apply when the load is distributed evenly in the vehicle (passengers and luggage). When transporting a heavy load in the luggage compartment, carry the load as near to the rear axle as possible so that the vehicle's handling is not impaired.
- Do not exceed the maximum permissible axle loads or the maximum gross vehicle weight. Always remember that the vehicle's handling will be affected by the extra load. Therefore, adjust your speed accordingly.
- Always observe local regulations.

## Dimensions

		A4 Sedan	S4 Sedan	allroad
Length	in (mm)	185.1 (4701)	185.7 (4716)	185.9 (4721)
Width	in (mm)	71.9 (1826)	71.9 (1826)	72.5 (1841)
Width (across mirrors)	in (mm)	80.3 (2040)	80.3 (2040)	78.9 (2006)
Height (unloaded) <sup>a)</sup>	in (mm)	56.2 (1427)	55.4 (1406)	58.0 (1473)

<sup>a)</sup> The height of the vehicle depends on the tires and the suspension.

When driving up steep ramps, on rough roads, over curbs, etc. it is important to remember that some parts of your vehicle, such as spoil-

ers or exhaust system components, may be close to the ground. Be careful not to damage them.

## Capacities

Fuel tank: total capacity	gal (liters)	16.1 (61.0)
Windshield and headlight* washer fluid container	quarts (liters)	4.8 (4.5)

## Gasoline engines

### A4 Sedan 2.0, 4 cylinder

Maximum output SAE net	hp @ rpm	220 @ 4450-6000
Maximum torque SAE net	lb-ft @ rpm	259 @ 1500-4300
Displacement	CID (cm <sup>3</sup> )	121 (1984)
Engine oil with filter change	quarts (liters)	4.9 (4.6)
Fuel	<b>Premium unleaded (91 AKI)</b> ⇒ page 207, <i>Gasoline</i> or <b>Bio-ethanol (E85)</b> ⇒ page 208, <i>Ethanol fuel (Bio-ethanol)</i> .	

### allroad 2.0, 4 cylinder

Maximum output SAE net	hp @ rpm	220 @ 4450-6000
Maximum torque SAE net	lb-ft @ rpm	259 @ 1500-4300
Displacement	CID (cm <sup>3</sup> )	121 (1984)
Engine oil with filter change	quarts (liters)	4.9 (4.6)
Fuel	<b>Premium unleaded (91 AKI)</b> ⇒ page 207, <i>Gasoline</i> or <b>Bio-ethanol (E85)</b> ⇒ page 208, <i>Ethanol fuel (Bio-ethanol)</i> .	

### S4 Sedan 3.0, 6 cylinder

Maximum output SAE net	hp @ rpm	333 @ 5500-6500
Maximum torque SAE net	lb-ft @ rpm	325 @ 2900-5300
Displacement	CID (cm <sup>3</sup> )	182.8 (2995)
Engine oil with filter change	quarts (liters)	7.2 (6.8)
Fuel	<b>Premium unleaded (91 AKI)</b> ⇒ page 207, <i>Gasoline</i>	

## Consumer Information

### Warranty coverages

Your Audi is covered by the following warranties:

- *New Vehicle Limited Warranty*
- *Limited Warranty Against Corrosion Performance*
- *Emissions Control System Warranty*
- *Emissions Performance Warranty*
- *California Emissions Control Warranty (USA vehicles only)*
- *California Emissions Performance Warranty (USA vehicles only)*

Detailed information regarding your warranties can be found in your **Warranty & Maintenance booklet**.

### Operating your vehicle outside the U.S.A. or Canada

Government regulations in the United States and Canada require that automobiles meet specific emission regulations and safety standards. Therefore, vehicles built for the U.S.A. and Canada differ from vehicles sold in other countries.

If you plan to take your vehicle outside the continental limits of the United States or Canada, there is the possibility that:

- unleaded fuels for vehicles with catalytic converter may not be available;
- fuel may have a considerably lower octane rating. Improper fuel may cause engine damage;
- service may be inadequate due to lack of proper service facilities, tools or testing equipment;
- replacement parts may not be readily available.
- Navigation systems for vehicles built for the U.S.A. and Canada will not necessarily work in Europe, and may not work in other countries outside of North America.

#### Note

Audi cannot be responsible for mechanical damage that could result from inadequate fuel, service or parts availability.

### Audi Service Repair Manuals and Literature

Audi Official Factory Service Manuals and Literature are published as soon as possible after model introduction. Service manuals and literature are available to order from the Audi Technical Literature Ordering Center at:

[www.audi.techliterature.com](http://www.audi.techliterature.com)

### Maintenance

#### General

Your vehicle has been designed to help keep maintenance requirements to a minimum. However, a certain amount of regular maintenance is still necessary to assure your vehicle's safety, economy and reliability. For detailed vehicle maintenance consult your Warranty & Maintenance booklet.

**Under difficult operating conditions**, for example at extremely low outside temperatures, in very dusty regions, when towing a trailer very frequently, etc., some service work should be performed between the intervals specified. This applies particularly to:

- oil changes, and
- cleaning or replacing the air filter.

#### For the sake of the environment

By regularly maintaining your vehicle, you help make sure that emission standards are maintained, thus minimizing adverse effects on the environment.

#### Important considerations for you and your vehicle

The increasing use of electronics, sophisticated fuel injection and emission control systems, and the generally increasing technical

complexity of today's automobiles, have steadily reduced the scope of maintenance and repairs which can be carried out by vehicle owners. **Also, safety and environmental** concerns place very strict limits on the nature of repairs and adjustments to engine and transmission parts which an owner can perform.

Maintenance, adjustments and repairs usually require special tools, testing devices and other equipment available to specially trained workshop personnel in order to assure proper performance, reliability and safety of the vehicle and its many systems.

Improper maintenance, adjustments and repairs can impair the operation and reliability of your vehicle and even void your vehicle warranty. Therefore, proof of servicing in accordance with the maintenance schedule may be a condition for upholding a possible warranty claim made within the warranty period.

Above all, operational safety can be adversely affected, creating unnecessary risks for you and your passengers.

If in doubt about any servicing, have it done by your authorized Audi dealer or any properly equipped and qualified workshop. We strongly urge you to give your authorized Audi dealer the opportunity to perform all scheduled maintenance and necessary repairs. Your dealer has the facilities, original parts and trained specialists to keep your vehicle running properly.

### **Performing limited maintenance yourself**

The following pages describe a limited number of procedures which can be performed on your vehicle with ordinary tools, should the need arise and trained personnel be unavailable. Before performing any of these procedures, always thoroughly read all of the applicable text and carefully follow the instructions given. Always rigorously observe the **WARNINGS** provided.

**Before you check anything in the engine compartment, always read and heed all**

**WARNINGS** ⇨  **and** ⇨  *in Working in the engine compartment on page 212.*

### **WARNING**

- Serious personal injury may occur as a result of improperly performed maintenance, adjustments or repairs.
- Always be extremely careful when working on the vehicle. Always follow commonly accepted safety practices and general common sense. Never risk personal injury.
- Do not attempt any of the maintenance, checks or repairs described on the following pages if you are not fully familiar with these or other procedures with respect to the vehicle, or are uncertain how to proceed.
- Do not do any work without the proper tools and equipment. Have the necessary work done by your authorized Audi dealer or any properly equipped and qualified workshop.
- The engine compartment of any motor vehicle is a potentially hazardous area. Never reach into the area around or touch the radiator fan. It is temperature controlled and can switch on suddenly - even when the engine is off and the ignition key has been removed. The radiator fan switches on automatically when the coolant reaches a certain temperature and will continue to run until the coolant temperature drops.
- Always remove the ignition key before anyone gets under the vehicle.
- Always support your vehicle with safety stands if it is necessary to work underneath the vehicle. The jack supplied with the vehicle is not adequate for this purpose and could collapse causing serious personal injury.
- If you must work underneath the vehicle with the wheels on the ground, always make sure the vehicle is on level ground, that the wheels are always securely blocked and that the engine cannot be started.

- Always make sure the transmission selector lever (automatic transmission) is in “P” (Park position) or Neutral (manual transmission) and the park brake is firmly applied.



### For the sake of the environment

- Changing the engine settings will adversely affect emission levels. This is detrimental to the environment and increases fuel consumption.
- Always observe environmental regulations when disposing of old engine oil, used brake fluid, dirty engine coolant, spent batteries or worn out tires.
- Undeployed airbag modules and pretensioners might be classified as Perchlorate Material -special handling may apply, see [www.dtsc.ca.gov/hazardous-waste/perchlorate](http://www.dtsc.ca.gov/hazardous-waste/perchlorate). When the vehicle or parts of the restraint system including airbag modules safety belts with pretensioners are scrapped, all applicable laws and regulations must be observed. Your authorized Audi dealer is familiar with these requirements and we recommend that you have your dealer perform this service for you.

## Additional accessories, modifications and parts replacement

### Additional accessories and parts replacement

*Always consult an authorized Audi dealer before purchasing accessories.*

Your vehicle incorporates the latest safety design features ensuring a high standard of active and passive safety.

This safety could be compromised by non-approved changes to the vehicle. For this reason, if parts have to be replaced, please observe the following points when installing additional accessories:

Approved Audi accessories and genuine Audi parts are available from authorized Audi dealer.

These dealers also have the necessary facilities, tools and trained specialists to install the parts and accessories properly.



### WARNING

- Using the wrong spare parts or using non-approved accessories can cause damage to the vehicle and serious personal injury.
- Use only accessories expressly approved by Audi and genuine Audi spare parts
  - These parts and accessories have been specially designed to be used on your vehicle.
  - Never install accessories such as telephone cradles or beverage holders on airbag covers or within the airbag deployment zones. Doing so will increase the risk of injury if airbags are triggered in an accident!
  - Before you check anything in the engine compartment, always read and heed all WARNINGS ⇨ *page 212*.



### Note

- If items other than genuine Audi spare parts, add-on equipment and accessory items are used or if repair work is not performed according to specified methods, this can result in severe damage to your vehicle's engine and body (such as corrosion) and adversely affect your vehicle's warranty.
- If emergency repairs must be performed elsewhere, have the vehicle examined by an authorized Audi dealer as soon as possible.
- The manufacturer cannot be held liable for damage which occurs due to failure to comply with these stipulations.

## Technical Modifications

*Our guidelines must be complied with when technical modifications are made.*

Always consult an authorized Audi dealer **before** starting work on any modifications.

This will help ensure that vehicle function, performance and safety are not impaired ⇒ ⚠.

Attempting to work on electronic components and the software used with them can cause malfunctions. Because of the way electronic components are interconnected with each other, such malfunctions can also have an adverse affect on other systems that are not directly involved. This means that you risk both a substantial reduction in the operational safety of your vehicle and an increased wear of vehicle parts ⇒ ⚠.

Authorized Audi dealers will perform this work in a professional and competent manner or, in special cases, refer you to a professional company that specializes in such modifications.

### **WARNING**

Improper repairs and modifications can change the way vehicle systems work and cause serious personal injury.

### **Note**

If emergency repairs must be performed elsewhere, have the vehicle examined by an authorized Audi dealer as soon as possible.

## Declaration of Compliance, Telecommunications and Electronic Systems

*Radio Frequency Devices and Radiocommunication Equipment User Manual Notice.*

The manufacturer is not responsible for any radio or TV interference caused by unauthorized modifications to this equipment.

### Devices

The following devices each comply with FCC Part 15.19, FCC Part 15.21 and RSS-Gen Issue 1:

- Adaptive cruise control\*
- Convenience key\*
- Side assist\*
- Cell phone package\*
- Electronic immobilizer
- HomeLink universal remote control\*
- Remote control key

### FCC Part 15.19

This device complies with part 15 of the FCC Rules. Operation is subject to the following two conditions:

- (1) This device may not cause harmful interference, and
- (2) this device must accept any interference received, including interference that may cause undesired operation.

### FCC Part 15.21

CAUTION:

Changes or modifications not expressly approved by the party responsible for compliance could void the user's authority to operate the equipment.

### RSS-Gen Issue 1

Operation is subject to the following two conditions:

- (1) this device may not cause interference, and

(2) this device must accept any interference, including interference that may cause undesired operation of the device.

151.561.8K0.23

Technical data

Do-it-yourself service

Vehicle care

Vehicle operation

Safety first

Controls and equipment

## A

- A/C (automatic climate control) . . . . . 79
- Accessories . . . . . 66, 285
- adaptive cruise control
  - Vehicles with manual transmission . . . 103
- Adaptive cruise control . . . . . 101
  - Cleaning the sensor . . . . . 203
  - Messages . . . . . 109
  - Request for driver intervention . . . . . 107
  - Setting the driving program . . . . . 106
- Adaptive dampers . . . . . 115
- Adaptive light . . . . . 49
- Adaptive Light (defective) . . . . . 22
- Adding
  - Engine coolant . . . . . 219
  - Engine oil . . . . . 216
  - Windshield washer fluid . . . . . 225
- Additional accessories . . . . . 285
- Additives
  - Engine oil . . . . . 216
- Adjustable steering column . . . . . 82
- Adjusting
  - Air distribution (automatic climate control) . . . . . 80
  - Instrument illumination . . . . . 52
  - Steering column . . . . . 82
  - Temperature (automatic climate control) 80
- Airbag
  - Warning/indicator lights . . . . . 20
- Airbag system . . . . . 144, 160
  - Advanced Airbag System . . . . . 148
  - Advanced Airbag System components . 151
  - Care . . . . . 157
  - Children . . . . . 166
  - Child restraints . . . . . 167
  - Components (front airbags) . . . . . 151
  - Danger of fitting a child safety seat on the front passenger seat . . . . . 145
  - Disposal . . . . . 157
  - Front airbags . . . . . 148, 149
  - How do the front airbags work? . . . . . 153
  - How many airbags does my vehicle have? . . . . . 151
  - How the Advanced Airbag System components work together . . . . . 152
  - Important things to know . . . . . 144
  - Indicator light . . . . . 154
  - Monitoring . . . . . 154
  - PASSENGER AIR BAG OFF light . . . . . 155
  - Repairs . . . . . 157
  - Safety instructions . . . . . 156
  - Side airbags . . . . . 159
  - Side curtain airbags . . . . . 162
  - Weight-sensing mat . . . . . 166
  - When must the system be inspected? . 154
- Alcantara
  - Cleaning . . . . . 205
- all-wheel drive . . . . . 190
- All wheel drive
  - Winter tires . . . . . 254
- Alternator
  - refer to* Generator . . . . . 16
- Anti-freeze
  - refer to* Engine coolant system . . . . . 218
- Anti-lock braking system . . . . . 185
  - Warning/indicator lights . . . . . 18, 19
- Anti-slip regulation . . . . . 185
  - Warning/indicator lights . . . . . 18
- Anti-theft alarm warning system . . . . . 31
- Anti-theft systems
  - Electronic immobilizer . . . . . 37
- Armrest . . . . . 62
- Ashtray . . . . . 65
- Asterisk
  - What does it mean when something is marked with an asterisk? . . . . . 6
- Audi braking guard
  - refer to* braking guard . . . . . 101
- Audi drive select . . . . . 115
  - Adaptive dampers . . . . . 115
  - Description . . . . . 115
  - Dynamic steering . . . . . 115
  - Setting the driving mode . . . . . 116
  - Sport differential . . . . . 115
- Audi Service Repair Manuals and Literature . . . . . 283
- AUTO
  - Automatic climate control . . . . . 80
  - Automatic headlights . . . . . 49
- Auto Lock . . . . . 31
- Automatic belt retractor . . . . . 139

- Automatic climate control
  - Air vents . . . . . 80
  - Operation . . . . . 79
  - Setup . . . . . 81
- Automatic Shift Lock (ASL) . . . . . 95
- Automatic transmission . . . . . 93
  - Automatic Shift Lock (ASL) . . . . . 95
  - Driving . . . . . 95
  - Emergency mode . . . . . 99
  - Emergency release . . . . . 100
  - Kick-down . . . . . 98
  - Manual shift program . . . . . 98
  - Removal lock (ignition key) . . . . . 82
  - Selector lever . . . . . 94
- Automatic wipers . . . . . 55
- Auto Safety Hotline . . . . . 134
- Average speed . . . . . 24
- Avoid damaging the vehicle . . . . . 193
  
- B**
- Bag hooks . . . . . 74
- Battery . . . . . 16, 222
  - Battery location inside the luggage compartment . . . . . 222
  - Charging . . . . . 224
  - Important warnings when working on the battery . . . . . 222
  - Jump starting . . . . . 274
  - Low . . . . . 191
  - Replacing the battery . . . . . 225
  - State of charge . . . . . 191
  - Winter operation . . . . . 222
  - Working on the battery . . . . . 222
- Before driving . . . . . 126
- Bio-ethanol (Fuel) . . . . . 208
- Blended gasoline . . . . . 207
- Blower (automatic climate control) . . . . . 80
- Booster seats . . . . . 173
- Brake fluid
  - Changing the brake fluid . . . . . 221
  - Checking the brake fluid level . . . . . 221
  - Reservoir . . . . . 221
  - What is the correct brake fluid level? . . . . . 221
  - What should I do if the brake fluid warning light comes on? . . . . . 221
- Brake system . . . . . 221
  - Anti-lock braking system . . . . . 19
  - Brake assist system . . . . . 185
  - Brake fluid . . . . . 221
  - Brake fluid specifications for refill and replacement . . . . . 221
  - Brake light defective . . . . . 21
  - Brake power assist unit . . . . . 188
  - Brakes . . . . . 188
  - Ceramic brakes . . . . . 188
  - Electromechanical parking brake . . . . . 87
  - Warning/indicator lights . . . . . 15
  - Worn brake pads symbol . . . . . 20
- Braking
  - Emergency braking function . . . . . 89
- braking guard . . . . . 101
  - Messages . . . . . 109
  - Settings . . . . . 108
- Break-in period . . . . . 193
  - Tires . . . . . 193
- Bulbs . . . . . 272
  
- C**
- California Proposition 65 Warning . . . . . 213
  - Battery specific . . . . . 223
- Capacities . . . . . 281
- Carbon parts
  - Cleaning . . . . . 204, 205
- Care . . . . . 202
- Cargo area
  - refer to* Luggage compartment . . . . . 70, 132
- Catalytic converter . . . . . 194
- Center armrest . . . . . 62
- Central locking . . . . . 31
  - Central locking switch . . . . . 35
  - Convenience key . . . . . 35
  - Remote control key . . . . . 34
- Ceramic brake rotors
  - New brake pads . . . . . 188
- Certification . . . . . 286
- Changing a flat tire . . . . . 263
- Changing a wheel . . . . . 263
- Changing engine oil . . . . . 217
- Checking
  - Engine coolant level . . . . . 218
- Checking tire pressure . . . . . 239

- Child restraints
    - Danger of using child restraints in the front seat . . . . . 145
    - Where can I get additional information about child restraints and their use? .. 183
  - Child restraint system anchors . . . . . 179
  - Child safety . . . . . 165
    - Convertible locking retractor . . . . . 175
    - Important safety instructions for using child safety seats . . . . . 168
    - Important things to know when driving with children . . . . . 165
    - Installing a child restraint using the LATCH system . . . . . 180
    - Lower anchorages . . . . . 180
    - Mounting and releasing the anchorage hook . . . . . 180
    - Tether anchors . . . . . 181
    - Tether straps . . . . . 181
  - Child safety locks
    - Power windows . . . . . 42
    - Rear doors . . . . . 41
  - Child safety seats . . . . . 171
    - Booster seats . . . . . 173
    - Convertible child seats . . . . . 172
    - Convertible locking retractor . . . . . 175
    - Danger of using child restraints in the front seat . . . . . 145
    - How do I properly install a child safety seat in my vehicle? . . . . . 168
    - Infant seats . . . . . 171
    - Installing . . . . . 175
    - LATCH system . . . . . 180
    - Safety instructions . . . . . 168
    - Unused safety belts on the rear seat .. 170
  - Cigarette lighter . . . . . 65
  - Cleaning . . . . . 202
  - Climate controls . . . . . 78
  - Climate control system
    - Automatic recirculation . . . . . 81
    - Supplementary heater . . . . . 81
    - synchronizing . . . . . 81
  - Clock . . . . . 12
  - Closing
    - Power windows . . . . . 42
    - Sliding/tilting sunroof . . . . . 43
    - Sunshade . . . . . 43
  - Closing/opening
    - at the lock cylinder . . . . . 37
    - by remote control . . . . . 34
    - with the central locking switch . . . . . 35
    - with the convenience key . . . . . 35
  - Cold tire inflation pressure . . . . . 234
  - Coming home . . . . . 50
  - Compact spare tire . . . . . 260
    - also refer to Spare tire* . . . . . 260
  - Compartments . . . . . 68
  - Compass in the mirror . . . . . 58
  - Compliance . . . . . 286
  - Consumer Information . . . . . 134, 283
  - Contacting NHTSA . . . . . 134
  - Controls
    - Cleaning . . . . . 204
  - Convenience key
    - Indicator lights . . . . . 86
    - Starting engine (START ENGINE STOP button) . . . . . 85
    - Stopping the engine (START ENGINE STOP button) . . . . . 86
    - Switching on ignition . . . . . 85
    - unlocking/locking . . . . . 35
  - Convenience opening/closing . . . . . 42
  - Convertible child safety seats . . . . . 172
  - Convertible locking retractor
    - Activating . . . . . 177
    - Deactivating . . . . . 178
    - Using to secure a child safety seat .175, 177
  - Coolant system . . . . . 218
  - Cooling mode (automatic climate control) 79
  - Cooling System
    - Expansion tank . . . . . 218
  - Cornering light . . . . . 49
  - Cruise control
    - Changing speed . . . . . 91
    - Presetting your speed . . . . . 92
    - Switching off . . . . . 92
    - Switching on . . . . . 91
  - Cruising range . . . . . 24
  - Cupholder . . . . . 67
- D**
- Data recorder . . . . . 184
  - Date display . . . . . 12

Daytime running lights . . . . .	49, 50	Electro-mechanical power assist . . . . .	190
Declaration of compliance		Electromechanical parking brake	
Adaptive cruise control . . . . .	286	Emergency braking . . . . .	89
Audi side assist . . . . .	286	Indicator light . . . . .	87
Cell phone package . . . . .	286	Parking . . . . .	88
Convenience key . . . . .	286	Releasing and closing . . . . .	87
Electronic immobilizer . . . . .	286	Starting assist . . . . .	88
HomeLink universal remote control . . .	286	Starting from rest . . . . .	88
Remote control key . . . . .	286	Starting off with a trailer . . . . .	89
Decorative parts/trim		Warning/indicator lights . . . . .	16
Cleaning . . . . .	204	Electronic differential lock	
Defective light bulb warning . . . . .	21	Warning/indicator lights . . . . .	18
Defrosting (windows) . . . . .	80	Electronic differential lock (EDL) . . . . .	185
Determining correct load limit . . . . .	244	Warning/indicator lights . . . . .	19
Digital clock . . . . .	12	Electronic immobilizer . . . . .	12, 37
Digital compass . . . . .	58	Electronic power control	
Dimensions . . . . .	281	(EPC) warning/indicator light . . . . .	20
Dimming the rearview mirror . . . . .	53	Electronic speed limiter . . . . .	30
Displays		Electronic stabilization control	
Cleaning . . . . .	204	offroad mode . . . . .	187
Doors		Sport mode . . . . .	187
Child safety locks . . . . .	41	Electronic Stabilization Control (ESC) . . .	185
emergency locking . . . . .	37	Warning/indicator lights . . . . .	18
Driver information system		Emergency actuation	
Enhanced shift indicator . . . . .	27	Doors . . . . .	37
Open door or front lid warning . . . . .	23	Ignition key . . . . .	34
Outside temperature display . . . . .	23	Rear lid . . . . .	40, 41
Sound system display . . . . .	23	Sliding/tilting sunroof . . . . .	44
Driver seat		Emergency braking . . . . .	89
<i>refer to</i> Seating position . . . . .	127	Emergency flasher . . . . .	51
Driving offroad . . . . .	197	Warning/indicator lights . . . . .	22
Driving safely . . . . .	126	Emergency key . . . . .	32
Driving through water . . . . .	193	Starting engine . . . . .	84
Driving time . . . . .	24	Emergency operation	
Dust filter		Emergency braking function (parking	
<i>refer to</i> Pollutant filter (automatic A/C		brake) . . . . .	89
system) . . . . .	78	Emergency starting . . . . .	274
Dynamic steering . . . . .	115, 190	Emergency towing . . . . .	276
		Energy management . . . . .	191
<b>E</b>		Battery power . . . . .	16
E85 (Fuel) . . . . .	208	Driver notification . . . . .	16
Efficiency program . . . . .	26	Engine	
Fuel economy messages . . . . .	28	Compartment . . . . .	214
Memory levels . . . . .	24	Coolant . . . . .	218
Other equipment . . . . .	27	Data . . . . .	282
Shift indicator . . . . .	27	Hood . . . . .	212
		Starting . . . . .	82, 85

- Starting with jumper cables . . . . . 274
  - Stopping . . . . . 84, 86
  - Engine compartment
    - Safety instructions . . . . . 212
    - Working the engine compartment . . . . 212
  - Engine coolant
    - Indicator light . . . . . 17
  - Engine coolant system . . . . . 218
    - Adding coolant . . . . . 219
    - Checking coolant level . . . . . 218
    - Checking the engine coolant level . . . . 218
    - Radiator fan . . . . . 220
  - Engine coolant temperature
    - Temperature gauge . . . . . 10
  - Engine hood
    - Closing . . . . . 212
    - How to release the hood . . . . . 212
  - Engine oil . . . . . 214
    - Adding . . . . . 216
    - Additives . . . . . 216
    - Changing . . . . . 217
    - Check oil level . . . . . 216
    - Consumption . . . . . 216
    - Indicator light . . . . . 17, 21
    - Oil consumption . . . . . 215
    - Oil grades . . . . . 214
    - Pressure malfunction . . . . . 17
    - Sensor defective . . . . . 21
    - Specification and viscosity . . . . . 214
  - Engine speed limitation . . . . . 20
  - Environment
    - Break-in period . . . . . 193
    - Catalytic converter . . . . . 194
    - Disposing of your vehicle battery . . . . 225
    - Driving at high speeds . . . . . 195
    - Driving to minimize pollution and noise 195
    - Fuel . . . . . 210
    - Fuel economy . . . . . 195
    - Leaks under your vehicle . . . . . 212
    - Letting the vehicle stand and warm up . 196
    - Proper disposal of drained brake fluid . 221
    - Proper disposal of drained engine coolant . . . . . 219
    - Proper disposal of drained engine oil . . . . . 216, 217
    - Recycling used engine oil . . . . . 216
    - Roof rack . . . . . 70
    - Unleaded fuel . . . . . 207
    - What should I do with an old battery? . 225
  - EPC
    - refer to* Electronic power control . . . . . 20
  - Ethyl alcohol (Fuel) . . . . . 208
  - Event Data Recorder (EDR) . . . . . 184
  - Exhaust tail pipes
    - Cleaning . . . . . 203
  - Expansion tank . . . . . 218
  - Exterior lighting . . . . . 49
  - Exterior mirrors
    - Adjusting . . . . . 52
    - Dimming . . . . . 53
    - Heating . . . . . 52
- ## F
- Fan
    - Radiator . . . . . 220
  - Fastening
    - Booster seats . . . . . 173
    - Convertible child safety seats . . . . . 172
    - Infant seats . . . . . 171
  - Fastening eyes
    - refer to* Tie-downs . . . . . 74
  - Flat tire
    - Changing . . . . . 263
  - flexible fuel . . . . . 208
  - Floor . . . . . 76
  - Floor mats . . . . . 131
  - Fog lights/rear fog light(s) . . . . . 49
  - Folding the rear seats . . . . . 71
  - Foot pedals . . . . . 131
  - For the sake of the environment
    - Gasoline fumes and the environment . . 210
    - Letting the engine warm up . . . . . 82, 85
    - Refueling . . . . . 210
    - Saving fuel by early upshifting . . . . . 11
  - Front airbags
    - Description . . . . . 148
    - How they work . . . . . 153
  - Frontal collisions and the laws of physics 137
  - Front passenger's door emergency locking 37
  - Front seats
    - Adjusting . . . . . 128
    - Child restraints in the front seat . . . . 145

- Fuel
- Additives . . . . . 207
  - Blended gasoline . . . . . 207
  - Consumption . . . . . 24
  - Filler neck . . . . . 209
  - Fuel gauge . . . . . 12
  - Gasoline . . . . . 207
  - Gasoline additives . . . . . 209
  - Low fuel level symbol . . . . . 21
  - Octane rating . . . . . 207
  - Recommendation . . . . . 207
  - Refuelling . . . . . 210
  - Reserve . . . . . 12
  - Tank capacity . . . . . 281
  - Tank system . . . . . 21
  - Unlocking the fuel filler flap by hand . . 211
- Fuel economy messages (efficiency program) . . . . . 28
- Fuel filler flap
- Unlocking the fuel filler flap by hand . . 211
- Fuses
- Assignment . . . . . 269, 271
  - Replacing . . . . . 269
- G**
- Garage door opener (HomeLink) . . . . . 45
- Garment hooks . . . . . 68
- Gas discharge lamps . . . . . 272
- Gauges
- Engine coolant temperature . . . . . 10
  - Fuel gauge . . . . . 12
  - Tachometer . . . . . 11
- Gear recommendation . . . . . 27
- Gearshift indicator . . . . . 26
- Gearshift lever
- 6-speed manual transmission . . . . . 93
- General illustration
- Instruments and controls . . . . . 8
- Generator
- Warning/indicator lights . . . . . 16
- Glossary of tire and loading terminology . . 229
- Glove compartment . . . . . 67
- Valet parking . . . . . 45
- GPS controlled clock . . . . . 12
- Gross Vehicle Weight Rating (GVWR) . . . 280
- Ground clearance . . . . . 197
- H**
- Headlights
- Cleaning . . . . . 203
  - Cleaning system . . . . . 55
  - Defective . . . . . 21
  - Headlight range control . . . . . 21
  - Left hand drive, right hand drive . . . . 51
  - Travel mode . . . . . 51
- Headlight washer reservoir . . . . . 225
- Head restraints . . . . . 130
- Adjusting . . . . . 63, 130
  - Removing/installing . . . . . 63
- Heated
- exterior mirrors . . . . . 52
  - rear window . . . . . 80
  - seats . . . . . 80
  - windshield washer spray nozzles . . . . 55
- Heating . . . . . 78
- Heavy clothing and safety belts . . . . . 139
- High beam . . . . . 50
- High voltage warning label . . . . . 280
- Hill descent control . . . . . 97
- HomeLink (garage door opener) . . . . . 45
- Hood
- Opening . . . . . 212
  - Release lever . . . . . 212
- Hooks . . . . . 74
- Horn . . . . . 8
- How are child restraint system anchors related to child safety . . . . . 179
- How many airbags does my vehicle have? . 151
- How often should I check my tire pressures? . . . . . 241
- How safety belt pretensioners work . . . . 142
- Hydroplaning . . . . . 245
- I**
- Ignition
- switching on/off . . . . . 82
- Ignition key
- Emergency unlocking . . . . . 34
- Ignition lock . . . . . 82
- Indicator light . . . . . 18
  - Malfunction . . . . . 22
- Immobilizer . . . . . 12

- Important things to do before driving . . . 126
- Improperly worn safety belts . . . . . 142
- Indicator lights . . . . . 13
- Airbag system . . . . . 154, 155
- Dynamic steering . . . . . 190
- PASSENGER AIR BAG OFF . . . . . 155
- also refer to* Warning/indicator lights . . . 13
- Infant seats . . . . . 171
- Inflatable spare tire . . . . . 261
- Inflating . . . . . 262
- Installing child safety seats
- Safety belts . . . . . 175
- Installing the upper tether strap on the anchorage . . . . . 182
- Instruments
- Adjusting the lighting . . . . . 52
- Instruments and controls . . . . . 10
- General illustration . . . . . 8
- Interior lights
- Front . . . . . 52
- Rear . . . . . 52
- Intermittent (windshield wipers) . . . . . 55
- J**
- Jump-starting . . . . . 274
- Jumper cables . . . . . 275
- K**
- Key . . . . . 32
- Battery replacement . . . . . 33
- Check light . . . . . 33
- Emergency key . . . . . 32, 84
- Ignition/engine on/off . . . . . 82
- Key replacement . . . . . 32
- Mechanical key . . . . . 32, 33
- removing . . . . . 84
- unlocking/locking . . . . . 34, 35, 37
- Kick-down . . . . . 98
- L**
- Lane Change Assistant
- refer to* side assist . . . . . 111
- LATCH . . . . . 179
- Description . . . . . 180
- Installing a child restraint . . . . . 180
- Location . . . . . 179
- Mounting and releasing the anchorage hook . . . . . 180
- Launch Control Program . . . . . 99
- Leather cleaning/protection . . . . . 205
- Leaving home . . . . . 50
- Left hand drive . . . . . 51
- Lifting jack . . . . . 265
- Lifting vehicle . . . . . 278
- Light
- adaptive light . . . . . 49
- Coming/Leaving home . . . . . 50
- Daytime running lights . . . . . 49, 50
- Exterior lighting . . . . . 49, 50
- Fog lights/rear fog light(s) . . . . . 49
- Interior/reading . . . . . 52
- Low beam . . . . . 49
- Rear fog lights . . . . . 49
- Side marker lights . . . . . 49
- Travel mode . . . . . 51
- Light/rain sensor
- Headlights . . . . . 49
- Intermittent (windshield wipers) . . . . . 55
- Sensor defective . . . . . 22
- Lights
- Emergency flashers . . . . . 51
- High beam . . . . . 50
- Turn signals . . . . . 50
- Locking
- Rear lid . . . . . 38
- Locking/unlocking
- at the lock cylinder . . . . . 37
- by remote control . . . . . 34
- with the central locking switch . . . . . 35
- with the convenience key . . . . . 35
- Low beams . . . . . 49
- Lower anchorage locator button . . . . . 180
- Lower universal anchorage bars (Canada) 179
- Lower universal anchorages (Canada) . . . 179
- Luggage
- Stowing . . . . . 132
- Luggage compartment . . . . . 70
- Cargo net . . . . . 73
- Cover . . . . . 71
- Enlarging . . . . . 71
- Floor . . . . . 76
- Lid . . . . . 38

Loading	132
Partition net	72, 73
Pass-through	75
Reversible mat	75
Securing attachments	75
Ski sack	75
Tie-downs	74, 133
Valet parking	45
Lumbar support	61, 62

## M

Maintenance	283
Malfunction Indicator Lamp (MIL)	20, 29
Manual transmission	93
Matte finish paint cleaning	202
Mechanical key	32, 33
Memory function	64
Mileage	
Average	24
Instantaneous	24
Mirrors	
Adjusting the exterior mirrors	52
Compass	58
dimming	53
Vanity mirrors	54
Monitoring the Advanced Airbag System	154
multitronic	93
Automatic Shift Lock (ASL)	95
Driving	95
Emergency mode	99
Manual shift program	98
Selector lever	94

## N

Natural leather	
Cleaning	205
Net	68
New tires and wheels	248
NHTSA	
Contacting	134
Number of seats	136

## O

Occupant seating positions	127
Octane rating	207

Odometer	12
Offroad	197
OFF (automatic climate control)	79
Oil	
<i>refer to</i> Engine oil	214, 216
Oil consumption	216
On-Board Diagnostic System (OBD)	
Data Link Connector (DLC)	29
Electronic speed limiter	30
Malfunction Indicator Lamp (MIL)	29
Open door or front lid warning	23
Opening	
Power windows	42
Rear lid	39, 40, 41
Sliding/tilting sunroof	43
Sunshade	43
Sun shades	54, 55
Opening/closing	
at the lock cylinder	37
by remote control	34
with the central locking switch	35
with the convenience key	35
Operate your vehicle economically and minimize pollution	195
Optional equipment	
Marked with an asterisk	6
Other equipment (efficiency program)	27
Outside mirrors	
<i>refer to</i> Exterior mirrors	52
Outside temperature display	23
Owner's manual	
How the Owner's Manual is organized	6

## P

Paint damage	204
Paint No.	280
Parcel shelf	76
Park assist	118
Cleaning sensors/camera lenses	203
Parking	88
Automatic transmission	95
Valet parking	45
Parking brake	87
<i>also refer to</i> Electromechanical parking brake	87

- Parking system . . . . . 118
- Rear . . . . . 118
  - Rear, with rear view camera . . . . . 120
- Parking system (rear) . . . . . 118
- Adjusting the warning tones . . . . . 119
- Parking system (rear, with rear view camera)
- Parking mode 1 . . . . . 122
  - Parking mode 2 . . . . . 123
  - Safety precautions . . . . . 120
  - Switching on/off . . . . . 121
  - Switching rear view camera on/off . . . . 124
- Partition net . . . . . 72, 73
- Parts replacement . . . . . 285
- Pass-through . . . . . 75
- PASSENGER AIR BAG OFF light . . . . . 155
- Passive safety system . . . . . 126
- Pedals . . . . . 131
- Physical principles of a frontal collision . 137
- Plastic parts
- Cleaning . . . . . 204
- Polishing . . . . . 204
- Pollutant filter (automatic A/C system) . . 78
- Power
- seat adjustment . . . . . 62
- Power locking system . . . . . 31
- Emergency locking . . . . . 37
  - Power windows . . . . . 42
  - Rear lid . . . . . 38
  - Selective unlock feature . . . . . 36
  - Settings . . . . . 36
  - Sliding/tilting sunroof . . . . . 42
- Power steering
- refer to* Electro-mechanical power assist . . . . . 190
- Power window
- Convenience opening/closing . . . . . 42
- Power windows . . . . . 42
- Child safety locks . . . . . 42
  - Malfunctions . . . . . 43
- Pregnant women
- Special considerations when wearing a safety belt . . . . . 141
- Proper occupant seating positions . . . . 127
- Proper safety belt position . . . . . 140
- Proper seating position
- Front passenger . . . . . 128
  - Occupants . . . . . 127
  - Rear passengers . . . . . 129
- Protecting . . . . . 204
- Protective liner . . . . . 76
- Q**
- Quartz clock . . . . . 12
- quattro
- refer to* all-wheel drive . . . . . 190
- Question
- What happens to unbelted occupants? 137
  - Why safety belts? . . . . . 136
- R**
- Radiator fan . . . . . 220
- Rain/light sensor
- Headlights . . . . . 49
  - Intermittent (windshield wipers) . . . . 55
  - Sensor defective . . . . . 22
- Reading lights . . . . . 52
- Rear door sun shade . . . . . 54, 55
- Rear fog lights . . . . . 49
- Rear lid
- Automatic operation . . . . . 39
  - Emergency release . . . . . 40, 41
  - Escape handle . . . . . 41
  - Opening and closing . . . . . 38
- Rear light
- Defective . . . . . 21
- Rear view camera
- Parking mode 1 . . . . . 122
  - Parking mode 2 . . . . . 123
- Rear view mirror . . . . . 53
- Rear window heating . . . . . 80
- Rear window sun shade . . . . . 55
- Rear window washer system . . . . . 55
- Recirculation mode (automatic climate control) . . . . . 79
- Refuelling . . . . . 210
- Release lever for hood . . . . . 212
- Remote control
- Garage door opener (HomeLink) . . . . . 45

- Remote control key . . . . . 32
    - Personalizing . . . . . 32
    - unlocking/locking . . . . . 34
  - Remote rear lid release . . . . . 38
  - Repair manuals . . . . . 283
  - Repairs
    - Airbag system . . . . . 157
  - Replacement key . . . . . 32
  - Replacing
    - Windshield wiper blades . . . . . 58
  - Replacing bulbs . . . . . 272
  - Replacing tires and wheels . . . . . 249
  - Replacing wiper blades . . . . . 57
  - Reporting Safety Defects . . . . . 134
  - Reset button . . . . . 12
  - Retractor . . . . . 139
  - Reversible floor . . . . . 76
  - Reversible mat . . . . . 75
  - Right hand drive . . . . . 51
  - Rims
    - Cleaning . . . . . 203
  - Roof rack . . . . . 69
    - Roof load . . . . . 70
    - Roof weight . . . . . 70
- S**
- SAFE . . . . . 12
  - Safe driving habits . . . . . 126
  - Safety belt position . . . . . 140
    - Safety belt height adjustment . . . . . 142
    - Safety belts worn by pregnant women . . . . . 141
  - Safety belt pretensioner . . . . . 142
    - Service and disposal . . . . . 143
  - Safety belts . . . . . 139
    - Cleaning . . . . . 204
    - Danger to passengers who do not wear a safety belt . . . . . 137
    - Fastening . . . . . 139
    - Height adjustment . . . . . 142
    - Improperly worn . . . . . 142
    - Not worn . . . . . 137
    - Safety belt position . . . . . 140
    - Safety instructions . . . . . 139
    - Securing child safety seats . . . . . 175
    - Special considerations for pregnant women . . . . . 141
    - Unfastening . . . . . 141
    - Warning/indicator light . . . . . 136
    - Warning light . . . . . 16
    - Why YOU MUST wear them . . . . . 136
    - Worn properly . . . . . 138
  - Safety belt warning light . . . . . 136
  - Safety compliance sticker . . . . . 280
  - Safety equipment . . . . . 126
  - Safety features for occupant restraint and protection . . . . . 126
  - Safety guidelines
    - Seats . . . . . 60
  - Safety instructions
    - Engine compartment . . . . . 212
    - for side curtain airbags . . . . . 163
    - for using child safety seats . . . . . 168
    - for using safety belts . . . . . 139
    - Monitoring the Advanced Airbag System . . . . . 156
  - Seat adjustment
    - Head restraints . . . . . 130
  - Seat belts
    - refer to* Safety belts . . . . . 136
  - Seat covers
    - Cleaning . . . . . 205
  - Seat heating . . . . . 80
  - Seating capacity . . . . . 136
  - Seating position
    - Driver . . . . . 127
    - Front passenger . . . . . 128
    - How to adjust the front seats . . . . . 128
    - Incorrect seat position . . . . . 130
    - Occupants . . . . . 127
    - Rear passengers . . . . . 129
  - Seat memory . . . . . 64
  - Seats
    - Adjusting . . . . . 61, 62
    - Driver's seat . . . . . 60
    - Folding . . . . . 71
    - Front passenger's seat . . . . . 61
    - Head restraints . . . . . 63
    - Number of seats . . . . . 136
    - Safety guidelines . . . . . 60
  - Securing attachments . . . . . 75
  - Selective unlock feature . . . . . 36
  - Selector lever . . . . . 94
    - Emergency release . . . . . 100

- Selector lever emergency release ..... 100
- Service and disposal
- Safety belt pretensioner ..... 143
- Service interval display ..... 28
- Service position
- refer to* Replacing wiper blades ..... 57
- SET button ..... 11
- Shift indicator (efficiency program) ..... 27
- Shutting down vehicle ..... 195
- Side airbags
- Description ..... 159
  - How they work ..... 160
- side assist
- Adjusting the brightness ..... 113
  - Sensor range ..... 112
- Side assist
- Activating and deactivating ..... 113
  - Cleaning the sensors ..... 203
  - Description ..... 111
- Side curtain airbags ..... 162
- Description ..... 162
  - How they work ..... 163
  - Safety instructions ..... 163
- Side marker lights ..... 49
- Ski sack ..... 75
- Sliding/tilting sunroof
- Convenience opening/closing ..... 42
  - Emergency closing ..... 44
  - Opening and closing ..... 43
  - Sunshade ..... 43
- Snow chains ..... 255
- Socket
- 12-volt ..... 66
- Sound system display ..... 23
- Sources of information about child restraints and their use ..... 183
- Spare tire ..... 260
- Speedometer ..... 12
- Speed rating letter code ..... 250
- Speed warning system ..... 89
- Sport differential ..... 115
- Indicator lamp ..... 22
- START ENGINE STOP button (convenience key) ..... 86
- START ENGINE STOP button (Convenience key) ..... 85
- Starting from rest ..... 88
- Starting off with a trailer ..... 89
- Starting the engine ..... 82, 85
- Steering
- Locking the steering ..... 82
  - also refer to* Electro-mechanical power assist ..... 190
- Steering wheel
- Adjusting steering column ..... 82
  - Indicator light ..... 18, 190
- Steps for determining correct load limit . 244
- Stopping the engine ..... 84, 86
- Storage ..... 66
- Storage compartments ..... 68, 76
- S tronic ..... 93
- Selector lever ..... 94
- S tronic transmission
- Emergency release ..... 100
  - Launch Control Program ..... 99
- Sunroof ..... 43
- also refer to* Sliding/tilting sunroof 43, 44
- Sun shades
- Rear doors ..... 54, 55
  - Rear window ..... 55
- Sun visors ..... 54
- Symbols
- refer to* Warning/indicator lights ..... 13
- ## T
- Tachometer ..... 11
- Tail lights
- Cleaning ..... 203
- Technical modifications ..... 286
- Tether anchors ..... 181
- Tether strap ..... 181
- Textiles
- Cleaning ..... 205
- The first 1,000 miles (1,500 km) and afterwards ..... 193
- Tie-downs ..... 74, 133
- tiptronic ..... 93
- Automatic Shift Lock (ASL) ..... 95
  - Driving ..... 95
  - Emergency mode ..... 99
  - Manual shift program ..... 98
  - Selector lever ..... 94

- Tire pressure ..... 239
- Tire pressure monitoring system ..... 257
- Tires ..... 227
- Low aspect ratio tires ..... 256
  - Service life ..... 245
  - Speed rating letter code ..... 250
  - Tire manufacturing date ..... 250
  - Tire specifications ..... 249
  - Tread depth ..... 245
  - Uniform tire quality grading ..... 254
  - Winter tires ..... 254
- Tires and vehicle load limits ..... 242
- Tires and wheels
- Checking tire pressure ..... 239
  - Cold tire inflation pressure ..... 234
  - Dimensions ..... 248
  - General notes ..... 227
  - Glossary of tire and loading terminology ..... 229
  - New tires and wheels ..... 248
  - Replacing ..... 249
  - Snow chains ..... 255
  - Tires and vehicle load limits ..... 242
  - Wheel bolts ..... 256
  - Winter tires ..... 254
- Tire service life ..... 245
- Tool kit ..... 260
- Torn or frayed safety belts ..... 139
- Towing
- Front eyelet ..... 277
  - Rear eyelet ..... 277
  - Tow truck procedures ..... 276
- TPMS
- Tire pressure monitoring system ..... 257
- Trailer towing ..... 199
- Operating instructions ..... 199
  - Technical requirements ..... 199, 200
  - Tips ..... 201
- Transmission ..... 93
- 6-speed manual transmission ..... 93
- Transmission malfunction (indicator light) 99
- Transport Canada ..... 134
- Travel mode ..... 51
- Tread Wear Indicator (TWI) ..... 245
- Trip computer
- Fuel consumption ..... 24
  - Mileage ..... 24
- Single-trip memory ..... 24
  - Total-trip memory ..... 24
- Trip odometer ..... 12
- Trunk
- refer to* Luggage compartment ... 70, 132
- Trunk escape handle ..... 41
- Trunk lid
- refer to* Rear lid ..... 38, 39
- Turn signals ..... 50
- Warning/indicator lights ..... 22
- ## U
- Unfastening safety belts ..... 141
- Unidirectional tires ..... 228
- Uniform tire quality grading ..... 254
- Unlocking
- Rear lid ..... 38
- Unlocking/locking
- at the lock cylinder ..... 37
  - by remote control ..... 34
  - with the central locking switch ..... 35
  - with the convenience key ..... 35
- Use of jumper cables ..... 275
- ## V
- Valet parking ..... 45
- Vanity mirrors ..... 54
- Vehicle
- care/cleaning ..... 202
- Vehicle control modules ..... 184
- Vehicle electrical system ..... 16
- Vehicle identification label ..... 280
- Vehicle Identification Number (VIN) ..... 280
- Vehicle jack ..... 265
- Vehicle key ..... 32
- Vehicle literature ..... 5
- Vehicle shut-down ..... 195
- Vehicle tool kit ..... 260
- Ventilation ..... 78
- Vinyl
- Cleaning ..... 205

## W

- Warning/indicator lights . . . . . 10, 13
  - Airbag system . . . . . 20
  - Anti-lock braking system (ABS) . . . . . 19
  - Brake system . . . . . 15
  - Electromechanical parking brake . . . . . 16
  - Electronic power control . . . . . 20
  - Electronic Stabilization Control (ESC) . . . 18
  - Generator . . . . . 16
  - Malfunction Indicator Lamp (MIL) . . . . . 20
  - Safety belt . . . . . 16
  - Safety systems . . . . . 20
  - Turn signals . . . . . 22
- Warranty coverages . . . . . 283
- Washer reservoir . . . . . 225
- Wear indicator . . . . . 245
- Weights . . . . . 280
- What happens if you wear your safety belt too loose? . . . . . 140
- What happens to unbelted occupants? . . 137
- What impairs driving safety? . . . . . 127
- What should I do after changing a wheel? . . . . . 241
- What should I do after replacing wheels? 241
- Wheel bolts
  - Torque . . . . . 256
- Wheels . . . . . 227
  - Checking tire pressure . . . . . 239
  - Cleaning . . . . . 203
  - Cold tire inflation pressure . . . . . 234
  - General notes . . . . . 227
  - Glossary of tire and loading terminology . . . . . 229
  - New tires and wheels . . . . . 248
  - Tires and vehicle load limits . . . . . 242
- When must a safety belt be replaced? . . 139
- When must the airbag system be inspected? . . . . . 154
- When should I adjust the tire pressures? 241
- When should I check the tire pressures? . 241
- Where can I find the tire pressures for my car? . . . . . 239
- Why safety belts? . . . . . 136, 137
- Window regulators
  - Power locks . . . . . 42
- Windows
  - Cleaning/removing ice . . . . . 204
  - defrosting . . . . . 80
- Windshield
  - Cleaning . . . . . 55
  - defrosting . . . . . 80
- Windshield washer fluid
  - Low level . . . . . 21
- Windshield washer system . . . . . 55
- Windshield wipers
  - Cleaning . . . . . 56
  - Folding up . . . . . 57
  - Indicator light . . . . . 21
  - Replacing windshield wiper blades . . 57, 58
  - Switching on/off . . . . . 55
  - Washer reservoir . . . . . 225
- Winter operation
  - Battery . . . . . 222
  - Car washes . . . . . 202
  - Coolant system . . . . . 218
  - Defrosting windows . . . . . 80
  - Removing ice from windows . . . . . 204
  - Seat heating . . . . . 80
  - Tires . . . . . 190
- Winter tires . . . . . 254
  - All wheel drive . . . . . 254

## X

- Xenon headlights . . . . . 49, 51, 272

It has always been Audi's policy to continuously improve its products. Audi, therefore, reserves the right to make changes in design and specifications, and to make additions or improvements in its products, without incurring any obligation to install them on products previously manufactured.

Text, illustrations and specifications in this manual are based on the most up-to-date information available at the time of printing.

All rights reserved. May not be reproduced or translated in whole or in part without the

written consent of AUDI AG. Specifications are subject to change without notice.

**Editorial deadline: 03/28/2014**



**For the sake of the environment**

Printed on environmentally friendly paper  
(bleached without chlorine, recyclable).

Printed in Germany

© 2014 AUDI AG

**Owner's Manual**  
**2015 Audi A4 Sedan**  
**2015 Audi S4 Sedan**  
**2015 Audi allroad**  
**Englisch USA 05.2014**  
**151.561.8K0.23**



1515618K023

[www.audi.com](http://www.audi.com)