



KIA MOTORS

Sportage

2002 Owner's Manual

Kia, The Company

Now that you are the owner of a Kia Sportage, you'll probably be asked a lot of questions about your vehicle and the company like "Who is Kia?" "What does "Kia" mean?"

Here are some answers. First, Kia is the oldest car company in Korea. It's a company that has thousands of employees focused on building high-quality vehicles at affordable prices.

The first syllable, *ki*, in the word "Kia" means "to arise from to the world" or "to come up out of to the world." The second syllable, *a*, means "Asia." So, the word *Kia*, means "to arise from" or "to come up out of Asia to the world."

Enjoy your Sportage!

Table of Contents

Introduction	Section 1
Your Vehicle At A Glance	Section 2
Knowing Your Vehicle	Section 3
Including “Air Bags” on page 3-35	
“Child Restraints” on page 3-32	
“Safety Belts” on page 3-19	
Driving Your Vehicle	Section 4
Driving Tips	Section 5
In Case Of An Emergency	Section 6
Maintenance	Section 7
Specifications	Section 8
Index	Section 9

Introduction

How To Use This Manual	1-2
Vehicle Break-In Process	1-3

Introduction

How To Use This Manual

We want to help you get the greatest possible driving pleasure from your vehicle. Your Owner's Manual can assist you in many ways. **We strongly urge that you review the entire manual.**

However, in order to prevent death or injury, at the very least, you must review the WARNING and CAUTION sections spread throughout the manual, which are easily recognized by their special markings listed below.

Illustrations complement the words in this manual to best explain how to enjoy your vehicle. By reading your manual, you learn about features, important safety information, and driving under various road conditions.

The general layout of the manual is provided in the Table of Contents. A good place to start is the index; it has an alphabetical listing of all information in your manual.

Sections. This manual has eight sections plus an index. Each section begins with a brief list of contents so you can tell at a glance if that section has the information you want.

You'll find various WARNING's, CAUTION's, and NOTICE's in this manual. These WARNING's, CAUTION's and NOTICE's were prepared to enhance your personal safety and continued satisfaction with your Kia Sportage. You should carefully read and follow ALL procedures and recommendations provided in these WARNING's, CAUTION's and NOTICE's.

WARNING

A WARNING indicates a situation in which serious bodily injury or death could result if the warning is ignored.

CAUTION

A CAUTION indicates a situation in which personal injury, perhaps severe, could result if the caution is ignored.

* NOTICE

A NOTICE indicates a situation in which damage to your vehicle could result if the notice is ignored.

Vehicle Handling Instructions

As with other vehicles of this type, failure to operate this vehicle correctly may result in loss of control, an accident or vehicle rollover. Specific design characteristics (higher ground clearance, track, etc.) give this vehicle a higher center of gravity than ordinary cars. They are not designed for cornering at the same speeds as conventional 2-wheel drive vehicles. Avoid sharp turns or abrupt maneuvers. Again, failure to operate this vehicle correctly may result in loss of control, an accident or vehicle rollover. Be sure to read the "on-pavement" and "off-road" driving guidelines, Section 5 in this manual.

Vehicle Break-In Process

No special break-in period is needed. By following a few simple precautions for the first 1000 km (600 miles) you may add to the performance, economy and life of your vehicle.

- Do not race the engine.
- Do not maintain a single speed for long periods of time, either fast or slow. Varying engine speed is needed to properly break in the engine.
- Avoid hard stops, except in emergencies, to allow the brakes to seat properly.
- Avoid full-throttle starts.

Your Vehicle At A Glance

Instrument Panel Overview	2-3
Interior and Exterior Overview	2-2

Your Vehicle At A Glance

Interior and Exterior Overview

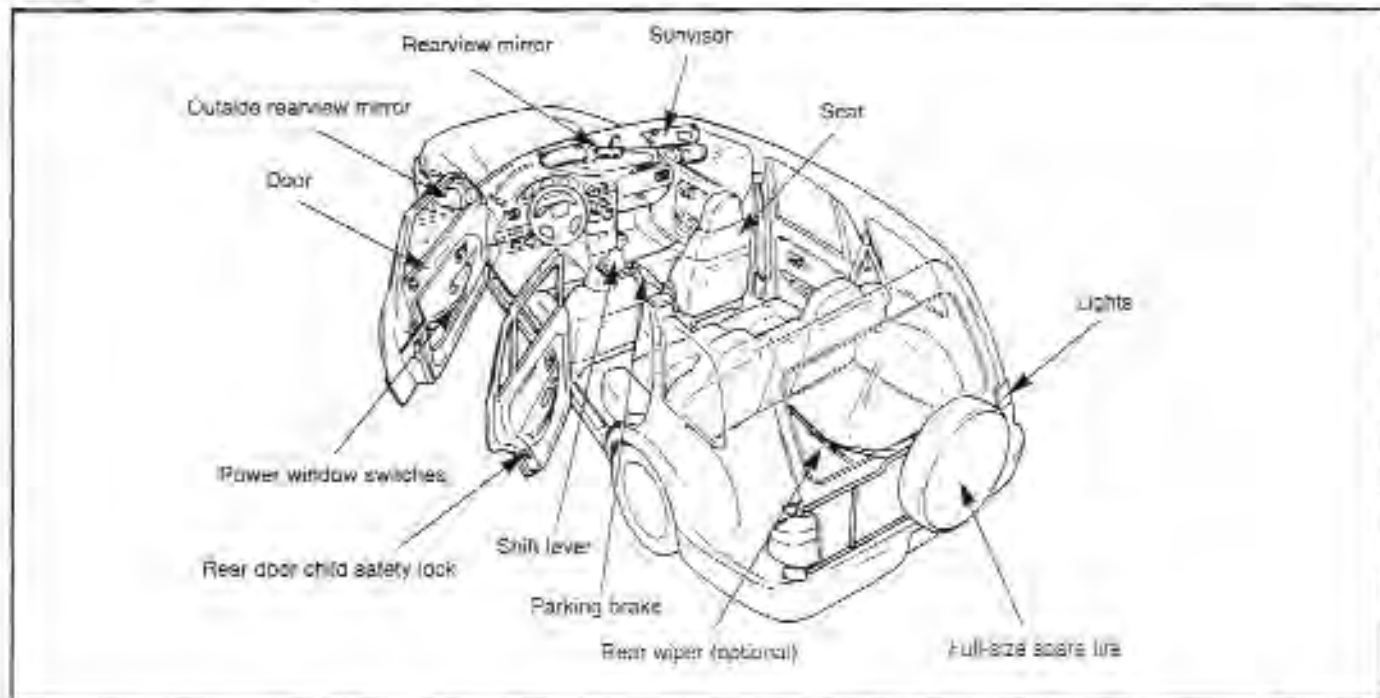

AN7802001

Instrument Panel Overview

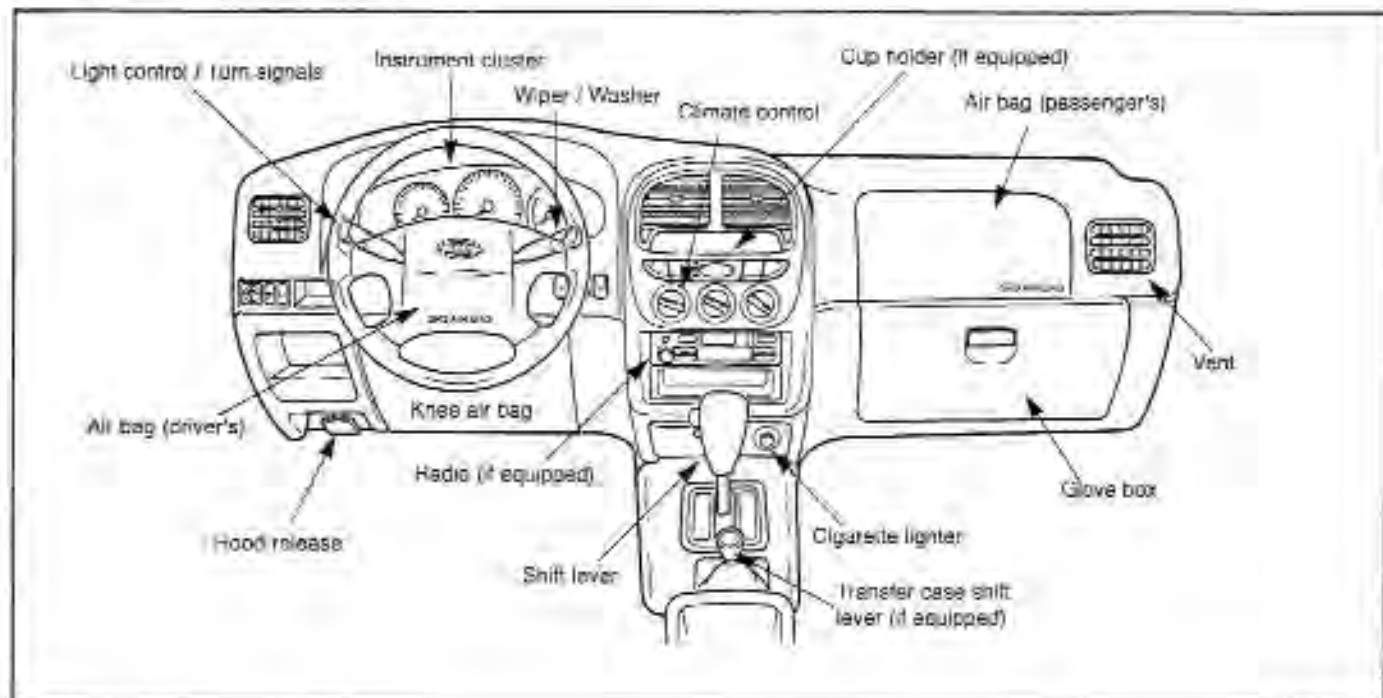

AM/BU2002B

Knowing Your Vehicle

Air Bags	3-35
Child Restraints	3-32
Console Storage Compartment	3-59
Cup Holder	3-57
Door Locks	3-4
Front Seat	3-11
Fuel Filler Lid	3-51
Hood	3-49
Interior Lights	3-56
Keys	3-3
Mirrors	3-54
Rear Hatch	3-46
Rear Seat	3-15

Knowing Your Vehicle

Safety Belts	3-19
Steering Wheel	3-53
Windows	3-7

Keys

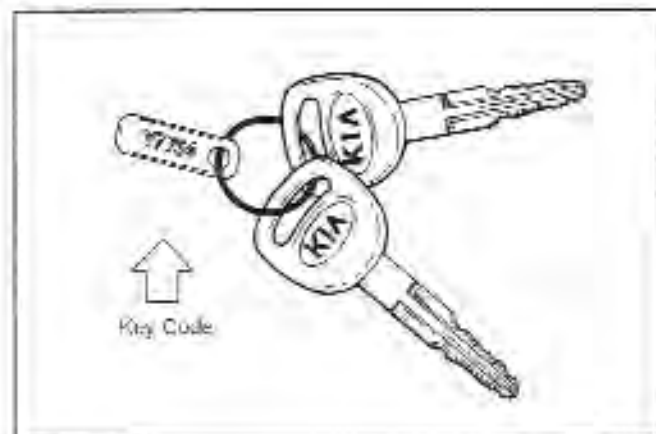

4N7D0J001

The key code number is stamped on the plate attached to the key set. If you should lose your keys, this number will enable an authorized Kia dealer to duplicate the keys easily. Remove the plate and store it in a safe place. Also, record the code number and keep it in a safe and handy place, but not in the vehicle.

▲ WARNING - Ignition Key

Leaving children unattended in a vehicle with the ignition key is dangerous even if the key is not in the ignition. Children copy adults and they could place the key in the ignition. The ignition key would enable children to operate power windows or other controls, or even make the vehicle move which could result in serious bodily injury or even death. Never leave the keys in your vehicle with unsupervised children.

Knowing Your Vehicle

Door Locks

Automatic Door Locks

Operating Door Locks - With Key

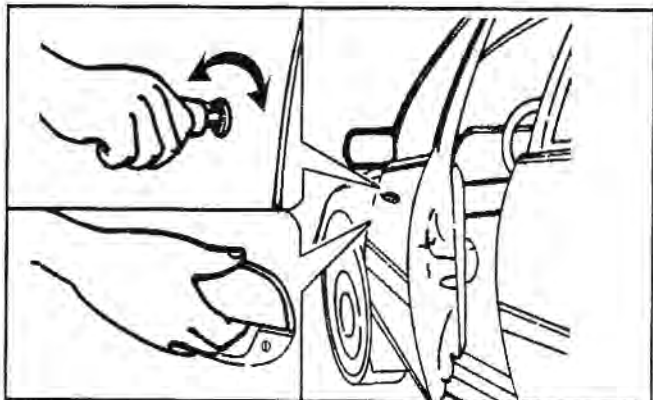

133-04001

- From the driver's door, all four doors can be locked and unlocked with the key.
- Turn the key to the left twice within three seconds to unlock, and once to the right to lock.
- The passenger's door lockset only locks or unlocks passenger's door.

When the doors are locked using the key, the Theft Deterrent System is activated. The horn will sound once to indicate system activation.

For more information about Theft Deterrent System operation, refer to "Driving Your Vehicle", Section 4.

- Once the doors are unlocked, they may be opened by lifting the door handle.

Operating Door Locks - Without Key

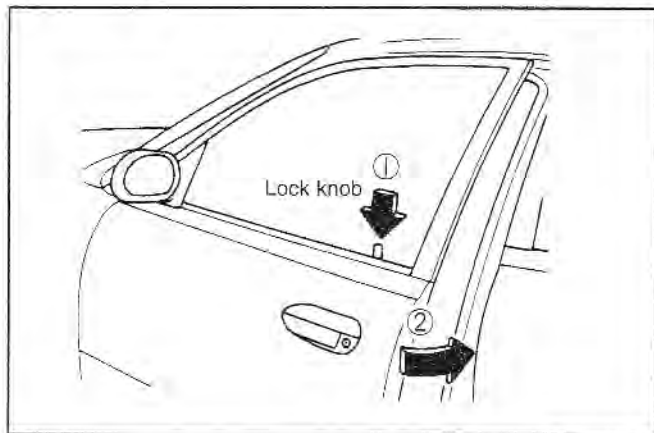

BN7B03003

Depressing the door lock knob and then closing the door enables the door to lock without a key.

* NOTICE

Always remove the ignition key, engage the parking brake, close all windows and lock all doors when leaving your vehicle unattended.

Operating Door Locks From Inside the Vehicle

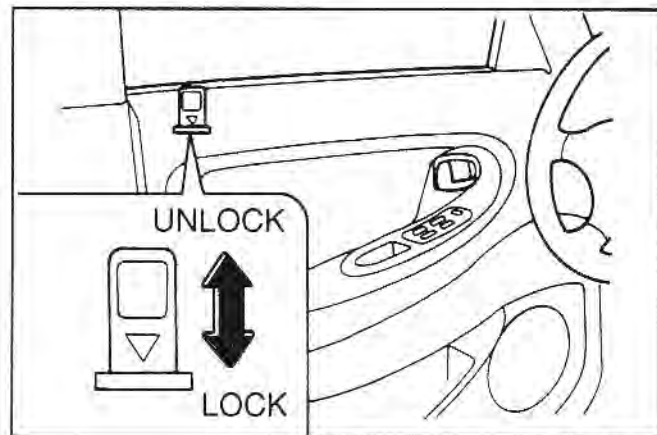

AN7B03004

- To lock a door, depress the door lock knob.
When the driver's door is locked or unlocked using the driver's door lock knob, all the other doors will automatically lock or unlock.
- To unlock, pull the door lock knob up.
- To open, pull the door handle.

- To lock the rear door so that it can't be opened from the inside, push down on the child safety lock on the rear edge of the door before closing the door.
- To open the rear door while the child safety lock is engaged, lift the door lock knob then lift the outside door handle.

 WARNING - Rear Door Locks

If children accidentally open the rear doors while the vehicle is in motion, the child could fall out and be seriously injured. To prevent a child from opening the rear doors from the inside, the rear door safety locks should be used whenever children are in the vehicle.

Windows

Power Windows

The ignition switch must be in the ON position for power windows to operate. Each door has a power window switch that controls that door's window. However, the driver has a power window switch which can block the operation of the three passenger windows.

*** NOTICE**

To prevent the power window system from the possibility of damage, do not open or close more than two windows at the same time. This will also ensure the longevity of the fuse.

Knowing Your Vehicle

Driver's Door Power Window Controls

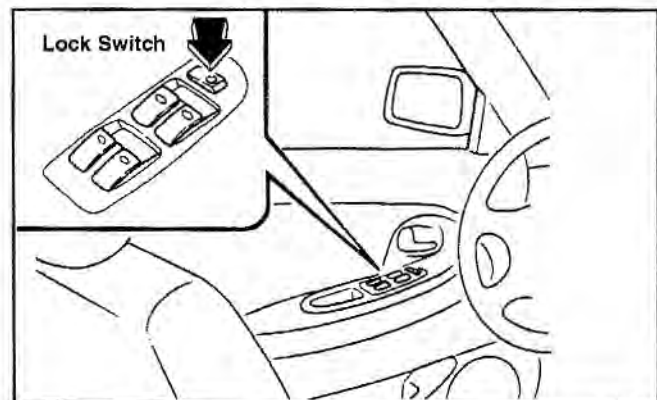

04009A

The driver's door has a master power window switch that controls all the windows in the vehicle. To open a window, press down on the front portion of the corresponding switch. To close a window, pull up on the front portion of the corresponding power window switch.

Power Window Lock Switch Feature

The driver can lock the power window switches on all passenger doors by depressing the left side (flat portion) of the "WINDOW LOCK" switch located on the driver's door to ON (flat side down). When the power window lock switch is ON, only the driver's master control can operate the windows.

⚠ WARNING - Power Windows

Keep the power window lock switch in the driver's door in the ON/"LOCK" (left side/flat portion of switch down) position, except when someone is operating a passenger door window. Serious injury can result (especially to children) from unintentional window operation.

*** NOTICE**

If you notice buffeting and pulsation (wind shock) with either side window open, you should open the opposite window slightly to reduce the condition.

Passenger Doors Power Window Controls

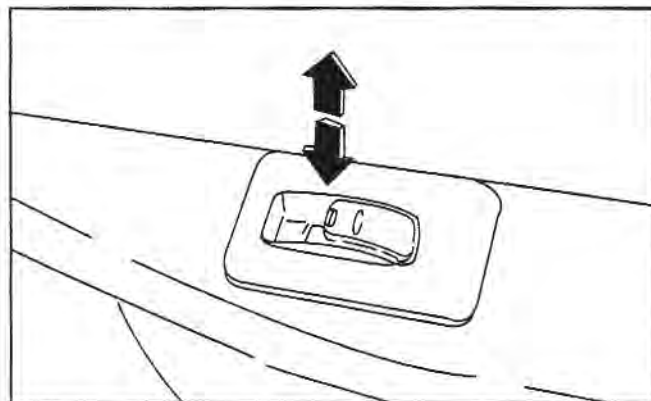

1N7104002

To open a window, press down on the front portion of the power window switch. To close a window, pull up on the front portion of the power window switch.

Knowing Your Vehicle

⚠ WARNING

- **Do not allow children to play with the power windows. They may seriously injure themselves or others.**
- **Always double check to make sure all arms, hands, and other obstructions are safely out of the way before closing a window.**

*** NOTICE**

The driver's door window "LOCK" switch must be in the OFF position (right side/raised portion down) to operate the passenger door windows.

Front Seat

⚠ WARNING - Driver's Seat

- Never adjust the driver's seat while the vehicle is in motion. Doing so could cause loss of vehicular control and serious personal injury or death.
- Do not allow anything to interfere with the normal position of a seatback. Such interference may prevent the seatback from locking which could result in serious injury or death in the event of a sudden stop or collision.
- Always drive and ride with your seatback upright and the lap portion of the safety belt, or lap belt, snug and low across the hips.

Front Seat Adjustment

Moving the Front Seat Forward and Backward

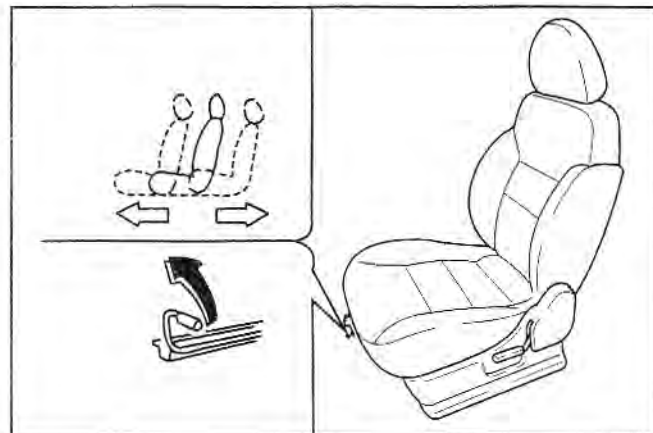

AN7B03008

To move the seat forward or backward, pull up on the lever under the front edge of the seat cushion, slide the seat to the desired position, and release the lever. To ensure the seat is locked in position, try to move the seat.

Knowing Your Vehicle

CAUTION

Do not place anything under the front seats. Loose objects might interfere with the seat slide mechanism or roll out from under the seat. Objects rolling around in the driver's foot area could interfere with the operation of the brake, clutch or accelerator foot pedals.

Adjusting the Front Seatback Recliner



AN7B03009

To change the seatback angle, lean forward slightly and raise the lever located on the outer portion of the seat. Then lean back to the desired angle and release the lever. After adjustment, make sure that the lever has returned to its original locked position.

⚠ WARNING - Front Seat

To reduce the risk of sliding under the lap belt, and potentially suffering serious personal injury or death in the event of a collision, do not use the front seatback in a reclined position while the vehicle is in motion. If a front seat is reclined, the occupant's hips may slide under the lap portion of the safety belt during a collision. If that occurs, the occupant may no longer be properly restrained, and the safety belt could apply restraint forces to the unprotected abdomen, resulting in serious personal injury or death. Therefore, keep the seatbacks in a comfortably upright position whenever the vehicle is in motion.

Knowing Your Vehicle

Lumbar Support (Driver's Seat Only)

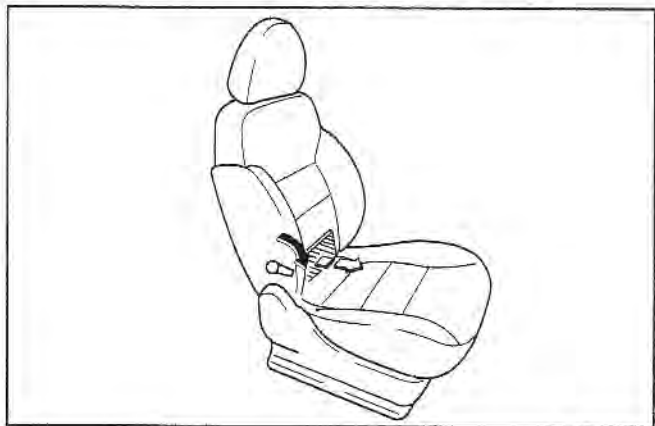

1N7105005

You can adjust the lumbar support by moving the lever on the right side of the driver's seatback. Pivoting the lever toward the front of the vehicle increases the lumbar support. Pivoting the lever toward the rear of the vehicle decreases the lumbar support.

Headrest

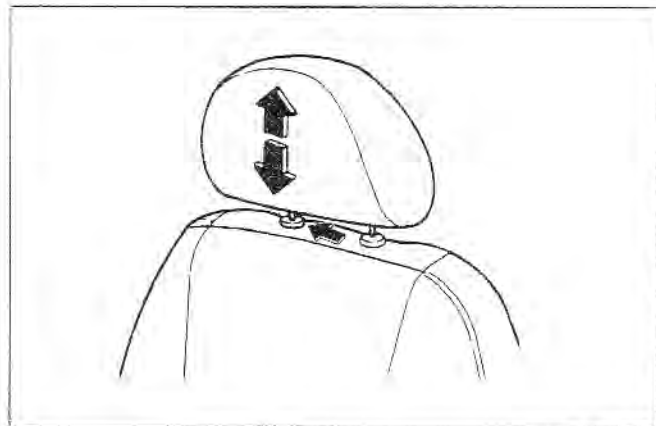

135-07011A

The front seat headrests provide comfort and also help protect your head and neck in the event of certain kinds of collisions.

Adjust the headrest so that the center of it is positioned as high as your ears. Hold the headrest and pull up to raise it. It will lock into position. To lower the headrest, push the release lever on the right side and push down on the headrest.

⚠ WARNING - Headrests

- To reduce the risk of head and neck injuries, don't operate the vehicle with the headrest removed or improperly positioned.
- In order to reduce the chance of injury in the event of a collision, adjust the headrest so its center is as high as your ears.
- Do not attempt to adjust the driver's headrest while you are driving.

Rear Seat

⚠ WARNING - Rear Seatback

- The rear seatback must be securely latched. If not, passengers and objects could be thrown forward and suffer serious injury or death in the event of a sudden stop or collision.
- Luggage and other cargo should be laid flat in the cargo area. If objects are large, heavy, or must be piled, they must be secured. Under no circumstances should cargo be piled higher than the seatbacks. Failure to follow these warnings could result in serious injury or death in the event of a sudden stop, collision or rollover.

(Continued)

Knowing Your Vehicle

(Continued)

- **Passengers should not ride in the cargo area or sit or recline on folded seatbacks while the vehicle is in motion.**
- **When resetting the seatback to the upright position, make sure it is securely latched by pushing it forward and rearward.**
- **To avoid the possibility of burns, do not remove the carpet in the cargo area. Emission controls beneath this floor generate high exhaust temperatures.**

Folding Rear Seat

The rear seat and seatbacks fold forward to increase the size of the cargo area.

1. Move the front seats forward as far as possible. Refer to "Front Seat Adjustment" earlier in this section.
2. Arrange the rear safety belts and buckles in a straight forward position.

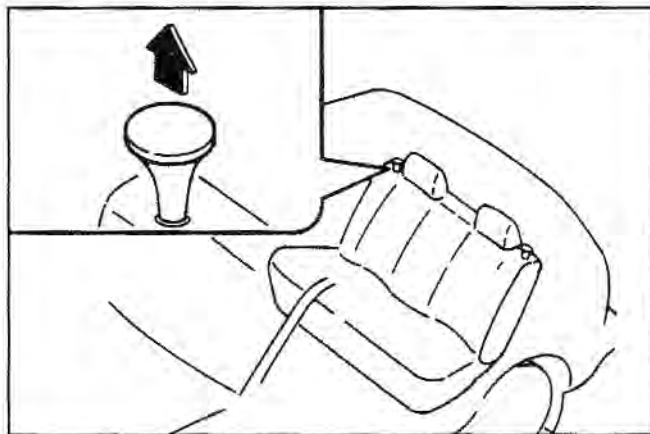

131-05023

3. Pull up on one release knob (located on the outside top of each seatback) and, with your other hand, grasp the inside top of the same seatback and pull forward. Repeat this for the other seatback.

*** NOTICE**

- Do not pull forward on the release knob. Doing so repeatedly could cause it to fatigue and break.
- The safety belts should be moved out of the way before folding the seatbacks fully forward.

4. Pull all safety belts and buckles out from between the "fold" of the seat.

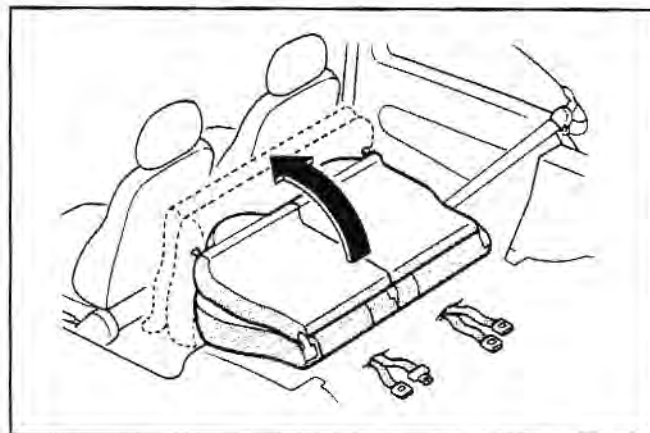

134-07006

5. Grasp the rear of the seat, below the "fold," and pull up and forward. The seat will rotate to a near-vertical position.

Knowing Your Vehicle

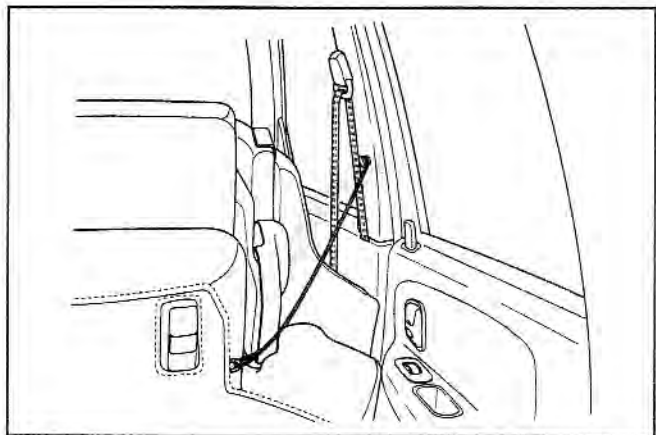

0318

6. Pull the tie-down straps out of their pockets on the (now) top outside of the seats, and place the unattached loops over the buttons in the rear door pillar trim panel (behind the front seat shoulder belts).
7. Adjust the front seats to their previous positions. Refer to "Front Seat Adjustment" earlier in this section.

To unfold the rear seat for passenger use:

1. Remove the loops from the buttons on the rear door pillar trim panel.
2. Rotate the bottom seat cushion down to the floor.
3. Insert the center lap belt and the three (3) safety belt buckles between the seatback and seat cushion.
4. Push the seatbacks to an upright, locked position.

* NOTICE

Make sure the two shoulder belts are positioned in front of the seatbacks to allow for proper use of the safety belts.

5. Make sure the center lap belt and the three (3) safety belt buckles are pulled from between the seat's cushion and the seatbacks for rear seat passenger use.

Safety Belts

Safety Belt Restraint System

⚠ WARNING - Safety Belts

The driver and all passengers should always use the safety belts provided in order to minimize the risk of severe bodily injury.

We strongly recommend that the driver and all passengers be properly restrained at all times by using the safety belts provided with the vehicle. Proper use of the safety belts decreases the risk of severe injury or death in accidents or sudden stops. In most states, and in Canada, the law requires their use.

All seats, except the center rear seat, have lap/shoulder belts. The center rear seat has a lap belt.

Inertial locks in the safety belt retractors allow all of the lap/shoulder safety belts to remain unlocked during normal vehicle operation.

This allows the occupants some freedom of movement and increased comfort while using the safety belts. If a force is applied to the vehicle, such as a strong stop, a sharp turn, or a collision, the safety belt retractors will automatically lock the safety belts.

Since the inertial locks do not require a collision to lock up, you may become aware of the safety belts locking while braking or going around sharp corners.

The center rear seat safety belt does not have an inertial lock so it is always in a locked condition. Whenever possible, use the center rear seat position to install your child restraint. If the center seat is unavailable, a child restraint may be installed in the front passenger seat or in the rear outboard seats using the special auto-lock mode feature provided with these safety belts.

Rear outboard safety belts have been designed to allow a child restraint to be used in these positions without an added locking clip. Those safety belts normally lock only under extreme or emergency conditions (this is the emergency lock mode which uses the locking retractor).

Knowing Your Vehicle

However, they can be adjusted so that they remain fixed and locked when a child restraint is placed in those positions (this auto-lock mode should only be used to secure a child restraint).

The drivers safety belt can only operate in the emergency lock mode.

Safety belts provide the best restraint when:

- The seatback is upright
- The occupant is sitting upright (not slouched)
- The lap belt is snug across the hips
- The shoulder belt is snug across the chest
- The knees are straight forward

To help you remember to fasten your safety belt, a warning light may come on and a chime may sound. See Safety Belt Warning Light and Chime on page 3-22.

WARNING - After a Collision

- Lap/shoulder belt assemblies may be stretched or damaged when subjected to the stress and forces of a collision.
- The entire restraint system should be inspected following any collision. All belts, retractors, anchors and hardware damaged by a collision should be replaced before the vehicle is operated again.

⚠ WARNING - Cargo Area

Passengers should never be allowed to ride in the cargo area of a vehicle. No safety belts are provided for the cargo area. Persons riding in the vehicle without a fastened safety belt are much more likely to suffer serious bodily injury or death during an accident.

⚠ WARNING - Twisted Belts

Never drive or ride with a twisted or jammed safety belt. If you cannot untwist or unjam the safety belt, see your Kia dealer immediately.

⚠ WARNING - Belt Usage

Each seating position in your vehicle has a specific safety belt assembly which includes a buckle and tongue that are designed to be used together:

- 1) Use the shoulder portion of the safety belt on the outside shoulder only. Never wear the shoulder portion of the safety belt under the arm.
- 2) Never swing the safety belt around your neck to fit over the inside shoulder.
- 3) Never use a single safety belt for more than one person.

Knowing Your Vehicle

⚠ WARNING - Safety Belt Care

Safety belts should be inspected periodically for excessive wear or damage. Pull out each belt fully and look for fraying, cuts, burns or other damage.

Pull the safety belt out and let it retract a number of times. Make sure that the lap/shoulder belts return smoothly and easily into the retractor.

Check the latches to make sure they latch and release without interference or delay. Any belt not in good condition or in good working order should be promptly replaced.

⚡ CAUTION

Never close the doors on any part of the lap or shoulder belt. It can damage the safety belt or buckle which could increase the risk of injury in case of an accident.

Safety Belt Warning Light and Chime

If the driver's lap/shoulder belt is not fastened when the key is turned ON or if it is disconnected after the key is ON, the safety belt warning chime sounds for approximately six seconds and the safety belt warning light remains on until the safety belt is buckled.

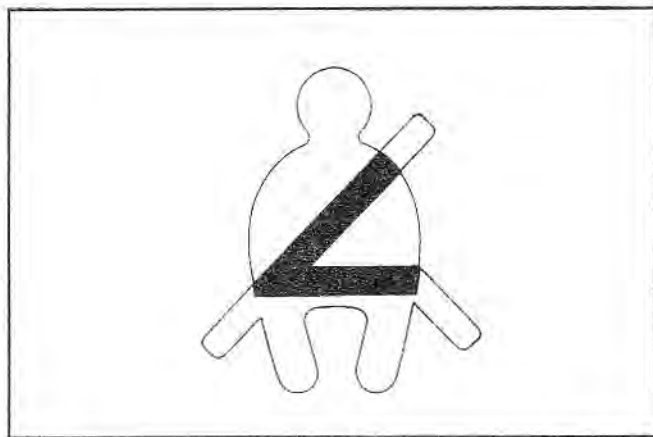

AN7B03016

Front Lap/Shoulder Belt

To fasten the front lap/shoulder belt:

1. Grasp the buckle and tongue plate.
2. Slowly pull the lap/shoulder belt out from the retractor.



AN7B03017

3. Insert the tongue plate into the open end of the buckle until an audible "click" is heard, indicating the belt is locked in the buckle.

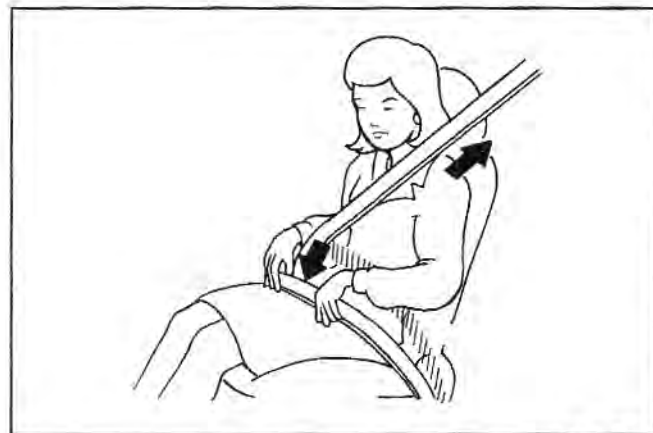

AN7B03018

4. Position the lap portion of the belt across your lap as **LOW ON THE HIPS** as possible to reduce the risk of sliding under it during an accident. Adjust the belt to a **SNUG FIT** by pulling up on the shoulder portion of the safety belt. The belt retractor is designed to take up excess webbing automatically and to maintain tension on the belt. For maximum safety, do not put any excess slack into the safety belt.

Knowing Your Vehicle

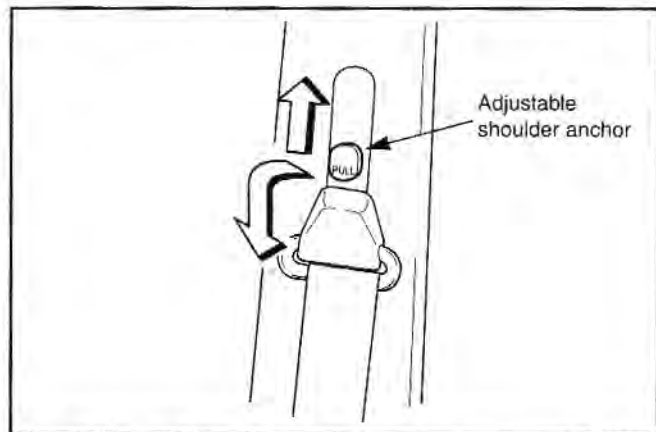

AS2B03026

5. Adjust the shoulder anchor position to your size. To raise the anchor position, pull the knob and push the anchor up. To lower the anchor position, pull the knob and slide the anchor down. After adjustment, make sure the anchor is locked in position.



AN7B03019

To unfasten the front lap/shoulder belt:

Press the release button on the buckle and allow the belt to slowly retract.

⚠ WARNING - Front Safety Belts

- The front seatbacks should always remain in a comfortable, upright position while the vehicle is in motion. The safety belt system will provide the most protection with the seatbacks in an upright position.
- Never wear the shoulder portion of the safety belt under the outside arm or behind the back.
- Never wear the shoulder portion of the safety belt across the neck or face.
- Wear the lap portion of the safety belt as low as possible. Be sure the lap belt fits snugly around the hips. Never wear the lap belt over your waist.
- Make sure the safety belts are not twisted while in use.

(Continued)

(Continued)

- Never use a single belt to restrain more than one person at a time.

Failure to follow these warnings will increase the chance and severity of injury in an accident.

Rear safety belts

Two kinds of belts are provided:

- Lap/shoulder belts for people who sit on the outboard sides of the rear seat.
- A lap belt for people who sit in the center of the rear seat.

Knowing Your Vehicle

Rear Lap/Shoulder Belt (Outboard Seats)

To fasten the rear lap/shoulder belt:

1. Grasp the buckle and tongue plate.
2. Slowly pull the lap/shoulder belt out.



AN7B03020

3. Insert the tongue plate into the open end of the buckle until an audible "click" is heard, indicating the belt is locked in the buckle.

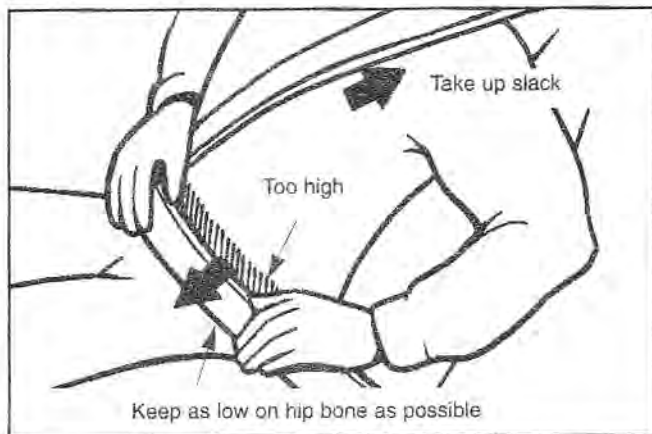

AN7B03021

4. Position the lap portion of the belt across your lap as **LOW ON THE HIPS** as possible to reduce the risk of sliding under it during an accident. Adjust the belt to a **SNUG FIT** by pulling up on the shoulder portion of the safety belt. The belt retractor is designed to take up excess webbing automatically and to maintain tension on the belt. This is for your safety. Do not put excess slack into the safety belt.

To unfasten:

Press the button on the buckle and allow the belt to slowly retract.

▲ WARNING - Rear Lap/Shoulder Safety Belts

- Never wear the shoulder portion of the safety belt under the outside arm or behind the back.
- Never wear the shoulder portion of the safety belt across the neck or face.
- Wear the lap portion of the safety belt as low as possible. Be sure the lap belt fits snugly around the hips. Never wear the lap belt over your waist.
- Make sure the safety belts are not twisted while in use.
- Never use a single belt to restrain more than one person at a time.

Failure to follow these warnings could increase the chance and severity of injury in an accident.

Lap Belt Only (Rear Center Seat)

To fasten the rear lap belt:

1. Grasp the buckle end and pull it low over the hips.
2. Insert the tongue plate into the open end of the buckle until an audible “click” is heard, indicating the latch is locked. Make sure the belt is not twisted.

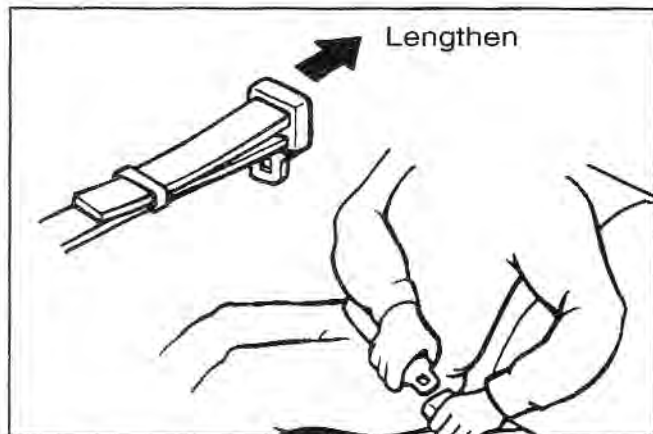

AN7B03022

Knowing Your Vehicle

3. Grasp the free portion of the belt webbing and pull until the belt is snug over the hips and lower abdomen. If it becomes necessary to lengthen or shorten the belt, hold the latch plate tongue at right angles to the webbing and pull.

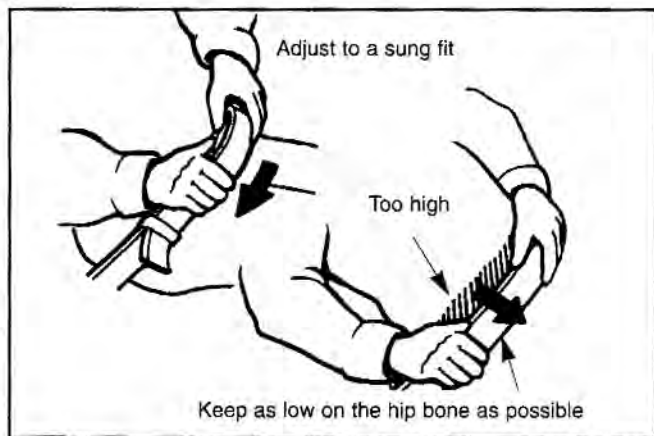

AN7B03023

4. Make sure that the belt is placed as **LOW ON THE HIPS** as possible.

To unfasten the rear lap belt:

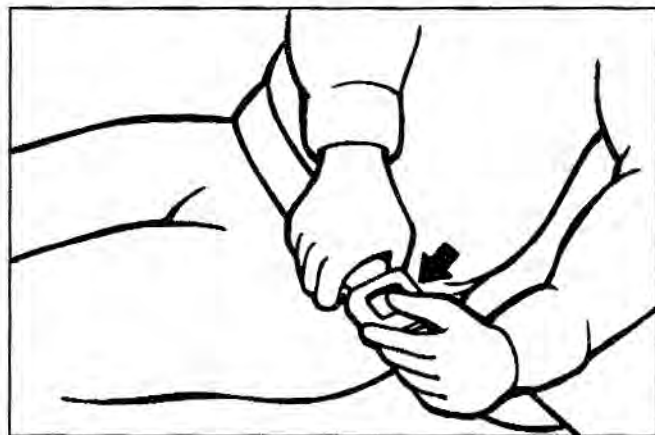

AN7B03024

Press the release button on buckle.

▲ WARNING - Center Rear Lap Belt

Be sure the center rear lap belt is positioned snugly around the hips, and not on the waist. Failure to position the center rear lap belt snugly around the hips will increase the chance and severity of injury in the event of a collision.

Proper Use and Care of the Safety Belt System

To ensure that the safety belts provide the maximum protection, please follow these instructions:

- Use the belts at all times - even on short trips.
- If the safety belt is twisted, straighten it prior to use.
- Keep sharp edges and damaging objects away from the belt.

- Periodically inspect belt webbing, anchors, buckles, and all other parts for signs of wear, and damage. Replace damaged, excessively worn or questionable parts immediately.
- To clean the belt webbing, use any mild soap solution recommended for cleaning upholstery or carpets. Follow the instructions provided with the soap. Do not bleach or dye the webbing because this may weaken the webbing fibers and allow them to fail when loaded in a collision.
- Do not make modifications or additions to the safety belt.
- After wearing a safety belt, make sure it fully retracts to the stowed position. Do not allow the belt to get caught in the door when you close it.

Knowing Your Vehicle

Restraint of Pregnant Women

Pregnant women should wear lap/shoulder belt assemblies whenever possible according to specific recommendations by their doctors. The lap portion of the belt should be worn AS SNUGLY AND AS LOW AS POSSIBLE.

⚠ WARNING - Pregnant Women

Pregnant women must never place the lap portion of the safety belt over the area of the abdomen where the fetus is located or above the abdomen.

Restraint of Infants and Small Children

Small children and infants should be restrained by an approved child-restraint system to help protect them while riding in a vehicle.

Never allow a child to stand or kneel on the seat of a moving vehicle. Never allow a safety belt to be placed around both a child and an adult or around two children at the same time.

⚠ WARNING - Children on Laps

Never hold a child on your lap or in your arms in a moving vehicle. Even a very strong person cannot hold onto a child in the event of even a minor collision.

Many companies manufacture child-restraint systems (often called child seats) for infants and small children. An acceptable child-restraint system must always satisfy Canadian Motor Vehicle Safety Standards. Make sure that any child-restraint system you use in your vehicle is labeled as complying with those safety standards.

The child restraint system should be chosen to fit both the size of the child and the size of the vehicle seat. Be sure to follow any instructions provided by the child restraint system manufacturer when installing the child-restraint system.

CAUTION - Hot Metal Parts

Since a safety belt or child restraint system can become very hot in a closed vehicle during warm sunny weather, be sure to check the seat cover and buckles before placing a child anywhere near them.

Restraint of Large Children

As children grow, they may need to use new child restraints, including larger child seats or booster seats, which are appropriate for their increased size.

A child who has outgrown available child restraint systems should use the belts provided in the vehicle. When seated, the child should be restrained by the lap/shoulder belt.

If the shoulder belt touches the child's neck or face, you can use some after-market devices made by independent manufacturers which help pull the shoulder belt lower and away from the child's face or neck.

WARNING - Shoulder Belts on Children

- **Never allow a shoulder belt to be in contact with a child's neck or face while the vehicle is in motion.**
- **If safety belts are not properly worn and adjusted on a child, the risk of death or serious injury to such a child is high.**

Knowing Your Vehicle

⚠ WARNING - Child Restraints

- Children will be endangered in a crash if their child restraint systems are not properly secured by child safety seat tether anchor in the vehicle.
- According to accident statistics, children are provided more protection when properly restrained in the rear seats instead of the front seats.
- When a child restraint system is not in use, make sure that it is secured by a safety belt so that it will not be thrown forward in the event of a sudden stop or accident.
- If your vehicle has a split-bench rear seat, the installation of child restraint on middle anchorage fitting would be unsafe as the child seat tether would slide down between the split.

Child Restraint Anchor Position

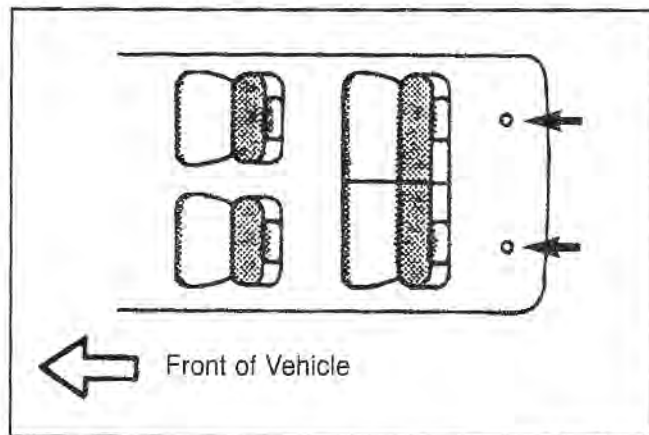

IN7B03011A

Child restraint anchorage fittings are installed in the floor of the rear cargo area as shown above.

Anchor Installation

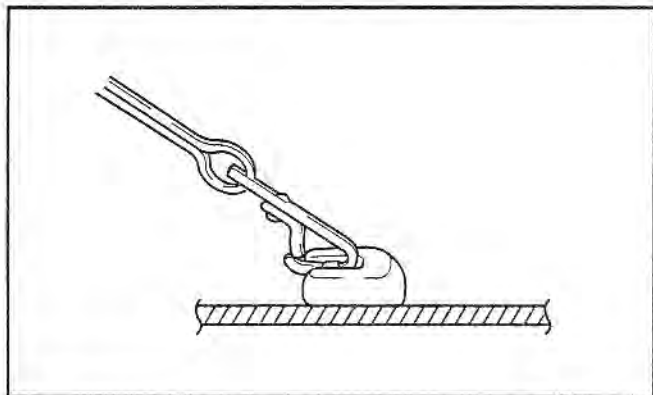

AS2B03064A

Knowing Your Vehicle

WARNING - Restraint Instructions

Failure to observe this manual's instructions regarding child restraint systems and the instructions provided with the child restraint system could increase the chance and/or severity of injury in an accident.

WARNING - Child Restraint Anchorage

Child restraint anchorages are designed to withstand only those loads imposed by correctly fitted child restraints. Under no circumstances are they to be used for adult seat belts or harnesses or for attaching other items or equipment to the vehicle.

⚠ WARNING - Child Restraint

Check that the child restraint system is secure by pushing and pulling it in different directions. Incorrectly fitted child restraints may swing, twist, tip or come away causing death or injury.

⚠ WARNING - Child Restraint Placement

Never use a rear-facing child restraint in the front passenger seat. A child in a rear-facing child restraint installed in the front passenger seat can be severely or fatally injured by an air bag which could impact the child restraint with great force when the air bag inflates.

Air Bag - Supplemental Restraint System

What Your Air Bag System Does

Your vehicle is equipped with a Supplemental Restraint System (SRS), which includes two air bags for the driver and one air bag for the front passenger. The two air bags for the driver include an air bag in the steering wheel and another air bag, called a "knee air bag", which is stored below the steering column inside the driver's side knee bolster. The steering wheel air bag is designed to help restrain the forward movement of the driver's head and chest in a severe frontal collision. The knee air bag helps hold the driver in the proper position to receive the maximum protection from the steering wheel air bag and it offers added protection for the driver's legs in the event of such a collision. The passenger air bag is designed to help restrain the forward movement of the passenger's head and chest in a severe frontal collision.

Knowing Your Vehicle

What Your Air Bag System Does Not Do

The air bag system is designed to supplement or add to the protection offered by the safety belt system. **IT IS NOT A SUBSTITUTE FOR THE SAFETY BELT.**

Why Didn't My Air Bag Go Off in a Collision?

There are many types of accidents in which the air bag would not be expected to provide additional protection. These include side or rear impacts, rollovers, and second or third collisions in multiple-impact accidents, as well as low speed impacts.

Remember, air bags are **ONLY** designed to inflate when the impact would throw the occupant into the air bags – generally from an area a little to the left to a little to the right of straight ahead.

In other words, just because your vehicle is damaged and even if it is totally unusable, don't be surprised that the air bags did not inflate.

The Importance of Using Safety Belts

There are four very important reasons to use safety belts even with an air bag supplemental restraint system. They:

- help keep you in the proper position (away from the air bag) when it inflates.
- reduce the risk of harm in rollover, side or rear impact collisions, because an air bag is not designed to inflate in such situations.
- reduce the risk of harm in frontal collisions which are not severe enough to actuate the air bag supplemental restraint system.
- reduce the risk of being thrown from your vehicle.

⚠ WARNING - Air Bags & Safety Belts

- Even in vehicles with air bags, you and your passengers must always wear the safety belts provided in order to minimize the risk and severity of injury in the event of a collision or rollover.
- Always wear your safety belt. It can help keep you away from the air bags during heavy braking just before a collision.
- Air bags are designed to inflate only in severe frontal collisions and will generally not provide protection in side or rear impacts, rollovers or less severe frontal collisions. They will not provide protection from later impacts in a multi-impact collision.
- If your vehicle has been subjected to flood conditions (e.g. soaked carpeting/standing water on the floor of the vehicle, etc.) or if your vehicle has become flood damaged in any way, do not

(Continued)

(Continued)

attempt to start the vehicle or put the key in the ignition before disconnecting the battery. This may cause air bag deployment, which could result in serious personal injury or death. Have the vehicle towed to an authorized Kia dealer for inspection and necessary repairs.

Air Bag System Components

The main components of your SRS are:

- An air bag in the steering wheel.
- A second air bag in the driver's side knee bolster.
- A third air bag in the passenger's side dashboard.
- A diagnostic system that continually monitors system operation.
- An indicator light to warn you of a possible problem with the system.
- Emergency power backup in case your car's electrical system is disconnected in a crash.

Knowing Your Vehicle

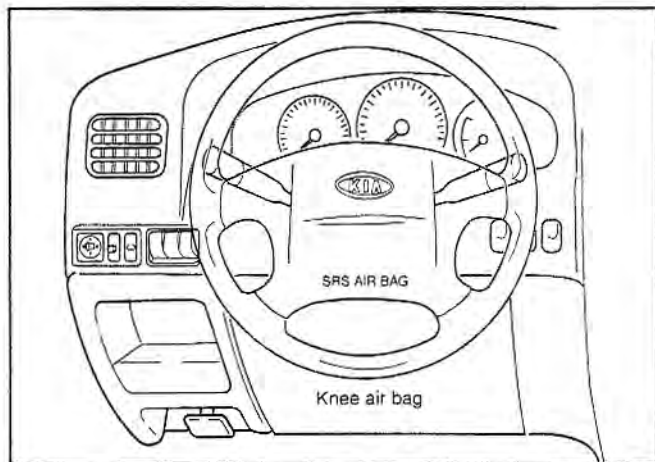

AN7B03030E

To indicate that your vehicle is equipped with driver's and passenger's side air bags, the air bag covers on the steering wheel and on the dashboard are marked "SRS AIR BAG" and the cover on the driver's side knee bolster, located below the steering wheel on the underside of the instrument panel is marked "KNEE AIR BAG."

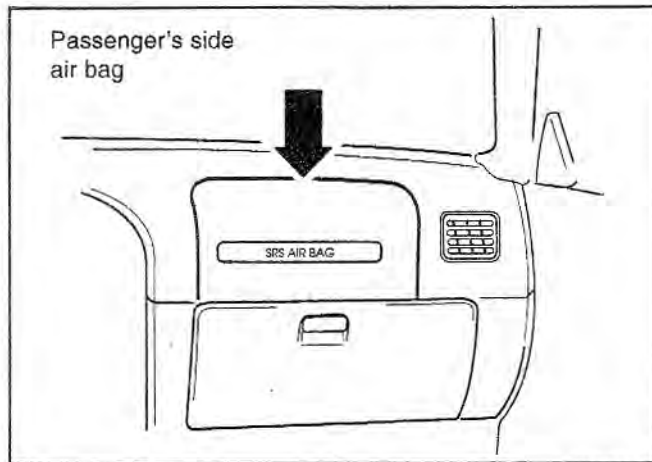

AN7B03031

How the Driver's Air Bags (SRS) Work

The driver's air bags are stored in the steering wheel hub and in the knee bolster below the steering column. The passenger's air bag is stored in the dashboard above the glove box.

If you ever have a severe frontal collision, your air bags will instantly inflate to help protect you from serious physical injury or death.

There is no single vehicle speed at which the air bags will inflate. Generally, air bags are designed to inflate in severe frontal collisions. The air bag Supplemental Restraint System (SRS) reacts to the severity of a collision and its direction. These two factors determine whether the sensors send out an electronic deployment/inflation signal. Whether the air bags will inflate depends on a number of factors including vehicle speeds, angles of impact and the density and stiffness of the vehicles or objects which your vehicle hits in the collision.

The air bags are designed to inflate instantly in the event of a severe frontal collision in order to help protect the driver and passenger from serious physical injury.

The air bags will completely inflate and deflate in less than 1/10 of a second. The speed of inflation and deflation protects the driver's ability to operate the vehicle. This is important in crashes where a vehicle continues to move after an impact and the driver still has some control of the vehicle's steering, braking, throttle and/or transmission systems.

It is virtually impossible for you to see the air bags inflate during an accident. It is much more likely that you will simply see the deflated air bags hanging out of their storage compartments after the collision.

In order to help provide protection in a severe collision, the air bags must inflate rapidly. However, that speed also causes the air bags to expand with a great deal of force. The speed of this inflation has been determined by the Canadian Motor Vehicle Safety Standards (CMVSS) to reduce the likelihood of serious or life-threatening injuries and is thus a mandatory part of air bag design.

Knowing Your Vehicle



However, air bag inflation can also cause injuries which may include facial abrasions, bruises and broken bones.

There are even circumstances under which contact with the steering wheel air bag can cause fatal injuries, especially if the occupant is positioned excessively close to the steering wheel.

YOU MUST ALWAYS SIT AS FAR BACK FROM THE STEERING WHEEL AIR BAG AS POSSIBLE, WHILE STILL MAINTAINING A COMFORTABLE SEATING POSITION FOR GOOD VEHICLE CONTROL, IN ORDER TO REDUCE THE RISK OF INJURY OR DEATH IN A COLLISION.

▲ WARNING - Air Bag Injuries

- Sit as far back from the steering wheel as possible without interfering with your control of the vehicle. Positioning yourself too close to the steering wheel can result in serious or even fatal injuries if the air bag deploys.
- Never place objects over the air bag storage compartments or between the air bags and yourself. Due to the speed and force of the air bag inflation, such objects could hit your body at high speed and cause severe bodily injury and even death.

When the air bags inflate, they make a loud noise and they leave smoke and powder in the air inside of the vehicle. This is normal and is a result of the ignition of the air bag inflator.

After the air bags inflate, you may feel substantial discomfort in breathing due to the contact of your chest to both the safety belt and the air bag, as well as from breathing the smoke and powder.

We strongly urge you to open your doors and/or windows as promptly as possible after impact in order to reduce discomfort and prevent prolonged exposure to the smoke and powder.

⚠ WARNING - Hot Metal Parts

When the air bags deploy, the air bag inflators in the steering wheel and/or below the dashboard are very hot. To prevent injury, do not touch the air bag storage areas internal components immediately after an air bag has inflated.

Special Information About the Passenger Air Bag

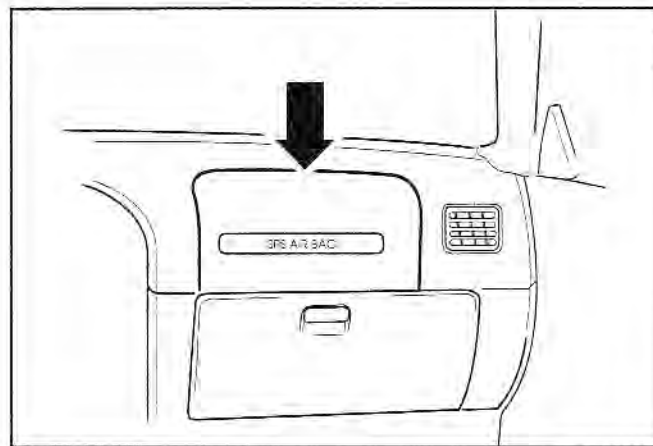

AN7B03031

The front seat passenger's air bag is much larger than the steering wheel air bag and inflates with considerably more force. It can seriously hurt or kill a passenger who is not in the proper position and wearing the safety belt properly. The front passenger should always move their seat as far back as practical and sit back in their seat.

Knowing Your Vehicle

It is essential that the front passenger always wear their safety belt, even when moving in a parking lot or up a driveway into a garage. The reason for this is that in most frontal impacts, the occupants are thrown forward. If the right front passenger is not wearing their safety belt, they will be directly in front of the storage compartment when inflation occurs. In that situation, serious injury or death is possible.

⚠ WARNING - Right Front Seat

Pre-impact braking could throw an unbelted passenger toward or onto the air bag storage compartment. Upon impact in a collision, the air bag would rapidly inflate and possibly severely injure or kill that occupant who failed to wear their safety belt.

Because of the air bag, you should **NEVER INSTALL A REAR-FACING CHILD RESTRAINT SYSTEM IN THE FRONT PASSENGER SEAT**. There is a very significant risk of serious or fatal injuries to a child in a rear-facing child restraint if the right front passenger air bag inflates.

We also strongly recommend that you do not put a front-facing child restraint system in the passenger seat. If a front-facing child restraint system must be used in the front passenger's seat and the air bag inflates, it could seriously or fatally hurt a child who is not in the proper position or properly restrained.

⚠ WARNING - Front Passengers

- **Never use a rear-facing child restraint in the front seat. In the front seat, a rear-facing child restraint would be positioned too close to where the air bag is stored and in the event an air bag deploys, the air bag would impact the rear-facing child restraint and cause serious injuries or death.**
- **Failure to observe the instructions provided with the child restraint system could increase the risk and/or severity of injury in an accident.**

Air Bag Warning Light

The purpose of the air bag warning light in your instrument panel is to alert you of a potential problem with your Air Bag - Supplemental Restraint System (SRS).

Have the system checked if:

- The light does not illuminate briefly when you turn the ignition ON.
- The light stays on after the engine starts.
- The light comes on or flashes while you are driving.



AS2B03035

Knowing Your Vehicle

Supplemental Restraint System Service

Your Supplemental Restraint System is virtually maintenance-free. There are no parts you can safely service by yourself. The entire SRS system must be inspected by an authorized Kia dealer 10 years after the date that the vehicle was manufactured.

You must have the system serviced under the following circumstances:

- If an air bag ever inflates, the air bag must be replaced. Do not try to remove or discard the air bag by yourself. This must be done by an authorized Kia dealer.
- If the air bag warning indicator light alerts you of a problem, have the air bag system checked as soon as possible. Otherwise, your air bag might not inflate when you need it.

**▲ WARNING - Air Bag (SRS)
Malfunctions**

- Do not modify your steering wheel or any other part of the Supplemental Restraint System. Modification could make the system ineffective.
- Do not work on the system's components or wiring. This could cause the air bags to inflate inadvertently, possibly seriously injuring someone. Working on the system could also disable the system so that the air bags would not deploy in a collision.

Knowing Your Vehicle

Rear Hatch

Opening the Rear Hatch

To open the rear hatch:

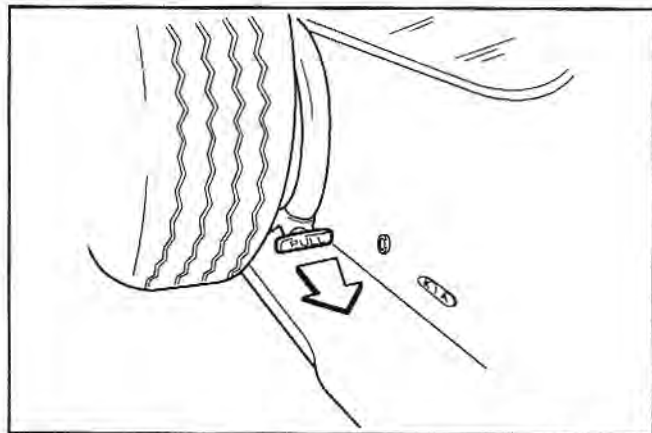

AN7B03034

1. Reach behind the tire and pull the release lever on the carrier and swing the carrier out.

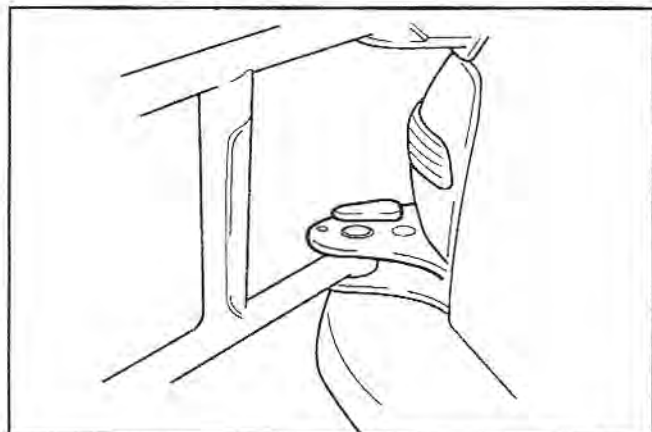

AN7B03035

2. If you swing the carrier out, the lock lever located on the lower hinge of the carrier will be locked automatically.

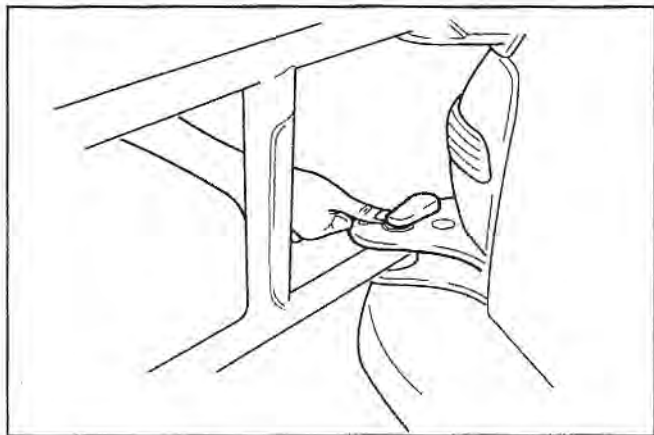

AN7B03036

3. To push the carrier against the rear hatch, you have to pull the lever inward and push the carrier at the same time.

Handle the spare tire carrier carefully. It is heavy because of the attached spare tire. Pushing the carrier hard against the rear hatch may damage the rear hatch and/or rear window.

* NOTICE

When closing the spare tire carrier, push the tire at the bottom. If you push the tire at the top, the carrier will not lock properly. This may cause a rattling noise while driving as well as damage to the hatch and/or rear body panels.

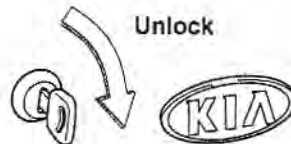

BN7B03033

4. Insert the key into the lock in the rear hatch.
5. Rotate the key to the right (approximately one-quarter turn).

Knowing Your Vehicle

6. Carefully raise the rear hatch.

⚠ WARNING - Rear Hatch

- Check to be sure the rear hatch is completely closed before driving. If the rear hatch is open, exhaust gases can enter the vehicle.
- Occupants should never ride in the rear cargo area. To avoid injury in the event of an accident or sudden stops, occupants should always be properly restrained in the vehicle.

Hood

Opening the Hood:

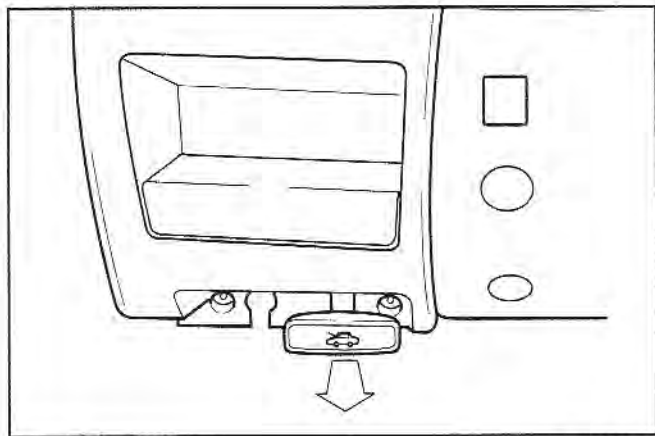

AN7B03037

1. Pull the release lever on the lower left side of the instrument panel to unlatch the hood.

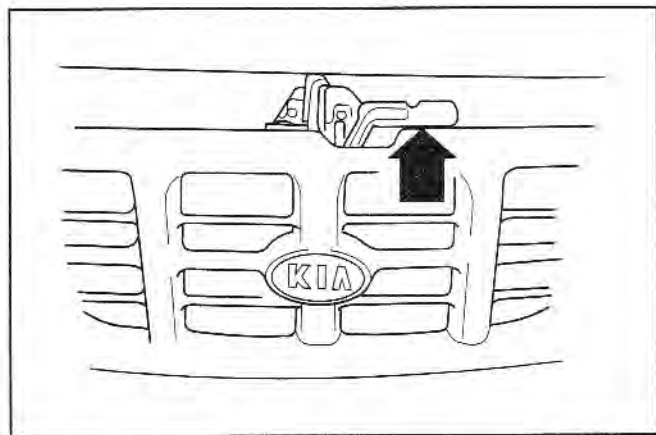

AN7B03038

2. Go to the front of the vehicle, raise the hood a little, pull the secondary latch up and lift the hood.

Knowing Your Vehicle

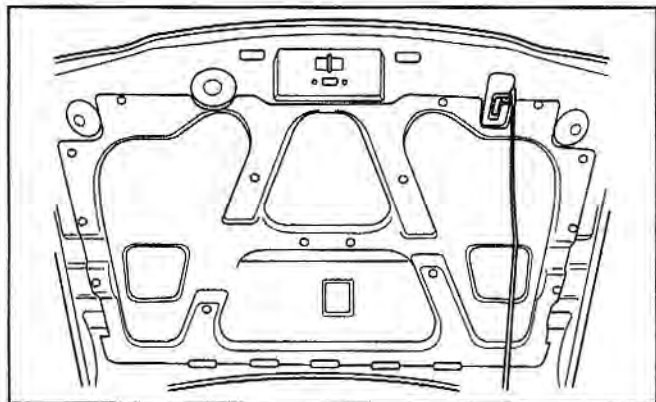

BN7B03039

3. Hold the hood open with the support rod by inserting the free end of the rod into the L-shaped slot located below the arrow stamped into the hood.

CAUTION

Before dropping the hood, make sure that all engine parts and tools have been removed from the engine area and that no one's hands are near the hood opening.

Closing the Hood:

- Check the area under the hood to make certain all filler caps are in place and that all loose items have been removed.
- Secure the support rod in its clip.
- Lower the hood to about 30 cm (12 inches) height and then let it drop to properly lock in place.
- Check to make sure the hood is closed.

Fuel Filler Lid

Remote Fuel Filler Lid Release

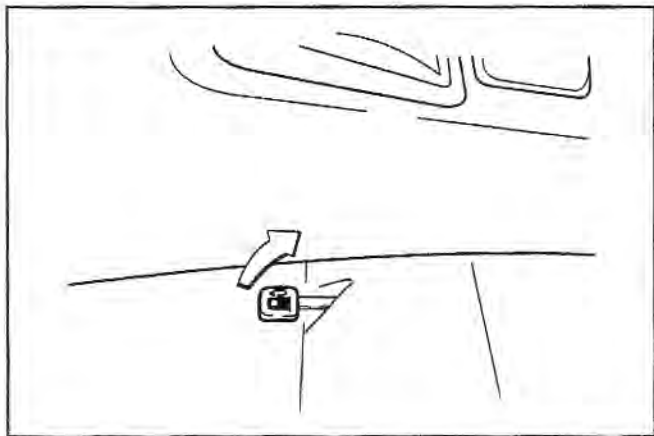

AN7B03040

Pull up on the release lever next to the driver's seat to open the filler lid.

Manual Fuel Filler Lid Release

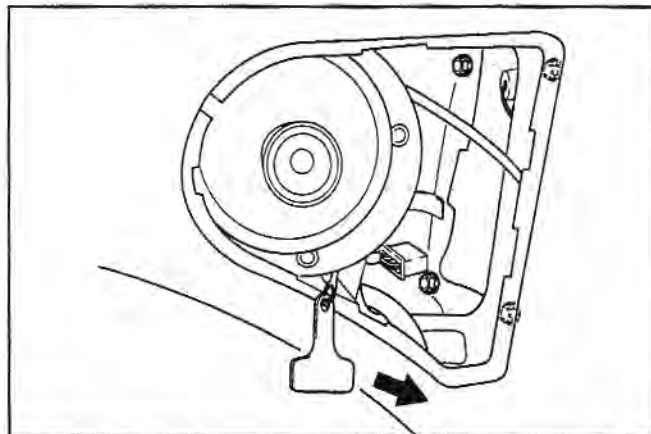

AN7B07041A

If the fuel filler lid does not open using the remote fuel filler lid release, you can open it manually. Unsnap and remove the panel on the right rear side of the cargo area. Pull the handle toward the rear of the vehicle.

Knowing Your Vehicle

CAUTION

To avoid injury from sharp objects, it is recommended that protective gloves be worn when opening the fuel filler door manually.

WARNING - Refueling

- Fuel may be under pressure. Always remove the fuel cap carefully and slowly. If the cap is venting fuel or if a hissing sound is heard, wait until the condition stops before completely removing the cap. If these precautions are not followed, fuel may spray out and cause serious personal injury.
- Fuel vapor is extremely hazardous and can explode. When refueling, always stop the engine and never allow sparks or open flames near the filler neck. Always put out cigarettes and other smoking materials before refueling.

- To remove the cap, turn it counterclockwise.
- To install the cap, turn it clockwise until it clicks several times. This indicates that the cap is securely tightened.

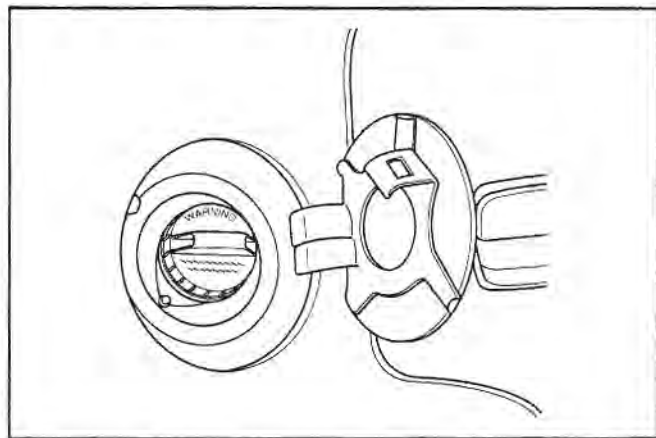

BN7B03042

The fuel filler pipe is designed to prevent filling the fuel tank with anything but unleaded fuel.

* NOTICE

- If the fuel filler cap requires replacement, use only a genuine Kia cap for your vehicle. An incorrect fuel filler cap can result in a serious malfunction of the fuel system or emission control system. Correct replacement caps are available at authorized Kia dealers.
- Do not spill fuel on the exterior surfaces of the vehicle. Any type of fuel spilled on painted surfaces may damage the paint.
- A loose fuel filler cap may cause the "Check Engine" light in the instrument panel to illuminate unnecessarily.
- If the fuel filler lid will not open in cold weather because the area around it is frozen, push or lightly tap the lid.

Steering Wheel

Horn

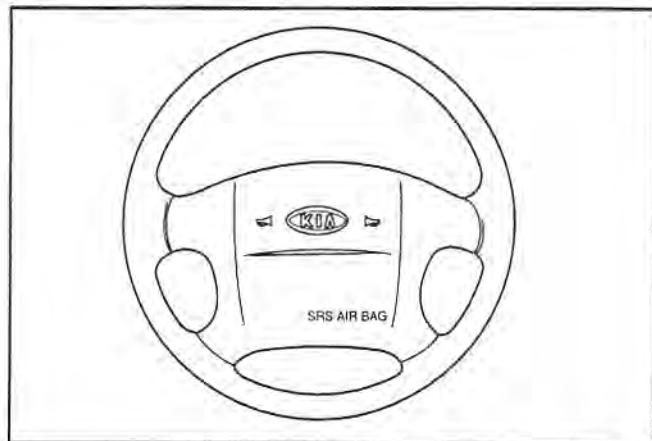

AN7B03030

To sound the horn, press the horn symbol on your steering wheel.

Check the horn regularly to be sure it operates properly.

Knowing Your Vehicle

Tilt Steering

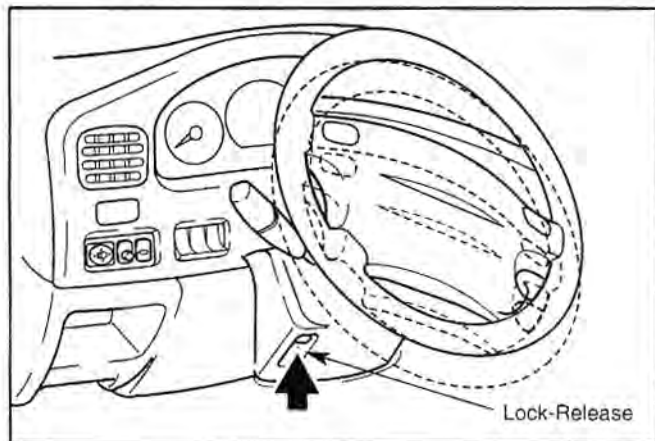

1N7102005B

To change the steering wheel angle, pull up on the lock release (located beneath the steering column), adjust the steering wheel to the desired angle, then release the lock-release to lock the steering wheel in place. The steering wheel should be positioned so that it feels comfortable to you when driving, while permitting you to see the instrument panel warning lights and gauges.

⚠ WARNING - Tilt Steering

- Never adjust the position of the steering wheel while the vehicle is in motion, or you may lose control of the vehicle.
- After adjusting, push the steering wheel up and down to be certain it is locked in position.

Mirrors

Outside Rearview Mirror

Be sure to adjust mirror angles before driving.

⚠ CAUTION

- *The right outside rearview mirror is convex. Objects seen in the mirror are closer than they appear.*
- *Use your interior rearview mirror or direct observation to determine the actual distance of following vehicles when changing lanes.*

* NOTICE

Do not scrape ice off the mirror face; this may damage the surface of the glass. If ice should restrict movement of the mirror, do not force the mirror for adjustment. To remove ice, use a de-icer spray, or a sponge or soft cloth with very warm water.

Outside Rearview Mirror Electric Remote Control

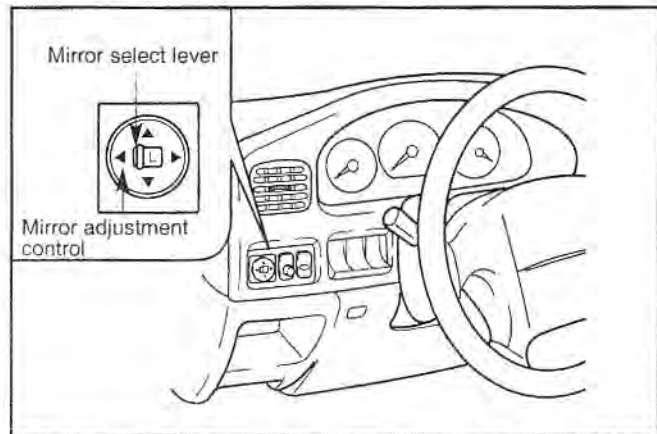

BN7B03043B

The electric remote control mirror switch, located on the left side of the instrument panel, allows you to adjust the position of the left and right outside rearview mirrors. To adjust the position of either mirror, move the lever to R or L to select the right side mirror or the left side mirror, then press an arrow on the mirror adjustment control to position the selected mirror up, down, left or right.

* NOTICE

The mirrors stop moving when they reach the maximum adjusting angles, but the motor continues to operate while the switch is depressed. Do not depress the switch longer than necessary, the motor may be damaged.

Knowing Your Vehicle

Day/Night Rearview Mirror

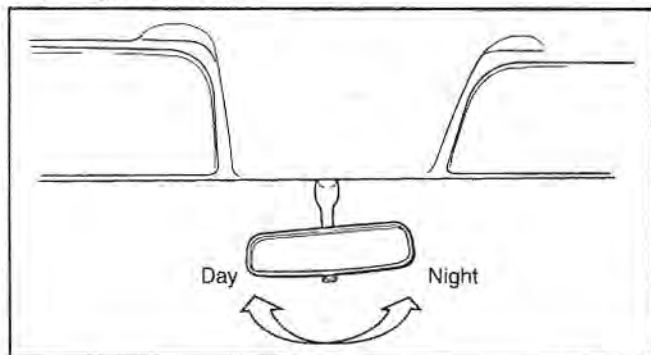

1RS104017A

Adjust the rearview mirror to center on the view through the rear window. Make this adjustment before you start driving and while the day/night lever is in the day position.

Pull the day/night lever toward you to reduce glare from the headlights of vehicles behind you during night driving. *Remember that you lose some rearview clarity in the night position.*

CAUTION

Do not allow objects in the rear seat or cargo area to interfere with your vision out the rear window.

Interior Lights

Dome Light

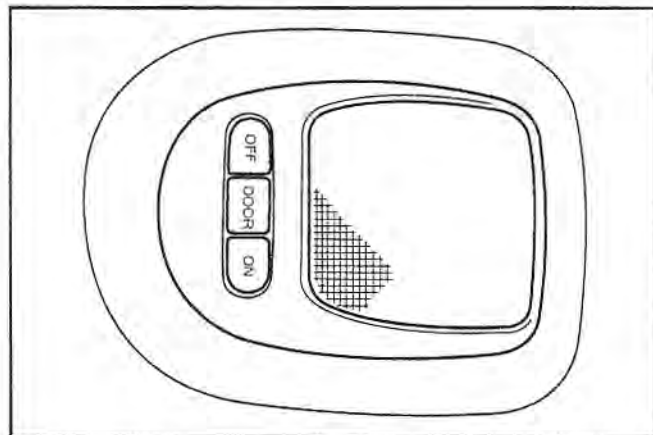

BN7B07031A

The dome light switch has three positions as described below:

- OFF – The light stays off even when a door is open.
- DOOR – The light turns on or off when a door is opened or closed.
- ON – The light turns on and stays on even when the doors are all closed.

Rear Cargo Area Light

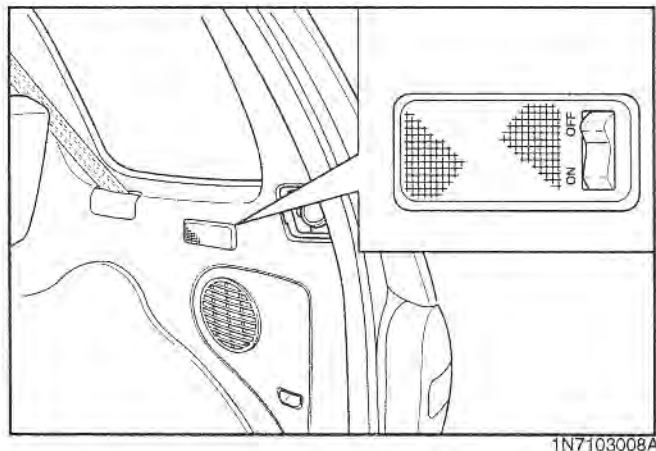

The cargo area light switch has two positions as described below:

- OFF – The light stays off even when the rear hatch is open.
- ON – The light comes on when the rear hatch is open.

Cup Holder

Front Cup Holder

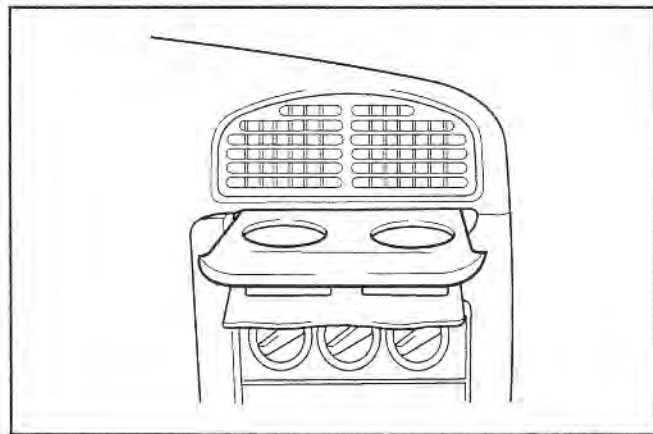

Press the cup holder in, then release it to allow the cup holder to slowly extend from the instrument panel.

Knowing Your Vehicle

⚠ WARNING - Hot Liquids

- Do not place uncovered cups of hot liquid in the cup holder while the vehicle is in motion. If the hot liquid spills, you could be burned. Such a burn to the driver could cause a loss of control of the vehicle.
- To reduce the risk of personal injury in the event of a sudden stop or collision, do not place bottles, glasses, cans, etc in the cup holder while the vehicle is in motion.

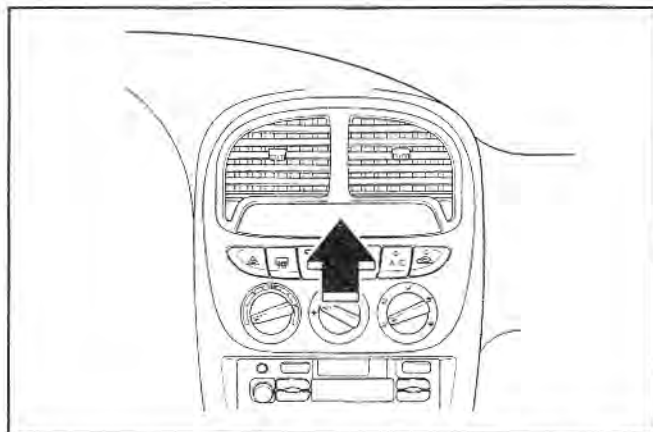

AN7B03048A

To return the cup holder to its closed position, push it completely into the instrument panel. The cup holder latching mechanism will “click” when it is locked into position.

Rear Cup Holder

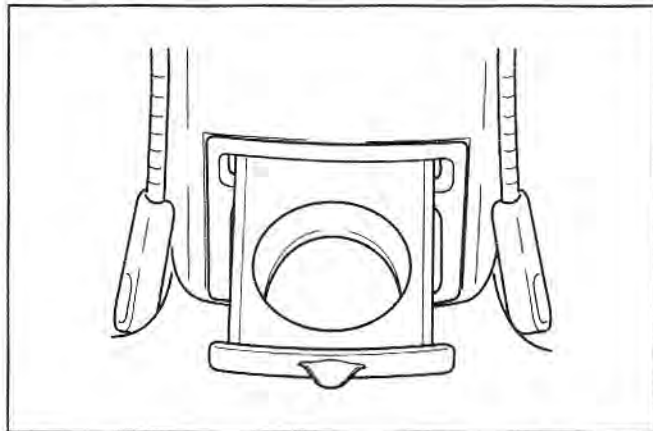

AN7B03049

To use the rear cup holder, pull it out.

Console Storage Compartment

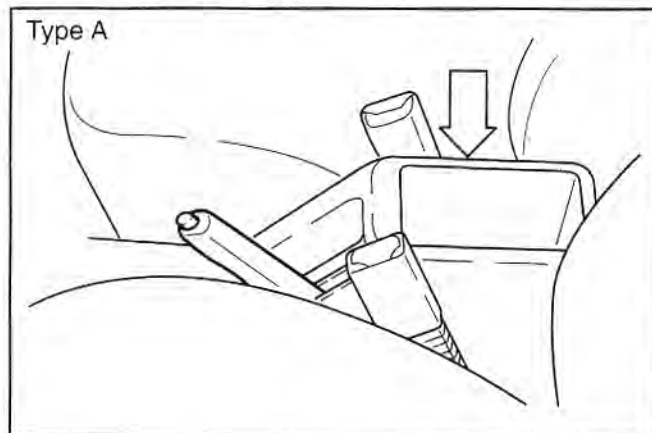

AN7B03050

Knowing Your Vehicle

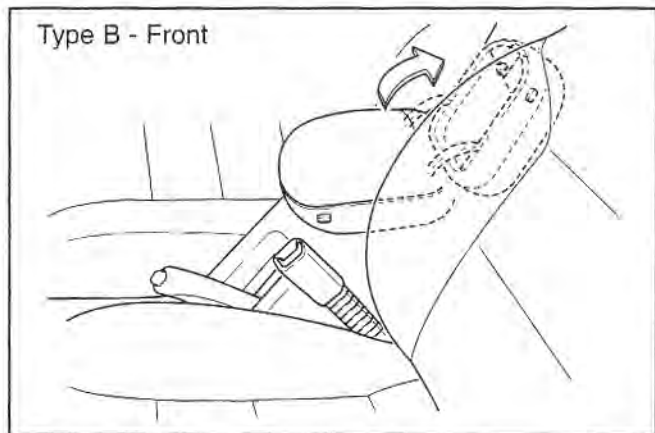

1N7105012

To access the console storage compartment, pull up on the locking tab at the forward end of the console lid and lift center console lid.

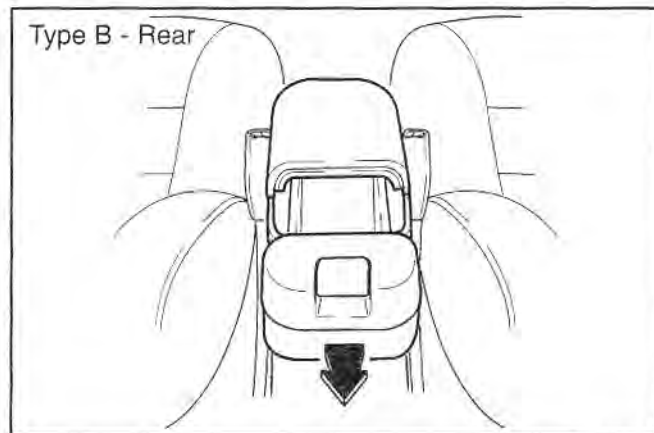

1N7105013

To access the rear console compartment, pull the latch rearward. To return to its original position, push it forward.

Type B-Armrest

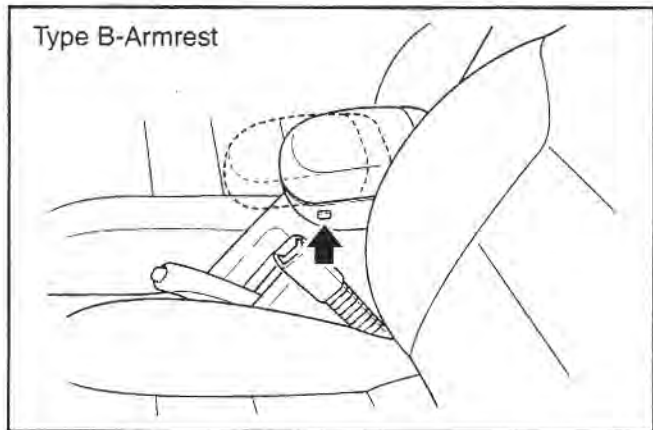

1N7105014

To use the center console lid as an arm-rest, depress the button located on the side of the center console lid. To return to its original position, push the center console lid rearward.

Front Seat Storage Bin (If equipped)

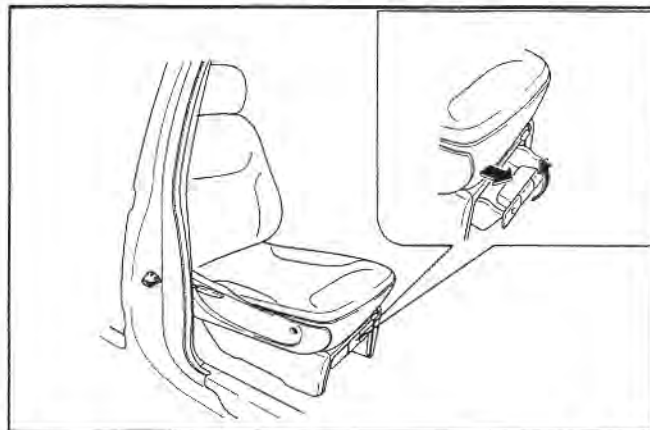

1V2105041B

The storage bin is located under the front passenger's seat. To open, pull the lever up and pull the storage bin out.

*** NOTICE**

To deter theft, never leave valuables in the storage bin while the vehicle is unattended.

Knowing Your Vehicle

Electrical Power Outlet

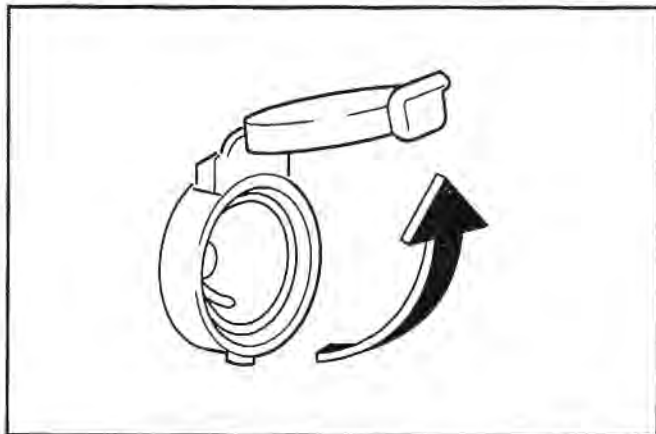

1V2105043A

Open the power outlet cover on the rear quarter trim and, with the engine running, insert the mating connector from the electrical appliance. Make sure the electrical appliance draws less than 10 amperes at 12 volts.

CAUTION

- *Use the electrical power outlet with the engine running.*
- *If you have to use electrical accessories that draw higher power (vacuum cleaners, lights, coolers, etc.), use the power outlet intermittently and with caution.*
- *If electrical accessories are plugged into the power outlet for long periods with engine off, the vehicle battery will discharge and battery life will be shortened.*
- *Close the power outlet cover when not in use.*

Driving Your Vehicle

Automatic Transmission	4-10
Automatic Locking Hubs	4-24
Brake System	4-27
Climate Control System	4-66
Cruise Control	4-36
Four-Wheel Drive	4-20
Gauges	4-43
Ignition Switch	4-3
Instrument Cluster	4-41
Interior Features	4-60
Lighting	4-51
Manual Transmission	4-7
Power Steering	4-35
Rear Window Defroster	4-58

Driving Your Vehicle

Recreational Towing Guidelines (Manual Transmission Only)	4-75
Starting the Engine	4-5
Theft Deterrent System	4-76
Transfer Lever (Four-Wheel Drive Lever)	4-21
Warnings and Indicators	4-46
Windshield Defrosting and Defogging	4-73
Wipers and Washers	4-54

Ignition Switch

Ignition Switch and Anti-Theft Steering Column Lock

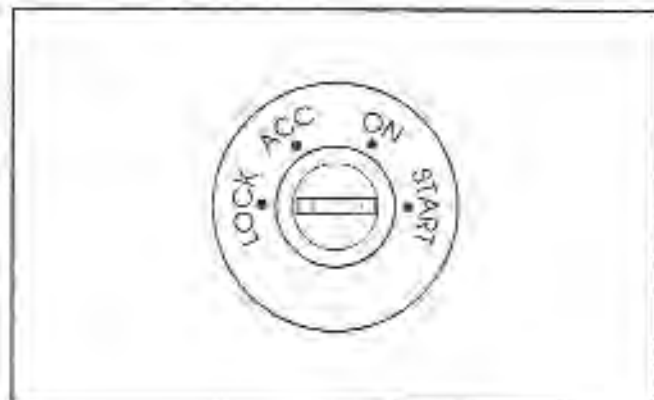

AS2D04001

Ignition Switch Positions

LOCK

The steering wheel locks to protect against theft. The ignition key can be removed only in the LOCK position. When turning the ignition switch

to the LOCK position, push the key inward at the ACC position and turn the key toward the LOCK position.

ACC (Accessory)

The steering wheel is unlocked and electrical accessories are operative.

ON

The warning lights can be checked before the engine is started. This is the normal running position after the engine is started.

Do not leave the ignition switch ON if the engine is not running. The battery will discharge.

*** NOTICE**

This spark ignition system meets all requirement of the Canadian interference-Causing Equipment Regulations.

Driving Your Vehicle

START

Turn the ignition key to the START position to start the engine. The engine will crank until you release the key; then it returns to the ON position. The brake warning lamp can be checked in this position.

If difficulty is experienced in turning the ignition key to the the START position, turn the steering wheel right and left to release the tension and then turn the key.

⚠ WARNING - Ignition Key

- **Never turn the ignition switch to LOCK or ACC while the vehicle is moving. This would result in loss of directional control and braking function, which could cause an immediate accident.**

(Continued)

(Continued)

- **The anti-theft steering column lock is not a substitute for the parking brake. Before leaving the driver's seat, always make sure the shift lever is engaged in 1st gear for manual transmission, or P (Park) for automatic transmission; set the parking brake fully AND shut the engine off. Unexpected and sudden vehicle movement may occur if these precautions are not taken.**
- **Never reach for the ignition switch, or any other controls through the steering wheel while the vehicle is in motion. The presence of your hand or arm in this area could cause a loss of vehicle control, an accident and serious bodily injury or death.**

Starting the Engine

1. Make sure the parking brake is applied.
2. **Manual Transmission** - Depress the clutch pedal fully and shift the transmission into Neutral. Keep the clutch pedal depressed while cranking the engine. The starter will not operate if the clutch pedal is not fully depressed.

Automatic Transmission - Place the transmission shift lever in P (Park). Depress the brake pedal fully.

You can also start the engine when the shift lever is in the N (Neutral) position.

3. Turn the ignition switch to START and hold it there until the engine starts (a maximum of 10 seconds), then release the key.
4. In extremely cold weather – below -18°C (0°F) – or after the vehicle has not been operated for several days, let the engine warm up without depressing the accelerator.

Whether the engine is cold or warm, it should be started without depressing the accelerator.

CAUTION

If the engine stalls while you are in motion, do not attempt to move the shift lever to the P (Park) position. If traffic and road conditions permit, you may put the shift lever in the N (Neutral) position while the vehicle is still moving and turn the ignition switch to the START position in an attempt to restart the engine.

If the engine fails to start when the engine is cold:

The engine is “cold” when the engine coolant temperature drops below $0^{\circ}\text{C}/32^{\circ}\text{F}$. A no-start condition may be caused by an engine that has become flooded (has excessive fuel in the cylinders). If this is the case, use the following starting procedure.

*** NOTICE**

This spark ignition system complies with Canadian ICES-002.

Driving Your Vehicle

1. Make sure the parking brake is applied.
2. **Manual Transmission** - Depress the clutch pedal fully and shift the transmission into Neutral. Keep the clutch pedal depressed while cranking the engine. The starter will not operate if the clutch pedal is not fully depressed.

Automatic Transmission - Place the transmission shift lever in P (Park) or N (Neutral). Depress the brake pedal fully.

3. While fully depressing the accelerator, turn the ignition switch to the START position and hold it (a maximum of 10 seconds) to discharge the excess fuel.

If the engine starts, the engine speed will increase suddenly; release the key and the accelerator immediately.

4. If the engine has not yet started, release the accelerator after cranking the engine. Without depressing the accelerator, crank the engine until it starts (a maximum of 10 seconds).

If the engine fails to start when the engine is warm:

A no-start condition, characterized by failure to restart a warmed engine despite repeated attempts may be eliminated by using the following procedure.

1. Make sure the parking brake is applied.
2. **Manual Transmission** - Depress the clutch pedal fully and shift the transmission into Neutral. Keep the clutch pedal depressed while cranking the engine. The starter will not operate if the clutch pedal is not fully depressed.

Automatic Transmission - Place the transmission shift lever in P (Park) or N (Neutral). Depress the brake pedal fully.

3. While depressing the accelerator about halfway, turn the ignition switch to the START position and hold it (a maximum of 10 seconds).
4. Permit the engine to idle for about 10 seconds before driving.

* NOTICE

- Do not engage the starter for more than 10 seconds. If the engine stalls or fails to start, wait 5 to 10 seconds before re-engaging the starter. Improper use of the starter may damage it.
- This spark ignition system complies with Canadian ICES-002.

The starter will not operate if:

- Manual transmission - the clutch pedal is not fully depressed.
- Automatic transmission - the shift lever is NOT in the P (Park) or N (Neutral) position.

Excessive engine noise may occur if the engine has not been operated for an extended period. The noise should stop after the engine has reached normal operating temperature. If the noise does not stop, have the vehicle inspected by an authorized Kia dealer.

Manual Transmission

Manual Transmission Operation

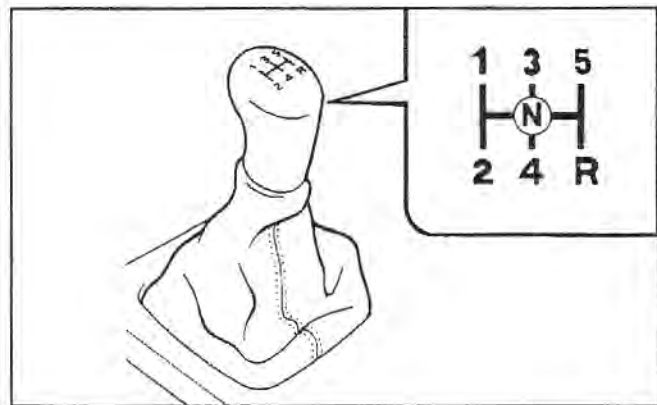

02001A

The manual transmission has five forward gears. Press the clutch pedal down fully while shifting, then release it slowly.

Driving Your Vehicle

A special safety feature prevents inadvertent shifting from 5 (Fifth) to R (Reverse). The gearshift lever must be returned to the neutral position before shifting into R (Reverse).

Make sure the vehicle is completely stopped before shifting into R (Reverse).

*** NOTICE**

To avoid premature clutch wear and damage, do not drive with your foot resting on the clutch pedal. Also, don't use the clutch to hold the vehicle stopped on an upgrade, while waiting for a traffic light, etc.

▲ WARNING - Manual Transmission

Before leaving the driver's seat, always set the parking brake fully and shut the engine off. Then make sure the transmission is shifted into 1st gear. Unexpected and sudden vehicle movement can occur if these precautions are not followed in the order identified.

Recommended Shift Speeds

The chart shows when to shift for smooth driving and best fuel economy.

This data has been obtained through tests. You are encouraged to follow this shift schedule.

Gear Position	Speeds – Km/h (Mph)	
1	0 – 21	(0 – 13)
2	21 – 40	(13 – 25)
3	40 – 60	(25 – 37)
4	60 – 72	(37 – 45)
5	over 72	(over 45)

You may have to upshift at higher speeds than those above if you need more power while you are driving on a hill or passing another vehicle.

However, never operate the engine with the tachometer (RPM) in the red area.

Downshifting

When you must slow down in heavy traffic or while driving up steep hills, downshift before the engine starts to “labor”. Downshifting reduces the chance of stalling and gives better acceleration when you again need to increase your speed. When the vehicle is traveling down steep hills, downshifting helps maintain safe speed and prolongs brake life.

Driving Your Vehicle

Automatic Transmission (If Equipped)

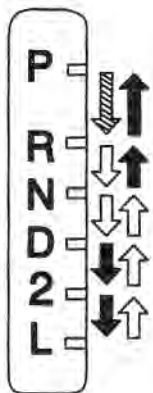

Normal transmission gear ranges are provided on the right side of the indicator.



To move the shift lever from the P position, the ignition switch must be in the ON position, the brake pedal must be depressed and the lock release button must be depressed.



The lock release button must be depressed while moving the shift lever.

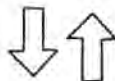

The shift lever can be moved without depressing the lock release button.

Lock release button
Prevents shift lever movement without first depressing the button.

HOLD button
Pressing the button activates the HOLD mode. Pressing again deactivates the HOLD mode.

Emergency override

Shift lever

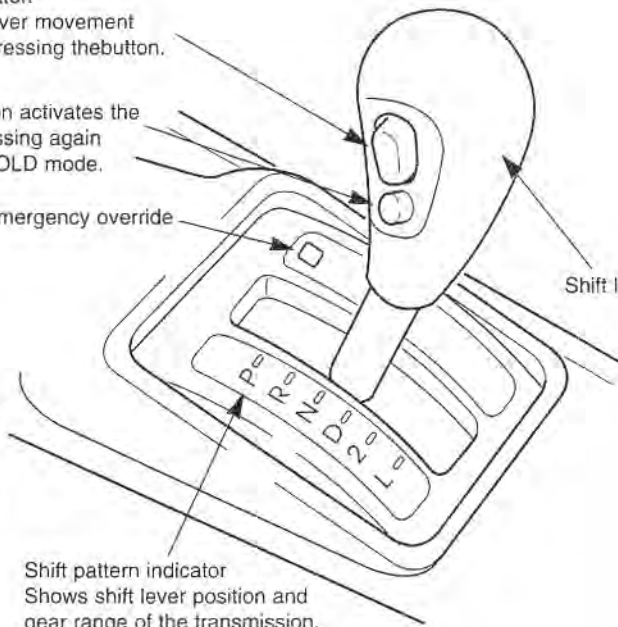

Shift pattern indicator
Shows shift lever position and gear range of the transmission.

Automatic Transmission Operation

The optional four-speed automatic transmission is electronically controlled.

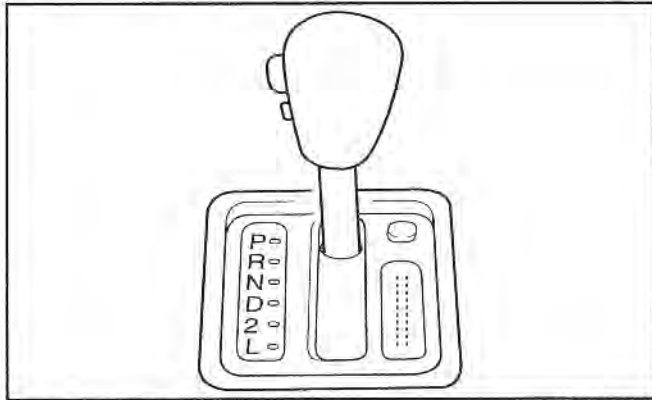

AN7B04004

All normal forward driving is done with the shift lever in the D (Drive) position.

To move the shift lever from the P (Park) position, the ignition switch must be in the ON position, the brake pedal must be depressed and the lock release button must be depressed.

For smooth operation, depress the brake pedal when shifting from N (Neutral) to a forward or reverse gear.

CAUTION

- Do not accelerate the engine in R (Reverse) or any forward gear position with the brakes on.
- When stopped on an upgrade, do not hold the vehicle stationary with engine power. Use the service brake or the parking brake.
- Do not shift from N (Neutral) or P (Park) into L (Low), 2 (Second Gear), D (Drive), or R (Reverse) when the engine is above idle speed.

Driving Your Vehicle

Transmission Ranges

P (Park)

This position locks the transmission and prevents the front wheels from rotating. Always come to a complete stop before shifting into this position.

WARNING

- Shifting into P (Park) while the vehicle is in motion will cause the drive wheels to lock and you will lose driving control of the vehicle.
- Do not use the P (Park) position in place of the parking brake. Always make sure the shift lever is latched in the P (Park) position so that it cannot be moved unless the lock release button is pushed in, AND set the parking brake fully.

(Continued)

(Continued)

- Before leaving the driver's seat, always make sure the shift lever is in the P (PARK) position; set the parking brake fully and shut the engine off. Unexpected and sudden vehicle movement can occur if these precautions are not followed in the order identified.
- Never leave a child unattended in a vehicle.

CAUTION

The transmission may be damaged if you shift into P (Park) while the vehicle is in motion.

R (Reverse)

Use this position to drive the vehicle backward.

CAUTION

Always come to a complete stop before shifting into or out of R (Reverse); you may damage the transmission if you shift into R while the vehicle is in motion, except as explained in "Rocking the Vehicle", page 5-8.

N (Neutral)

The wheels and transmission are not locked. The vehicle will roll freely even if the transfer case is in gear, unless the parking brake or service brakes are applied.

D (Drive)

This is the normal forward driving position. The transmission will automatically shift through a four-gear sequence, providing the best economy and power.

For extra power when passing another vehicle or climbing grades, depress the accelerator fully, at which time the transmission will automatically downshift to the next lower gear.

For improved engine performance, the transmission will not shift into 4th gear until the engine coolant temperature reaches approximately 68°C (155°F).

2 (Second Gear)

Use 2 (Second Gear) for more power when climbing hills and for increased braking when going down hills. This position also helps reduce wheel spin on slippery surfaces. When the shift lever is placed in 2 (Second Gear), the transmission will automatically shift from first to second gear. Downshifting from second to first gear is possible below speeds of 43 km/h (26 mph). Do not exceed 60 km/h (36 mph) while in second gear.

Driving Your Vehicle

L (Low)

Move the shift lever to this position in hard pulling situations and for climbing steep grades. Do not exceed 35 km/h (22 mph) while in Low.

Upshift patterns without HOLD mode engaged:

CAUTION

Do not exceed the recommended maximum speeds in 2 (Second Gear) or L (Low). Operating the vehicle at speeds above the maximum recommended, for 2 (Second Gear) or L (Low) may cause excessive heat to develop which could result in damage to or failure of the automatic transmission.

Moving Up a Steep Grade From a Standing Start

To move up a steep grade from a standing start, depress the brake pedal, shift the shift lever to D (Drive), 2 (Second) or L (Low) depending on load weight and steepness of the grade, and release the parking brake. Depress the accelerator gradually while releasing the service brakes.

D = 1st, 2nd, 3rd, 4th ; **2** = 1st, 2nd ; **L** = 1st

HOLD Mode (For A/T Only)

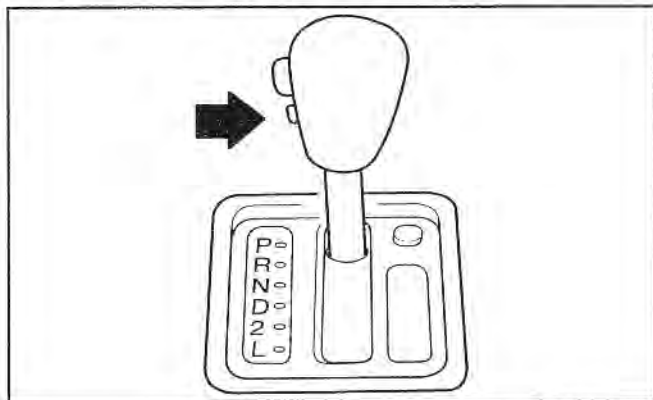

AN7B04005

* NOTICE

The transmission will remain in the HOLD mode until you again depress the HOLD button, or you shut the engine OFF. While in the HOLD mode, do not exceed maximum engine RPM, or you will damage the engine.

This system modifies the automatic gear change while in forward driving only.

Under normal operating conditions the transmission starts in 1st gear and shifts through 2nd, 3rd and then to 4th gear, with the gear selector in D (Drive).

Use the HOLD mode system when starting the vehicle from a complete stop on slippery surfaces such as snowy, slushy, or muddy roads, when driving up steep inclines, and for braking assistance when going down hills.

Pushing the HOLD button activates the HOLD mode. Pushing the button again deactivates this mode.

D (Drive)

The transmission is held in 3rd gear. When stopping, however, it automatically downshifts to 2nd gear then returns to 3rd gear for smoother acceleration, that is, the transmission starts in 2nd gear and shifts to 3rd gear when the hold mode is engaged. In this case, the transmission never goes into 1st or 4th gear.

Driving Your Vehicle

2 (Second Gear)

HOLD mode does not change the operation of 2 (Second).

L (Low)

HOLD mode does not change the operation of L (Low)

Upshift Patterns With HOLD Engaged:

D (Drive) – HOLD: 3rd gear (momentary 2nd from standing start)

2 (Second Gear) – HOLD: Starts in 1st gear and automatically shifts to 2 (Second) then remains in 2 (Second)

L (Low) – HOLD: Starts in first gear and remains in first gear.

When the ignition is switched OFF, HOLD mode is automatically cancelled.

HOLD Indicator Light

This indicator light illuminates in the instrument panel when the HOLD mode is selected.

*** NOTICE**

If the HOLD indicator flashes, it indicates an electrical problem in the transmission. Should this occur, have the vehicle checked by an authorized Kia dealer as soon as possible.

Power/Economy Mode

The Power/Economy mode select switch, located on the right side of the steering column, allows you to select either “Power” or “Economy” mode. The Power/Economy mode only functions when the shift lever is in the D (Drive) position. To select “Power” mode, depress the switch. If you wish to return to “Economy” mode, depress the switch again.

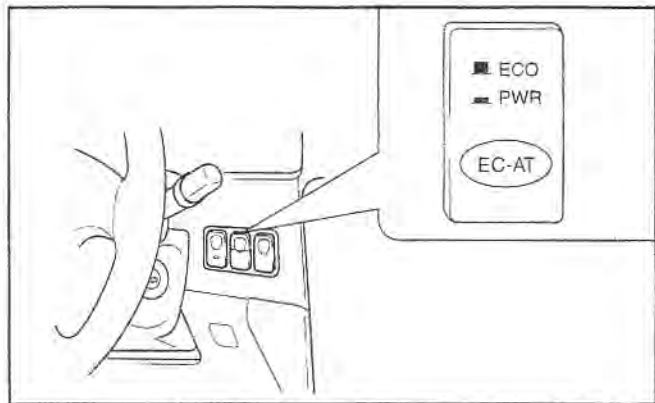

AN7B04006Z

Economy Mode

This mode is used for normal driving. The transmission upshifts at lower engine speeds to achieve the best possible fuel consumption.

Power Mode

This mode offers “sportier” driving characteristics, but functions only when the shift lever is in D (Drive). When this mode is selected, a “POWER”

indicator light appears on the instrument cluster. The transmission upshifts at higher engine speeds and requires less force on the accelerator to downshift for passing or climbing situations.

When the shift lever is in the L (Low) or 2 (Second) position, this mode can be selected and the “POWER” indicator will illuminate, however, the shift patterns are not affected.

If the Power Mode is selected and the HOLD mode is activated, the “POWER” indicator will go out.

Shift Lock System

For your safety, the Automatic Transmission has a shift lock system which prevents shifting the transmission out of P (Park) unless the brake pedal is depressed.

To shift the transmission out of P (Park):

1. Depress and hold the brake pedal.
2. Start the engine or turn the ignition to the ON position.
3. Depress the lock release button and move the shift lever.

Driving Your Vehicle

When the ignition switch is in the ACC or LOCK position, the transmission cannot be shifted from P (Park).

If the brake pedal is repeatedly depressed and released with the shift lever in the P (Park) position, a chattering noise near the shift lever may be heard. This is a normal condition.

Also, the ignition key cannot be removed unless the shift lever is in the P (Park) position. If the ignition switch is in any other position, the key cannot be removed.

Shift-lock override

If the shift lever should fail to move from the P (Park) position with the brake pedal depressed, continue depressing the brake, then do the following:

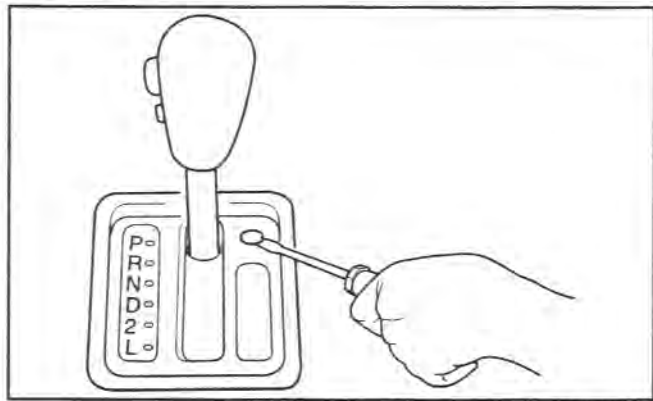

AN7B04007

1. Carefully remove the cap covering the S/Lock override access hole which is located on the right side of the shift lever.

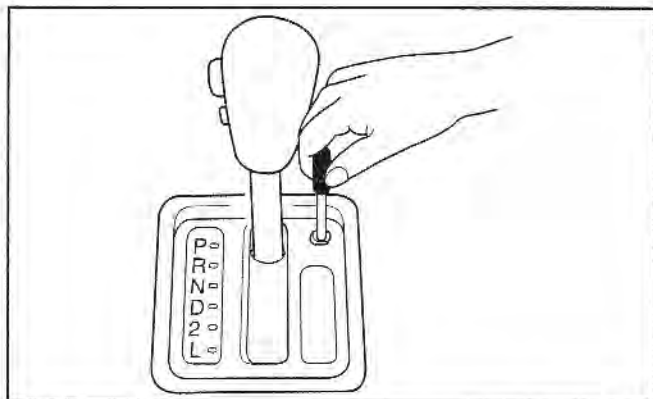

AN7B04008

2. Insert the ignition key into the access hole and press down on the key.

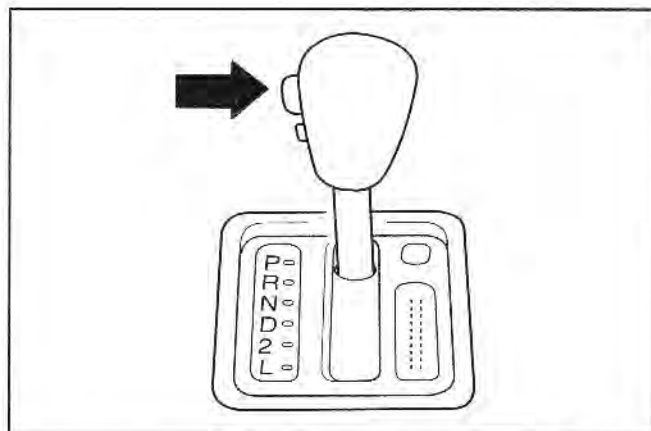

AN7B04009

3. Depress the lock release button and move the shift lever.
4. Have your vehicle inspected by an authorized Kia dealership immediately.

Driving Your Vehicle

Four-Wheel Drive (4WD) (If Equipped)

- You can send your engine's driving power to all front and rear wheels for maximum power.
- Four-wheel drive is useful when you drive in snow, mud, ice, or sand where good traction is required, or when your wheels lose traction using two-wheel drive.

*** NOTICE**

- Do not select four-wheel drive mode on flat and normal roads.
- Four-wheel driving on flat roads for a long period causes poor fuel economy and noise, and it also causes tires to wear faster.
- Four-wheel driving on flat and normal roads can result in a severe binding and chattering condition when turning the steering wheel.
- Four-wheel driving on flat roads for a long period can also cause the differential oil temperature to increase, resulting in damage to parts in the powertrain.

Transfer Lever (If Equipped) (Four-Wheel Drive Lever)

▲ WARNING - Four Wheel Drive

When shifting the transfer lever into the four-wheel drive positions (4H and 4L), make sure the lever is fully engaged in the gear setting. Failure to fully engage the gear could allow the transfer lever to slip out of gear causing loss of power to the drive wheels. This could cause a loss of vehicle control and could possibly result in a serious accident.

Use this lever to shift into and out of four-wheel drive.

Manual Transmission Four-Wheel Drive Lever

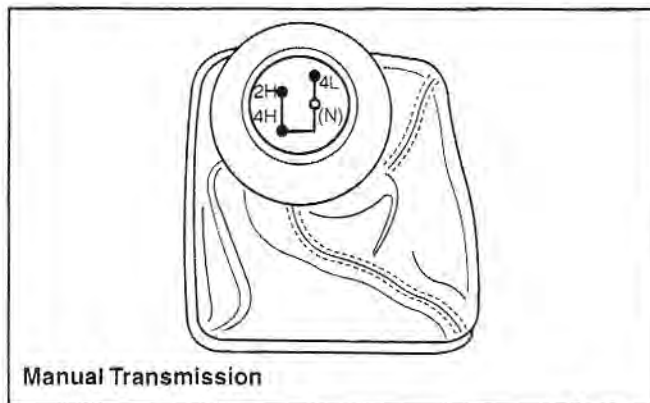

BN7B04010

Driving Your Vehicle

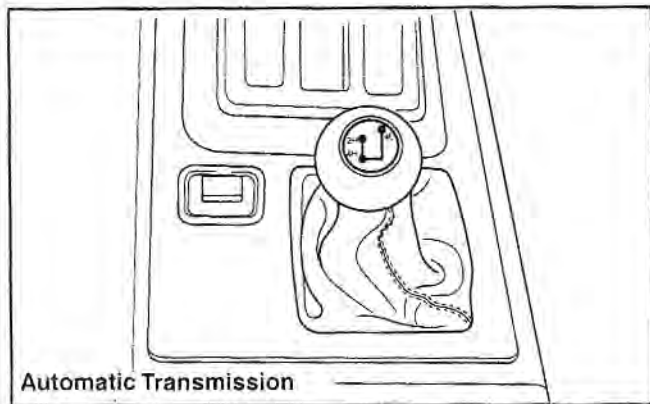

BN7B04011

You have the following options with this lever:

2H: Two-Wheel High Speed

4H: Four-Wheel High Speed

N : Neutral (Manual Transmission only)

4L: Four-Wheel Low Speed

- In Manual Transmission equipped vehicles: It is not necessary to depress the clutch pedal to shift from 2H to 4H.
- To shift between 4H, N(Manual Transmission only) and 4L, depress the clutch pedal after

stopping your vehicle. The shifting between 4H, N (Manual Transmission only) and 4L can only occur after the vehicle has been stopped.

- In Automatic Transmission equipped vehicles: stop your vehicle and set your parking brake to prevent the vehicle from rolling, then place the transmission in the N (Neutral) position before shifting the transfer lever between 4H and 4L.

2H (Two-Wheel Drive High Speed)

This setting engages the rear axle only.

Select this setting when you drive in most ordinary driving situations.

4H (Four-Wheel Drive High Speed)

This setting engages front and rear axles. Select this setting when you drive in sand, snow, etc.

The 4WD indication light will illuminate to remind you that you are in the four-wheel drive mode.

N (Neutral) (Manual Transmission only)

This setting disengages front and rear axles. The 4WD indication light will be turned on to remind you that you are in the four-wheel drive mode.

In vehicles equipped with Automatic Transmission, the transfer case does not have a neutral position.

4L (Four-Wheel Drive Low Speed)

This setting engages front and rear axles and gives you greater traction than 4H but lowers your maximum vehicle speed.

Select this setting when you drive on steep hills or in mud or snow. You will get greater power in 4L.

The 4WD indication light will illuminate to remind you that you are in the four-wheel drive mode.

*** NOTICE**

When towing a Sportage equipped with either a manual or automatic transmission, the use of flat bed equipment or wheel dollies is recommended.

If you must tow without a flatbed or dolly, use the following procedure:

- Set the transfer lever to 2H.
- Set the transmission shift lever to "N" (Automatic Transmission) or neutral (Manual Transmission).
- Make sure the front hubs are unlocked.
- The rear of the Sportage should always be lifted, not the front.
- Vehicles equipped with an Automatic Transmission should not exceed 45 km/h (28 mph) and should not be towed more than 80 km (50 miles).

Failure to follow this procedure could cause damage to the transmission, front hubs, etc. Observe all provincial and local laws applicable to towing vehicles.

Driving Your Vehicle

For "Recreational Towing" information, refer to Section 4 "Driving Your Vehicle". For "Emergency Towing" information, refer to Section 6 "In Case Of An Emergency."

CAUTION

In vehicles equipped with a Manual Transmission, if you set the transfer case lever to the Neutral position, the front and rear axles are disengaged and the vehicle will be free to roll regardless of whether or not the transmission is in gear. This same condition may occur with Automatic Transmission equipped vehicles if the transfer case lever is not fully engaged into 2H, 4H or 4L. Always set your parking brake to prevent the vehicle from rolling even if the transfer case and transmission are in gear.

Automatic Locking Hubs (4WD Only)

Your vehicle is equipped with automatic locking hubs. This feature allows you to enter and exit 4WD without manually locking the hubs.

To lock the hubs:

When you find it necessary to use 4WD, move the transfer lever into four-wheel drive mode while you are driving at low speed.

You will hear noise from the gear while you are trying to move the transfer lever. This is normal.

To unlock the hubs:

Once you leave an area requiring the four-wheel drive operation, return the transfer lever to 2H to unlock the hubs.

For Safe Four-Wheel Drive Operation

- Your Sportage allows you to drive in on-road and off-road conditions.
- However, do not try to drive in deep standing water or mud, or over steep hills.
- When you are driving up or down hills, drive as close to straight up and down the hills as possible. Use extreme caution in going up or down steep hills, since you can flip your vehicle over depending on the grade, terrain and water/mud conditions.

⚠ WARNING - Steep Hills

Driving across the contour of steep hills can be extremely dangerous. This danger can come from slight changes in the hill angle which can destabilize the vehicle or, even if the vehicle is maintaining stability under power, it can lose that stability if the vehicle stops its forward motion. Your vehicle may roll over without warning and without time for you to correct for your mistake causing serious injury or death.

- You must learn how to corner in a 4WD vehicle as soon as possible. Do not rely on your experience in conventional 2WD vehicles in choosing a safe cornering speed. You must drive more slowly.

⚠ WARNING - Turning Corners

Reduce speed when you turn corners. The center of gravity of 4WD vehicles is raised higher than that of conventional 2WD vehicles, making them more likely to roll over when you turn corners too fast.

- Drive off-road carefully because your vehicle may be damaged by rocks or roots of trees. Become familiar with the off-road conditions you are going to drive before you start.

Driving Your Vehicle

CAUTION

Do not grab inside of the steering wheel when you are driving off-road. Your arm may be hurt by a sudden steering maneuver or from steering wheel rebound due to impact with objects on the ground. This may cause you to lose steering wheel control.

- Always hold the steering wheel firmly when you are driving off-road.
- Make sure all passengers are wearing seat belts.

CAUTION

If you are driving in heavy wind, the vehicle's higher center of gravity decreases your steering control capability and requires you to drive more slowly.

- If you need to drive in water, stop your vehicle, set your transfer lever to "4L" and drive at less than 8 km/h (5 mph).

WARNING - Driving Through Water

If you are driving too fast in water, the water spray can get into the engine compartment and wet the ignition system, causing your vehicle to suddenly stop. If this happens and your vehicle is in a tilted position, your vehicle may roll over.

- Do not drive in water if the level is higher than the bottom of the wheel hubs.
- Check your brake condition once you are out of mud or water. Press the brake pedal several times as you move slowly until you feel normal braking forces return.
- Shorten your scheduled maintenance interval if you drive off-road in conditions such as sand, mud or water.(See "Maintenance Schedule" in the Index) Always wash your car thoroughly.

Brake System

Power Brakes

Your vehicle has power-assisted brakes that adjust automatically through normal usage.

In the event that the power-assisted brakes lose power because of a stalled engine or some other reason, you can still stop your vehicle by applying greater force to the brake pedal than you normally would. The stopping distance, however, will be longer.

When the engine is not running, the reserve brake power is partially depleted each time the brake pedal is applied. Do not pump the brake pedal when the power assist has been interrupted. Pump the brake pedal only when necessary to maintain steering control on slippery surfaces.

In the Event of Brake Failure

If the service brakes should fail to operate while the vehicle is in motion, you can make an emergency stop with the parking brake. The stopping distance, however, will be much greater than normal.

WARNING - Parking Brake

Pulling on the parking brake while the vehicle is moving at normal speeds can cause a sudden loss of control of the vehicle. If you must use the parking brake to stop the vehicle, use great caution in applying the brake.

WARNING - Brakes

Do not drive with your foot resting on the brake pedal. This will create abnormally high brake temperatures, excessive brake lining and pad wear, and increased stopping distances.

(Continued)

Driving Your Vehicle

(Continued)

- When descending a long or steep hill, shift to a lower gear and avoid continuous application of the brakes. Continuous brake application will cause the brakes to overheat and could result in a temporary loss of braking performance.
- Wet brakes may result in the vehicle not slowing down at the usual rate and pulling to one side when the brakes are applied. Applying the brakes lightly will indicate whether they have been affected in this way. Always test your brakes in this fashion after driving through deep water. To dry the brakes, apply them lightly while maintaining a safe forward speed until brake performance returns to normal.

Disc Brake Wear Indicators

Your vehicle has front disc brakes.

When your front brake pads are worn and it's time for new pads, you will hear a high-pitched warning sound from your front brakes. You may hear this sound come and go or it may occur whenever you depress the brake pedal.

WARNING - Brake Wear

This brake wear warning sound means your vehicle needs service. If you ignore this audible warning, you will eventually lose braking performance, which could lead to a serious accident.

*** NOTICE**

To avoid costly brake repairs, do not continue to drive with worn brake pads.

Please remember that some driving conditions or climates may cause a brake squeal when you first apply (or lightly apply) the brakes. This is normal and does not indicate a problem with your brakes.

Rear Drum Brakes

Your rear drum brakes do not have wear indicators. Therefore, have the rear brake linings inspected if you hear a rear brake rubbing noise. Also have your rear brakes inspected each time you change or rotate your tires and when you have the front brakes replaced.

CAUTION

Always replace brake pads or linings as complete front or rear axle sets.

Driving Your Vehicle

Parking Brake

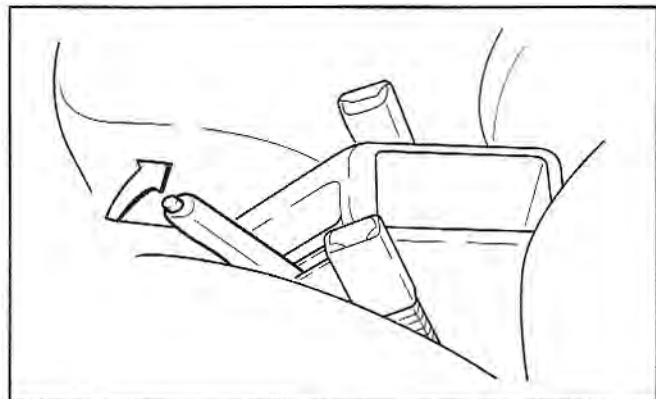

AN7B04012

- To set the parking brake, pull the parking brake handle fully and firmly upward while applying the service brake.

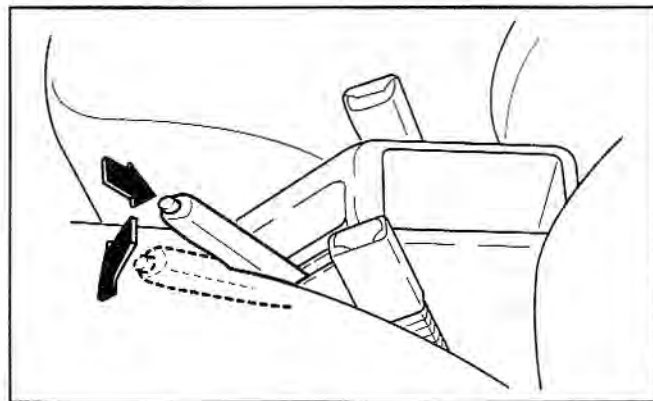

AN7B04013

- To release the parking brake, pull the handle up slightly and push the release button. Then lower the handle to the released position while holding the button in.

CAUTION

When stopped, do not use the gearshift lever in place of the parking brake. Always set the parking brake fully AND make sure the gearshift lever is securely positioned in 1st (First) gear or Reverse for manual transmission equipped vehicles and in P (Park) for automatic transmission equipped vehicles.



AN7B04014

Check the brake warning light each time you start the engine. This warning will be illuminated when the engine is running and the parking brake is set. Before driving, be sure the parking brake is fully released and the brake warning light is off. If the brake warning light remains on after the parking brake is released, there may be a malfunction in the brake system. Immediate attention is necessary.

Driving Your Vehicle

If at all possible, cease driving the vehicle immediately. If that is not possible, use extreme caution while operating the vehicle and only continue to drive the vehicle until you can reach a safe location or repair shop.

Parking on Curbed Streets

- When parking your vehicle on an uphill grade, park as close to the curb as possible and turn the front wheels away from the curb so that the front wheels will contact the curb if the vehicle moves backward.
- When parking your vehicle on a downhill grade, park as close to the curb as possible and turn the front wheels toward the curb so that the front wheels will contact the curb if the vehicle moves forward.

Anti-Lock Brake System (ABS) (Optional)

The ABS system continuously senses the speed of the wheels. If the wheels are going to lock, the ABS system repeatedly modulates the hydraulic brake pressure to the wheels.

When you apply your brakes under conditions which may lock the wheels, you may hear a “tik-tik” sound from the brakes, or feel a corresponding sensation in the brake pedal. This is normal and it means your ABS system is active.

In order to obtain the maximum benefit from your ABS system in an emergency situation, do not attempt to modulate your brake pressure and do not try to pump your brakes. Press your brake pedal as hard as possible (or as hard as the situation warrants) and allow the ABS system to control the force being delivered to the rear brakes.

- Even with the anti-lock brake system, your vehicle still requires a sufficient stopping distance. Always maintain a safe distance from the vehicle in front of you.
- Always slow down when cornering. The anti-lock brake system cannot prevent accidents resulting from excessive speeds.
- On loose or uneven road surfaces, operation of the anti-lock brake system may result in a longer stopping distance than for vehicles equipped with a conventional brake system.



AN7B04015

* NOTICE

- If the ABS warning light is on and stays on, you may have a problem with the ABS system. In this case, however, your regular brakes will work normally.
- The ABS warning light will stay on for 2-3 seconds after the engine starts. During that time, the ABS will go through self-diagnosis and the light will go off if everything is normal. If the light stays on, you may have a problem with your ABS system. Contact an authorized Kia dealer as soon as possible.

Driving Your Vehicle

* NOTICE

- When you drive on a road having poor traction, such as an icy road, and operate your brakes continuously, the ABS will be active continuously and the ABS warning light may illuminate. Pull your car over to a safe place and stop the engine.
- Restart the engine. If the ABS warning light is off, then your ABS system is normal. Otherwise, you may have a problem with the ABS. Contact an authorized Kia dealer as soon as possible.

* NOTICE

When you jump start your vehicle because of a drained battery, the engine may not run as smoothly and the ABS warning light may blink at the same time. This happens because of the low battery voltage. It does not mean your ABS is malfunctioning.

- Do not pump your brakes!
- Have the battery recharged before driving the vehicle.

⚠ WARNING - ABS Brakes

For safe driving, don't depend too much on your ABS system. Use common sense. Your ABS system will probably not be able to prevent an accident in the following driving conditions:

- **Dangerous driving such as neglecting safety precautions, speeding, or driving with inadequate distance between your vehicle and the vehicle in front of you.**
- **Driving at high speed in situations providing considerably less traction, such as conditions where hydroplaning could occur.**
- **The ABS is designed to improve maximum braking effectiveness on typical highways and roads in good condition. On poor road surfaces which are in poor condition, the ABS may actually reduce braking effectiveness.**

Power Steering

Power steering uses energy from the engine to assist you in steering the vehicle. If the engine is off or if the power steering system becomes inoperative, the vehicle may still be steered, but it will require increased steering effort.

Should you notice any change in the effort required to steer during normal vehicle operation, have the power steering system checked by an authorized Kia dealer.

*** NOTICE**

If the vehicle is parked for extended periods outside in cold weather (below -10°C (14°F)), the power steering may require increased effort when the engine is first started. This is caused by increased fluid viscosity due to the cold weather and does not indicate a malfunction.

When this happens, increase the engine RPM to 1500rpm then release or let the engine idle for two or three minutes to warm up the fluid.

Driving Your Vehicle

* NOTICE

- Never hold the steering wheel against a stop (extreme right or left turn) for more than five seconds with the engine running. Holding the steering wheel for more than five seconds in either position may cause damage to the power steering pump.
- If the power steering drive belt breaks or if the power steering pump malfunctions, the steering effort will greatly increase.

Cruise Control (Optional)

The cruise control system allows you to program the vehicle to maintain a constant speed without resting your foot on the accelerator pedal.

With cruise control, you can set and automatically maintain any speed of more than about 40 km/h (25 mph).

WARNING - Cruise Control

Using cruise control in the following conditions could cause you to lose control of the vehicle:

- Heavy or unsteady traffic
 - Slippery or winding roads
 - Situations that involve varying speeds
- Do not use cruise control in these situations.**

WARNING

If the **CRUISE MAIN** switch is left on, the cruise control can be switched on accidentally. **Keep the CRUISE MAIN switch off when cruise control is not in use.**

To Set Cruise Control Speed:

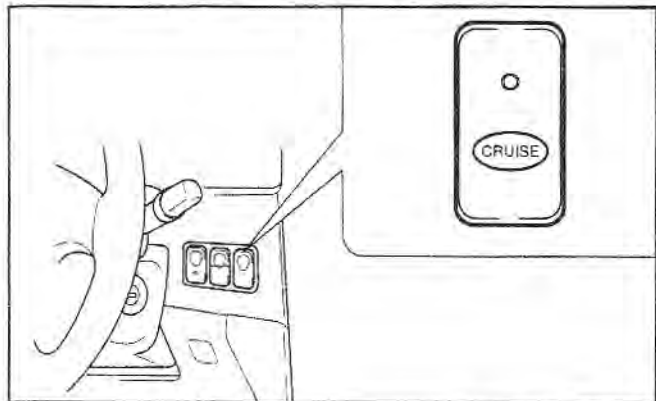

AN7B04016G

1. Push the CRUISE MAIN switch, located on the right side of the steering column, to the ON position.
2. Accelerate to the desired speed, which must be more than 40 km/h (25 mph).

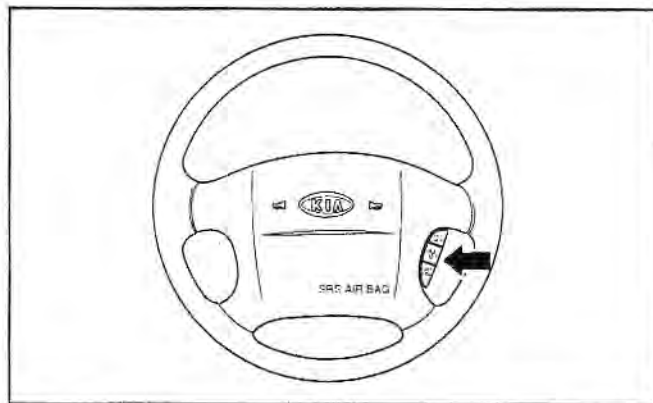

AN7B04017

3. Depress the SET/COAST switch, located on the steering wheel, and release it at the speed you want. Release the accelerator at the same time. The AUTO CRUISE light on your instrument cluster will illuminate.

The SET function cannot be activated until approximately 2 seconds after the CRUISE MAIN switch has been engaged.

On a steep grade, the vehicle may momentarily slow down while going downhill.

Driving Your Vehicle

To Cancel Cruise Control, do one of the following:

- Depress the brake pedal.
- Depress the clutch pedal with a manual transmission, or shift into N (Neutral) with an automatic transmission.
- Depress the CANCEL switch located on the steering wheel.

These will take you out of cruise control but will not turn the system off. If you wish to return to cruise control after doing one of the above actions, depress the RESUME/ACCEL switch located on the steering wheel. If you are still within 15km/h (9 mph) of the preset speed, you will return to your previously preset speed.

To turn cruise control off, do one of the following:

- Push the CRUISE MAIN switch to the OFF position.
- Turn the ignition off.

If you wish to return to cruise control, you have to set cruise control speed from the beginning. Cruise control will cancel at about 15km/h (9 mph) below the preset speed.

To Increase Cruise Control Set Speed:

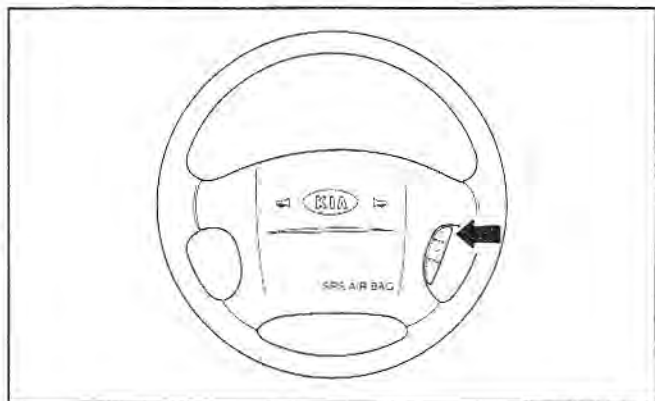

AN7B04018

Follow either of these procedures:

- Depress the RESUME/ACCEL switch and hold it. Your vehicle will accelerate. Release the switch at the speed you want.
- Depress the RESUME/ACCEL switch and release it immediately. The cruising speed will increase 1.6 km/h (1 mph) by one touch and will be memorized to the reset speed.

To Temporarily Accelerate with the Cruise Control On

If you want to speed up temporarily when the cruise control is on, depress the accelerator pedal. Increased speed will not interfere with cruise control operation or change the set speed.

To return to the set speed, take your foot off the accelerator.

Driving Your Vehicle

To Decrease the Cruising Speed:

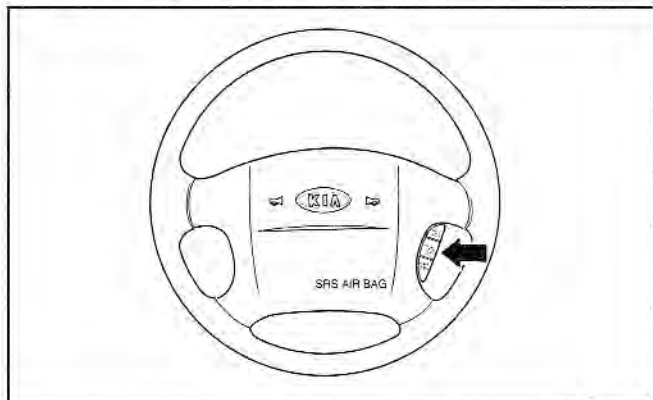

AN7B04019

Follow either of these procedures:

- Depress the SET/COAST switch and hold it. Your vehicle will gradually slow down. Release the switch at the speed you want to maintain.
- Depress the SET/COAST switch and release it immediately. The cruising speed will decrease 1.6 km/h (1 mph) by one touch and will be memorized to the reset speed.

To Resume Cruising Speed at More Than 40 km/h (25 mph):

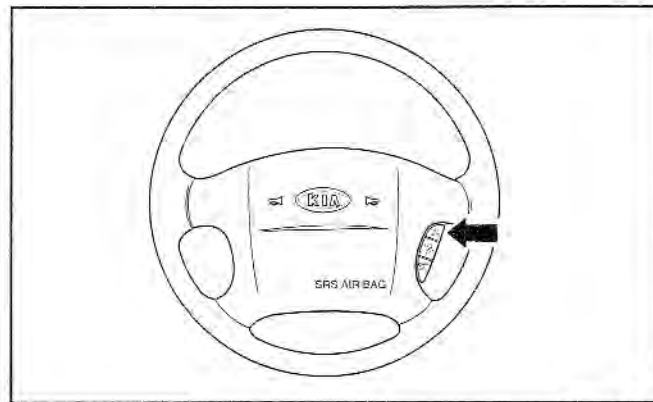

AN7B04020

If something besides the CRUISE MAIN switch was used to cancel cruising speed and the system is still activated, the most recent set speed will automatically resume when the ACCEL/RESUME switch is depressed. It will not resume, however, if the vehicle speed has dropped below 40 km/h (25 mph).

Instrument Cluster (Manual Transmission)

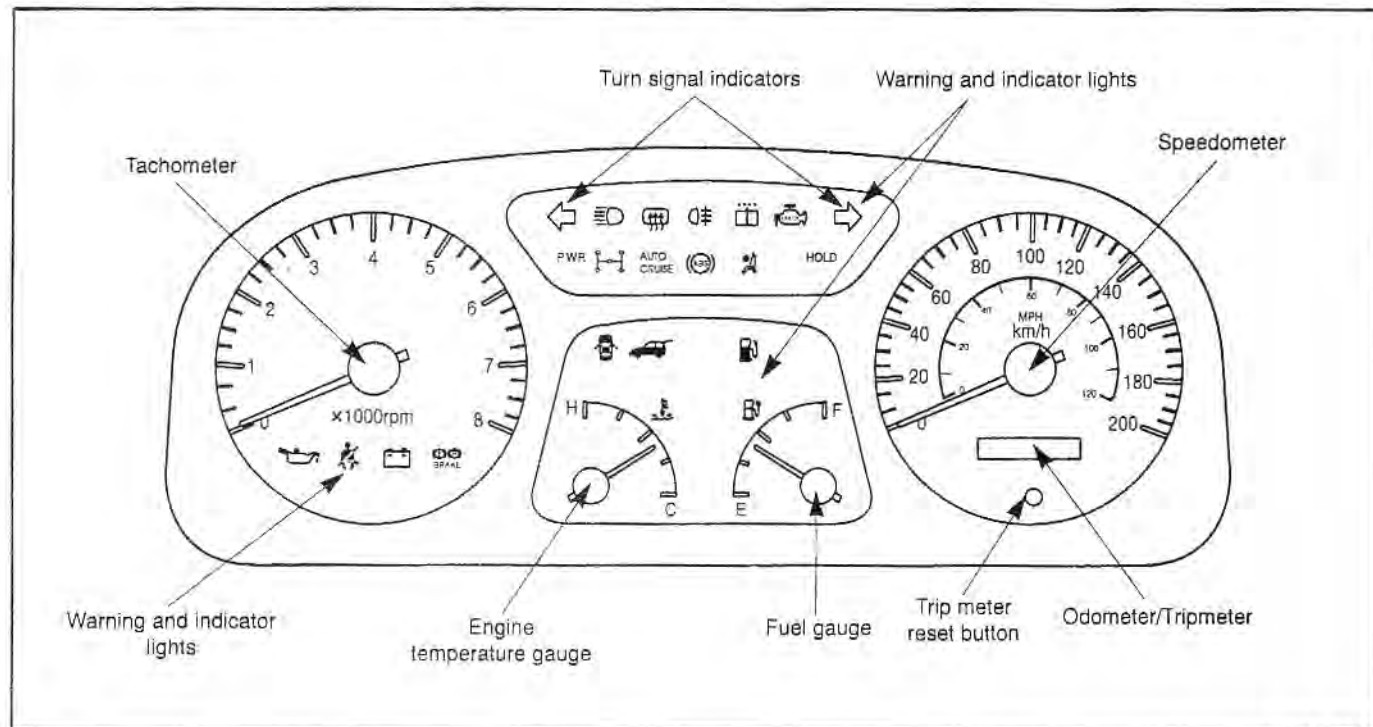

AN7C04022C

Driving Your Vehicle

Instrument Cluster (Automatic Transmission)

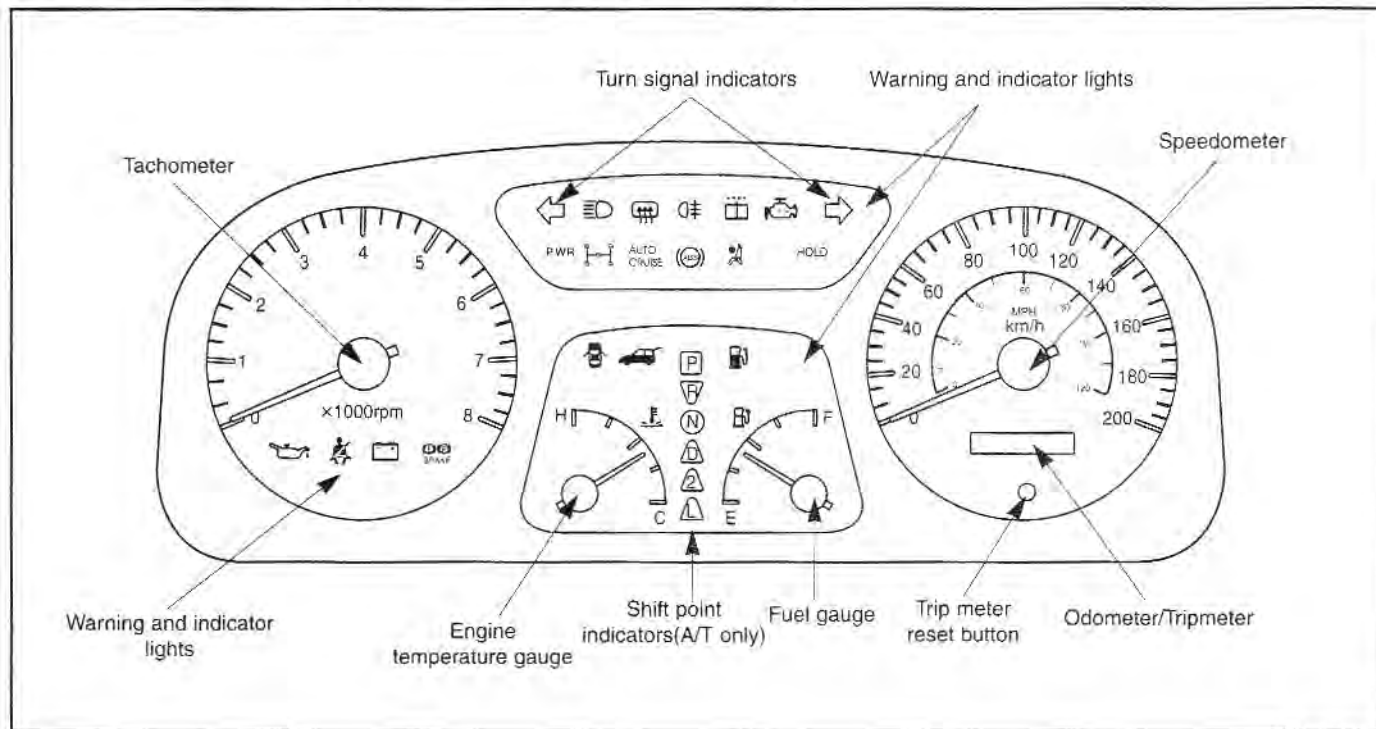

AN7B04021C

Gauges

Speedometer

The speedometer indicates the forward speed of the vehicle.

Odometer/Tripmeter

You can choose the odometer, Tripmeter A and Tripmeter B by pressing the mode selection button.

Odometer

The odometer indicates the total distance the vehicle has been driven.

Tripmeter

TRIP A : Tripmeter A

TRIP B : Tripmeter B

The tripmeter indicates the distance of individual trips selected by the driver. Tripmeter A and B can be reset to zero by pressing the mode selection button for one second or more, then releasing.

Engine Temperature Gauge

This gauge shows the temperature of the engine coolant when the ignition switch is ON.

If the gauge pointer moves beyond the normal range area toward the H position, it indicates overheating that may damage the engine.

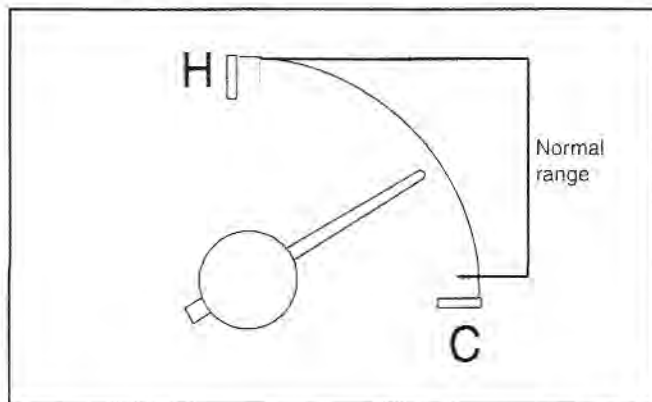

AN7B04023A

Do not continue driving with an overheated engine. If your vehicle overheats, refer to "Overheating" in the Index.

Driving Your Vehicle

Fuel Gauge

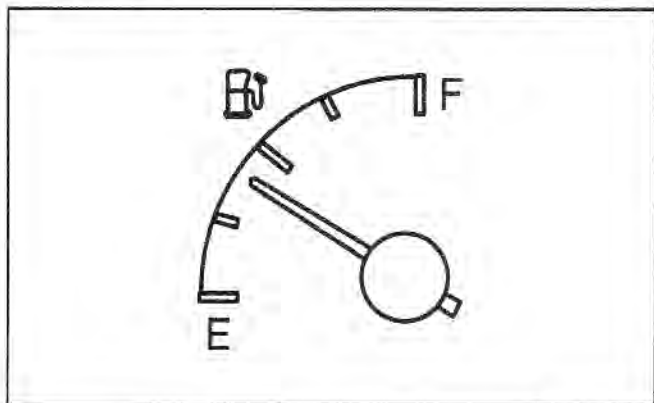

AN7B04024B

The fuel gauge indicates the approximate amount of fuel remaining in the fuel tank.

Fuel tank capacity - 60 liters (15.8 US gal.).

The fuel gauge is supplemented by a low fuel warning light, which will illuminate when the fuel level has dropped to about 10 liters (2.6 US gal.).

Tachometer

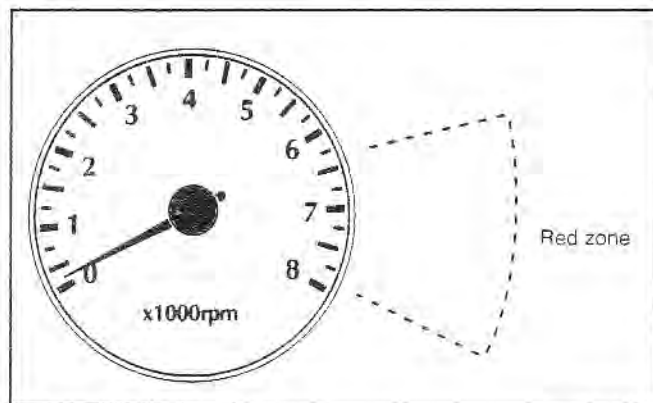

AN7B04025

The tachometer indicates the approximate number of engine revolutions per minute (rpm).

Use the tachometer to select the correct shift points and to prevent lugging the engine and/or over-revving the engine.

The tachometer pointer may move slightly when the ignition switch is in ACC or ON position with the engine OFF. This movement is normal and will not affect the accuracy of the tachometer once the engine is running.

*** NOTICE**

Do not operate the engine within the tachometer's RED ZONE.
This may cause severe engine damage.

Instrument Panel Illumination

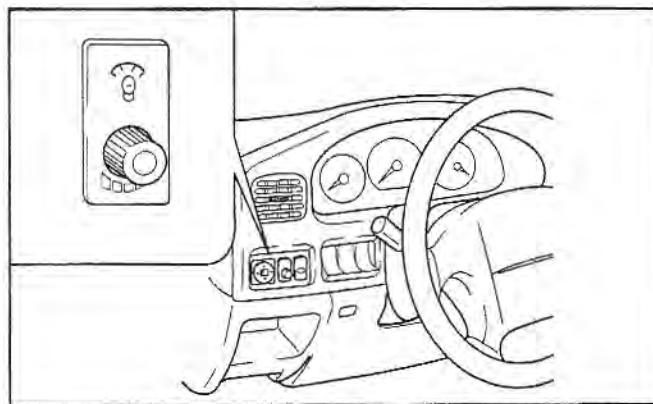

BN7B03043C

When the vehicle's parking lights or headlights are on, the instrument panel lights activate. This makes the instruments and controls visible in darkness. To adjust the instrument panel illumination intensity, use the following procedure.

Driving Your Vehicle

1. Depress the illumination control knob to pop it out.
2. Turn the knob to the right to brighten the lights or to the left to dim them.
3. Push the knob in after you select a brightness setting.

Warnings and Indicators

Warning Lights/Audible Indicators

Checking Operation

All warning lights are checked by turning the ignition switch ON (do not start the engine). Any light that does not illuminate should be checked by an authorized Kia dealer.

After starting the engine, check to make sure that all warning lights are off. If any are still on, this indicates a situation that needs attention. When releasing the parking brake, the brake system warning light should go off. The fuel warning light will stay on if the vehicle is low on fuel.

Auto Cruise Indicator (Optional)

**AUTO
CRUISE**

This indicator illuminates when the Auto Cruise system is activated. The indicator will go off if the system is deactivated by depressing the brake pedal, turning the cruise main switch off or the system disengages itself.

4WD Indicator (4WD only)



Shows 4WD (4H, 4L or N) is in use.

Anti-Lock Brake System (ABS)



Warning Light (Optional)

This light illuminates when you start the engine. The light will go off if the ABS system is operating normally.

Also, this light illuminates if the key is turned to ON and goes off in 3-4 seconds if the system is operating normally.

HOLD Indicator

(Automatic Transmission Only)

HOLD

Indicates that the Automatic Transmission is in HOLD mode.

Power Indicator

(Automatic Transmission Only)

POWER

Indicates that the Automatic Transmission is in Power Mode. If the Power Mode is operating and HOLD mode is selected, the Power Mode function is cancelled and the POWER indicator will go out.

Engine Oil Pressure Warning



This warning light indicates the engine oil pressure is low.

If the warning light illuminates while driving:

1. Drive safely to the side of the road and stop.
2. With the engine off, check the engine oil level. If the level is low, add oil as required.

Driving Your Vehicle

If the warning light remains on after adding oil or if oil is not available, call an authorized Kia dealer .

* NOTICE

If the engine is not stopped as soon as possible, severe damage could result.

Charging System Warning



This warning light indicates a malfunction of either the alternator or electrical charging system.

If the warning light comes on while the vehicle is in motion:

1. Drive to the nearest safe location.
2. With the engine off, check the generator drive belt for looseness or breakage. The generator drive belt is located on the driver's side of the engine. This belt also drives the engine cooling fan.

3. If the belt is adjusted properly, a problem exists somewhere in the electrical charging system. Have an authorized Kia dealer locate and correct the problem as soon as possible.

* NOTICE

Do not drive the vehicle with a loose or broken generator belt; the engine could be damaged by overheating because this belt also drives the engine cooling fan.

Safety Belt Warning



As a reminder to the driver and passenger, this warning light will remain on until the driver's safety belt is fastened. If the driver's lap/shoulder belt is not fastened when the key is turned ON or if it is unfastened after the key is ON, a chime sounds for approximately six seconds and the safety belt warning light remains on. If the system

does not operate as described, see an authorized Kia dealer for assistance.

Parking Brake & Brake Fluid Warning



Parking Brake Warning

This light is illuminated when the parking brake is applied with the ignition switch in the START or ON position. The warning light should go off when the parking brake is released.

Low Brake Fluid Level Warning

If the warning light remains on, it may indicate that the brake fluid level in the reservoir is low.

If the warning light remains on:

1. Drive to the nearest safe location and carefully stop your vehicle.
2. With the engine stopped, check the brake fluid level immediately and add fluid as required. Then check all brake components for fluid leaks.

3. Do not drive the vehicle if leaks are found, the warning light remains on or the brakes do not operate properly. Have it towed to any authorized Kia dealer for a brake system inspection and necessary repairs.

▲ WARNING - Brake Warning Light

Driving the vehicle with a warning light on is dangerous. If the brake warning light remains on, have the brakes checked and repaired immediately by an authorized Kia dealer.

To check bulb operation, the parking brake and brake fluid warning light illuminates when the ignition switch is in the ON position.

Driving Your Vehicle

Low Fuel Level Warning



This warning light indicates the fuel tank is near empty. The warning light will come on when the fuel level has dropped to about 10 liters (2.6 US gal.). Refuel as soon as possible.

Door Ajar Warning



This warning light comes on when a door is not closed securely. The light activates with the ignition switch in any position.

Headlight High Beam Indicator



This indicator activates when the headlights are on and in the high beam position or when the turn signal lever is pulled into the Flash-to-Pass position.

Back Door Ajar Warning



This warning light comes on when back door is not closed securely. The light activates with ignition switch in any position.

Shift Pattern Indicators

(Automatic Transmission Only)

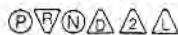

The individual indicators illuminate to show the shift lever selection. The P (Park) and R (Reverse) symbols are illuminated by red lights and the N (Neutral), D (Drive), 2 (Second), and L (Low) symbols are illuminated by green lights.

Rear Window Defroster Indicator



This light comes on when the rear defroster switch is depressed to remove the frost on the rear glass. Press the switch again to shut off the defroster when the frost is removed. The rear window defroster will automatically turn off after 15 minutes. It will also turn off whenever you remove the ignition key.

Check Engine Light



The CHECK ENGINE or malfunction indicator light is installed in your vehicle's instrument panel and responds to signals from the vehicle's On Board Diagnostic (OBD -II) System. The OBD-II System monitors the performance of the vehicle's Emission Control System (ECS), which is designed to reduce the amount of air pollutants in engine exhaust to the levels required by government regulations.

When you first start the engine, the CHECK ENGINE light will illuminate briefly as a system check to confirm that the OBD-II System is operating properly. As the engine starts, this light turns off. However, if at any time the OBD-II system detects a faulty signal or determines that the ECS is not performing to specification, the CHECK ENGINE light will illuminate continuously or flash.

Continuously on:

If the CHECK ENGINE light comes ON while driving and illuminates continuously, a potential problem has been discovered in the ECS or one of the exhaust system components. Generally, the vehicle will continue to be driveable but it should be checked by an authorized Kia dealer as soon as possible. This condition is unlikely to lead to engine damage unless a decrease in vehicle power or poor running conditions is immediately apparent.

Flashing on and off:

If the CHECK ENGINE light begins to flash ON and OFF, a more serious problem with the ECS or exhaust system component has been detected. If this happens, and there is no degradation to performance, the vehicle is still driveable (avoid high speeds) but should be checked by an authorized Kia dealer at your earliest possible convenience. If the flashing CHECK ENGINE light is accompanied by a decrease in power or poor running conditions, safely stop the vehicle and immediately contact Kia Roadside Assistance.

Note that the CHECK ENGINE light will illuminate for a problem like a loose or missing gas cap, but will not illuminate as a result of low

engine oil or coolant, low automatic transaxle fluid or engine overheating. The driver will be alerted to these conditions by other indicators on the instrument panel.

Air Bag Warning



This warning light will remain on for approximately 6 seconds each time you turn the ignition switch to the ON position. If this warning indicator does not do this or if it illuminates while the vehicle is being driven, see an authorized Kia dealer for immediate service.

Key Reminder Warning Chime

If the driver's door is opened and the ignition key is left in the ignition switch, the key reminder warning chime will sound. This is to prevent you from locking your keys in the vehicle.

Lights On Warning Chime

The lights on warning chime will sound if the headlight switch is left in the 1st or 2nd position and the driver's door is opened.

Driving Your Vehicle

* NOTICE

- Do not hold the lighter in after it is already heated because it will overheat.
- Only a genuine Kia lighter should be used in the cigarette lighter socket. The use of plug-in accessories (shavers, hand-held vacuums, and coffee pots, for example) may damage the socket or cause electrical failure.
- If the lighter does not pop out within 30 seconds, remove it to prevent overheating.

Ashtrays

Front Ashtray

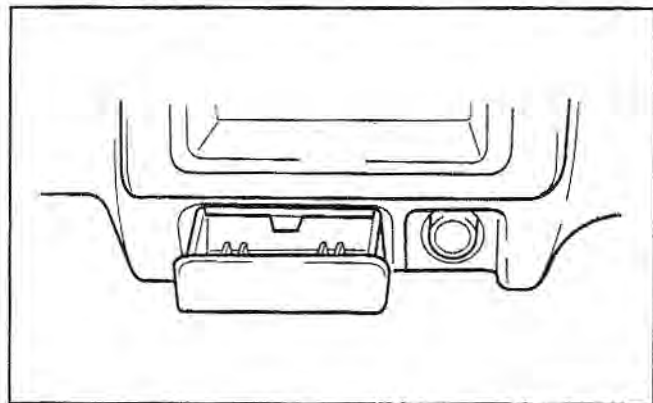

AN7B04036

To remove the ashtray, pull it out to the normal position, push down on the lock spring plate, and pull the ashtray out.

⚠ WARNING - Ashtray Use

- Do not use the vehicle's ashtrays as waste receptacles.
- Putting lit cigarettes or matches in an ashtray with other combustible materials may cause a fire.

Rear Ashtray

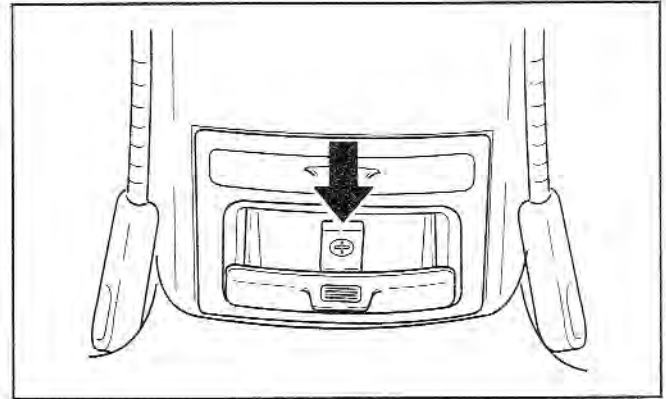

AN7B04037

To remove the rear ashtray, pull it out to the normal position, push down on the lock spring plate, and pull the ashtray out.

Driving Your Vehicle

Glove Box

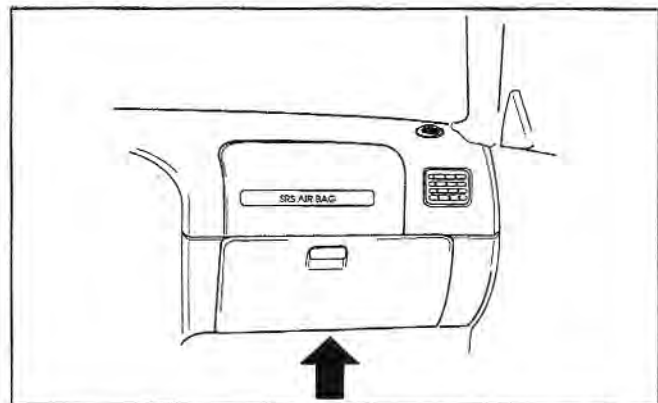

AN7B04038

To open the glove box door, pull the latch toward you.

Door Pocket

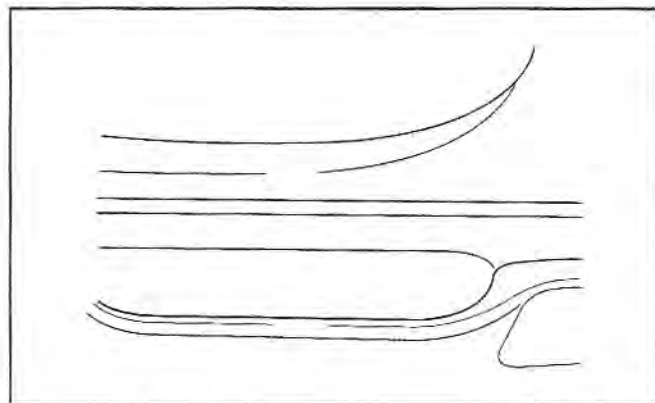

BN7B04039

Your front door pocket is a convenient place to store maps and small items.

CAUTION

To reduce the risk of injury in case of an accident or sudden stop, always keep the glove box door closed while driving.

Sunvisors

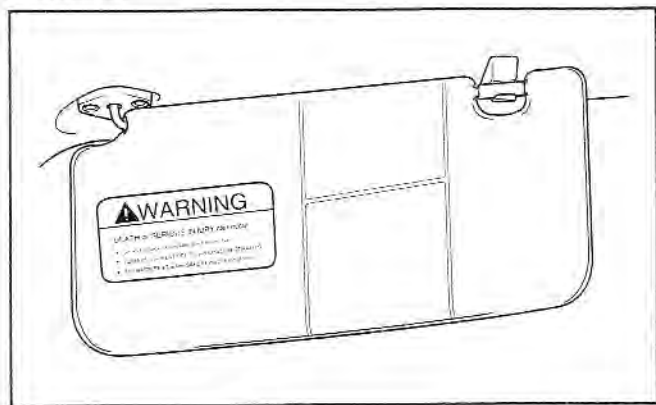

AN7B04040

To use a sunvisor, pull it downward.

To use a sunvisor for a side window, pull it downward, unsnap it from the bracket and swing it to the side.

There is a pocket on the driver's visor for items such as tickets or notes, and a vanity mirror is provided on the passenger's visor.

The driver's side sunvisor also provides important information about your vehicle's driver's side air bag system and about vehicle handling and usage.

Vanity Mirror (Passenger Side Visor) (Optional)

To use the vanity mirror, rotate the sunvisor downward.

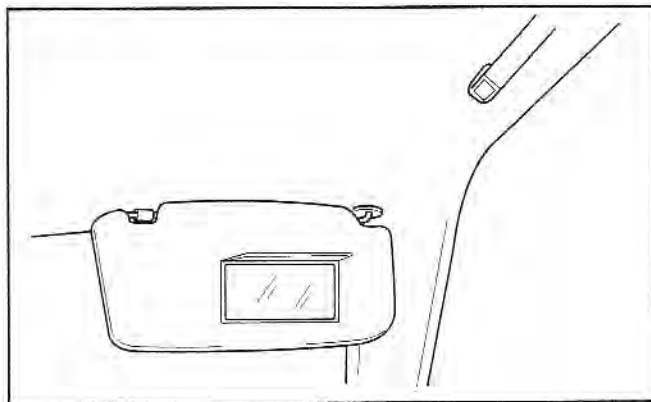

AS2B04034A

Driving Your Vehicle

Climate Control System

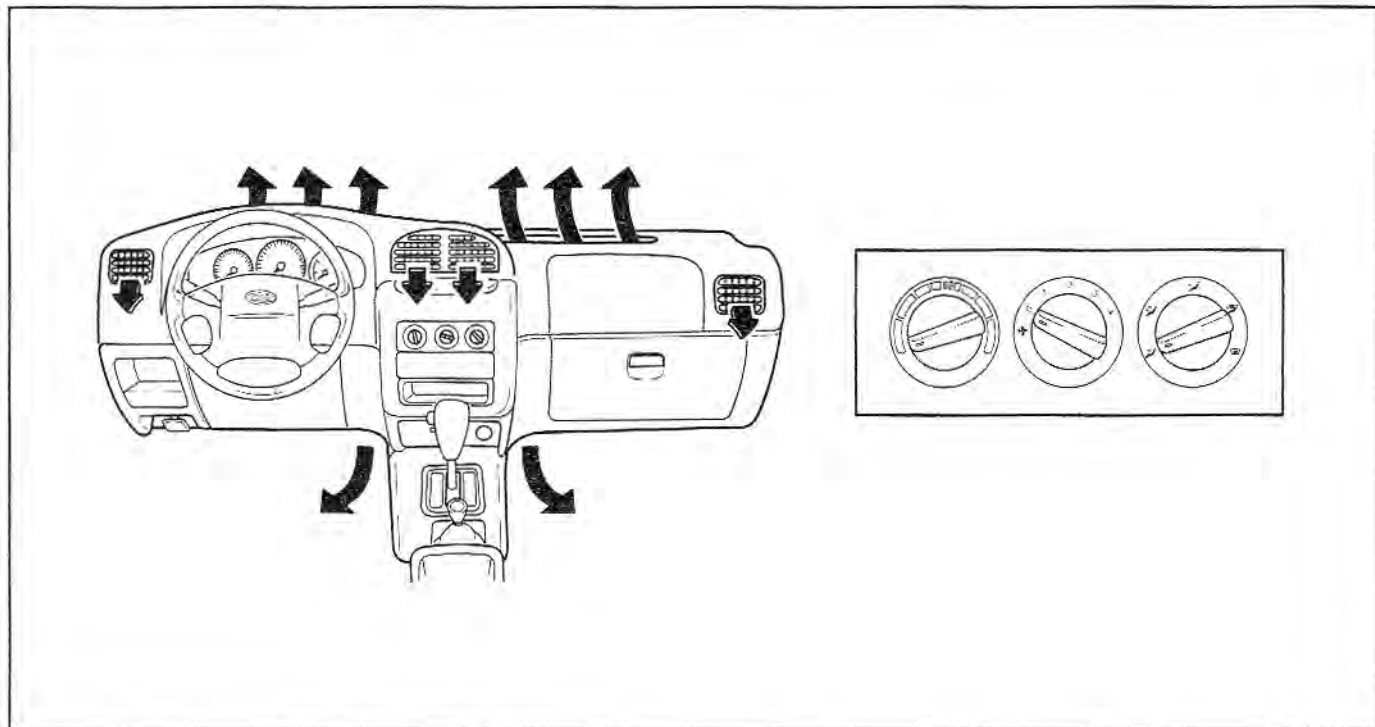

BN7B04042A

Temperature Control Knob

The temperature control knob allows you to control the temperature of the air flowing from the ventilation system.

To change the air temperature in the passenger compartment, turn the knob either clockwise for warm to hot air or counterclockwise for cooler air.

Air Intake Control Button

The air intake control button is located in the center console switch panel.

It is recommended that under normal conditions the outside (fresh) air position be selected.

Whenever you start the engine, the air flow control will be set at outside (fresh) air position. If you want the recirculated air position, press the corresponding button.

Recirculated Air Position

If you press the air intake control button once (recirculate), almost all outside air flow into the vehicle is shut off, and air within the vehicle will be recirculated.

This position can be used temporarily for maximum heating or cooling (if equipped with air conditioning) and to help prevent undesirable outside air flow into the vehicle.

CAUTION

Continued climate control system operation in the recirculated air position may allow humidity to increase inside the vehicle which may fog the glass and obscure visibility.

Outside (Fresh) Air Position

If you press the air intake control button again, the air position will be changed to outside (Fresh) air and air will enter the ventilation system from outside the vehicle. Use this position for normal ventilation and heating.

Driving Your Vehicle

Fan Speed Control knob

Four (4) adjustable fan speeds are provided which increase as the number increases. The ignition switch must be in the ON position for fan operation.

OFF- Fan off

- | | |
|------------------|-------------------|
| 1 - Low speed | 3 - High speed |
| 2 - Medium speed | 4 - Maximum speed |

Mode Selection knob

The mode selection knob controls the direction of air flow through the ventilation system.



AN7B04043

Face Position

Air flow is directed toward the upper body and face through all four (4) center instrument panel ventilation outlets.

Additionally, each outlet can be controlled to direct the air discharged from the outlet.



AN7B04044

Face-Floor Position

Air flow is directed toward the face and the floor. The air to the floor is warmer than to the face (except when the temperature control is set to the extreme cold position).



AN7B04045

Floor Position

Most of the air flow is directed to the floor, with a small amount being directed to the windshield and side window defrosters.



AN7B04046

Floor-Defrost Position



Most of the air flow is directed to the floor and the windshield with a small amount directed to the side window defrosters.



AN7B04047

Defrost Position

Most of the air flow is directed to the windshield with a small amount of air directed to the side window defrosters.

For improved defroster performance, when you select the  (Floor-Defrost) or  (Defrost) position, the air conditioning system (if equipped) is automatically turned on, and the outside (Fresh) air position is selected.

CAUTION

Continued climate control system operation in the recirculated air position may allow humidity to increase inside the vehicle which may fog the glass and obscure visibility.

Air Conditioning Switch (optional)

Depress the switch to turn the air conditioning system on. An indicator light in the switch will illuminate when the fan switch is on. Depress the switch again to turn the air conditioning system off.

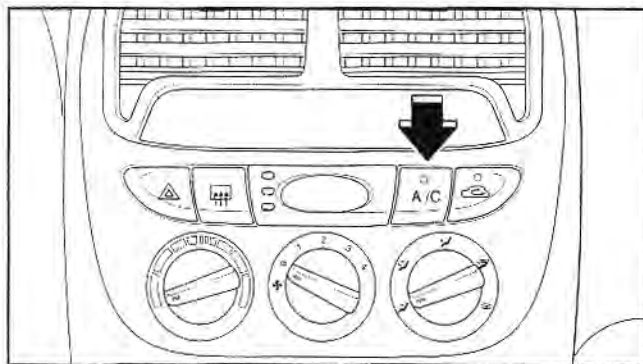

AN7B04048A

Driving Your Vehicle

System Operation

Ventilation



1. Set the mode selection knob to the  position.
2. Set the air intake control button to the outside air position.
3. Set the temperature control knob to the desired position.
4. Set the fan speed control knob to the desired speed.

Heating

1. Set the mode selection knob to the  position.
2. Set the air intake control button to the recirculated air position.

CAUTION

Continued climate control system operation in the recirculated air position may allow humidity to increase inside the vehicle which may fog the glass and obscure visibility.

3. Set the temperature control knob to the desired position.
4. Set the fan speed control knob to the desired speed.
5. If dehumidified heating is desired, turn the air conditioning system (if equipped) on.
 - *If cool air is desired at face level for bi-level operation, set the mode selection knob to the  position.*
 - *If the windshield fogs up, set the mode selection knob to the  position.*

Air Conditioning (optional)

All Kia Air Conditioning Systems are filled with environmentally friendly R134a refrigerant which is not damaging to the ozone layer.

1. Start the engine. Depress the air conditioning switch.
2. Set the mode selection knob to the  position.
3. Set the air intake control button to the outside air or recirculated air position.
4. Set the temperature control knob to the desired position.
5. Set the fan speed control knob to the desired speed.
6. Adjust the fan speed control lever and temperature control knob to maintain maximum comfort.

- *If warmer air is desired at floor level for bi-level operation, set the mode selection knob to the  position and adjust the temperature control knob to maintain maximum comfort.*
- *When maximum cooling is desired, rotate the temperature control knob to the extreme left position and set the air intake control button to the recirculated air position, then set the fan speed control knob to the highest speed.*

*** NOTICE**

When using the air conditioning system, monitor the temperature gauge closely while driving up long hills or in heavy traffic when outside temperatures are high. Air conditioning system operation may cause engine overheating. Continue to use the blower fan but turn the air conditioning system off if the temperature gauge indicates engine overheating.

Driving Your Vehicle

Air Conditioning System Operating Tips:



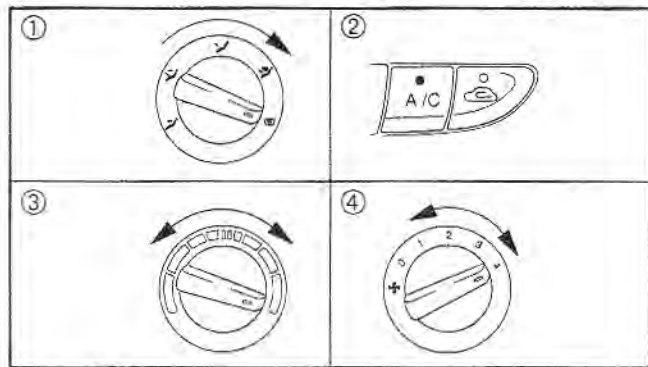

- If the vehicle has been parked in direct sunlight during hot weather, open the windows for a short time to let hot air inside the vehicle escape.
- To help reduce moisture on the inside of windows on rainy humid days, decrease the humidity inside the vehicle by operating the Air Conditioning System.
- During Air Conditioning System operation, you may occasionally notice a slight change in engine speed at idle as the A/C Compressor cycles on. This is a normal system operating characteristic.
- Use the Air Conditioning System every month if only for a few minutes.
- After Air Conditioning System use, you may notice clear water dripping (or even puddling) on the ground under the passenger side of the vehicle. This is a normal system operating characteristic.
- The Air Conditioning System includes a function that will automatically turn the A/C Compressor off if engine coolant temperature approaches an overheating level. A/C Compressor operation will resume once engine coolant temperature returns to the “normal” range. Also, the A/C Compressor is automatically turned off for a few seconds when the accelerator is fully depressed.
- When operating the Air Conditioning System use the Outside (fresh) air position.
- Operating the Air Conditioning System in the recirculated air position does provide maximum cooling, however, continual operation in this mode may cause the air inside the vehicle to become stale.

Windshield Defrosting and Defogging



BN7B04001

To defog inside windshield

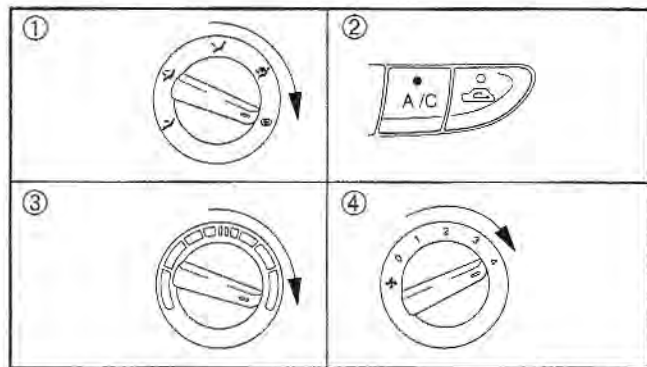

1. Set the mode selection knob to the  or  position.
2. When you select  or  position, the system automatically turns on the A/C(if equipped) and sets the air intake control button to the outside (fresh) air position.
3. Set the temperature control knob to the desired position.
4. Set the fan speed control knob to any desired speed except "O".

For maximum defogging, set the fan speed control knob to the "3" or "4" position.



BN7B04002



To defrost outside windshield

1. Set the mode selection knob to the  position.
2. When you select  position, the system automatically turns on the A/C(if equipped) and sets the air intake control button to the outside (fresh) air position.
3. Set the temperature control knob to the extreme right/hot position
4. Set the fan speed control knob to the "3" or "4" position.

Driving Your Vehicle

- For maximum defrosting, set the temperature control knob to the extreme right/hot position and the fan speed control knob to the highest speed.
- If warm air to the floor is desired while defrosting or defogging, set the mode selection knob to the  position.
- Before driving, clear all snow and ice from the windshield, rear window, outside rear view mirrors, and all side windows.
- Clear all snow and ice from the hood and the air inlet in the cowl grille to improve heater and defroster efficiency and to reduce the probability of fogging on the inside of the windshield.

WARNING

Do not use the  or  position during cool operation in extremely humid weather. The difference between the temperature of the outside air and that of the windshield could cause the outer surface of the windshield to fog up, causing loss of visibility. In this case, set the mode selection knob to the  position and fan speed control knob to the lower speed.



*** NOTICE**

If you don't want air-conditioning or outside (fresh) air when operating in either of these modes, pressing the air-conditioning switch or air intake control switch again will deactivate the air-conditioning or outside (fresh) air mode.

How to cancel forced air-conditioning operation and outside(fresh) air position in floor-defrost and defrost position ;

When you select the Floor-Defrost or Defrost position, the system automatically turns on the air-conditioning system and outside(fresh) air position will be selected.

If you don't want air-conditioning and outside(fresh) air position when operating in either of these modes you can turn off the air-conditioning system operation by performing the followings:

- 1) Turn the fan speed control knob to the "0" position.
- 2) Turn the mode selection knob to the defrost position ().
- 3) Push the air intake button () at least 5 times within 3 seconds.

Then the indicator light in the recirculated air position button will blink 3 times with 0.5 second of interval.

If you want to return to the automatic air conditioning system and outside(fresh) air position, repeat the same procedure.

Follow the same procedure if you want to cancel or return to the forced outside(fresh) air position when you start the engine.

Driving Your Vehicle

Recreational Towing Guidelines (Manual Transmission only)

* NOTICE

Sportage models with automatic transmissions should not be towed with all four tires in contact with the road surface unless an emergency exists. For "Emergency Towing" information, refer to Section 7 "In Case Of An Emergency."

General Precautions

- Follow all provincial and local laws applicable to vehicle towing.
- Never tow your Sportage from the rear (backwards) with all four tires in contact with the road surface.
- Do not use a towing dolly.

Recommended Towing Procedures

* NOTICE

If a single continuous towing distance will exceed 644 km (400 miles), have the rear drive shaft removed by an authorized Kia dealer.

Option #1

Disconnect and remove the rear drive shaft. This is the recommended option and allows the vehicle to be towed an unlimited distance.

Your authorized Kia dealer has Manual Locking Hubs available for installation which will eliminate the need to remove the rear drive shaft. Contact your authorized Kia dealer for details.

Driving Your Vehicle

Recreational Towing Guidelines (Manual Transmission only)

* NOTICE

Sportage models with automatic transmissions should not be towed with all four tires in contact with the road surface unless an emergency exists. For "Emergency Towing" information, refer to Section 7 "In Case Of An Emergency."

General Precautions

- Follow all provincial and local laws applicable to vehicle towing.
- Never tow your Sportage from the rear (backwards) with all four tires in contact with the road surface.
- Do not use a towing dolly.

Recommended Towing Procedures

* NOTICE

If a single continuous towing distance will exceed 644 km (400 miles), have the rear drive shaft removed by an authorized Kia dealer.

Option #1

Disconnect and remove the rear drive shaft. This is the recommended option and allows the vehicle to be towed an unlimited distance.

Your authorized Kia dealer has Manual Locking Hubs available for installation which will eliminate the need to remove the rear drive shaft. Contact your authorized Kia dealer for details.

Driving Tips

Before Driving	5-4
Emission Control System	5-3
Fuel Requirements	5-2
Label Information	5-41
Overloading	5-41
Special Driving Conditions	5-7
Suggestions for Economical Operation	5-6
Trailer Towing	5-33
Using Four-Wheel Drive	5-14
On Pavement Driving Tips	5-12
Off Road Driving With Your Four Wheel Drive Vehicle	5-16

Driving Tips

Fuel Requirements

Your new Kia vehicle must use only unleaded fuel having an octane rating of 87 or higher.

Your new Kia is designed to obtain maximum performance with UNLEADED FUEL, as well as minimize exhaust emissions and spark plug fouling.

* NOTICE

NEVER USE LEADED FUEL. The use of leaded fuel is detrimental to the catalytic converter and will damage the engine control system's oxygen sensor and affect emission control.

Never add any fuel system cleaning agents to the fuel tank other than what Kia has specified. (Consult an authorized Kia dealer for details.)

Gasoline Containing Alcohol and Methanol

Gasohol, a mixture of gasoline and ethanol (also known as grain alcohol), and gasoline or gasohol containing methanol (also known as wood alcohol) are being marketed along with or instead of leaded or unleaded gasoline.

Do not use gasohol containing more than 10% ethanol, and do not use gasoline or gasohol containing any methanol. Either of these fuels may cause driveability problems and damage to the fuel system.

Discontinue using gasohol of any kind if driveability problems occur.

Vehicle damage or driveability problems may not be covered by the manufacturer's warranty if they result from the use of:

1. Gasohol containing more than 10% ethanol.
2. Gasoline or gasohol containing methanol.
3. Leaded fuel or leaded gasohol.

*** NOTICE**

Never use gasoline which contains methanol. Discontinue use of any gasoline product which impairs driveability.

Emission Control System

The emissions control system of your vehicle is covered by a written limited warranty. Please see the warranty information contained in the Warranty and Consumer Information Manual in your vehicle.

Vehicle Modifications

This vehicle should not be modified. Modification of your Kia could affect its performance, safety or durability and may even violate governmental safety and emissions regulations.

In addition, damage or performance problems resulting from any modification may not be covered under warranty.

Engine Exhaust Gas Precautions (Carbon Monoxide)

Engine exhaust gases contain carbon monoxide. Though colorless and odorless, it is dangerous and could be lethal if inhaled.

- Carbon monoxide can be present with other exhaust fumes. Therefore, if you smell exhaust fumes of any kind inside your vehicle, have it inspected and repaired immediately by an authorized Kia dealer.
If you ever suspect exhaust fumes are coming into your vehicle, drive it only with all the windows fully open. Have your vehicle checked and repaired immediately.
- Do not operate the engine in confined or closed areas (such as garages) any more than what is necessary to move the vehicle in or out of the area.
- When the vehicle is stopped in an open area for more than a short time with the engine running, adjust the heating or cooling system (as needed) to draw outside air into the vehicle.
- Never sit in a parked or stopped vehicle for any extended time with the engine running.

Driving Tips

Operating Precautions for Catalytic Converters

Your vehicle is equipped with a catalytic converter emission control device.

Therefore, the following precautions must be observed:

- Use only UNLEADED FUEL.
- Do not park the vehicle over or near flammable objects, such as dry grass, paper, leaves, etc. Under certain conditions, they could be ignited by a hot exhaust system.
- Do not operate the vehicle when there are signs of engine malfunction, such as misfire or a noticeable loss of performance.
- Do not misuse or abuse the engine. Examples of misuse are coasting with the ignition off and descending steep grades in gear with the ignition off.

- Do not operate the engine at high idle speed for extended periods (5 minutes or more).
- Do not modify or tamper with any part of the engine or emission control system. All inspections and adjustments must be made by a qualified technician.

Failure to observe these precautions could result in damage to the catalytic converter and to your vehicle. Additionally, such actions could void your warranties.

Before Driving

Before entering vehicle:

- Be sure that all windows, outside mirror(s), and outside lights are clean.
- Check the condition of the tires.
- Check under the vehicle for any sign of leaks.
- Be sure there are no obstacles behind you if you intend to back up.

Necessary Inspections

Fluid levels, such as engine oil, engine coolant, brake/clutch fluid, and washer fluid should be checked on a regular basis, with the exact interval depending on the fluid. Further details are provided in Maintenance, Section 7.

Before Starting

- Close and lock all doors.
- Position the seat so that all controls are easily reached.
- Adjust the inside and outside rearview mirrors.
- Be sure that all lights work.
- Check all gauges.
- Check the operation of warning lights when the ignition switch is turned to the ON position.
- Release the parking brake and make sure the brake warning light goes out.

For safe operation, be sure you are familiar with your vehicle and its equipment.

Drunk Driving

Drinking and driving is dangerous. Drunk driving is the number one contributor to the highway death toll each year. Alcohol impairs a driver's judgment, vision and muscular coordination. Even a small amount of alcohol will affect a driver's reflexes, perceptions and judgment.

Please don't drink and drive, or ride with a driver who has been drinking. Choose a designated driver if you're with a group, or if you're alone, call a cab.

Drugs and Driving

Driving while under the influence of drugs is as dangerous or more dangerous than driving drunk, depending on the drug used and the quantity consumed. Don't take drugs and drive.

Driving Tips

Suggestions for Economical Operation

Your vehicle's fuel economy depends mainly on your style of driving, where you drive and when you drive.

Each of these factors affects how many miles (kilometers) you can get from a gallon (liter) of fuel. To operate your vehicle as economically as possible, use the following driving suggestions to help save money in both fuel and repairs:

- Avoid lengthy warm-up idling. Once the engine is running smoothly, begin driving. Remember, engine warm-up may take a little longer on cold days.
- Save fuel by accelerating slowly after stopping.
- Keep the engine in tune and follow the recommended periodic maintenance schedule. This will increase the life of all parts and lower your operating costs.
- Do not use the air conditioner unnecessarily.
- Slow down when driving on rough roads.
- For longer tire life and better fuel economy, always keep the tires inflated to the recommended pressures.
- Maintain a safe distance from other vehicles to avoid sudden stops. This will reduce wear on brake linings and pads. Driving in such a way will also save fuel because extra fuel is required to accelerate back to driving speed.
- Do not carry unnecessary weight in the vehicle.
- Do not rest your foot on the brake pedal while driving. This can cause needless wear, possible damage to the brakes, and poor fuel economy.
- Improper wheel alignment results in faster tire wear and lower fuel economy.

- Open windows at high speeds can reduce fuel economy.
- Fuel economy is less in crosswinds and headwinds. To help offset some of this loss, slow down when driving in these conditions.

Keeping a vehicle in good operating condition is important both for economy and safety. Therefore, have an authorized Kia dealer perform scheduled inspections and maintenance.

WARNING - Engine off Motion

Never turn the engine off to coast down hills or anytime the vehicle is in motion. The power steering and power brakes will not function without the engine running. Instead, downshift to an appropriate gear for engine braking effect.

Special Driving Conditions

Hazardous Driving Conditions

When hazardous driving conditions are encountered such as water, snow, ice, mud, sand, or similar hazards, follow these suggestions:

- Drive cautiously and allow extra distance for braking.
- Avoid sudden movements in braking or steering.
- When braking in the four-wheel drive mode, pump the brake pedal with a light up-and-down motion until the vehicle is stopped.
- If stalled in snow, mud, or sand, use second gear or shift the transfer case (if equipped) into four-wheel drive. Accelerate slowly to avoid spinning the drive wheels.

Driving Tips

- Use sand, rock salt, tire chains, or other non-slip material under the drive wheels to provide traction when stalled in ice, snow, or mud. (If equipped, refer to “Using Four-Wheel Drive.”)

⚠ WARNING - Downshifting

Downshifting into first gear with a manual transmission, or L (Low) with an automatic transmission, while driving on slippery surfaces can cause an accident. The sudden change in tire speed could cause the tires to skid. Be careful when downshifting on slippery surfaces.

Rocking the Vehicle

If it is necessary to rock the vehicle to free it from snow, sand, or mud, first turn the steering wheel right and left to clear the area around your front wheels. Then, shift back and forth between 1 (First) and R (Reverse) in vehicles equipped with a manual transmission or R (Reverse) and any

forward gear in vehicles equipped with an automatic transmission. Do not race the engine, and spin the wheels as little as possible. If you are still stuck after a few tries, have the vehicle pulled out by a tow vehicle to avoid engine overheating and possible damage to the transmission, transfer case (if equipped), or differential.

*** NOTICE**

Prolonged rocking may cause engine overheating, transmission or transfer case (if equipped) damage or failure, and tire damage.

⚠ WARNING - Spinning Tires

Do not spin the wheels especially at speeds more than 56 km/h (35 mph). Spinning the wheels at high speeds when the vehicle is stationary could cause a tire to overheat, explode and injure bystanders.

Driving at Night

Because night driving presents many more hazards than driving in the daylight, here are some important tips to remember:

- Slow down and keep more distance between you and other vehicles, as it may be more difficult to see at night, especially in areas where there may not be any street lights.
- Adjust your mirrors to reduce the glare from other driver's headlights.
- Keep your headlights clean and properly aimed. Dirty or improperly aimed headlights will make it much more difficult to see at night.
- Avoid staring directly at the headlights of oncoming vehicles. You could be temporarily blinded, and it will take several seconds for your eyes to readjust to the darkness.

Driving in the Rain

Rain and wet roads can make driving dangerous, especially if you're not prepared for the slick

pavement. Here are a few things to consider when driving in the rain:

- A heavy rainfall will make it harder to see and will increase the distance needed to stop your vehicle, so slow down.
- Keep your windshield wiping equipment in good shape. Replace your windshield wiper blades when they show signs of streaking or missing areas on the windshield.
- If your tires are not in good condition, making a quick stop on wet pavement can cause a skid and possibly lead to an accident. Be sure your tires are in good shape.
- Turn on your headlights to make it easier for others to see you.
- Driving too fast through large puddles can affect your brakes. If you must go through puddles, try to drive through them slowly.
- If you believe you may have gotten your brakes wet, apply them lightly while driving until normal braking operation returns.

Driving Tips

Winter Driving

- We recommend that you carry emergency equipment, including tire chains, a window scraper, windshield de-icer a bag of sand or salt, flares, a small shovel and jumper cables.
- Make sure you have sufficient ethylene-glycol coolant in the radiator.
- Check the battery condition and cables. Cold temperatures reduce the capacity of any battery, so it must be in excellent condition to provide enough winter starting power.
- Make sure the engine oil viscosity is suitable for cold weather.
- Check the ignition system for loose connections and damage.
- Use antifreeze-formulated windshield washer fluid. (Do not use engine coolant antifreeze.)
- Do not use the parking brake if it might freeze. When parking, shift to 1 (First) or R (Reverse) with a manual transmission or P (Park) with an automatic transmission, and block the rear wheels.

Snow Tires

If you mount snow tires on your Kia vehicle, make sure they are radial tires of the same size and load range as the original tires. Mount snow tires on all four wheels to balance your vehicle's handling in all weather conditions. Keep in mind that the traction provided by snow tires on dry roads may not be as high as your vehicle's original equipment tires. You should drive cautiously even when the roads are clear. Check with the tire dealer for maximum speed recommendations.



WARNING - Snow Tire Size

Snow tires should be equivalent in size and type to the vehicle's standard tires. Otherwise, the safety and handling of your vehicle may be adversely affected.

Do not install studded tires without first checking local, provincial and municipal regulations for possible restrictions against their use.

Tire Chains

Mount snow chains on your vehicle when warranted by driving conditions or required by local laws. Make sure the chains are the correct size for your tires. Install them only on the rear tires. If metal chains are used, they must be SAE class "S". Cable-type traction devices can also be used.

Chain Installation

When installing chains, follow the manufacturer's instructions and mount them as tightly as you can. Drive slowly with chains installed. If you hear the chains contacting the body or chassis, stop and tighten them. If they still make contact, slow down until it stops. Remove the chains as soon as you begin driving on cleared roads.

⚠ WARNING - Tire Chains

- The use of chains may adversely affect vehicle handling.
- Do not exceed 50 km/h (30 mph) or the chain manufacturer's recommended speed limit, whichever is lower.
- Drive carefully and avoid bumps, holes, sharp turns, and other road hazards, which may cause the vehicle to bounce.
- Avoid sharp turns or locked-wheel braking.
- Do not attempt to use a tire chain on the compact spare tire because it may impair vehicle handling and result in damage to the vehicle and to the tire.
- Chains that are the wrong size or improperly installed can damage your vehicle's brake lines, suspension, body and wheels.
- Stop driving and retighten the chains any time you hear them hitting the vehicle.

Driving Tips

Driving in Flooded Areas

Avoid driving through flooded areas unless you are sure the water is no higher than the bottom of the wheel hub. Drive through any water slowly. Allow adequate stopping distance because brake performance may be affected.

After driving through water, dry the brakes by gently applying them several times while the vehicle is moving slowly.

On-Pavement Driving Tips

This multi-purpose passenger vehicle is defined as a utility vehicle. Utility vehicles have higher ground clearance and a narrower track to make them capable of performing in a wide variety of off-road applications. Specific design characteristics give them a higher center of gravity than ordinary cars. An advantage of the higher ground clearance is a better view of the road, which allows you to anticipate problems. They are not designed for cornering at the same speeds as conventional two-wheel drive vehicles, any more than low-slung sports cars are designed to perform satisfactorily in off-road conditions. If at all possible, avoid sharp turns or abrupt maneuvers. As with other vehicles of this type, failure to operate this vehicle correctly may result in loss of control or vehicle rollover.

Rollover Warning Label

To remind you of the danger of the rollover, rollover warning label which are now required by Federal Safety regulations are adhered to the driver's sunvisor.

⚠ WARNING

As with other vehicles of this type (utility vehicle), failure to operate this vehicle correctly may result in loss of control, an accident or vehicle rollover.

- **Specific design characteristics (higher ground clearance, track, etc.) give this vehicle a higher center of gravity than ordinary cars.**
- **They are not designed for cornering at the same speeds as conventional 2-wheel drive vehicles.**
- **Avoid sharp turns or abrupt maneuvers.**
- **In a rollover crash, an unbelted person is significantly more likely to die than a person wearing a safety belt.**

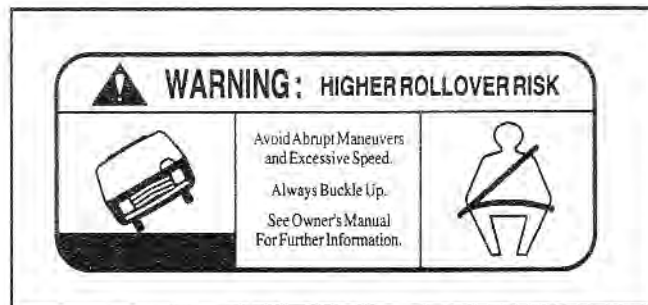

To remind you of the danger of the rollover, the rollover warning label is adhered to the driver's sunvisor. If you close the driver's sunvisor, you can see the rollover warning label which is located on the above the air bag warning label.

Driving Tips

Using Four-Wheel Drive

Driving on Snow- or Ice-Covered Roads (4H, 4L)

- Use snow tires or tire chains. See “Tires” in the Index for more information.
- Keep an adequate distance between yourself and other vehicles.
- Avoid sudden braking, acceleration or steering. These actions can cause your vehicle to lose traction.

Driving in Sand or Mud (4L)

- Avoid sudden braking, acceleration or steering. These actions can cause your vehicle to get stuck in the sand or mud.
- Drive at low speeds whenever possible.
- Use tire chains on the rear wheels when driving in mud, if necessary.
- You may need to get out of your vehicle at times to check road conditions.

- If you get stuck in the sand or mud, try placing stones, wood or other similar materials under the tires to get traction, or move forward and backward repeatedly to get unstuck.

WARNING - Traction

Make sure that no one stands in front of or behind the tires when materials are placed under the tires to get more traction. The tires may cause loose materials to fly out from under the vehicle, potentially causing serious bodily injury or death.

*** NOTICE**

Prolonged rocking may cause engine damage, overheating, transmission differential or transfer case (if equipped) damage or failure and tire damage.

Driving on a Hill (4L)

- Use low gear when going uphill or downhill and avoid sudden braking.
- Do not shift gears or use your clutch when going downhill. Do not coast downhill in Neutral.

Crossing a Ditch (4L)

- Avoid driving through ditches if possible, especially if there is water in the ditch. Your vehicle may stall if the electrical system gets wet. If you must cross a ditch, shift the transfer lever to 4L.
- Avoid driving where the water level is higher than the bottom of the wheel hub. If the water level rises above this mark, your vehicle will need to be serviced.
- Tap lightly on the brake pedal during and after driving through water. This will help keep the brakes dry and in proper working order.
- Do not shift gears while crossing a ditch.

Tight Corner Brake Effect

CAUTION

When turning sharply on a paved road at low speed while in four-wheel drive, steering control will be difficult.

This is called tight corner brake effect. This is a unique feature of four-wheel drive vehicles caused by the difference in tire rotation at the four wheels and the zero-degree alignment of the front wheels and suspension.

Sharp turns at low speeds should be carried out with caution.

Driving Tips

Off-Road Driving with Your Four-Wheel Drive Vehicle

Off-road driving can be great fun. But it has definite hazards. The greatest of these is the terrain itself.

“Off-roading” means you’ve left the paved road system behind. Traffic lanes are not marked. Curves are not banked.

There are no carefully engineered road signs to warn you of dangerous conditions or to advise you of a safe speed. You have to assess the environment yourself. Surfaces can be slippery, rough, uphill or downhill.

Off-road driving involves learning new skills. That’s why it’s important that you read and understand this section. You’ll find useful driving information and suggestions. These will help make your off-road driving safer and more enjoyable.

⚠ WARNING

As with other vehicles of this type (utility vehicle), failure to operate this vehicle correctly may result in loss of control, an accident or vehicle rollover.

- Specific design characteristics (higher ground clearance, track, etc.) give this vehicle a higher center of gravity than ordinary cars.
- They are not designed for cornering at the same speeds as conventional 2-wheel drive vehicles.
- Avoid sharp turns or abrupt maneuvers.
- In a rollover crash, an unbelted person is significantly more likely to die than a person wearing a safety belt.

Before You Go Off-Roading

There are some things to do before you leave the paved roads. Be sure to have all necessary maintenance and service work done beforehand. Be sure to read all the information about your four-wheel drive vehicle in this manual. Is there enough fuel? Is the spare tire fully inflated? Are the fluid levels at the proper levels? What are the local laws that apply to off-roading where you'll be driving? If you don't know, you should check with law enforcement people in the area. Will you be on someone's private land? If so, be sure to get the necessary permission.

Loading Your Vehicle for Off-Road Driving

There are some important items to remember about how to properly load your vehicle.

- The heaviest things should be in the cargo area and forward of your rear axle. Place heavier items as far forward as you can.
- Be sure the load is properly secured, so driving over off-road terrain doesn't shift your load or throw items toward the driver or passengers.

▲ WARNING - Cargo

- Cargo piled close to the height of (or higher than) the seat backs can be thrown forward during a sudden stop or on downhill slopes. You or your passengers could be severely injured. Keep cargo below the top of the seat backs and, if possible, do not pile separate items.
- Unsecured cargo in the cargo area can be tossed about when driving on the highways or over rough terrain. You or your passengers can be struck by flying objects and severely injured. Secure the cargo properly.

(Continued)

(Continued)

- Cargo should not be carried on the roof without a proper roof rack installed. The roof rack will hold a maximum of 45 kg (100 lbs.). Heavy loads in a roof rack raise the vehicle's center of gravity, making it more likely to roll over. You can be seriously or fatally injured if the vehicle rolls over. Do not load cargo on the roof while driving off-road, if at all possible. Put heavy loads inside the cargo area, not on the roof or in a roof rack. Keep cargo in the cargo area as far forward and low as possible.

Traveling to Remote Areas

It makes sense to plan your trip, especially when going to a remote area. Know the terrain and plan your route. You are much less likely to encounter unwanted surprises. Get accurate maps of trails.

It's also a good idea to travel with at least one other vehicle. If something happens to one of them, the other can quickly help.

Getting Familiar with Off-Road Driving

It's necessary for you to practice in an area that's safe and close to home before you begin serious off-road driving. Off-road driving requires new and different driving skills.

You need to tune your senses to different kinds of signals. For example, constantly sweep the terrain with your eyes looking for unexpected obstacles. Listen for unusual tire, gear, or engine sounds. Feel and respond to the vibrations of the vehicle with your hands, feet, and body while still carefully controlling your vehicle. You'll also need to adjust your expectations and greatly lower

the number of miles you expect to cover in an hour or a day.

Controlling your vehicle is the key to successful off-road driving. One of the best ways to control your vehicle is to control your speed. Here are some things to keep in mind when traveling at higher speeds:

- You approach things faster and you have less time to scan the terrain for obstacles.
- You have less time to react.
- You have much more vehicle bounce when you drive over obstacles, giving you less vehicle control.
- You'll need more distance for braking, especially since you're on an unpaved surface. Such terrain will always be more "slippery" than a paved road.

▲ WARNING - Off Road Driving

When you're driving off-road, bouncing and quick changes in direction can easily throw you out of position. This could cause you to lose control of the vehicle and crash. So, whether you are driving on or off the road, you and your passengers should always wear safety belts.

Scanning the Terrain

Off-road driving can take you over many different kinds of terrain. You need to be familiar with the terrain and its many different features. Here are some things to consider.

Surface Conditions

Off-roading can take you over hard-packed dirt, gravel, rocks, grass, sand, mud, snow or ice. Each of these surfaces affects the steering, acceleration, and braking of your vehicle in different ways.

Depending upon the kind of surface you are on, you may experience slipping, sliding, wheel spinning, delayed acceleration, poor traction, and longer braking distances.

Surface Obstacles

Unseen or hidden obstacles can be hazardous. A rock, log, hole, rut, or bump can startle you if you're not prepared. Often these obstacles are hidden by grass, bushes, snow or even the rise and fall of the terrain itself. Here are some things to constantly evaluate:

- Is the path ahead clear?
- Will the surface texture change ahead?
- Does the path take you uphill or downhill?
- Might you have to stop suddenly or change direction quickly?

When you drive over obstacles or rough terrain, it is critical that you keep a firm grip on the steering wheel. Ruts, troughs, or other surface features can

force the wheel out of your hands if you're not prepared.

When you drive over bumps, rocks, or other obstacles, your wheels can leave the ground. If this happens, even with one or two wheels, you can't control the vehicle as well or perhaps at all.

Because you will be on an unpaved surface, it's especially important to avoid sudden acceleration, sudden turns, or sudden braking. Any of these actions could cause the center of gravity of the vehicle to shift and destabilize the vehicle, leading to a collision or rollover accident.

Off-road driving requires a different kind of alertness from driving on paved roads and highways. There are no road signs, posted speed limits or signal lights. You have to use your own judgment about what is safe and what isn't. Bad judgment in this uncontrolled environment can be fatal.

▲ WARNING - Drinking & Driving
Drinking and driving, or drug use and driving can be very dangerous on any road. This certainly remains true for off-road driving. At the very time you need special alertness and driving skills, your reflexes, perceptions and judgement can be affected by even a small amount of alcohol or drugs. You could have a serious - or even fatal - accident if you drink or take drugs and drive or ride with a driver who has been drinking or taking drugs.

Driving on Off-Road Hills

Off-road driving often takes you up, down, or across a hill. Driving safely on hills requires excellent judgment and an understanding of what your vehicle can and can't do. There are some hills that simply should not be driven.

⚠ WARNING - Driving on Hills

Many hills are simply too steep for any vehicle. If you drive up them, you will stall. If you drive down them, you can't control your speed. In either case, you could flip over. If you drive across them, you will roll over. You could be seriously or fatally injured. If you have any doubt about the steepness, don't drive up or down the hill, even if it means that you have to turn around and find another route. Re-tracking is a normal part of safe off-roading.

Approaching a Hill

When you approach a hill, you need to decide if it's one of those hills that's just too steep to climb, descend, or cross. Steepness can be difficult to judge. On a very small hill, for example, there may be a smooth, constant incline with only a small change in elevation where you can easily see all the way to the top. On a large hill, the

incline may get steeper as you near the top, but you may not see this because the crest of the hill is hidden by bushes, grass, or shrubs.

Here are some other things to consider as you approach a hill:

- Is there a constant incline, or does the hill get sharply steeper in places?
- Is there good traction on the hillside, or will the surface cause tire slipping?
- Is there a straight path up or down the hill so you won't have to make turning maneuvers?
- Are there obstructions on the hill that can block your path (boulders, trees, logs or ruts)?
- What's beyond the hill? Is there a cliff, an embankment, a drop-off, or a fence? Get out of the vehicle and walk the hill if you are unsure. It's the smart way to find out.
- Is the hill simply too rough? Steep hills often have ruts, gullies, troughs, and exposed rocks because they are more susceptible to the effects of erosion.

- How have weather conditions affected the terrain? Is there likely to be mud, snow or ice on the hill?
- What time of day is it? Are temperatures dropping so that wet surfaces will start to freeze?

Driving Uphill

Once you decide you can safely drive up the hill, you need to take some special steps.

- Use a low gear and get a firm grip on the steering wheel.
- Get a smooth start up the hill and try to maintain your speed. Don't use more power than you need, because you don't want your wheels to start spinning or sliding.
- Try to drive straight up the hill, if at all possible. If the path twists and turns, you may have to find another route.

WARNING - Driving Across Hills

Turning or driving across steep hills can be dangerous. You could lose traction, slide sideways, or just reach an area too steep to traverse. In any case, it could cause you to roll over. You could be seriously or fatally injured. When driving up hills, always try to go as straight up as possible.

- Slow down as you approach the top of the hill.
- Attach a flag to the vehicle to make you more visible to approaching traffic on trails or hills.
- Sound the horn as you approach the top of the hill to let opposing traffic know you're there.
- Use your headlights even during the day. They make you more visible to other drivers.

⚠ WARNING - Driving over hills

Driving to the top (crest) of a hill at full speed can cause an accident and result in serious or fatal injury. There could be a drop-off, embankment, cliff, another vehicle or people sitting on the ground. As you near the top of a hill, slow down and stay alert.

Stalling While Driving Uphill

What should I do if my vehicle stalls, or is about to stall, and I can't make it up the hill?

If your vehicle stalls, or is about to stall while driving uphill, there are some things you should do, and there are some things you must not do.

First, here's what you **should** do:

- Push the brake pedal to stop the vehicle and keep it from rolling backwards. Also, apply the parking brake.

- If your engine is still running, shift the transmission into reverse, release the parking brake, and slowly back down the hill in reverse.
- If your engine has stopped running, you'll need to restart it. With the brake pedal depressed and the parking brake still applied, shift a manual transmission to Neutral, or an automatic transmission to P (Park) and restart the engine. Then, shift to reverse, release the parking brake, and slowly back down the hill in reverse.
- As you are backing down the hill, put your left hand on the steering wheel at the 12 o'clock position. This way, you'll be able to tell if your wheels are straight or turned to the left or right as you back down.

Here are some things you **must not** do if you stall, or are about to stall, when going up a hill.

- Never attempt to prevent a stall by depressing the clutch or shifting to N (Neutral) to "rev-up" the engine and regain forward momentum. This won't work. Your vehicle will roll backwards very quickly and you could go out of control or roll over.

Instead, apply the brake to stop the vehicle. Then apply the parking brake. Shift into reverse, release the parking brake, and slowly back down.

CAUTION

Never attempt to turn around if you are about to stall when going up a hill. If the hill is steep enough to stall your vehicle, it's steep enough to cause you to roll over if you turn around. If you can't make it up, you must back down the hill.

Stalled on a Steep Hill

If your vehicle stalls and you can't back down the hill, try this: Set the parking brake, put your transmission in first gear or P (Park), and turn the engine off. Leave the vehicle and get some help. If your vehicle is at an angle to the slope of the hill, exit the vehicle on the uphill side and stay clear of the path the vehicle would take if it rolled downhill. Do not shift the transfer case to N (Neutral) when you leave the vehicle. Leave it in a gear for manual transmission or P (Park) for

WARNING - Exiting Vehicle

Getting out on the downhill (low) side of a vehicle stopped across an incline is dangerous. If the vehicle rolls over, you could be crushed or fatally injured. Always get out on the uphill (high) side of the vehicle and stay well clear of the rollover path.

WARNING - Leaving Vehicle

For manual transmission-equipped vehicles, shifting the transfer case to N (Neutral) can cause your vehicle to roll even if the transmission is in gear. If you are going to leave your vehicle, set the parking brake and shift the transmission to first gear. Additionally, leave the transfer case in the 2H, 4H, or 4L position.

(Continued)

Driving Tips

(Continued)

For automatic transmission-equipped vehicles, shift to P (Park), set the parking brake and ensure that the transfer case lever is in the 2H, 4H or 4L position.

Driving Downhill

When off-roading takes you downhill, you'll want to consider many of the same things you thought about before you went uphill. As a brief reminder, those include:

- How steep is the downhill? Will I be able to maintain vehicle control?
- What's the surface like? Smooth? Rough? Slippery? Hard-packed dirt? Gravel?
- Are there hidden surface obstacles? Ruts? Logs? Boulders?
- What's at the bottom of the hill? Is there a hidden creek bank or even a river bottom with large rocks?

- Have changes in the weather conditions and their effect on the terrain since you went uphill made your task more difficult?

Once you have decided that you can go down a hill safely, try to keep your vehicle headed straight down, and use a low gear. This way, engine braking can help your brakes so they won't have to do all the work. Descend slowly, keeping your vehicle under control at all times.

CAUTION

Before beginning to go downhill, it is critical that you ensure that no cargo can shift forward while you are heading downhill. Such shifting could either endanger you and your occupants, or interfere with your ability to control the vehicle.

WARNING - Braking

Heavy braking when going down a hill can cause your brakes to overheat and fade. This could cause loss of control and a serious accident. Apply the brakes lightly when descending a hill and use a low gear to keep vehicle speed under control.

Avoid turns that take you across the incline of the hill. A hill that's not too steep to drive down may be too steep to drive across. You could roll over if you don't drive straight down.

Never go downhill with the clutch pedal depressed. This is called "free-wheeling." Your brakes will have to do all the work and could overheat and fade.

CAUTION

Avoid braking so hard that you lock the wheels when going downhill. If your front wheels are locked, you can't steer your vehicle.

If your wheels lock up during downhill braking, you may feel the vehicle starting to slide sideways. To regain your direction, just ease off the brakes and steer to keep the front of the vehicle pointing straight downhill.

Stalling Downhill

Stalling is much more likely to happen going uphill. But if it happens going downhill, here's what to do.

- Stop your vehicle by applying the brakes. Then apply the parking brake.
- Move the shift lever to P (Park) in automatic transmissions or shift to N (Neutral) in manual transmissions and, while still braking, restart the engine.
- Shift back to a low gear, release the parking brake, and drive straight down.
- If the engine won't start, get out and seek help. Exit on the uphill side of the vehicle and stay clear of the path the vehicle would take if it rolled downhill.

Driving Tips

Driving Across an Incline

Sooner or later, an off-road trail will probably go across the incline of a hill. If this happens, you have to decide whether or not to try to drive across the incline. Here are some things to consider:

- A hill that can be driven straight up or down may be too steep to drive across. When you go straight up or down a hill, the length of the wheel base (the distance from the front wheels to the rear wheels) reduces the likelihood the vehicle will tumble end over end. But when you drive across an incline, the much narrower track width (the distance between the left and right wheels) may not prevent the vehicle from tilting and rolling over. Also, driving across an incline puts more weight on the downhill wheels. This could cause a downhill slide or a rollover.

- Surface conditions can be a problem when you drive across a hill. Loose gravel, muddy spots, or even wet grass can cause your tires to slip sideways. If the vehicle slips sideways, it can hit something that will tip it (a rock, a rut, etc.) and cause it to roll over.
- Hidden obstacles can make the steepness of the incline even worse. If you drive across a rock with the uphill wheels, or if the downhill wheels drop into a rut or depression, your vehicle can tilt even more.

For reasons like these, you need to decide carefully whether or not to try to drive across an incline. Just because the trail goes across the incline doesn't mean you have to drive it.

 WARNING - Roll Over

Driving across an incline that's too steep will make your vehicle roll over. You could be seriously or fatally injured. If you have any doubt about the steepness of the incline, don't drive across it. Find another route instead.

If Your Vehicle Slides Downhill

If you feel your vehicle starting to slide sideways, turn downhill immediately. This should help straighten out the vehicle and prevent the side slipping. However, a much better way to prevent this is to get out and "walk the course" first so you know what the surface is like before you drive it.

Stalling While Crossing an Incline

If your vehicle stalls when you're crossing an incline, be sure you (and your passengers) get out on the uphill side, even if that door is harder to open. If you get out on the downhill side and the vehicle starts to roll over, you'll be in its path.

If you have to walk down the slope, stay out of the path the vehicle will take if it does roll over.

 WARNING - Exiting Vehicle

Getting out on the downhill (low) side of a vehicle stopped across an incline is dangerous. If the vehicle rolls over, you could be crushed or fatally injured. Always get out on the uphill (high) side of the vehicle and stay well clear of the rollover path.

Driving Tips

Driving in Mud, Sand, Snow, or Ice

When you drive in mud, sand, snow, or ice, your wheels won't get good traction. You can't accelerate as quickly, turning is more difficult, and you'll need longer braking distances.

It's best to use a low gear when you're in mud – the deeper the mud, the lower the gear. In extremely deep mud, the idea is to keep your vehicle moving so you don't get stuck.

When you drive on sand, you'll sense a change in wheel traction. But it will depend upon how loosely packed the sand is. On loosely packed sand (as on beaches or sand dunes) your tires will tend to sink into the sand. This has an effect on steering, accelerating, and braking. You may want to reduce the air pressure in your tires slightly when driving on sand. This will improve traction. Remember to re-inflate them the first chance that you have after you leave the loosely packed sand.

*** NOTICE**

- In case of loss of traction in mud, loose soil, or sand, turn the steering wheel rapidly from side-to-side. This can help generate additional traction.
- Do not gun the engine. This will cause the tires to spin and dig down, not forward, and could bury the vehicle to the frame. Smooth, easy power is better than too much power.

Hard-packed snow and ice offer the worst tire traction. On these surfaces, it's very easy to lose control. On wet ice, for example, the traction is so poor that you will even have difficulty accelerating. And if you do get moving, poor steering and difficult braking can easily cause you to slide out of control.

 **WARNING - Frozen Surfaces**

Driving on frozen lakes, ponds or rivers can be dangerous. Underwater springs, currents under the ice, or sudden thaws can weaken the ice. Your vehicle could fall through the ice and you and your passengers could drown. Drive your vehicle on safe surfaces only.

Driving in Water

Light rain causes no special off-road driving problems. However, heavy rain can cause flash flooding, and flood waters demand extreme caution.

Find out how deep the water is before you drive through it. If it's deep enough to cover your wheel bearing hubs, axles, or exhaust pipe, don't try it - you probably won't get through. Also, water that deep can damage your axle and other vehicle parts.

If the water isn't too deep, then drive through slowly. At fast speeds, water can splash on your ignition system and your vehicle can stall. Stalling can also occur if your tailpipe goes underwater. As long as your tailpipe is underwater, you will not be able to start your engine. When you go

Driving Tips

through water, remember that it may take you longer to stop when your brakes are wet.

If you have driven through water that was deep enough to cover your wheel bearing hubs, it may be a good idea to have an authorized Kia dealer or other competent service center repack your front wheel bearings and examine your rear-end fluid for evidence of water.

WARNING - Water

Driving through rushing water can be dangerous. Deep water can sweep your vehicle downstream and you and your passengers could drown. If it's only inches deep, it can still wash away the ground from under your tires, and you could lose traction and roll the vehicle. Never drive through rushing water.

After Off-Road Driving

Remove any brush or debris that has collected on the underbody, chassis or under the hood. These accumulations can be a fire hazard.

After driving in mud or sand, clean and check the brake linings. Accumulation of mud or sand can cause glazing and uneven braking. Check the body structure, steering, suspension, wheels, tires, and exhaust system for damage. Also, check the fuel lines and cooling system for any leakage. Your vehicle will also require more frequent service due to off-road use.

Trailer Towing

⚠ WARNING - Towing a Trailer

If you don't use the correct equipment and drive properly, you can lose control when you pull a trailer. For example, if the trailer is too heavy, the brakes may not work well - or even at all. You and your passengers could be seriously or fatally injured. Pull a trailer only if you have followed all the steps in this section.

Maximum trailer weight:

- **Trailer without brake system:**
450kg (1,000 lbs.)
Tongue weight: 45 kg (100 lbs.)
- **Trailer with brake system:**
900kg (2,000 lbs.)
Tongue weight: 91kg (200 lbs.)

*** NOTICE**

Pulling a trailer improperly can damage your vehicle and result in costly repairs not covered by your warranty. To pull a trailer correctly, follow the advice in this section.

Your vehicle can tow a trailer. To identify what the vehicle trailering capacity is for your vehicle, you should read the information in "Weight of the Trailer" that appears later in this section.

Remember that trailering is different than just driving your vehicle by itself. Trailering means changes in handling, durability, and fuel economy. Successful, safe trailering takes correct equipment, and it has to be used properly.

This section contains many time-tested, important trailering tips and safety rules. Many of these are important for your safety and that of your passengers. Please read this section carefully before you pull a trailer.

Driving Tips

Load-pulling components such as the engine, transmission, wheel assemblies, and tires are forced to work harder against the load of the added weight. The engine is required to operate at relatively higher speeds and under greater loads. This additional burden generates extra heat. The trailer also adds considerably to wind resistance, increasing the pulling requirements.

If You Do Decide to Pull a Trailer

Here are some important points if you decide to pull a trailer:

- State, provincial, county and municipal government have varying trailering laws. Make sure your hitch, mirrors, lights and wiring arrangements are legal, not only where you live, but also where you'll be driving. A good source for this information is state or local law enforcement agencies.
- Consider using a sway control. You can ask a hitch dealer about sway control.

- After your odometer indicates 800 km (500 miles) or more, you can tow a trailer. For the first 800 km (500 miles) that you tow a trailer, don't drive over 80 km/h (50 mph) and don't make starts at full throttle. This helps your engine and other parts of your vehicle "wear" in at the heavier loads.
- Three important considerations have to do with weight:

Weight of the Trailer

How heavy can a trailer safely be? It should never weigh more than 900 kg (2,000 pounds). But even that can be too heavy.

It depends on how you plan to use your trailer. For example, speed, altitude, road grades, outside temperature and how much your vehicle is used to pull a trailer are all important. The ideal trailer weight can also depend on any special equipment that you have on your vehicle.

Weight of the Trailer Tongue

The tongue load of any trailer is an important weight to measure because it affects the total gross vehicle weight (GVW) of your vehicle. This weight includes the curb weight of the vehicle, any cargo you may carry in it, and the people who will be riding in the vehicle. And if you will tow a trailer, you must add the tongue load to the GVW because your vehicle will also be carrying that weight.

The trailer tongue should weigh a maximum of 10% of the total loaded trailer weight. After you've loaded your trailer, weigh the trailer and then the tongue, separately, to see if the weights are proper. If they aren't, you may be able to correct them simply by moving some items around in the trailer.

CAUTION

- *Never load a trailer with more weight in the rear than in the front. The front should be loaded with approximately 60% of the total trailer load; the rear should be loaded with approximately 40% of the total trailer load.*
- *Never exceed the maximum weight limits of the trailer or trailer towing equipment. Improper loading can result in damage to your vehicle and/or personal injury. Check weights and loading at a commercial scale or highway patrol office equipped with scales.*

Driving Tips

Total Weight on Your Vehicle's Tires

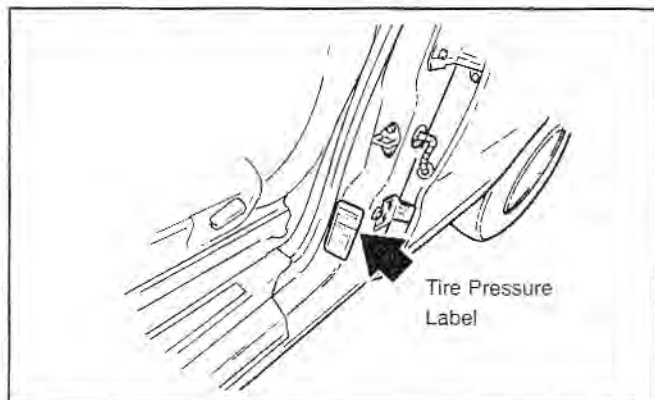

AN7B05001

Be sure your vehicle's tires are inflated to the limit for cold tires. You'll find these numbers on the Tire Pressure label on the driver's door pillar (or see "Label Information" in the Index). Be sure not to exceed the GVW limit for your vehicle.

Hitches

It's important to have the correct hitch equipment. Crosswinds, large trucks going by, and rough roads are a few reasons why you'll need the right hitch. Here are some rules to follow:

- Will you have to make any holes in the body of your vehicle when you install a trailer hitch? If you do, then be sure to seal the holes later when you remove the hitch. If you don't seal them, deadly carbon monoxide (CO) from your exhaust can get into your vehicle, as well as dirt and water.
- The bumpers on your vehicle are not intended for hitches. Do not attach rental hitches or other bumper-type hitches to them. Use only a frame-mounted hitch that does not attach to the bumper.

Safety Chains

You should always attach chains between your vehicle and your trailer. Cross the safety chains under the tongue of the trailer so that the tongue

will not drop to the road if it becomes separated from the hitch. Instructions about safety chains may be provided by the hitch manufacturer or by the trailer manufacturer. Follow the manufacturer's recommendation for attaching safety chains. Always leave just enough slack so you can turn with your trailer. And, never allow safety chains to drag on the ground.

Trailer Brakes

If your trailer weighs more than 450 kg (1,000 pounds) loaded, then it needs its own brakes – and they must be adequate. Be sure to read and follow the instructions for the trailer brakes so you'll be able to install, adjust and maintain them properly.

- Don't tap into your vehicle's brake system.
- Do not use a trailer with its own brakes unless you are absolutely certain that you have properly set up the brake system. This is not a task for amateurs. Use an experienced, competent trailer shop for this work.

Driving with a Trailer

Towing a trailer requires a certain amount of experience. Before setting out for the open road, you must get to know your trailer. Acquaint yourself with the feel of handling and braking with the added weight of the trailer. And always keep in mind that the vehicle you are driving is now a good deal longer and not nearly so responsive as your vehicle is by itself.

Before you start, check the trailer hitch and platform, safety chains, electrical connector(s), lights, tires and mirror adjustment. If the trailer has electric brakes, start your vehicle and trailer moving and then apply the trailer brake controller by hand to be sure the brakes are working. This lets you check your electrical connection at the same time.

During your trip, check occasionally to be sure that the load is secure, and that the lights and any trailer brakes are still working.

Driving Tips

Following Distance

Stay at least twice as far behind the vehicle ahead as you would when driving your vehicle without a trailer. This can help you avoid situations that require heavy braking and sudden turns.

Passing

You'll need more passing distance up ahead when you're towing a trailer. And, because you're a good deal longer, you'll need to go much farther beyond the passed vehicle before you can return to your lane.

Backing Up

Hold the bottom of the steering wheel with one hand. Then, to move the trailer to the left, just move your hand to the left. To move the trailer to the right, move your hand to the right. Always back up slowly and, if possible, have someone guide you.

Making Turns

When you're turning with a trailer, make wider turns than normal. Do this so your trailer won't

strike soft shoulders, curbs, road signs, trees, or other objects. Avoid jerky or sudden maneuvers. Signal well in advance.

Turn Signals When Towing a Trailer

When you tow a trailer, your vehicle has to have a different turn signal flasher and extra wiring. The green arrows on your instrument panel will flash whenever you signal a turn or lane change. Properly connected, the trailer lights will also flash to alert other drivers you're about to turn, change lanes, or stop.

When towing a trailer, the green arrows on your instrument panel will flash for turns even if the bulbs on the trailer are burned out. Thus, you may think drivers behind you are seeing your signals when, in fact, they are not. It's important to check occasionally to be sure the trailer bulbs are still working. You must also check the lights every time you disconnect and then reconnect the wires. Do not connect a trailer lighting system directly to your vehicle's lighting system.

Use only an approved trailer wiring harness. Your authorized Kia dealer can assist you in installing the wiring harness.

CAUTION

Failure to use an approved trailer wiring harness could result in damage to the vehicle electrical system and/or personal injury.

Driving on Grades

Reduce speed and shift to a lower gear **before** you start down a long or steep downgrade. If you don't shift down, you might have to use your brakes so much that they would get hot and no longer operate efficiently.

On a long uphill grade, shift down and reduce your speed to around 70 km/h (45 mph) to reduce the possibility of engine and transmission overheating.

If your trailer weighs more than 450kg (1000 lbs) and you have an automatic transmission, you should drive in D (Drive) when towing a trailer.

Operating your vehicle in D (Drive) when towing a trailer will minimize heat buildup and extend the life of your transmission. If you have a manual transmission, drive in fourth gear (or, as you need to, a lower gear).

Parking on Hills

Generally, you should not park your vehicle, with a trailer attached, on a hill. People can be seriously or fatally injured, and both your vehicle and the trailer can be damaged if they begin a downhill trajectory.

 **WARNING - Parking on a Hill**
Parking your vehicle on a hill with a trailer attached could cause serious injury or death should a down hill trajectory happen.

Driving Tips

However, if you ever have to park your trailer on a hill, here's how to do it:

1. Apply your brakes, but don't shift into gear.
2. Have someone place chocks under the trailer wheels.
3. When the wheel chocks are in place, release the brakes until the chocks absorb the load.
4. Reapply the brakes. Apply your parking brake, and then shift to R (Reverse) for a manual transmission or P (Park) for an automatic transmission.
5. Be sure the transfer case is fully engaged in a drive gear – not in N (Neutral).
6. Release the brakes.

WARNING - Parking Brake

It can be dangerous to get out of your vehicle if the parking brake is not firmly set.

If you have left the engine running, the vehicle can move suddenly. You or others could be seriously or fatally injured.

When You Are Ready to Leave After Parking on a Hill

1. With the manual transmission in Neutral or automatic transmission in P (Park), apply your brakes and hold the brake pedal down while you:
 - Start your engine;
 - Shift into gear; and
 - Release the parking brake.
2. Slowly remove your foot from the brake pedal.
3. Drive slowly until the trailer is clear of the chocks.
4. Stop and have someone pick up and store the chocks.

Maintenance When Trailer Towing

Your vehicle will need service more often when you regularly pull a trailer. Important items to pay particular attention to include engine oil, automatic transmission fluid, axle lubricant and cooling system fluid. Brake condition is another important item to frequently check. Each item is covered in this manual, and the Index will help you find them quickly. If you're trailering, it's a good idea to review these sections before you start your trip.

Don't forget to also maintain your trailer and hitch. Follow the maintenance schedule that accompanied your trailer and check it periodically. Preferably, conduct the check at the start of each day's driving. Most importantly, all hitch nuts and bolts should be tight.

Overloading

CAUTION

The gross axle weight rating (GAWR) and the gross vehicle weight rating (GVWR) for your vehicle are on the manufacturer's label attached to the driver's door. Exceeding these ratings can cause an accident or vehicle damage. You can calculate the weight of your load by weighing the items (or people) before putting them in the vehicle. Be careful not to overload your vehicle.

Label Information

There are several important labels and identification numbers located on your vehicle. The label locations are identified in the illustrations on the following three pages.

Driving Tips

Vehicle Identification Number (VIN)

This is the legal identifier for your vehicle. It appears on a plate attached to the left side of the forward portion of the dashboard. The VIN plate can be easily seen from the outside of the vehicle through the windshield on the driver's side.

The VIN also appears on the vehicle's certification label on the pillar to the rear of the driver's door, and on the vehicle frame directly below the passenger's side door handle.

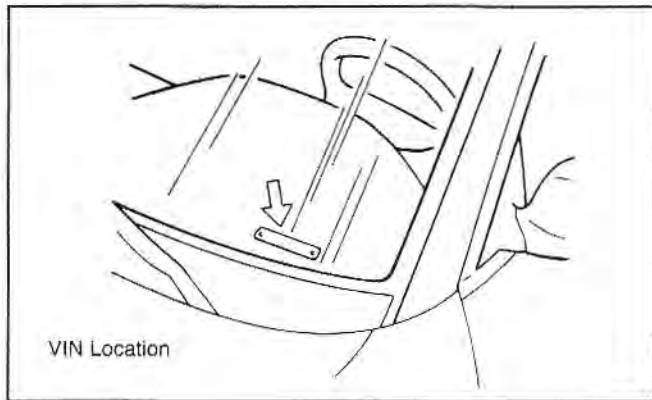

AN7B05002

Vehicle Certification Label

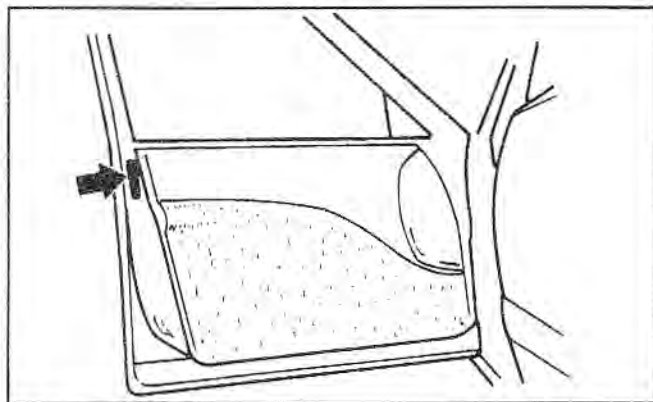

AN7B05003

Frame Vehicle Identification Number

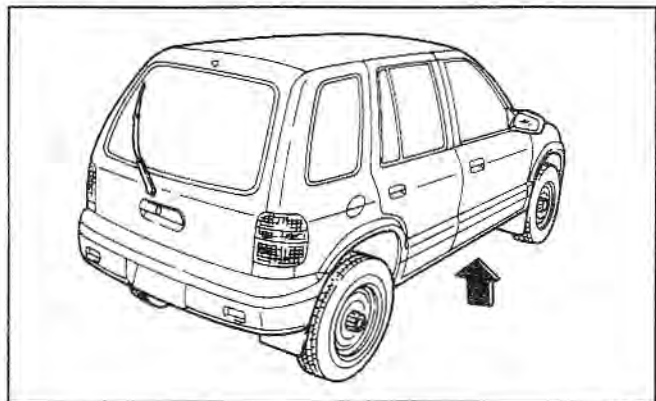

AN7B05004

Chassis Number

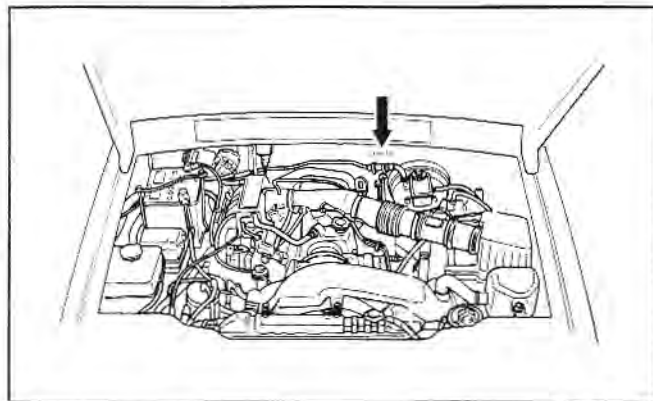

AN7B05005

Driving Tips

Vehicle Emission Control Information/Vacuum Hose Routing Diagram

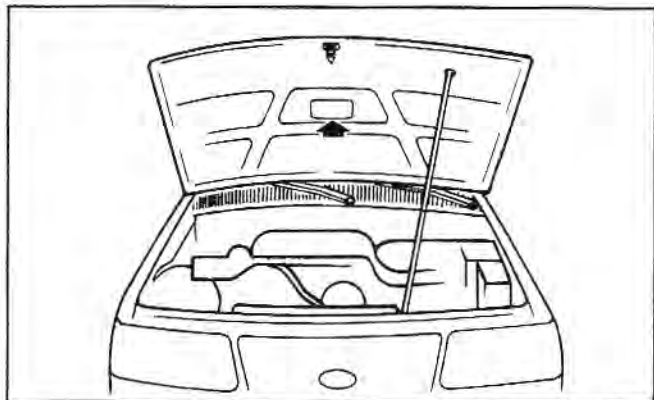

AN7B05006

Tire Information Label

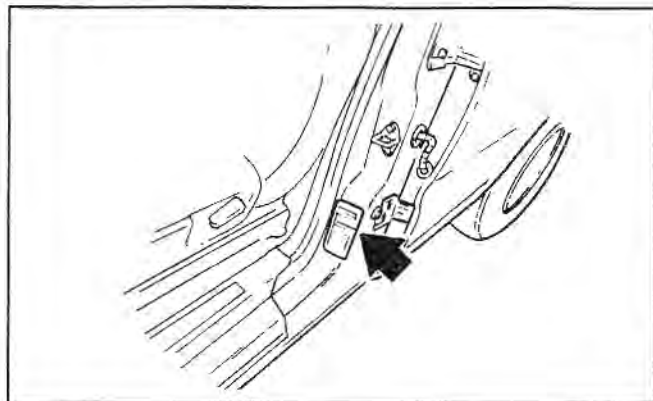

ZAN7B05007

In Case Of An Emergency

Electrical Circuit Protection	6-7
Emergency Starting	6-4
If You Have a Flat Tire	6-18
Overheating	6-2
Road Warning	6-2
Towing	6-13

In Case Of An Emergency

Road Warning

Hazard Warning Flasher

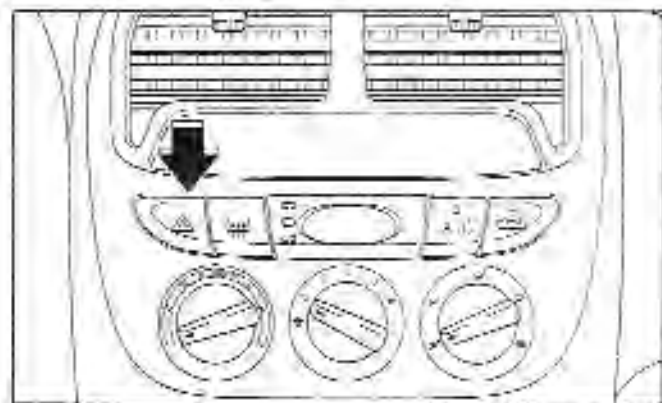

The hazard warning flasher serves as a warning to other drivers to exercise extreme caution when approaching, overtaking, or passing your vehicle. It should be used whenever emergency repairs are being made or when the vehicle is stopped near the edge of a roadway.

Depress the flasher switch with the ignition switch in any position. The flasher switch is located in the center console switch panel. All turn signal lights will flash simultaneously.

- *The hazard warning flasher operates whether your vehicle is running or not.*
- *The turn signals do not work when the hazard flasher is on.*
- *Care must be taken when using the hazard warning flasher while the vehicle is being towed. Local regulations may prohibit using it in this manner.*

Overheating

If your temperature gauge indicates overheating, if you experience a loss of power, or if you hear a loud knocking or pinging noise, the engine has probably overheated. Should any of these symptoms occur, use the following procedure:

1. Turn on the hazard warning flasher, then drive to the nearest safe location and stop your vehicle; shift to Neutral (manual transmission) or Park (automatic transmission) and apply the parking brake.
2. Make sure the air conditioner is off.
3. If coolant or steam is boiling out of the radiator, stop the engine and call an authorized Kia dealer for assistance.

If coolant is not boiling out, allow the engine to idle and open the hood to permit the engine to cool gradually.

If the temperature does not go down with the engine idling, stop the engine and allow sufficient time for it to cool.

4. The coolant level should then be checked. Use the coolant reservoir dipstick to check the level. If the level in the reservoir is low, look for leaks at the radiator hoses and connections, heater hoses and connections, radiator, and water pump. If you find a major leak or another problem that may have caused the engine to overheat, do not operate the engine until it has been corrected. Call an authorized Kia dealer for assistance. If you do not find a leak or other problem, carefully add coolant to the reservoir.

 WARNING - Removing Radiator Cap

Do not remove the radiator cap when the engine and radiator are hot. Scalding hot coolant and steam may blow out under pressure. This could cause serious injury.

If the engine frequently overheats, have the cooling system checked and repaired.

In Case Of An Emergency

Emergency Starting

Jump Starting

Jump starting can be dangerous if done incorrectly. Therefore, to avoid harm to yourself or damage to your vehicle or battery, follow the jump starting procedures on this page. If in doubt, we strongly recommend that you have a competent technician or towing service jump start your vehicle.

*** NOTICE**

Use only a 12-volt jumper system. You can damage a 12-volt starting motor, ignition system, and other electrical parts beyond repair by use of a 24-volt power supply (either two 12-volt batteries in series or a 24-volt motor generator set).

⚠ WARNING - Battery

- **Keep all flames or sparks away from the battery. The battery produces hydrogen gas which may explode if exposed to flame or sparks.**
- **Do not attempt to jump start the vehicle if the discharged battery is frozen or if the electrolyte level is low; the battery may rupture or explode.**

Jump Starting Procedure

1. Make sure the booster battery is 12-volt and that its negative terminal is grounded.
2. If the booster battery is in another vehicle, do not allow the vehicles to touch.
3. Turn off all unnecessary electrical loads.

Connecting Jumper Cables

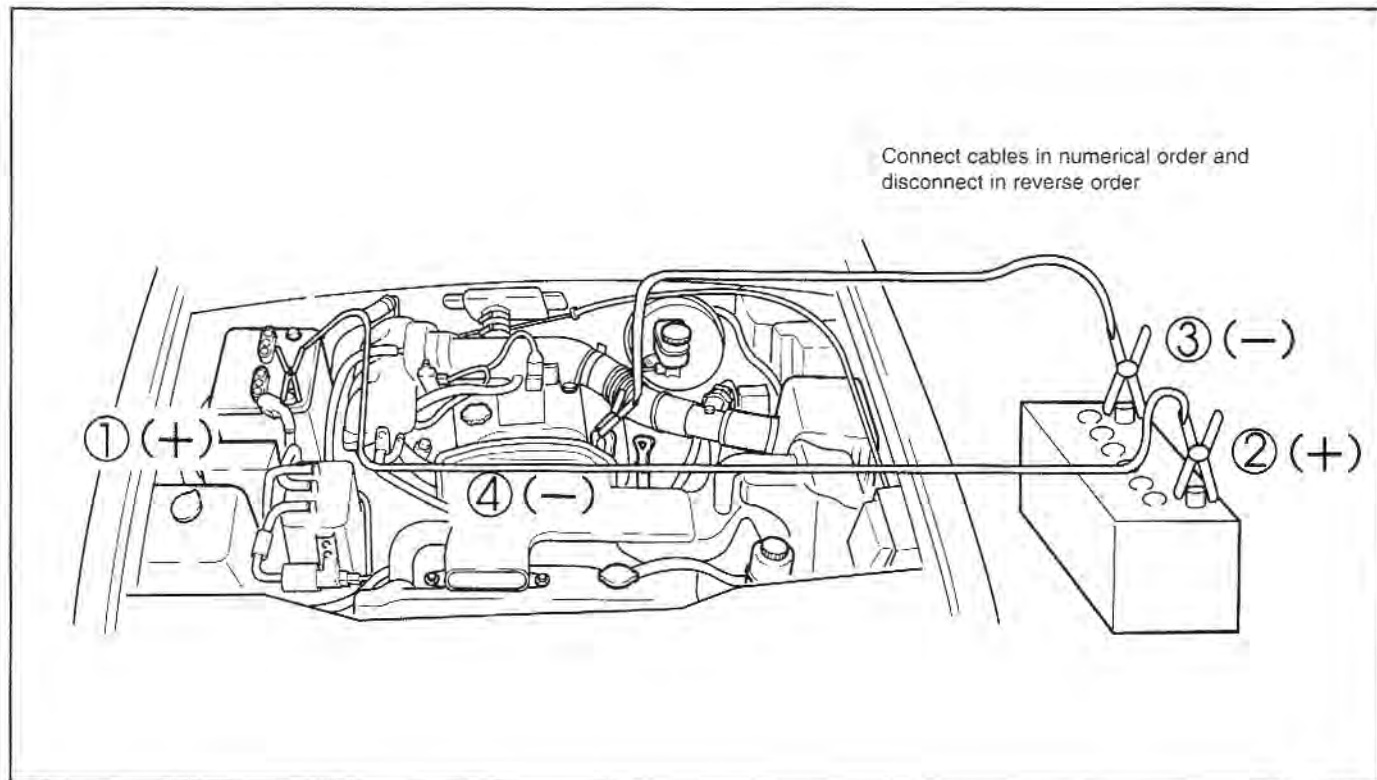

AN7B06002A

In Case Of An Emergency

4. Turn off all unnecessary electrical loads.
5. Connect the jumper cables in the exact sequence shown in the previous illustration. First connect one end of a jumper cable to the positive terminal of the discharged battery, then connect the other end to the positive terminal on the booster battery. Proceed to connect one end of the other jumper cable to the negative terminal of the booster battery, then the other end to a solid, stationary, metallic point (for example, the engine lifting bracket) away from the battery. Do not connect it to or near any part that moves when the engine is cranked. Do not connect the jumper cable from the negative terminal of the booster battery to the negative terminal of the discharged battery. Do not allow the jumper cables to contact anything except the correct battery terminals or the correct ground. Do not lean over the battery when making connections.

6. Start the engine of the vehicle with the booster battery and let it run at 2,000 rpm, then start the engine of the vehicle with the discharged battery.

If the cause of your battery discharging is not apparent, you should have your vehicle checked by an authorized Kia dealer.

Push-Starting

Your manual transmission-equipped Sportage should not be push-started because it might damage the emission control system. Vehicles equipped with automatic transmissions cannot be push-started. Follow the directions on page 6-4 for jump-starting.

CAUTION

Never tow a vehicle to start it because the sudden surge forward when the engine starts could cause a collision with the tow vehicle.

Electrical Circuit Protection

Fuses

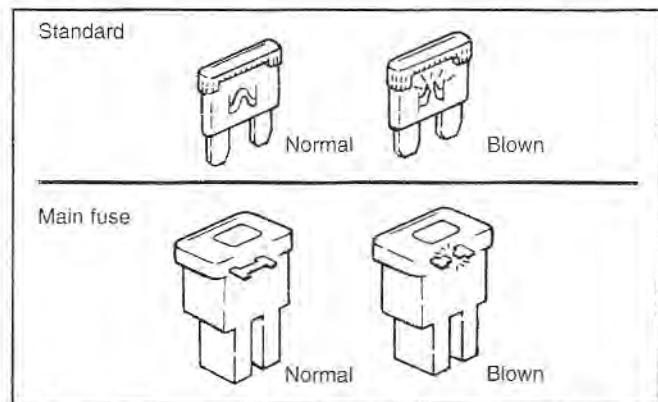

AN7B06003

A vehicle's electrical system is protected from electrical overload damage by fuses.

The Sportage has two fuse panels, one located in the driver's side kick panel, the other in the engine compartment near the battery.

If any of your vehicle's lights, accessories, or controls do not work, check the appropriate circuit fuse. If a fuse has blown, the element inside the fuse will be melted.

Always replace a blown fuse with one of the same rating.

If the same fuse blows again, avoid using the system involved and immediately consult an authorized Kia dealer.

Two kinds of fuses are used: standard for lower amperage rating and main for higher amperage ratings.

In Case Of An Emergency

Fuse Replacement

⚠ WARNING - Fuse Replacement

- Never replace a fuse with anything but another fuse of the same rating.
- A higher capacity fuse could cause damage and possibly a fire.
- Never install a wire instead of the proper fuse – even as a temporary repair. It may cause extensive wiring damage and possibly a fire.
- Do not use a screwdriver or any other metal object to remove fuses because it may cause a short circuit and damage the system.

If the electrical system does not work, first check the driver's side fuse panel.

1. Turn the ignition switch and all other switches off.
2. Pull the suspected fuse straight out.
3. Check the removed fuse; replace it if it is blown.
Four (4) spare fuses are provided in the fuse panel.
4. Push in a new fuse of the same rating, and make sure it fits tightly in the clips.

If it fits loosely, consult an authorized Kia dealer.

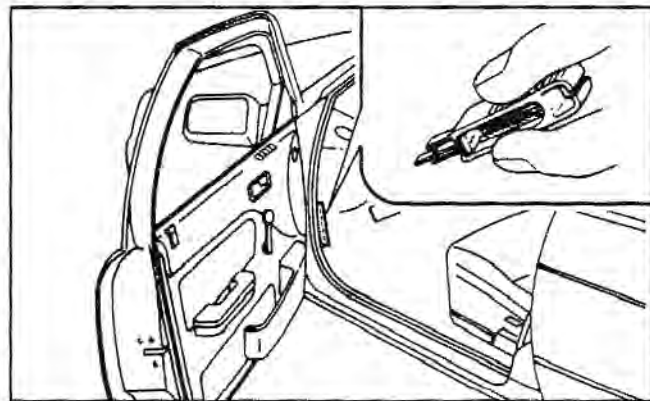

133-07002

If you do not have a spare, use a fuse of the same rating from a circuit you may not need for operating the vehicle, such as the radio or clock (Room) fuse.

If the headlights or other electrical components do not work and the fuses are OK, check the fuse block in the engine compartment. If a fuse is blown, it must be replaced.

1. Turn the ignition switch and all other switches off.
2. Remove the fuse block cover by unhooking the tab on one end and tilting the cover back toward the other end.
3. Check the fuses. If one is blown, replace it with a new one of the same rating.

CAUTION

After checking the fuse box in the engine compartment, please securely install the fuse box cover. If not, some electrical failures may occur causing from the water.

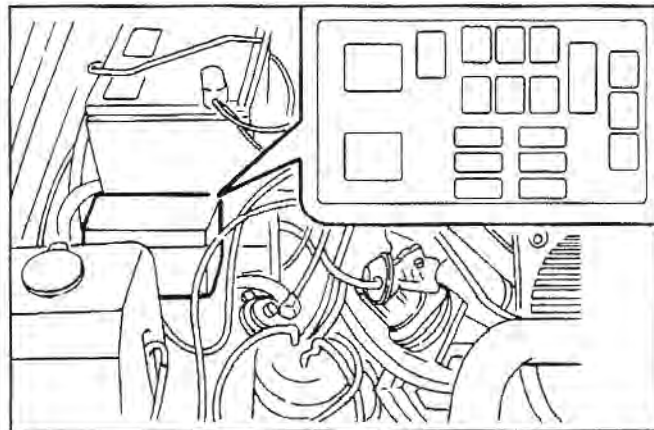

07011A

In Case Of An Emergency

If the 80A "MAIN" fuse is blown, it must be removed as follows:

1. Disconnect the negative battery cable.
2. Remove the nuts "A" in the photo below.
3. Lift the fuse block and remove the bolts "B" in the photo below.
4. Replace the fuse with a new one of the same 80A rating.
5. Reinstall in the reverse order of removal.

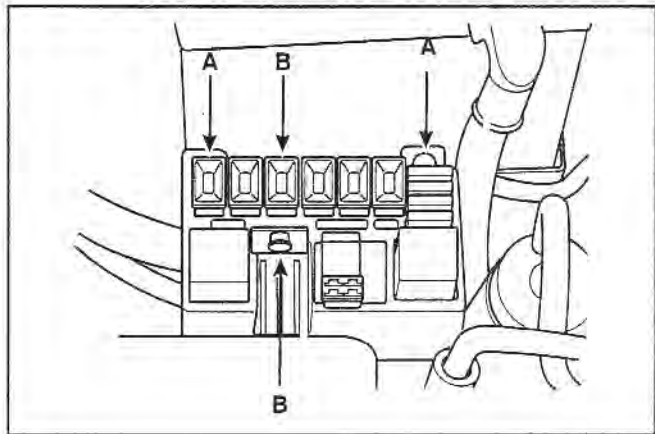

BN7B06006

Fuse Panel Description

Description	Fuse Rating	Protected components
Engine compartment		
HEAD	30A	Headlights
BTN 1	40A	Stop lights, License plate lights, Dome lights, Hazard lamp
IGN 2	40A	Ignition
MEMORY	15A	Room lights, Audio, Meter set
INJ	60A	Injector
BTN 2	40A	Stop lights, License plate lights, Dome lights, Hazard lamp
IGN 1	30A	Ignition
A/CON	40A	Air conditioner system
ABS 1	30A	Anti-lock brake system
P/WIN	30A	Power window
ABS 2	(30A)	Anti-lock brake system
ECU	10A	Engine control unit
MAIN RLY	15A	Fuel Pump, Injectors, Main relay, Fuel pump relay
O2 UP	(10A)	Oxygen sensor
O2 DN	(10A)	Oxygen sensor
F/PUMP	10A	Fuel Pump, Diagnosis connector
MAIN	80A	For protection of all cir

Driver's Side Kick Panel

Description	Fuse Rating	Protected components
Driver's side kick panel		
C/FAN	20A	Cooling fan
HEATER	30A	Heater
TAIL	10A	Tail lights
OBD-II	10A	Engine emission control
D/LOCK	20A	Auto door lock
P/OUTLET	(20A)	Electric power outlet
DEF 2	10A	Defroster
ROOM	10A	Interior lights, Cargo area lights
ST.SIGN	10A	Side turn signal
RR.WIPER	10A	Rear wiper
WIPER	10A	Front wiper
HEAD LOW	20A	Headlights low beam
HEAD HI	15A	Headlights high beam
STOP	15A	Stop lights
HORN	10A	Horn

Description	Fuse Rating	Protected components
Driver's side kick panel		
HAZARD	15A	Hazard lamp
DEF 1	20A	Defroster
ENG	15A	Diagnosis connector
A/BAG	10A	Airbags
METER	10A	Instrument panel
TURN	10A	Turn signal light
RADIO	10A	Radio system
CIGAR	15A	Cigarette lighter

In Case Of An Emergency

Driver's side kick panel

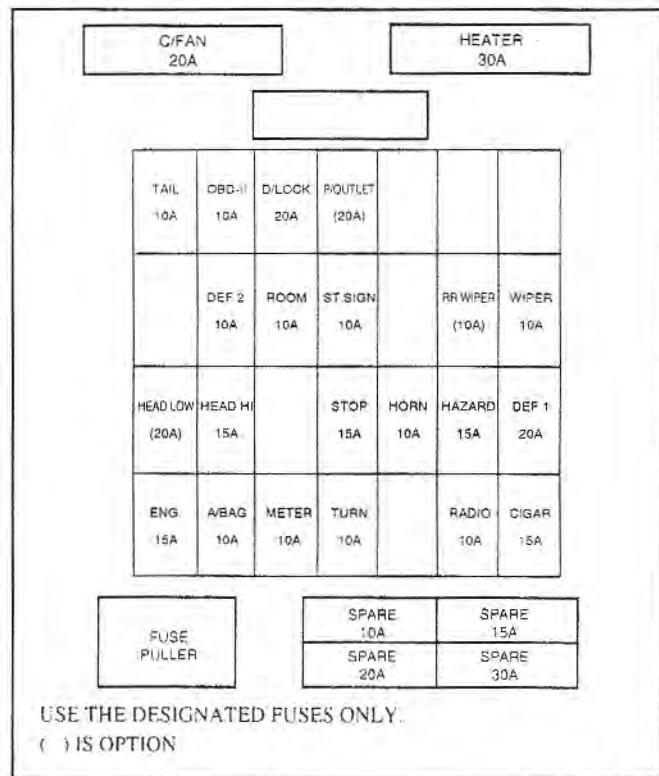

FUSE-10

Engine compartment

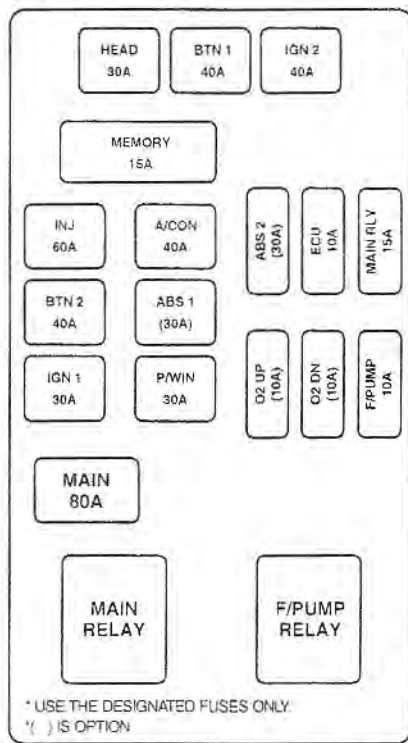

FED-LHD

Towing

If emergency towing is necessary, we recommend having it done by an authorized Kia dealer or a commercial tow-truck service. Proper lifting and towing procedures are necessary to prevent damage to the vehicle. State and local laws applicable to towing vehicles must be followed. The use of wheel dollies is recommended.

When being towed by a commercial tow truck and wheel dollies are not used, the rear of the Sportage should always be lifted, not the front.

For recreational towing guidelines information, refer to section 4 "Driving Your Vehicle".

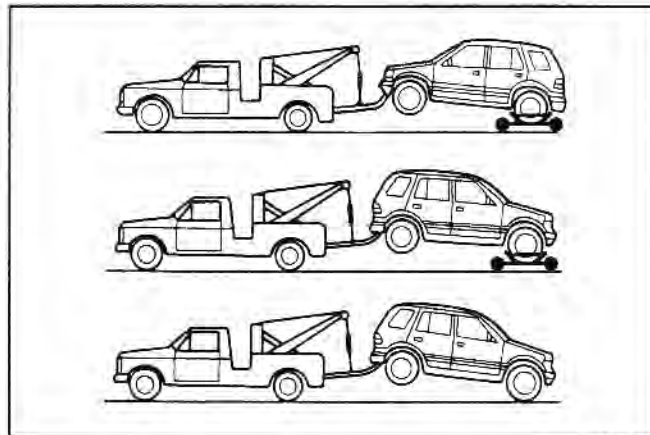

AN7B06009

In Case Of An Emergency

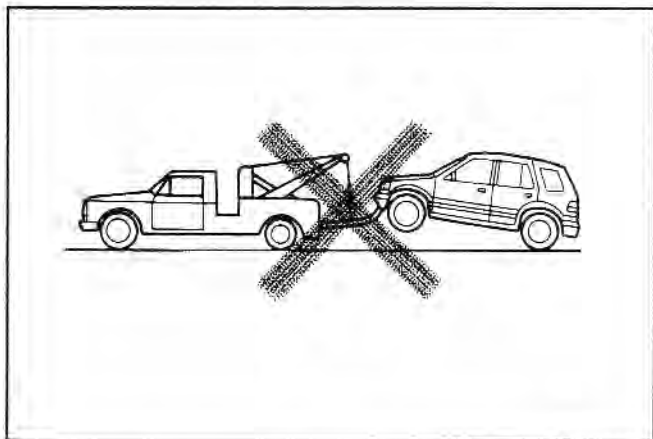

AN7B06010

When towing your Sportage in an emergency without wheel dollies:

1. Set the ignition switch in the ACC position;
2. Place the transmission shift lever in Neutral;
3. Shift the transfer case lever (if equipped) to N (Neutral) for manual transmission or 2H for automatic transmission;
4. Release the parking brake.

* NOTICE

Failure to place the transmission shift lever in neutral and the transfer case lever (if equipped) in N for manual transmissions or 2H for automatic transmissions may cause internal damage to the transmission or transfer case.

Towing With a Vehicle Other Than a Tow Truck

In case of an emergency, there are tow hooks on the front and rear of the vehicle.

* NOTICE

- Attach a towing strap to the tow hook.
- Using a portion of the vehicle other than the tow hooks for towing may damage the body of your vehicle.

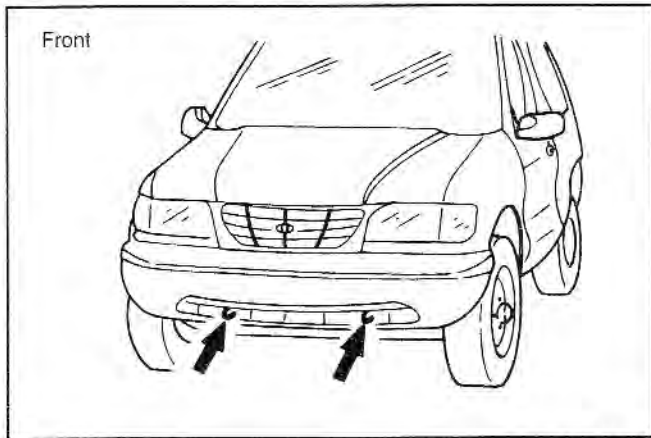

AN7B06011

- Do not try to tow your vehicle when the wheels are stuck in mud.
- Avoid towing a vehicle heavier than the vehicle doing the towing.
- The drivers of both vehicles should communicate with each other frequently.

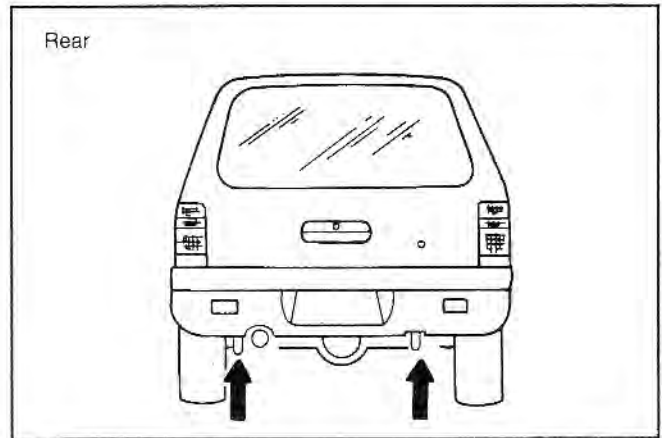

AN7B06012

In Case Of An Emergency

- Use a towing strap less than 5 m (16 feet) long. Attach a white or red cloth (about 30 cm (12 inches) wide) in the middle of the strap for easy visibility.
- Drive carefully so that the towing strap is not loosened during towing.

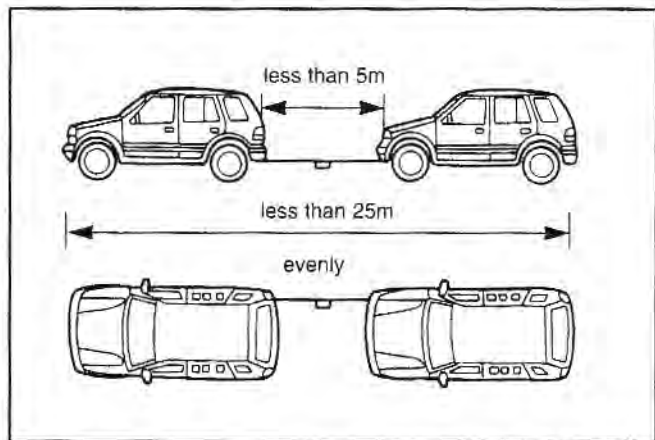

AN7B06013

When Your Sportage Is Being Towed By Another Vehicle Other Than a Tow Truck (in case of an emergency)

- Turn the ignition switch to ACC so the steering wheel isn't locked.
- Place the transmission shift lever in neutral.
- Place the transfer case lever (if equipped) in the 2H position.
- Vehicles equipped with automatic transmissions should not exceed 45 km/h (28 mph) and should not be towed more than 80 km (50 miles).

*** NOTICE**

Remove the rear drive shaft if it is necessary to exceed 45 km/h (28 mph) and/or 80 km (50 miles). If the drive shaft cannot be removed, stop every 80 km (50 miles) and start the engine. Allow the engine to idle for a few minutes. This will ensure that the transmission is sufficiently lubricated.

- Vehicles equipped with manual transmissions should not be towed in excess of 89 km/h (55 mph) and should not be towed more than 650 km (400 miles).

*** NOTICE**

Remove the rear drive shaft if it is necessary to exceed 650 km (400 miles). If the drive shaft cannot be removed, stop every 650 km (400 miles) and start the engine. Allow the engine to idle for a few minutes. This will ensure that the transmission is sufficiently lubricated.

- Press the brake pedal with more force than normal since you will have reduced brake performance.
- More steering effort will be required because the power steering system will be disabled.
- If you are driving down a long hill, the brakes may overheat and brake performance will be reduced. Stop often and let the brakes cool off.

*** NOTICE**

To prevent internal damage to the transmission, never tow your Sportage from the rear (backwards) with all four tires in contact with the road surface.

In Case Of An Emergency

If You Have a Flat Tire

Storing the Spare Tire, Jack and Tools

The full-size spare tire, if equipped, is either stored in the cargo area or mounted on the external spare tire carrier.

The jack, jack handle, and wheel lug nut wrench are stored in the "TOOL BOX" in the rear area of the vehicle.

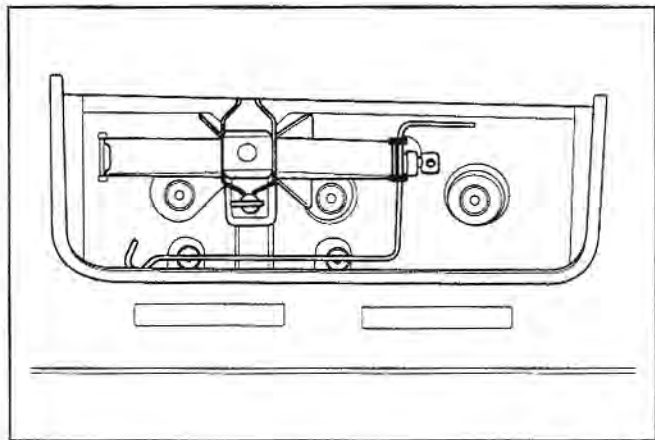

BN7B06014

Removing the Spare Tire and Jack

Inside-mounted spare tire (if equipped):

1. Move the rear carpet out of the way and lift the tool box access cover.

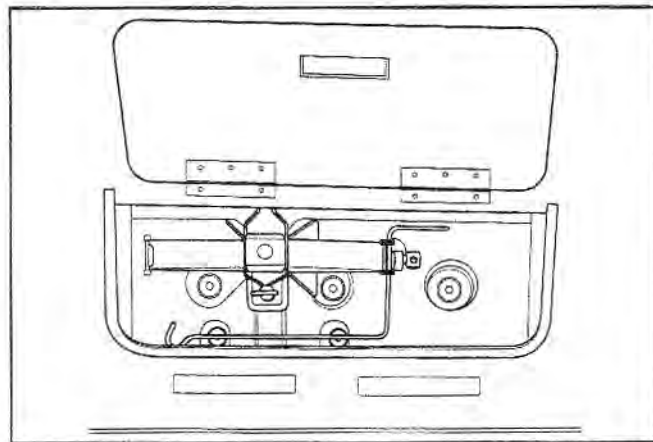

BN7B06014A

2. Use the wheel lug nut wrench to remove the bolt from the spare tire. Remove the tire.

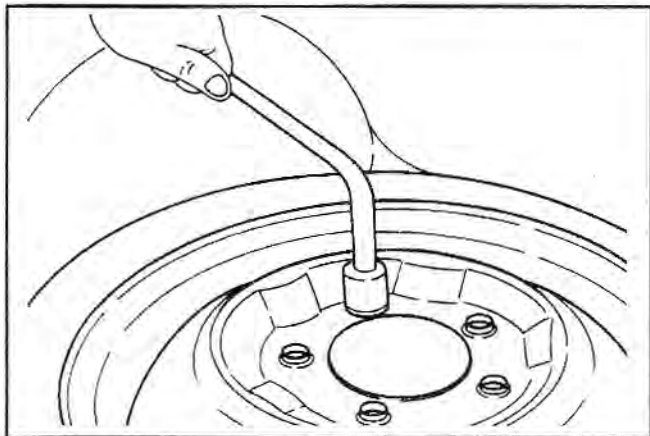

1N7B06009A

3. Open the tool compartment door, loosen the jack wing nut and remove the jack handle.

Outside-mounted spare tire (if equipped):

1. Remove the spare tire cover.
2. Using the ignition key, remove the wheel lock by inserting the key into the lock and pulling the lock off of the wheel lug nut.

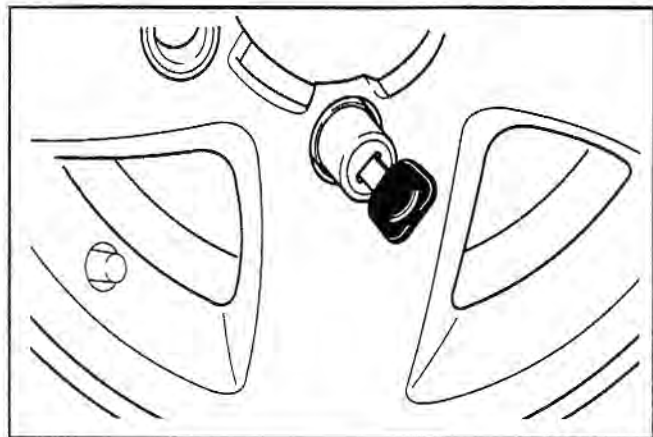

AN7B06017

In Case Of An Emergency

3. Remove the wheel lug nut wrench from the tool compartment and remove the spare tire.

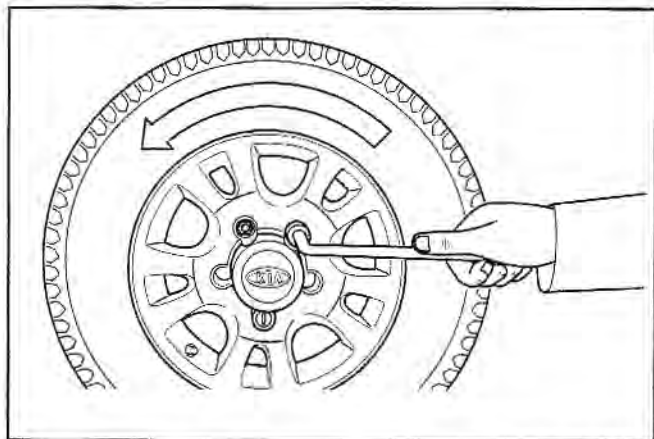

BN7B06024

4. Loosen the jack wing nut and remove the jack and handle.

Store the jack and tire in the reverse order of removal.

To prevent the jack, jack handle, and wheel lug nut wrench from “rattling” while the vehicle is in motion, store them properly. A tool bag is provided for the wheel lug nut wrench.

* NOTICE

Check the inflation pressures as soon as possible after installing the spare tire. Adjust it to the specified pressure, as necessary.

Changing Tires

Jacking Instructions

The jack is provided for emergency tire changing only.

Follow jacking instructions to reduce the possibility of personal injury.

WARNING - Changing Tires

- **Never attempt vehicle repairs in the traffic lanes of a public road or highway.**

(Continued)

(Continued)

- Always move the vehicle completely off the road and onto the shoulder before trying to change a tire. If you cannot find a firm, level place off the road, call a towing service company for assistance.
- Do not exceed the jack's maximum permissible load: 1,000 kg (2,200 lbs.).
- Be sure to use the correct front and rear jacking positions on the vehicle; never use the bumpers or any other part of the vehicle for jack support.
- The vehicle can easily roll off the jack causing serious injury or death. Never allow any portion of your body to get beneath the vehicle while using the jack.
- Do not start or run the engine while the vehicle is on the jack.

In Case Of An Emergency

Tire Replacement

1. Park on a level surface and set the parking brake firmly.
2. Shift into Reverse (manual transmission) or Park (automatic transmission).
3. Activate the hazard warning flasher.

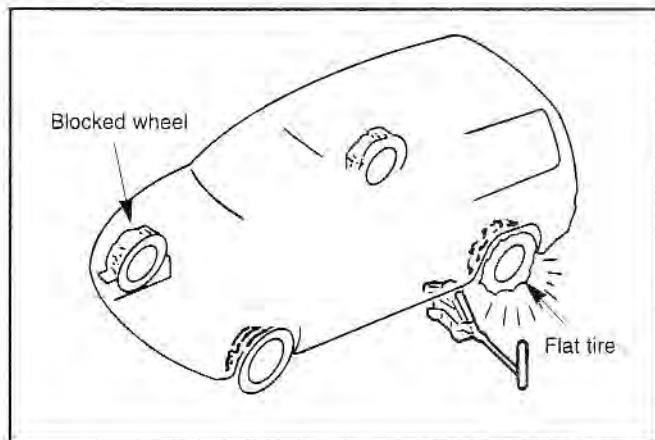

AN7B06019

4. Remove the wheel lug nut wrench, jack, jack handle, and spare tire from the vehicle.
5. Block both the front and rear of the wheel that is diagonally opposite the jack position.

▲ WARNING - Changing a Tire

To prevent vehicle movements while changing a tire, always set the parking brake fully, and always block the wheel diagonally opposite the wheel being changed.

6. Loosen the wheel nuts counterclockwise one turn each, but do not remove any nut until the tire has been raised off the ground.

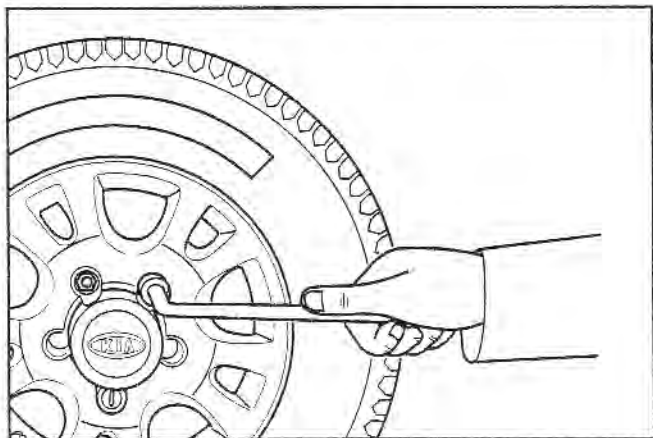

BN7B06024

7. Place the jack at the front or rear jacking position closest to the tire you are changing. Place the jack at the designated locations under the frame. The jacking positions are plates welded to the frame with two tabs and a raised dot to index with the jack.

⚠ WARNING - Jack Location

To reduce the possibility of injury, be sure to use only the jack provided with the vehicle and in the correct jack position; never use any other part of the vehicle for jack support.

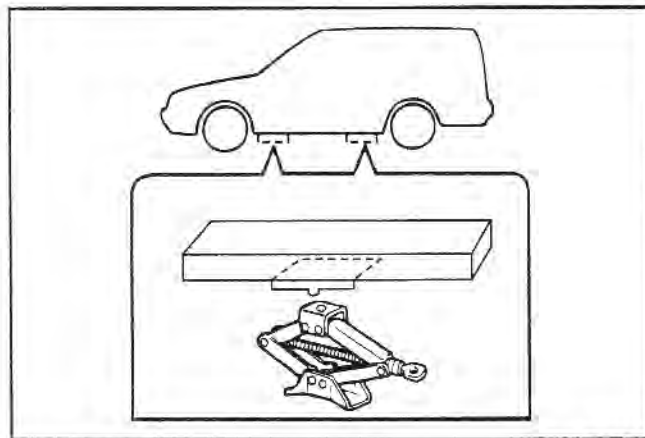

133-07009A

In Case Of An Emergency

8. Insert the jack handle into the jack and turn it clockwise, raising the vehicle until the tire just clears the ground. This measurement is approximately 30mm (1.2 in). Before removing the wheel lug nuts, make sure the vehicle is stable and that there is no chance for it to slip or move.
9. Remove the wheel lug nuts by turning them counterclockwise, then remove the wheel.
10. Mount the spare tire into position and tighten the wheel nuts by hand. Install the wheel lug nuts with the beveled edge inward.

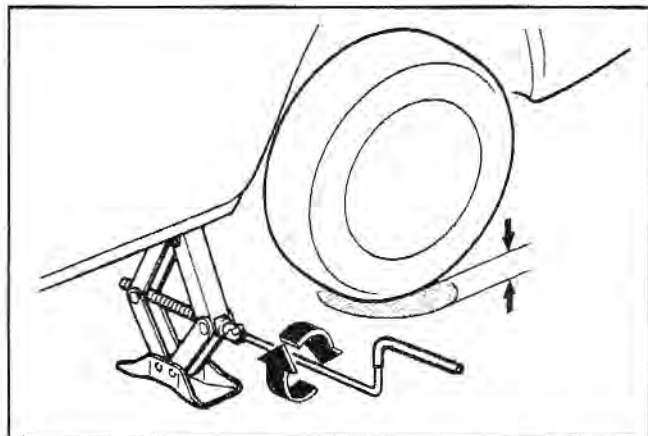

1S2108008

11. Turn the jack handle counterclockwise and lower the vehicle until it touches the ground. Tighten the wheel lug nuts firmly in a “star” pattern.

Once the lug nuts have been tightened, lower the vehicle fully to the ground and continue to tighten the lug nuts until they are fully secured.

If you are unsure of the tightness of the wheel lug nuts, have them checked at the nearest service station. The specified tightening torque is 88-118 N·m (65-87 ft. lb.).

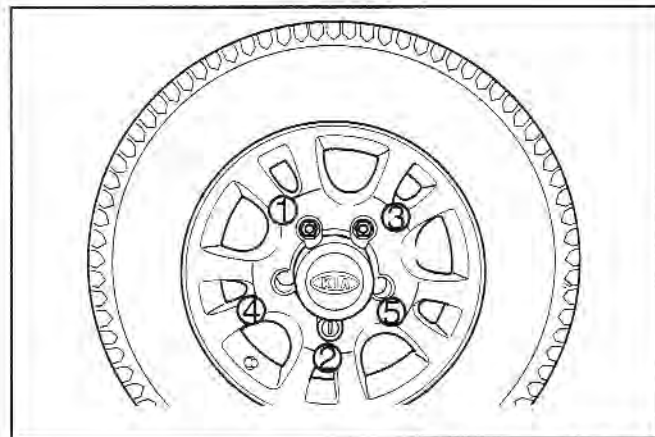

BN7B06025

In Case Of An Emergency

CAUTION

Your vehicle has metric threads on the wheel studs and nuts. Make certain during wheel removal that the same nuts removed are reinstalled – or, if replaced, that nuts with metric threads and the same chamfer configuration are used. Installation of a non-metric thread nut on a metric stud or vice-versa will not secure the wheel to the hub properly and will damage the stud so that it must be replaced. Note that most U.S. lug nuts do not have metric threads. Be sure to use extreme care in checking for thread style before installing aftermarket lug nuts or wheels. If in doubt, consult an Authorized Kia Dealer.

WARNING - Wheel Studs

If the studs are damaged, they may lose their ability to retain the wheel. This could lead to the loss of the wheel and a collision.

To prevent the jack, jack handle, wheel lug nut, wrench and spare tire from rattling while the vehicle is in motion, store them properly.

Maintenance

Air Cleaner	7-26
Automatic Transmission	7-21
Battery	7-31
Brakes and Clutch	7-17
Bulb Replacement	7-42
Engine Compartment	7-10
Engine Cooling System	7-13
Engine Oil and Oil Filter	7-11
Exterior Care	7-56
Interior Care	7-59
Lubricant Specifications	7-53
Lubricants and Fluids	7-24
Maintenance Schedule	7-4
Maintenance Services	7-3
Manual Transmission	7-19

Maintenance

Owner Maintenance	7-8
Parking Brake	7-18
Power Steering	7-18
Tires and Wheels	7-34
Wiper Blades	7-28

Maintenance Services

You should exercise the utmost care to prevent damage to your vehicle and injury to yourself whenever performing any maintenance or inspection procedures.

Should you have any doubts concerning the inspection or servicing of your vehicle, we strongly recommend that you have a reliable and qualified service shop perform this work, preferably an authorized Kia dealer.

An authorized Kia dealer has factory-trained technicians and genuine Kia parts to service your vehicle properly. For expert advice and quality service, see an authorized Kia dealer.

Inadequate, incomplete or insufficient servicing may result in operational problems with your vehicle that could lead to vehicle damage, an accident, or personal injury.

Owner's Responsibility

* NOTICE

Maintenance Service and Record Retention are the owner's responsibility.

You should retain documents that show proper maintenance has been performed on your vehicle in accordance with the scheduled maintenance service charts shown on the following pages. You need this information to establish your compliance with the servicing and maintenance requirements of your Kia warranties.

Detailed warranty information is provided in your *Warranty and Consumer Information Manual*.

Repairs and adjustments required as a result of improper maintenance or a lack of required maintenance are not covered.

We recommend that maintenance be performed by an authorized Kia dealer using genuine Kia parts.

Maintenance

Maintenance Schedule

Engine Control System

MAINTENANCE INTERVAL \ MAINTENANCE ITEM	Kilometers or Time in Months, Whichever Comes First																
	x 1,000 km	12	24	36	48	60	72	84	96	108	120	132	144	156	168	180	192
# Months	6	12	18	24	30	36	42	48	54	60	66	72	78	84	90	96	
Engine oil & engine oil filter (1), (3)	Change every 6,000 km or 3 months, whichever comes first.																
Drive belts (tension)			I			I			I			I			I		
Cooling system hoses & connections		I		I		I		I		I		I		I		I	
Engine coolant (1)	I	I	I	R	I	I	I	R	I	I	I	R	I	I	I	R	
Fuel filter			R			R			R			R			R		
Fuel tank cap, lines and hoses				I				I				I					I
Air cleaner element (2)	I	I	I	R	I	I	I	R	I	I	I	R	I	I	I	R	
Ignition wires				I				I				I					I
Spark plugs				R				R				R					R
Idle speed		I		I		I		I		I		I		I		I	
Evaporative emission canister & vapour lines						I					I					I	
PCV valve							I						I				
Engine timing belt	Replace every 102,000km.																

Maintenance Schedule (continued)

Chassis and Body

MAINTENANCE INTERVAL	Kilometers or Time in Months, Whichever Comes First																
	x 1,000 km	12	24	36	48	60	72	84	96	108	120	132	144	156	168	180	192
MAINTENANCE ITEM	# Months	6	12	18	24	30	36	42	48	54	60	66	72	78	84	90	96
Air conditioner compressor operation & refrigerant amount (if equipped)			I		I		I		I		I		I		I		I
Exhaust pipes, heat shield & mountings		I		I		I		I		I		I		I		I	
Transfer case oil (if equipped)		I	I	R	I	I	R	I	I	R	I	I	R	I	I	R	I
Rear differential fluid (if equipped)		I	I	R	I	I	R	I	I	R	I	I	R	I	I	R	I
Front differential fluid (if equipped)		I	I	R	I	I	R	I	I	R	I	I	R	I	I	R	I
Front suspension ball joints				I			I			I			I			I	
Brakes/clutch fluid	(1)	I	I	I	I	R	I	I	I	I	R	I	I	I	I	R	I
Front brake pads & discs	(3)	I	I	I	I	I	I	I	I	I	I	I	I	I	I	I	I
Rear brake pads & discs/drums	(3)	I	I	I	I	I	I	I	I	I	I	I	I	I	I	I	I
Parking brake			I		I		I		I		I		I		I		I
Brake lines & connections (including booster)			I		I		I		I		I		I		I		I
Manual transaxle oil	(1), (3)	I	I	I	I	I	I	I	R	I	I	I	I	I	I	I	R
Clutch & brake pedal free play	(3)	I	I	I	I	I	I	I	I	I	I	I	I	I	I	I	I

Maintenance

Maintenance Schedule (continued)

MAINTENANCE INTERVAL	Kilometers or Time in Months, Whichever Comes First																
	x 1,000 km	12	24	36	48	60	72	84	96	108	120	132	144	156	168	180	192
MAINTENANCE ITEM	# Months	6	12	18	24	30	36	42	48	54	60	66	72	78	84	90	96
Automatic transaxle fluid	(1), (3)	I	I	R	I	I	R	I	I	R	I	I	R	I	I	R	I
Chassis & underbody bolts & nuts		I	I	I	I	I	I	I	I	I	I	I	I	I	I	I	I
Tire condition & inflation pressure		I	I	I	I	I	I	I	I	I	I	I	I	I	I	I	I
Wheel alignment	(4)	Inspect when abnormal condition noted.															
Tire rotation		Rotate the tires every 12,000 km.															
Steering operation & linkage		I	I	I	I	I	I	I	I	I	I	I	I	I	I	I	I
Power steering fluid & lines			I		I		I		I		I		I		I		I
Driveshaft u-joints		L	L	L	L	L	L	L	L	L	L	L	L	L	L	L	L
Driveshaft dust boots				I			I			I			I			I	
Seat belts, buckles & anchors		I	I	I	I	I	I	I	I	I	I	I	I	I	I	I	I
Locks, hinges & hood latch		L	L	L	L	L	L	L	L	L	L	L	L	L	L	L	L

Chart Symbols:

I- Inspect these items and their related parts. If necessary, correct, clean, refill, adjust or replace.

R- Replace or change

L-Lubricate.

(1) Refer to the lubricant and coolant specifications in the Owner's Manual

(2) More frequent maintenance is required if driving under dusty conditions.

(3) More frequent maintenance is required if the vehicle is operated under any of the following conditions:

a. Short-distance driving

b. Driving on dusty roads.

c. Extensive idling or slow-speed driving in stop-and-go traffic.

(4) If necessary, rotate and balance the wheels.

* Note: Check the engine oil and coolant levels every week.

Maintenance

Owner Maintenance

Owner Maintenance Schedule

The owner or a qualified service technician should perform these vehicle inspections at the indicated intervals to ensure safe and dependable operation.

Bring any problem to the attention of an authorized Kia dealer as soon as possible.

When refueling, check the following:

- Engine oil level
- Engine coolant level

CAUTION

Be careful when checking your engine coolant level. The engine compartment will be hot and you could be burned.

- Brake (and clutch, if equipped) fluid level
- Washer fluid level

At least monthly, check:

- Tire inflation pressures (cold)
- Coolant level in reservoir (cold engine)

At least every 6 months (for example, every spring and fall), check:

- Power steering fluid level
- Automatic transmission fluid level

You can do the following scheduled maintenance items if you have some mechanical ability, a few basic tools and if you closely follow the directions in this manual.

When servicing your vehicle use only genuine Kia replacement parts. Genuine Kia parts can be obtained from your authorized Kia dealer.

When removing parts with gaskets or seals, replace the gasket or seal with a new part before reassembly. Be sure to completely remove the old gasket and any remaining sealant, without marring the mating surfaces, before installing the new part.

Owner Maintenance Precautions

Improper or incomplete service may result in problems. This section gives instructions only for items easy to perform.

▲ WARNING - Maintenance Work

Performing maintenance work on a vehicle can be dangerous. You can be seriously injured while performing some maintenance procedures. If you lack sufficient knowledge and experience or the proper tools and equipment to do the work, have it done by a qualified technician.

As explained earlier in this section, several procedures can be done only by a qualified service technician with special tools.

Improper owner maintenance during the warranty period may affect warranty coverage. For details, read the separate Warranty and Consumer Information Manual provided with the vehicle. If you're unsure about any servicing or maintenance procedure, have it done by an authorized Kia dealer.

▲ WARNING - Loose Clothing or Jewelry

Working under the hood with the engine running is dangerous. It becomes even more dangerous when you wear jewelry or loose clothing. Either can become entangled in moving parts and result in injury. Therefore, if you must run the engine while working under the hood, make certain that you remove all jewelry (especially rings, bracelets, watches, and necklaces) and all neckties, scarves, and similar loose clothing before getting near the engine or cooling fans.

Maintenance

Engine Compartment

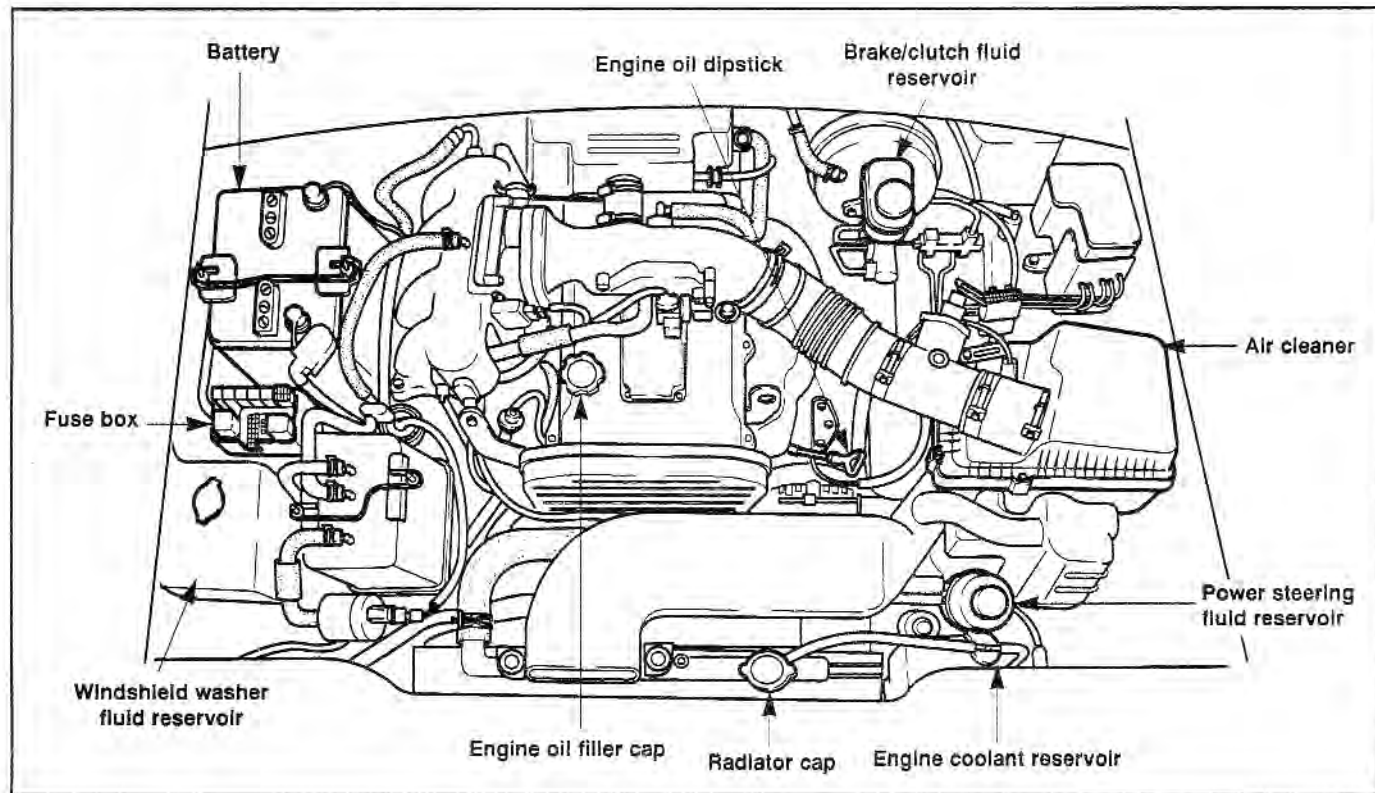

AN7B07001

Engine Oil and Oil Filter

Checking the Engine Oil Level

1. Be sure the vehicle is on level ground.
2. Start the engine and allow it to reach normal operating temperature.
3. Turn the engine off and wait a few minutes for the oil to return to the oil pan.
4. Pull the dipstick out, wipe it clean, and re-insert it fully.
5. Pull the dipstick out again and check the level. The level should be between F and L.

If it is near or at L, add enough oil to bring the level to F. **Do not overfill.**

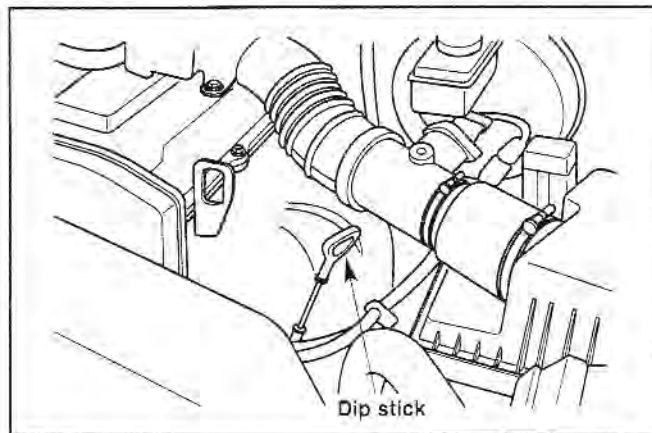

BN7B07002

Use only the specified engine oil. (Refer to "Recommended Lubricants" later in this section.)

Maintenance

Changing the Engine Oil and Filter

Change engine oil and filter according to the Maintenance Schedule at the beginning of this section.

WARNING - Engine Oil

Continuous contact with USED engine oil has caused skin cancer in laboratory mice. Protect your skin by washing with soap and water.

Keep all engine oil out of the reach of children.

1. Warm the engine up for a few minutes and then turn it off. Remove the oil filler cap.
2. Drain the oil into a suitable container after removing the oil filler cap and drain plug.

CAUTION

Both the oil and engine are hot. Do not burn yourself.

3. Remove the engine oil filter with an oil filter wrench.

*** NOTICE**

Do not allow the oil filter gasket to remain on the oil filter mounting surface. This will cause oil leakage and engine damage. Remove the old gasket completely so that a new gasket may be properly seated.

4. Use a clean rag to clean the oil filter mounting surface on the engine.
5. Apply a small amount of engine oil to the new oil filter O-ring seal.
6. Install the oil filter and tighten it. (Refer to the oil filter caution label for tightening instructions.)
7. Install a new washer on the drain plug.
8. Replace the drain plug after the oil has thoroughly drained. Torque the plug to 30 N·m (22 lb.-ft.).

9. Refill the engine with new oil to the F mark on the dipstick. Do not overfill.
10. Replace the oil filler cap securely.
11. Start the engine and inspect around the oil filter seal for leaks. Stop the engine.
12. Check the oil level and fill to the F mark as necessary.

Oil Capacity

4.2 liters (4.4 US qt.)

Use only API Service Grade SG or higher.

*** NOTICE**

- Although oil filters may have the same external appearance, their internal designs differ significantly. These filters are not interchangeable. To avoid potential engine damage, use only the specified filter. Consult an authorized Kia dealer.

(Continued)

(Continued)

- Follow these instructions carefully. An improper oil filter installation can cause oil leakage and engine damage.

Engine Cooling System

The high-pressure cooling system has a reservoir filled with year-round antifreeze coolant. The reservoir is filled at the factory.

Check the antifreeze protection and coolant level at least once a year, at the beginning of the winter season, and before traveling to a colder climate.

Maintenance

Checking the Coolant Level

⚠ WARNING - Removing Radiator Cap

- Never attempt to remove the radiator cap while the engine is operating. Doing so might lead to cooling system and engine damage and could result in serious personal injury from escaping hot coolant or steam. Turn the engine off and wait until it has cooled. Even then, use extreme care when removing the radiator cap. Wrap a thick towel around it, and turn it counterclockwise slowly to the first stop. Step back while the pressure is released from the cooling system. When you are sure all the pressure has been released, press down on the cap, using a thick towel, and continue turning counterclockwise to remove it.

(Continued)

(Continued)

- Even if the engine is not operating, do not remove the radiator cap or the drain plug while the engine and radiator are hot. Hot coolant and steam may still blow out under pressure, causing serious injury.

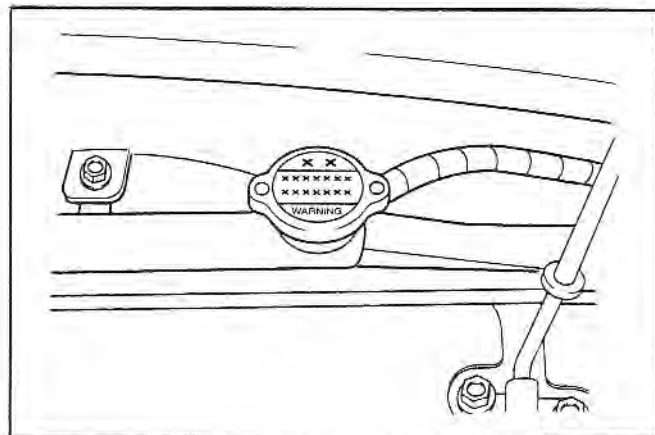

BN7B07003

Check the condition and connections of all cooling system hoses and heater hoses. Replace any swollen or deteriorated hoses.

The coolant level should be full in the radiator and between F (Full) and L (Low) on the coolant reservoir dipstick when the engine is cool.

Check the coolant level using the dipstick attached to the reservoir cap.

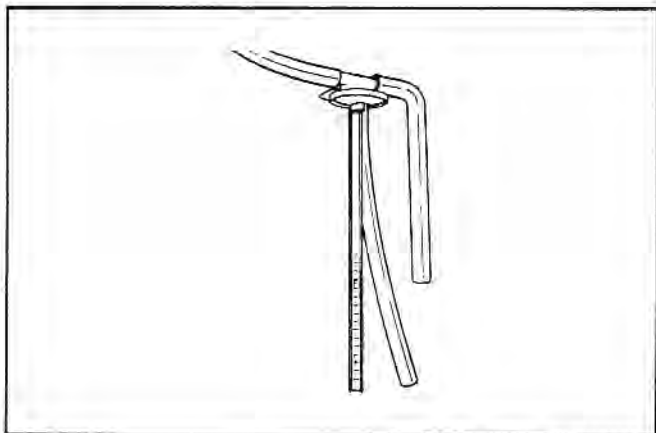

AN7B07004

If the coolant level is low, add enough specified coolant to provide protection against freezing and corrosion. Bring the level to F, but do not overfill. If frequent additions are required, see an authorized Kia dealer for a cooling system inspection.

Changing Coolant

Change coolant according to the Scheduled Maintenance.

- *Use only soft (de-mineralized) water in the coolant mixture.*
- *The engine in your vehicle has aluminum engine parts and must be protected by an ethylene-glycol-based coolant to prevent corrosion and freezing.*
- *DO NOT USE alcohol or methanol antifreeze or mix them with the specified coolant.*
- *Do not use a solution that contains more than 60% antifreeze, which would reduce the effectiveness of the solution.*

Maintenance

For mixture percentage, refer to the following table.

PROTECTION	Mixture percentage (volume)	
	Coolant solution	Water
Above -16°C (3°F)	35	65
Above -26°C (-15°F)	45	55
Above -40°C (-40°F)	55	45

CAUTION

To prevent burning yourself, do not remove the radiator cap or loosen the drain plug if the engine is hot.

1. Turn the radiator cap counterclockwise to remove it.

2. Loosen the radiator drain plug and drain the coolant into a suitable container.
3. With the plug loose, flush the system with running water.
4. Drain the system completely and retighten the drain plug. Add the necessary amount of ethylene-glycol-based coolant and water to provide the required protection against freezing and corrosion. In extremely cold climates, add ethylene-glycol based coolant in accordance with the instructions of the manufacturer.
5. Run the engine at idle with the radiator cap off. Slowly add additional coolant as necessary.
6. At this point, wait until the engine reaches normal operating temperature. Depress the accelerator two or three times; then add coolant as required. **Be careful not to burn yourself.**
7. Replace the radiator cap. Inspect all connections for leaks and recheck the coolant level in the reservoir. Recheck again after a few days and add coolant as necessary.

Brakes and Clutch

Checking Brake/Clutch Fluid Level

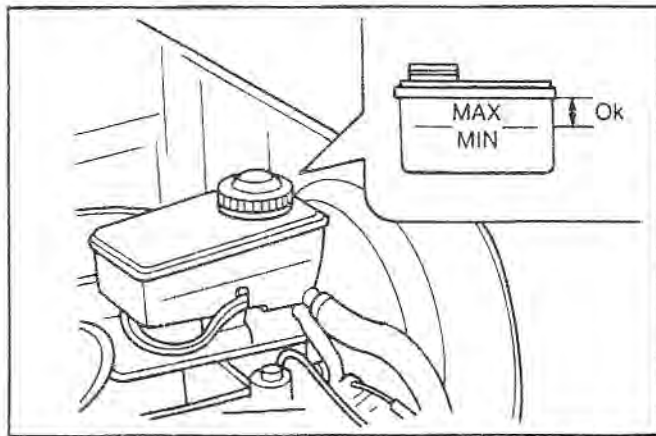

AN7B07005

The brake system and the hydraulic clutch system share the same master cylinder reservoir. Check the fluid level in the reservoir periodically. The fluid level should be between MAX and MIN on the side of the reservoir.

Before removing the reservoir cap and adding brake fluid, clean the area around the reservoir cap thoroughly to prevent brake/clutch fluid contamination.

If the level is low, add fluid to the MAX level. The level will fall with accumulated mileage. This is a normal condition associated with the wear of the brake/clutch linings. If the fluid level is excessively low, have the brake/clutch system checked by an authorized Kia dealer.

Use only the specified brake/clutch fluid. (Refer to "Recommended Lubricants" later in this section.)

Never mix different types of fluid.

*** NOTICE**

In the event the brake/clutch system requires frequent additions of fluid, the vehicle should be inspected by an authorized Kia dealer.

Maintenance

Parking Brake

Checking the Parking Brake

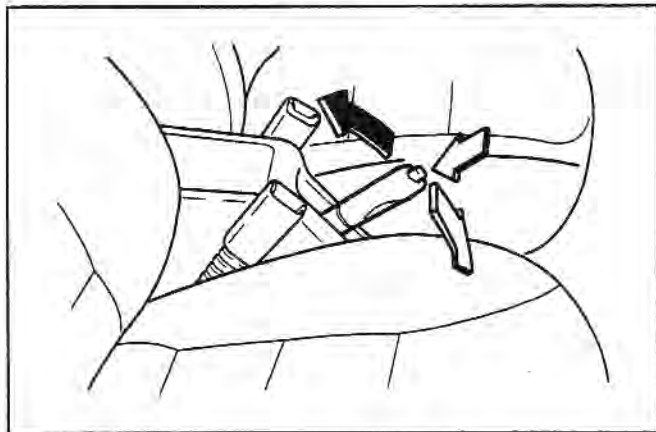

AN7B07006

Check the stroke of the parking brake by counting the number of “clicks” heard while fully applying it from the released position. Also, the parking brake alone should securely hold the vehicle on a fairly steep grade. If the number of “clicks” is more or less than specified, have the parking brake adjusted by an authorized Kia dealer.

Stroke:

6-10 “clicks” at a force of 98N (22 lbs).

Power Steering

Checking the Power Steering Fluid Level

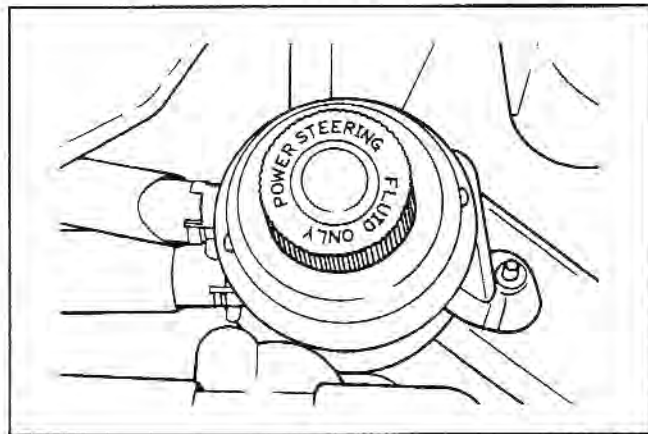

AN7B07007

With the vehicle on level ground, check the fluid level in the power steering reservoir periodically. The fluid should be between High and Low on the side of the reservoir.

If the level is low, add fluid to the High level. In the event the power steering system requires frequent addition of fluid, the vehicle should be inspected by an authorized Kia dealer.

*** NOTICE**

To avoid damage to the power steering pump, do not operate the vehicle for prolonged periods with a low power steering fluid level.

Use only the specified power steering fluid. (Refer to "Recommended Lubricants" later in this section.)

Manual Transmission

Checking the Manual Transmission Oil Level

1. Raise and suitably support the vehicle.

 WARNING - Lifting Your Vehicle

If you raise your vehicle, always ensure that it is supported at all four jacking or lift points for the vehicle. Only if this level of support is provided can you ensure that the vehicle will remain stable and not fall off the jack stands or other supports. If you do not provide such support, the vehicle may fall off the jack stands, or other supports, causing serious injury or death.

Maintenance

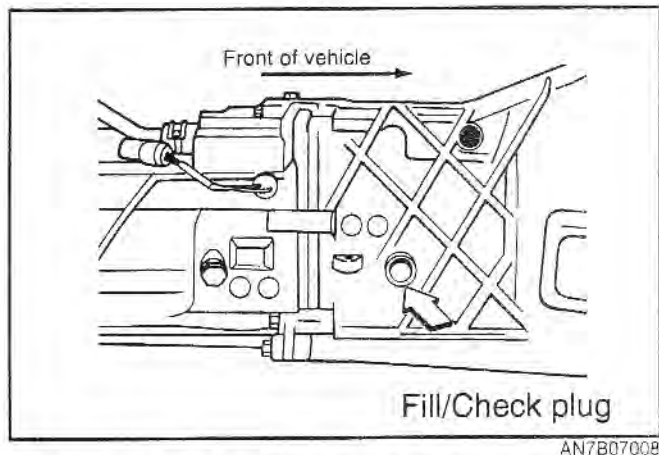

2. Remove the fill/check plug on the side of the transmission.

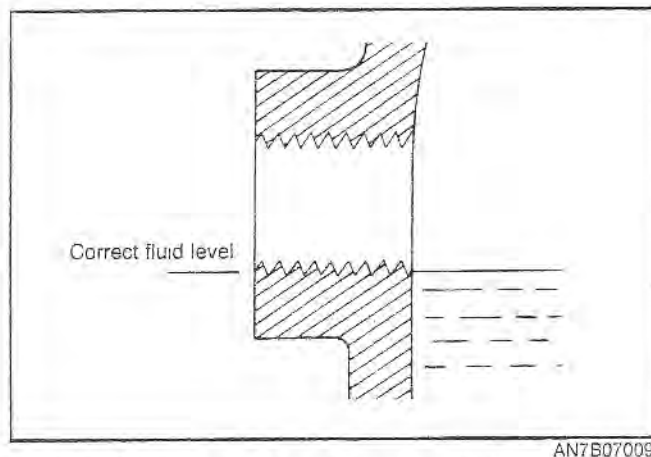

3. Verify that the oil level reaches the bottom of the fill/check hole. Fill as necessary.
If the oil level is low, check for leaks before adding oil. Do not overfill. Use only the specified manual transmission oil. (Refer to "Recommended Lubricants" later in this section.)
4. Install a new washer on the fill/check plug and tighten the plug to 30 N·m (22 lb-ft.).

Changing the Manual Transmission Oil

1. Raise and suitably support the vehicle.
2. Remove the drain plug on the bottom of the transmission.
3. After the oil has drained completely, install a new washer on the plug, reinstall the drain plug and tighten to 30 N•m (22 lb ft).
4. Remove the fill/check plug on the side of the transmission.
5. Add oil through the fill/check hole until it reaches the bottom of the fill/check hole.
6. Install a new washer on the fill/check plug.
7. Reinstall and tighten the fill/check plug to 30 N•m (22 lb ft).

Use only the specified manual transmission oil. (Refer to "Recommended Lubricants" later in this section.)

Automatic Transmission

Checking the Automatic Transmission Fluid Level

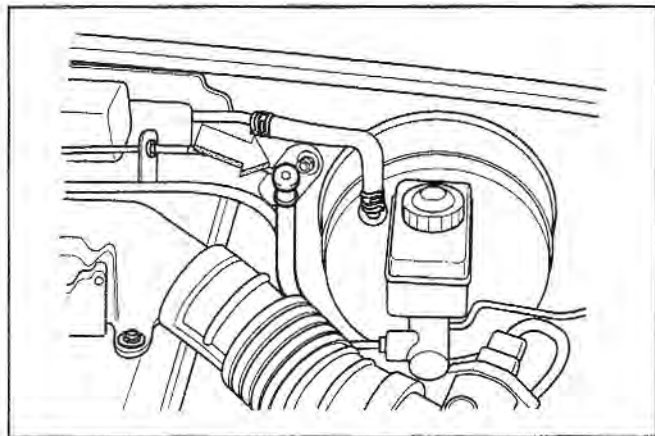

BN7B07010

The automatic transmission fluid level should be checked regularly.

The volume of the transmission fluid changes with temperature. Although it is best to check the level

Maintenance

after having driven the vehicle for at least 30 minutes, the level can be checked after warming the fluid using the procedure below.

CAUTION

- *Low fluid level causes transmission slippage. Overfilling can cause foaming, loss of fluid and transmission malfunction.*
- *The use of a non-specified fluid could result in transmission malfunction and failure.*

WARNING - Parking Brake

To avoid sudden movement of the vehicle, set the parking brake and depress the brake pedal before moving the shift lever.

1. Park the vehicle on level ground and firmly set the parking brake.

2. Allow the engine to idle for about 2 minutes.
3. Depress the brake pedal and move the shift lever slowly through all ranges then set it in P (Park).
4. With the engine still idling, pull out the dipstick, wipe it clean and reinsert it fully.

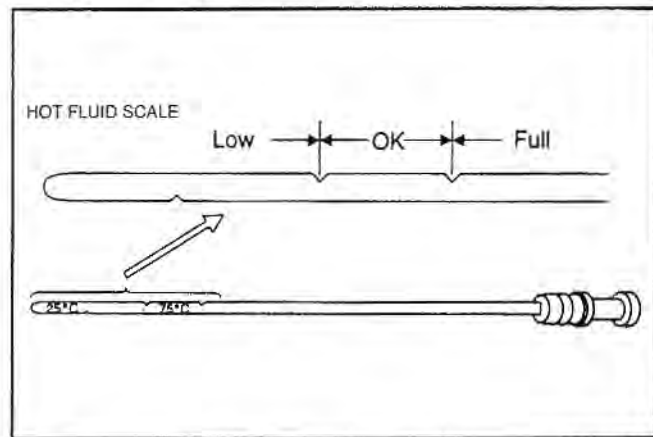

AN7B07011

5. Pull out the dipstick again and check the fluid level.

If the fluid has been warmed to normal operating temperature of approximately 75°C (167°F), the fluid level should be between the 2 notches marked 75°C (167°F).

*** NOTICE**

The notch on the 25°C scale is for reference only and should NOT be used to determine transmission fluid level.

Changing the Automatic Transmission Fluid

1. Raise and suitably support the vehicle.
2. Remove the drain plug located at the bottom center front of the transmission pan.
3. After the oil has drained, completely install a new washer on the plug, reinstall the drain plug, and tighten to 30 N·m (22 lb-ft).
4. Lower the vehicle.
5. Remove the Automatic Transmission dipstick located near the center of the engine compartment bulkhead and, using a funnel, add approximately 2 quarts (2 liters) of automatic transmission fluid (Dexron IIE).

Maintenance

* NOTICE

Do NOT overfill the automatic transmission reservoir. Doing so can cause a seal “blow out,” loss of fluid, and damage to the transmission. If you overfill the reservoir, you must drain the excess prior to driving the vehicle. The transmission will hold 2.5L (2.7 qts.) when completely empty. However, it is likely that there will be fluid left in the transmission after draining, especially if the front of the vehicle was raised to remove the drain plug.

6. Check the fluid level. If necessary, add a small amount of fluid and check the level again. Continue this process until the level reads between the 75°C (167°F) notches.
7. Replace the dipstick and properly dispose of the used transmission fluid.

Lubricants and Fluids

Checking the Front Washer Fluid Level

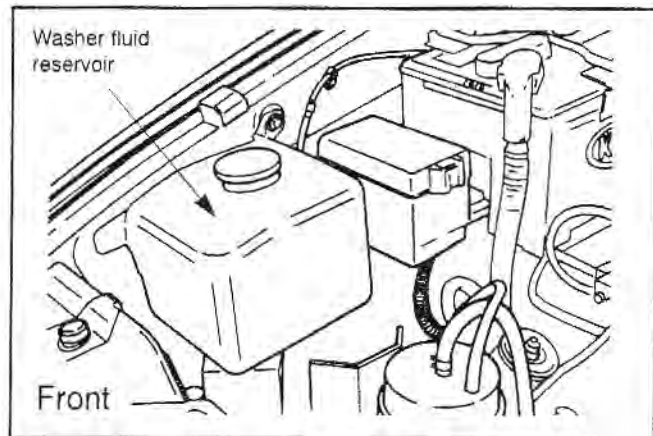

AN7B07012

The reservoir is translucent so that you can check the level with a quick visual inspection.

Check the fluid level in the washer fluid reservoir and add fluid if necessary. Plain water may be used if washer fluid is not available. However, use

washer solvent with antifreeze characteristics in cold climates to prevent freezing.

Checking the Rear Washer Fluid Level

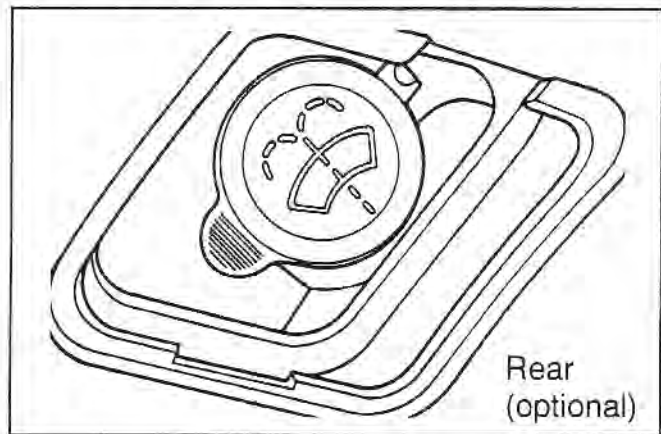

AN7B07013

The rear washer fluid reservoir does not allow for a visual level check because of its location.

The rear washer fluid reservoir filler tube is located along the right side of the cargo area, just

below the pillar at the very rear of your vehicle. Remove the small access panel to reach the filler tube.

To add washer fluid, pull out the filler tube extension located inside the filler tube.

*** NOTICE**

Do NOT continue to pull on the filler tube once it is extended.

CAUTION

- *Do not use radiator coolant or antifreeze in the washer fluid reservoir.*
- *Radiator coolant can severely obscure visibility when sprayed on the windshield and may cause loss of vehicle control or damage to paint and body trim.*

Maintenance

Body Lubrication

All moving points of the body, such as door hinges, hood hinges, and locks, should be lubricated each time the engine oil is changed. Use a non-freezing lubricant on locks during cold weather.

Make sure the engine hood secondary latch keeps the hood from opening when the primary latch is released.

Air Cleaner

Element Replacement

A viscous paper air cleaner filter is used. It must be replaced when necessary, and should not be cleaned and reused.

1. Loosen the air clamp and remove the intake air hose.
2. Remove the six (6) cover bolts on the air cleaner cover and remove the cover.
3. Wipe the inside of the air cleaner housing with a damp cloth.

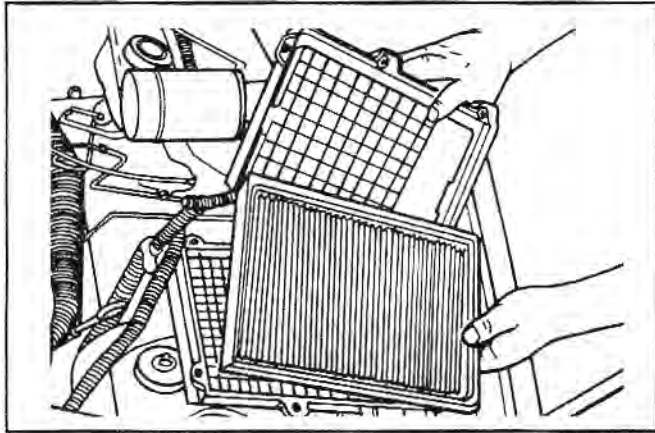

AN7B07014

4. Replace the air cleaner element.

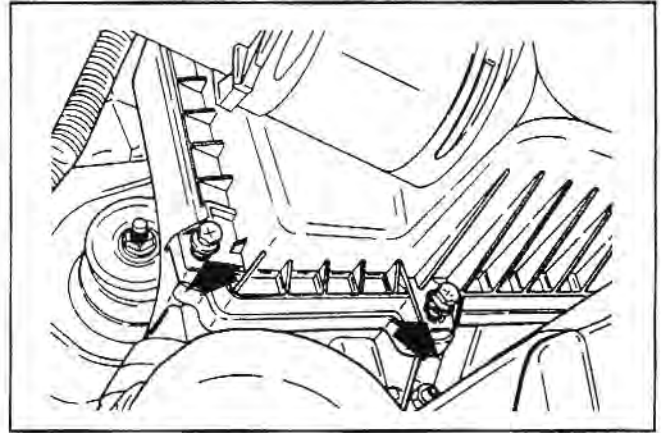

AN7B07015

5. Install the cover. Install and tighten the (6) cover bolts.

Replace the element according to the Maintenance Schedule Section.

If the vehicle is operated in extremely dusty or sandy areas, replace the element more often than the usual recommended intervals. (Refer to the Maintenance schedule in this section.)

Maintenance

CAUTION

- *Do not drive with the air cleaner removed; this will result in excessive engine wear.*
- *Driving without an air cleaner encourages backfiring, which could cause a fire in the engine compartment.*

Wiper Blades

Wiper Blade Maintenance

*** NOTICE**

Commercial hot waxes applied by automatic car washes have been known to make the windshield difficult to clean.

Contamination of either the windshield or the wiper blades with foreign matter can reduce the effectiveness of the windshield wipers. Common sources of contamination are insects, tree sap, and hot wax treatments used by some commercial car

washes. If the blades are not wiping properly, clean both the window and the blades with a good cleaner or mild detergent, and rinse thoroughly with clean water.

*** NOTICE**

To prevent damage to the wiper blades, do not use gasoline, kerosene, paint thinner, or other solvents on or near them.

Windshield Wiper Blade Replacement

When the wipers no longer clean adequately, the blades may be worn or cracked, and require replacement.

*** NOTICE**

To prevent damage to the wiper arms or other components, do not attempt to move the wipers manually.

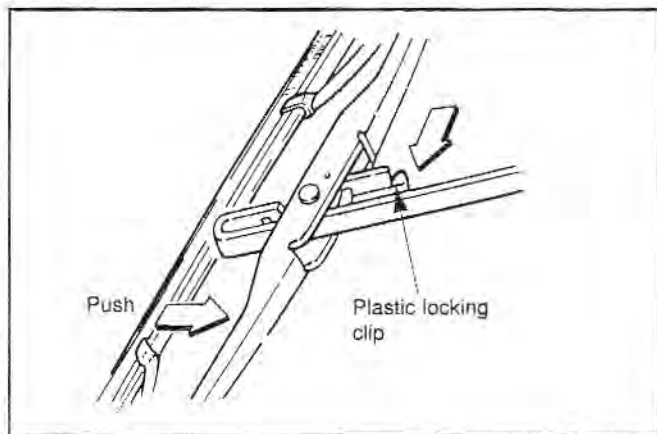

AN7B07016

1. Raise the wiper arm and turn the wiper blade assembly to expose the plastic locking clip. Compress the clip and slide the blade assembly downward; then lift it off the arm.

*** NOTICE**

Do not allow the wiper arm to fall against the windshield.

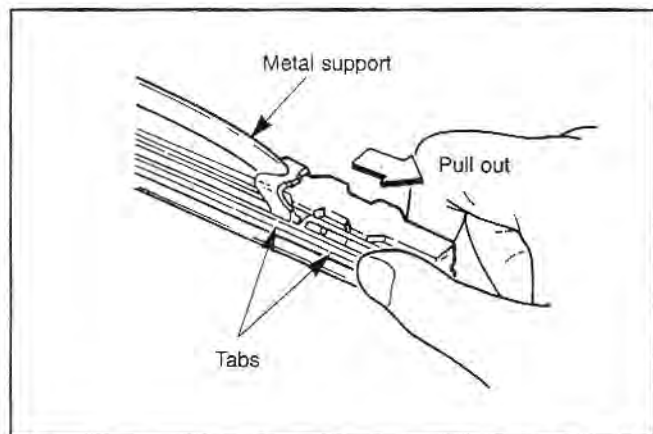

AN7B07017

2. Firmly grasp the end of the rubber blade and pull until the tabs are free of the metal support.

Maintenance

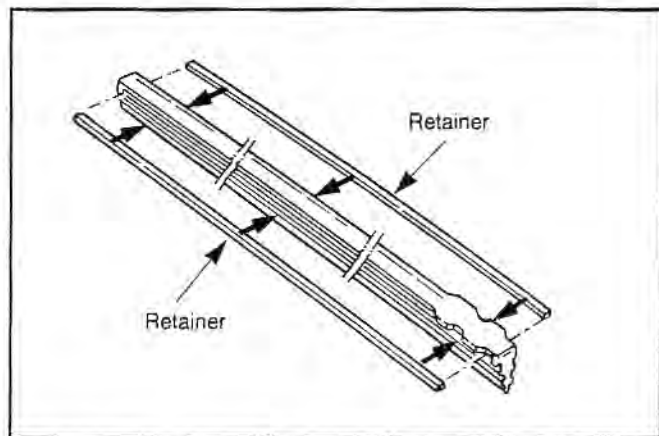

AN7B07018

3. Remove the metal retainers from the rubber blade and install them in the new rubber blade.

* NOTICE

Do not bend the metal retainers.

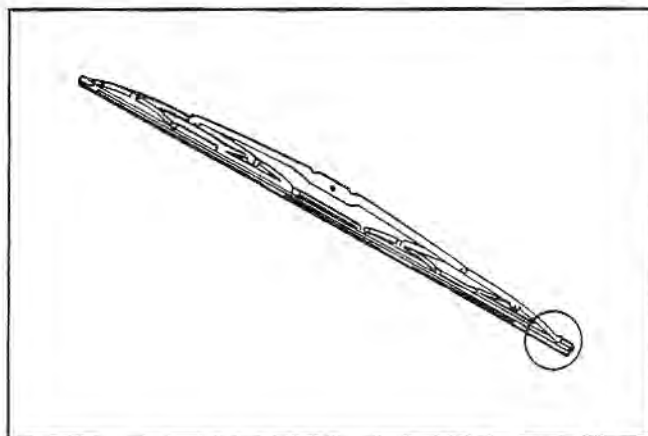

AN7B07019

4. Carefully insert a new rubber blade and install the blade assembly.

Install the blade with the tabs facing towards the bottom of the wiper arm.

Battery

⚠ WARNING - Battery Dangers

- Keep lighted cigarettes and all other flames or sparks away from the battery. Hydrogen, which is a highly combustible gas, is always present in battery cells and may explode if ignited.
- Keep batteries out of the reach of children because batteries contain highly corrosive **SULFURIC ACID**. Do not allow battery acid to contact your skin, eyes, clothing or paint finish.
- If any electrolyte gets into your eyes, flush your eyes with clean water for at least 15 minutes and get immediate medical attention. If possible, continue to apply water with a sponge or cloth until medical attention is received.

(Continued)

(Continued)

- If electrolyte gets on your skin, thoroughly wash the contacted area. If you feel a pain or a burning sensation, get medical attention immediately.
- When charging or working near a battery, wear eye protection. Always provide ventilation when working in an enclosed space.
- When lifting a plastic-cased battery, excessive pressure on the case may cause battery acid to spew through the vent caps, resulting in personal injury. Lift with a battery carrier or with your hands on opposite corners.
- Never attempt to charge the battery when the battery cables are connected.

Maintenance

Maintenance

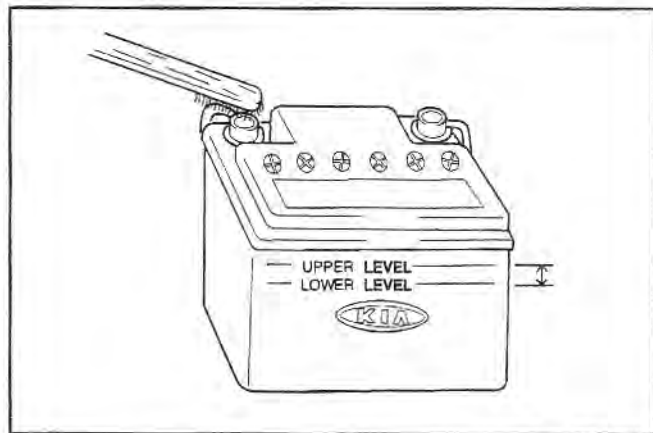

AS2B08020A

For best battery service:

- Keep the battery securely mounted.
- Keep the battery top clean and dry.
- Keep the terminals and connections clean, tight, and coated with petroleum jelly or terminal grease.

- Rinse any spilled electrolyte from the battery immediately with a solution of water and baking soda.
- If the vehicle is not going to be used for an extended time, disconnect the battery cables.

Battery Recharging

Your vehicle has a maintenance-free, calcium-based battery.

- If the battery becomes discharged in a short time (because, for example, the headlights or interior lights were left on while the vehicle was not in use), recharge it by slow charging (trickle) for 10 hours.
- If the battery gradually discharges because of high electric load while the vehicle is being used, recharge it at 20-30A for two hours.

▲ WARNING - Recharging Battery

When recharging the battery, observe the following precautions:

- The battery must be removed from the vehicle and placed in an area with good ventilation.
- Do not allow cigarettes, sparks, or flame near the battery.
- Watch the battery during charging, and stop or reduce the charging rate if the battery cells begin gassing (boiling) violently or if the temperature of the electrolyte of any cell exceeds 49°C (120°F).
- Wear eye protection when checking the battery during charging.

(Continued)

(Continued)

- Disconnect the battery charger in the following order.
 1. Turn off the battery charger main switch.
 2. Unhook the negative clamp from the negative battery terminal.
 3. Unhook the positive clamp from the positive battery terminal.

*** NOTICE**

- Before performing maintenance or recharging the battery, turn off all accessories and stop the engine.
- The negative battery cable must be removed first and installed last when the battery is disconnected.

Maintenance

Tires and Wheels

Tire Care

For proper maintenance, safety, and maximum fuel economy, you must always maintain recommended tire inflation pressures and stay within the load limits and weight distribution recommended for your vehicle.

Inflation Pressures

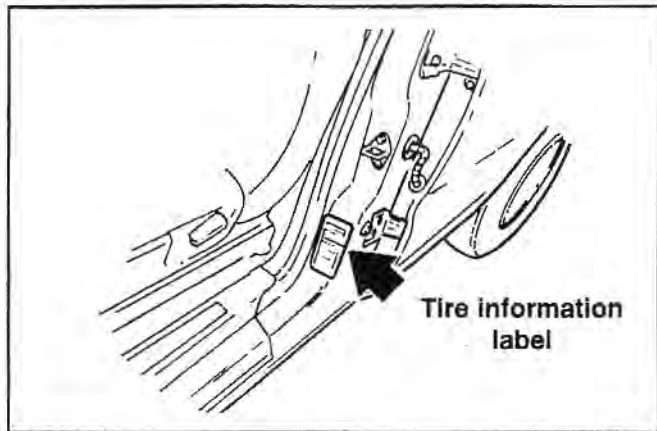

AN7B07021

All tire pressures (including the spare) should be checked monthly when the tires are cold. "Cold Tires" means the vehicle has not been driven for at least three hours or driven less than 1.6 km (one mile). Recommended pressures must be maintained for the best ride, top vehicle handling, and minimum tire wear.

The front and rear tires should be 180 kPa (26 psi). The full-size spare should be inflated to 240 kPa (35 psi).

* NOTICE

- Warm tires normally exceed recommended cold tire pressures by 4 to 6 psi (28 to 41 kPa). Do not release air from warm tires to adjust the pressure or the tires will be underinflated.
- Underinflation results in excessive wear, poor handling, reduced fuel economy, and the possibility of blowouts from overheated tires. Also, low tire pressure can cause poor sealing of the tire bead. If the tire pressure is excessively low, wheel deformation and/or tire separation is possible. So, keep your tire pressures at the proper levels. If a tire frequently needs refilling, have it checked by an authorized Kia dealer.
- Overinflation produces a harsh ride, handling problems, excessive wear at the center of the tire tread, and a greater possibility of damage from road hazards.

WARNING - Tire Inflation

Overinflation or underinflation can reduce tire life, adversely affect vehicle handling, and lead to sudden tire failure. This could result in loss of vehicle control.

Tire Rotation

To equalize tread wear, it is recommended that the tires be rotated every 12 000 km (7,500 miles) or sooner if irregular wear develops.

During rotation, check the tires for correct balance.

When rotating tires, check for uneven wear and damage. Abnormal wear is usually caused by incorrect tire pressure, improper wheel alignment, out-of-balance wheels, severe braking or severe cornering. Look for bumps or bulges in the tread or side of tire. Replace the tire if you find either of these conditions. Replace the tire also if you can see fabric or cord. After rotation, be sure to bring the front and rear tire pressures to specification and check lug nut tightness.

Maintenance

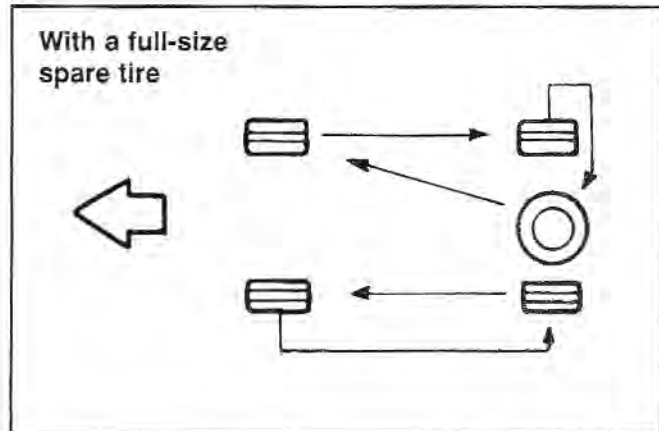

Disc brake pads and rear brake shoes should be inspected for wear whenever tires are rotated.

* NOTICE

Rotate radial tires that have an asymmetric tread pattern only from front to rear and not from right to left.

Tire Replacement

If the tire is worn evenly, a tread wear indicator will appear as a solid band 12.7 mm wide (1/2 inch) across the the tread. This shows there is less than 1.6 mm (1/16 inch) of tread left on the tire. Replace the tire when this happens.

Do not wait for the band to appear across the entire tread before replacing the tire.

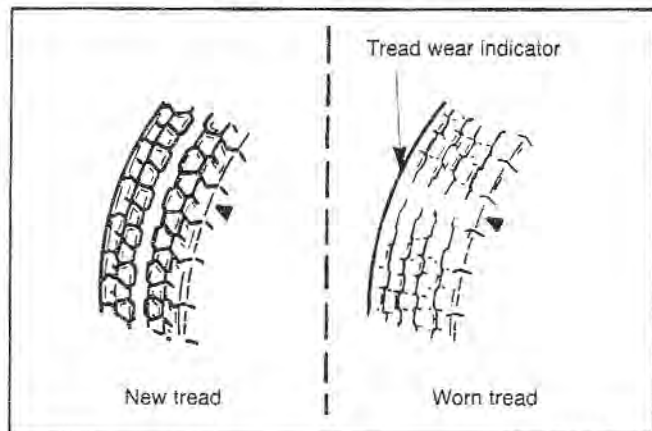

Wheel Alignment and Tire Balance

The wheels on your vehicle were aligned and balanced carefully at the factory to give you the longest tire life and best overall performance.

In most cases, you will not need to have your wheels aligned again. However, if you notice unusual tire wear or your vehicle pulling one way or the other, the alignment may need to be reset. If you notice your vehicle vibrating when driving on a smooth road, your wheels may need to be rebalanced.

*** NOTICE**

Improper wheel weights can damage your vehicle's aluminum wheels. Use only approved wheel weights.

CAUTION

- *When replacing tires, never mix radial, bias-belted, and bias-type tires. All four tires should be of the same size, design and construction. Use only the tire sizes listed on the Tire Label found below the door striker on the driver's side. Make sure that all tires and wheels are the same size and have the same load-carrying capacity. Use only tire and wheel combinations recommended on the Tire Label or by an authorized Kia dealer. Failure to follow these precautions can adversely affect the safety and handling of your vehicle.*
- *The use of any other tire size or type may seriously affect ride, handling, ground clearance, tire clearance, and speedometer calibration.*

(Continued)

(Continued)

- *Driving on worn-out tires is very hazardous and will reduce braking effectiveness, steering accuracy, and traction.*
- *It is best to replace all four tires at the same time. If that is not possible, or necessary, then replace the two front or two rear tires as a pair. Replacing just one tire can seriously affect your vehicle's handling.*

Wheel Replacement

When replacing the metal wheels for any reason, make sure the new wheels are equivalent to the original factory units in diameter, rim width and offset.

CAUTION

A wheel that is not the correct size may adversely affect wheel and bearing life, braking and stopping abilities, handling characteristics, ground clearance, body-to-tire clearance, snow chain clearance, speedometer calibration, headlight aim and bumper height.

Tire Size Designation

A tire's sidewall is marked with a tire size designation. You will need this information when selecting replacement tires for your car. The following explains what the letters and numbers in the tire size designation mean.

Example tire size designation: P205/75R15 97S

P – Applicable vehicle type (tires marked with the prefix “P” are intended for use on passenger cars or light trucks; however, not all tires have this marking).

205 – Tire width in millimeters.

75 – Aspect ratio. The tire's section height as a percentage of its width.

R – Tire construction code (Radial).

15 – Rim diameter in inches.

97 – Load Index, a numerical code associated with the maximum load the tire can carry.

S – Speed Rating Symbol. See the speed rating chart in this section for additional information.

Wheel Size Designation

Wheels are also marked with important information that you need if you ever have to replace one. The following explains what the letters and numbers in the wheel size designation mean.

Example wheel size designation: 6.0JJ x 15

6.0 – Rim width in inches.

J – Rim contour designation.

15 – Rim diameter in inches.

Maintenance

Tire Speed Ratings

The chart below shows many of the different speed ratings currently being used for passenger car and light truck tires. The speed rating symbol is part of the tire size designation on the sidewall of the tire. This symbol corresponds to that tire's designed maximum safe operating speed.

Speed Rating Symbol	Maximum Speed
S	180 km/h (112 mph)
T	190 km/h (118 mph)
H	210 km/h (130 mph)
V	240 km/h (149 mph)
Z	Above 240 km/h (149 mph)

Uniform Tire Quality Grading

The following information relates to the tire grading system developed by the Canadian Motor Vehicle Safety Standard (CMVSS) for grading tires by tread wear, traction and temperature performance.

Tread Wear

The tread wear grade is a comparative rating based on the wear rate of the tire when tested under controlled conditions on a specified government test course. For example, a tire graded 150 would wear one-and-a-half times as well on the government course as a tire graded 100.

The relative performance of tires depends upon the actual conditions of their use. However, performance may differ from the norm because of variations in driving habits, service practices and differences in road characteristics and climate.

These grades are molded on the side-walls of passenger vehicle tires. The tires available as standard or optional equipment on Kia vehicles may vary with respect to grade.

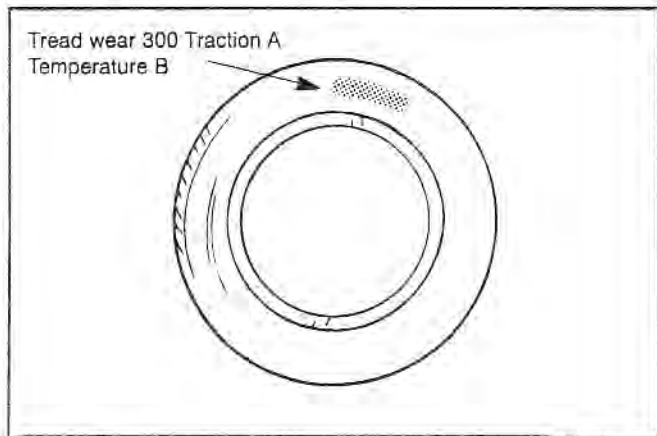

AN7B07024

Traction – A, B & C

The traction grades, from highest to lowest, are A, B and C. The grades represent the tire's ability to stop on wet pavement as measured under controlled conditions on specified government test surfaces of asphalt and concrete. A tire marked C may have poor traction performance.

Temperature – A, B & C

The temperature grades are A (the highest), B and C. The grades represent the tire's resistance to the generation of heat and its ability to dissipate heat when tested under controlled conditions on a specified indoor laboratory test wheel. Sustained high temperature can cause the material of the tire to degenerate and reduce tire life, and excessive temperature can lead to sudden tire failure. Grade C corresponds to a level of performance which all passenger vehicle tires must meet under the Federal Motor Vehicle Safety Standard No. 109. Grades A and B represent higher levels of performance on the laboratory test wheel than the minimum required by the law.

Maintenance

⚠ WARNING - Tire Temperature

The temperature grade for this tire is established for a tire that is properly inflated and not overloaded. Excessive speed, underinflation, or excessive loading, either separately or in combination, can cause heat build-up and possible sudden tire failure. This can cause loss of vehicle control and serious injury or death.

Bulb Replacement

Headlight Replacement

⚠ WARNING - Halogen Bulbs

- Halogen bulbs contain pressurized gas that will produce flying pieces of glass if broken.
- Always handle them carefully, and avoid scratches and abrasions. If the bulbs are lit, avoid contact with liquids. Never touch the glass with bare hands. Residual oil may cause the bulb to overheat and burst when lit. A bulb should be operated only when installed in a headlight.
- If a bulb becomes damaged or cracked, replace it immediately and carefully dispose of it.
- Wear eye protection when changing a bulb. Allow the bulb to cool before handling it.

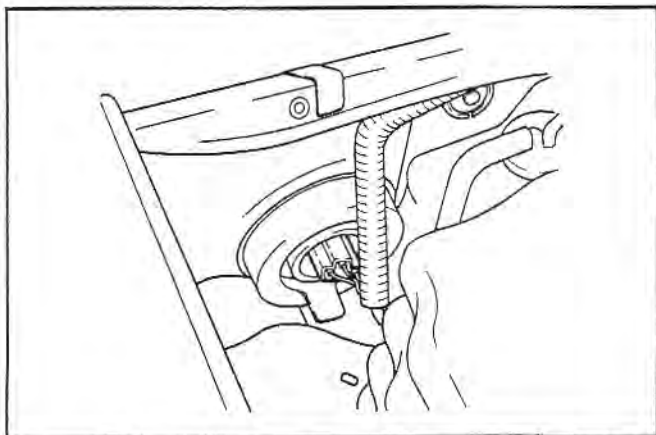

AN7B07025

1. Open the hood.
2. Disconnect the connector from the bulb assembly.

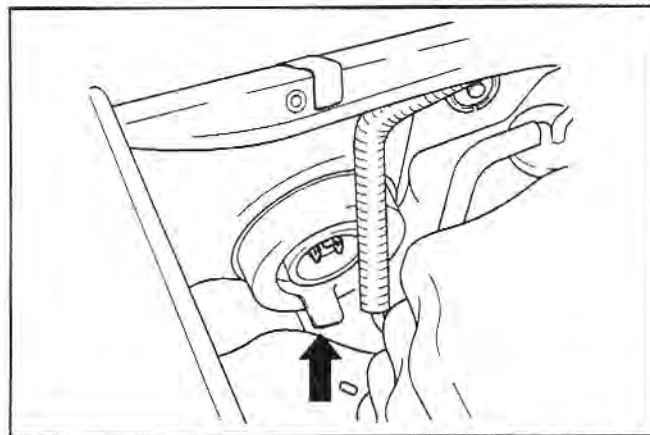

AN7B07026

3. Remove the rubber by pulling it out.

Maintenance

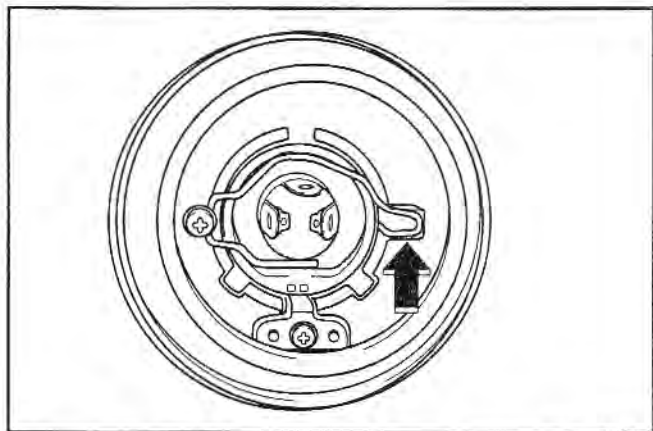

AN7B07027

4. Unsnap the headlight bulb retaining wire.
5. Remove the bulb from the three (3) slots on the headlight assembly.
6. Install a new headlight bulb in the three (3) slots on the headlight assembly and snap the headlight bulb retaining wire into position.
7. Install the rubber into position.
8. Connect the headlight bulb electrical connector.

Turn Signal and Parking Light Replacement

1. Open the hood.

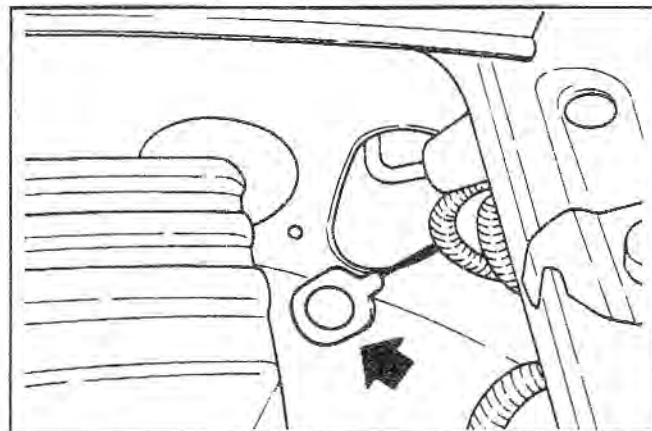

1N7B07010A

2. Locate the white plastic ring.
3. Pull on the ring until the spring lock releases from the inner fender.
4. Gently pull the housing assembly away from the vehicle.

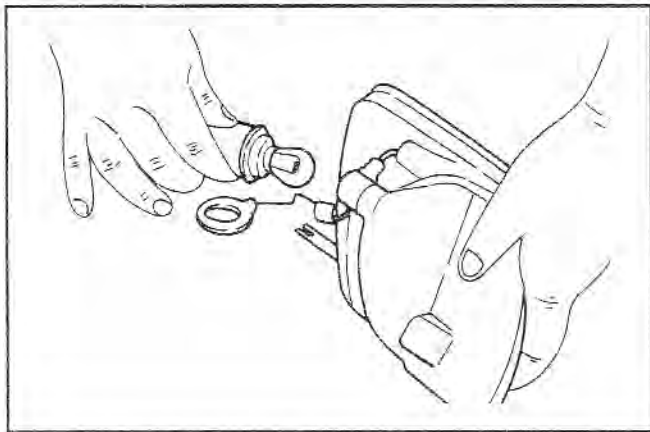

1N7B07011A

5. Remove the socket from the housing by turning the socket counterclockwise until the tabs on the socket align with the slots on the

housing. Carefully remove the socket from the housing.

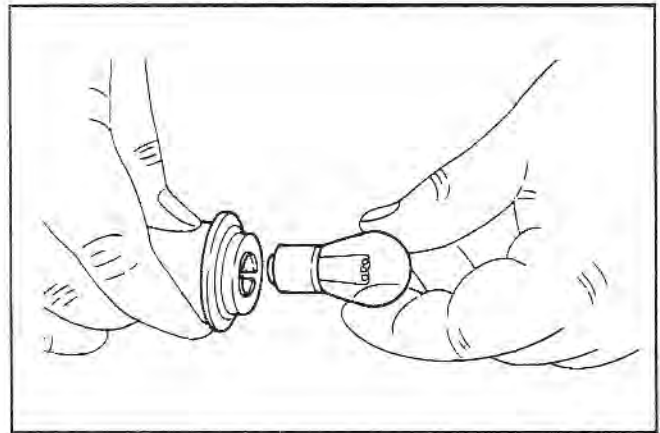

1N7B07012A

6. Remove the bulb from the socket by pressing it in and rotating it until the tabs on the bulb align with the slots in the socket. Pull the bulb out of the socket.
7. Install a new bulb by inserting it into the socket and rotating it until it locks into place.

Maintenance

8. Install the socket in the housing by aligning the tabs on the socket with the slots in the housing. Push the bulb into the socket and turn the socket clockwise.
9. Carefully slide the white plastic ring and spring back through the opening in the fender as you align the two tabs and one post on the housing with the two slots and one notch in the fender and carefully seat the housing in the fender.
10. Pull on the white plastic ring to secure the catch on the spring to the fender.

Dome Light Replacement

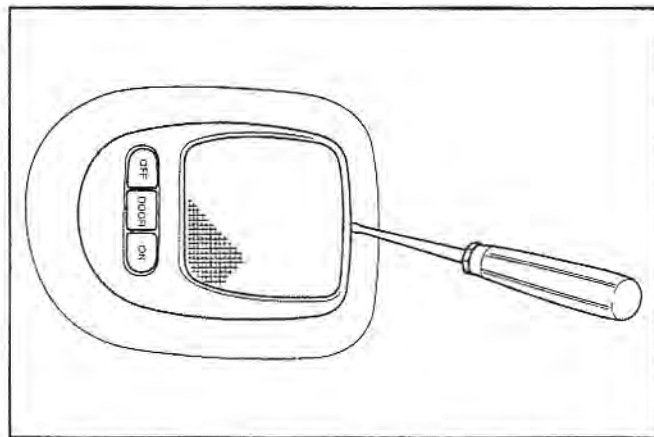

BN7B07031

1. Carefully pull down on the notch in the back of the lens to remove it.

CAUTION

Prior to working on the Dome Light, ensure that the "OFF" button is depressed to avoid burning your fingers or receiving an electric shock.

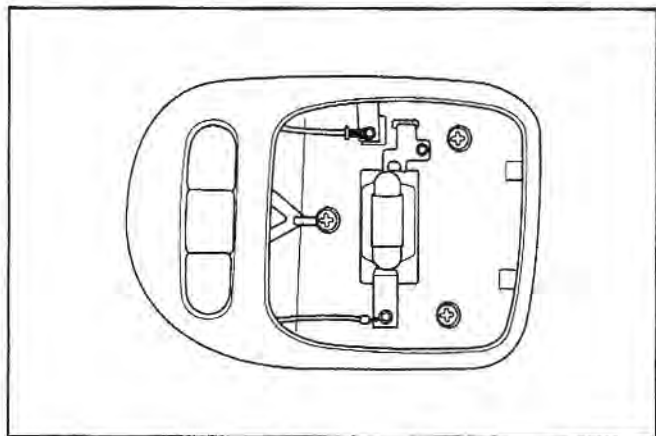

BN7B07032

2. Push up on the metal spring clip until the bulb drops down to remove it.

3. Install a new bulb. The easiest way to do this is to place the bulb into the spring clip first, then slide the other end into place.
4. When installing the lens, align the two front tabs with the notches before pushing up on the rear of the lens.

Rear Cargo Area Light Replacement

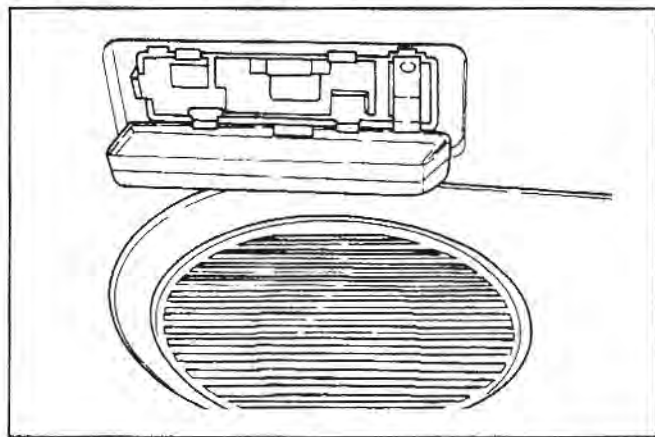

1N7B07014A

Maintenance

1. Open the rear hatch.
2. Carefully pry the lens from the storage compartment lamp assembly.
3. Cover the opening beneath the bulb to keep the bulb from falling into it.
4. Remove the bulb by pushing on the spring-clip.
5. Place one end of the replacement bulb into the spring-clip side of the retainer, then slide the other end into place.
6. Carefully snap the lens back in place.

Center High-Mounted Stoplight Replacement

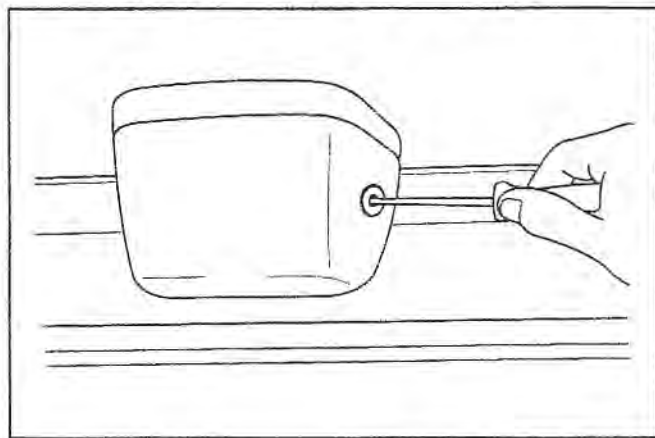

BN7B07054

1. Using a small screwdriver gently but firmly press on the center of the retaining clips on each side of the light until the center pin is pushed in.

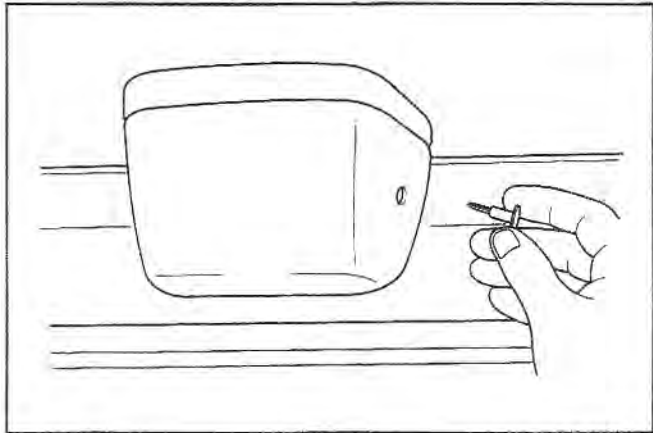

BN7B07035

2. Pull out the retaining clips and remove the cover.

Do not discard the retaining clips.

3. Rotate the socket one-quarter turn counter-clockwise and remove it from the housing.

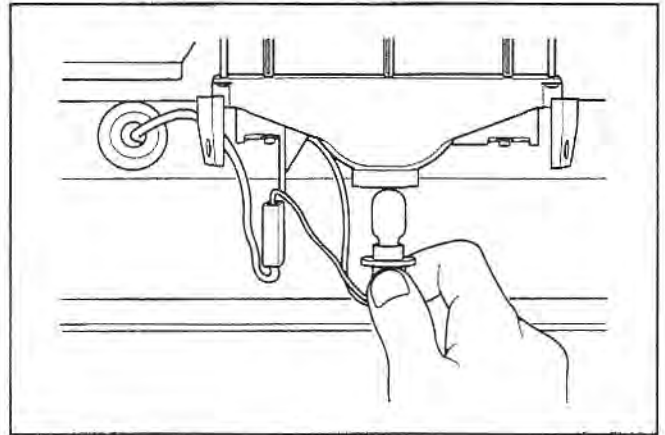

BN7B07036

4. Pull the bulb straight out.

Maintenance

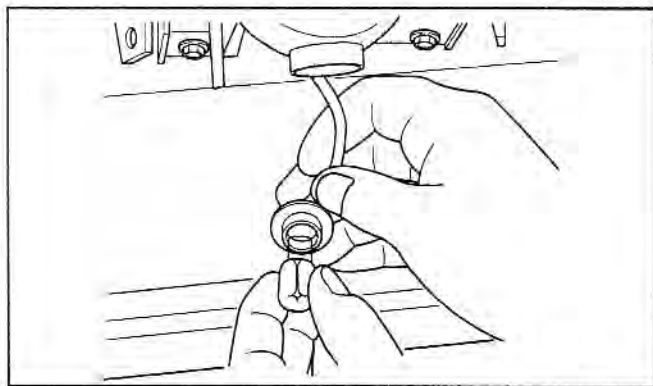

BN7B07037

5. Install a new bulb in the socket.
6. Insert the socket in the housing and secure it by rotating it one quarter turn clockwise.
7. Press the center pins back out of the retaining clips.
8. Seat the lip of the cover in the housing and install the two clips.

9. Press the center pins of the retaining clips until they are flush with the surface of the clip.
Do not press the center pins through the clip.

License Plate Light Replacement

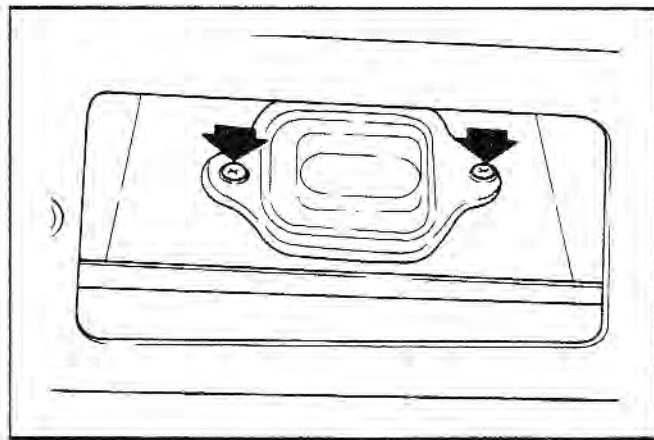

1N7B07015A

1. Using a cross-tip screwdriver, remove the two lens retaining screws.
2. Remove the lens.

3. Pull the bulb holder assembly down.
4. Remove the bulb by pulling it straight out.

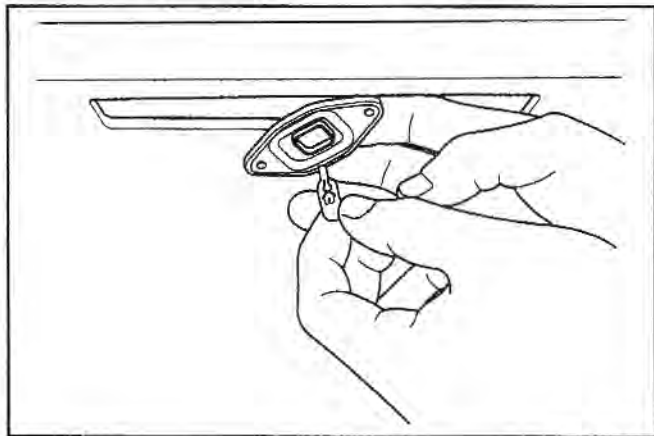

BN7B07039

5. Install a new bulb.
6. Reassemble the lens and bulb holder assembly and secure with the two lens retaining screws.

Rear Light (Tail, Back Up, Brake) Replacement

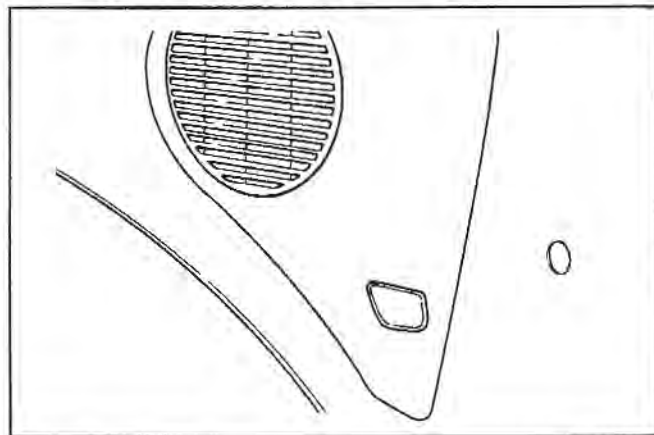

1N7B07016A

1. Pull out on the finger slots to remove the rear speaker cover.

Maintenance

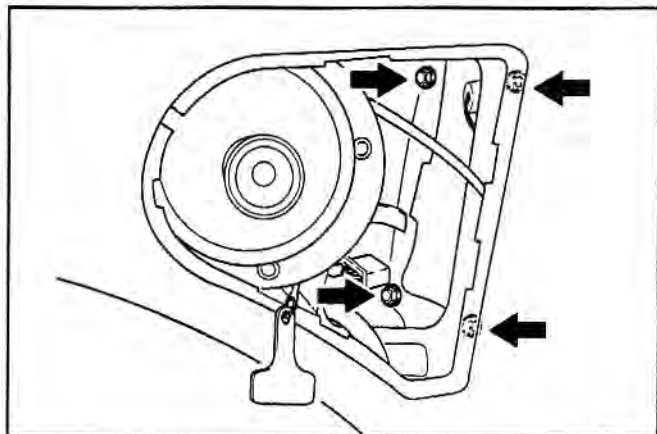

AN7B07041

2. Disconnect the electrical connector by pressing on the locking tab while pulling on the connector.
3. Remove the four (4) nuts to disconnect the light assembly.

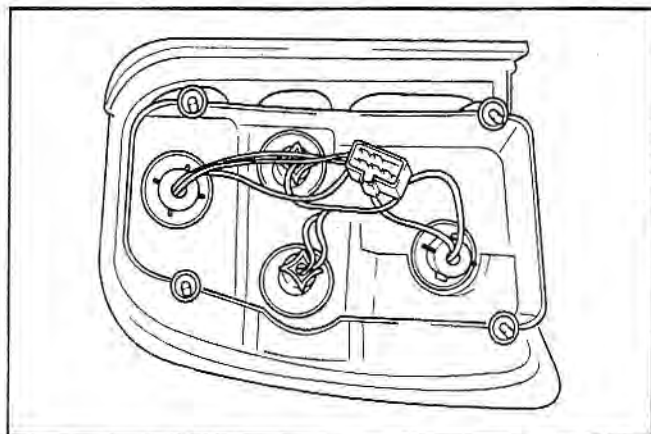

AN7B07042

4. Disconnect the light assembly from the body of the vehicle.
5. Remove the bulb from the three (3) slots on the light assembly.
6. Install a new bulb.
7. Install the light assembly to the body of the vehicle.
8. Install the four (4) nuts.
9. Connect the electrical connector:
Make sure the connector is firmly seated.

Lubricant Specifications

Recommended Lubricants

To help achieve proper engine and powertrain performance and durability, use only lubricants of the proper quality. The correct lubricants also help promote engine efficiency that results in improved fuel economy.

Engine oils labeled Energy Conserving Oil are now available. Along with other additional benefits, they contribute to fuel economy by reducing the amount of fuel necessary to overcome engine friction. Often, these improvements are difficult to measure in everyday driving, but in a year's time, they can offer significant cost and energy savings.

Maintenance

These lubricants and fluids are recommended for use in your vehicle:

Lubricant	Classification
Engine oil*	API Service SG or SH Energy Conserving II (EC II)(SAE 5W-30)
Manual transmission oil*	API Service GL-4 (SAE 75W-90)
Automatic transmission fluid	Dexron II E or M-III
4WD transfer case fluid*	API Service GL-4 (SAE 75W-90)
Front and rear differential oil*	API Service GL-5 (SAE 90, SAE 80W-90)
Power steering fluid	PSF-III
Brake/clutch fluid	SAE J1703 or FMVSS116 DOT-3 or DOT-4

Recommended SAE Viscosity Number

* NOTICE

Always be sure to clean the area around any filler plug, drain plug, or dipstick before checking or draining any lubricant. This is especially important in dusty or sandy areas and when the vehicle is used on unpaved roads. Cleaning the plug and dipstick areas will prevent dirt and grit from entering the engine and other mechanisms that could be damaged.

Engine oil viscosity (thickness) has an effect on fuel economy and cold weather operating (starting and oil flow). Lower viscosity engine oils can provide better fuel economy and cold weather performance, however, higher viscosity engine oils are required for satisfactory lubrication in hot weather. Using oils of any viscosity other than those recommended could result in engine damage. When choosing an oil, consider the range of temperature your vehicle will be operated in before the next oil change. Proceed to select the recommended oil viscosity from the chart.

Temperature Range for SAE Viscosity Numbers												
Temperature	°C	-50	-40	-30	-20	-10	0	10	20	30	40	50
	(°F)	-58	-40	-22	-4	14	32	50	68	86	104	122
Engine Oil	10W-30											
	10W-40					10W-50						
	5W-30											

Maintenance

Exterior Care

Exterior General Caution

It is very important to follow the label directions when using any chemical cleaner or polish. Read all warning and caution statements that appear on the label.

Finish Maintenance

Washing

To help protect your vehicle's finish from rust and deterioration, wash it thoroughly and frequently at least once a month with lukewarm or cold water.

If you use your vehicle for off-road driving, you should wash it after each off-road trip. Pay special attention to the removal of any accumulation of salt, dirt, mud, and other foreign materials. Make sure the drain holes in the lower edges of the doors and rocker panels are kept clear and clean.

Insects, tar, tree sap, bird droppings, industrial pollution and similar deposits can damage your vehicle's finish if not removed immediately.

Even prompt washing with plain water may not completely remove all these deposits. A mild soap, safe for use on painted surfaces, may be used.

After washing, rinse the vehicle thoroughly with lukewarm or cold water. Do not allow soap to dry on the finish.

*** NOTICE**

Do not use strong soap, chemical detergents or hot water, and do not wash the vehicle in direct sunlight or when the body of the vehicle is warm.

CAUTION

After washing the vehicle, test the brakes while driving slowly to see if they have been affected by water. If braking performance is impaired, dry the brakes by applying them lightly while maintaining a slow forward speed.

CAUTION - Water washing in Engine Compartment

- *Water washing in the engine compartment may cause the failure of electrical circuits located in the engine compartment.*
- *Pay extreme attention to wash the engine compartment by using water.*

Waxing

Wax the vehicle when water will no longer bead on the paint.

Always wash and dry the vehicle before waxing. Use a good quality liquid or paste wax, and follow the manufacturer's instructions. Wax all metal trim to protect it and to maintain its luster.

Removing oil, tar, and similar materials with a spot remover will usually strip the wax from the finish. Be sure to re-wax these areas even if the rest of the vehicle does not yet need waxing.

*** NOTICE**

- Wiping dust or dirt off the body with a dry cloth will scratch the finish.
- Do not use steel wool, abrasive cleaners, or strong detergents containing highly alkaline or caustic agents on chrome-plated or anodized aluminum parts. This may result in damage to the protective coating and cause discoloration or paint deterioration.

Maintenance

Finish Damage Repair

Deep scratches or stone chips in the painted surface must be repaired promptly. Exposed metal will quickly rust and may develop into a major repair expense.

*** NOTICE**

If your vehicle is damaged and requires any metal repair or replacement, be sure the body shop applies anti-corrosion materials to the parts repaired or replaced.

Bright-Metal Maintenance

- To remove road tar and insects, use a tar remover, not a scraper or other sharp object.
- To protect the surfaces of bright-metal parts from corrosion, apply a coating of wax or chrome preservative and rub to a high luster.
- During winter weather or in coastal areas, cover the bright metal parts with a heavier coating of wax or preservative. If necessary, coat the parts with non-corrosive petroleum jelly or other protective compound.

Underbody Maintenance

Corrosive materials used for ice and snow removal and dust control may collect on the underbody. If these materials are not removed, accelerated rusting can occur on underbody parts such as the fuel lines, frame, floor pan and exhaust system, even though they have been provided with rust protection.

Thoroughly flush the vehicle underbody and wheel openings with lukewarm or cold water once a month, after off-road driving and at the end of each winter. Pay special attention to these areas because it is difficult to see all the mud and dirt. It will do more harm than good to wet down the road grime without removing it. The lower edges of doors, rocker panels, and frame members have drain holes that should not be allowed to clog with dirt; trapped water in these areas can cause rusting.

CAUTION

After washing the vehicle, test the brakes while driving slowly to see if they have been affected by water.

Aluminum Wheel Maintenance

The aluminum wheels are coated with a clear protective finish.

- *Do not use any abrasive cleaner, polishing compound, solvent, or wire brushes on aluminum wheels. They may scratch or damage the finish.*
- *Use only a mild soap or neutral detergent, and rinse thoroughly with water. Also, be sure to clean the wheels after driving on salted roads. This helps prevent corrosion.*
- *Avoid washing the wheels with high-speed car wash brushes.*

Interior Care

Interior General Precautions

Prevent caustic solutions such as perfume and cosmetic oil from contacting the dashboard because they may cause damage or discoloration. If they do contact the dashboard, wipe them off immediately. See the instructions that follow for the proper way to clean vinyl.

Cleaning the Upholstery and Interior Trim

Vinyl

Remove dust and loose dirt from vinyl with a whisk broom or vacuum cleaner. Clean vinyl surfaces with a vinyl cleaner.

Maintenance

Fabric

Remove dust and loose dirt from fabric with a whisk broom or vacuum cleaner. Clean with a mild soap solution recommended for upholstery or carpets. Remove fresh spots immediately with a fabric spot cleaner. If fresh spots do not receive immediate attention, the fabric can be stained and its color can be affected. Also, its fire-resistant properties can be reduced if the material is not properly maintained.

CAUTION

Using anything but recommended cleaners and procedures may affect the fabric's appearance and fire-resistant properties.

Cleaning the Lap/Shoulder Belt Webbing

Clean the belt webbing with any mild soap solution recommended for cleaning upholstery or carpet. Follow the instructions provided with the soap. Do not bleach or re-dye the webbing because this may weaken it.

Cleaning the Interior Window Glass

If the interior glass surfaces of the vehicle become fogged (that is, covered with an oily, greasy or waxy film), they should be cleaned with glass cleaner. Follow the directions on the glass cleaner container.

* NOTICE

Do not scrape or scratch the inside of the rear window. This may result in damage to the rear window defroster grid.

Specifications

Specifications 8-2

Specifications

Specifications

The specifications given here are for general information only. Please check with an authorized Kia dealer for more precise and more up-to-date information.

DIMENSIONS

Unit: mm (in)

Item	4 Doors
Overall length w/o spare tire carrier	4 125 (161.2)
Overall length w/ spare tire carrier	4 325 (170.3)
Overall width	1 730 (68.1)
Overall height	1 650 (65.0)
Front tread	1 440 (56.7)
Rear tread	1 440 (56.7)
Wheelbase	2 650 (104.3)

WEIGHTS

Unit: Kg (Lbs)

Item		4 Doors
GVWR		1 940 (4,277)
GAWR	Front	950 (2,094)
	Rear	1 030 (2,271)

GVWR: Gross Vehicle Weight Rating

GAWR: Gross Axle Weight Rating

AIR CONDITIONER

Refrigerant complies with SAE J639	R134A
Maximum operating charge	700 g (25 oz)

TIRES

Size	Inflation Pressure (psi)
P205/75R15	26 (front and rear)
T145/80D16 compact spare	60
full-size spare	35

FUSES

Please refer to "Fuses" in the Index.

LIGHT BULBS

Light Bulb	Wattage	P/N
Exterior Lights		
Headlights	60/55	1102
Front parking and side marker	27/8	1157 NA
Front turn signal lights	27/8	1157 NA
Rear turn signal lights	27	1156 NA
Rear running lights	27/8	1157
Brake lights	27/8	1157
High mounted brake light	27	1156
Back-up lights	27	1156
License plate lights	5	168
Interior Lights		
Dome light	10	12584
Rear cargo area light	5	D03175

Specifications

ENGINE

Item	EFI ENGINE
Bore x Stroke	86 mm x 86 mm (3.39 in x 3.39 in)
Displacement	1,998 cc (122 cu-in)
Compression Ratio	9.2:1

ELECTRICAL SYSTEM

Item		EFI ENGINE 4 CYL. DOHC
Battery		12V, 60AH
Alternator		12V/70A
Starter	M/T	0.9 Kw
	A/T	1.2 Kw
Spark Plug	Gap	1.0-1.1 mm (0.039-0.043 in)
	Specification	NGK BKR6E-11

CAPACITIES

Item		US qt	Liter
Engine oil (w/filter)		4.4	4.3
Coolant		8.0	7.5
Transmission Oil (Manual)	2WD	1.7	1.6
	4WD	1.3	1.2
Transmission Oil (Automatic)		7.2	6.8
4WD Transfer Case		1.8	1.7
Rear Differential		1.6	1.5
Front Differential		1.3	1.2
		US gal	Liter
Fuel Tank	4Doors	15.8	60
	2Doors	14.0	53

2WD : 2 Wheel Drive

4WD : 4 Wheel Drive

GEAR RATIO

Gear	M/T	A/T
1st	3.717	2.826
2nd	2.019	1.493
3rd	1.363	1.000
4th	1.000	0.730
5th	0.804	–
Reverse	3.445	2.703

M/T : Manual Transmission

A/T : Automatic Transmission

TRANSFER CASE

Gear Ratio	
High/Low	1.000/1.981

CLUTCH

Clutch Control		Hydraulic
Clutch Pedal	Type	Suspended
	Pedal ratio	6.9
	Full stroke	155
	Height	250

Index

ABS	4-37
Warning Light	4-33
Air Bag Supplemental Restraint System	3-35
Air Bag Warning Light	3-43
Air Cleaner	7-26
Air Conditioner (Specifications)	8-2
Air Conditioning	4-72
Air Intake Control Button	4-67
Alignment, Tire Balance and Wheel	7-37
Aluminum Wheel Maintenance	7-59
Anti Lock Brake System	4-32
Warning Light	4-33
Anti-Theft Steering Column Lock, Ignition Switch and	4-3
Ashtray	
Front	4-62
Rear	4-63
Auto Door Locks	3-4
Automatic Transmission	4-10
Transmission Fluid Level, Check the	7-21
Automatic Locking Hubs	4-24
Balancing, Wheel Alignment and Tire	7-37
Battery	7-31
Maintenance	7-32
Recharging	7-32
Belts, Safety	3-19
Blade Replacement, Windshield Wiper	7-28
Blades, Wiper	7-28
Body Lubrication	7-26
Brake/Clutch Fluid Level, Checking	7-17
Brake	
Fluid Warning, Parking Brake and	4-49
Parking	4-30, 7-18
System	4-27
System, Anti-Lock	4-32
Wear Indicators, Disc	4-28
And Clutch	7-17
Brakes	
Power	4-27
Rear Drum	4-29
Trailer	5-37
Break-In Process, Vehicle	1-3
Bush Replacement	7-42

Index

- Bulbs, Light 8-3
- Capacities 8-4
- Capacity, Oil 7-13
- Care
 - of the Safety Belt System, Proper Use and 3-29
 - Exterior 7-56
 - Interior 7-59
- Cargo Area Light Replacement, Rear 7-47
- Catalytic Converters, Operating Precautions for 5-4
- Center High-Mounted Stoplight Replacement 7-48
- Chains
 - Safety 5-36
 - Tire 5-11
- Charging System Warning 4-48
- Chassis Number 5-43
- Check Engine Light 4-50
- Child Safety Lock, Rear Door 3-6
- Children
 - Restraint of Infants and Small 3-30
 - Restraint of Large 3-31
- Cigarette Lighter 4-61
- Cleaner, Air 7-26
- Cleaning
 - Interior Window Glass 7-60
 - Lap/Shoulder Belt Webbing 7-60
 - Upholstery and Interior Trim 7-59
- Climate Control System 4-66
- Clock, Digital 4-60
- Cluster, Instrument 4-41, 4-42
- Clutch/Brake Fluid Level, Checking 7-17
- Clutch
 - Brakes and 7-17
 - (Specifications) 8-5
- Compartment, Engine 7-10
- Console Storage Compartment 3-59
- Coolant, Changing 7-15
- Coolant Level, Checking the 7-14
- Cooling System, Engine 7-13
- Cruise Control 4-36
- Cup Holder 3-57
- Day/Night Rearview Mirror** 3-56
- Defroster
 - Indicator, Rear Window 4-50
 - Rear Window 4-58
- Digital Clock 4-60
- Dimensions 8-2
- Disc Brake Wear Indicators 4-28
- Dome Light
 - Replacement 7-46
- Door

Ajar Warning	4-50	System (Specifications)	8-4
Locks	3-4	Emergency	
Locks, With Key	3-4	In Case of an	6-1
Locks, Without Key	3-5	Starting	6-4
Pocket	4-64	Emission Control System	5-3
Downshifting	4-9	Engine	
Driving		Compartment	7-10
At Night	5-9	Cooling System	7-13
Conditions, Special	5-7	Exhaust Gas Precautions	5-3
Hazardous	5-7	Oil and Filter, Changing the	7-12
In Flooded Areas	5-12	Oil and Oil Filter	7-11
In the Rain	5-9	Oil Level, Checking the	7-11
On Off-Road Hills	5-21	Oil Pressure Warning	4-47
Tips	5-1	Specifications	8-4
Tips, On-Pavement	5-12	Starting the	4-5
Your Vehicle	4-1	Exhaust Gas Precautions, Engine	5-3
Winter	5-10	Exterior	
With a Trailer	5-37	Care	7-56
Drugs and Driving	5-5	Overview, Interior and	2-2
Drum Brakes, Rear	4-29	Fan Speed Control Knob	4-68
Drunk Driving	5-5	Filler Lid, Fuel	3-51
Economical Operation, Suggestions for	5-6	Filter	
Electrical		Changing the Engine Oil and	7-12
Circuit Protection	6-7	Engine Oil and Oil	7-11
Power Outlet	3-62	Finish	
		Damage Repair	7-57

Index

- Maintenance 7-56
- Flasher, Hazard Warning 4-59, 6-2
- Flat Tire, If You Have a 6-18
- Flooded Areas, Driving in 5-12
- Fluids, Lubricants and 7-24
- Folding Rear Seat 3-16
- Four-Wheel Drive 4-20
 - Indicator 4-47
 - Operation, For Safe 4-25
 - Using 5-14
 - Vehicle, Off-Road Driving with 5-16
- Front
 - Ashtray 4-62
 - Lap/Shoulder Belt 3-23
 - Seat 3-11
 - Seat Adjustment 3-11
 - Seat Storage Bin (if equipped) 3-61
- Fuel
 - Filler Lid 3-51
 - Filler Lid Release, Manual 3-51
 - Filler Lid Release, Remote 3-51
 - Gauge 4-44
 - Level Warning, Low 4-50
 - Requirements 5-2
- Fuse Panel Description 6-10
- Fuses 6-7
- Gauges 4-43
- Glove Box 4-64
- Hatch Rear 3-46
- Hazard Warning Flasher 4-59, 6-2
- Hazardous Driving Conditions 5-7
- Headlight
 - High Beam Operation 4-52
 - Replacement 7-42
- Headrest 3-14
- Heating 4-70
- Hitches 5-36
- Hood 3-49
- Horn 3-53
- Hubs, Automatic Locking 4-24
- Ignition Switch 4-3
 - And Anti-Theft Steering Column Lock 4-3
- Illumination, Instrument Panel 4-45
- Indicators, Warnings and 4-46
- Infants and Small Children, Restraint of 3-30
- Inflation Pressures (Tire) 7-34
- Inspections, Necessary 5-5
- Instrument

Cluster	4-41, 4-42	Front	3-23
Panel Illumination	4-45	Rear	3-26
Panel Overview	2-3	Webbing, Cleaning the	7-60
Interior		License Plate Light Replacement	7-50
And Exterior Overview	2-2	Light	
Care	7-59	Bulbs	8-3
Features	4-60	Bulb Replacement	7-42
Lights	3-56	Dome	3-56
Trim, Cleaning the Upholstery and	7-59	Dome Replacement	7-46
Window Glass, Cleaning the	7-60	Interior	3-56
Intermittent Wipers, Variable	4-55	Rear Cargo Area	3-57
Jacking Instructions	6-21	Lighter, Cigarette	4-61
Jump Starting	6-4	Lighting, Control	4-51
Key Reminder Warning Chime	4-51	Lights	
Keys	3-3	Interior	3-56
Knowing Your Vehicle	3-1	Lane Change Signals	4-54
Label		On Warning Chime	4-51
Information	5-41	Locking Hubs, Automatic	4-24
Tire Information	5-44	Locks	
Vehicle Certification	5-42	Auto Door	3-4
Lane Change Signals	4-54	Door	3-4
Lap Belt, Rear Center Seat	3-27	Low Fuel Level Warning	4-50
Lap/Shoulder Belt		Lubricant Specifications	7-53
		Lubricants and Fluids	7-24
		Lubrication, Body	7-26
		Lumbar Support	3-14

Index

- Maintenance 7-1
 - Aluminum Wheel 7-59
 - Battery 7-32
 - Finish 7-56
 - Schedule 7-4
 - Owner 7-8
 - Services 7-3
 - Underbody 7-58
- Manual
 - Fuel Filler Lid Release 3-51
 - Transmission 4-7, 7-19
 - Transmission Oil Level, Checking the 7-19
- Mirror
 - Day/Night Rearview 3-56
 - Electric Remote Control, Outside Rearview 3-55
 - Vanity 4-65
- Mirrors 3-54
- Mode Selection Knob 4-68
- Modifications, Vehicle 5-3

- Night, Driving at 5-9

- Odometer 4-43
- Off-Road Driving
 - After 5-32
 - Getting Familiar with 5-19
 - Loading Your Vehicle for 5-17
 - On Hills 5-21
 - With Your Four-Wheel Drive Vehicle 5-16
- Off-Roading, Before You Go 5-17
- Oil
 - And Filter, Changing the Engine 7-12
 - Capacity 7-13
 - Filter, Engine Oil and 7-11
 - Level, Checking the Engine 7-11
 - Pressure Warning, Engine 4-47
- On-Pavement Driving Tips 5-12
- One-Touch Wipers 4-55
- Outside Rearview Mirror 3-54
- Overheating 6-2
- Overloading 5-41
- Owner Maintenance 7-8
 - Precautions 7-9

- Parking
 - Brake 4-30, 7-18
 - Brake and Brake Fluid Warning 4-49
 - Light Replacement, Turn Signal and 7-44
- Power
 - Brakes 4-27

Outlet, Electrical	3-62	Recharging, Battery	7-32
Steering	4-35, 7-18	Recliner, Adjusting the Front Seat Back	3-12
Steering Fluid Level, Checking the	7-18	Recreational Towing Guidelines	4-75
Windows	3-7	Reminder Warning Chime, Key	4-51
Pregnant Women, Restraint of	3-30	Remote	
Proper Use and Care of the Safety Belt System	3-29	Control Outside Review Mirror, Electric	3-55
		Fuel Filler Door Release	3-51
R ain, Driving in the	5-9	Restraint	
Rear		Of Infants and Small Children	3-30
Ashtray	4-63	Of Pregnant Women	3-30
Cargo Area Light	3-57	System, Safety Belt	3-19
Cargo Area Light Replacement	7-47	Road Warning	6-2
Center Seat Lap Belt	3-27	Rocking the Vehicle	5-8
Door Child Safety Lock	3-6	Rotation, Tire	7-35
Drum Brakes	4-29		
Hatch	3-46	S afety Belt	
Lap/Shoulder Belt	3-26	Restraint System	3-19
Light (Tail, Back Up, Brake) Replacement	7-51	System, Proper Use and Care of	3-29
Safety Belts	3-25	Warning Light and Chime	3-22, 4-48
Seat	3-15	Front Lap/Shoulder Belt	3-23
Seat, Folding	3-16	Rear	3-25
Window Defroster	4-58	Safety Chains	5-36
Window Defroster Indicator	4-50	Safety Lock, Rear Door Child	3-6
Window Wiper/Washer Switch	4-58	Schedule, Maintenance	7-4
Rearview Mirror		Seat	
Day/Night	3-56	Adjustment, Front	3-11
Outside	3-54	Rear	3-15

Index

- Storage Bin, Front 3-61
- Shift Speeds, Recommended 4-9
- Snow Tires 5-10
- Spare Tire
 - And Jack, Removing the 6-18
 - Jack and Tools, Storing the 6-18
- Special Driving Conditions 5-7
- Specifications 8-1
 - Lubricant 7-53
- Speedometer 4-43
- Starting
 - Emergency 6-4
 - Jump 6-4
 - The Engine 4-5
- Steering
 - Column Lock, Ignition Switch and Anti-Theft . . 4-3
 - Power 4-35, 7-18
 - Wheel 3-53
 - Tilt 3-54
- Stoplight Replacement, Center High-Mounted . . 7-48
- Storing the Spare Tire, Jack and Tools 6-18
- Sunvisors 4-65
- Switch, Ignition 4-3

- T**achometer 4-44
- Temperature
 - Control Knob 4-67
 - Gauge, Engine 4-43
- Tight Corner Brake Effect 5-15
- Tile Steering 3-54
- Tire
 - Balance, Wheel Alignment and 7-37
 - Chains 5-11
 - Label 5-44
 - Quality Grading, Uniform 7-40
 - Replacement 6-22, 7-36
 - Rotation 7-35
 - Size Designation 7-39
 - Speed Ratings 7-40
- Tires
 - And Wheels 7-34
 - Changing 6-21
 - Snow 5-10
 - Specifications 8-3
 - Total Weight on Your Vehicle's 5-36
- Theft Deterrent System 4-75
- Towing 6-13
 - Trailer 5-33
 - With a Vehicle Other Than a Tow Truck 6-14
- Trailer
 - Brakes 5-37
 - Driving with a 5-37

Tongue, Weight of the	5-35
Towing, Maintenance when	5-41
Weight of the	5-34
Transfer	
Case (Specifications)	8-5
Lever	4-21
Transmission	
Manual	4-7, 7-19
Oil Level, Check the Manual	7-19
Trip Meter	4-43
Turn Signal and Parking Light Replacement	7-44
Turn Signals	4-53
U nderbody Maintenance	7-58
Uniform Tire Quality Grading	7-40
Upholstery and Interior Trim, Cleaning the	7-59
V acuum Hose Routing Diagram, Vehicle	
Emission Control Information and	5-44
Vanity Mirror	4-65
Vehicle	
At A Glance, Your	2-1
Break-In Process	1-3
Driving Your	4-1

Emission Control Information and Vacuum Hose Routing Diagram	5-44
Identification Number	5-42
Knowing Your	3-1
Modifications	5-3
Rocking the	5-8
Ventilation	4-70

W arning	
And Indicators	4-46
Road	6-2
Washer	
Fluid Level, Checking the	7-24
Wipers and	4-54
Washers, Windshield	4-56
Washing	7-56
Waxing	7-57
Weight	
Of the Trailer	5-34
Of the Trailer Tongue	5-35
Your Vehicle's Tire, Total	5-36
Weights	8-2
Wheel	
Alignment and Tire Balance	7-37
Aluminum, Maintenance	7-59

Index

Replacement.....	7-38
Size Designation	7-39
Steering	3-53
Wheels, Tires and.....	7-34
Window Glass, Cleaning the Interior.....	7-60
Windows,Power.....	3-7
Windshield	
Defrosting and Defogging	4-73
Washers	4-56
Wiper Blade Replacement	7-28
Wipers	4-54
Winter Driving.....	5-10
Wiper	
Blade Replacement, Windshield.....	7-28
Blades.....	7-28
Wiper/Washer Switch, Rear Window.....	4-58
Wipers	
And Washer.....	4-54
Intermittent.....	4-55
One-Touch.....	4-55
Windshield	4-54
Your Vehicle At A Glance.....	2-1