



SORENTO

LOADING . . .

>>OWNER'S MANUAL

 KIA MOTORS

INTRODUCTION

How to Use This Manual	1-2
Vehicle Handling Instruction	1-3
Vehicle Break-In Process	1-3

HOW TO USE THIS MANUAL

We want to help you get the greatest possible driving pleasure from your vehicle. Your Owner's Manual can assist you in many ways. **For your safety and the safety of your passengers, we strongly urge that you read the entire manual. In order to avoid death or injury, please review the WARNING and CAUTION sections contained throughout the manual. The WARNING and CAUTION sections are easily recognized by their special markings listed on this page.**

Illustrations complement the words in this manual to best explain how to enjoy your vehicle. By reading your manual, you will learn about features, important safety information, and driving under various road conditions.

The general layout of the manual is provided in the Table of Contents. In addition, an alphabetical index located at the back of the manual has been provided for your reference.

Sections: This manual has eight sections plus an index. Each section begins with a brief list of contents to provide you with an overview of what is contained in that section.

You will find various WARNING's, CAUTION's, and NOTICE's in this manual. These WARNING's, CAUTION's and NOTICE's are provided to enhance your safety and continued satisfaction with your Kia vehicle. You should carefully read and follow all procedures and recommendations provided in these WARNING's, CAUTION's and NOTICE's.

WARNING

A WARNING indicates a situation in which serious bodily injury or death could result if the warning is ignored.

CAUTION

A CAUTION indicates a situation in which personal injury, perhaps severe, could result if the caution is ignored.

NOTICE

A NOTICE indicates a situation in which damage to your vehicle could result if the notice is ignored.

VEHICLE HANDLING INSTRUCTIONS

As with other vehicles of this type, failure to operate this vehicle correctly may result in loss of control, an accident or vehicle rollover. Specific design characteristics (higher ground clearance, track, etc.) give this vehicle a higher center of gravity than ordinary cars. They are not designed for cornering at the same speeds as conventional 2-wheel drive vehicles. Avoid sharp turns or abrupt maneuvers. Again, failure to operate this vehicle correctly may result in loss of control, an accident or vehicle rollover. Be sure to read the "on-pavement" and "off-road" driving guidelines, Section 5 in this manual.

VEHICLE BREAK-IN PROCESS

No special break-in period is needed. By following a few simple precautions for the first 600 miles (1 000 km) you may add to the performance, economy and life of your vehicle.

- Do not race the engine.
- Do not maintain a single speed for long periods of time, either fast or slow. Varying engine speed is needed to properly break in the engine.
- Avoid hard stops, except in emergencies, to allow the brakes to seat properly.
- Avoid full-throttle starts.

YOUR VEHICLE AT A GLANCE

Interior and Exterior Overview	2-2
Instrument Panel Overview	2-3

INTERIOR AND EXTERIOR OVERVIEW

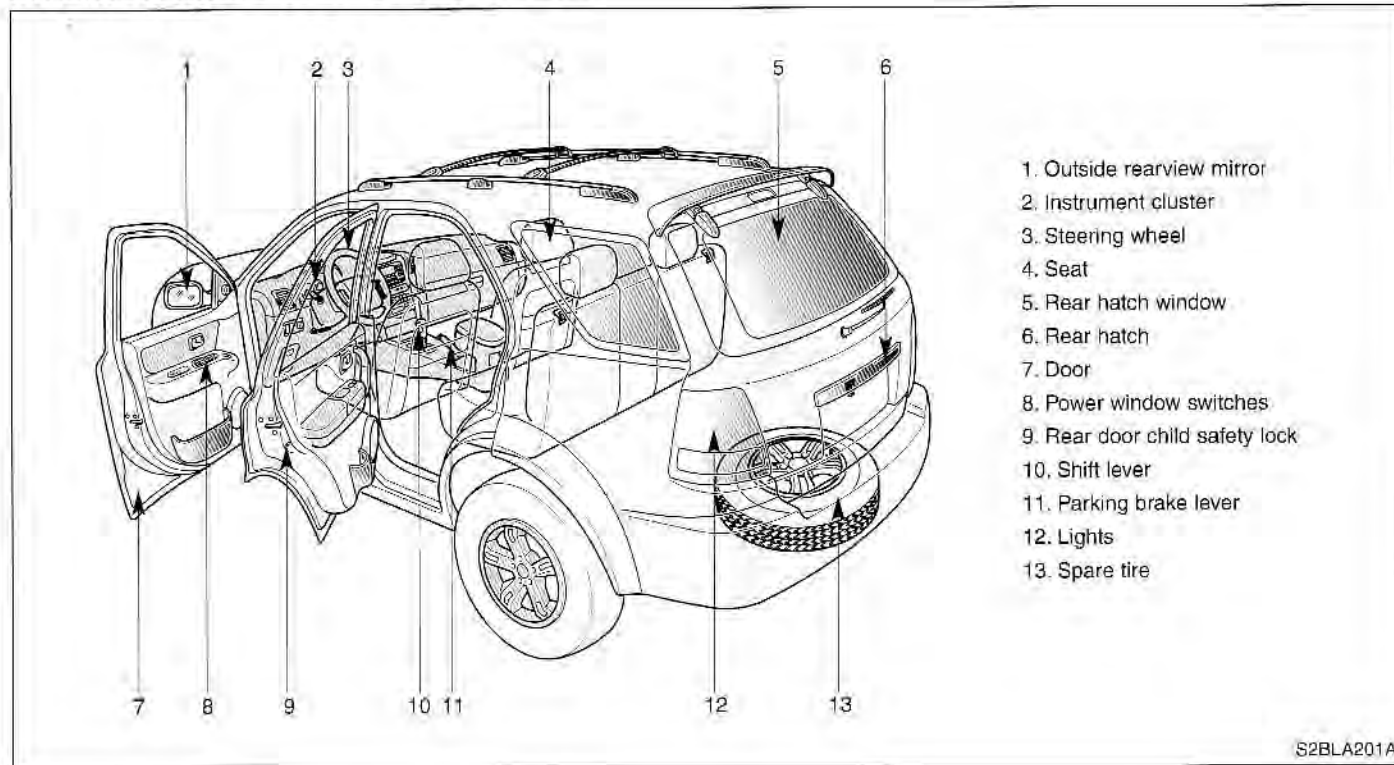

INSTRUMENT PANEL OVERVIEW

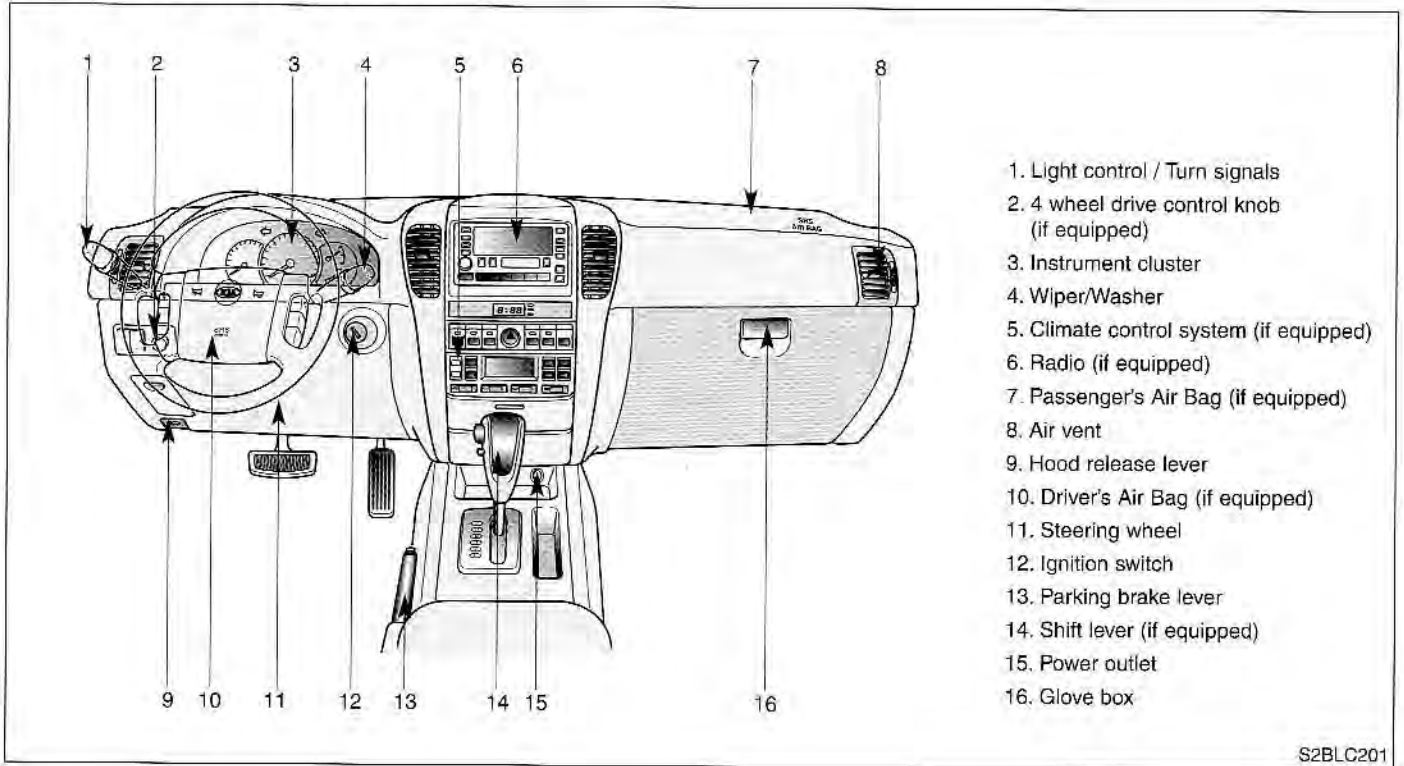

1. Light control / Turn signals
2. 4 wheel drive control knob (if equipped)
3. Instrument cluster
4. Wiper/Washer
5. Climate control system (if equipped)
6. Radio (if equipped)
7. Passenger's Air Bag (if equipped)
8. Air vent
9. Hood release lever
10. Driver's Air Bag (if equipped)
11. Steering wheel
12. Ignition switch
13. Parking brake lever
14. Shift lever (if equipped)
15. Power outlet
16. Glove box

S2BLC201

KNOWING YOUR VEHICLE

Keys	3-2
Immobilizer System	3-3
Door Locks	3-5
Windows	3-10
Front Seat	3-13
Rear Seat	3-21
Safety Belts	3-25
Air Bag - Supplemental Restraint System	3-43
Rear Hatch	3-53
Hood	3-55
Fuel Filler Lid	3-57
Steering Wheel	3-58
Mirrors	3-60
Interior Lights	3-62
Cup Holder	3-64
Sunglass Holder	3-65
Storage Compartment	3-66
Electrical Power Outlet	3-68
Sunroof	3-69
Antenna	3-72
Luggage Net	3-73
Tonneau cover	3-73
Luggage center box	3-74
Roof Rack	3-75

KEYS

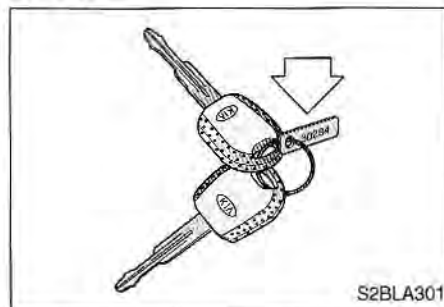

The key code number is stamped on the plate attached to your key set. Should you lose your keys, this number will enable an authorized Kia dealer to duplicate your keys easily. Remove this plate from the key ring and store it in a safe place. Also, record the code number and keep it in a safe and handy place, but not in the vehicle.

⚠ WARNING - Ignition Key

Leaving children unattended in a vehicle with the ignition key is dangerous even if the key is not in the ignition. Children could place the key in the ignition and operate the power windows or other controls, leading to a serious accident. Never leave a child alone in the vehicle, with or without keys.

⚡ CAUTION

Use only Kia original parts for the ignition key in your vehicle. If an aftermarket key is used, the ignition switch may not return to ON after START. If this happens, the starter will continue to operate causing damage to the starter motor and possible fire due to excessive current in the wiring.

IMMOBILIZER SYSTEM - FOR GASOLINE ENGINE (IF EQUIPPED)

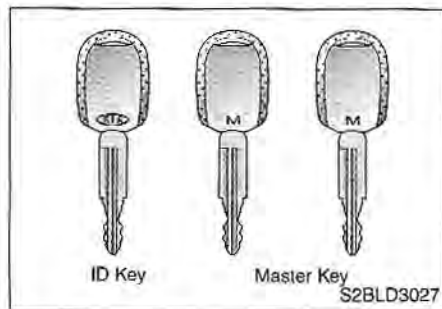

The immobilizer system is an anti-theft device, designed to deter automobile theft.

1) ID key

This key must be used first to register a unique ID code in the ICM.

2) Master key

This key is for general use. It will open all locks on your vehicle. One side of the key has the Kia logo and the other side has the "M" symbol.

CAUTION

Don't lose your ID key or forget the password.

Always keep your ID key in a place where you remember and record your password. If you don't have both the password and ID key, consult your Authorized Kia Dealer.

If you need additional keys or lose your keys, your Authorized Kia Dealer can make new keys if you can supply the key number and ID key.

*** NOTICE**

If you make your own duplicate key, you will not be able to cancel the system or start the engine.

CAUTION

A transponder equipped in your ignition key is very important part to deactivate the immobilizer system. So you must not give any shock on it. It could cause the failure of your immobilizer system and your vehicle's starting.

Limp home (override) procedure

When you turn the ignition key to the ON position, if the IMMO indicator remains on continuously after blinking 6 times, the transponder installed in the ignition key is out of order. You cannot start the engine without using the limp home procedure. To start the engine, you have to input your password using the ignition switch.

The following procedure shows how to input a sample password of "2345."

1. Turn the ignition key to the ON position. The IMMO indicator will blink 6 times and remain on indicating the beginning of the limp home procedure.
2. Turn the ignition key to the ACC position.
3. To enter the first digit (in this example "2"), turn the ignition key to the ON and ACC position twice. Wait 3 seconds but not more than 10 seconds, and perform the same procedure for the next digits (for example, for "3", turn the ignition to ON and ACC 3 times).
4. If all of the digits have been input successfully, you have to start the engine within 10 seconds. If you attempt to start the engine after 10 seconds, the engine will not start and you will have to input your password again.

After performing the limp home procedure, you have to see an authorized Kia dealer immediately to inspect and repair your ignition key or immobilizer system.

CAUTION

If you cannot start your engine in spite of the limp home procedure, have your vehicle towed by an authorized Kia dealer for inspection and necessary repairs.

CAUTION

Do not change, alter or adjust the immobilizer system at your discretion. It could cause the malfunction of your immobilizer system. A malfunction resulting from the changing, altering and/or adjusting by persons other than an authorized Kia dealer will not be covered by the Kia Warranty.

DOOR LOCKS

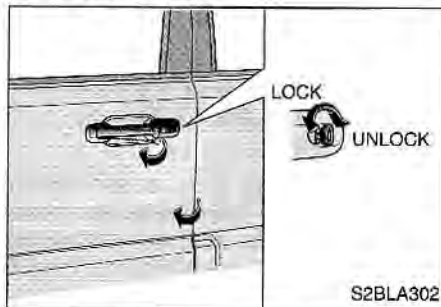

Automatic Door Locks

Operating Door Locks - With the Key

- Turn the key toward rear of vehicle to unlock.
Turn the key toward front of vehicle to lock.
- All four doors and rear hatch can be locked and unlocked from the driver or passenger door with the key.
- Once the doors are unlocked, they may be opened by pulling the door handle.

Two turn unlock system

To unlock the other doors and rear hatch, turn the key to the rear of the vehicle twice within three seconds. To lock all doors and rear hatch, turn the key toward the front of the vehicle once.

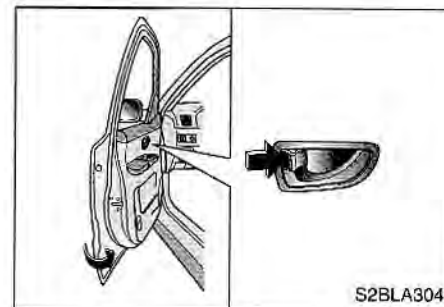

Operating Door Locks - Without the Key

Pushing the door lock knob and then closing the door enables the door to lock without a key.

*** NOTICE**

Always remove the ignition key, engage the parking brake, close all windows and lock all doors when leaving your vehicle unattended.



Operating Door Locks - With Remote Keyless Entry (If equipped)

If your vehicle has this feature, you can lock and unlock your doors and rear hatch from up to 5 m (15 feet) away using the key chain transmitter supplied with your vehicle.

- **Lock** ():

If you depress the corresponding button on the transmitter, all four doors and rear hatch will lock and the hazard lamp will flash once.

- **Unlock** ():

If you depress the corresponding button on the transmitter, all the driver's door will unlock, the hazard lamp will flash twice and the dome light and/or rear cargo area light will come on for 30 seconds if their switches are placed in the center position.

To unlock the other doors and rear hatch, depress the corresponding button twice within three seconds.

After depressing this button, unless you open the doors within 30 seconds, all four doors will lock automatically.

- **Rear hatch window unlock** ():

If you depress the corresponding button on the transmitter, the rear hatch window will unlock.

- **Panic** ():

If you depress the corresponding button on the transmitter for more than 2 seconds, the horn and hazard lamp will flash for about 27 seconds.

WARNING

Leaving your vehicle unlocked can invite theft or possible harm to you or others from someone hiding in your vehicle while you are gone. Always remove the ignition key, engage the parking brake, close all windows and lock all doors when leaving your vehicle unattended.

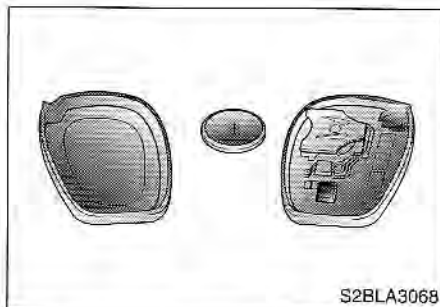

Battery Replacement

1. Insert a slim tool into the slot and gently pry open the transmitter.
2. Remove and replace the 3-volt battery with the (+) facing up.
3. Reassemble the transmitter.
4. Check the transmitter operation.

* NOTICE

- The keyless entry system may not operate when;
 - the ignition key is in the ignition switch.
 - you exceed the operating distance limit (5m).
 - the battery in the transmitter is weak.
 - other vehicles or objects may be blocking the signal. Check the location.
 - the weather is very cold.
 - the transmitter is close to a radio transmitter such as a radio station or an airport which can interfere with normal operation of the transmitter.
- If you have a problem with the keyless entry system, contact an authorized Kia dealer as soon as possible.

CAUTION

- *Using the wrong battery can cause the transmitter to malfunction. Be sure to use the correct battery.*
- *To avoid damaging the transmitter, don't drop it, get it wet, or expose it to heat or sunlight.*

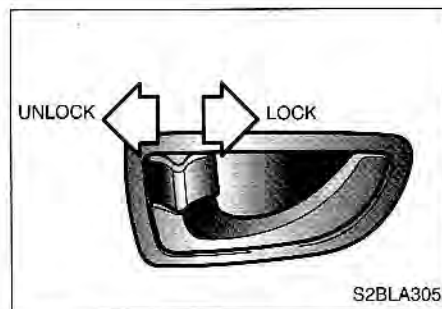

Operating Door Locks From

Inside the vehicle

- To lock a door, push the door lock button to the "LOCK" position.
- To unlock a door, pull the door lock button to the "UNLOCK" position.
- To open a door, pull the door handle outward.
- If you pull the driver's door handle, the driver's door is automatically unlocked and opened.

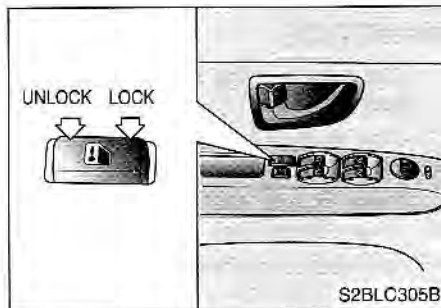

Central Door Locks (If equipped)

- Pressing the front portion of the door lock switch will automatically lock all the doors and rear hatch.
- Pressing the rear portion of the door lock switch will automatically unlock all the doors and rear hatch.
- If you lock/unlock the driver door or the passenger door with a key, all the doors and rear hatch will automatically lock/unlock. (When unlocking the driver door with a key, refer to "Two turn unlock system" on page 3-3.)

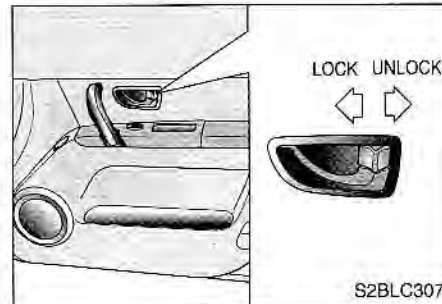

- If you lock/unlock the passenger door with the manual door lock, all the doors and rear hatch will automatically lock/unlock.
- If you lock/unlock the driver door with the manual door lock, only the driver door will lock/unlock.

The door ajar warning light will illuminate when a door is not fully closed. Close the door completely and the light will go out.

*** NOTICE**

If the airbag deploys, all doors will unlock automatically.

⚠ WARNING - Unattended Children

An enclosed vehicle can become extremely hot, causing death or severe injury to unattended children or animals who cannot escape the vehicle. Furthermore, children might operate features of the vehicle that could injure them, or they could encounter other harm, possibly from someone gaining entry to the vehicle. Never leave children or animals unattended in your vehicle.

⚠ CAUTION

The doors should always be fully closed and locked while the vehicle is in motion to prevent accidental opening of the door.

Locked doors will also discourage potential intruders when the vehicle stops or slows.

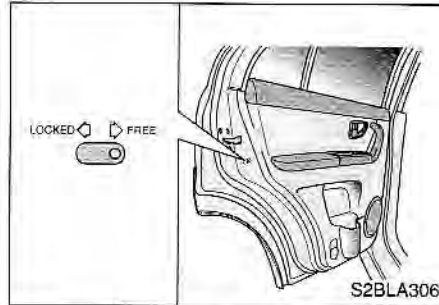

Rear Door Child Safety Lock

The child safety lock prevents children from opening the rear doors from the inside. It should be used whenever children are in the vehicle. To lock, push the child safety lock to the "LOCKED" position.

- To lock a rear door so that it cannot be opened from the inside, push the child safety lock located on the rear edge of the door to the "LOCKED" position before closing the door.
- To open a rear door while the child safety lock is engaged, push the door lock button to the "UNLOCK" position (red mark is visible) then pull the outside door handle.

⚠ WARNING - Rear Door Locks

If children accidentally open the rear doors while the vehicle is in motion, the child could fall out and be seriously injured. To prevent a child from opening the rear doors from the inside, the rear door safety locks should be used whenever children are in the vehicle.

WINDOWS

Power Windows

The ignition switch must be in the ON position for power windows to operate. Each door has a power window switch that controls that door's window. However, the driver has a power window switch which can block the operation of the passenger windows.

* NOTICE

To prevent the possibility of damage to the power window system, do not open or close more than two windows at the same time. This will also ensure the longevity of the fuse.

⚠ WARNING - Windows

- Do not allow children to play with the power windows. They may seriously injure themselves or others.
- Always double check to make sure all arms, hands, and other obstructions are safely out of the way before closing a window.

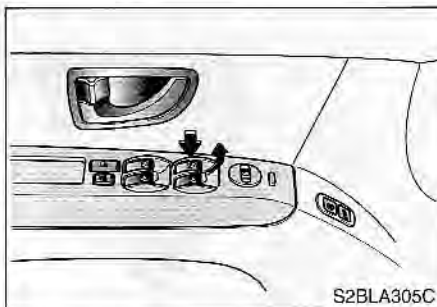

Driver's Door Power Window Controls

The driver's door has a master power window switch that controls all the windows in the vehicle. The ignition switch must be in the ON position for power windows to operate. To open a window, press down on the front portion of the corresponding switch. To close a window, pull up on the front portion of the corresponding power window switch.

Driver's Window Automatic-down Window Switch

The driver's window has an "Automatic-Down" feature. To activate the express-down feature, momentarily depress the front of the switch to the second detent position. To cancel this feature, pull up on the front of the switch and then release it or momentarily depress the front of the switch to the first detent position.

Power Window Timer (If equipped)

The power windows can be operated for approximately 30 seconds after the ignition key is removed or turned to the ACC or LOCK position. However, if the front doors are opened, the power windows cannot be operated unless ignition switch is ON.

Driver's Power Window Switch

The driver's power window switch provides two (2) separate window-down functions.

- Depressing the driver's power window switch completely lowers the driver's window automatically (Automatic-Down). To cancel this function, pull up on the front of the switch and release it or momentarily depress the front of the switch to the first detent position.
- Depressing the driver's power window switch partially (to the first detent) provides precise control of the window-down position. To raise/close the driver's window, pull up on the power window switch.

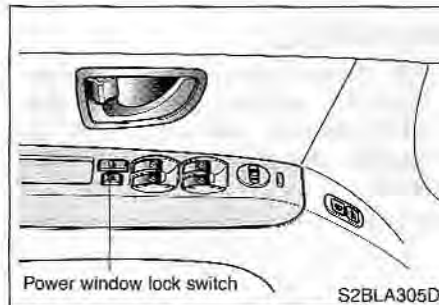

Power Window Lock Switch Feature

The driver can disable the power window switches on a passenger door by depressing the power window lock switch located on the driver's door to ON. When the power window lock switch is ON, the driver's master control can not operate the passenger door power windows either.

⚠ WARNING

- Power Windows

- **Keep the driver's door power window lock switch in the ON (depressed) position, except when someone is operating a passenger door window. Serious injury can result (especially to children) from unintentional window operation.**
- **Always double check to make sure all arms, hands, and other obstructions are safely out of the way before closing a window.**

*** NOTICE**

If you notice buffeting and pulsation (wind shock) with either side window open, you should open the opposite window slightly to reduce the condition.

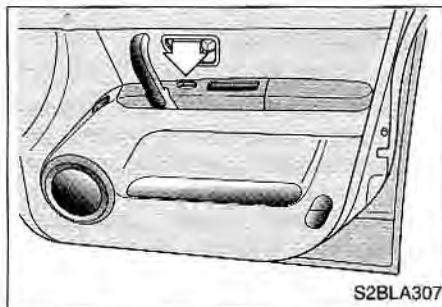

Passenger Doors Power Window Controls

To open a window, press down on the front portion of the power window switch. To close a window, pull up on the front portion of the power window switch.

* NOTICE

The driver's door power window "LOCK" switch must be in the OFF position (not depressed) to operate the passenger door windows.

FRONT SEAT

⚠ WARNING - Driver's Seat

- Adjusting the driver's seat with the vehicle in motion could cause loss of control and a serious accident.
- Do not allow anything to interfere with the normal position of the seatback. Storing items against a seatback or in any other way interfering with proper locking of a seatback could result in serious or fatal injury in a sudden stop or collision.
- Always drive and ride with your seatback upright and the lap portion of the safety belt, or lap belt, snug and low across the hips. This position puts your safety belts in the best position to protect you in case of an accident.

(Continued)

(Continued)

- The Canadian Motor Vehicle Safety Standards (CMVSS) recommends that the driver sit at least 10 inches (250 mm) away from the steering wheel to avoid the risk of serious injury or death due to the deployment of the driver's airbag.

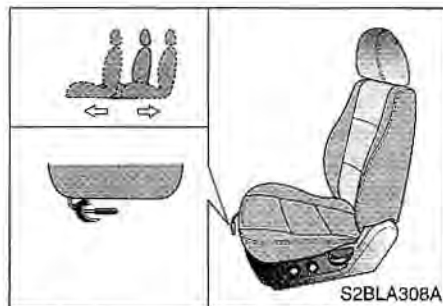

Front Seat Adjustment - Manual

Moving the Front Seat Forward and Backward

To move the seat forward or backward, pull up on the lever under the front edge of the seat cushion, slide the seat to the desired position, and release the lever. To ensure the seat is locked in position, check for any seat movement.

CAUTION

Loose objects in the driver's foot area could interfere with the operation of the foot pedals, possibly causing an accident. Loose objects might interfere with the seat slide mechanism. Do not place anything under the front seats.

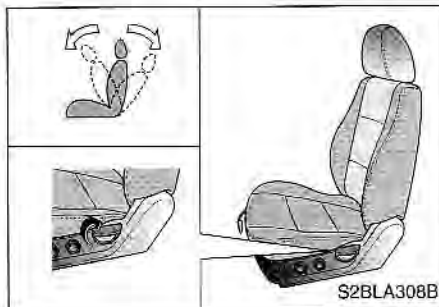

Adjusting the Front Seatback Recliner

To change the seatback angle, lean forward slightly and raise the lever located on the outer portion of the seat. Slowly and carefully lean back to the desired angle and release the lever. After adjustment, make sure that the lever has returned to its original locked position.

WARNING - Front Seat

Riding in a vehicle with a front seatback reclined could lead to serious or fatal injury in an accident. If a front seat is reclined, the occupant's hips may slide under the lap portion of the safety belt applying great force to the unprotected abdomen. Internal injuries could result. Keep the seatbacks in a comfortably upright position whenever the vehicle is in motion.



To change the height (rear portion) of the seat cushion, rotate the knob located on the outside of the seat cushion.

- To lower the seat cushion, rotate the knob toward the front of the vehicle.
- To raise the seat cushion, rotate the knob toward the rear of the vehicle.

Adjusting the Height of Driver Seat Cushion

To change the height (front portion) of the seat cushion, rotate the knob located on the outside of the seat cushion.

- To lower the seat cushion, rotate the knob toward the front of the vehicle.
- To raise the seat cushion, rotate the knob toward the rear of the vehicle.

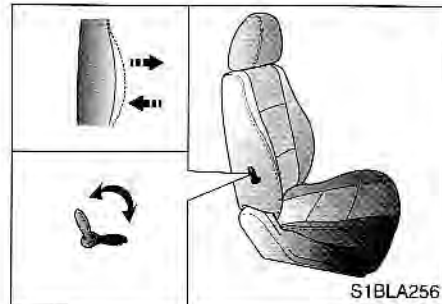

Lumbar Support (Driver's Seat Only)

You can adjust the lumbar support by moving the lever on the right side of the driver's seatback. Pivoting the lever increases or decreases the lumbar support.

Driver Seat Adjustment - Power (If equipped)

The driver seat can be adjusted by using the control knob on the outside of the seat. Before driving, adjust the seat to the proper position so as to easily control the steering wheel, pedals and switches on the instrument panel.

CAUTION

Do not operate two knobs at the same time.

WARNING - Driver's Seat

- Never attempt to adjust seat while the vehicle is moving. This could result in loss of control, and an accident causing death, serious injury, or property damage.

(Continued)

(Continued)

- In order to avoid unnecessary airbag injuries including the possibility of severe injury or death, always sit as far back as possible from the steering wheel while still being able to maintain comfortable control of your vehicle.
- The Canadian Motor Vehicle Safety Standards (CMVSS) recommends that the driver sit at least 10 inches (250 mm) away from the steering wheel to avoid the risk of serious injury or death due to the deployment of the driver's airbag.
- The power seats are operable with the ignition OFF. Therefore, children should never be left unattended in the car.

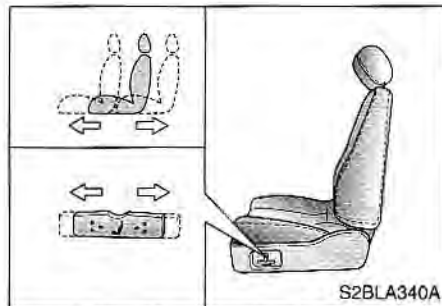

Moving the Front Seat Forward and Backward

Push the control knob forward or backward to move the seat to the desired position. Release the knob and the seat will lock in that position.

*** NOTICE**

Prior to operating the vehicle, ensure the seat is locked securely by trying to move the seat forward or backward without using the control knob. If the seat moves, it is not locked properly.

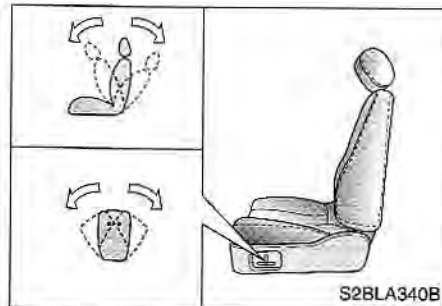

Adjusting the Front Seatback Recliner

Rotate the upper portion of the control knob forward or backward to recline the seatback to the desired position. Release the control knob and the seatback will lock in position.

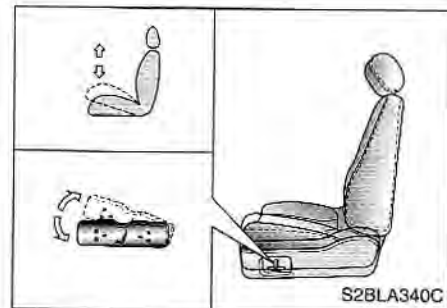

Adjusting the Height of Front Seat Cushion

Front height of front seat cushion

Move the front portion of the control knob up to raise or down to lower the front part of the seat cushion.

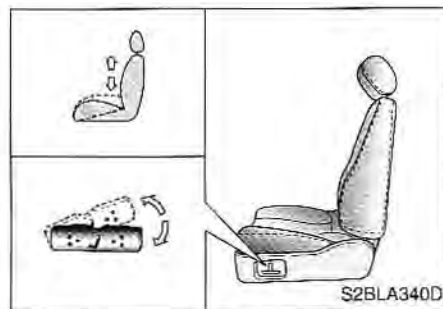

Rear height of front seat cushion

Move the rear portion of the control knob up to raise or down to lower the rear part of the seat cushion.

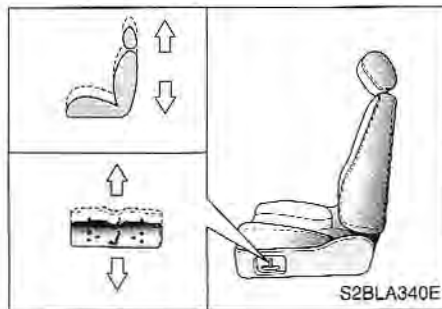

Height of front seat cushion

To raise or lower the seat cushion totally, pull up and push down on the center of the corresponding switch.

⚠ WARNING

To minimize the risk of possible severe personal injury in the event of a collision, both the driver's and passenger's seatbacks should be in a normal seating position while the car is in motion. The protection provided by the vehicle's restraint system may be reduced significantly when the seatbacks are reclined. All parts of the restraint system are designed to absorb energy in an accident and this can best be accomplished if the seatback is in a normal seating position and the seatbelt is in close proximity to the occupant.

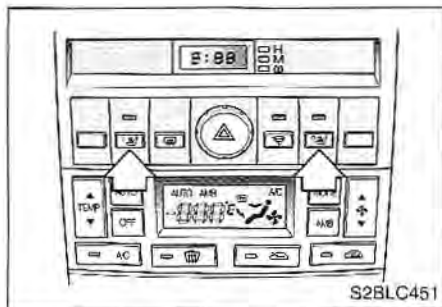

Heating the Front Seats (If equipped)

The front seats can be electrically heated individually when the ignition switch is ON. To heat one of the front seats, depress the corresponding switch on the center panel. To deactivate the seat heater, press the switch again.

* NOTICE

The seat warmer will not operate if ambient temperature is above $37\pm 3^{\circ}\text{C}$ ($98.5\pm 5.5^{\circ}\text{F}$).

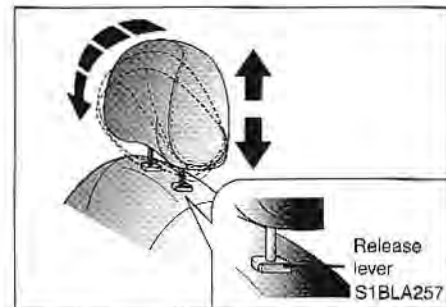

Headrest

All the seat headrests provide comfort and also help protect your head and neck in the event of certain kinds of collisions.

Hold the headrest and pull up to raise it. It will lock into position. To lower the headrest, push the lock lever on the left side and push down on the headrest.

If your vehicle is equipped with the headrest swing feature, the front headrests may be adjusted forward to four positions by pulling it forward. To adjust the headrest backwards, pull it forward and release it.

⚠ WARNING - Headrests

- **To reduce the risk of head and neck injuries, don't operate the vehicle with the headrest removed or improperly positioned.**
- **For best protection, adjust the headrest so its center is as high as your ears.**
- **Do not adjust the driver's headrest while driving.**

REAR SEAT

▲ WARNING**- Rear Seatback**

- The rear seatback must be securely latched. If not, passengers and objects could be thrown forward resulting in serious injury or death in the event of a sudden stop or collision.
- Luggage and other cargo should be laid flat in the cargo area. If objects are large, heavy, or must be piled, they must be secured. Under no circumstances should cargo be piled higher than the seatbacks. Failure to follow these warnings could result in serious injury or death in the event of a sudden stop, collision or rollover.

(Continued)

(Continued)

- No passenger should ride in the cargo area or sit or lie on folded seatbacks while the vehicle is moving. All passengers must be in seats and restrained properly while riding.
- When resetting the seatback to the upright position, make sure it is securely latched by pushing it forward and backwards.
- To avoid the possibility of burns, do not remove the carpet in the cargo area. Emission controls beneath this floor generate high exhaust temperatures.

**Split Folding Rear Seat**

The rear seatbacks fold forward to provide additional cargo space and to provide access to the cargo area.

- To fold the rear seatback(s) down, press the lock release button located on top of the seatbacks, then fold the seatback forward and down.
- To raise the seatback, lift and push it firmly until it clicks into place.
- When you return the seatback to its upright position, reposition the rear safety belts so that they can be used by rear seat passengers.

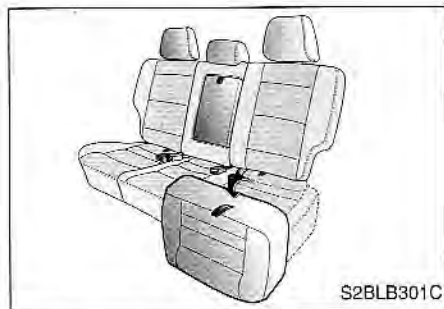

To fold the rear seat:

1. Pull up the strap to lift the rear portion of the seat cushion.

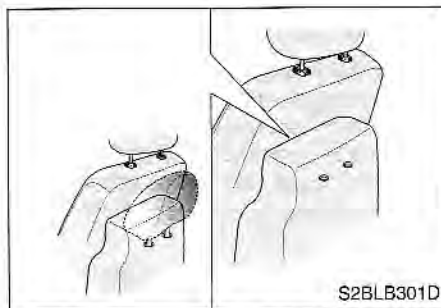

2. Remove the headrest and put the headrest poles into the holes on the rear of the seat cushion.

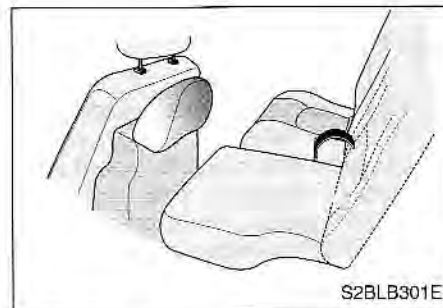

3. Press the lock release button on the seatbacks, then fold the seatback forward and down firmly.

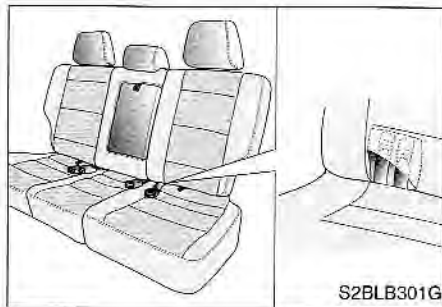

To unfold the rear seat:

1. Lift and push the seatback backward firmly until it clicks into place.
2. Replace the headrest on the seatback.
3. Push the seat cushion down firmly.

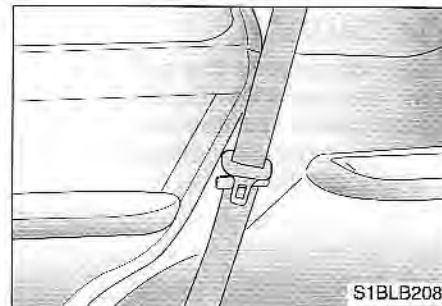

CAUTION

When you fold the rear seatback or put luggage on the rear seat cushion, you must insert the buckle into the pocket in the seatback. Doing so can prevent the buckle from being crushed by the rear seatback or luggage.

*** NOTICE**

When returning the rear seatbacks to the upright position, remember to return the rear shoulder belts to their proper position. Routing the safety belt webbing through the rear safety belt guides will help keep the belts from being trapped behind or under the seats.

CAUTION

Do not remove the floor carpet in your vehicle. Emission control system components cause high exhaust temperatures under the floor.

WARNING - Cargo

Cargo should always be secured to prevent it from shifting and causing injury to the vehicle occupants.



Center Armrest

This armrest is located in the center of the rear seatback. Pull the armrest down using the strap provided on the armrest.

SAFETY BELTS

**Pre-tensioner Seat Belt**

Your vehicle is equipped with driver's and front passenger's pre-tensioner safety belts. The purpose of the pre-tensioner is to pull the safety belt snugly against the occupant's body in certain frontal collisions.

The pre-tensioner safety belts will activate, along with the airbags, when a frontal collision is severe enough.

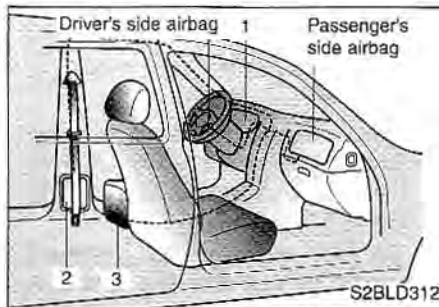

When the vehicle stops suddenly, or if the occupant tries to lean forward too quickly, the seat belt retractor will lock into position. However, in certain frontal collisions, the pre-tensioner will also activate and pull the seat belt into tighter contact against the occupant's body.

The safety belt pre-tensioner system consists mainly of the following components.

Their locations are shown in the illustration.

1. SRS airbag warning light.
2. Seat belt pre-tensioner assembly.
3. SRS control module.

⚠ WARNING

To obtain maximum benefit from a pre-tensioner, safety belt must be worn correctly.

CAUTION

- *When the pre-tensioner safety belts are activated, a loud noise may be heard and fine powder, which may appear to be smoke, may be visible in the passenger compartment. The powder is not toxic.*
- *The powder may cause skin irritation and should not be breathed for prolonged periods. Wash your hands and face thoroughly after an accident in which such powder has been released.*
- *If the pre-tensioner seat belt is not working properly, the airbag warning light will illuminate, since both devices are on the same electrical circuit. If the SRS airbag warning light does not blink when the ignition key is turned to "ON" or "ACC", or if it remains illuminated for more than 6 seconds, or if it illuminates while the vehicle is being driven, please have an authorized Kia dealer inspect the system as soon as possible.*

WARNING

- Pretensioner Repair or Replacement

- **Pre-tensioners are designed to operate once. After activation, pre-tensioner safety belts must be replaced.**
- **Do not attempt to inspect, repair or replace the pre-tensioner safety belts yourself. You can permanently damage the system.**

Safety Belt Restraint System

WARNING - Safety Belts

To minimize the risk of serious or fatal injury in an accident, the driver and all passengers should use the appropriate safety restraints for their age and size. The presence of airbags does not change the need to be properly restrained by a safety belt or size-appropriate child restraint. In fact, airbags can work properly when passengers are correctly restrained in the vehicle. Be sure you are familiar with the information in this section, including the information on infant and child restraints. Read the safety warnings on the sun visors.

We strongly recommend that the driver and all passengers be properly restrained at all times by using the safety belts provided with the vehicle. Proper use of the safety belts decreases the risk of severe injury or death in accidents or sudden stops. In most states, and in Canada, the law requires their use.

Inertial locks in the safety belt retractors allow all of the lap/shoulder safety belts to remain unlocked during normal vehicle operation.

This allows the occupants some freedom of movement and increased comfort while using the safety belts. If a force is applied to the vehicle, such as a strong stop, a sharp turn, or a collision, the safety belt retractors will automatically lock the safety belts.

Since the inertial locks do not require a collision to lock up, you may become aware of the safety belts locking while braking or going around sharp corners.

Whenever possible, use the center rear seat position to install your child restraint. The center rear seat is the safest position for a child to sit in. If the center seat is unavailable, a child restraint system may be installed in an outboard rear seat position. Never install a rear-facing infant seat in the front passenger position, as an inflating airbag could cause serious or fatal injury to a child in that position.

The rear safety belts use a special auto-lock feature designed to allow a child restraint to be used in these positions without an added locking clip. They normally lock only under extreme or emergency conditions (emergency lock mode). However they can be adjusted so that they remain in fixed and locked when a child restraint system is placed in these positions. (Use this auto-lock mode only to secure a child restraint, never for passengers restrained by the safety belts.) Page 3-38 gives instructions on placing the safety belt in the auto lock mode.

The drivers safety belt can only operate in the emergency lock mode.

Safety belts provide the best restraint when:

- The seatback is upright
- The occupant is sitting upright (not slouched)
- The lap belt is snug across the hips
- The shoulder belt is snug across the chest
- The knees are straight forward

To help you remember to fasten your safety belt, a warning light will come on and a chime will sound. See Safety Belt Warning Light and Chime on page 3-30.

WARNING

- After a Collision

- Lap/shoulder belt assemblies may be stretched or damaged when subjected to the stress and forces of a collision.
- The entire restraint system should be inspected following any collision. All belts, retractors, anchors and hardware damaged by a collision should be replaced before the vehicle is operated again.

WARNING - Cargo Area

Passengers should never be allowed to ride in the cargo area of a vehicle. No safety belts are provided for the cargo area. Persons riding in the vehicle without a fastened safety belt are much more likely to suffer serious bodily injury or death during an accident.

WARNING - Twisted Belts

A twisted or jammed safety belt cannot restrain you properly. If you cannot untwist or unjam the safety belt, see your Kia dealer immediately. Never drive or ride with a twisted or jammed safety belt.

WARNING - Belt Use

Safety belts must be used correctly to work properly in an accident. Each seating position in your vehicle has a specific safety belt assembly that includes a buckle and tongue designed to be used together. For greatest effectiveness, follow these guidelines in using safety belts:

- Use the shoulder portion of the safety belt on the outside shoulder only. Never wear the shoulder portion under the arm.

(Continued)

(Continued)

- Never swing the safety belt around your neck to fit over the inside shoulder.
- Never wear the shoulder portion of the safety belt across the neck or face.
- Wear the lap portion as low as possible. Be sure that the lap belt fits snugly around the hips. never wear a lap belt or lap portion of a lap/shoulder belt over your waist; it should always go over the stronger area of your hips.
- Never use a single safety belt for more than one person.
- The seatbacks should always remain in a comfortable, upright position when the vehicle is moving.

⚠ WARNING**- Safety Belt Care**

- A damaged belt may not give you the protection you need in an accident.
- Inspect the safety belts periodically for excessive wear or damage. Pull out each belt fully and look for fraying, cuts, burns or other damage. Pull the safety belt out and let it retract a number of times. Make sure that the lap/shoulder belts return smoothly and easily into the retractor.
- Check the latches to make sure they latch and release without interference or delay.
- Never close the doors on any part of the lap or shoulder belt.
- Any belt not in good condition or in good working order should be promptly replaced.

⚠ CAUTION

Never close the doors on any part of the lap or shoulder belt. It can damage the safety belt or buckle which could increase the risk of injury in case of an accident.



Safety Belt Warning Light and Chime

If the driver's lap/shoulder belt is not fastened when the key is turned ON, the safety belt warning chime sounds for approximately 6 seconds and the safety belt warning light illuminates for approximately 6 seconds.



Front and Rear Outboard Lap/Shoulder Belt

To fasten the lap/shoulder belt:

1. Grasp the buckle and tongue plate.
2. Slowly pull the lap/shoulder belt out from the retractor.



3. Insert the tongue plate into the open end of the buckle until an audible "click" is heard, indicating the belt is locked in the buckle.

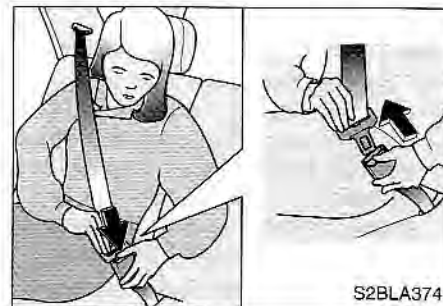
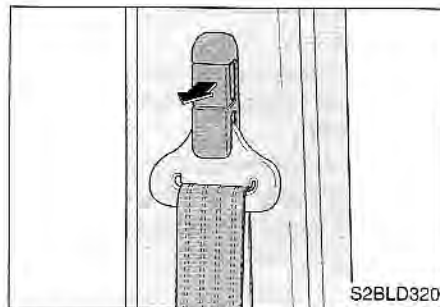
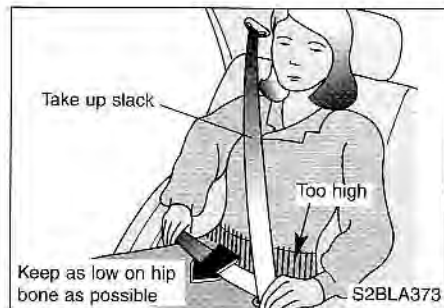

4. Position the lap portion of the belt across your lap as **LOW ON THE HIPS** as possible to reduce the risk of sliding under it during an accident. Adjust the belt to a **SNUG FIT** by pulling up on the shoulder portion of the safety belt. The belt retractor is designed to take up excess webbing automatically and to maintain tension on the belt. For maximum safety, do not put any excess slack into the safety belt.

5. Adjust the shoulder anchor position to your size. To raise the anchor position, push the anchor up. To lower the anchor position, press the button and slide the anchor down. After adjustment, make sure the anchor is locked in position.

To unfasten the lap/shoulder belt:
Press the release button on the buckle and allow the belt to slowly retract.

⚠ WARNING - Safety Belts

- The seatbacks should always remain in a comfortable, upright position while the vehicle is in motion. The safety belt system will provide the most protection with the seatbacks in an upright position.
- Never wear the shoulder portion of the safety belt under the outside arm or behind the back.
- Never wear the shoulder portion of the safety belt across the neck or face.
- Wear the lap portion of the safety belt as low as possible. Be sure the lap belt fits snugly around the hips. Never wear the lap belt over your waist.
- Make sure the safety belts are not twisted while in use.

(Continued)

(Continued)

- Never use a single belt to restrain more than one person at a time.

Failure to follow these warnings will increase the chance and severity of injury in an accident.



3 Point Rear Center Belt (If equipped)

To fasten the rear center belt

1. Slowly pull the tongue plates out from the retractor.

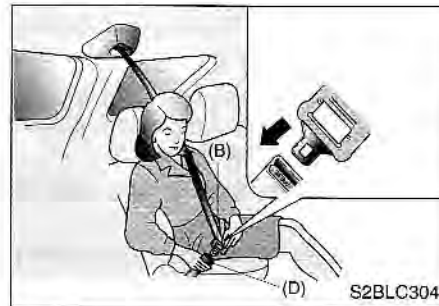
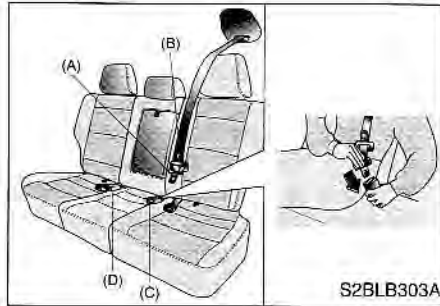

2. Insert the tongue plate (A) into the open end of the buckle (C) until an audible “click” is heard, indicating the latch is locked. Make sure the belt is not twisted.

3. Pull the tongue plate (B) and insert the tongue plate into the open end of the buckle (D) until an audible “click” is heard, indicating the latch is locked. Make sure the belt is not twisted.

There will be an audible “click” when the tab locks in the buckle. The seat belt automatically adjusts to the proper length only after the lap belt is adjusted manually so that it fits snugly around your hips, if you lean forward in a slow, easy motion, the belt will extend and let you move around. If there is a sudden stop or impact, the belt will lock into position. It will also lock if you try to lean forward too quickly.

▲ WARNING

When using the rear seat center belt, you must lock all tongue plates and buckles. If any tongue plate or buckle is not locked, it will increase the chance of injury in the event of collision.

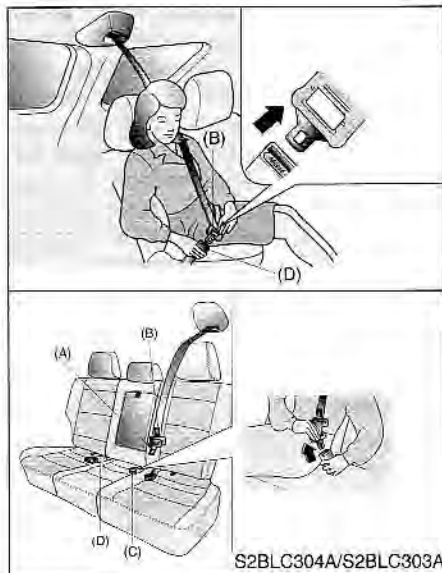

Proper Use and Care of the Safety Belt System

To ensure that the safety belts provide the maximum protection, please follow these instructions:

- Use the belts at all times - even on short trips.
- If the safety belt is twisted, straighten it prior to use.
- Keep sharp edges and damaging objects away from the belt.
- Periodically inspect belt webbing, anchors, buckles, and all other parts for signs of wear, and damage. Replace damaged, excessively worn or questionable parts immediately.

- To clean the belt webbing, use a mild soap solution recommended for cleaning upholstery or carpets. Follow the instructions provided with the soap. Do not bleach or dye the webbing because this may weaken the webbing fibers and allow them to fail when loaded in a collision.
- Do not make modifications or additions to the safety belt.
- After wearing a safety belt, make sure it fully retracts to the stowed position. Do not allow the belt to get caught in the door when you close it.

To unfasten the rear center belt

1. Press the release button on the buckle (D) and remove the tongue plate (B) from the buckle (D).
2. Press the release button on the buckle (C) and remove the tongue plate (A) from the buckle (C).

The belt webbing will retract automatically.

Restraint of Pregnant Women

Pregnant women should wear lap/shoulder belt assemblies whenever possible according to specific recommendations by their doctors. The lap portion of the belt should be worn **AS SNUGLY AND AS LOW AS POSSIBLE**.

▲ WARNING
- Pregnant Women

Pregnant women must never place the lap portion of the safety belt over the area of the abdomen where the fetus is located or above the abdomen.

Restraint of Infants and Small Children

To increase their safety, infants and young children should always be restrained by a restraint system approved for their age and size.

▲ WARNING
- Children on Lap

Never hold a child on your lap or in your arms in a moving vehicle. Even a very strong person cannot hold onto a child in the event of even a minor collision.

Many companies manufacture child-restraint systems (often called child seats) for infants and small children. An acceptable child-restraint system must always satisfy Motor Vehicle Safety Standards of your country. Make sure that any child-restraint system you use in your vehicle is labeled as complying with those safety standards.

The child restraint system should be chosen to fit both the size of the child and the size of the vehicle seat. Be sure to follow any instructions provided by the child restraint system manufacturer when installing the child-restraint system.

WARNING

- Infants and Young Children

- Infants and young children are at much greater risk of serious injury or death in an accident or sudden stop if they are unrestrained or restrained improperly. Follow all instructions in this section of your Kia manual and the instructions that came on and with an improved child safety restraint system. The child restraint must be correctly installed in the vehicle, and the child must be correctly installed in the child restraint.
- All children under 12 are safest in the back seat. The center rear position is best.
- Never install a child or infant seat in the front passenger position. The baby will be injured or killed by the airbag if it deploys in an accident.

(Continued)

(Continued)

- Never allow a child to stand or kneel on the seat of a moving vehicle. Insist the child sit down in an approved restraint system.
- Never allow a safety belt to be placed around both a child and an adult or around two children. In an accident they will not be properly restrained and may receive worse injuries from being thrown forward or crushed against one another.
- Never allow a child to be held on a lap or in anyone's arms while the vehicle is moving. Even a very strong person cannot hold onto a child in even a minor collision.
- A child too large for a child restraint but too small for the vehicle safety belts should use an approved belt-positioning booster seat. This is safer than allowing a child to ride with a shoulder belt that touches their face or neck.

WARNING

- Hot Metal Parts

Since a safety belt or child restraint system can become very hot in a closed vehicle during warm sunny weather, be sure to check the seat cover and buckles before placing a child anywhere near them.

Restraint of Large Children

As children grow, they may need to use new child restraints, including larger child seats or booster seats, which are appropriate for their increased size.

A child who has outgrown available child restraint systems should use the belts provided in the vehicle. When seated, the child should be restrained by the lap/shoulder belt.

If the shoulder belt slightly touches the child's neck or face, try placing the child closer to the center of the vehicle. If the shoulder belt still touches their face or neck, they may need to be returned to a child restraint system. In addition, aftermarket devices are available from independent manufacturers which help pull the shoulder belt lower and away from the child's face or neck.

Placement of a Child Restraint System

We recommend that, whenever possible, you put the child restraint in the center position of the rear seat.

If the center rear seat is not available, or you are using more than one child restraint system in the vehicle at the same time, the rear safety belts have been designed to allow a child restraint to be used in these positions. Since those safety belts normally lock only under extreme or emergency conditions (emergency lock mode) you must manually adjust those belts to the auto lock mode.

WARNING

When a child restraint is not in use, make sure that it is secured by a safety belt. In a sudden stop or accident, a loose child restraint could be thrown forward and injure someone.

*** NOTICE**

The driver's safety belt incorporates the emergency lock mode only.

WARNING

- Restraint Instructions

Failure to observe this manual's instructions regarding child restraint systems and the instructions provided with the child restraint system could increase the chance and/or severity of injury in an accident.



▲ WARNING

- Child Restraint Placement

Never use a child restraint in the front passenger seat. In a collision the air bag inflates with great force. A child in a restraint in the front passenger seat can be severely or fatally injured by the power of the air bag.



Installing a child restraint system in the rear center seat

To install a child restraint system in the rear center seat, do the following:

1. Pull the safety belt webbing and insert the tongue plate into the buckle.
2. Do the same procedure in the rear outboard seat on page 3-38.

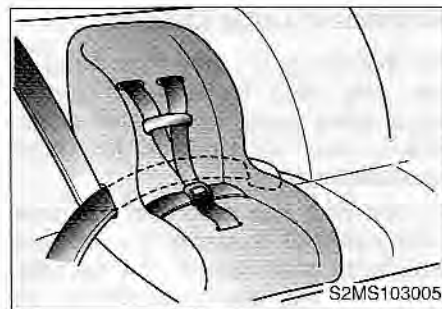

Placing a passenger safety belt into the auto lock mode

The use of the auto lock mode will ensure that the normal movement of the child in the vehicle does not cause the safety belt to be pulled out and loosen the firmness of its hold on the child restraint system.

To secure a child restraint in the rear outboard seats, follow the procedure below.

1. Place the child restraint system in the seat and route the lap/shoulder belt around or through the restraint, following the restraint manufacturer's instructions. Be sure the safety belt webbing is not twisted.



2. Fasten the lap/shoulder belt latch into the buckle. Listen for the distinct "click" sound.

Position the release button so that it is easy to access in case of an emergency.



3. Pull the shoulder portion of the safety belt all the way out. When the shoulder portion of the safety belt is fully extended, it will shift the retractor to the "Auto Lock" (child restraint) mode.



4. Slowly allow the belt to retract. Pull up on the shoulder webbing. A "clicking" or "ratcheting" sound will be heard as the belt retracts. This indicates the retractor is now in the automatic locking mode. Push down on the child restraint while you pull up on the belt in order to remove any slack in the belt.



5. Before placing the child in the child restraint, forcibly try to push the seat from side to side and forward to make sure that the seat is securely held in place.
6. Double check that the retractor is in the automatic locking mode by trying to pull the shoulder portion of the safety belt out of the retractor. If you cannot pull the belt out of the retractor, it is in the automatic locking mode. If you can, repeat step 4.

To remove the child restraint, press the release button on the buckle and then pull the lap/shoulder belt out of the restraint and allow the safety belt to retract fully.

⚠ WARNING - Auto Lock Mode

The lap/shoulder belt automatically returns to the “emergency lock mode” whenever the belt is allowed to retract fully. Therefore, the preceding seven steps must be followed each time a child restraint is installed.

If the safety belt is not placed in the “auto lock” mode, severe injury or death could occur to the child and/or other occupants in the vehicle in a collision, since the child restraint will not be effectively held in place.

*** NOTICE**

When the safety belt is allowed to retract to its fully stowed position, the retractor will automatically switch from the “Auto Lock” mode to the emergency lock mode for normal adult usage.

Child restraint anchor position

For small children and babies, the use of a child seat or infant seat is strongly recommended. This child seat or infant seat should be of appropriate size for the child and should be installed in accordance with the manufacturer's instructions. It is further recommended that the seat be placed in the vehicle's rear seat since this can make an important contribution to safety. Your vehicle is provided with three child restraint hook holders on the floor behind the rear seat for installing the child seat or infant seat.

⚠ WARNING - Child Restraint Placement

Never use a child restraint in the front passenger seat. A child in a child restraint installed in the front passenger seat can be severely or fatally injured by an air bag which could impact the child restraint with great force when the air bag inflates.

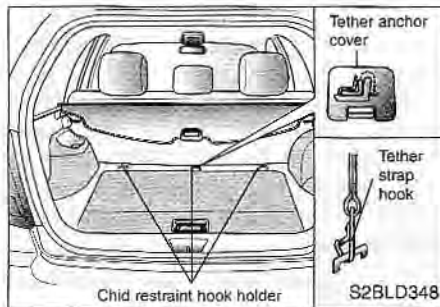

Tether anchor installation

Your vehicle is equipped with an anchor for securing the tether strap of a child restraint system (child seat). The child restraint anchor fittings are installed on the floor behind the rear seat.

▲ WARNING

If the tether strap is clipped incorrectly, the child restraint seat may not be restrained properly in the event of a collision.

Installing a Child Restraint seat :

1. Position the child restraint seat on the rear passenger seat cushion.
2. Route the child restraint seat tether strap over the back of the seat.

For vehicles with adjustable head restraints, route the tether strap under the head restraint and between the head restraint posts, otherwise route the tether strap over the top of the seatback.

3. Locate the correct anchor on the floor behind the rear seat for the selected seating position.
4. Open the tether anchor cover.
5. Clip the tether strap hook to the tether strap hook holder.
6. Tighten the tether strap to secure the seat.

▲ WARNING

- Child Restraint

Check that the child restraint system is secure by pushing and pulling it in different directions. Incorrectly fitted child restraints may swing, twist, tip or come away causing death or injury.

▲ WARNING

- Child Restraint Anchorage

- Child restraint anchorages are designed to withstand only those loads imposed by correctly fitted child restraints. Under no circumstances are they to be used for adult seat belts or harnesses or for attaching other items or equipment to the vehicle.
- The tether strap may not work properly if attached somewhere other than the correct tether anchor.

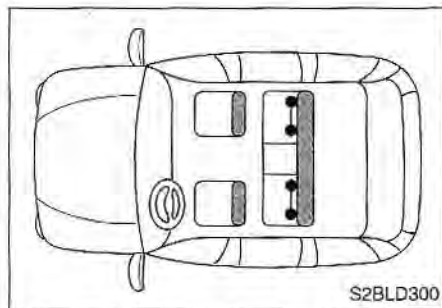

Child seat lower anchors

Some child seat manufacturers make child restraint seats that are labeled as ISOFIX or ISOFIX-compatible child restraint seats. These seats include two rigid or webbing mounted attachments that connect to two ISOFIX anchors at specific seating positions in your vehicle. This type of child restraint seat eliminates the need to use seat belts to attach the child seat for forward-facing child restraint seats.

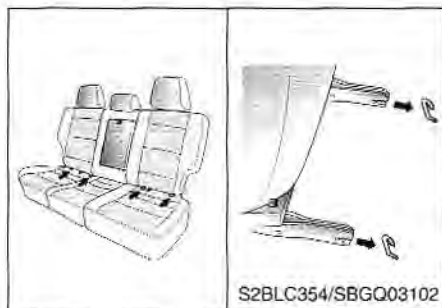

ISOFIX anchors have been provided in your vehicle. The ISOFIX anchors are located in the left and right outboard rear seating positions. Their locations are shown in the illustration. There is no ISOFIX anchor provided for the center rear seating position.

The ISOFIX anchors are located between the seatback and the seat cushion of the rear seat left and right outboard seating positions.

Follow the child seat manufacturer's instructions to properly install child restraint seats with ISOFIX or ISOFIX-compatible attachments.

Once you have installed the ISOFIX child restraint, assure that the seat is properly attached to the ISOFIX and tether anchors. Also, test the child restraint seat before you place the child in it. Tilt the seat from side to side. Also try to tug the seat forward. Check to see if the anchors hold the seat in place.

⚠ WARNING

If the child restraint is not anchored properly, the risk of a child being seriously injured or killed in a collision greatly increases.

⚠ WARNING

- **Do not mount more than one child restraint to a single tether or to a child restraint lower anchorage point. The improper increased load may cause the anchorage points or tether anchor to break, causing serious injury or death.**

(Continued)

(Continued)

- Do not install a child restraint seat at the rear center seating position using the vehicle's ISOFIX anchors. The ISOFIX anchors are only provided for the left and right outboard rear seating positions. Do not misuse the ISOFIX anchors by attempting to attach a child restraint seat in the middle rear seating position to the ISOFIX anchors. In a crash, the child restraint seat ISOFIX attachments may not be strong enough to secure the child restraint seat improperly in the rear center seating position and may break, causing serious injury or death.
- Attach the ISOFIX or ISOFIX-compatible child restraint seat only to the appropriate locations shown in the illustration.
- Always follow the installation and use instructions provided by the manufacturer of the child restraint.

AIR BAG - SUPPLEMENTAL RESTRAINT SYSTEM

What Your Air Bag System Does

Your vehicle is equipped with a Supplemental Restraint System (SRS), which includes an airbag for the driver, another airbag for the front seat passenger and side curtain airbags. The airbag for the driver is in the steering wheel and is designed to help restrain the forward movement of the driver head and chest in certain frontal collisions. The passenger airbag is designed to help restrain the forward movement of the passenger head and chest in certain frontal collisions. The side curtain airbags help to supplement the protection offered by the safety belt and side impact beams in side collisions.

What your air bag system does not do

The air bag system is designed to supplement or add to the protection offered by the safety belt system. It is not a substitute for the safety belt.

Why didn't my air bag go off in a collision?

There are many types of accidents in which the air bag would not be expected to provide additional protection. These include side or rear impacts, rollovers, and second or third collisions in multiple-impact accidents, as well as low speed impacts. However, the side curtain airbag can provide additional protection in certain side impact collisions.

Remember, the front air bags are only designed to inflate when the impact would throw the occupant into the air bags - generally from an area a little to the left to a little to the right of straight ahead and the side curtain airbags usually inflate in certain side impact collisions - generally from a little to forward to a little to the rear of both sides of the vehicle.

In other words, just because your vehicle is damaged and even if it is totally unusable, don't be surprised that the air bags did not inflate.

* NOTICE

Your vehicle's dual-level airbags use special sensors that are integrated with the front seat buckles. The point at which the airbag deploys is determined by whether or not the seat belt is being used, as well as the severity of the collision. Collisions can occur where only one of the airbags deploys.

If the impact is less severe, but severe enough to present a clear injury risk, the dual-level airbags are triggered at just 70% of their total capacity. If the impact is more severe, the dual-level airbags are triggered at full capacity.

The Importance of Using Safety Belts

There are four very important reasons to use safety belts even with an air bag supplemental restraint system. They:

- help keep you in the proper position (away from the air bag) when it inflates.
- reduce the risk of harm in rollover, side or rear impact collisions, because an air bag is not designed to inflate in such situations and even a side curtain airbag is designed to inflate only in certain side impact collisions.
- reduce the risk of harm in frontal or side collisions which are not severe enough to actuate the air bag supplemental restraint system.
- reduce the risk of being thrown from your vehicle.

⚠ WARNING**- Air Bags & Safety Belts**

- Even in vehicles with air bags, you and your passengers must always wear the safety belts provided in order to minimize the risk and severity of injury in the event of a collision or rollover.
- Always wear your safety belt. It can help keep you away from the air bags during heavy braking just before a collision.
- Front air bags are designed to inflate only in certain frontal collisions and will generally not provide protection in side or rear impacts, rollovers or less severe frontal collisions. Even the side air bags are designed to inflate only in certain side impact collision. They will not provide protection from later impacts in a multi-impact collision.

(Continued)

(Continued)

- If your vehicle has been subjected to flood conditions (e.g. soaked carpeting/standing water on the floor of the vehicle, etc.) or if your vehicle has become flood damaged in any way, do not attempt to start the vehicle or put the key in the ignition before disconnecting the battery. This may cause air bag deployment, which could result in serious personal injury or death. Have the vehicle towed to an authorized Kia dealer for inspection and necessary repairs.

Air Bag System Components

The main components of your SRS are:

- An air bag in the steering wheel.
- A second air bag in the passenger's side dashboard.
- Third air bags in both sides of the headliner.
- A diagnostic system that continually monitors system operation.
- An indicator light to warn you of a possible problem with the system.
- Emergency power backup in case the electrical system in your car is disconnected in a crash.



To indicate that your vehicle is equipped with driver's and passenger's side air bags, the air bag covers on the steering wheel, dashboard and on the pillar trim are marked "SRS AIR BAG."

How the Driver's Air Bag (SRS) Works

The driver's air bags are stored in the center of the steering wheel. The passenger's air bag is stored in the dashboard above the glove box.

In certain frontal collisions, your air bags will instantly inflate to help protect you from serious physical injury or death.

There is no single vehicle speed at which the air bags will inflate. Generally, air bags are designed to inflate in certain frontal collisions. The air bag Supplemental Restraint System (SRS) reacts to the severity of a collision and its direction. These two factors determine whether the sensors send out an electronic deployment/inflation signal. Whether the air bags will inflate depends on a number of factors including vehicle speeds, angles of impact and the density and stiffness of the vehicles or objects which your vehicle hits in the collision.

The air bags are designed to inflate instantly in the event of certain frontal collisions in order to help protect the driver and passenger from serious physical injury.

The front air bags will completely inflate and deflate in less than 1/10 of a second. The speed of inflation and deflation protects the driver's ability to operate the vehicle. This is important in crashes where a vehicle continues to move after an impact and the driver still has some control of the vehicle's steering, braking, throttle and/or transmission systems.

It is virtually impossible for you to see the air bags inflate during an accident. It is much more likely that you will simply see the deflated air bags hanging out of their storage compartments after the collision.

In order to help provide protection in a severe collision, the air bags must inflate rapidly. However, that speed also causes the air bags to expand with a great deal of force. The speed of this inflation has been determined by the Canadian Motor Vehicle Safety Standards (CMVSS) to reduce the likelihood of serious or life-threatening injuries and is thus a mandatory part of the air bag design.

However, air bag inflation can also cause injuries which normally can include facial abrasions, bruises and broken bones.



There are even circumstances under which contact with the steering wheel air bag can cause fatal injuries, especially if the occupant is positioned excessively close to the steering wheel.

⚠ WARNING

- Air Bag Injuries

- **You must always sit as far back from the steering wheel air bag as possible, while still maintaining a comfortable seating position for good vehicle control, in order to reduce the risk of injury or death in a collision.**
- **Never place objects over the air bag storage compartments or between the air bags and yourself. Due to the speed and force of the air bag inflation, such objects could hit your body at high speed and cause severe bodily injury and even death.**
- **Do not put stickers or ornaments on the steering wheel cover, dashboard and both sides of the headliner. These may interfere with the deployment of the air bag.**

Noise and Smoke

When the air bags inflate, they make a loud noise and they leave smoke and powder in the air inside of the vehicle. This is normal and is a result of the ignition of the air bag inflator.

After the air bags inflate, you may feel substantial discomfort in breathing due to the contact of your chest to both the safety belt and the air bag, as well as from breathing the smoke and powder.

We strongly urge you to open your doors and/or windows as promptly as possible after impact in order to reduce discomfort and prevent prolonged exposure to the smoke and powder.

⚠ WARNING

- Hot Metal Parts

When the air bags deploy, the air bag inflators in the steering wheel and/or below the dashboard and/or in both sides of the headliner over the rear quarter glasses are very hot. To prevent injury, do not touch the air bag storage areas internal components immediately after an air bag has inflated.



The Importance of the Passenger Being Properly Seated

The front seat passenger's air bag is much larger than the steering wheel air bag and inflates with considerably more force. It can seriously hurt or kill a passenger who is not in the proper position and wearing the safety belt properly. The front passenger should always move their seat as far back as practical and sit back in their seat.

It is essential that the front passenger always wear their safety belt, even when the vehicle is moving in a parking lot or up a driveway into a garage. The reason for this is that in most frontal impacts, the occupants are thrown forward. If the right front passenger is not wearing their safety belt, they will be directly in front of the storage compartment when inflation occurs. In that situation, serious injury or death is possible.

⚠ WARNING

- Right Front Seat

Pre-impact braking could throw an unbelted passenger toward or onto the air bag storage compartment. In the collision, the air bag would rapidly inflate and could severely injure or kill the unbelted occupant.

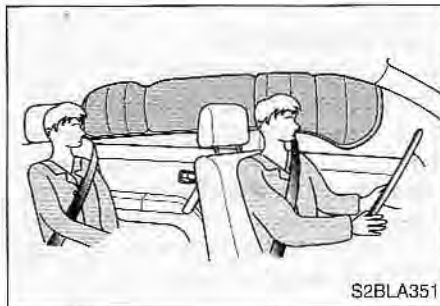

Side Airbag Curtain

This side curtain airbag system consists of inflatable curtains located along both sides of the roof rail, stretching from the rear edge of the rear side door windows to center of both front side windows. It is designed to help protect the heads of the front seat occupants and the rear outboard seat occupants in certain side impact collisions.

If the side curtain airbag deploys, it remains inflated for approximately 3 seconds.

Side curtain airbag deployment occurs only on the side of the vehicle affected by the impact.

▲ WARNING

- The side curtain airbags are not designed to deploy during collisions from the front or rear of the vehicle or in most rollover situations.
- Never try to open or repair any components of the side curtain airbag system. This should be done only by an Authorized Kia dealer.
- The side curtain airbags are designed to deploy only during certain side-impact collisions, depending on the crash severity, angle, speed and impact. The side curtain airbags are not designed to deploy in all side impact situations.

(Continued)

(Continued)

- In order for the side curtain airbag to provide its best protection, both front seat occupants and both outboard rear seat occupants should sit in an upright position with the seat belt properly fastened; adults using the seat belt and children using the proper child restraint system. Only adults should sit in the front seats. Children must never be allowed in the front passenger seat. Failure to follow these instructions can result in injury to the vehicle occupants in an accident.



W-26

Air Bag Warning Light

The purpose of the air bag warning light in your instrument panel is to alert you of a potential problem with your Air Bag - Supplemental Restraint System (SRS).

Have the system checked if:

- The light does not blink briefly when you turn the ignition ON.
- The light stays on after the engine starts.
- The light comes on while you are driving.



S2BLA358

Supplemental Restraint System Service

Your Supplemental Restraint System is virtually maintenance-free. There are no parts which you can service.

You must have the system serviced under the following circumstances:

- If an air bag ever inflates, the air bag must be replaced. Do not try to remove or discard the air bag by yourself. This must be done by an authorized Kia dealer.
- If the air bag warning indicator light alerts you to a problem, have the air bag system checked as soon as possible. Otherwise, your air bag may not perform properly.

⚠ WARNING - Air Bag (SRS) Malfunctions

- Do not modify your steering wheel or any other part of the Supplemental Restraint System. Modification could make the system ineffective.
- Do not work on the system's components or wiring. This could cause the air bags to inflate inadvertently, possibly seriously injuring someone. Working on the system could also disable the system so that the air bags would not deploy in a collision.

The SRS is virtually maintenance free and there are no parts you can safely service by yourself. The entire SRS system must be inspected by an authorized Kia dealer in 10 years after the vehicle manufacture date.

Any work on the SRS system, such as removing, installing, repairing, or any work on the steering wheel must be performed by a qualified Kia technician. Improper handling of the airbag system may result in serious personal injury.

ATTENTION!



SRS VEHICLE

THIS CAR IS EQUIPPED WITH A SUPPLEMENTAL RESTRAINT SYSTEM. TO PROVIDE CONTINUED RELIABILITY, CERTAIN ELEMENTS OF THE SUPPLEMENTAL RESTRAINT SYSTEM SHALL BE SERVICED OR REPLACED BY AUTHORIZED DEALER TEN YEARS AFTER VEHICLE MANUFACTURE DATE SHOWN ON CERTIFICATION LABEL. FOR FURTHER INFORMATION, SEE OWNER'S MANUAL



CURTAIN AIRBAG

THIS CAR IS EQUIPPED WITH A CURTAIN AIRBAG SYSTEM. TO PROVIDE CONTINUED RELIABILITY, CERTAIN ELEMENTS OF THE CURTAIN AIRBAG SYSTEM SHALL BE SERVICED OR REPLACED BY AUTHORIZED DEALER TEN YEARS AFTER VEHICLE MANUFACTURE DATE SHOWN ON CERTIFICATION LABEL. FOR FURTHER INFORMATION, SEE OWNER'S MANUAL



Airbag Warning Label

To remind you of the dangers of the airbag, airbag warning labels which are now required by the Canadian Motor Vehicle Safety Standards (CMVSS) are adhered to the driver's and passenger's sunvisors and attached to the glove box.

Note that these government warnings focus on the risk to children, Kia also wants you to be aware of the risks which adults are exposed to. Those have been described in previous pages.

REAR HATCH

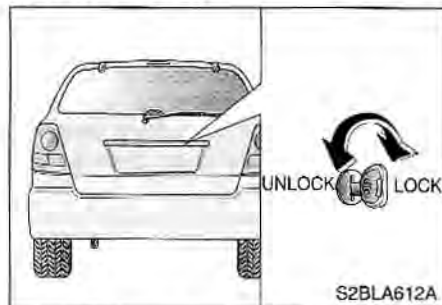

Opening the Rear Hatch

To open the rear hatch from the outside:

1. Insert the door key into the lock and turn it counterclockwise. You can also unlock the latch (but not release it) with the power door lock system.
2. Reach under the license plate light shield and pull the rear hatch handle to release the latch.



3. Pull the rear hatch back and up to open.

Make certain that you close the rear hatch door before driving your vehicle. Possible damage may occur to the rear hatch lift cylinders and attaching hardware if the rear hatch door is not closed prior to driving.

⚠ WARNING

The rear hatch swings upward. Make sure no objects or people are near the rear of the vehicle when opening the hatch.

⚠ WARNING - Rear Hatch

- Check to be sure the rear hatch is completely closed before driving. If the rear hatch is open, exhaust gases can enter the vehicle.
- Occupants should never ride in the rear cargo area where no restraints are available. To avoid injury in the event of an accident or sudden stops, occupants should always be properly restrained.

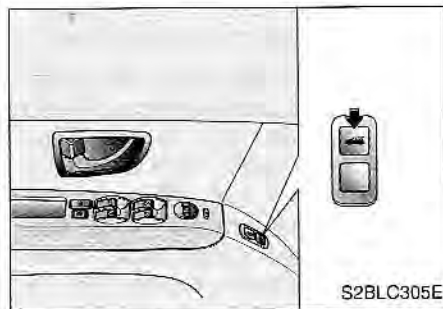

Opening the Rear Hatch Window

To open the rear hatch window, press the rear hatch window release button and raise the rear hatch window at the rear of the vehicle.

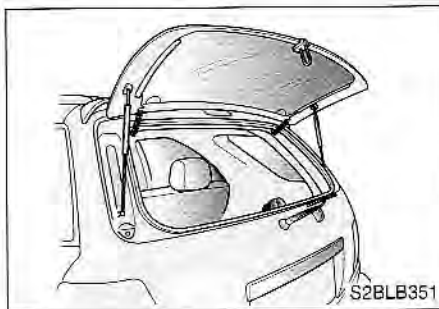

The window will raise completely by itself after it has been raised halfway.

To close the rear hatch window, lower and push down the rear hatch window firmly. Make sure that the rear hatch window is securely fastened.

You can also open the rear hatch window by inserting the key into the rear hatch key cylinder and turning the key to the right twice within 3 seconds and raising it.

* NOTICE

If the rear hatch window is left open or ajar, poisonous exhaust gases may enter the vehicle resulting in serious illness or damage to the occupants.

HOOD

**Opening the Hood:**

1. Pull the release lever on the lower left side of the instrument panel to unlatch the hood.

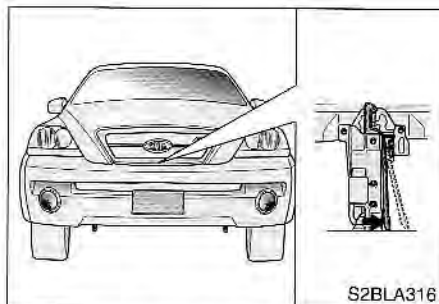

2. Go to the front of the vehicle, slightly raise the hood, push the secondary latch to the right and lift the hood.

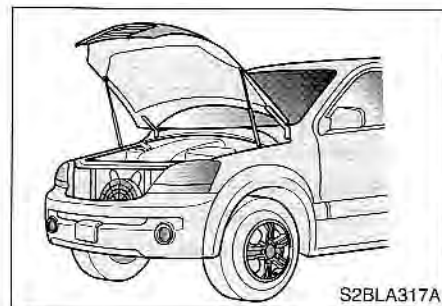

3. Raise the hood. It will raise completely by itself after it has been raised halfway.

Closing the Hood:

- Check the area under the hood to make certain all filler caps are in place and that all loose items have been removed.
- Lower the hood then push down to properly lock in place.
- Check to make sure the hood is closed.

⚠ WARNING

- **Before closing the hood, make sure that all engine parts and tools have been removed from the engine area and that no one's hands are near the hood opening.**
- **Do not leave gloves, rags or any other combustible material in the engine compartment. Doing so may cause a heat-induced fire.**

FUEL FILLER LID

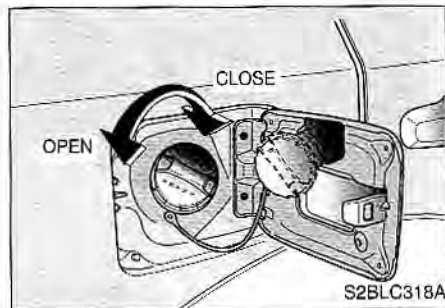

1. Pull the fuel filler lid out to open.
2. To remove the cap, turn it counter-clockwise.
3. Hold the cap on the hook to avoid damage on the surface of the vehicle.
4. Refuel the fuel tank.
5. To install the cap, place it on the fuel filler neck and turn it clockwise until it "CLICKS". This indicates that the cap is securely tightened.

⚠ WARNING - Refueling

- If pressurized fuel sprays out, it can cause serious injuries. Always remove the fuel cap carefully and slowly. If the cap is venting fuel or if you hear a hissing sound, wait until the condition stops before completely removing the cap.
- Fuel vapor is very hazardous and can explode. When refueling, always stop the engine. Never allow sparks or open flames near the filler neck. Always put out cigarettes and other smoking materials before refueling.
- Because your vehicle uses an ORVR (On-board Refuelling Vapor Recovery) system, "Top OFF" the vehicle very carefully to prevent fuel splash-back.

*** NOTICE**

- If the fuel filler cap requires replacement, use only a genuine Kia cap or the equivalent specified for your vehicle. An incorrect fuel filler cap can result in a serious malfunction of the fuel system or emission control system. Correct replacement caps are available at authorized Kia dealers.
- Do not spill fuel on the exterior surfaces of the vehicle. Any type of fuel spilled on painted surfaces may damage the paint.
- A loose fuel filler cap may cause the "Check Engine" light in the instrument panel to illuminate unnecessarily.
- If the fuel filler lid will not open in cold weather because the area around it is frozen, push or lightly tap the lid.

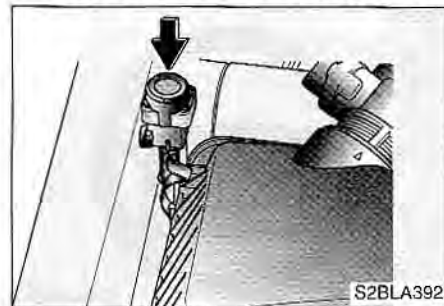
AUTO FUEL CUTOFF SWITCH

The auto fuel cutoff switch is located on the passenger's side of the engine compartment. In the event of a collision or sudden impact, the auto fuel cutoff device cuts off the fuel supply. If this device is activated, it must be reset by pressing in on the top of the switch before the engine can be restarted.

⚠ WARNING

Before resetting the auto fuel cutoff switch, the fuel line should be checked for fuel leaks.

STEERING WHEEL

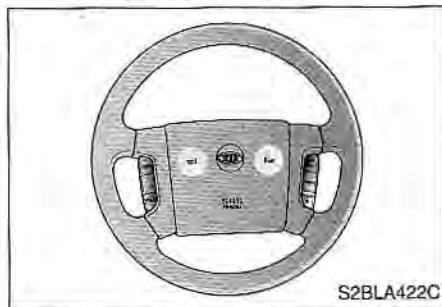

Horn

To sound the horn, press the horn symbol on your steering wheel.

Check the horn regularly to be sure it operates properly.

CAUTION

- *To sound the horn, press the area indicated by the horn symbol on your steering wheel (see illustration). The horn will operate only when this area is pressed.*
- *Do not strike the horn severely to operate it, or hit it with your fist. Do not press on the horn with a sharp-pointed object.*

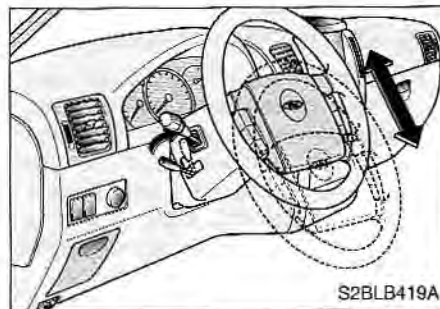

Tilt Steering (If equipped)

To change the steering wheel angle, pull the lock release lever, adjust the steering wheel to the desired angle, then release the lock release lever to lock the steering wheel in place. The steering wheel should be positioned so that it feels comfortable to you when driving, while permitting you to see the instrument panel warning lights and gauges.

⚠ WARNING - Tilt Steering

- Never adjust the position of the steering wheel while the vehicle is in motion, or you may lose control of the vehicle.
- After adjusting, push the steering wheel up and down to be certain it is locked in position.

MIRRORS

Outside Rearview Mirrors

Be sure to adjust mirror angles before driving.

▲ WARNING - Convex Mirror

The outside rearview mirrors are convex. Objects seen in the mirror are closer than they appear. When changing lanes, use your inside rearview mirror or direct observation to determine the actual distance of following vehicles.

*** NOTICE**

Do not scrape ice off the mirror face; this may damage the surface of the glass. If ice should restrict movement of the mirror, do not force the mirror for adjustment. To remove ice, use a de-icer spray, or a sponge or soft cloth with very warm water.

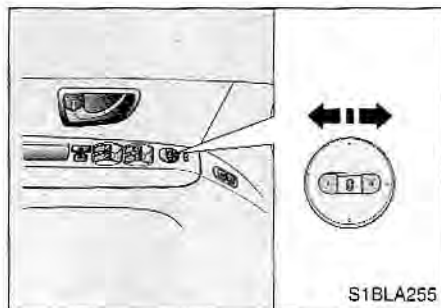

Electric Remote Control

The electric remote control mirror switch, located on the driver's door, allows you to adjust the position of the left and right outside rearview mirrors. To adjust the position of either mirror, move the lever to R or L to select the right side mirror or the left side mirror, then press a corresponding point on the mirror adjustment control to position the selected mirror up, down, left or right.

*** NOTICE**

The mirrors stop moving when they reach the maximum adjusting angles, but the motor continues to operate while the switch is depressed. Do not depress the switch longer than necessary, the motor may be damaged.

Outside Rearview Mirror Heater (If equipped)

The outside rearview mirror heater is actuated in conjunction with the rear window defroster. To heat the outside rearview mirror glass, push the switch for the rear window defroster.

The outside rearview mirror glass will be heated for defrosting or defogging and will give you improved rear vision in inclement weather conditions. Push the switch again to turn the heater off. The outside rearview mirror heater automatically turns itself off after 20 minutes.

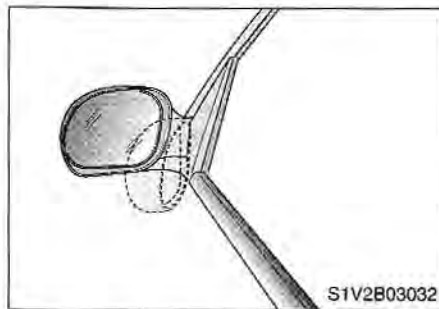

Folding the Outside Rearview mirror

To fold outside rearview mirror, grasp the housing of mirror and then fold it towards the rear of the vehicle.

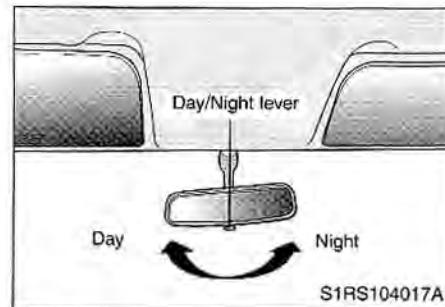

Day/Night Rearview Mirror

Manual type

Adjust the rearview mirror to center on the view through the rear window. Make this adjustment before you start driving and while the day/night lever is in the day position.

Pull the day/night lever toward you to reduce glare from the headlights of vehicles behind you during night driving. Remember that you lose some rearview clarity in the night position.



Electric type (if equipped)

The electric day/night rearview mirror automatically controls the glare from the headlights of the car behind you. Adjust the rearview mirror to the desired position.

CAUTION

Do not place objects in the rear seat or cargo area which would interfere with your vision out the rear window.

INTERIOR LIGHTS

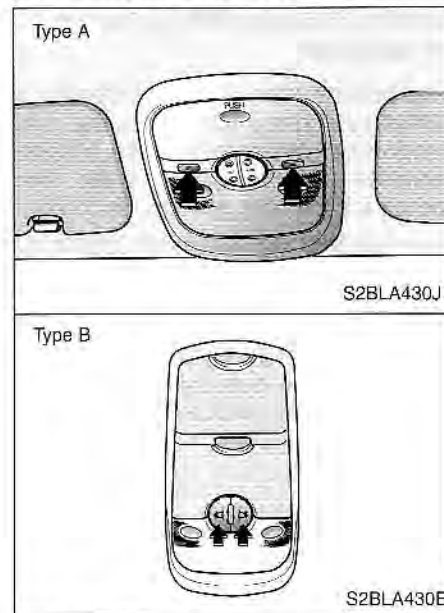

Map Light

The lights are switched ON or OFF by pressing the corresponding switches.

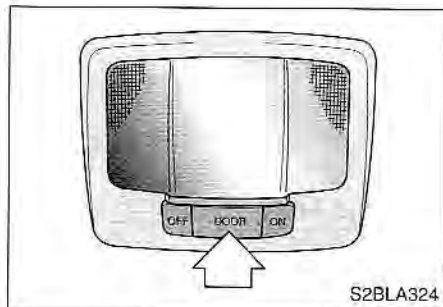

Dome Light

The dome light has three buttons:

OFF - The light stays OFF even when a door is open.

DOOR - The light turns ON or OFF when a door is opened or closed.

The light goes out gradually during 5~6 seconds after the door is closed.

ON - The light turns ON and stays on even when the doors are all closed.

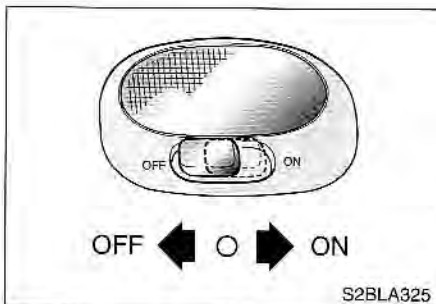

Rear Cargo Area Light

The switch has three positions:

OFF - The light stays off even when a door is open.

● - The light turns ON or OFF when a door is opened or closed.

The light goes out gradually during 5~6 seconds after the door is closed.

ON - The light turns ON and stays on even when the doors are all closed.

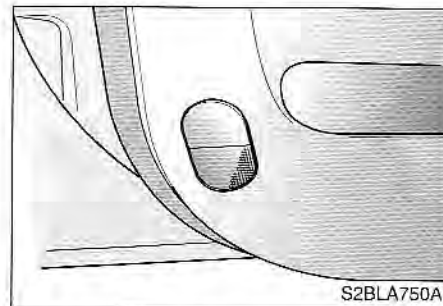

Door Courtesy Lamp

The door courtesy lamp comes ON when the door is opened to assist when you get in or out and also to warn passing vehicles.

CUP HOLDER

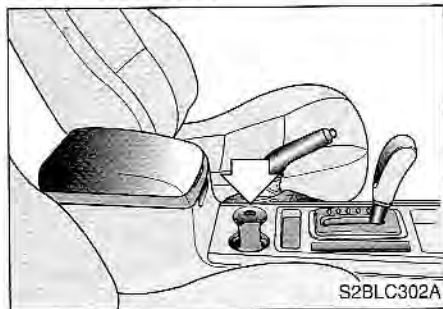

Front Cup Holder

A cup holder is located on the center console for holding cups.

⚠ WARNING - Hot Liquids

- Do not place uncovered cups of hot liquid in the cup holder while the vehicle is in motion. If the hot liquid spills, you could be burned. Such a burn to the driver could cause a loss of control of the vehicle.
- To reduce the risk of personal injury in the event of a sudden stop or collision, do not place uncovered or insecure bottles, glasses, cans, etc., in the cup holder while the vehicle is in motion.

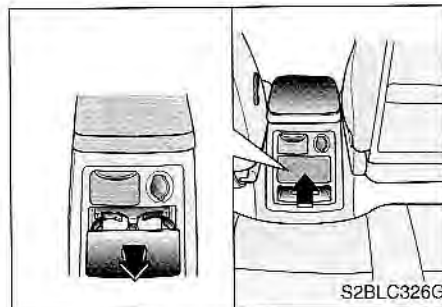

Rear Cup Holder

To use the rear cup holder, press the front face, release it and extend from the console box.

To return the cup holder to its closed position, push it completely into the console box. The cup holder latching mechanism will “click” when it is locked into position.

SUNGLASS HOLDER (IF EQUIPPED)



A compartment is provided at the overhead console to store sunglasses. To open the sunglasses holder, press the cover and the holder will slowly open. Place your sunglasses in the compartment door with the lenses facing out.

*** NOTICE**

Close the sunglasses holder while driving.

STORAGE COMPARTMENT

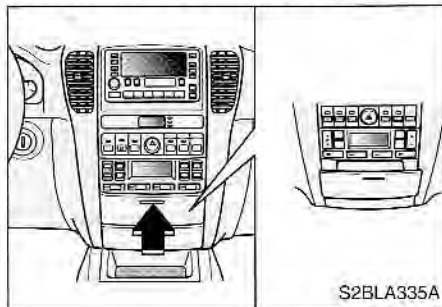

Center Tray

To use the storage compartment, press the front face, and then release it to allow the storage compartment to slowly extend from the instrument panel.

⚠ WARNING

Do not put gas lighters and other explosive materials in the vehicle. These may cause explosion if the vehicle is exposed for extended periods outside in hot weather.

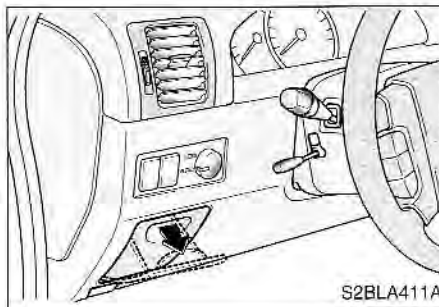

Multi Box

The multi box may be opened by pulling it out by its handle grip. It can be used for storing small items.

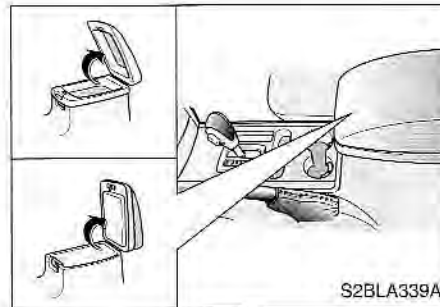

Center Console Storage

To use the console storage compartment, pull the cover up.

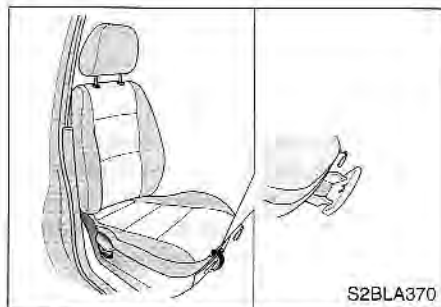

Under Tray (If equipped)

The under tray is located under the front passenger's seat and can be opened by pulling it out.

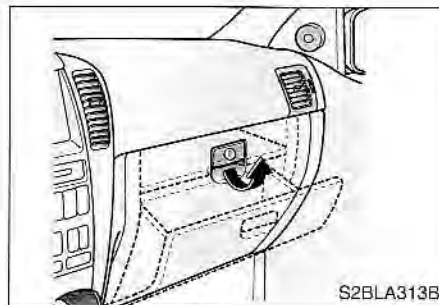

Glove Box

The glove box door can be locked or unlocked with a key.

To open the glove box door, pull the latch out and let the glove box open.

CAUTION

To reduce the risk of injury in case of an accident or sudden stop, always keep the glove box door closed while driving.

*** NOTICE**

To avoid possible theft, do not leave valuables in the glove box.

ELECTRICAL POWER OUTLET (IF EQUIPPED)

To plug in auxiliary electrical equipment, flip the outlet cover open from the edge of the cover and follow the proper installation instructions that are included with any electrical equipment you install. Maximum electrical draw must not exceed 10 ampere at 12 volts after engine is started.

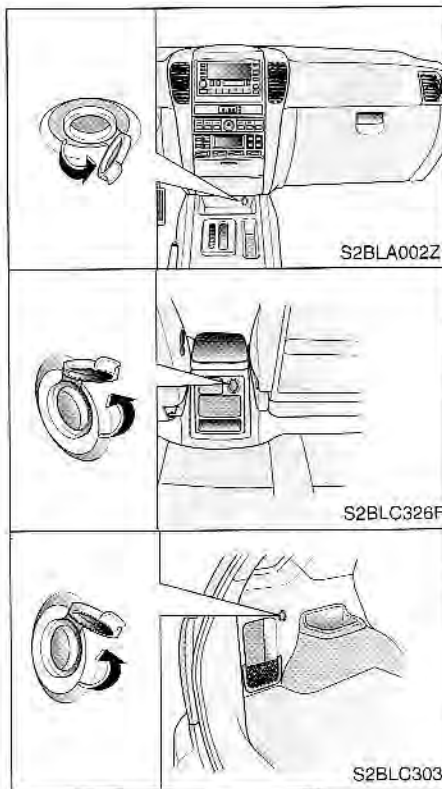

* NOTICE

- Only use the electrical power outlet with engine running.
- Adjust the air-conditioner or heater to the lowest operation level when you have to use the power socket while using air-conditioner or heater.
- If you have to use to the electrical accessories that draw higher power (vacuum cleaner, lights, cooler, etc.) only use the power outlet intermittently and with greater caution.
- Long periods of the vehicle not being started (with electrical accessories plugged in) will discharge the vehicle's battery and degrade the battery life.
- Cap the cover of power outlet when not in use.
- Some electronic devices can cause electronic interference and when plugged into a vehicle's power outlet. These devices may cause excessive audio static and malfunctions in other electronic systems or devices used in your vehicle.

SUNROOF (IF EQUIPPED)

If your vehicle is equipped with this feature, you can slide or tilt your sunroof with the sunroof switches located on the overhead console.



S2BLA430C

Sliding the Sunroof

The sunroof can be opened or closed when the ignition switch is in the "ON" position. To slide the sunroof, momentarily press "OPEN" (☰) on the SLIDE switch. The sunroof will slide all the way open. To stop the sunroof sliding at any point, press any sunroof switch. To close the sunroof, press "CLOSE" (☷) on the SLIDE switch and hold it until it is closed completely.

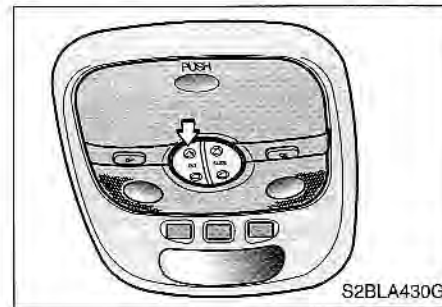

S2BLA430G

Tilting the Sunroof

To tilt the sunroof, momentarily press "UP" (☰) on the TILT switch. The sunroof will tilt all the way up. To stop the sunroof tilting at any point, press any sunroof switches.

To close it, press "DOWN" (☷) on the TILT switch and hold it until it is closed completely.

* NOTICE

The sunroof cannot slide when it is in the tilt position nor can it be tilted while in an open or slide position.

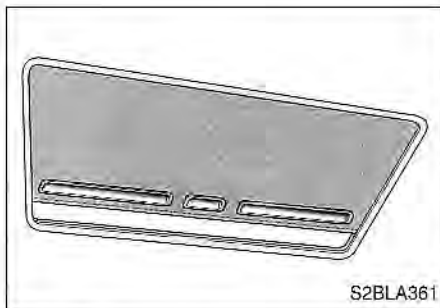

Sunshade

The sunshade will be opened with the glass panel automatically when the glass panel is slid. You will have to close it manually if you want it closed.

* NOTICE

- Do not depress the sunroof switch longer than necessary. It could cause the failure of the sunroof motor.
- Periodically remove any dirt that may accumulate on the guide rail.
- If you try to open the sunroof when the temperature is below freezing or when the sunroof is covered with snow or ice, the glass or the motor could be damaged.

In case of an Emergency

If the sunroof does not open electrically:

1. Remove the overhead console.
2. Insert the emergency handle (provided with the vehicle) and turn the handle clockwise to open or counterclockwise to close.

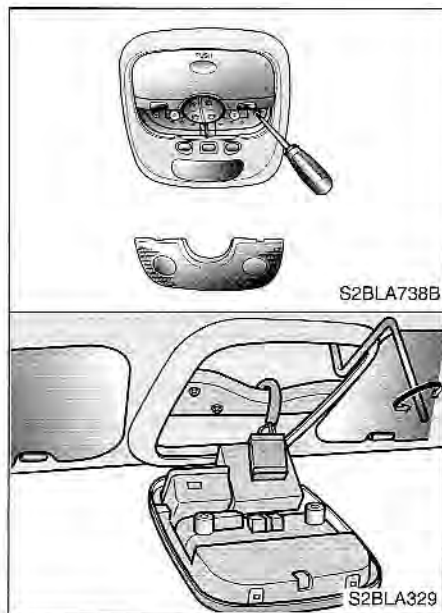

Resetting the Sunroof

When your battery happens to be disconnected or discharged, or you use the emergency handle to operate the sunroof, you have to reset your sunroof system as follows:

1. Turn the ignition key to the ON position
2. Tilt the sunroof up fully as follows:

Case A : When the sunroof has closed completely or been tilted:

Press the TILT UP button for 1 second then release it.

Case B : When the sunroof has slid open:

Press and hold the close button for more than 5 seconds until the sunroof has closed completely, then press the TILT UP button for 1 second and release it.

3. Press and hold the TILT UP button once again until the sunroof moves slightly and returns to the original TILT UP position.
4. Release the TILT Up button when the procedure is finished. The sunroof system is reset.

ANTENNA

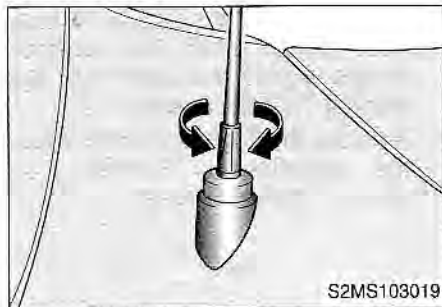

Fixed Rod Antenna

Your car uses a fixed rod antenna to receive both AM and FM broadcast signals.

This antenna is removable. To remove the antenna, turn it counter-clockwise. To install the antenna, turn it clockwise.

CAUTION

- *Be sure to remove the antenna before washing the car in an automatic car wash or it may be damaged.*
- *When reinstalling your antenna, it is important that it is fully tightened to ensure proper reception.*

LUGGAGE NET (IF EQUIPPED)



To keep items from shifting in the trunk, you can use the four rings located in the trunk to attach the cargo net.

CAUTION

Do not put fragile, bulky or excessive quantity of items into luggage net. They could be damaged.

WARNING

Avoid eye injury. DO NOT overstretch. ALWAYS keep face and body out of recoil path.

DO NOT use when strap has visible signs of wear or damage.

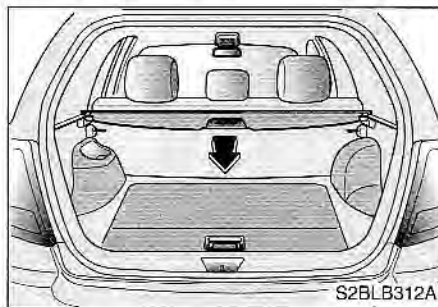
**TONNEAU COVER
(IF EQUIPPED)**

Use the tonneau cover to hide items stored in the cargo area.

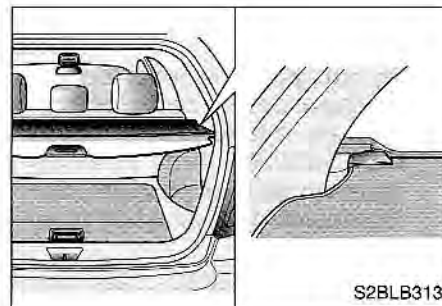

To use the tonneau cover, pull the handle backward and insert the edges into the slots of the slide rails.

CAUTION

- *Do not place objects on the tonneau cover. Such objects may be thrown about inside the vehicle and possibly injure vehicle occupants during an accident or when braking.*
- *Since the tonneau cover may be damaged or malformed, do not put the luggage on it when it is used.*
- *For better fuel economy, do not carry unnecessary weight.*
- *Never allow anyone to ride in the luggage compartment. It is designed for luggage only.*
- *Try to maintain the balance of the vehicle and locate the weight as far forward as possible.*

LUGGAGE CENTER BOX (IF EQUIPPED)

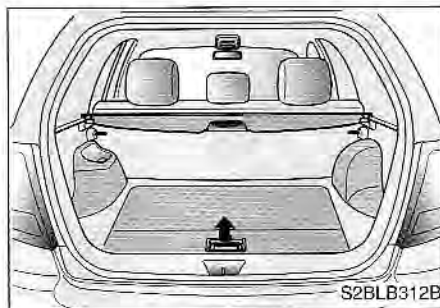

The luggage center box is located under the floor in cargo area. You can place a first aid kit, a reflector triangle, tools, etc. in the box for easy access.

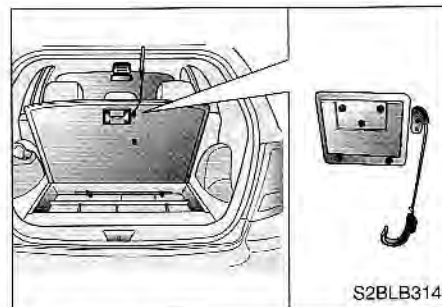

1. Grasp the handle on the top of the cover and lift it.
2. Detach the hook from the cover and hang it on the top edge of the roof.

To close the cover, hang the hook on the bottom of the cover.

ROOF RACK (IF EQUIPPED)

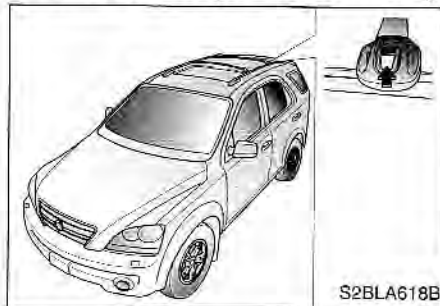

If the vehicle has a roof rack, you can load things on top of your vehicle. The two cross bars on the roof rack can be repositioned forward or rearward for conveniently loading cargo or luggage. With an assistant on the opposite side of the vehicle, press and hold the slider lock buttons on each side, then move the cross bar to the desired position. Release the buttons and lock the cross bar by moving the crossbar slightly forward or rearward.

* NOTICE

- The cross bars should be positioned before carrying a load on the roof rack.
- In case the sunroof is equipped, do not position roof rack loads that could interfere with opening of the sunroof.
- The following specification is maximum weight when loading cargo or luggage.

ROOF RACK	45 kg (100 lbs.) EVENLY DISTRIBUTED
-----------	--

- Loading cargo or luggage above 45 kg (100 lbs) on the roof rack may damage your vehicle.
When you carry large objects, never let them hang over the rear or the sides of your vehicle.
- To prevent damage or loss of cargo as you are driving, check frequently to make sure the luggage carrier and cargo are still securely fastened.
- Always drive your vehicle at a moderate speed.
- Loading cargo or luggage over specification on the roof rack may damage stability of your vehicle.

DRIVING YOUR VEHICLE

Ignition Switch	4-2
Starting the Gasoline Engine	4-4
Manual Transmission	4-7
Automatic Transmission	4-9
Four Wheel Drive(4WD)	4-15
Limited Slip Differential	4-24
Brake System	4-24
Power Steering	4-31
Cruise Control	4-32
Instrument Cluster	4-36
Gauges	4-37
Warnings and Indicators	4-39
Multi-Meter	4-46
Lighting	4-52
Wipers and Washers	4-56
Defroster	4-59
Hazard Warning Flasher	4-60
Interior Features	4-61
Manual Climate Control System	4-65
Automatic Climate Control System	4-72
Windshield Defrosting and Defogging (Manual type)	4-80
Windshield Defrosting and Defogging (Automatic type) ..	4-82

IGNITION SWITCH

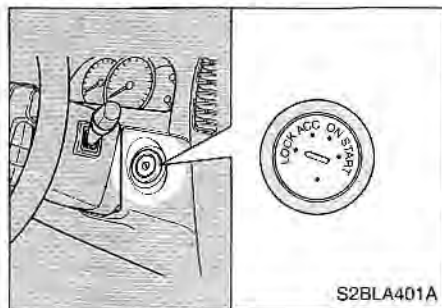

Illuminated Ignition Switch

Whenever a door is opened, the ignition switch will be illuminated for your convenience, provided the ignition switch is not in the ON position. The light will go off approximately 10 seconds after closing the door or when the ignition switch is turned on.

Ignition Switch and Anti-Theft Steering Column Lock

Ignition switch position

LOCK

The steering wheel locks to protect against theft. The ignition key can be removed only in the LOCK position. When turning the ignition switch to the LOCK position, push the key inward at the ACC position and turn the key toward the LOCK position.

ACC (Accessory)

The steering wheel is unlocked and electrical accessories are operative.

ON

The warning lights can be checked before the engine is started. This is the normal running position after the engine is started.

Do not leave the ignition switch ON if the engine is not running. The battery will discharge.

START

Turn the ignition key to the START position to start the engine. The engine will crank until you release the key; then it returns to the ON position. The brake warning lamp can be checked in this position.

If difficulty is experienced in turning the ignition key to the START position, turn the steering wheel right and left to release the tension and then turn the key.

*** NOTICE - Manual Transmission**

For your safety, the engine will not start if the clutch pedal is not fully depressed.

▲ WARNING - Ignition Key

- It is dangerous to turn the ignition switch to LOCK or ACC while the vehicle is moving. You could lose control of steering and braking.
- The anti-theft steering column lock (if equipped) is not a substitute for the parking brake. Before leaving the driver's seat, always make sure the shift lever is engaged in 1st gear for manual transmission, or P (Park) for automatic transmission. Set the parking brake fully AND shut the engine off. If you do not take these precautions, the vehicle may move suddenly and unexpectedly. Take the ignition key with you.

(Continued)

(Continued)

- Never reach through the steering wheel for the ignition switch or any other controls while the vehicle is moving. The presence of your hand or arm in this area could cause a loss of vehicle control, an accident and serious bodily injury or fatal injury.

Automatic Transaxle

When turning the ignition switch to the LOCK position, the shift lever must be in the P (Park) position.

Manual Transaxle

When turning the ignition switch to the LOCK position, push the key inward at the ACC position and turn the key toward the LOCK position.

1. Make sure the parking brake is applied.
2. **Manual Transmission** - Depress the clutch pedal fully and shift the transmission into Neutral. Keep the clutch pedal depressed while turning the ignition switch to the start position. The starter will not operate if the clutch pedal is not fully depressed.
Automatic Transmission - Place the transmission shift lever in P (Park) or N (Neutral). Depress the brake pedal fully.
3. While fully depressing the accelerator, turn the ignition switch to the START position and hold it (a maximum of 10 seconds) to discharge the excess fuel.

If the engine starts, the engine speed will increase suddenly; release the key and the accelerator immediately.

4. If the engine has not yet started, release the accelerator after cranking the engine. Without depressing the accelerator, crank the engine until it starts (a maximum of 10 seconds).

If the engine fails to start when the engine is warm:

A no-start condition, characterized by failure to restart a warmed engine despite repeated attempts may be eliminated by using the following procedure.

1. Make sure the parking brake is applied.
2. **Manual Transmission** - Depress the clutch pedal fully and shift the transmission into Neutral. Keep the clutch pedal depressed while turning the ignition switch to the start position. The starter will not operate if the clutch pedal is not fully depressed.

Automatic Transmission - Place the transmission shift lever in P (Park) or N (Neutral). Depress the brake pedal fully.

3. While depressing the accelerator about halfway, turn the ignition switch to the START position and hold it (a maximum of 10 seconds).
4. Let the engine idle for about 10 seconds before driving.

*** NOTICE**

Do not engage the starter for more than 10 seconds. If the engine stalls or fails to start, wait 5 to 10 seconds before re-engaging the starter. Improper use of the starter may damage it.

The starter will not operate if:

- Manual transmission - the clutch pedal is not fully depressed.
- Automatic transmission - the shift lever is NOT in the P (Park) or N (Neutral) position.

Excessive engine noise may occur if the engine has not been operated for an extended period. The noise should stop after the engine has reached normal operating temperature. If the noise does not stop, have the vehicle inspected by an authorized Kia dealer.

MANUAL TRANSMISSION (IF EQUIPPED)

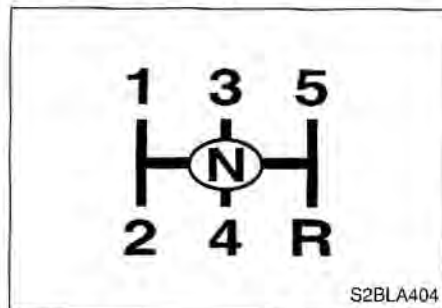

Manual Transmission Operation

The manual transmission has five forward gears.

Press the clutch pedal down fully while shifting, then release it slowly.

A special safety feature prevents inadvertent shifting from 5 (Fifth) to R (Reverse). The gearshift lever must be returned to the Neutral position before shifting into R (Reverse).

Make sure the vehicle is completely stopped before shifting into R (Reverse).

* NOTICE

To avoid premature clutch wear and damage, do not drive with your foot resting on the clutch pedal. Also, don't use the clutch to hold the vehicle stopped on an upgrade, while waiting for a traffic light, etc.

▲ WARNING - Manual Transmission

Before leaving the driver's seat, always set the parking brake fully and shut the engine off. Then make sure the transmission is shifted into 1st gear. Unexpected and sudden vehicle movement can occur if these precautions are not followed in the order identified.

Recommended Shift Speeds

The chart shows when to shift for smooth driving and best fuel economy.

This data has been obtained through tests. You are encouraged to follow this shift schedule.

Gear Position	Speeds - km/h (Mph)
1	0 - 21 (0 - 13)
2	21 - 40 (13 - 25)
3	40 - 60 (25 - 37)
4	40 - 80 (25 - 37)
5	over 72 (over 45)

You may have to upshift at higher speeds than those above if you need more power while you are driving on a hill or passing another vehicle.

However, never operate the engine with the tachometer (RPM) in the red area.

Downshifting

When you must slow down in heavy traffic or while driving up steep hills, downshift before the engine starts to "labor". Downshifting reduces the chance of stalling and gives better acceleration when you again need to increase your speed. When the vehicle is traveling down steep hills, downshifting helps maintain safe speed and prolongs brake life.

AUTOMATIC TRANSMISSION (IF EQUIPPED)

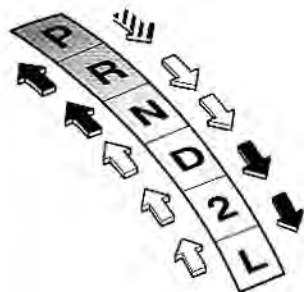

Normal transmission gear ranges are provided on the right side of the indicator.



To move the shift lever from the P position, the ignition switch must be in the ON position, the brake pedal must be depressed and the lock release button must be depressed.



The lock release button must be depressed while moving the shift lever.

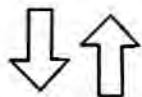

The shift lever can be moved without depressing the lock release button.

Lock release button

Prevents shift lever movement without first depressing the button.

O/D System

Pressing the button de-activates the O/D mode. Pressing again re-activates the O/D mode.

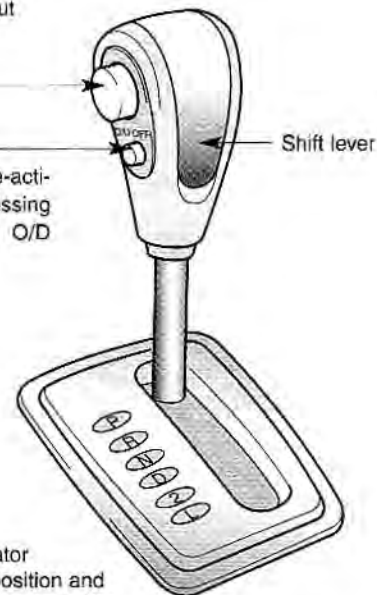

Shift pattern indicator shows shift lever position and gear range of the transmission.

S2BLC402B



Automatic Transmission Operation

The automatic transmission is electronically controlled.

All normal forward driving is done with the shift lever in the D (Drive) position.

To move the shift lever from the P (Park) position, the ignition switch must be in the ON position, the brake pedal must be depressed and the lock release button must be depressed.

For smooth operation, depress the brake pedal when shifting from N (Neutral) to a forward or reverse gear.

▲ WARNING - Automatic Transaxle

Before leaving the driver's seat, always make sure the shift lever is in the P (PARK) position; then set the parking brake fully and shut the engine off. Unexpected and sudden vehicle movement can occur if these precautions are not followed in the order identified.

*** NOTICE**

- To avoid damage to your transmission, do not accelerate the engine in R (Reverse) or any forward gear position with the brakes on.
- When stopped on an upgrade, do not hold the vehicle stationary with engine power. Use the service brake or the parking brake.
- Do not shift from N (Neutral) or P (Park) into L (Low), 2 (Second Gear), D (Drive), or R (Reverse) when the engine is above idle speed.

*** NOTICE**

If the Emission Control System Malfunction Indicator Light () flashes, it indicates an electrical problem with the transmission. Should this occur, have the vehicle checked by an Authorized Kia Dealer as soon as possible.

Shift Lock System

For your safety, the Automatic Transmission has a shift lock system which prevents shifting the transmission out of P (Park) unless the brake pedal is depressed.

To shift the transmission out of P (Park):

1. Depress and hold the brake pedal.
2. Start the engine or turn the ignition to the ON position.
3. Depress the lock release button and move the shift lever.

When the ignition switch is in the ACC or LOCK position, the transmission cannot be shifted from P (Park).

If the brake pedal is repeatedly depressed and released with the shift lever in the P (Park) position, a chattering noise near the shift lever may be heard. This is a normal condition.

Also, the ignition key cannot be removed unless the shift lever is in the P (Park) position. If the ignition switch is in any other position, the key cannot be removed.



S2BLA407

Transmission Ranges

O/D (OverDrive) System

Pressing the O/D system button cancels and engages the overdrive system. When the O/D system is cancelled (button is pressed), the O/D OFF indicator illuminates and the transmission gear range is limited to 1st through 3rd. The transmission will not shift to 4th gear until the O/D system button is pressed again to release the switch.

When driving down a sloping road with the transaxle in O/D (5th), you can decrease the vehicle speed without using the brakes by pressing the O/D OFF button.

When the ignition is switched OFF, O/D OFF mode is automatically cancelled.

O/D OFF indicator

This indicator light illuminates in the instrument panel when the O/D mode is cancelled.

*** NOTICE**

If the O/D OFF indicator flashes, it indicates an electrical problem with the transaxle. Should this occur, have the vehicle checked by an Authorized Kia Dealer as soon as possible.

P (Park)

This position locks the transmission and prevents the front wheels from rotating. Always come to a complete stop before shifting into this position.

▲ WARNING

- Shifting into P (Park) while the vehicle is in motion will cause the drive wheels to lock which will cause you to lose control of the vehicle.
- Do not use the P (Park) position in place of the parking brake. Always make sure the shift lever is latched in the P (Park) position so that it cannot be moved unless the lock release button is pushed in, AND set the parking brake fully.

(Continued)

(Continued)

- Before leaving the driver's seat, always make sure the shift lever is in the P (PARK) position. Set the parking brake fully, shut the engine off and take the key with you. Unexpected and sudden vehicle movement can occur if you do not follow these precautions in the order specified.
- Never leave a child unattended in a vehicle.

⚡ CAUTION

The transmission may be damaged if you shift into P (Park) while the vehicle is in motion.

R (Reverse)

Use this position to drive the vehicle backward.

*** NOTICE**

Always come to a complete stop before shifting into or out of R (Reverse); you may damage the transmission if you shift into R while the vehicle is in motion, except as explained in “Rocking the Vehicle”, in this manual.

D (Drive)

This is the normal forward driving position. The transmission will automatically shift through a four-gear sequence, providing the best economy and power.

For extra power when passing another vehicle or climbing grades, depress the accelerator fully, at which time the transmission will automatically downshift to the next lower gear.

2 (Second Gear)

Use 2 (Second Gear) for more power when climbing hills and for increased braking when going down hills. This position also helps reduce wheel spin on slippery surfaces. When the shift lever is placed in 2 (Second Gear), the transmission will automatically shift from first to second gear. Downshifting from second to first gear is possible below speeds of 26 miles per hour (43 km/h). Do not exceed 36 miles per hour (60 km/h) while in second gear.

N (Neutral)

With the gearshift in the N position, the wheels and transmission are not locked. The vehicle will roll freely even if the transfer case is in gear, unless the parking brake or service brakes are applied.

L (Low)

Move the shift lever to this position in hard pulling situations and for climbing steep grades. Do not exceed 22 miles per hour (35 km/h) while in Low.

*** NOTICE**

Do not exceed the recommended maximum speeds in 2 (Second Gear) or L (Low). Operating the vehicle at speeds above the maximum recommended, for these gears may cause excessive heat to develop which could result in damage to or failure of the automatic transmission.

Moving Up a Steep Grade From a Standing Start

To move up a steep grade from a standing start, depress the brake pedal, shift the shift lever to D (Drive), 2 (Second) or L (Low) depending on load weight and steepness of the grade, and release the parking brake. Depress the accelerator gradually while releasing the service brakes.

FOUR WHEEL DRIVE (4WD)

For Safe Four-Wheel Drive Operation

- Your vehicle allows you to drive in on-road and off-road conditions.
- However, do not try to drive in deep standing water, mud, or over steep hills.
- When you are driving up or down hills drive as close to straight up and down the hill as possible. Use extreme caution in going up or down steep hills, since you may flip your vehicle over depending on the grade, terrain and water/mud conditions.

▲ WARNING

- Four Wheel Drive

Driving across the contour of steep hills can be extremely dangerous. This danger can come from slight changes in the wheel angle which can destabilize the vehicle or, even if the vehicle is maintaining stability under power, it can lose that stability if the vehicle stops its forward motion. Your vehicle may roll over without warning and without time for you to correct a mistake that could cause serious injury or death.

- You must learn how to corner in a 4WD vehicle as soon as possible. Do not rely on your experience in conventional 2WD vehicles in choosing safe cornering speed. You must drive more slowly.
- Drive off-road carefully because your vehicle may be damaged by rocks or roots of trees. Become familiar with the off-road conditions you are going to drive before you start.

⚡ CAUTION

Do not grab inside of the steering wheel when you are driving off-road. Your arm may be hurt by a sudden steering maneuver or from steering wheel rebound due to impact with objects on the ground. This may cause you to lose steering wheel control.

⚠ WARNING

Reduce speed when you turn corners. The center of gravity of 4WD vehicles is higher than that of conventional 2WD vehicles, making them more likely to roll over when you turn corners too fast.

- Always hold the steering wheel firmly when you are driving off-road.
- Make sure all passengers are wearing seat belts.
- Do not drive in water if the level is higher than the bottom of the vehicle.
- Check your brake condition once you are out of mud or water. Press the brake pedal several times as you move slowly until you feel normal braking forces return.
- Shorten your scheduled maintenance interval if you drive in off-road conditions such as sand, mud or water (see "Scheduled Maintenance" in the Index). Always wash your car thoroughly.

⚠ CAUTION

If you are driving in heavy wind, the vehicle's higher center of gravity decreases your steering control capacity and requires you to drive more slowly.

⚠ WARNING

If you are driving too fast in water, the water spray can get into the engine compartment and wet the ignition system, causing your vehicle a sudden stop. If this happens and your vehicle is in a tilted position, your vehicle may roll over.

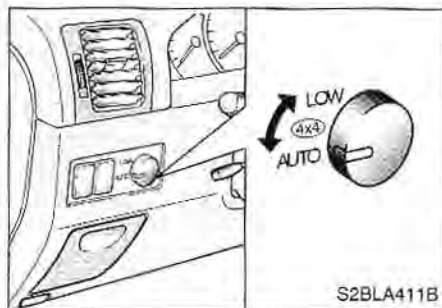

Full-Time 4WD Operation (If equipped)

When 4WD is selected with the transfer shift knob, the vehicle will switch to 4WD operation after a few seconds.

* NOTICE

When the vehicle shifts into 4WD mode, a slight mechanical sound and vibration may be felt and does not indicate a problem with the system.

To avoid shift shock, when the vehicle is stopped and you make a transfer case shift using the transfer shift knob, wait until the corresponding indicator light in the instrument cluster illuminates before driving.

Knob position

This is used to set different positions.

AUTO

Full power delivered to front and rear axle for increased traction. Use this mode for normal on-road driving.

LOW

Full power to both axles, including a lower gear ratio for low speed applications that require extra power such as wet pavement, snow-covered roads and/or off-road.

LOW Mode is not recommended on dry pavement.

The 4WD LOW indicator light () will be turned on to remind you that you are in the LOW mode.

Transfer shift knob operation

AUTO ↔ LOW

1. Stop the vehicle.
2. Depress the clutch pedal (Manual transmission) or put the shift lever into N (Neutral) position (Automatic transmission).

3. AUTO → LOW

: Turn the transfer shift knob to LOW mode.

LOW → AUTO

: Turn the transfer shift knob to AUTO mode.

4. Before releasing the clutch pedal (Manual Transmission) or shifting to other ranges from N (Automatic Transmission), wait for the corresponding indicator light in the instrument cluster to go ON or OFF.

CAUTION

If the vehicle moves while the transfer shift is in process, the gearbox may be damaged.

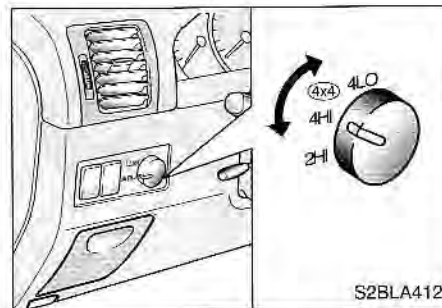

Part-Time 4WD Operation (If equipped)

You can send your engine's driving power to all front and rear wheels for maximum power.

Four-wheel drive is useful when you drive in snow, mud, ice or sand where good traction is required, or when your wheels lose traction using two-wheel drive.

When 4WD is selected with the transfer shift knob, the vehicle will switch to 4WD operation after a few seconds.

* NOTICE

When the vehicle shifts into 4WD mode, a slight mechanical sound and vibration may be felt and does not indicate a problem with the system.

To avoid shift shock, when the vehicle is stopped and you make a transfer case shift using the transfer shift knob, wait until the corresponding indicator light in the instrument cluster illuminates before driving.

* NOTICE

- Do not select four wheel drive on flat and normal roads.
- Four-wheel driving on flat roads for a long period causes poor fuel economy and noise and it also causes tires to wear faster.
- Four-wheel driving on flat and normal roads can result in a severe binding and chattering condition when turning the steering wheel.
- Four-wheel driving on flat roads for a long period can also cause the differential oil temperature to increase, resulting in damage to parts in the power train.

Knob position

This is used to set different positions.

2HI (Rear-wheel drive)

This mode is used, when driving on normal roads and highway.

4HI (High-range 4-wheel drive)

This mode is used, when driving off-roads, wet or snow covered roads with normal speed.

The 4WD indicator light () will be turned on to remind you that you are in the 4HI mode.

4LO (Low-range 4-wheel drive)

Use 4LO for climbing or descending hills, off-roads driving and towing the vehicle, especially when increased power is required.

The 4WD LOW indicator light () will be turned on to remind you that you are in the 4LO mode.

Transfer shift knob operation

By turning the transfer knob (4HI, 4LO), both front and rear axles are engaged.

This improves the traction characteristic.

2HI → 4HI

Turn the transfer knob from the 2HI mode to 4HI mode at speed below 80km/h.

It is not necessary to depress the clutch pedal or put the shift lever into N (Neutral) position (Manual Transmission) or put the shift lever into N (Neutral) position (Automatic Transmission).

Perform this operation when driving straight. There will be a few seconds of time delay before come into 4HI mode when you shift the knob to 4 HI from 2HI.

4HI → 2HI

Turn the transfer knob from the 4HI mode to the 2HI mode at speed below 80km/h. It is not necessary to depress the clutch pedal (manual transmission) or put the shift lever into N (Neutral) (automatic transmission). Perform this operation when driving straight. Perform this operation when driving straight.

If the transfer mode does not shift into 2HI mode when you turn the transfer knob to 2HI, drive straight ahead with accelerating or decelerating, or drive in reverse.

4HI ↔ 4LO

1. Stop the vehicle.
2. Depress the clutch pedal for the manual transmission or put the shift lever into N (Neutral) for the automatic transmission.
3. **4HI → 4LO**
: Select the 4LO mode.
4LO → 4HI
: Select the 4HI mode.
4. Before releasing the clutch pedal (Manual transmission) or shifting to other ranges from N range (Automatic transmission), wait for corresponding indicator light turns on or off in the cluster.

CAUTION

If the vehicle moves while the transfer shift is in process, the gearbox may be damaged.

For Safe Four-Wheel Drive Operation

- Your vehicle allows you to drive in on-road and off-road conditions.
- However, do not try to drive in deep standing water, mud, or over steep hills.

▲ WARNING - Four-Wheel Driving

The conditions on-road or off-road that demand four-wheel drive mean all functions of your vehicle are exposed to more extreme stress than under highway conditions. Slow down, look ahead, and be ready for sudden changes in the composition and traction of the surface under your tires. If you have any doubt about the safety of the conditions you are facing, stop and consider the best way to proceed. Do not exceed the ability of yourself or your vehicle to operate safely.

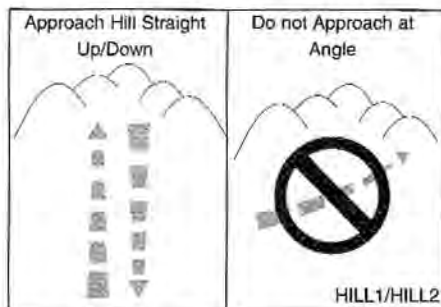

- When you are driving up or down hills, drive as close to straight up and down the hills as possible. Use extreme caution in going up or down steep hills, since you can flip your vehicle over depending on the grade, terrain and water/mud conditions.

▲ WARNING - Steep Hills

Driving across the contour of steep hills can be extremely dangerous. This danger can come from slight changes in the hill angle which can destabilize the vehicle. Even if the vehicle is maintaining stability under power, it can lose that stability if the vehicle stops its forward motion. Your vehicle may roll over without warning and without time for you to correct a mistake that could cause serious injury or death.

- You must learn how to corner in a 4WD vehicle as soon as possible. Do not rely on your experience in conventional 2WD vehicles in choosing a safe cornering speed. You must drive more slowly.

▲ WARNING - Turning Corners

Reduce speed when you turn corners. The center of gravity of 4WD vehicles is raised higher than that of conventional 2WD vehicles, making them more likely to roll over when you turn corners too fast.

- Drive off-road carefully because your vehicle may be damaged by rocks or roots of trees. Become familiar with the off-road conditions you are going to drive before you start.



▲ WARNING

Do not grab inside of the steering wheel when you are driving off-road. Your arm may be hurt by a sudden steering maneuver or from steering wheel rebound due to impact with objects on the ground. You could lose control of the steering wheel.

- Always hold the steering wheel firmly when you are driving off-road.
- Make sure all passengers are wearing seat belts.

▲ WARNING

If you are driving in heavy wind, the vehicle's higher center of gravity decreases your steering control. Drive more slowly than you would in calm conditions.

- If you need to drive in water, stop your vehicle, set your transfer lever to "4LO" or "LOW" and drive at less than 5 mph (8 km/h).

⚠ WARNING**- Driving Through Water**

If you are driving too fast in water, the water spray can get into the engine compartment and wet the ignition system, causing your vehicle to suddenly stop. If this happens and your vehicle is in a tilted position, your vehicle may roll over.

- Do not drive in water if the level is higher than the bottom of the wheel hubs.
- Check your brake condition once you are out of mud or water. Press the brake pedal several times as you move slowly until you feel normal braking forces return.
- Shorten your scheduled maintenance interval if you drive off-road in conditions such as sand, mud or water (see "Scheduled Maintenance" in the Index). Always wash your car thoroughly.

- Since the driving torque is always applied to the 4 wheels the performance of the 4WD vehicle is greatly affected by the condition of the tires. Be sure to equip them with all four tires with same size and type.
- The full time four wheel drive vehicle cannot be towed by an ordinary tow truck. Make sure that the vehicle is towed with its four wheels raised off the ground.

⚠ CAUTION

While the full-time 4WD vehicle is being raised on a jack, never start the engine or cause the tires to rotate.

There is the danger that rotating tires touching the ground could cause the vehicle to go off the jack and to jump forward.

If one of the front or rear wheels begins to spin in mud, snow, etc. the vehicle can sometimes be driven out by depressing the accelerator pedal further; however avoid running the engine continuously at high rpm because doing so could damage the 4WD system.

▲ WARNING

- **Avoid high cornering speed.**
- **Do not make quick steering wheel movements, such as sharp lane changes or fast, sharp turns.**
- **The risk of rollover is greatly increased if you lose control of your vehicle at high speeds.**
- **In a collision crash, an unbelted person is significantly more likely to die compared to a person wearing a seat belt.**
- **Loss of control often occurs if two or more wheels drop off the roadway and the driver over steers to re-enter the roadway.**
- **In the event your vehicle leaves the roadway, do not steer sharply.**
Instead, slow down before pulling back into the travel lanes.

LIMITED SLIP DIFFERENTIAL (IF EQUIPPED)

A limited slip differential if equipped, is for the rear wheel differential only. The features of this limited slip differential are described below;

Just as with conventional differential, the wheel on one side is allowed to turn at a different speed from the wheel on the other side when the vehicle is cornering.

The difference between the limited slip differential and a conventional differential is that if the wheel on one side of the vehicle loses traction, a greater amount of torque is applied to the rear wheel on the other side to improve traction.

▲ WARNING

To avoid injury, never run the engine with one wheel off the ground, such as when changing a tire.

BRAKE SYSTEM

Power Brakes

Your vehicle has power-assisted brakes that adjust automatically through normal usage.

In the event that the power-assisted brakes lose power because of a stalled engine or some other reason, you can still stop your vehicle by applying greater force to the brake pedal than you normally would. The stopping distance, however, will be longer. Refer to the scheduled maintenance guide for scheduled maintenance intervals.

When the engine is not running, the reserve brake power is partially depleted each time the brake pedal is applied. Do not pump the brake pedal when the power assist has been interrupted. Pump the brake pedal only when necessary to maintain steering control on slippery surfaces.

In the Event of Brake Failure

If the service brakes should fail to operate while the vehicle is in motion, you can make an emergency stop with the parking brake. The stopping distance, however, will be much greater than normal.

⚠ WARNING - Parking Brake

Pulling on the parking brake while the vehicle is moving at normal speeds can cause a sudden loss of control of the vehicle. If you must use the parking brake to stop the vehicle, use great caution in applying the brake.

⚠ WARNING - Brakes

- Do not drive with your foot resting on the brake pedal. This will create abnormally high brake temperatures, excessive brake lining and pad wear, and increased stopping distances.
- When descending a long or steep hill, shift to a lower gear and avoid continuous application of the brakes. Continuous brake application will cause the brakes to overheat and could result in a temporary loss of braking performance.

(Continued)

(Continued)

- Wet brakes may result in the vehicle not slowing down at the usual rate and pulling to one side when the brakes are applied. Applying the brakes lightly will indicate whether they have been affected in this way. Always test your brakes in this fashion after driving through deep water. To dry the brakes, apply them lightly while maintaining a safe forward speed until brake performance returns to normal.

Disc Brake Wear Indicators

Your vehicle has disc brakes.

When your brake pads are worn and it's time for new pads, you will hear a high-pitched warning sound from your front brakes. You may hear this sound come and go or it may occur whenever you depress the brake pedal.

▲ WARNING - Brake Wear

This brake wear warning sound means your vehicle needs service. If you ignore this audible warning, you will eventually lose braking performance, which could lead to a serious accident.

*** NOTICE**

To avoid costly brake repairs, do not continue to drive with worn brake pads. Always replace brake pads or linings as a complete front or rear axle sets.

Please remember that some driving conditions or climates may cause a brake squeal when you first apply (or lightly apply) the brakes. This is normal and does not indicate a problem with your brakes.

⚡ CAUTION

Always replace brake pads as complete front or rear axle sets.

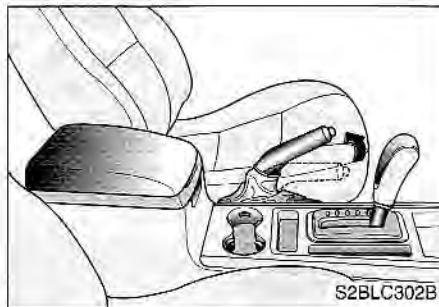

Parking Brake

To set the parking brake, pull the parking brake handle fully and firmly upward while applying the service brake.



To release the parking brake, pull the handle up slightly and push the release button. Then lower the handle to the released position while holding the button in.

⚠ WARNING

To prevent unintentional movement when stopped and leaving the vehicle, do not use the gearshift lever in place of the parking brake. Set the parking brake AND make sure the gearshift lever is securely positioned in 1st (First) gear or R (Reverse) for manual transmission equipped vehicles and in P (Park) for automatic transmission equipped vehicles.

Check the brake warning light each time you start the engine. This warning will be illuminated when the engine is running and the parking brake is set.

Before driving, be sure the parking brake is fully released and the brake warning light is off.

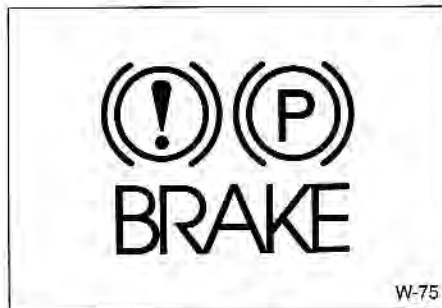

If the brake warning light remains on after the parking brake is released, there may be a malfunction in the brake system. Immediate attention is necessary.

If at all possible, cease driving the vehicle immediately. If that is not possible, use extreme caution while operating the vehicle and only continue to drive the vehicle until you reach the first safe location or repair shop.

Parking on Curbed Streets

- When parking your vehicle on an uphill grade, park as close to the curb as possible and turn the front wheels away from the curb so that the front wheels will contact the curb if the vehicle moves backward.
- When parking your vehicle on a downhill grade, park as close to the curb as possible and turn the front wheels toward the curb so that the front wheels will contact the curb if the vehicle moves forward.

Anti-Lock Brake System (ABS) (If equipped)

▲ WARNING - ABS Brakes

Your ABS is not a substitute for good driving judgement. You can still have an accident. In fact, your ABS system will probably not be able to prevent an accident in the following driving conditions:

- **Dangerous driving, such as neglecting safety precautions, speeding, or driving too close to the vehicle in front of you.**
- **Driving at high speed in situations providing considerably less traction, such as wet conditions where hydroplaning could occur.**

(Continued)

(Continued)

- **Driving too fast on poor road surfaces. The ABS is designed to improve maximum braking effectiveness on typical highways and roads in good condition. On poor road surfaces in poor condition, the ABS may actually reduce braking effectiveness.**

The ABS system continuously senses the speed of the wheels. If the wheels are going to lock, the ABS system repeatedly modulates the hydraulic brake pressure to the wheels.

When you apply your brakes under conditions which may lock the wheels, you may hear a “tik-tik” sound from the brakes, or feel a corresponding sensation in the brake pedal. This is normal and it means your ABS system is active.

In order to obtain the maximum benefit from your ABS system in an emergency situation, do not attempt to modulate your brake pressure and do not try to pump your brakes. Press your brake pedal as hard as possible or as hard as the situation warrants and allow the ABS system to control the force being delivered to the rear brakes.

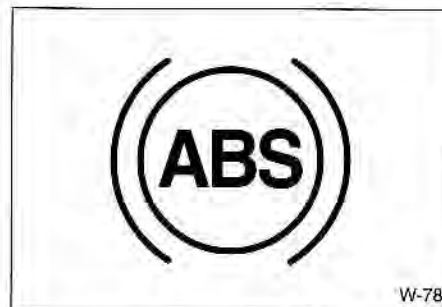

W-78

- Even with the anti-lock brake system, your vehicle still requires sufficient stopping distance. Always maintain a safe distance from the vehicle in front of you.
- Always slow down when cornering. The anti-lock brake system cannot prevent accidents resulting from excessive speeds.
- On loose or uneven road surfaces, operation of the anti-lock brake system may result in a longer stopping distance than for vehicles equipped with a conventional brake system.

*** NOTICE**

- If the ABS warning light is on and stays on, you may have a problem with the ABS system. In this case, however, your regular brakes will work normally.
- The ABS warning light will stay on for 2-3 seconds after the engine starts. During that time, the ABS will go through self-diagnosis and the light will go off if everything is normal. If the light stays on, you may have a problem with your ABS system. Contact an authorized Kia dealer as soon as possible.

*** NOTICE**

- When you drive on a road having poor traction, such as an icy road, and operate your brakes continuously, the ABS will be active continuously and the ABS warning light may illuminate. Pull your car over to a safe place and stop the engine.
- Restart the engine. If the ABS warning light is off, then your ABS system is normal. Otherwise, you may have a problem with the ABS. Contact an authorized Kia dealer as soon as possible.

*** NOTICE**

When you jump start your vehicle because of a discharged battery, the engine may not run as smoothly and the ABS warning light may blink at the same time. This happens because of the low battery voltage. It does not mean your ABS is malfunctioning.

- Do not pump your brakes!
- Have the battery recharged before driving the vehicle.

POWER STEERING

Power steering uses energy from the engine to assist you in steering the vehicle. If the engine is off or if the power steering system becomes inoperative, the vehicle may still be steered, but it will require increased steering effort.

Should you notice any change in the effort required to steer during normal vehicle operation, have the power steering system checked by an authorized Kia dealer.

*** NOTICE**

If the vehicle is parked for extended periods outside in cold weather (below -10°C (14°F)), the power steering may require increased effort when the engine is first started. This is caused by increased fluid viscosity due to the cold weather and does not indicate a malfunction.

When this happens, increase the engine RPM to 1500rpm then release or let the engine idle for two or three minutes to warm up the fluid.

*** NOTICE**

- **Never hold the steering wheel against a stop (extreme right or left turn) for more than five seconds with the engine running. Holding the steering wheel for more than five seconds in either position may cause damage to the power steering pump.**
- **If the power steering drive belt breaks or if the power steering pump malfunctions, the steering effort will greatly increase.**

CRUISE CONTROL

The cruise control system allows you to program the vehicle to maintain a constant speed without resting your foot on the accelerator pedal.

With cruise control, you can set and automatically maintain any speed of more than about 24 mph (40km/h).

⚠ WARNING

- Cruise Control

Do not use the cruise control feature under the following conditions:

- **Heavy or unsteady traffic**
- **Slippery or winding roads**
- **Situations that involve varying speeds**

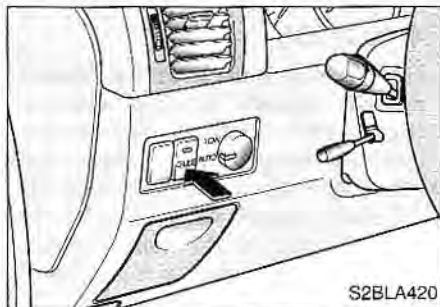

To Set Cruise Control Speed:

1. Push the CRUISE switch, located on the left side of the steering column, to the ON position.
2. Accelerate to the desired speed, which must be more than 24 mph (40 km/h).

⚠ WARNING

If the CRUISE MAIN switch is left on, the cruise control can be switched on accidentally. Keep the CRUISE MAIN switch off when cruise control is not in use.

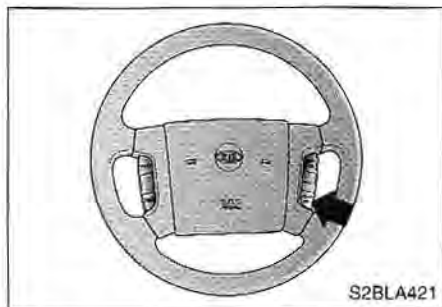

To Cancel Cruise Control, do one of the following:

- Depress the brake pedal.
- Depress the clutch pedal with a manual transmission, or shift into N (Neutral) with an automatic transmission.
- Depress the CANCEL switch located on the steering wheel.
- Depress the COAST/SET and RES/ACCEL switches at the same time.

Each of these actions will cancel cruise control operation, but it will not turn the system off. If you wish to resume cruise control operation, depress the RES/ACCEL switch located on your steering wheel. You will return to your previously preset speed.

3. Depress the COAST/SET switch, located on the steering wheel, and release it at the speed you want. Release the accelerator at the same time. The desired speed will automatically be maintained and the CRUISE light on your instrument cluster will illuminate.

The SET function cannot be activated until approximately 2 seconds after the CRUISE MAIN switch has been engaged.

On a steep grade, the vehicle may momentarily slow down while going downhill.

To turn cruise control off, do one of the following:

- Push the CRUISE switch to the OFF position.
- Turn the ignition off.

Both of these actions also cancel cruise control operation. If you want to resume cruise control operation, repeat the steps provided in "To Set Cruise Control Speed" on the previous page.

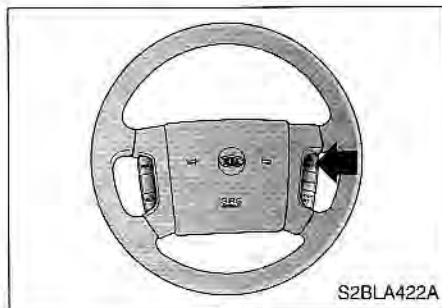

S2BLA422A

To Increase Cruise Control Set Speed:

Follow either of these procedures:

- Depress the RES/ACCEL switch and hold it. Your vehicle will accelerate. Release the switch at the speed you want.
- Depress the RES/ACCEL switch and release it immediately. The cruising speed will increase 1mph (1.6 km/h) by one touch and will be memorized to the reset speed.

To Temporarily Accelerate with the Cruise Control On

If you want to speed up temporarily when the cruise control is on, depress the accelerator pedal. Increased speed will not interfere with cruise control operation or change the set speed.

To return to the set speed, take your foot off the accelerator.

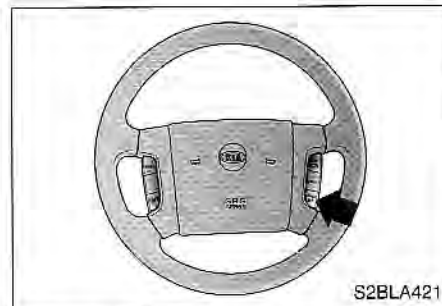

S2BLA421

To Decrease the Cruising Speed:

Follow either of these procedures:

- Depress the COAST/SET switch and hold it. Your vehicle will gradually slow down. Release the switch at the speed you want to maintain.
- Depress the COAST/SET switch and release it immediately. The cruising speed will decrease 1mph (1.6 km/h) by one touch and will be memorized to the reset speed.

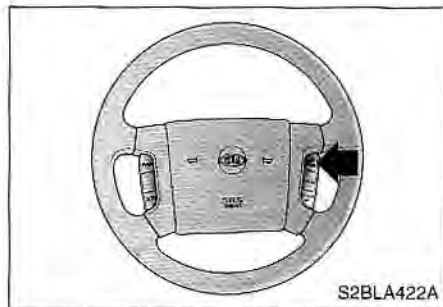

**To Resume Cruising Speed at
More Than 24 mph (40 km/h):**

If something besides the CRUISE MAIN switch was used to cancel cruising speed and the system is still activated, the most recent set speed will automatically resume when the RES/ACCEL switch is depressed. It will not resume, however, if the vehicle speed has dropped below 24 mph (40km/h).

INSTRUMENT CLUSTER

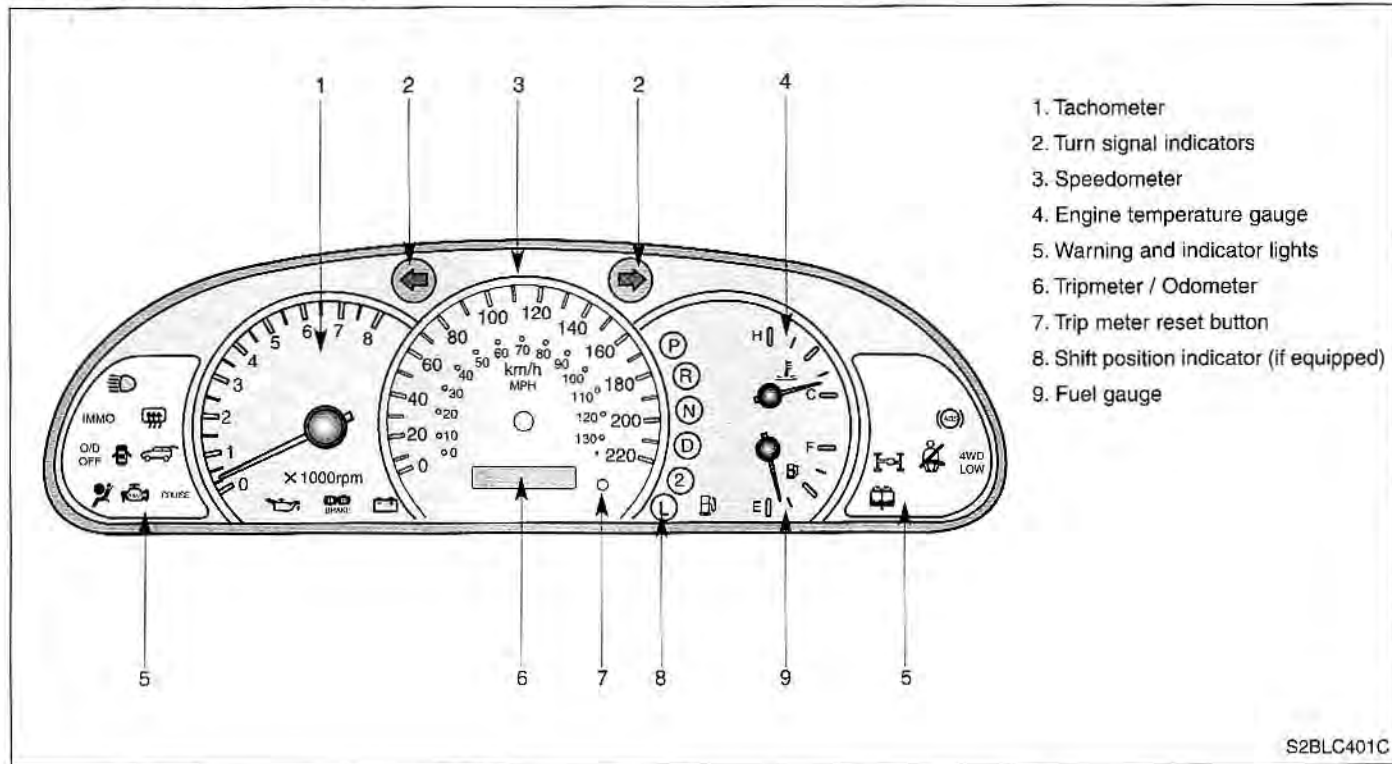

1. Tachometer
2. Turn signal indicators
3. Speedometer
4. Engine temperature gauge
5. Warning and indicator lights
6. Tripmeter / Odometer
7. Trip meter reset button
8. Shift position indicator (if equipped)
9. Fuel gauge

S2BLC401C

GAUGES

Speedometer

The speedometer indicates the forward speed of the vehicle.

Odometer/Tripmeter

You can choose the odometer, tripmeter A and tripmeter B by pressing the mode selection button.

Odometer

The odometer indicates the total distance the vehicle has been driven.

Tripmeter

TRIP A : Tripmeter A

TRIP B : Tripmeter B

The tripmeter indicates the distance of individual trips selected by the driver. Tripmeter A and B can be reset to zero by pressing the mode selection button for one second or more then releasing.

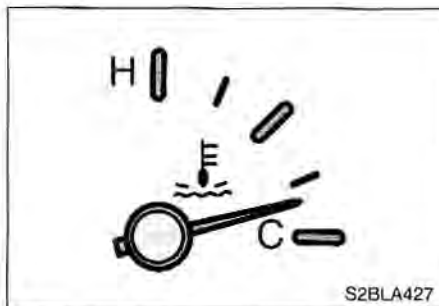

Engine Temperature Gauge

This gauge shows the temperature of the engine coolant when the ignition switch is ON.

If the gauge pointer moves beyond the normal range area toward the H position, it indicates overheating that may damage the engine.

Do not continue driving with an overheated engine. If your vehicle overheats, refer to "Overheating" in the Index.

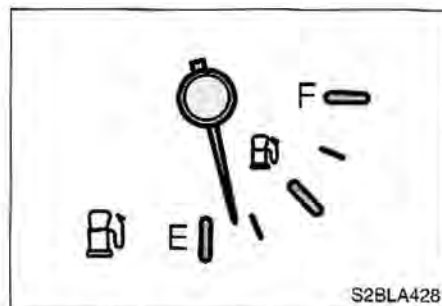

Fuel Gauge

The fuel gauge indicates the approximate amount of fuel remaining in the fuel tank.

Fuel tank capacity - 20.8 gal. (80 liters).

The fuel gauge is supplemented by a low fuel warning light, which will illuminate when the fuel level has dropped to about 3.1 gal. (12 liters).

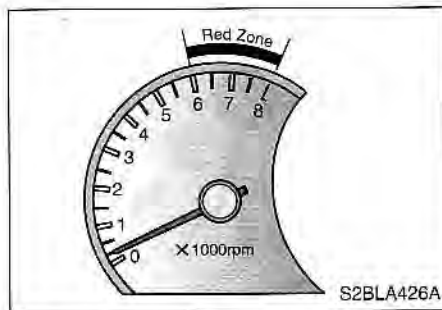

Tachometer

The tachometer indicates the approximate number of engine revolutions per minute (rpm).

Use the tachometer to select the correct shift points and to prevent lugging the engine and/or over-revving the engine.

The tachometer pointer may move slightly when the ignition switch is in ACC or ON position with the engine OFF. This movement is normal and will not affect the accuracy of the tachometer once the engine is running.

* NOTICE

Do not operate the engine within the tachometer's RED ZONE.

This may cause severe engine damage.

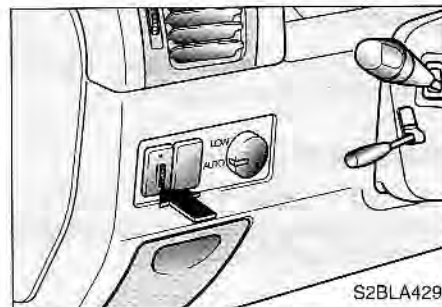

Instrument Panel Illumination (If equipped)

When the vehicle's parking lights or headlights are on, the instrument panel lights activate. This makes the instruments and controls visible in darkness. To adjust the instrument panel illumination intensity, rotate the illumination control knob.

You can turn ON or OFF the interior lights (map light, dome light) by rotating the control knob to the maximum position when the interior lights are turned OFF.

WARNINGS AND INDICATORS

Warning Lights / Audible Indicators

Checking operation

All warning lights are checked by turning the ignition switch ON (do not start the engine). Any light that does not illuminate should be checked by an Authorized Kia Dealer.

After starting the engine, check to make sure that all warning lights are off. If any are still on, this indicates a situation that needs attention. When releasing the parking brake, the brake system warning light should go off. The fuel warning light will stay on if the fuel level is low.

Anti-Lock Brake System (ABS) Warning Light



This light illuminates when you start the engine. The light will go off if the ABS system is operating normally.

Also, this light illuminates if the key is turned to ON and goes off in 2-3 seconds if the system is operating normally.

O/D OFF Indicator (if equipped)



This indicator comes on when the O/D system is deactivated.

Engine Oil Pressure Warning



This warning light indicates the engine oil pressure is low.

If the warning light illuminates while driving:

1. Drive safely to the side of the road and stop.
2. With the engine off, check the engine oil level. If the level is low, add oil as required.

If the warning light remains on after adding oil or if oil is not available, call an Authorized Kia Dealer.

*** NOTICE**

If the engine is not stopped immediately, severe damage could result.

Charging System Warning



This warning light indicates a malfunction of either the generator or electrical charging system.

If the warning light comes on while the vehicle is in motion:

1. Drive to the nearest safe location.
2. With the engine off, check the generator drive belt for looseness or breakage.
3. If the belt is adjusted properly, a problem exists somewhere in the electrical charging system. Have an Authorized Kia Dealer correct the problem as soon as possible.

Safety Belt Warning



If the driver's lap/shoulder belt is not fastened when the key is turned ON or if it is unfastened after the key is ON, a chime sounds and the safety belt warning light remains on for 6 seconds. If the system does not operate as described, see an Authorized Kia Dealer for assistance.

Shift Pattern Indicators

(Automatic Transmission Only)

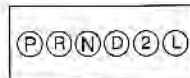

The individual indicators illuminate to show the shift lever selection. The P (Park) and R (Reverse) symbols are illuminated by red lights and the N (Neutral), D (Drive), 2 (Second), and L (Low) symbols are illuminated by green lights.

Parking Brake & Brake Fluid Warning



Parking brake warning

This light is illuminated when the parking brake is applied with the ignition switch in the START or ON position. The warning light should go off when the parking brake is released.

Low brake fluid level warning

If the warning light remains on, it may indicate that the brake fluid level in the reservoir is low.

If the warning light remains on:

1. Drive carefully to the nearest safe location and stop your vehicle.
2. With the engine stopped, check the brake fluid level immediately and add fluid as required. Then check all brake components for fluid leaks.
3. Do not drive the vehicle if leaks are found, the warning light remains on or the brakes do not operate properly. Have it towed to any Authorized Kia Dealer for a brake system inspection and necessary repairs.

To check bulb operation, check whether the parking brake and brake fluid warning light illuminates when the ignition switch is in the ON position

▲ WARNING

Driving the vehicle with a warning light on is dangerous. If the brake warning light remains on, have the brakes checked and repaired immediately by an Authorized Kia Dealer.

Rear Hatch Ajar Warning



This warning light activates when the rear hatch or rear hatch window are not closed securely.

Low Fuel Level Warning



This warning light indicates the fuel tank is nearly empty. The warning light will come on when the fuel level has dropped to about 3.1 us gal. (12 liters). Refuel as soon as possible.

Rear Hatch Window Defroster Indicator



This light comes on when the rear hatch defroster switch is depressed to remove the frost on the rear hatch glass.

Press the switch again to shut off the defroster when the frost is removed.

The rear hatch window defroster will automatically turn off after 20 minutes.

It will also turn off whenever you remove the ignition key.

Door Ajar Warning



This warning light comes on when a door is not closed securely with the ignition in any position.

Headlight High Beam Indicator



This indicator activates when the headlights are on and in the high beam position or when the turn signal lever is pulled into the Flash-to-Pass position.

Immobilizer Indicator**IMMO**

When you turn the ignition key to the ON position, if the IMMO indicator goes off after blinking 6 times, this indicates that the immobilizer system is normal. However, if the IMMO indicator remains on continuously after blinking 6 times, this indicates that the immobilizer system is out of order and you cannot start the engine without the limp home procedure. Refer to the "Limp home procedure" on page 3-4.

Malfunction Indicator

The CHECK ENGINE or malfunction indicator light is installed in your vehicle's instrument panel and responds to signals from the vehicle's On Board Diagnostic (OBD -II) System. The OBD-II System monitors the performance of the vehicle's Emission Control System (ECS), which is designed to reduce the amount of air pollutants in engine exhaust to the levels required by government regulations.

When you first start the engine, the check engine light will illuminate briefly as a system check to confirm that the OBD-II System is operating properly. As the engine starts, this light turns off. However, if at any time the OBD-II system detects a faulty signal or determines that the ECS is not performing to specification, the CHECK ENGINE light will illuminate continuously or flash.

Continuously ON :

If the CHECK ENGINE light comes ON while driving and illuminates continuously, a potential problem has been discovered in the ECS or one of the exhaust system components. Generally, the vehicle will continue to be driveable but it should be checked by an authorized Kia dealer as soon as possible. This condition is unlikely to lead to engine damage unless a decrease in vehicle power or poor running conditions is immediately apparent.

Note that the CHECK ENGINE light will illuminate for a problem like a loose or missing gas cap, but will not illuminate as a result of low engine oil or coolant, low automatic transaxle fluid or engine overheating. The driver will be alerted to these conditions by other indicators on the instrument panel

CAUTION

- *Prolonged driving with the On Board Diagnostic System Malfunction Indicator Light (🚗) illuminated may cause damage to the emission control systems which could affect driveability and/or fuel economy.*
- *If the On Board Diagnostic System Malfunction Indicator Light (🚗) illuminates, potential catalytic converter damage is possible which could result in loss of engine power. Have the On Board Diagnostic System inspected as soon as possible by an authorized Kia dealer.*

*** NOTICE**

A loose fuel filler cap may cause the On Board Diagnostic System Malfunction Indicator Light (🚗) in the instrument panel to illuminate unnecessarily. Always make sure that the fuel filler cap is tight.

Air Bag Warning



This warning light will blink for approximately 6 seconds each time you turn the ignition switch to the ON position.

If this indicator does not do this or if it illuminates while the vehicle is being driven, see an Authorized Kia Dealer for immediate service.

Auto Cruise Indicator

CRUISE

The indicator light illuminates when the cruise control system is activated.

4WD Indicator Light (If equipped) (Part Time 4WD Only)



When the key is turned to the "ON" position, the 4WD indicator light will come on and then go off in a few seconds.

The 4WD indicator light will illuminate when the transfer shift knob is set to 4HI position (Part time 4WD only).

4WD LOW Indicator Light (If equipped)

**4WD
LOW**

When the key is turned to the "ON" position, the 4WD Low indicator will come on and then go off in a few seconds. The 4WD Low indicator light comes on when the transfer shift knob is set to 4WD low position.

Part-time 4WD : 4LO position

Full-time 4WD : Low position

CAUTION

If the 4WD indicator light (I-I) blinks (full-time 4WD) or 4WD indicator light (I-I) and 4WD LOW indicator light (4WD Low) illuminate at the same time (part time 4WD), this indicates that there is a malfunction in the 4WD system. If this occurs, have your vehicle checked by an Authorized Kia Dealer as soon as possible.

Low Washer Fluid Level Warning Indicator

This warning light indicates the washer fluid reservoir is near empty. Refill the washer fluid as soon as possible.

Parking Start Warning Chime (If equipped)

If you drive over 10 km/h with the parking brake applied, the parking start warning chime will sound.

Door Ajar Warning Chime

If a door is opened while driving the vehicle more than 5 km/h, the warning chime will sound.

Safety Belt Warning Chime

If the driver's seat belt is not fastened when the ignition key is turned to the "ON" position, the safety belt warning chime will sound approximately for 6 sec.

Key Reminder Warning Chime

If the front door is opened and the ignition key is left with the ignition switch in "LOCK" or "ACC" position, the key reminder warning chime will sound. This is to prevent you from locking your keys in the vehicle.

MULTI-METER (IF EQUIPPED)

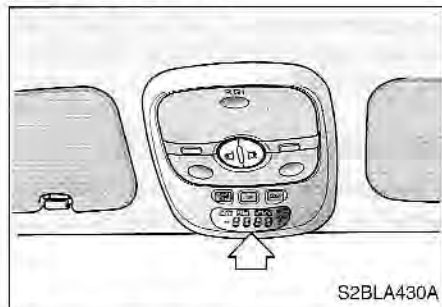

The Functions Of Multi-Meter

1. Azimuth Compass
2. Relative Altimeter
3. Barometer
4. Tempmeter (if equipped)

How to Adjust the Multi-Meter

Switch function

Mode/Set Switch Function

1. Selection of modes : If you push the MODE/SET switch for less than 1 second, the mode will be selected as follows.

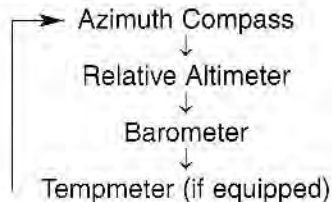

2. Correction of Relative Azimuth Compass Indicator.
3. Correction of Terrestrial deviation of the Azimuth Compass.
4. Clear the altitude to "0" (zero).

Up/Down Switch

1. Correction of the terrestrial deviation angle of the Azimuth Compass.
2. Conversion of the Relative Altimeter. units (m ↔ ft).
3. Conversion of the Tempmeter units (°C ↔ °F).

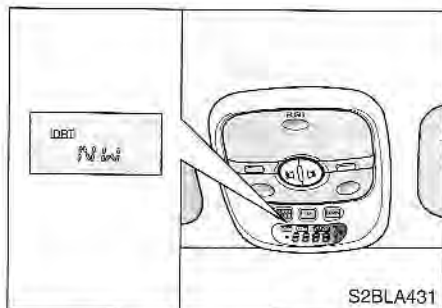

Correcting Azimuth Indicator

Position correction should be performed if the displayed direction of the vehicle differs from the actual direction of the vehicle, or if the battery has been disconnected.

1. Start the vehicle and access the compass function indicated by DRT on the display. Press the MODE/SET button until the DRT display begins to blink on and off.
2. Slowly (about 3 mph) and carefully drive the vehicle in a complete 360 degree circle, within 128 seconds (about two minutes).
3. After completing the circle drive, the DRT display will stop blinking and the error correction will be complete.

Electric Azimuth Compass

It displays azimuth according to the vehicle's driving direction.

The indication is displayed only when the vehicle is in motion.

* NOTICE

If new vehicle is first driven or if the battery has been disconnected, correct the azimuth indicator before driving.

The azimuth compass indicator correction will be cancelled:

1. If you press MODE/SET switch for more than 1 second while the DRT display blinks.
2. When the vehicle is not rotated within 128 seconds after the blinking of the DRT display.

*** NOTICE**

The azimuth may display abnormally in specific places (tunnel, parking lot in building, underground parking lot, near transformer substation, etc.).

Magnetic Declination Correction

The compass function provides bearing (direction of travel) information to the driver. It is known that a magnetic compass does not point to true (geographic) north. Magnetic north is the direction in which a compass will point. Over most of the earth surface, a magnetic compass will point either east or west of true north. In order to compensate for this, magnetic declination must be taken into consideration. Magnetic declination is the angle between magnetic north and true north.

Correcting declination

1. Turn the ignition key ON and access the compass function indicated by DRT on the display.
2. Press and hold the MODE/SET button for four seconds. The display will change from a direction to a number followed by an E or W.

3. Press the UP or DOWN button to select the degree of correction for your location from the contour line map. (example: Los Angeles, California would be 15E.)
4. Press the MODE/SET button until the display changes back to its normal view.

*** NOTICE**

The terrestrial deviation setting will be remembered even if the battery has been disconnected.

The terrestrial deviation angle correction will be cancelled:

1. If you press MODE/SET switch for less than 1 second.
2. If you don't correct the terrestrial deviation angle within 30 seconds.

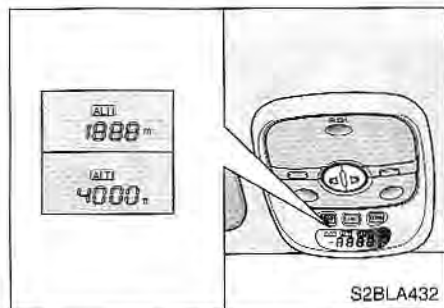

Relative Altimeter

The relative altimeter displays the current altitude to an actual altitude of +/- 9800 feet.

When you want to know the altitude difference between your starting point and destination:

1. Press the MODE/SET button until the current altitude displayed is 0.
2. When you arrive at your destination, the altitude displayed will be the difference between the starting point and destination.
3. To change the display from feet to meters, press the UP or DOWN button for one second.

* NOTICE

The Relative Altimeter will display different altitude at the same place as the atmospheric pressure varies at one place.

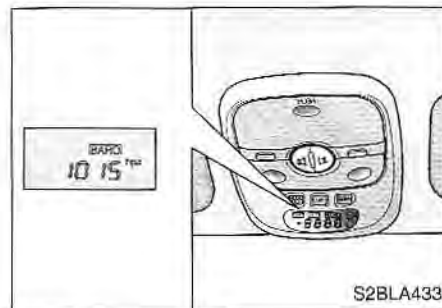

Barometer

The barometer function displays atmospheric pressure in hectopascals. 1013 hPa is equivalent to 29.92 inches of mercury, or 14.7 psi. (air pressure at sea level). The barometer range is 600 to 1100 hPa.

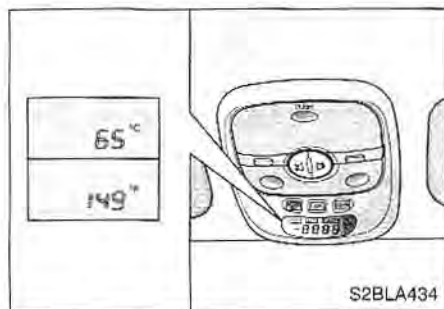

Tempmeter (If equipped)

Ambient outdoor temperature is displayed in metric or standard units to a range of -30 to 149 degrees F. Pressing the UP or DOWN button for approximately one second will change the units from standard to metric.

LIGHTING

Battery Saver Function

- The purpose of this feature is to prevent the battery from being discharged. The system automatically turns off the small light when the driver removes the ignition key and opens the driver- side door.
- With this feature, the taillight will be turned off automatically if the driver parks on the side of road at night.

If necessary, to keep the lights on when the ignition switch is removed, perform the following :

- 1) Open the driver-side door.
- 2) Turn the tail-lights OFF and ON again using the light switch on the steering column.

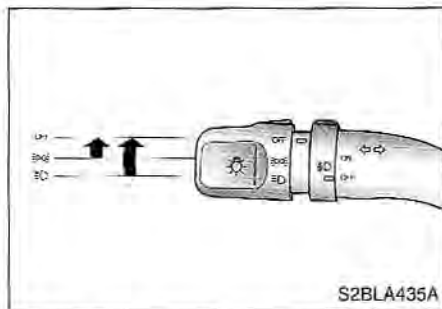

Lighting Control

The light switch has a Headlight and a Parklight position.

To turn the lights on, twist the knob on the end of the control lever.

Parklight position.

When the light switch is in the park-light position, the tail, parking, license and instrument panel lights are ON.

Headlight position.

When the light switch is in the head-light position, the head, tail, parking, license and instrument panel lights are ON.

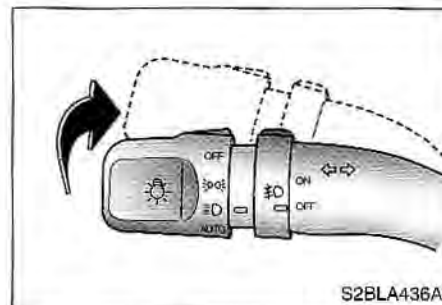
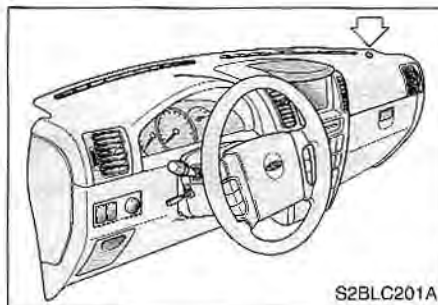
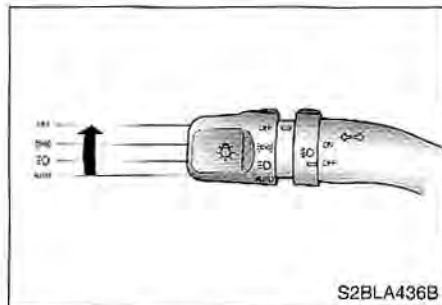

Auto light position (If equipped)

When the light switch is in the auto light position (third position), the tail-lights and headlights will be turned automatically ON or OFF according to external illumination.

*** NOTICE**

To ensure better control of the auto light system, never place items on the sensor located on the dash. Don't clean the sensor with a window cleaner, only use a towel dampened with water. If your front windshield has a coating or tint the auto light system may not work properly.

High-Beam operation

To turn on the high-beam headlights, push the lever away from you. Pull it back for low beams.

The high-beam indicator will light when the headlight high beams are switched on.

To prevent the battery from being discharged, do not leave the lights on for a prolonged time while the engine is not running.

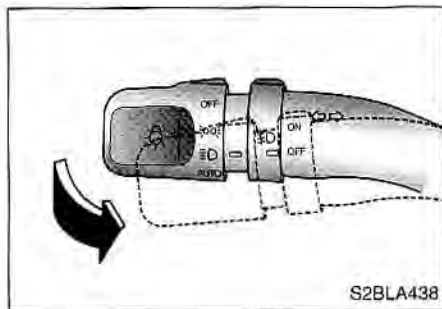

Flashing Headlights

To flash the headlights, pull the lever toward you. It will return to the normal position when released. The headlight switch does not need to be on to use this flashing feature.

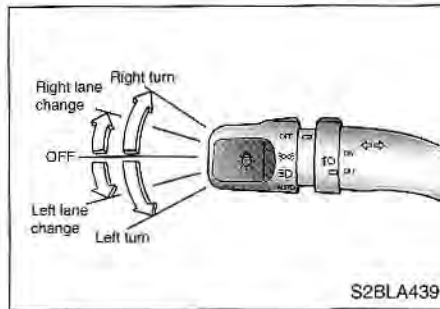

Turn Signals

The ignition switch must be on for the turn signals to function. To turn on the turn signals, move the lever up or down. Green arrow indicators on the instrument panel indicate which turn signal is operating. They will self-cancel after a turn is completed. If the indicator continues to flash after a turn, manually return the lever to the OFF (middle) position.

Lane change signals

To signal a lane change, move the turn signal lever slightly and hold it in position. The lever will return to the OFF (center) position when released.

If an indicator stays on and does not flash or if it flashes abnormally, one of the turn signal bulbs may be burned out and will require replacement.

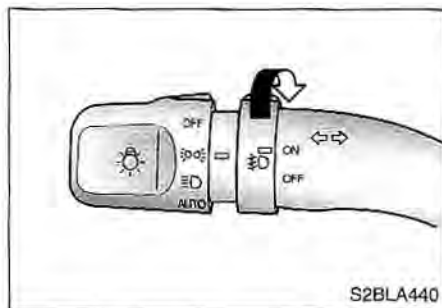

Front Fog Light (If equipped)

To turn the front fog lights ON, turn the headlights ON after starting the engine and then turn the front fog light switch to ON position. To turn it OFF, turn it to OFF position or turn the headlights OFF.

Daytime Running Light

Daytime Running Lights (DRL) can make it easier for others to see the front of your vehicle during the day. DRL can be helpful in many different driving conditions, and it is especially helpful after dawn and before sunset.

The DRL system will make your low-beam headlights turn OFF when:

1. The headlight switch is ON.
2. The parking brake is engaged.
3. The engine stops.

WIPERS AND WASHERS

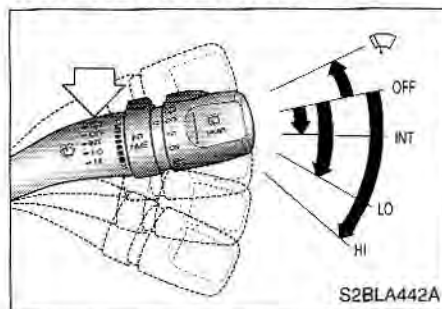

Windshield Wipers

The ignition switch must be ON.

To turn the wipers on, move the lever down.

-  - One touch wiper
- INT - Intermittent wiper operation
- LO - Normal wiper speed
- HI - Fast wiper speed

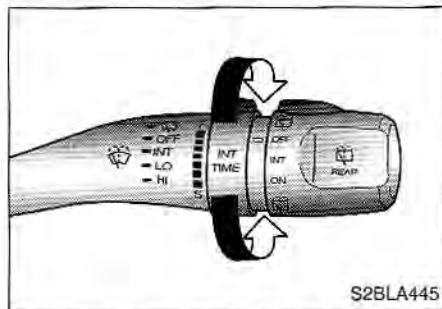

Variable Intermittent Wipers

Set the lever to the INT position and choose the desired wiper interval by turning the ring.

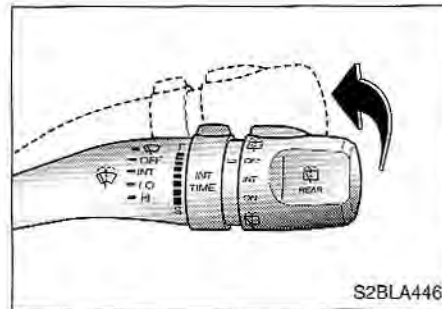

One-Touch Wipers

For a single wiping cycle, push the lever upward and release it with the lever in the OFF position.

The wipers will operate continuously if the lever is pushed upward and held.

*** NOTICE**

- To prevent possible damage to the wipers or windshield, do not operate the wipers when the windshield is dry.
- To prevent damage to the wiper blades, do not use gasoline, kerosene, paint thinner, or other solvents on or near them.
- To prevent damage to the wiper arms and other components, do not attempt to move the wipers manually.

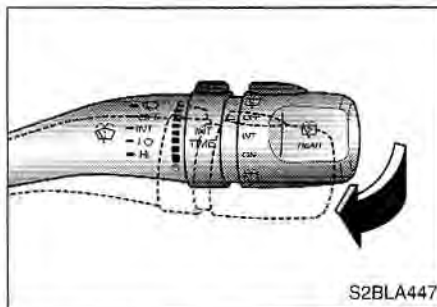

S2BLA447

Windshield Washers

In the OFF position, pull the lever gently toward you to spray washer fluid on the windshield and to run the wipers 2-3 cycles.

Use this function when the windshield is dirty.

The spray and wiper operation will continue until you release the lever.

If the washer does not work, check the washer fluid level. If the fluid level is not sufficient, you will need to add an appropriate non-abrasive windshield washer fluid to the washer reservoir. The reservoir filler neck is located in the front of the engine compartment on the passenger side.

⚠ WARNING

Do not use the washer in freezing temperatures without first warming the windshield with the defrosters; the washer solution could freeze on contact with the windshield and obscure your vision.

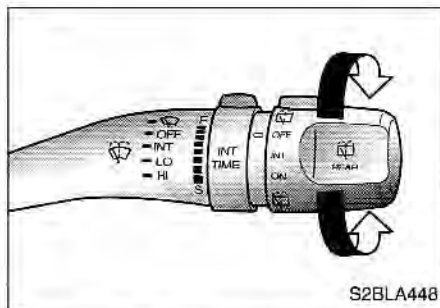

*** NOTICE**

To prevent possible damage to the washer pump, do not operate the washer when the fluid reservoir is empty.



Rear Window Wiper and Washer Switch

The rear window wiper and washer switch is located at the end of the wiper and washer switch lever. Turn the switch to desired position to operate the rear wiper and washer. When the rear hatch window is opened the rear window wiper and washer does not work.

-  - Spraying washer fluid and wiping
- INT - Intermittent wiper operation
- ON - Normal wiper operation
-  - Spraying washer fluid and wiping

* NOTICE

To prevent possible damage to the rear window wiper, do not open the rear hatch window while the rear window wiper and washer is operating.

DEFROSTER

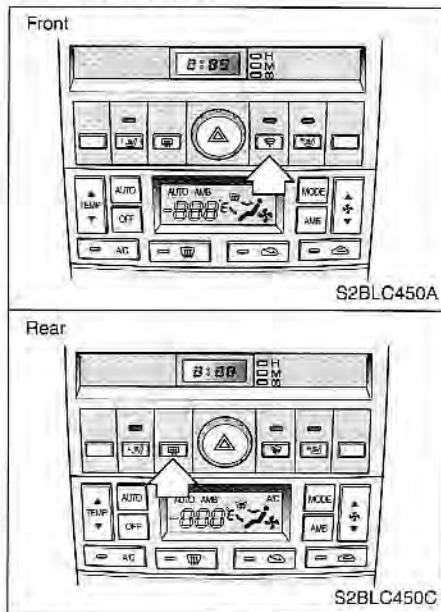

The defroster clears frost, fog and thin ice from the interior and exterior of the front windshield and rear window, while the engine is running.

* NOTICE

- To prevent damage to the conductors bonded to the inside surface of the bottom of the front windshield and the rear window, never use sharp instruments or window cleaners containing abrasives to clean the window.
- To prevent the battery from being discharged, operate the defroster only while the engine is running.
- The front windshield defroster is designed to defrost wiper blades. If you want to defrost and defog on the front windshield, refer to "Windshield Defrosting and Defogging" in this section.

If your vehicle is equipped with the outside rearview mirror defroster, you can also clear frost from the mirrors by depressing this rear window defroster switch.

To activate the defroster, depress the corresponding defroster switch located on the center console switch panel. Front windshield and rear window defroster indicators illuminate when the defrosters are on. The defrosters automatically turn off after about 20 minutes, or when the ignition switch is turned off. To turn off the defroster, press the corresponding defroster switch again.

If there is heavy accumulation of snow on the rear window, brush it off before operating the rear defroster.

If your vehicle is equipped with an outside rearview mirror defroster, it will be operating at the same time when you operate the rear window defroster.

HAZARD WARNING FLASHER

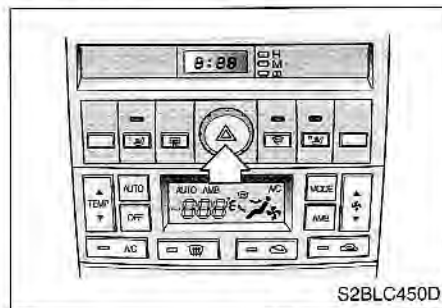

The hazard warning flasher causes the rear tail lights and front turn signal lights to flash on and off, which serves as a warning to other drivers to exercise caution when approaching or passing your vehicle.

To activate the flasher, depress the hazard warning flasher switch. This switch operates in any ignition switch position.

To turn the flashers off, depress the switch again.

INTERIOR FEATURES

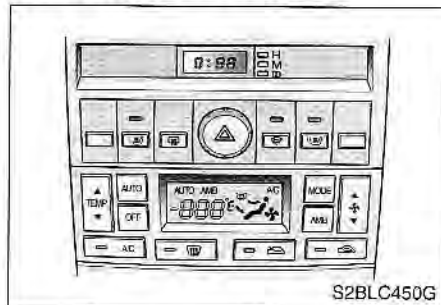

Digital Clock

When the ignition switch is in the ACC or ON position, the clock buttons operate as follows:

HOUR "H":

Pressing the "H" button with your finger, a pencil or similar object will advance the time displayed by one hour.

MINUTE "M":

Pressing the "M" button with your finger, a pencil or similar object will advance the time displayed by one minute.

RESET ":00":

To clear away minutes, press the ":00" button with your finger, a pencil or similar object. Then the clock will be set precisely on the hour.

For example, if the ":00" button is pressed while the time is between 9:01 and 9:29, the display will be reset to 9:00. If pressed while it is between 9:30 and 9:59, the display will be reset to 10:00.

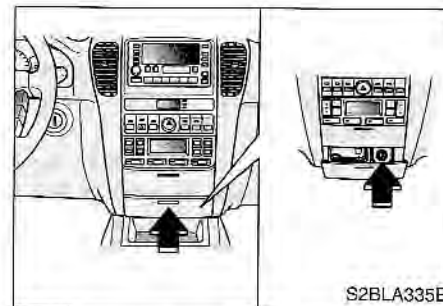

Cigarette Lighter

To use the cigarette lighter, press the front face then release it to allow the cigarette lighter and ashtray to slowly extend from center panel.

To operate the cigarette lighter, press it in and release it. When it is heated, it automatically pops out ready for use.

If the engine is not running, the ignition switch must be in the ACC position for the lighter to operate.

* NOTICE

- Do not hold the lighter in after it is already heated because it will overheat.
- Only a genuine Kia lighter or equivalent should be used in the cigarette lighter socket. The use of plug-in accessories (shavers, hand-held vacuums, and coffee pots, for example) may damage the socket or cause electrical failure.
- If the lighter does not pop out within 30 seconds, remove it to prevent overheating.

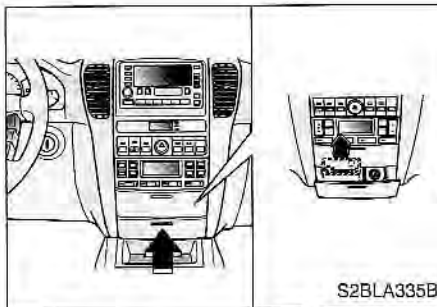

Ashtrays

Front ashtray

To use the ashtray, press the front face and release it to allow the cigarette lighter and ashtray to slowly extend from center panel.

To remove the ashtray, grasp the ashtray bucket and carefully pull it out.

▲ WARNING -Ashtray Use

- Do not use the vehicle's ashtrays as waste receptacles.
- Putting lit cigarettes or matches in an ashtray with other combustible materials may cause a fire.



Rear Ashtray

You can open the rear ashtray by pulling it out by its top edge. To remove the ashtray to empty or clean, push the tab inside, lift it up slightly and pull it all the way out.

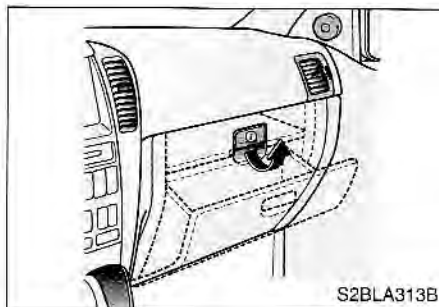

Glove Box

The glove box door can be locked or unlocked with a key. To open the glove box door, pull the latch out and let the glove box open.

⚠ WARNING

To reduce the risk of injury in case of an accident or sudden stop, always keep the glove box door closed while driving.

*** NOTICE**

Do not leave valuables in the glove box to avoid theft.

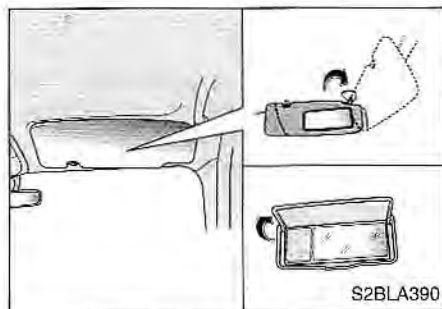

Sunvisors

To use a sunvisor, pull it downward.

To use a sunvisor for a side window, pull it downward, unsnap it from the bracket and swing it to the side.

Vanity Mirror

To use the vanity mirror, pull down the visor and pull up the mirror cover then the lamp, comes ON. If you don't use the mirror, you must close the cover to prevent the battery from being discharged.

MANUAL CLIMATE CONTROL SYSTEM

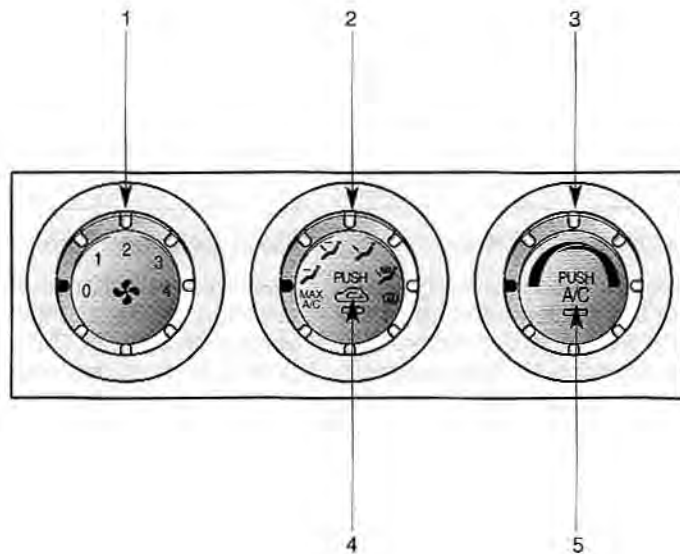

1. Fan speed control knob
2. Mode selection knob
3. Temperature control knob
4. Air flow control button
5. Air conditioning button

S4BLA464

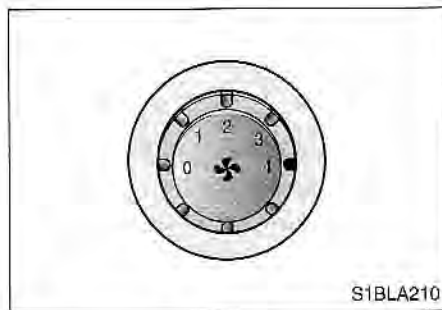

Fan Speed Control Knob

Four (4) adjustable fan speeds are provided which increase as the number increases. The ignition switch must be in the ON position for fan operation.

- 0 - Fan off
- 1 - Low speed
- 2 - Medium speed
- 3 - High speed
- 4 - Maximum speed

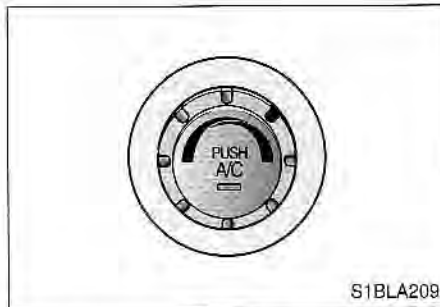

Temperature Control Knob

The temperature control knob allows you to control the temperature of the air flowing from the ventilation system. To change the air temperature in the passenger compartment turn the knob to the right for warm and hot air or left for cooler air.

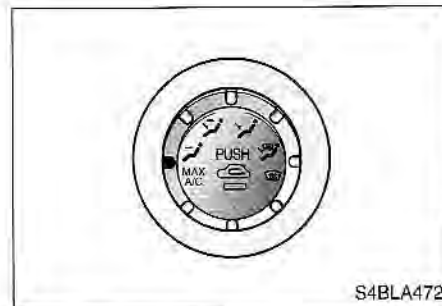

Mode Selection Knob

The mode selection knob controls the direction of the air flow through the ventilation system. The air from outlet port D flows at any mode. Close the ventilation outlets using the knob to block the air flow if you do not want the air.

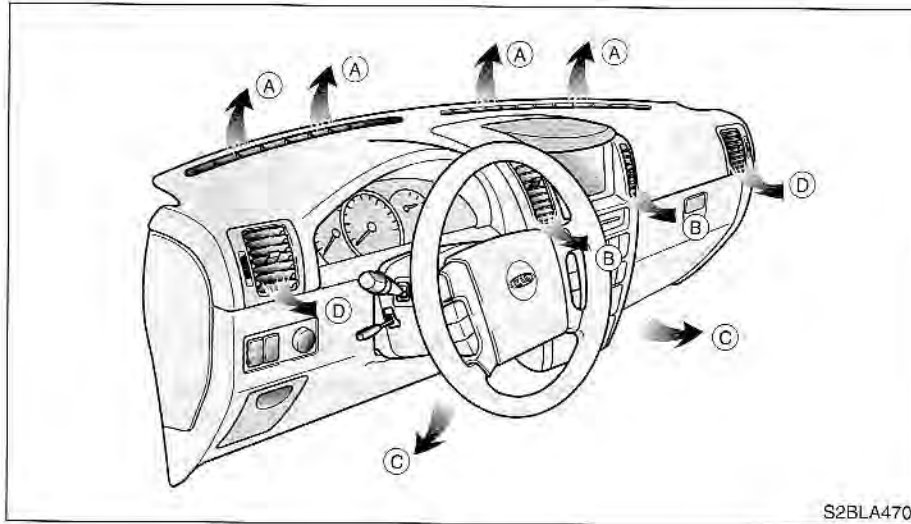
**Face position**

Air flow is directed toward the upper body and face. Additionally, each outlet can be controlled to direct the air discharged from the outlet. (outlet port: Ⓑ, Ⓓ)

Face - floor position

Air flow is directed towards the face and the floor. The air to the floor is warmer than the air to the face (except when the temperature control is set to the extreme cold position). (outlet port: Ⓑ, Ⓒ, Ⓓ)

Floor position

Most of the air flow is directed to the floor, with a small amount of the air being directed to the windshield and side window defroster. (outlet port: Ⓒ, Ⓓ)

Floor - defrost position



Most of the air flow is directed to the floor and the windshield with a small amount directed to the side window defrosters.

(outlet port: (A), (C), (D))

Defrost position



Most of the air flow is directed to the windshield with a small amount of air directed to the side window defrosters.

(outlet port: (A), (D))

MAX/ A/C position



When you select the MAX A/C mode while the fan speed is on, it will be set the system automatically as follows;

- the air conditioning system will be turned on.
- the recirculated air position will be selected.
- the face mode will be selected.

If you select the MAX A/C mode, you could not cancel the A/C system and the recirculated air position.

Set the fan speed control knob to desired speed and rotate the temperature control knob to the extreme left position.

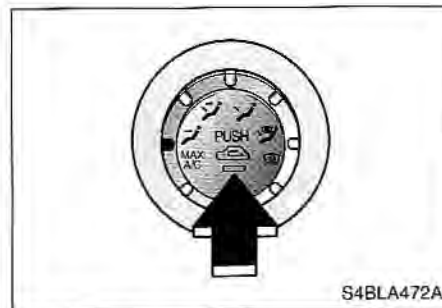

S4BLA472A

Air Flow Control Button

It is recommended that under normal conditions the outside (fresh) air position be selected.

Recirculated air position

If you press the air intake control button once (recirculate), almost all outside air flow into the vehicle is shut off, and air within the vehicle will be recirculated.

This position can be used temporarily for maximum heating or cooling (if equipped with an air conditioning) and to help prevent undesirable outside air flow into the vehicle.

CAUTION

Continued climate control system operation in the recirculated air position may allow humidity to increase inside the vehicle which may fog the glass and obscure visibility.

WARNING

Don't sleep in a vehicle with air conditioning system or heating system on. It may cause serious harm or death to passengers due to a drop in the oxygen level and/or body temperature.

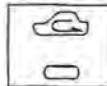
Outside (fresh) air position

If you press the air intake control button again, the air position will be changed to outside (fresh) air and air will enter the ventilation system from outside the vehicle. Use this position for normal ventilation and heating.

The air flow control will be set at outside (fresh) air position automatically if any of following occur.

- The ignition switch is OFF.
- The fan speed control is OFF (0).
- When you select the floor, floor-defrost or defrost mode position while the system is activated.

If you want the recirculated air position, press the corresponding button.

To cancel the forced outside (fresh) air position, refer to the canceling procedure in "Windshield Defrosting and Defogging" section.

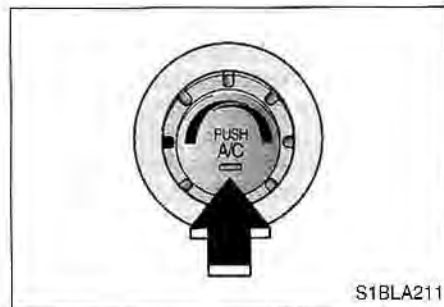

Air Conditioning Button (If equipped)



Push the A/C button to turn the air conditioning system on. The indicator light in the button will illuminate when the fan speed control knob is on. Push the button again to turn the air conditioning system off.

System Operation

Ventilation



1. Set the mode selection knob to the  position.
2. Set the air intake control button to the outside (fresh) air position.
3. Set the temperature control knob to the desired position.
4. Set the fan speed control knob to the desired speed.

Heating

1. Set the mode selection knob to the  position.
2. Set the air intake control button to the outside (fresh) air position.
3. Set the temperature control knob to the desired position.
4. Set the fan speed control knob to the desired speed.
5. If dehumidified heating is desired, turn the air conditioning system on.
 - If cool air is desired at face level for bi-level operation, set the mode selection knob to the  position.
 - If the windshield fogs up, set the mode selection knob to the  position.

Air conditioning

All Kia Air Conditioning Systems are filled with environmentally friendly R134a refrigerant which is not damaging to the ozone layer.

1. Start the engine. Push the air conditioning button.
 2. Set the mode selection knob to the face  position.
 3. Set the air intake control button to the outside air or recirculated air position.
 4. Set the temperature control knob to the desired position.
 5. Set the fan speed control knob to the desired speed.
 6. Adjust the fan speed control knob and temperature control knob to maintain maximum comfort.
- If warmer air is desired at floor level for bi-level operation, set the mode selection knob to the  position and adjust the temperature control knob to maintain maximum comfort.
 - When maximum cooling is desired, rotate the temperature control knob to the extreme left position and set the air intake control button to the recirculated air position, then set the fan speed control knob to the highest speed.

*** NOTICE**

When using the air conditioning system, monitor the temperature gauge closely while driving up hills or in heavy traffic when outside temperatures are high. Air conditioning system operation may cause engine overheating. Continue to use the blower fan but turn the air conditioning system off if the temperature gauge indicates engine overheating.

Air Conditioning System Operation Tips

- If the vehicle has been parked in direct sunlight during hot weather, open the windows for a short time to let the hot air inside the vehicle escape.
- To help reduce moisture inside of windows on rainy humid days, decrease the humidity inside the vehicle by operating the air conditioning system.
- During air conditioning system operation, you may occasionally notice a slight change in engine speed at idle as the air conditioning compressor cycles on. This is a normal system operation characteristics.
- Use the air conditioning system every month if only for a few minutes.
- After the use of the air conditioning system, you may notice clear water dripping (or even puddling) on the ground under the passenger side of the vehicle. This is a normal system operation characteristics.
- The air conditioning system includes a function that will automatically turns the air conditioning compressor off if engine coolant temperature approaches an over heating level. The air conditioning compressor operation will resume once engine coolant temperature returns to the normal range. Also, the air conditioning compressor is automatically turned off for a few seconds when the accelerator is fully depressed.
- When operating the air conditioning system use the outside (fresh) air position.
- Operating the air conditioning system in the recirculated air position does provide maximum cooling, however, continual operation in this mode may cause the air inside the vehicle to become stale.

AUTOMATIC CLIMATE CONTROL SYSTEM (IF EQUIPPED)

The automatic climate control system is controlled by simply setting the desired temperature.

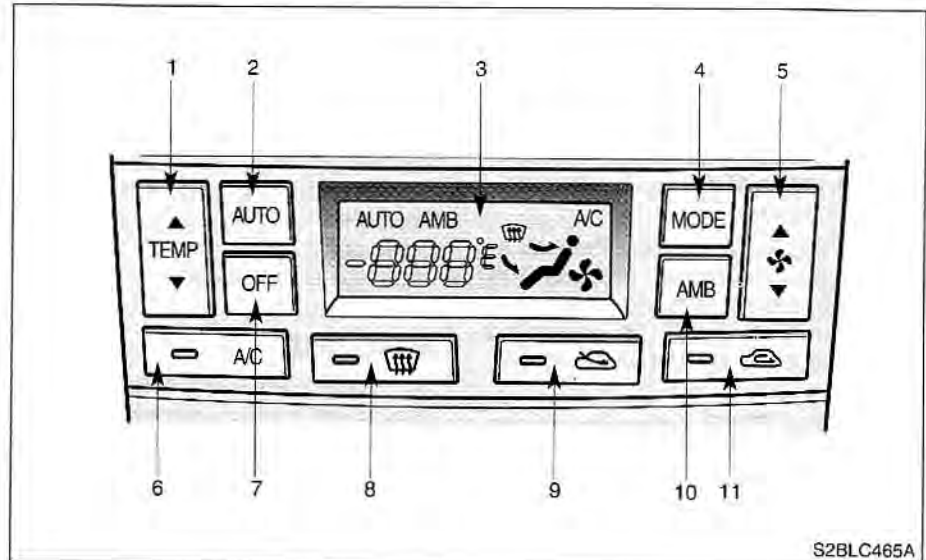

S2BLC465A

- | | |
|------------------------------------|--|
| 1. Temperature Control Button | 7. OFF Button |
| 2. AUTO (Automatic Control) Button | 8. Defrost Button |
| 3. Indicator Light | 9. Outside (fresh) Air Position Button |
| 4. Mode Selection Button | 10. AMB (ambient) Button |
| 5. Fan Speed Control Button | 11. Recirculated Air Position Button |
| 6. Air Conditioning Button | |

Automatic Operation

AUTO

The Full Automatic Temperature Control (FATC) system automatically controls the heating and cooling system as follows:

1. Push the AUTO button. The indicator light will come on and the modes, fan speeds, air intake and air-conditioning will be controlled automatically by temperature setting.
2. Push the TEMP button to set the desired temperature.

If the temperature setting is 17°C (62°F), the air conditioning system will operate continuously.

3. To turn the automatic operation off, press any button except temperature control button and AMB button. If you press the mode selection button, air-conditioning button, defrost button, air intake control button, fan speed button, the selected function will be controlled manually while other functions operate automatically.

*** NOTICE**

Never place anything over the sensor located on the instrument panel to ensure better control of the heating and cooling system.

*** NOTICE**

If the battery has been discharged or disconnected, the temperature mode will reset as Centigrade degree.

This is normal condition and you can adjust the temperature mode from Centigrade to Fahrenheit as follows:

Press the temperature down button 3 seconds or more with the AMB button held down. The display shows that the unit of temperature is adjusted to Centigrade or Fahrenheit.

Manual Operation

The heating and cooling system can be controlled manually as well by pushing buttons other than the AUTO button. In this case, the system sequentially works according the order of buttons selected.

The functions of the buttons which are not selected will be controlled automatically.

Press the AUTO button in order to convert to automatic control of the system.

Temperature Control Button

A rectangular button with the word "TEMP" in bold, uppercase letters.

The temperature will increase to the maximum 32°C (90°F) by pushing the up button. Each push of the button will cause the temperature to increase by 0.5 °C (1°F).

The temperature will decrease to the minimum 17°C (62°F) by pushing the down button. Each push of the button will cause the temperature to decrease by 0.5°C (1°F).

Ambient Button

A rectangular button with the word "AMB" in bold, uppercase letters.

The ambient temperature will be displayed for 5 seconds. before returning to the previous indication.

If you press AMB button again, the previous indication will be displayed.

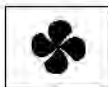

Fan Speed Control Button



The fan speed can be set to the desired speed by pressing the appropriate fan speed control button.

The higher the fan speed is, the more air is delivered.

Pressing the "OFF" button turns off the fan.

-  - Fan off
-  - Low speed
-  - Medium speed
-  - High speed
-  - Maximum speed

Air Flow Control Button

This is used to select outside (fresh) air position or recirculated air position.

To change the air intake control position, push the control button.

Recirculated air position

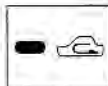

The indicator light is illuminated when the air intake control is in recirculated air position.

With the recirculated air position selected, air from passenger compartment will be drawn through the heating system and heated or cooled according to the function selected.

Outside (fresh) air position

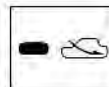

The indicator light on the button is illuminated when the air intake control is set to the outside (fresh) air position.

With the outside (fresh) air position selected, air enters the vehicle from outside and is heated or cooled according to the function selected.

The system will automatically switch to the outside (fresh) air position whenever the ignition is turned ON.

To cancel the automatic outside (fresh) air selection, refer to the cancel procedure in the windshield defrosting and defogging section.

*** NOTICE**

It should be noted that prolonged operation of the heating in recirculated air position will cause fogging of the windshield and side windows and the air within the passenger compartment will become stale.

In addition, prolonged use of the air conditioning with the "recirculated air position" selected, will result in excessively dry air in the passenger compartment.

CAUTION

Continued climate control system operation in the recirculated air position may allow humidity to increase inside vehicle which may fog the glass and obscure visibility.

WARNING

Do not sleep in a vehicle with air conditioning system or heating system on. It may cause serious harm or death due to a drop in the oxygen level and/or body temperature.

Mode Selection Button**MODE**

The mode selection button controls the direction of the air flow through the ventilation system.

The air flow outlet port is same as manual climate control system.

**Face position**

Air flow is directed toward the upper body and face. Additionally, each outlet can be controlled to direct the air discharged from the outlet. (outlet port: Ⓑ, Ⓓ)

Face - floor position



Air flow is directed towards the face and the floor. The air to the floor is warmer than the air to the face (except when the temperature control is set to the extreme cold position). (outlet port: **B**, **C**, **D**)

Floor position



Most of the air flow is directed to the floor, with a small amount of the air being directed to the windshield and side window defroster. (outlet port: **C**, **D**)

Floor - defrost position



Most of the air flow is directed to the floor and the windshield with a small amount directed to the side window defrosters. (outlet port: **A**, **C**, **D**)

The air conditioning will automatically on based on the ambient temperature and outside(fresh) air position will be selected automatically. If you don't want the air-conditioning or outside (fresh) air position press the corresponding button to cancel the operation.

Defrost Button

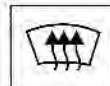

Most of the air flow is directed to the windshield with a small amount of air directed to the side window defrosters. (outlet port: **A**, **D**)

When the defrost button is pressed the outside (fresh) air position will automatically selected and the air will be discharged through the windshield defrost vents. The air conditioning will automatically operate based on ambient temperature. If you don't want the air-conditioning or outside (fresh) air position press the corresponding button to cancel the operation.

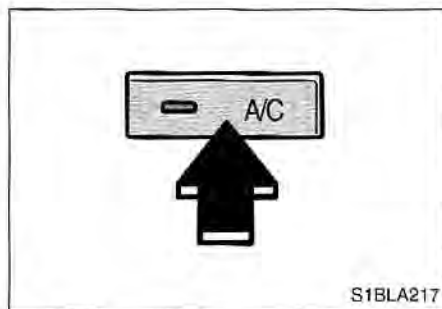

Air Conditioning Button

Push the A/C button to turn the air conditioning system on. The indicator light in the button will illuminate when the fan speed control knob is on. Push the button again to turn the air conditioning system off.

WINDSHIELD DEFROSTING AND DEFOGGING (MANUAL TYPE)

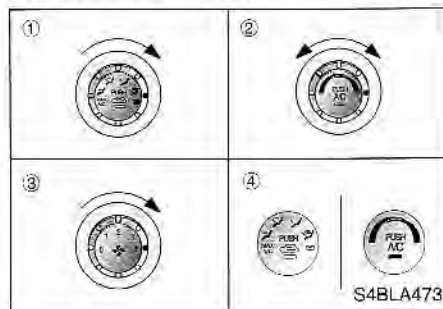

To Defog Inside Windshield

1. Select the floor-defrost (🚗❄️) or defrost (🚗🌫️) position.
2. Select desired temperature.
3. Select any fan speed except "0".
4. The outside (fresh) air will be selected.

If you don't want the outside (fresh) air position press the corresponding button to cancel the operation.

⚠️ CAUTION

Do not use defrost (🚗❄️) or (🚗🌫️) position during cooling operation in extremely humid weather. The difference between the temperature of the outside air and that of the windshield could cause the outer surface of the windshield to fog up, causing loss of visibility. In this case, set the mode selection knob to the (🚗🌬️) position and fan speed control knob to the lower speed.

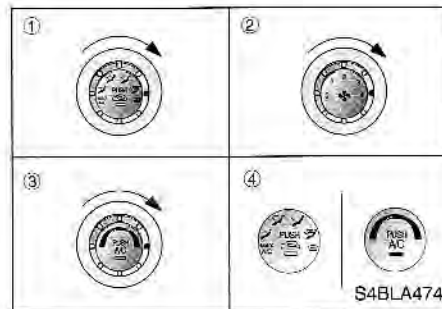

To Defrost Outside Windshield

1. Select the defrost (🚗🌫️) position.
2. Set the fan speed to the "3" or "4" position.
3. Set the temperature to the extreme hot position.
4. The outside (fresh) air will be selected.

If you don't want the outside (fresh) air position press the corresponding button to cancel the operation.

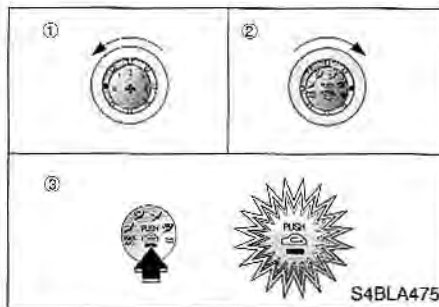

- For maximum defrosting, set the temperature control knob to the extreme right/hot position and the fan speed control knob to the highest speed.
- If warm air to the floor is desired while defrosting or defogging, set the mode selection knob to the floor-defrost position.
- Before driving, clear all snow and ice from the windshield, rear window, outside rear view mirrors, and all side windows.
- Clear all snow and ice from the hood and air inlet in the cowl grill to improve heater and defroster efficiency and to reduce the probability of fogging up inside of the windshield.



How to cancel automatic outside (fresh) air position in the Floor, Floor-Defrost and Defrost position:

When you select the Floor, Floor-Defrost or Defrost position, the outside (fresh) air position will be selected automatically.

If you don't want the outside (fresh) air position when operating in either of these modes, you can turn off the automatic outside (fresh) air position by performing the following:

1. Make sure the engine is running or the ignition switch is in the ON position.
2. Turn the fan speed control knob to the "0" position.
3. Turn the mode selection knob to the defrost () position.
4. Push the air intake control button () at least 5 times within 3 seconds.

Then the indicator light on the air intake control button will blink 3 times with 0.5 second intervals between blinks.

If you want to return to the automatic outside (fresh) air position, repeat the procedure above.

WINDSHIELD DEFROSTING AND DEFOGGING (AUTOMATIC TYPE)

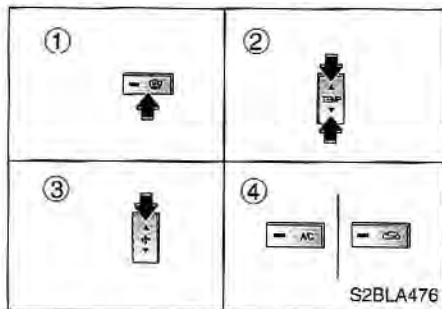

To Defog Inside Windshield

1. Press the defrost button ().
2. Select desired temperature.
3. Select any fan speed except OFF () position.
4. The air-conditioning will be turned on according to the detected ambient temperature and outside (fresh) air position will be selected.

If you don't want the air-conditioning or outside (fresh) air position press the corresponding button to cancel the operation.

CAUTION

Do not use defrost position during cooling operation in extremely humid weather. The difference between the temperature of the outside air and that of the windshield could cause the outer surface of the windshield to fog up, causing loss of visibility. In this case, set the mode selection knob to the position and fan speed control knob to the lower speed.

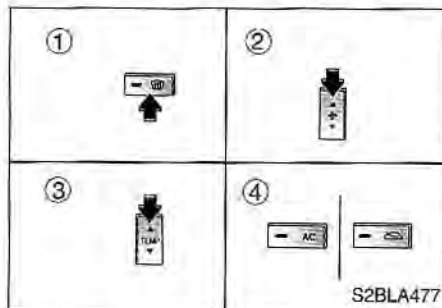

To Defrost Outside Windshield

1. Press the defrost button ().
2. Set the fan speed to the or position.
3. Set temperature to the extreme hot (25°C~32°C) position.
4. The air-conditioning will be turned on according to the detected ambient temperature and outside (fresh) air position will be selected.

If you don't want the air-conditioning or outside (fresh) air position press the corresponding button to cancel the operation.

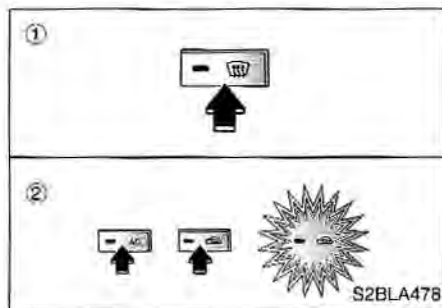

How to cancel forced air-conditioning operation and outside (fresh) air position in floor-defrost and defrost position ;

When you select the Floor-Defrost or Defrost position, the system automatically turns on the air-conditioning system and the outside (fresh) air position will be selected.

If you don't want air-conditioning and the outside (fresh) air position when operating in either of these modes, you can turn off the air-conditioning system operation by performing the following:

1. Make sure the engine is running or the ignition switch is in the ON position.
2. Select the defrost position pressing the defrost (☃) button.
3. While holding the air conditioning button A/C depressed, depress the recirculated air position button (↻) at least 5 times within 3 seconds.

The indicator light in the recirculated air position button (↻) will blink 3 times with 0.5 second of interval.

If you want to return to the automatic air conditioning system and outside (fresh) air position, repeat the procedure above.

Follow the same procedure if you want to cancel or return to the forced outside (fresh) air position when you start the engine with recirculated air position selected manually before the engine off.

DRIVING TIPS

Fuel Requirements	5-2
Emission Control System	5-3
Tips on Driving Your Vehicle	5-5
Suggestions for Economical Operation	5-6
Special Driving Conditions	5-8
Using Four-Wheel Drive	5-14
Trailer Towing	5-32
Overloading	5-41
Label Information	5-41

FUEL REQUIREMENTS

Your new Kia vehicle must use only unleaded fuel having an octane rating of at least 87.

Your new Kia is designed to obtain maximum performance with UNLEADED FUEL, as well as minimize exhaust emissions and spark plug fouling.

*** NOTICE**

NEVER USE LEADED FUEL. The use of leaded fuel is detrimental to the catalytic converter and will damage the engine control system's oxygen sensor and affect emission control.

Never add any fuel system cleaning agents to the fuel tank other than what Kia has specified.

(Consult an authorized Kia dealer for details.)

Gasoline Containing Alcohol and Methanol

Gasohol, a mixture of gasoline and ethanol (also known as grain alcohol), and gasoline or gasohol containing methanol (also known as wood alcohol) are being marketed along with or instead of leaded or unleaded gasoline.

Do not use gasohol containing more than 10% ethanol, and do not use gasoline or gasohol containing any methanol. Either of these fuels may cause driveability problems and damage to the fuel system.

Discontinue using gasohol of any kind if driveability problems occur.

Vehicle damage or driveability problems may not be covered by the manufacturer's warranty if they result from the use of:

1. Gasohol containing more than 10% ethanol.
2. Gasoline or gasohol containing methanol.
3. Leaded fuel or leaded gasohol.

*** NOTICE**

Never use gasohol which contains methanol. Discontinue use of any gasohol product which impairs driveability.

EMISSION CONTROL SYSTEM

The emissions control system of your vehicle is covered by a written limited warranty. Please see the warranty information contained in the Warranty and Consumer Information Manual in your vehicle.

Vehicle Modifications

This vehicle should not be modified. Modification of your Kia could affect its performance, safety or durability and may even violate governmental safety and emissions regulations.

In addition, damage or performance problems resulting from any modification may not be covered under warranty.

Engine Exhaust Gas Precautions (Carbon Monoxide)

WARNING

Engine exhaust gases contain carbon monoxide (CO). Though colorless and odorless, it is dangerous and could be lethal if inhaled. Follow the instructions following to avoid CO poisoning.

- Carbon monoxide can be present with other exhaust fumes. Therefore, if you smell exhaust fumes of any kind inside your vehicle, have it inspected and repaired immediately by an authorized Kia dealer. If you ever suspect exhaust fumes are coming into your vehicle, drive it only with all the windows fully open. Have your vehicle checked and repaired immediately.

- Do not operate the engine in confined or closed areas (such as garages) any more than what is necessary to move the vehicle in or out of the area.
- When the vehicle is stopped in an open area for more than a short time with the engine running, adjust the heating or cooling system (as needed) to draw outside air into the vehicle.
- Never sit in a parked or stopped vehicle for any extended time with the engine running.

Operating Precautions for Catalytic Converters

⚠ WARNING - Fire

A hot exhaust system can ignite flammable items under your vehicle. Do not park the vehicle over or near flammable objects, such as dry grass, paper, leaves, etc.

Your vehicle is equipped with a catalytic converter emission control device.

Therefore, the following precautions must be observed:

- Use only UNLEADED FUEL.
- Do not operate the vehicle when there are signs of engine malfunction, such as misfire or a noticeable loss of performance.
- Do not misuse or abuse the engine. Examples of misuse are coasting with the ignition off and descending steep grades in gear with the ignition off.

- Do not operate the engine at high idle speed for extended periods (5 minutes or more).
- Do not modify or tamper with any part of the engine or emission control system. All inspections and adjustments must be made by a qualified technician.

Failure to observe these precautions could result in damage to the catalytic converter and to your vehicle. Additionally, such actions could void your warranties.

⚠ WARNING

Your Full-time Four-Wheel Drive vehicle must never be tested on a two-wheel dynamometer. Serious transmission damage and uncontrolled vehicle movement could result.

TIPS ON DRIVING YOUR VEHICLE

Before Entering Vehicle:

- Be sure that all windows, outside mirror(s), and outside lights are clean.
- Check the condition of the tires.
- Check under the vehicle for any sign of leaks.
- Be sure there are no obstacles behind you if you intend to back up.

Necessary Inspections

Fluid levels, such as engine oil, engine coolant, brake/clutch fluid, and washer fluid should be checked on a regular basis, with the exact interval depending on the fluid. Further details are provided in the "Maintenance" section.

Before Starting

- Close and lock all doors.
- Position the seat so that all controls are easily reached.
- Adjust the inside and outside rearview mirrors.
- Be sure that all lights work.
- Check all gauges.
- Check the operation of warning lights when the ignition switch is turned to the ON position.
- Release the parking brake and make sure the brake warning light goes out.

For safe operation, be sure you are familiar with your vehicle and its equipment.

WARNING

- Driving Under the Influence of Alcohol or Drugs

Drinking and driving is dangerous. Drunk driving is the number one contributor to the highway death toll each year. Even a small amount of alcohol will affect your reflexes, perceptions and judgement.

You are much more likely to have a serious accident if you drink and drive.

If you are drinking or taking drugs, don't drive. Do not ride with a driver who has been drinking or taking drugs. Choose a designated driver or call a cab.

Driving while under the influence of drugs is as dangerous or more dangerous than driving drunk.

SUGGESTIONS FOR ECONOMICAL OPERATION

Your vehicle's fuel economy depends mainly on your style of driving, where you drive and when you drive.

Each of these factors affects how many miles (kilometers) you can get from a gallon (liter) of fuel. To operate your vehicle as economically as possible, use the following driving suggestions to help save money in both fuel and repairs:

- Avoid lengthy warm-up idling. Once the engine is running smoothly, begin driving. Remember, engine warm-up may take a little longer on cold days.
- Save fuel by accelerating slowly after stopping.
- Keep the engine in tune and follow the recommended periodic maintenance schedule. This will increase the life of all parts and lower your operating costs.
- Do not use the air conditioner unnecessarily.
- Slow down when driving on rough roads.
- For longer tire life and better fuel economy, always keep the tires inflated to the recommended pressures.
- Maintain a safe distance from other vehicles to avoid sudden stops. This will reduce wear on brake linings and pads. Driving in such a way will also save fuel because extra fuel is required to accelerate back to driving speed.
- Do not carry unnecessary weight in the vehicle.
- Do not rest your foot on the brake pedal while driving. This can cause needless wear, possible damage to the brakes, and poor fuel economy.

- Improper wheel alignment results in faster tire wear and lower fuel economy.
- Open windows at high speeds can reduce fuel economy.
- Fuel economy is less in crosswinds and headwinds. To help offset some of this loss, slow down when driving in these conditions.

Keeping a vehicle in good operating condition is important both for economy and safety. Therefore, have an authorized Kia dealer perform scheduled inspections and maintenance.

⚠ WARNING**- Engine off During Motion**

Never turn the engine off while the vehicle is in motion. The power steering and power brakes will not work with the engine off. Instead of coasting downhill with the engine off, downshift to an appropriate gear for engine braking effect.

SPECIAL DRIVING CONDITIONS

Hazardous Driving Conditions

When hazardous driving conditions are encountered such as water, snow, ice, mud, sand, or similar hazards, follow these suggestions:

- Drive cautiously and allow extra distance for braking.
- Avoid sudden movements in braking or steering.
- When braking in the four-wheel drive mode (if equipped), pump the brake pedal with a light up-and-down motion until the vehicle is stopped.

* NOTICE

Do not pump the brake pedal on ABS equipped vehicle.

- If stalled in snow, mud, or sand, use second gear or shift the transfer case (if equipped) into four-wheel drive. Accelerate slowly to avoid spinning the drive wheels.
- Use sand, rock salt, tire chains, or other non-slip material under the drive wheels to provide traction when stalled in ice, snow, or mud. (If equipped, refer to "Using Four-Wheel Drive.")

⚠ WARNING - Downshifting
On slippery surfaces, downshifting can cause an accident. The sudden change in tire speed could cause the tires to skid. Be careful when downshifting on slippery surfaces. Try to drive slowly enough so you won't have to make any sudden changes in gear or vehicle speed.

Rocking the Vehicle

If it is necessary to rock the vehicle to free it from snow, sand, or mud, first turn the steering wheel right and left to clear the area around your front wheels. Then, shift back and forth between 1 (First) and R (Reverse) in vehicles equipped with a manual transmission or R (Reverse) and any forward gear in vehicles equipped with an automatic transmission. Do not race the engine, and spin the wheels as little as possible. If you are still stuck after a few tries, have the vehicle pulled out by a tow vehicle to avoid engine overheating and possible damage to the transmission, transfer case (if equipped), or differential.

* NOTICE

Prolonged rocking may cause engine over-heating, transmission or transfer case (if equipped) damage or failure, and tire damage.

WARNING - Spinning Tires

Do not spin the wheels, especially at speeds more than 35 mph (56 km/h). Spinning the wheels at high speeds when the vehicle is stationary could cause a tire to overheat, explode and injure bystanders.

Driving at Night

Because night driving presents many more hazards than driving in the daylight, here are some important tips to remember:

- Slow down and keep more distance between you and other vehicles, as it may be more difficult to see at night, especially in areas where there may not be any street lights.
- Adjust your mirrors to reduce the glare from other driver's headlights.
- Keep your headlights clean and properly aimed. Dirty or improperly aimed headlights will make it much more difficult to see at night.
- Avoid staring directly at the headlights of oncoming vehicles. You could be temporarily blinded, and it will take several seconds for your eyes to readjust to the darkness.

Driving in the Rain

Rain and wet roads can make driving dangerous, especially if you're not prepared for the slick pavement. Here are a few things to consider when driving in the rain:

- A heavy rainfall will make it harder to see and will increase the distance needed to stop your vehicle, so slow down.
- Keep your windshield wiping equipment in good shape. Replace your windshield wiper blades when they show signs of streaking or missing areas on the windshield.
- If your tires are not in good condition, making a quick stop on wet pavement can cause a skid and possibly lead to an accident. Be sure your tires are in good shape.

- Turn on your headlights to make it easier for others to see you.
- Driving too fast through large puddles can affect your brakes. If you must go through puddles, try to drive through them slowly.
- If you believe your brakes may have become wet, apply them lightly while driving until normal braking operation returns.

Winter Driving

- We recommend that you carry emergency equipment, including tire chains, a window scraper, windshield de-icer, a bag of sand or salt, flares, a small shovel and jumper cables.
- Make sure you have sufficient ethylene-glycol coolant in the radiator.
- Check the battery condition and cables. Cold temperatures reduce the capacity of any battery, so it must be in excellent condition to provide enough winter starting power.
- Make sure the engine oil viscosity is suitable for cold weather.
- Check the ignition system for loose connections and damage.

- Use antifreeze-formulated windshield washer fluid. (Do not use engine coolant antifreeze.)
- Do not use the parking brake if it might freeze. When parking, shift to 1 (First) or R (Reverse) with a manual transmission or P (Park) with an automatic transmission, and block the rear wheels.

Snow Tires

If you mount snow tires on your Kia, make sure they are radial tires of the same size and load range as the original tires. Mount snow tires on all four wheels to balance your vehicle's handling in all weather conditions. Keep in mind that the traction provided by snow tires on dry roads may not be as high as your vehicle's original equipment tires. You should drive cautiously even when the roads are clear. Check with the tire dealer for maximum speed recommendations.

 **WARNING**
- Snow Tire Size

Snow tires should be equivalent in size and type to the vehicle's standard tires. Otherwise, the safety and handling of your vehicle may be adversely affected.

Do not install studded tires without first checking local, provincial and municipal regulations for possible restrictions against their use.

Driving in Flooded Areas

Avoid driving through flooded areas unless you are sure the water is no higher than the bottom of the wheel hub. Drive through any water slowly. Allow adequate stopping distance because brake performance may be affected.

After driving through water, dry the brakes by gently applying them several times while the vehicle is moving slowly.

Reducing the Risk of a Rollover

This multi-purpose passenger vehicle is defined as a Sports Utility Vehicle (SUV). SUV's have higher ground clearance and a narrower track to make them capable of performing in a wide variety of off-road applications. Specific design characteristics give them a higher center of gravity than ordinary cars. An advantage of the higher ground clearance is a better view of the road, which allows you to anticipate problems. They are not designed for cornering at the same speeds as conventional passenger drive vehicles, any more than low-riding sports cars are designed to perform satisfactorily in off-road conditions. Due to this risk, driver and passengers are strongly recommended to buckle their seatbelts.

In a rollover crash, an unbelted person is more likely to die than a person wearing a seatbelt. There are steps that a driver can make to reduce the risk of a rollover. If at all possible, avoid sharp turns or abrupt maneuvers, do not load your roof rack with heavy cargo, and never modify your vehicle in any way.

Rollover Warning Label

To remind you of the danger of the rollover, a rollover warning label which is now required by Federal Safety regulations is adhered to the driver's sunvisor.

⚠ WARNING - Rollover

As with other Sports Utility Vehicle (SUV), failure to operate this vehicle correctly may result in loss of control, an accident or vehicle rollover.

- **Specific design characteristics (higher ground clearance, narrower track, etc.) give this vehicle a higher center of gravity than ordinary cars.**
- **An SUV is not designed for cornering at the same speeds as conventional 2-wheel drive vehicles.**
- **Avoid sharp turns or abrupt maneuvers.**
- **In a rollover crash, an unbelted person is significantly more likely to die than a person wearing a safety belt. Make sure everyone in the vehicle is properly buckled up.**



To remind you of the danger of the rollover, the rollover warning label is adhered to the driver's sunvisor. If you close the driver's sunvisor, you can see the rollover warning label located at the side of the air bag warning label.

USING FOUR-WHEEL DRIVE

Driving on Snow- or Ice-Covered Roads (“4HI, 4LO” for Part-time 4WD Operation or “AUTO” for Full-time 4WD Operation)

- Use snow tires. See “Tires” in this section for more information.
- Keep an adequate distance between yourself and other vehicles.
- Avoid sudden braking, acceleration or steering. These actions can cause your vehicle to lose traction.

Driving in Sand or Mud (“4HI, 4LO” for Part-time 4WD Operation or “AUTO” for Full-time 4WD Operation)

- Avoid sudden braking, acceleration or steering. These actions can cause your vehicle to get stuck in the sand or mud.
- Drive at low speeds whenever possible.
- You may need to get out of your vehicle at times to check road conditions.
- If you get stuck in the sand or mud, try placing stones, wood or other similar materials under the tires to get traction, or move forward and backward repeatedly to get unstuck.

WARNING - Traction

Make sure that no one stands in front of or behind the tires when materials are placed under the tires to get more traction. The tires may cause loose materials to fly out from under the vehicle, potentially causing serious bodily injury or death.

*** NOTICE**

Prolonged rocking may cause engine damage, overheating, transmission differential or transfer case damage or failure and tire damage.

Driving on a Hill (“4LO” for Part-time 4WD Operation or “LOW” for Full-time 4WD operation)

- Use low gear when going uphill or downhill and avoid sudden braking.
- Do not shift gears or use your clutch when going downhill. Do not coast downhill in Neutral.

Crossing a Ditch (“4LO” for Part-time 4WD Operation or “LOW” for Full-time 4WD operation)

- Avoid driving through ditches if possible, especially if there is water in the ditch. Your vehicle may stall if the electrical system gets wet. If you must cross a ditch, shift the transfer knob to 4LO or LOW.
- Avoid driving where the water level is higher than the bottom of the wheel hub. If the water level rises above this mark, your vehicle will need to be serviced.
- Tap lightly on the brake pedal during and after driving through water. This will help keep the brakes dry and in proper working order.
- Do not shift gears while crossing a ditch.

Tight Corner Brake Effect** CAUTION**

When turning sharply on a paved road at low speed while in four-wheel drive, steering control will be difficult.

This is called tight corner brake effect. Tight corner brake effect is a unique characteristic of four-wheel drive vehicles caused by the difference in tire rotation at the four wheels and the zero-degree alignment of the front wheels and suspension.

Sharp turns at low speeds should be carried out with caution.

Off-Road Driving with Your Four-Wheel Drive Vehicle

Off-road driving can be great fun. But it has definite hazards. The greatest of these is the terrain itself.

"Off-roading" means you've left the paved road system behind. Traffic lanes are not marked. Curves are not banked.

There are no carefully engineered road signs to warn you of dangerous conditions or to advise you of a safe speed. You have to assess the environment yourself. Surfaces can be slippery, rough, uphill or downhill.

Off-road driving involves learning new skills. That's why it's important that you read and understand this section. You'll find useful driving information and suggestions. These will help make your off-road driving safer and more enjoyable.

▲ WARNING - Rollover

As with other Sports Utility Vehicles (SUVs), failure to operate this vehicle correctly may result in loss of control, an accident or vehicle rollover.

- **Specific design characteristics (higher ground clearance, narrower track, etc.) give this vehicle a higher center of gravity than ordinary cars.**
- **A SUV is not designed for cornering at the same speeds as conventional 2-wheel drive vehicles.**
- **Avoid sharp turns or abrupt maneuvers.**
- **In a rollover crash, an unbelted person is significantly more likely to die than a person wearing a safety belt. Make sure everyone in the vehicle is properly buckled up.**

Before you go Off-Roading

There are some things to do before you leave the paved roads. Be sure to have all necessary maintenance and service work done beforehand. Be sure to read all the information about your four-wheel drive vehicle in this manual. Is there enough fuel? Is the spare tire fully inflated? Are the fluid levels at the proper levels? What are the local laws that apply to off-roading where you'll be driving? If you don't know, you should check with law enforcement people in the area. Will you be on someone's private land? If so, be sure to get the necessary permission.

Loading your vehicle for Off-Road Driving

There are some important items to remember about how to properly load your vehicle.

- The heaviest things should be in the cargo area and forward of your rear axle. Place heavier items as far forward as you can.
- Be sure the load is properly secured, so driving over off-road terrain doesn't shift your load or throw items toward the driver or passengers.

⚠ WARNING - Cargo

- **Cargo piled close to the height of (or higher than) the seat backs can be thrown forward during a sudden stop or on downhill slopes. You or your passengers could be severely injured. Keep cargo below the top of the seat backs and, if possible, do not pile separate items.**
- **Unsecured cargo in the cargo area can be tossed about when driving on the highways or over rough terrain. You or your passengers can be struck by flying objects and severely injured. Secure the cargo properly.**

(Continued)

(Continued)

- **Cargo should not be carried on the roof without a proper roof rack installed. The roof rack will hold a maximum of 100 lbs. (45 kg). Heavy loads in a roof rack raise the vehicle's center of gravity, making it more likely to roll over. You can be seriously or fatally injured if the vehicle rolls over. Do not load cargo on the roof while driving off-road, if at all possible. Put heavy loads inside the cargo area, not on the roof or in a roof rack. Keep cargo in the cargo area as far forward and low as possible.**

Traveling to Remote Areas

It makes sense to plan your trip, especially when going to a remote area. Know the terrain and plan your route. You are much less likely to encounter unwanted surprises. Get accurate maps of trails.

It's also a good idea to travel with at least one other vehicle. If something happens to one of them, the other can quickly help.

Getting Familiar with Off-Road Driving

It's necessary for you to practice in an area that's safe and close to home before you begin serious off-road driving. Off-road driving requires new and different driving skills.

You need to tune your senses to different kinds of signals. For example, constantly sweep the terrain with your eyes looking for unexpected obstacles. Listen for unusual tire, gear, or engine sounds. Feel and respond to the vibrations of the vehicle with your hands, feet, and body while still carefully controlling your vehicle. You'll also need to adjust your expectations and greatly lower the number of miles you expect to cover in an hour or a day.

Controlling your vehicle is the key to successful off-road driving. One of the best ways to control your vehicle is to control your speed. Here are some things to keep in mind when traveling at higher speeds:

- You approach things faster and you have less time to scan the terrain for obstacles.
- You have less time to react.
- You have much more vehicle bounce when you drive over obstacles, giving you less vehicle control.
- You'll need more distance for braking, especially since you're on an unpaved surface. Such terrain will always be more "slippery" than a paved road.

⚠ WARNING**- Off Road Driving**

When you're driving off-road, bouncing and quick changes in direction can easily throw you out of position. This could cause you to lose control of the vehicle and crash. So, whether you are driving on or off the road, you and your passengers should always wear safety belts.

Scanning the terrain

Off-road driving can take you over many different kinds of terrain. You need to be familiar with the terrain and its many different features. Here are some things to consider.

Surface conditions

Off-roading can take you over hard-packed dirt, gravel, rocks, grass, sand, mud, snow or ice. Each of these surfaces affects the steering, acceleration, and braking of your vehicle in different ways.

Depending upon the kind of surface you are on, you may experience slipping, sliding, wheel spinning, delayed acceleration, poor traction, and longer braking distances.

Surface obstacles

Unseen or hidden obstacles can be hazardous. A rock, log, hole, rut, or bump can startle you if you're not prepared. Often these obstacles are hidden by grass, bushes, snow or even the rise and fall of the terrain itself. Here are some things to constantly evaluate:

- Is the path ahead clear?
- Will the surface texture change ahead?
- Does the path take you uphill or downhill?
- Might you have to stop suddenly or change direction quickly?

When you drive over obstacles or rough terrain, it is critical that you keep a firm grip on the steering wheel. Ruts, troughs, or other surface features can force the wheel out of your hands if you're not prepared.

When you drive over bumps, rocks, or other obstacles, your wheels can leave the ground. If this happens, even with one or two wheels, you can't control the vehicle as well or perhaps at all. Because you will be on an unpaved surface, it's especially important to avoid sudden acceleration, sudden turns, or sudden braking. Any of these actions could cause the center of gravity of the vehicle to shift and destabilize the vehicle, leading to a collision or rollover accident.

Off-road driving requires a different kind of alertness from driving on paved roads and highways. There are no road signs, posted speed limits or signal lights. You have to use your own judgment about what is safe and what isn't. Bad judgment in this uncontrolled environment can be fatal.

WARNING

- Drinking & Driving

Drinking and driving, or drug use and driving can be very dangerous on any road. This certainly remains true for off-road driving. At the very time you need special alertness and driving skills, your reflexes, perceptions and judgement can be affected by even a small amount of alcohol or drugs. You could have a serious - or even fatal - accident if you drink or take drugs and drive or ride with a driver who has been drinking or taking drugs.

Driving on Off-Road Hills

Off-road driving often takes you up, down, or across a hill. Driving safely on hills requires excellent judgment and an understanding of what your vehicle can and can't do. There are some hills that simply should not be driven.

⚠ WARNING**- Driving on Hills**

Many hills are simply too steep for any vehicle. If you drive up them, you will stall. If you drive down them, you can't control your speed. In either case, you could flip over. If you drive across them, you will roll over. You could be seriously or fatally injured. If you have any doubt about the steepness, don't drive up or down the hill, even if it means that you have to turn around and find another route. Re-tracking is a normal part of safe off-roading.

Approaching a hill

When you approach a hill, you need to decide if it's one of those hills that's just too steep to climb, descend, or cross. Steepness can be difficult to judge. On a very small hill, for example, there may be a smooth, constant incline with only a small change in elevation where you can easily see all the way to the top. On a large hill, the incline may get steeper as you near the top, but you may not see this because the crest of the hill is hidden by bushes, grass, or shrubs.

Here are some other things to consider as you approach a hill:

- Is there a constant incline, or does the hill get sharply steeper in places?
- Is there good traction on the hillside, or will the surface cause tire slipping?

- Is there a straight path up or down the hill so you won't have to make turning maneuvers?
- Are there obstructions on the hill that can block your path (boulders, trees, logs or ruts)?
- What's beyond the hill? Is there a cliff, an embankment, a drop-off, or a fence? Get out of the vehicle and walk the hill if you are unsure. It's the smart way to find out.
- Is the hill simply too rough? Steep hills often have ruts, gullies, troughs, and exposed rocks because they are more susceptible to the effects of erosion.
- How have weather conditions affected the terrain? Is there likely to be mud, snow or ice on the hill?
- What time of day is it? Are temperatures dropping so that wet surfaces will start to freeze?

Driving uphill

Once you decide you can safely drive up the hill, you need to take some special steps.

- Use a low gear and get a firm grip on the steering wheel.
- Get a smooth start up the hill and try to maintain your speed. Don't use more power than you need, because you don't want your wheels to start spinning or sliding.
- Try to drive straight up the hill, if at all possible. If the path twists and turns, you may have to find another route.



WARNING

- Driving Across Hills

Turning or driving across steep hills can be dangerous. You could lose traction, slide sideways, or just reach an area too steep to traverse. In any case, it could cause you to roll over. You could be seriously or fatally injured. When driving up hills, always try to go as straight up as possible.

- Slow down as you approach the top of the hill.
- Attach a flag to the vehicle to make you more visible to approaching traffic on trails or hills.
- Sound the horn as you approach the top of the hill to let opposing traffic know you're there.
- Use your headlights even during the day. They make you more visible to other drivers.

▲ WARNING - Driving over Hills

Driving to the top (crest) of a hill at full speed can cause an accident and result in serious or fatal injury. There could be a drop-off, embankment, cliff, another vehicle or people sitting on the ground. As you near the top of a hill, slow down and stay alert.

Stalling while Driving Uphill

What should I do if my vehicle stalls, or is about to stall, and I can't make it up the hill?

If your vehicle stalls, or is about to stall while driving uphill, there are some things you should do, and there are some things you must not do. First, here's what you should do:

- Push the brake pedal to stop the vehicle and keep it from rolling backwards. Also, apply the parking brake.
- If your engine is still running, shift the transmission into reverse, release the parking brake, and slowly back down the hill in reverse.
- If your engine has stopped running, you'll need to restart it. With the brake pedal depressed and the parking brake still applied, shift a manual transmission to N (Neutral), or an automatic transmission to P (Park) and restart the engine. Then, shift to reverse, release the parking brake, and slowly back down the hill in reverse.
- As you are backing down the hill, put your left hand on the steering wheel at the 12 o'clock position. This way, you'll be able to tell if your wheels are straight or turned to the left or right as you back down.

Here are some things you must not do if you stall, or are about to stall, when going up a hill.

- Never attempt to prevent a stall by depressing the clutch or shifting to N (Neutral) to “rev-up” the engine and regain forward momentum. This won’t work. Your vehicle will roll backwards very quickly and you could go out of control or roll over.

Instead, apply the brake to stop the vehicle. Then apply the parking brake. Shift into reverse, release the parking brake, and slowly back down.

⚡ CAUTION

Never attempt to turn around if you are about to stall when going up a hill. If the hill is steep enough to stall your vehicle, it's steep enough to cause you to roll over if you turn around. If you can't make it up, you must back down the hill.

Stalled on a Steep Uphill

If your vehicle stalls and you can't back down the hill, try this: Set the parking brake, put your transmission in 1 (First) gear or P (Park), and turn the engine off. Leave the vehicle and get some help. If your vehicle is at an angle to the slope of the hill, exit the vehicle on the uphill side and stay clear of the path the vehicle would take if it rolled downhill. Leave it in 1 (First) gear for manual transmission or P (Park) for automatic transmission.

▲ WARNING
- Exiting Vehicle

Getting out on the downhill (low) side of a vehicle stopped across an incline is dangerous. If the vehicle rolls over, you could be crushed or fatally injured. Always get out on the uphill (high) side of the vehicle and stay well clear of the rollover path.

▲ WARNING
- Leaving Vehicle

If you are going to leave your vehicle, set the parking brake and shift a manual transmission to 1(First), or an automatic transmission to P (Park).

Driving Downhill

When off-roading takes you downhill, you'll want to consider many of the same things you thought about before you went uphill. As a brief reminder, those include:

- How steep is the downhill? Will I be able to maintain vehicle control?
- What's the surface like? Smooth? Rough? Slippery? Hard-packed dirt? Gravel?
- Are there hidden surface obstacles? Ruts? Logs? Boulders?
- What's at the bottom of the hill? Is there a hidden creek bank or even a river bottom with large rocks?
- Have changes in the weather conditions and their effect on the terrain since you went uphill made your task more difficult?

Once you have decided that you can go down a hill safely, try to keep your vehicle headed straight down, and use a low gear. This way, engine braking can help your brakes so they won't have to do all the work. Descend slowly, keeping your vehicle under control at all times.

⚡ CAUTION

Before beginning to go downhill, it is critical that you ensure that no cargo can shift forward while you are heading downhill. Such shifting could either endanger you and your occupants, or interfere with your ability to control the vehicle.

⚠ WARNING - Braking

Heavy braking when going down a hill can cause your brakes to overheat and fade. This could cause loss of control and a serious accident. Apply the brakes lightly when descending a hill and use a low gear to keep vehicle speed under control.

Avoid turns that take you across the incline of the hill. A hill that's not too steep to drive down may be too steep to drive across. You could roll over if you don't drive straight down.

Never go downhill with the clutch pedal depressed. This is called "free-wheeling." Your brakes will have to do all the work and could overheat and fade.

⚡ CAUTION

Avoid braking so hard that you lock the wheels when going downhill. If your front wheels are locked, you can't steer your vehicle.

If your wheels lock up during downhill braking, you may feel the vehicle starting to slide sideways. To regain your direction, just ease off the brakes and steer to keep the front of the vehicle pointing straight downhill.

Stalling downhill

Stalling is much more likely to happen going uphill. But if it happens going downhill, here's what to do.

- Stop your vehicle by applying the brakes. Then apply the parking brake.
- Move the shift lever to P (Park) in automatic transmissions or shift to N (Neutral) in manual transmissions and, while still braking, restart the engine.
- Shift back to a low gear, release the parking brake, and drive straight down.
- If the engine won't start, get out and seek help. Exit on the uphill side of the vehicle and stay clear of the path the vehicle would take if it rolled downhill.

Driving across an incline

Sooner or later, an off-road trail will probably go across the incline of a hill. If this happens, you have to decide whether or not to try to drive across the incline. Here are some things to consider:

- A hill that can be driven straight up or down may be too steep to drive across. When you go straight up or down a hill, the length of the wheel base (the distance from the front wheels to the rear wheels) reduces the likelihood the vehicle will tumble end over end. But when you drive across an incline, the much narrower track width (the distance between the left and right wheels) may not prevent the vehicle from tilting and rolling over. Also, driving across an incline puts more weight on the downhill wheels. This could cause a downhill slide or a rollover.

- Surface conditions can be a problem when you drive across a hill. Loose gravel, muddy spots, or even wet grass can cause your tires to slip sideways. If the vehicle slips sideways, it can hit something that will tip it (a rock, a rut, etc.) and cause it to roll over.
- Hidden obstacles can make the steepness of the incline even worse. If you drive across a rock with the uphill wheels, or if the downhill wheels drop into a rut or depression, your vehicle can tilt even more.

For reasons like these, you need to decide carefully whether or not to try to drive across an incline. Just because the trail goes across the incline doesn't mean you have to drive it.

⚠ WARNING - Roll Over

Driving across an incline that's too steep will make your vehicle roll over. You could be seriously or fatally injured. If you have any doubt about the steepness of the incline, don't drive across it. Find another route

If your vehicle slides downhill

If you feel your vehicle starting to slide sideways, turn downhill immediately. This should help straighten out the vehicle and prevent the side slipping. However, a much better way to prevent this is to get out and "walk the course" first so you know what the surface is like before you drive it.

Stalling while crossing an incline

If your vehicle stalls when you're crossing an incline, be sure you (and your passengers) get out on the uphill side, even if that door is harder to open. If you get out on the downhill side and the vehicle starts to roll over, you'll be in its path.

If you have to walk down the slope, stay out of the path the vehicle will take if it does roll over.

⚠ WARNING - Exiting Vehicle

Getting out on the downhill (low) side of a vehicle stopped across an incline is dangerous. If the vehicle rolls over, you could be crushed or fatally injured. Always get out on the uphill (high) side of the vehicle and stay well clear of the rollover path.

Driving in Mud, Sand, Snow, or Ice

When you drive in mud, sand, snow, or ice, your wheels won't get good traction. You can't accelerate as quickly, turning is more difficult, and you'll need longer braking distances.

It's best to use a low gear when you're in mud, the deeper the mud, the lower the gear. In extremely deep mud, the idea is to keep your vehicle moving so you don't get stuck.

When you drive on sand, you'll sense a change in wheel traction. But it will depend upon how loosely packed the sand is. On loosely packed sand (as on beaches or sand dunes) your tires will tend to sink into the sand.

This has an effect on steering, accelerating, and braking. You may want to reduce the air pressure in your tires slightly when driving on sand. This will improve traction. Remember to re-inflate them the first chance that you have after you leave the loosely packed sand.

*** NOTICE**

- **In case of loss of traction in mud, loose soil, or sand, turn the steering wheel rapidly from side-to-side. This can help generate additional traction.**
- **Do not gun the engine. This will cause the tires to spin and dig down, not forward, and could bury the vehicle to the frame. Smooth, easy power is better than too much power.**

Hard-packed snow and ice offer the worst tire traction. On these surfaces, it's very easy to lose control. On wet ice, for example, the traction is so poor that you will even have difficulty accelerating. And if you do get moving, poor steering and difficult braking can easily cause you to slide out of control.

▲ WARNING**- Frozen Surfaces**

Driving on frozen lakes, ponds or rivers can be dangerous. Underwater springs, currents under the ice, or sudden thaws can weaken the ice. Your vehicle could fall through the ice and you and your passengers could drown. Drive your vehicle on safe surfaces only.

Driving in Water

Light rain causes no special off-road driving problems. However, heavy rain can cause flash flooding, and flood waters demand extreme caution.

Find out how deep the water is before you drive through it. If it's deep enough to cover your wheel bearing hubs, axles, or exhaust pipe, don't try it. You probably won't get through. Also, water that deep can damage your axle and other vehicle parts.

If the water isn't too deep, then drive through slowly. At fast speeds, water can splash on your ignition system and your vehicle can stall. Stalling can also occur if your tailpipe goes underwater. As long as your tailpipe is underwater, you will not be able to start your engine. When you go through water, remember that it may take you longer to stop when your brakes are wet.

If you have driven through water that was deep enough to cover your wheel bearing hubs, it may be a good idea to have an authorized Kia dealer repack your front wheel bearings and examine your rear-end fluid for evidence of water.

After Off-Road Driving

Remove any brush or debris that has collected on the underbody, chassis or under the hood. These accumulations can be a fire hazard.

After driving in mud or sand, clean and check the brake linings. Accumulation of mud or sand can cause glazing and uneven braking. Check the body structure, steering, suspension, wheels, tires, and exhaust system for damage. Also, check the fuel lines and cooling system for any leakage. Your vehicle will also require more frequent service due to off-road use.

⚠ WARNING - Water

Driving through rushing water can be dangerous. Deep water can sweep your vehicle downstream and you and your passengers could drown. If it's only inches deep, it can still wash away the ground from under your tires, and you could lose traction and roll the vehicle. Never drive through rushing water.

TRAILER TOWING

▲ WARNING

- Towing a Trailer

If you don't use the correct equipment and drive properly, you can lose control when you pull a trailer. For example, if the trailer is too heavy, the brakes may not work well - or even at all. You and your passengers could be seriously or fatally injured. Pull a trailer only if you have followed all the steps in this section.

Maximum trailer weight:

- **Trailer without brake system:**
750 kg (1,650 lbs.)
- **Trailer with brake system:**
1,590 kg (3,500 lbs.)

*** NOTICE**

Pulling a trailer improperly can damage your vehicle and result in costly repairs not covered by your warranty. To pull a trailer correctly, follow the advice in this section.

Your vehicle can tow a trailer. To identify what the vehicle trailering capacity is for your vehicle, you should read the information in "Weight of the Trailer" that appears later in this section. Remember that trailering is different than just driving your vehicle by itself. Trailering means changes in handling, durability, and fuel economy. Successful, safe trailering takes correct equipment, and it has to be used properly.

This section contains many time-tested, important trailering tips and safety rules. Many of these are important for your safety and that of your passengers. Please read this section carefully before you pull a trailer.

Load-pulling components such as the engine, transmission, wheel assemblies, and tires are forced to work harder against the load of the added weight. The engine is required to operate at relatively higher speeds and under greater loads. This additional burden generates extra heat. The trailer also adds considerably to wind resistance, further increasing the pulling requirements.

If You Do Decide to Pull a Trailer

Here are some important points if you decide to pull a trailer:

- State, provincial, county and municipal government have varying trailering laws. Make sure your hitch, mirrors, lights and wiring arrangements are legal, not only where you live, but also where you'll be driving. A good source for this information is provincial or local law enforcement agencies.
- Consider using a sway control. You can ask a hitch dealer about sway control.

- After your odometer indicates 800 km or more, you can tow a trailer. For the first 800 km that you tow a trailer, don't drive over 80 km/h and don't make starts at full throttle. This helps your engine and other parts of your vehicle "wear" in at the heavier loads.
- Three important considerations have to do with weight:

Weight of the Trailer

How heavy can a trailer safely be? It should never weigh more than 1,590 kg (3,500 lbs.) with trailer brakes. But even that can be too heavy depending on the number of passengers.

It depends on how you plan to use your trailer. For example, speed, altitude, road grades, outside temperature and how much your vehicle is used to pull a trailer are all important. The ideal trailer weight can also depend on any special equipment that you have on your vehicle.

Weight of the Trailer Tongue

The tongue load of any trailer is an important weight to measure because it affects the total gross vehicle weight (GVW) of your vehicle. This weight includes the curb weight of the vehicle, any cargo you may carry in it, and the people who will be riding in the vehicle. And if you tow a trailer, you must add the tongue load to the GVW because your vehicle will also be carrying that weight.

The trailer tongue should weigh a maximum of 10% of the total loaded trailer weight. After you've loaded your trailer, weigh the trailer and then the tongue, separately, to see if the weights are proper. If they aren't, you may be able to correct them simply by moving some items around in the trailer.

Too little tongue load can make the trailer unstable and cause it to sway. Too much tongue load reduces front-tire traction and steering control.

WARNING

- **An improperly loaded trailer can cause loss of control of your vehicle.**
- **Never load a trailer with more weight in the rear than in the front. The front should be loaded with approximately 60% of the total trailer load; the rear should be loaded with approximately 40% of the total trailer load.**
- **Never exceed the maximum weight limits of the trailer or trailer towing equipment. Improper loading can result in damage to your vehicle and/or personal injury. Check weights and loading at a commercial scale or highway patrol office equipped with scales.**

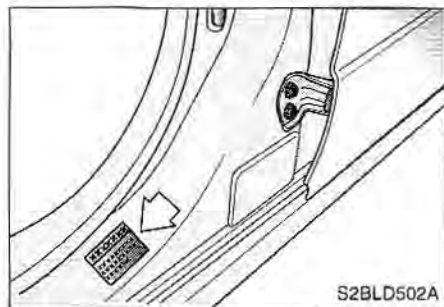

Total Weight on Your Vehicle's Tires

Be sure your vehicle's tires are inflated to the limit for cold tires. You'll find these numbers on the Tire Pressure label (or see "Label Information" in the Index). Be sure not to exceed the GVW limit for your vehicle.

Hitches

It's important to have the correct hitch equipment. Crosswinds, large trucks going by, and rough roads are a few reasons why you'll need the right hitch. Here are some rules to follow:

- Will you have to make any holes in the body of your vehicle when you install a trailer hitch?

If you do, then be sure to seal the holes later when you remove the hitch. If you don't seal them, deadly carbon monoxide (CO) from your exhaust can get into your vehicle, as well as dirt and water.

- The bumpers on your vehicle are not intended for hitches. Do not attach rental hitches or other bumper-type hitches to them. Use only a frame-mounted hitch that does not attach to the bumper.

Safety chains

You should always attach chains between your vehicle and your trailer. Cross the safety chains under the tongue of the trailer so that the tongue will not drop to the road if it becomes separated from the hitch. Instructions about safety chains may be provided by the hitch manufacturer or by the trailer manufacturer. Follow the manufacturer's recommendation for attaching safety chains. Always leave just enough slack so you can turn with your trailer. And, never allow safety chains to drag on the ground.

Trailer brakes

If your trailer weighs more than 1,650 pounds (750 kg) loaded, then it needs its own brakes – and they must be adequate. Be sure to read and follow the instructions for the trailer brakes so you'll be able to install, adjust and maintain them properly.

- Don't tap into your vehicle's brake system.
- Do not use a trailer with its own brakes unless you are absolutely certain that you have properly set up the brake system. This is not a task for amateurs. Use an experienced, competent trailer shop for this work.

Driving with a trailer

Towing a trailer requires a certain amount of experience. Before setting out for the open road, you must get to know your trailer. Acquaint yourself with the feel of handling and braking with the added weight of the trailer. And always keep in mind that the vehicle you are driving is now a good deal longer and not nearly so responsive as your vehicle is by itself.

Before you start, check the trailer hitch and platform, safety chains, electrical connector(s), lights, tires and mirror adjustment. If the trailer has electric brakes, start your vehicle and trailer moving and then apply the trailer brake controller by hand to be sure the brakes are working. This lets you check your electrical connection at the same time.

During your trip, check occasionally to be sure that the load is secure, and that the lights and any trailer brakes are still working.

Following distance

Stay at least twice as far behind the vehicle ahead as you would when driving your vehicle without a trailer. This can help you avoid situations that require heavy braking and sudden turns.

Passing

You'll need more passing distance up ahead when you're towing a trailer. And, because you're a good deal longer, you'll need to go much farther beyond the passed vehicle before you can return to your lane.

Backing up

Hold the bottom of the steering wheel with one hand. Then, to move the trailer to the left, just move your hand to the left. To move the trailer to the right, move your hand to the right. Always back up slowly and, if possible, have someone guide you.

Making turns

When you're turning with a trailer, make wider turns than normal. Do this so your trailer won't strike soft shoulders, curbs, road signs, trees, or other objects. Avoid jerky or sudden maneuvers. Signal well in advance.

Turn signals when towing a trailer

When you tow a trailer, your vehicle has to have a different turn signal flasher and extra wiring.

The green arrows on your instrument panel will flash whenever you signal a turn or lane change. Properly connected, the trailer lights will also flash to alert other drivers that you're about to turn, change lanes, or stop.

When towing a trailer, the green arrows on your instrument panel will flash for turns even if the bulbs on the trailer are burned out. Thus, you may think drivers behind you are seeing your signals when, in fact, they are not. It's important to check occasionally to be sure the trailer bulbs are still working. You must also check the lights every time you disconnect and then reconnect the wires.

Do not connect a trailer lighting system directly to your vehicle's lighting system.

Use only an approved trailer wiring harness. Your authorized Kia dealer can assist you in installing the wiring harness.

⚠ WARNING

Using an improper trailer wiring harness could lead to malfunctioning of your vehicles electrical system and a possible accident.

Trailer Connector

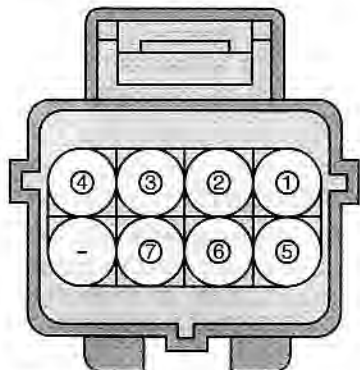

- ① Back up lamp
- ② Position lamp
- ③ Trailer accessory
- ④ Turn signal lamp (LH)
- ⑤ Turn signal lamp (RH)
- ⑥ Stop lamp
- ⑦ Earth

S2BLA550

You must check the capacity of the lighting system and electrical equipment for a trailer before connecting the wires.

- Trailer accessory : 120W and below
- Turn signal lamp : 27W × 2EA and below (Total : 4.2 A and below)
- Stop lamp : 27W × 2EA and below (Total : 4.2 A and below)
- Position lamp : 5W × 8EA and below (Total : 3.65 A and below)

Driving on grades

Reduce speed and shift to a lower gear before you start down a long or steep downgrade. If you don't shift down, you might have to use your brakes so much that they would get hot and no longer operate efficiently.

On a long uphill grade, shift down and reduce your speed to around 45 mph (70 km/h) to reduce the possibility of engine and transmission overheating.

If your trailer weighs more than 1650 lbs (750 kg) and you have an automatic transmission, you should drive in D (Drive) when towing a trailer.

Operating your vehicle in D (Drive) when towing a trailer will minimize heat buildup and extend the life of your transmission. If you have a manual transmission, drive in fourth gear (or, as you need to, a lower gear).

Parking on hills

Generally, you should not park your vehicle, with a trailer attached, on a hill. People can be seriously or fatally injured, and both your vehicle and the trailer can be damaged if they begin a downhill trajectory.

⚠ WARNING **- Parking on a Hill**

Parking your vehicle on a hill with an attached trailer could cause serious injury or fatal injury. If the brakes fail, the vehicle and trailer could roll down hill and strike people or property.

However, if you ever have to park your trailer on a hill, here's how to do it:

1. Apply your brakes, but don't shift into gear.
2. Have someone place chocks under the trailer wheels.
3. When the wheel chocks are in place, release the brakes until the chocks absorb the load.
4. Reapply the brakes. Apply your parking brake, and then shift to R (Reverse) for a manual transmission or P (Park) for an automatic transmission.
5. Be sure the transfer case (if equipped) is fully engaged in a drive gear – not in N (Neutral).
6. Release the brakes.

⚠ WARNING **- Parking Brake**

Not setting the parking brake when leaving the vehicle could lead to a serious accident.

If you have left the engine running, the vehicle can move suddenly. Always set the parking brake and take the key with you to be sure your vehicle is securely parked.

When You Are Ready to Leave After Parking on a Hill

1. With the manual transmission in Neutral or automatic transmission in P (Park), apply your brakes and hold the brake pedal down while you:
 - Start your engine;
 - Shift into gear; and
 - Release the parking brake.
2. Slowly remove your foot from the brake pedal.
3. Drive slowly until the trailer is clear of the chocks.
4. Stop and have someone pick up and store the chocks.

Maintenance When Trailer Towing

Your vehicle will need service more often when you regularly pull a trailer. Important items to pay particular attention to include engine oil, automatic transmission fluid, axle lubricant and cooling system fluid. Brake condition is another important item to frequently check. Each item is covered in this manual, and the Index will help you find them quickly. If you're trailering, it's a good idea to review these sections before you start your trip.

Don't forget to also maintain your trailer and hitch. Follow the maintenance schedule that accompanied your trailer and check it periodically. Preferably, conduct the check at the start of each day's driving. Most importantly, all hitch nuts and bolts should be tight.

* NOTICE

Due to higher load during trailer usage, overheating might occur in hot days or during uphill driving. If the coolant gauge indicates overheating, switch off the A/C and stop the vehicle in a safe area to cool down the engine.

OVERLOADING

⚠ WARNING - Weight Rating

The gross axle weight rating (GAWR) and the gross vehicle weight rating (GVWR) for your vehicle are on the manufacturer's label attached to the driver's door. Exceeding these ratings can cause an accident or vehicle damage. You can calculate the weight of your load by weighing the items (or people) before putting them in the vehicle. Be careful not to overload your vehicle.

LABEL INFORMATION

There are several important labels and identification numbers located on your vehicle. The label locations are identified in the illustrations on the following three pages.

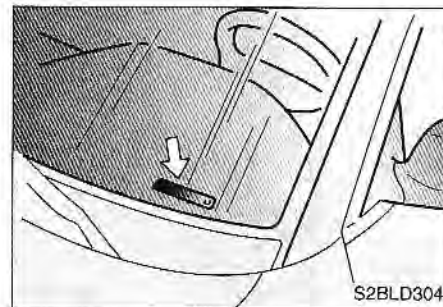

Vehicle Identification Number (VIN)

This is the legal identifier for your vehicle. It appears on a plate attached to the left side of the forward portion of the dashboard. The VIN plate can be easily seen from the outside of the vehicle through the windshield on the driver's side.

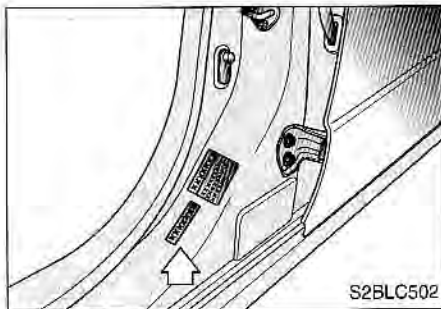

Vehicle Certification label (CMVSS label)

The VIN also appears on the vehicle's certification label and VIN label on the pillar,

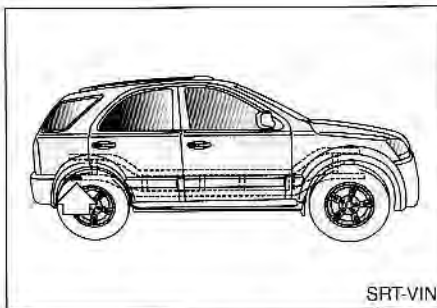

Frame Vehicle Identification Number

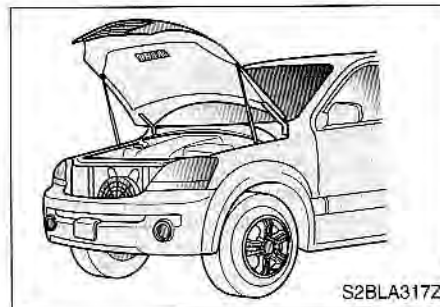

Vehicle Emission Control Information/Vacuum Hose Routing Diagram

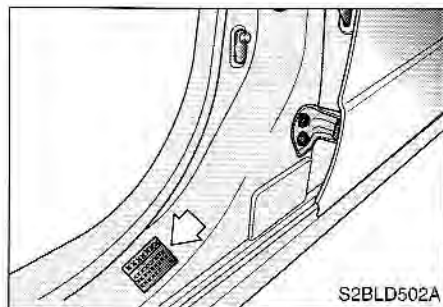

Tire Information Label

IN CASE OF AN EMERGENCY

Road Warning	6-2
Overheating	6-3
Emergency Starting	6-4
Electrical Circuit Protection	6-7
Towing	6-13
If You Have a Flat Tire	6-19

ROAD WARNING

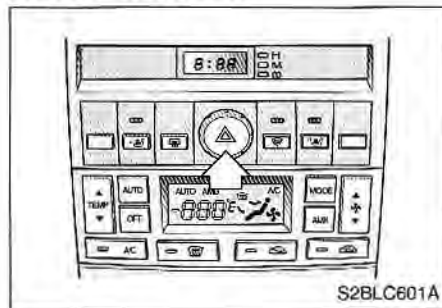

Hazard Warning Flasher

The hazard warning flasher serves as a warning to other drivers to exercise extreme caution when approaching, overtaking, or passing your vehicle. It should be used whenever emergency repairs are being made, when the vehicle is stopped near the edge of a roadway, or whenever your vehicle is in distress.

Depress the flasher switch to activate at any time. The flasher switch is located in the center console switch panel. All turn signal lights will flash simultaneously.

- The hazard warning flasher operates whether your vehicle is running or not.
- The turn signals do not work when the hazard flasher is on.
- Care must be taken when the hazard warning flasher is used while the vehicle is being towed. Local regulations may prohibit using it in this manner.

OVERHEATING

If your temperature gauge indicates overheating, if you experience a loss of power, or if you hear a loud knocking or pinging noise, the engine has probably overheated. Should any of these symptoms occur, use the following procedure:

1. Turn on the hazard warning flasher, then drive to the nearest safe location and stop your vehicle; shift to Neutral (manual transaxle) or Park (automatic transaxle) and apply the parking brake.
2. Make sure the air conditioner is off.
3. If coolant or steam is boiling out of the radiator, stop the engine and call an authorized Kia dealer for assistance.

If there is no visible coolant, you may allow the engine to idle and open the hood to permit the engine to cool gradually.

If the temperature does not go down with the engine idling, stop the engine and allow sufficient time for it to cool.

4. The coolant level should then be checked. Use the coolant reservoir dipstick to check the level. If the level in the reservoir is low, look for leaks at the radiator hoses and connections, heater hoses and connections, radiator, and water pump. If you find a major leak or another problem that may have caused the engine to overheat, do not operate the engine until it has been corrected. Call an authorized Kia dealer for assistance. If you do not find a leak or other problem, carefully add coolant to the reservoir.

WARNING

- Removing Radiator Cap

Never remove the radiator cap when the engine and radiator are hot. Scalding hot coolant and steam may blow out under pressure. This could cause serious injury.

If the engine frequently overheats, have the cooling system checked and repaired by an Authorized Kia Dealer.

EMERGENCY STARTING

Jump Starting

Jump starting can be dangerous if done incorrectly. Therefore, to avoid harm to yourself or damage to your vehicle or battery, follow the jump starting procedures on this page. If in doubt, we strongly recommend that you have a competent technician or towing service jump start your vehicle.

* NOTICE

Use only a 12-volt jumper system. You can damage a 12-volt starting motor, ignition system, and other electrical parts beyond repair by use of a 24-volt power supply (either two 12-volt batteries in series or a 24-volt motor generator set).

WARNING - Battery

Never attempt to check the electrolyte level of the battery as this may cause the battery to rupture or explode causing serious injury.

WARNING - Battery

- Keep all flames or sparks away from the battery. The battery produces hydrogen gas which may explode if exposed to flame or sparks.
- Do not attempt to jump start the vehicle if the discharged battery is frozen or if the electrolyte level is low; the battery may rupture or explode.

Jump starting procedure

1. Make sure the booster battery is 12-volt and that its negative terminal is grounded.
2. If the booster battery is in another vehicle, do not allow the vehicles to touch.

Connecting jumper cables

Connect cables in numerical order and disconnect in reverse order.

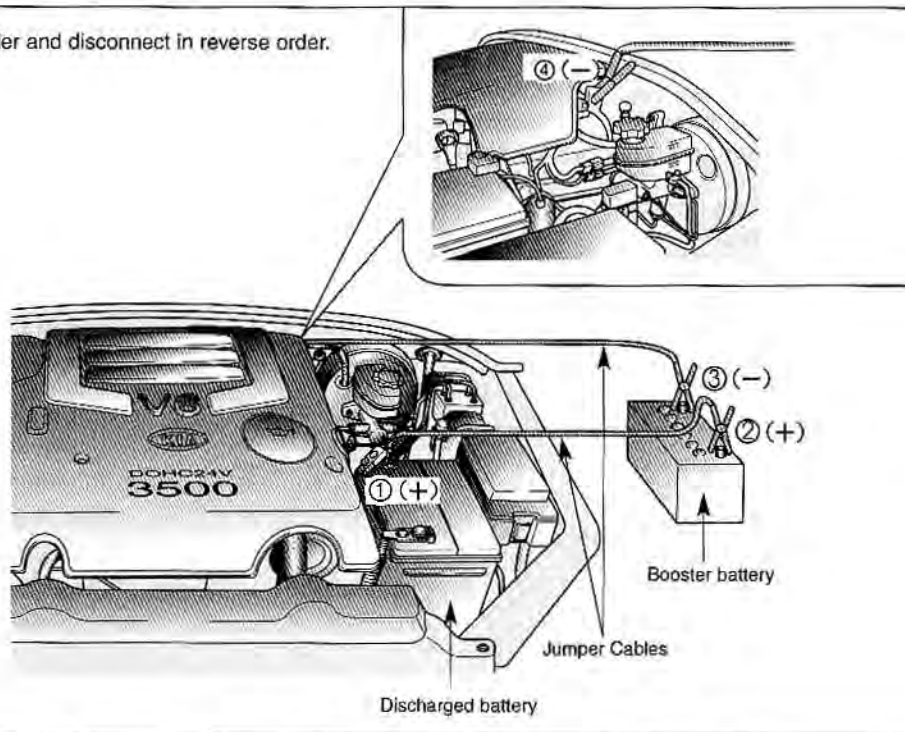

S2BLC701A

3. Turn off all unnecessary electrical loads.
 4. Connect the jumper cables in the exact sequence shown in the previous illustration. First connect one end of a jumper cable to the positive terminal of the discharged battery, then connect the other end to the positive terminal on the booster battery. Proceed to connect one end of the other jumper cable to the negative terminal of the booster battery, then the other end to a solid, stationary, metallic point (for example, the engine lifting bracket) away from the battery. Do not connect it to or near any part that moves when the engine is cranked. Do not connect the jumper cable from the negative terminal of the booster battery to the negative terminal of the discharged battery. Do not allow the jumper cables to contact anything except the correct battery terminals or the correct ground. Do not lean over the battery when making connections.
 5. Start the engine of the vehicle with the booster battery and let it run at 2,000 rpm, then start the engine of the vehicle with the discharged battery.
- If the cause of your battery discharge is not apparent, you should have your vehicle checked by an authorized Kia dealer.*

Push-Starting

Your manual transmission-equipped vehicle should not be push-started because it might damage the emission control system. Vehicles equipped with automatic transmissions cannot be push-started. Follow the directions for jump-starting in this manual.

CAUTION

Never tow a vehicle to start it because the sudden surge forward when the engine starts could cause a collision with the tow vehicle.

ELECTRICAL CIRCUIT PROTECTION

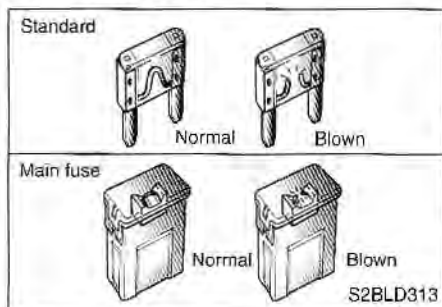

Fuses

A vehicle's electrical system is protected from electrical overload damage by fuses.

This vehicle has two fuse panels, one located in the driver's side kick panel, the other in the engine compartment near the battery.

If any of your vehicle's lights, accessories, or controls do not work, check the appropriate circuit fuse. If a fuse has blown, the element inside the fuse will be melted.

Always replace a blown fuse with one of the same rating.

If the same fuse blows again, avoid using the system involved and immediately consult an authorized Kia dealer.

Two kinds of fuses are used: standard for lower amperage rating and main for higher amperage ratings.

Fuse Replacement

⚠ WARNING

- Fuse Replacement

- **Never replace a fuse with anything but another fuse of the same rating.**
- **A higher capacity fuse could cause damage and possibly a fire.**
- **Never install a wire instead of the proper fuse – even as a temporary repair. It may cause extensive wiring damage and possibly a fire.**
- **Do not use a screwdriver or any other metal object to remove fuses because it may cause a short circuit and damage the system.**

If the electrical system does not work, first check the driver's side fuse panel.



1. Turn the ignition switch and all other switches off.
2. Pull the suspected fuse straight out. Use the removal tool provided on the main fuse box in the engine compartment fuse relay box (if equipped). Refer to the fuse panel chart on the fuse panel cover to identify the likely problem fuse or electrical circuit.

3. Check the removed fuse; replace it if it is blown. The number of fuses vary according to the vehicle model. Check both the passenger and engine compartment fuse box covers.

4. Push in a new fuse of the same rating, and make sure it fits tightly in the clips.

If it fits loosely, consult an authorized Kia dealer.

If you do not have a spare, use a fuse of the same rating from a circuit you may not need for operating the vehicle, such as the radio or room lamp fuse.

If the headlights or other electrical components do not work and the fuses are OK, check the fuse block in the engine compartment. If a fuse is blown, it must be replaced.

1. Turn the ignition switch and all other switches off.
2. Remove the fuse block cover by unhooking the tab on one end and tilting the cover back toward the other end.
3. Check the fuses. If one is blown, replace it with a new one of the same rating.

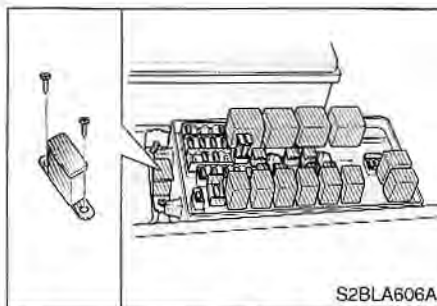
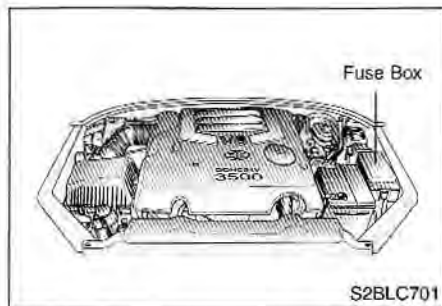

*** NOTICE**

After checking the fuse box in the engine compartment, securely install the fuse box cover. If not, electrical failures may occur from water leaking in.

If the 120A "MAIN" fuse is blown, it must be removed as follows:

1. Disconnect the negative battery cable.
2. Remove the bolts in the photo above.
3. Replace the fuse with a new one of the same 120A rating.
4. Reinstall in the reverse order of removal.

IN CASE OF AN EMERGENCY

Fuse panel description

Driver-side kick panel

1 (W/SHD 15A)	2 (S/ROOF 20A)	3 START 10A
4 HAZARD 15A	5 P/SCK(CTR) 15A	6 CIGAR (FRT) 15A
7 (DRL/OBD-II) 10A	8 WIPER(FRT) 20A	9 P/SCK (FRT,RR) 30A
10 (RELAY COIL) 10A	11 WIPER(RR) 10A	12 ACC 10A
13 (TCCS) 20A	14 (FOG (RR)) 15A	15 (O/S MIRROR) 10A
16 ROOM LAMP 10A	17 (S/WARMER) 20A	18 (PREMIUM AUDIO) 30A
19 STOP LAMP 20A	20 TURN LAMP 10A	21 (A/BAG) 10A
22 METER 10A	23 (TRAILER) 15A	24 ENGINE 10A

USE THE DESIGNATED FUSES ONLY.
() IS OPTION.

Description	FUSE RATING	PROTECTED COMPONENT
1. W/SHD	15 A	Defroster
2. S/ROOF	20 A	Sunroof
3. START	10 A	Starting system, PCM, ACC
4. HAZARD	15 A	Turn & Hazard flasher unit
5. P/SCK(CTR)	15 A	Center power socket
6. CIGAR (FRT)	15 A	Cigar lighter
7. DRL/OBD-II	10 A	Check connector
8. WIPER (FRT)	20 A	Wiper & Washer, Head light, Front heater & Aircon, Cooling system, Defroster
9. P/SCK (FRT, RR)	30 A	Front and rear power socket
10. RELAY COIL	10 A	Relay coil
11. WIPER (RR)	10 A	Wiper & Washer, ETWIS, Heater & Aircon, Trip computer, sunroof
12. ACC	10 A	Power mirror, Cigar lighter, Power Socket, Clock, Keyless entry, Audio
13. TCCS	20 A	Transfer case control unit
14. FOG (RR)	15 A	Rear fog lamp
15. O/S MIRROR	10 A	Electric remote control mirror
16. ROOM LAMP	10 A	Instrument cluster, ETWIS, Head light, DRL, Keyless entry, Room lamp, Sunviior lamp, Clock
17. S/WARMER	20 A	Seat warmer
18. PREMIUM AUDIO	30 A	Audio
19. STOP LAMP	20 A	Stop light
20. TURN LAMP	10 A	Turn & Hazard flasher unit
21. A/BAG	10 A	Airbag
22. METER	10 A	PCM, ACC, Trip computer, Stop light ,DRL, ETWIS, Instrument cluster, Front heater & Aircon
23. TRAILER	15 A	Trailer accessory
24. ENGINE	10 A	PCM, Cooling, Speed sensor, Diagnosis connector, ACC, Instrument cluster, ABS

Engine compartment

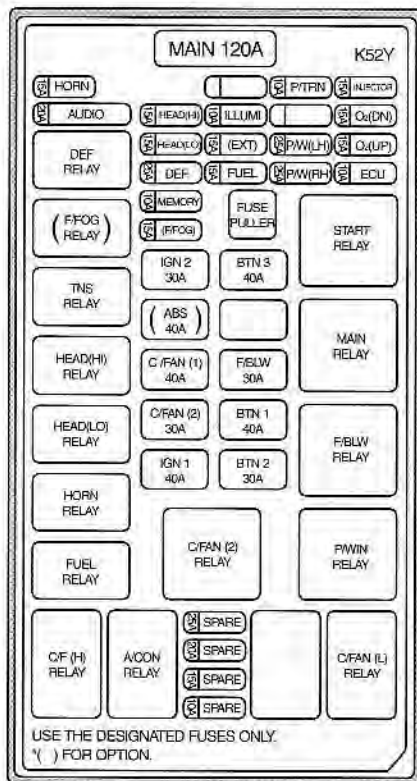

HORN	15 A	Horn
P/TRN	10 A	PCM, Main relay
INJECTOR	15 A	PCM
AUDIO	20 A	Audio
HEAD (HI)	15 A	Head Light
ILLUMI	10 A	Key hole illumination
O ₂ (DN)	15 A	PCM
HEAD (LO)	15 A	Head light
EXT	15 A	DRL, License lamp, Tail lamp, Position lamp, Turn lamp
P/W (LH)	25 A	Power window
O ₂ (UP)	15 A	PCM
DEF	25 A	Defroster
FUEL	15 A	Fuel pump relay
P/W (RH)	25 A	Power window
ECU	10 A	PCM, Cooling
MEMORY	10 A	Front heater & aircon, Etwis, Keyless entry system
F/FOG	15 A	Front fog lamp
IGN 2	30 A	Ignition switch
BTN 3	40 A	Turn & Hazard flasher unit, Power door lock
ABS 1	40 A	ABS
C/FAN (1)	40 A	Cooling system
F/BLW	30 A	Front heater & Aircon
C/FAN (2)	30 A	Cooling system
BTN 1	40 A	Cigar lighter, Power socket
IGN 1	40 A	Ignition switch
BTN 2	30 A	Power seat, PCM

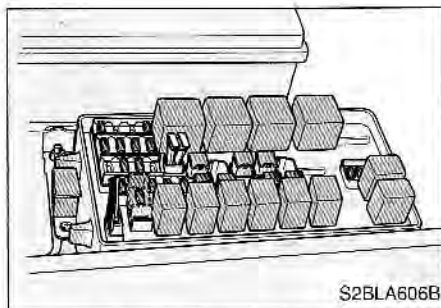

Memory fuse

Your vehicle is equipped with a "Memory Fuse" to prevent battery discharge if your vehicle is parked without being operated for prolonged periods. Use the following procedures before parking the vehicle for prolonged period.

1. Turn off the engine.
2. Turn off the headlights and tail lights.
3. Open the main fuse box cover in engine compartment and pull up the "AUDIO FUSE 20A". This will change the memory fuse mode to prevent battery discharge.

CAUTION

- *If the memory fuse is pulled up from the fuse box housing, the key reminder warning chime, door ajar warning chime and light, and clock will not operate. The clock must be reset.*
- *Even though the memory fuse is pulled up, the battery can still be discharged by operation of the headlights or other electrical devices.*

TOWING

If emergency towing is necessary, we recommend having it done by an Authorized Kia Dealer or a commercial tow-truck service. Proper lifting and towing procedures are necessary to prevent damage to the vehicle. Provincial and local laws applicable to towing vehicles must be followed. As a general rule, towed vehicles should be pulled with the driving wheels off the ground. If excessive damage or other conditions prevent towing the vehicle with the driving wheels of the ground, use wheel dollies.

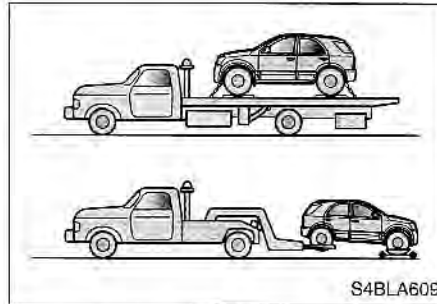

On 4WD Vehicles, it is recommended that your vehicle be towed with a wheel lift and dollies or flatbed equipment with all the wheels off the ground.



It is recommended that your vehicle be towed with a wheel lift or flatbed equipment. Do not tow with a sling-belt. Our company has not approved a slingbelt towing procedure.

* NOTICE

- Do not tow the vehicle forward with the front wheels on the ground as this may cause damage to the vehicle.
- Do not tow with sling-type equipment. Use wheel lift or flatbed equipment.

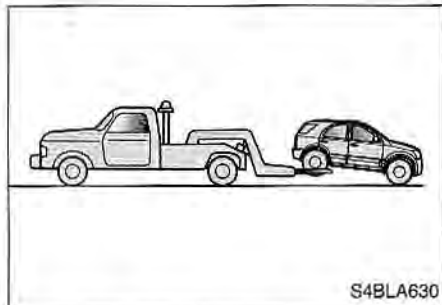

On 2WD vehicles, it is acceptable to tow the vehicle with the front wheels on the ground (without dollies) and the rear wheels off the ground.

When being towed by a commercial tow truck and wheel dollies are not used, the rear of the vehicle should always be lifted, not the front.

When towing your vehicle in an emergency without wheel dollies (2WD Vehicles or Part-time 4WD Vehicles):

1. Set the ignition switch in the ACC position.
2. Place the transmission shift lever in N (Neutral).
3. Place the transfer shift knob for part-time 4WD operation in the 2HI position.
4. Release the parking brake.

* NOTICE

Failure to place the transmission shift lever in N (Neutral) and the transfer shift knob for part-time 4WD operation to 2HI may cause internal damage to the transmission.



**Tie-down hook
(for flatbed towing)**

CAUTION

Do not use the hook under the rear of the vehicle for towing purposes. The hook is designed ONLY for transport tie-down. If the tie-down hook is used for towing, the tie-down hook will be damaged and this could lead to serious injury.

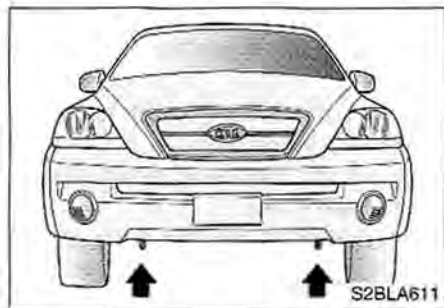

Towing with a vehicle other than a tow truck

If towing is necessary, we recommend you to have it done by an Authorized Kia dealer or a commercial tow truck service.

If towing service is not available in an emergency, your vehicle may be temporarily towed using a cable or chain secured to the emergency towing hook under the front of the vehicle. Use extreme caution when towing the vehicle.

A driver must be in the vehicle to steer it and operate the brakes.

Towing in this manner may be done only on hard-surfaced roads for a short distance and at low speeds. Also, the wheels, axles, power train, steering and brakes must all be in good condition.

- Do not try to tow your vehicle when the wheels are stuck in mud, sand or similar substances that prevent the vehicle from being driven out under its own power.
- Avoid towing a vehicle heavier than the vehicle doing the towing.
- The drivers of both vehicles should communicate with each other frequently.

⚡ CAUTION

Use extreme caution when towing the vehicle.

- ***Avoid sudden starts or erratic driving maneuvers which would place excessive stress on the emergency towing hook and towing cable or chain. The hook and towing cable or chain may break and cause serious injury or damage.***
- ***If the towing vehicle can hardly move, do not forcibly continue the towing. Contact an Authorized Kia dealer or a commercial tow truck service for assistance.***
- ***Tow the vehicle as straight ahead as possible.***
- ***Keep away from the vehicle during towing.***

*** NOTICE**

- **Attach a towing strap to the tow hook.**
- **Using a portion of the vehicle other than the tow hooks for towing may damage the body of your vehicle.**
- **Use only a cable or chain specifically intended for use in towing vehicles. Securely fasten the cable or chain to the towing hook provided.**

- **Before emergency towing, check that the hook is not broken or damaged.**
- **Fasten the towing cable or chain securely to the hook.**
- **Do not jerk the hook. Apply steady and even force.**
- **To avoid damaging the hook, do not pull from the side or at a vertical angle. Always pull straight ahead.**

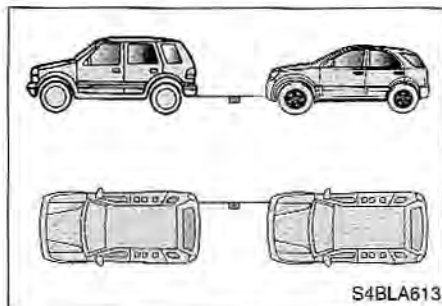

When Your Vehicle is Being Towed by Another Vehicle Other Than a Tow Truck (In Case Of an Emergency) (2WD Vehicles or Part-time 4WD Vehicles)

- Turn the ignition switch to ACC so the steering wheel isn't locked.
- Place the transmission shift lever in N (Neutral).
- Place the transfer shift knob for part-time 4WD operation in the 2HI position.
- Release the parking brake.
- Vehicle equipped with automatic transmissions should not exceed 45km/h (28 mph) and should not be towed more than 80km (50 miles).

*** NOTICE**

Remove the rear drive shaft if it is necessary to exceed 45km/h (28 mph) and/or 80km (50 miles). If the drive shaft cannot be removed, stop every 80km (50 miles) and start the engine. Allow the engine to idle for a few minutes. This will ensure that the transmission is sufficiently lubricated.

- Press the brake pedal with more force than normal since you will have reduced brake performance.
- More steering effort will be required because the power steering system will be disabled.
- If you are driving down a long hill, the brakes may overheat and brake performance will be reduced. Stop often and let the brakes cool off.

*** NOTICE**

To prevent internal damage to the transmission, never tow your vehicle from the rear (backwards) with all four tires in contact with the surface.

Tips for towing a stuck vehicle

The following methods are effective when your vehicle is stuck in mud, sand or similar substances that prevent the vehicle from being driven out under its own power.

- Remove the soil and sand, etc. from the front and the back of the tires.
- Place a stone or wood under the tires.

IF YOU HAVE A FLAT TIRE

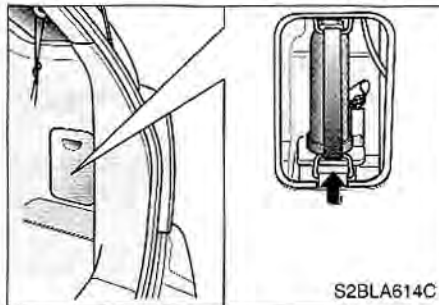
**Storing the Jack and Tools**

Jack is stored in the compartment of the cargo area.

Jack handle and wheel lug nut wrench are located in the cargo area floor.

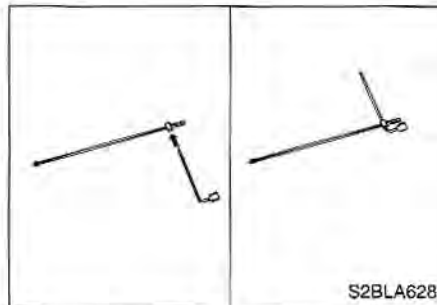
**Removing the Spare Tire**

Your spare tire is stored underneath your vehicle, directly below the cargo area.

1. Assemble the wheel lug nut wrench to the jack handle.
2. Open the rear hatch.

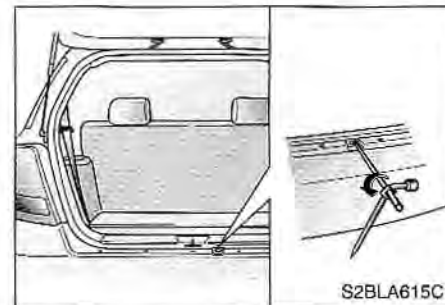

3. Insert the jack handle into the hole just above the rear bumper. The resistance to turning will be felt when properly engaged.
4. Turn the handle counterclockwise until tire is lowered to the ground.

⚠ WARNING

Hold the handle firmly and turn it slowly to lower the spare tire. The separation of the wrench from the handle could cause loss of control and personal injury.

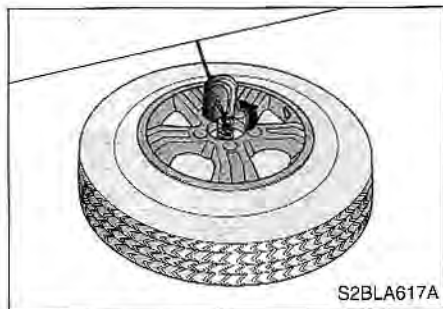

5. Remove the retainer from the center of the spare tire.

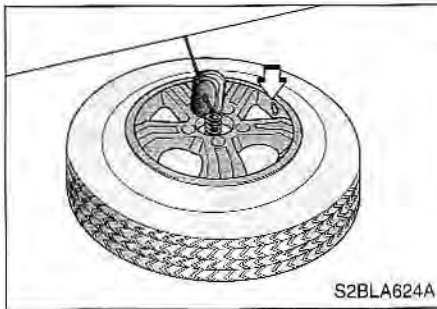

Storing the Spare Tire

1. Lay the tire on the ground with the valve stem facing up.
2. Place the wheel under the vehicle and install the retainer through the wheel center.
3. Turn the handle clockwise until it clicks.

Changing Tires

Jacking instructions

The jack is provided for emergency tire changing only.

Follow jacking instructions to reduce the possibility of personal injury.

⚠ WARNING**- Changing Tires**

- Never attempt vehicle repairs in the traffic lanes of a public road or highway.
- Always move the vehicle completely off the road and onto the shoulder before trying to change a tire. If you cannot find a firm, level place off the road, call a towing service company for assistance.
- Do not exceed the jack's maximum permissible load: 4,400 lbs. (2,000 kg).

(Continued)

(Continued)

- Be sure to use the correct front and rear jacking positions on the vehicle; never use the bumpers or any other part of the vehicle for jack support.
- The vehicle can easily roll off the jack causing serious injury or death. Never allow any portion of your body to get beneath the vehicle while using the jack.
- Do not start or run the engine while the vehicle is on the jack.
- Do not allow anyone to remain in the vehicle while it is on the jack.
- Make sure any children present are in a secure place away from the road and from the vehicle to be raised with the jack.

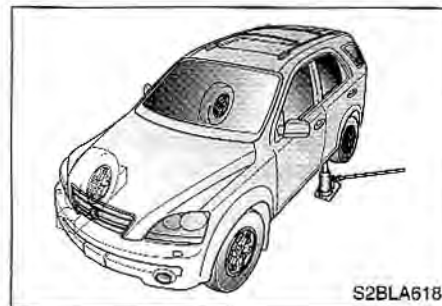

S2BLA618

Tire replacement

1. Park on a level surface and apply the parking brake firmly.
2. Shift into R (Reverse) with manual transmission or P (Park) with automatic transmission.
3. Activate the hazard warning flasher.

4. Remove the wheel lug nut wrench, jack, jack handle, and spare tire from the vehicle.
5. Block both the front and rear of the wheel that is diagonally opposite the jack position.

⚠ WARNING
- Changing Tires

To prevent vehicle movements while changing a tire, always set the parking brake fully, and always block the wheel diagonally opposite the wheel being changed.

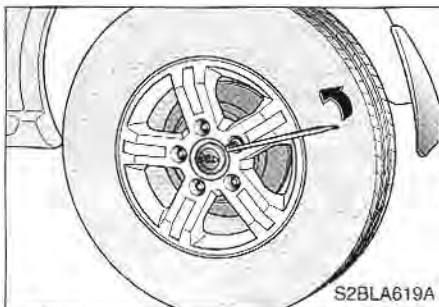

6. Loosen the wheel lug nuts counter-clockwise one turn each, but do not remove any nut until the tire has been raised off the ground.

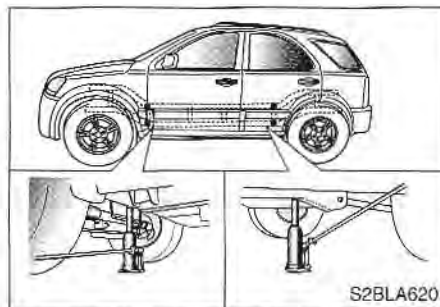

7. Place the jack at the front or rear jacking position closest to the tire you are changing.

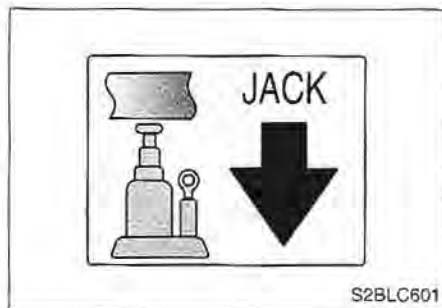

▲ WARNING

- Jack Location

To reduce the possibility of injury, be sure to use only the jack provided with the vehicle and in the correct jack position; never use any other part of the vehicle for jack support.

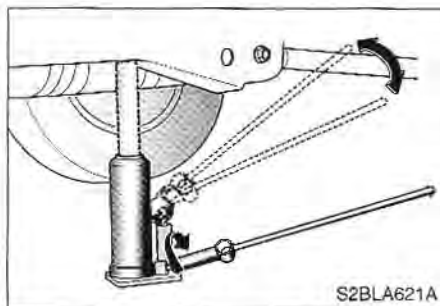

8. Securely tighten the valve of the jack. Move the jack handle up and down until the top of the jack contacts the proper point and takes on a slight load.

Raise the vehicle until the tire just clears the ground (approximately 1.2 in (30 mm)). Never raise the wheel higher. Before removing the wheel lug nuts, make sure the vehicle is stable and that there is no chance for it to slip or move.

9. Remove the wheel lug nuts by turning them counterclockwise, then remove the wheel.

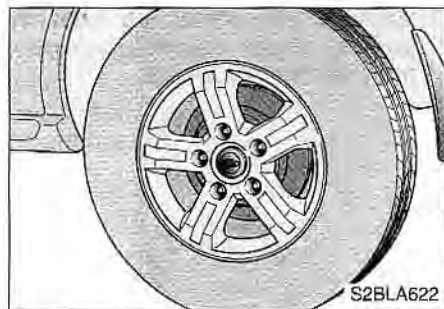

10. Mount the spare tire into position and install the wheel lug nuts with the beveled edge inward.

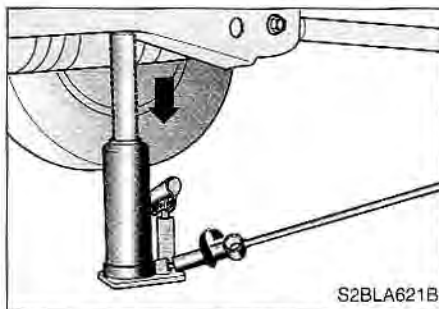

11. Gradually loosen the valve of the jack with the groove on the jack handle to lower the vehicle.

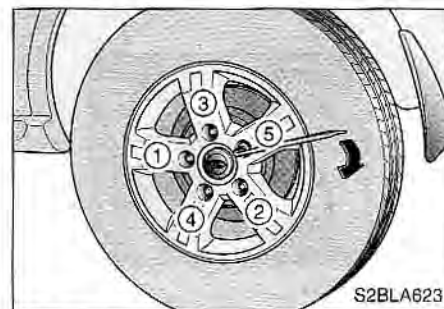

12. Once the wheel lug nuts have been tightened, lower the vehicle fully to the ground and continue to tighten the lug nuts until they are fully secured. Tighten the wheel lug nuts firmly in a "star" pattern.

If you are unsure of the tightness of the wheel lug nuts, have them checked at the nearest service station. The specified tightening torque is 65-87 ft•lb (9~12 kg•m, 88-118 N•m).

⚡ CAUTION

Your vehicle has metric threads on the wheel studs and nuts. Make certain during wheel removal that the same nuts removed are reinstalled - or, if replaced, that nuts with metric threads and the same chamfer configuration are used. Installation of a non-metric thread nut on a metric stud or vice-versa will not secure the wheel to the hub properly and will damage the stud so that it must be replaced.

Note that most lug nuts do not have metric threads. Be sure to use extreme care in checking for thread style before installing aftermarket lug nuts or wheels. If in doubt, consult an Authorized Kia Dealer.

⚠ WARNING - Wheel Studs

If the studs are damaged, they may lose their ability to retain the wheel. This could lead to the loss of the wheel and a collision.

To prevent the jack, jack handle, wheel lug nut, wrench and spare tire from rattling while the vehicle is in motion, store them properly. To store the flat tire, refer to "Storing the spare tire" in this section.

*** NOTICE**

Check the inflation pressures as soon as possible after installing the spare tire. Adjust it to the specified pressure, if necessary. Refer to Section 8, Specifications.

MAINTENANCE

Maintenance Services	7-2
Maintenance Schedule	7-3
Owner Maintenance	7-7
Engine Compartment	7-8
Engine Oil and Oil Filter	7-9
Engine Cooling System	7-11
Brakes and Clutch	7-14
Parking Brake	7-15
Power Steering	7-16
Automatic Transmission	7-17
Lubricants and Fluids	7-19
Air Cleaner	7-20
Wiper Blades	7-21
Battery	7-23
Tires and Wheels	7-26
Bulb Replacement	7-33
Lubricant Specifications	7-41
Exterior Care	7-43
Interior Care	7-47

MAINTENANCE SERVICES

You should exercise the utmost care to prevent both damage to your vehicle and injury to yourself whenever performing any maintenance or inspection procedures.

Should you have any doubts concerning the inspection or servicing of your vehicle, we strongly recommend that you have an authorized Kia Dealer perform this work.

An authorized Kia dealer has factory-trained technicians and genuine Kia parts to service your vehicle properly. For expert advice and quality service, see an authorized Kia dealer.

Inadequate, incomplete or insufficient servicing may result in operational problems with your vehicle that could lead to vehicle damage, an accident, or personal injury.

Owner's Responsibility

* NOTICE

Maintenance Service and Record Retention are the owner's responsibility.

You should retain documents that show proper maintenance has been performed on your vehicle in accordance with the scheduled maintenance service charts shown on the following pages. You need this information to establish your compliance with the servicing and maintenance requirements of your Kia warranties.

Detailed warranty information is provided in your Warranty and Consumer Information Manual.

Repairs and adjustments required as a result of improper maintenance or a lack of required maintenance are not covered.

We strongly recommend that all vehicle maintenance be performed by an authorized Kia dealer using genuine Kia parts.

MAINTENANCE SCHEDULE

Engine Control System

MAINTENANCE INTERVAL	Kilometers or Time in Months, Whichever Comes First																
	x 1,000 km	12	24	36	48	60	72	84	96	108	120	132	144	156	168	180	192
MAINTENANCE ITEM	# Months	6	12	18	24	30	36	42	48	54	60	66	72	78	84	90	96
Engine oil & engine oil filter (1), (3)	Change every 8,000 km or 4 months, whichever comes first.																
Drive belts (tension)			I				I			I			I			I	
Cooling system hoses & connections			I		I		I		I		I		I		I		I
Engine coolant (1)	I	I	I	R	I	I	I	R	I	I	I	R	I	I	I	R	
Fuel filter							R					R					
Fuel tank cap, lines and hoses				I				I				I					I
Air cleaner element	I	I	I	R	I	I	I	R	I	I	I	R	I	I	I	R	
Ignition wires				I				I				I					I
Spark plugs								R									R
Idle speed (3)		I		I			I		I		I		I		I		I
Evaporative emission canister & vapour lines						I					I					I	
Engine timing belt	Replace every 96,000km or 60months																

MAINTENANCE SCHEDULE (CONTINUED)
Chassis and Body

MAINTENANCE INTERVAL \ MAINTENANCE ITEM	Kilometers or Time in Months, Whichever Comes First															
	x 1,000 km	12	24	36	48	60	72	84	96	108	120	132	144	156	168	180
# Months	6	12	18	24	30	36	42	48	54	60	66	72	78	84	90	96
Air conditioner compressor operation & refrigerant amount (if equipped)																
Exhaust pipes, heat shield & mountings																
Transfer case oil (if equipped)									R							
Rear differential fluid (if equipped)			R			R			R			R			R	
Front differential fluid (if equipped)			R			R			R			R			R	
Front suspension ball joints																
Brakes/clutch fluid (1)					R					R					R	
Front brake pads & discs (3)																
Rear brake pads & discs (3)																
Parking brake																
Brake lines & connections (including booster)																
Manual transaxle oil								R								R
Clutch & brake pedal free play (3)																

MAINTENANCE SCHEDULE (CONTINUED)

MAINTENANCE INTERVAL	Kilometers or Time in Months, Whichever Comes First																	
	x 1,000 km	12	24	36	48	60	72	84	96	108	120	132	144	156	168	180	192	
MAINTENANCE ITEM	# Months	6	12	18	24	30	36	42	48	54	60	66	72	78	84	90	96	
Automatic transaxle fluid (1),(3)		I	I	I	R	I	I	I	R	I	I	I	R	I	I	I	R	
Chassis & underbody bolts & nuts		I	I	I	I	I	I	I	I	I	I	I	I	I	I	I	I	
Tire condition & inflation pressure		I	I	I	I	I	I	I	I	I	I	I	I	I	I	I	I	
Wheel alignment (4)		Inspect when abnormal condition noted.																
Tire rotation		Rotate the tires every 12,000 km.																
Steering operation & linkage		I	I	I	I	I	I	I	I	I	I	I	I	I	I	I	I	
Power steering fluid & lines			I		I		I		I		I		I		I		I	
Driveshaft u-joints		L	L	L	L	L	L	L	L	L	L	L	L	L	L	L	L	
Driveshaft dust boots				I			I			I			I			I		
Seat belts, buckles & anchors		I	I	I	I	I	I	I	I	I	I	I	I	I	I	I	I	
Locks, hinges & hood latch		L	L	L	L	L	L	L	L	L	L	L	L	L	L	L	L	

Chart Symbols:

I- Inspect these items and their related parts. If necessary, correct, clean, refill, adjust or replace.

R- Replace or change

L- Lubricate.

(1) Refer to the lubricant and coolant specifications in the Owner's Manual

(2) More frequent maintenance is required if driving under dusty conditions.

(3) More frequent maintenance is required if the vehicle is operated under any of the following conditions:

a. Short-distance driving

b. Driving on dusty roads.

c. Extensive idling or slow-speed driving in stop-and-go traffic.

(4) If necessary, rotate and balance the wheels.

* Note: Check the engine oil and coolant levels every week.

OWNER MAINTENANCE

Owner Maintenance Schedule

The owner should perform these vehicle inspections at the indicated intervals to ensure safe and dependable operation.

Bring any problem to the attention of an authorized Kia dealer as soon as possible.

When refueling, check the following:

- Engine oil level
- Engine coolant level

⚠ WARNING

Be careful when checking your engine coolant level. The engine compartment will be hot and you could be burned.

- Brake (and clutch, if equipped) fluid level
- Washer fluid level

Every month, check:

- Tire inflation pressures (cold)
- Coolant level in reservoir (cold engine)

Every 6 months (for example, every spring and fall), check:

- Power steering fluid level
- Automatic transmission fluid level

⚠ WARNING

- Engine Cooling Fans

Because your engine cooling fans are electronically controlled, they will run if the ignition switch is ON, even if the engine is not running. This could cause serious injury. To prevent this, be sure the ignition is OFF, unless you must run the engine while performing maintenance or an inspection.

ENGINE COMPARTMENT

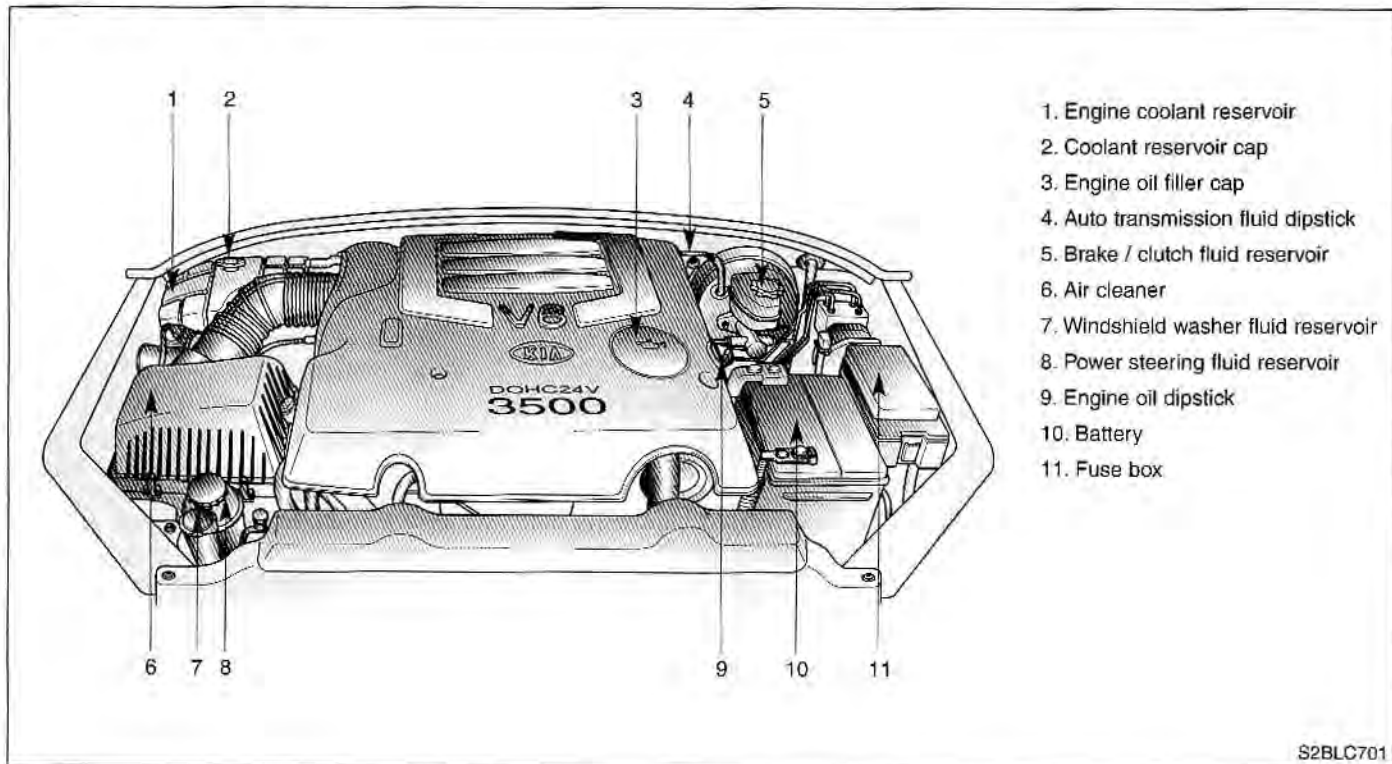

S2BLC701

ENGINE OIL AND OIL FILTER

Checking the Engine Oil Level

1. Be sure the vehicle is on level ground.
2. Start the engine and allow it to reach normal operating temperature.
3. Turn the engine off and wait a few minutes for the oil to return to the oil pan.
4. Pull the dipstick out, wipe it clean, and re-insert it fully.
5. Pull the dipstick out again and check the level. The level should be between F and L.

If the level is near or at L, add enough oil to bring the level to F. **Do not over-fill.**

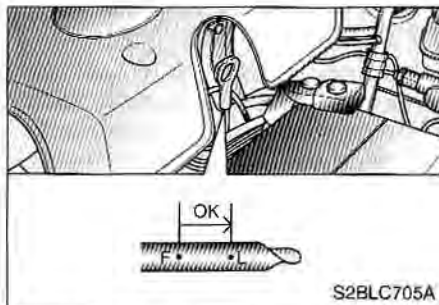

S2BLC705A

*Use only the specified engine oil.
(Refer to "Recommended Lubricants"
later in this section.)*

Changing the Engine Oil and Filter

Change engine oil and filter according to the Scheduled Maintenance at the beginning of this section.

⚠ WARNING - Engine Oil
Continuous contact with **USED** engine oil has caused skin cancer in laboratory mice. Protect your skin by washing with soap and water. Keep all engine oil out of reach of children.

Oil capacity

Without filter change : 4.0 liters

With filter change : 4.3 liters

Use only the specified Service Grade engine oil. (Refer to "Recommended Lubricants" later in this section.)

*** NOTICE**

Although oil filters may have the same external appearance, their internal designs differ significantly. These filters are not interchangeable. To avoid potential engine damage, use only the specified filter.

ENGINE COOLING SYSTEM

The high-pressure cooling system has a reservoir filled with year-round antifreeze coolant. The reservoir is filled at the factory.

Check the antifreeze protection and coolant level at least once a year, at the beginning of the winter season, and before traveling to a colder climate.

Checking the Coolant Level

WARNING

- Removing Radiator Cap

- **Never attempt to remove the radiator cap while the engine is operating. Doing so might lead to cooling system and engine damage and could result in serious personal injury from escaping hot coolant or steam. Turn the engine off and wait until it has cooled. Even then, use extreme care when removing the radiator cap. Wrap a thick towel around it, and turn it counterclockwise slowly to the first stop. Step back while the pressure is released from the cooling system. When you are sure all the pressure has been released, press down on the cap, using a thick towel, and continue turning counterclockwise to remove it.**

(Continued)

(Continued)

- **Even if the engine is not operating, do not remove the radiator cap or the drain plug while the engine and radiator are hot. Hot coolant and steam may still blow out under pressure, causing serious injury.**

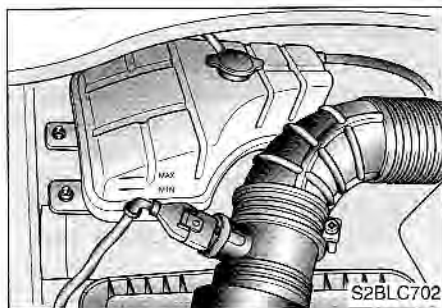

Check the condition and connections of all cooling system hoses and heater hoses. Replace any swollen or deteriorated hoses.

The coolant level should be filled between MAX and MIN marked on the coolant reservoir when the engine is cool.

If the coolant level is low, add enough coolant to bring the level to MAX, but do not overfill. If frequent additions are required, see an authorized Kia dealer for a cooling system inspection.

Changing Coolant

Change coolant according to the Scheduled Maintenance.

- Use only soft (de-mineralized) water in the coolant mixture.
- The engine in your vehicle has aluminum engine parts and must be protected by an ethylene-glycol-based coolant to prevent corrosion and freezing.
- DO NOT USE alcohol or methanol antifreeze or mix them with the specified coolant.
- Do not use a solution that contains more than 60% antifreeze or less than 35% antifreeze, which would reduce the effectiveness of the solution.

For mixture percentage, refer to the following table

Ambient Temperature	Mixture Percentage (volume)	
	Coolant Solution	Water
-15°C (5°F)	35	65
-25°C (-13°F)	40	60
-35°C (-31°F)	50	50
-45°C (-49°F)	60	40

CAUTION

To prevent burning yourself, do not remove the radiator cap or loosen the drain plug while the engine is hot.

1. Turn the coolant reservoir cap counterclockwise to remove it.
2. Loosen the radiator drain plug and drain the coolant into a suitable container.
3. With the plug loose, flush the system with running water.
4. Drain the system completely and retighten the drain plug. Add the necessary amount of ethylene-glycol-based coolant and water to provide the required protection against freezing and corrosion. In extremely cold climates, add ethylene-glycol based coolant in accordance with the instructions of the manufacturer.
5. Run the engine at idle with the coolant reservoir cap off. Slowly add additional coolant as necessary.
6. At this point, wait until the engine reaches normal operating temperature. Depress the accelerator two or three times; then add coolant as required. Be careful not to burn yourself.
7. Replace the coolant reservoir cap. Inspect all connections for leaks and recheck the coolant level in the reservoir. Recheck again after a few days and add coolant as necessary.

BRAKES AND CLUTCH

Checking Brake/Clutch Fluid Level

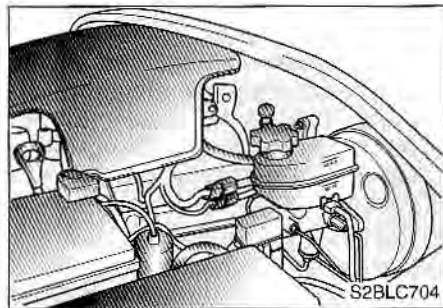

Check the fluid level in the reservoir periodically. The fluid level should be between MAX and MIN indicators on the side of the reservoir.

Before removing the reservoir cap and adding brake fluid, clean the area around the reservoir cap thoroughly to prevent brake/clutch fluid contamination.

If the level is low, add fluid to the MAX level. The level will fall with accumulated mileage. This is a normal condition associated with the wear of the brake/clutch linings. If the fluid level becomes low frequently, have the brake/clutch system checked by an authorized Kia dealer.

Use only the specified brake/clutch fluid. (Refer to "Recommended Lubricants" later in this section.)

Never mix different types of fluid.

* NOTICE

In the event the brake/clutch system requires frequent additions of fluid, the vehicle should be inspected by an authorized Kia dealer.

▲ WARNING

When changing and adding brake/clutch fluid, handle it carefully. Do not let it come in contact with your eyes. If brake/clutch fluid should come in contact with your eyes, immediately flush them with a large quantity of fresh tap water. Have your eyes examined by a doctor as soon as possible.

CAUTION

Do not allow brake/clutch fluid to contact the vehicle's body paint, as paint damage will result. Brake/clutch fluid, which has been exposed to open air for an extended time should never be used as its quality cannot be guaranteed. It should be thrown out. Don't put in the wrong kind of fluid. For example, just a few drops of mineral-based oil, such as engine oil, in your brake clutch system can damage brake clutch system parts.

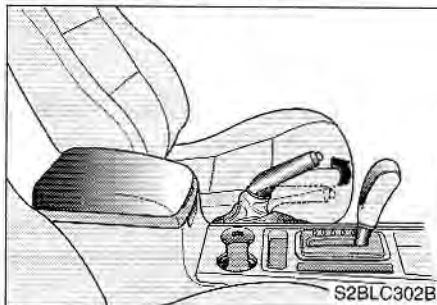
PARKING BRAKE**Checking the Parking Brake**

Check the stroke of the parking brake by counting the number of "clicks" heard while fully applying it from the released position. Also, the parking brake alone should securely hold the vehicle on a fairly steep grade. If the number of "clicks" is more or less than specified, have the parking brake adjusted by an authorized Kia dealer.

Stroke:

4~6 "clicks" at a force of 22 lbs (10kg, 98N).

POWER STEERING



Checking the Power Steering Fluid Level

With the vehicle on level ground, check the fluid level in the power steering reservoir periodically. The fluid level should be between HIGH and LOW indicators on the side of the reservoir.

Before adding power steering fluid, thoroughly clean the area around the reservoir cap to prevent power steering fluid contamination.

If the level is low, add fluid to the HIGH level.

In the event the power steering system requires frequent addition of fluid, the vehicle should be inspected by an authorized Kia dealer.

Use only the specified power steering fluid. (Refer to "Recommended Lubricants" in this section.)

* NOTICE

To avoid damage to the power steering pump, do not operate the vehicle for prolonged periods with a low power steering fluid level.

AUTOMATIC TRANSMISSION (IF EQUIPPED)

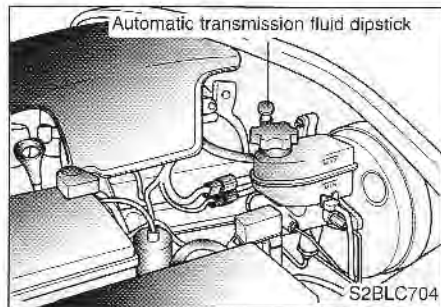

Checking the Automatic Transmission Fluid Level

The automatic transmission fluid level should be checked regularly.

The volume of the transmission fluid changes with temperature. Although it is best to check the level after having driven the vehicle for at least 30 minutes, the level can be checked after warming the fluid using the procedure below.

* NOTICE

- Low transmission fluid level causes transmission slippage. Overfilling can cause foaming, loss of fluid and transmission malfunction.
- The use of a non-specified fluid could result in transmission malfunction and failure.

⚠ WARNING - Parking Brake

To avoid sudden movement of the vehicle, set the parking brake and depress the brake pedal before moving the shift lever.

1. Park the vehicle on level ground and firmly set the parking brake.
2. Allow the engine to idle for about 2 minutes.
3. Depress the brake pedal and move the shift lever slowly through all ranges then set it in P (Park).
4. With the engine still idling, pull out the dipstick, wipe it clean and reinsert it fully.
5. Pull out the dipstick again and check the fluid level.

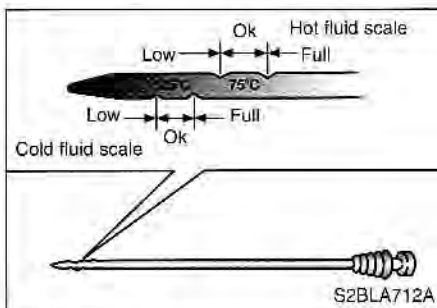

5. Pull out the dipstick again and check the fluid level.

If the fluid has been warmed to normal operating temperature of approximately 167°F (75°C), the fluid level should be between the 2 notches marked 75°C.

* NOTICE

The notch on the 25°C scale is for reference only and should NOT be used to determine transmission fluid level.

* NOTICE

New automatic transaxle fluid should be red. The red dye is added so the assembly plant can identify it as automatic transaxle fluid and distinguishes it from engine oil or antifreeze. The red dye, which is not an indicator of fluid quality, is not permanent. As the vehicle is driven, the automatic transaxle fluid will begin to look darker. The color may eventually appear light brown. Therefore, have an Authorized Kia dealer change the automatic transaxle fluid according to the Scheduled Maintenance at the beginning of this section.

LUBRICANTS AND FLUIDS

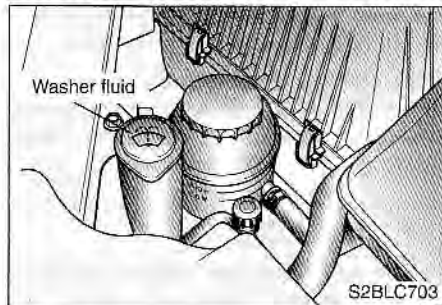

Checking the Washer Fluid Level

The reservoir is translucent so that you can check the level with a quick visual inspection.

Check the fluid level in the washer fluid reservoir and add fluid if necessary. Plain water may be used if washer fluid is not available. In cold climates, use washer solvent with antifreeze to prevent freezing.

⚠ WARNING

- **Do not use radiator coolant or antifreeze in the washer fluid reservoir.**
- **Radiator coolant can severely obscure visibility when sprayed on the windshield and may cause loss of vehicle control or damage to paint and body trim.**

Body Lubrication

All moving points of the body, such as door hinges, hood hinges, and locks, should be lubricated each time the engine oil is changed. Use a non-freezing lubricant on locks during cold weather.

Make sure the engine hood secondary latch keeps the hood from opening when the primary latch is released.

AIR CLEANER

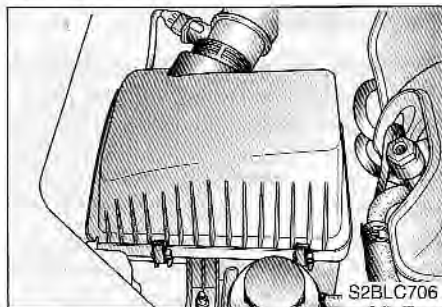

Element Replacement

A viscous paper air cleaner filter is used. It must be replaced when necessary, and should not be cleaned and reused.

1. Loosen the air cleaner cover attaching clips and open the cover.

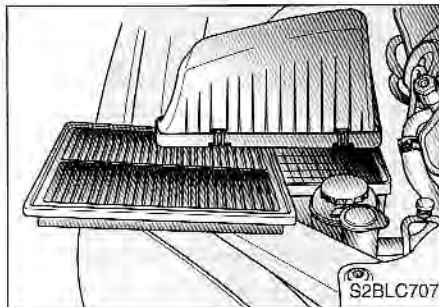

2. Wipe the inside of the air cleaner housing with a clean, damp cloth.
3. Replace the air cleaner element.
4. Lock the cover with the cover attaching clips.

Replace the element according to the Scheduled Maintenance Section.

If the vehicle is operated in extremely dusty or sandy areas, replace the element more often than the usual recommended intervals.

CAUTION

- ***Do not drive with the air cleaner removed; this will result in excessive engine wear.***
- ***Driving without an air cleaner encourages backfiring, which could cause a fire in the engine compartment.***
- ***When removing the air cleaner element, be careful that dust or dirt does not enter the air intake, or damage may result.***

WIPER BLADES

Windshield Wiper Blade Maintenance

* NOTICE

Commercial hot waxes applied by automatic car washes have been known to make the windshield difficult to clean.

Contamination of either the windshield and wiper blades with foreign matter such as insects, tree sap, and hot wax treatments used by some commercial car washes can reduce wiper effectiveness. If the blades are not wiping properly, clean both the window and the blades with a good cleaner or mild detergent, and rinse thoroughly with clean water.

* NOTICE

To prevent damage to the wiper blades, do not use gasoline, kerosene, paint thinner, or other solvents to clean them.

Windshield Wiper Blade Replacement

When the wipers no longer clean adequately, the blades may be worn or cracked, and require replacement.

* NOTICE

To prevent damage to the wiper arms or other components, do not attempt to move the wipers manually.

* NOTICE

The use of a non-specified wiper blade could result in wiper malfunction and failure.

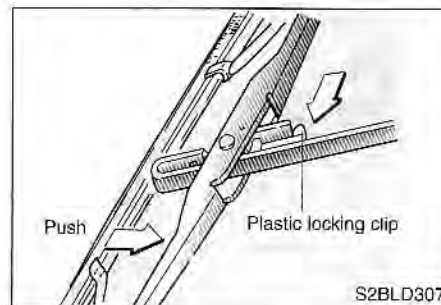

1. Raise the wiper arm and turn the wiper blade assembly to expose the plastic locking clip.

Compress the clip and slide the blade assembly downward; then lift it off the arm.

* NOTICE

Do not allow the wiper arm to fall against the windshield.

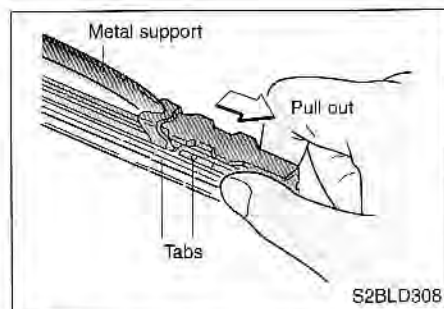

2. Firmly grasp the end of the rubber blade and pull until the tabs are free of the metal support.

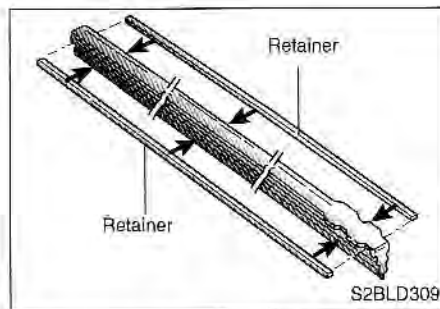

3. Remove the metal retainers from the rubber blade and install them in the new rubber blade.

* NOTICE

Do not bend the metal retainers.

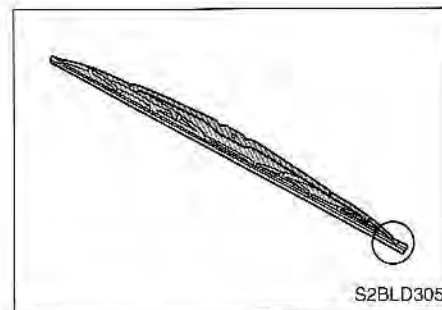

4. Carefully insert a new rubber blade and install the blade assembly.
Install the blade with the tabs facing towards the bottom of the wiper arm.

BATTERY

▲ WARNING - Battery dangers

Always read the following instructions carefully when handling a battery.



Keep lighted cigarettes and all other flames or sparks away from the battery.



Hydrogen, which is a highly combustible gas, is always present in battery cells and may explode if ignited.



Keep batteries out of the reach of children because batteries contain highly corrosive SULFURIC ACID. Do not allow battery acid to contact your skin, eyes, clothing or paint finish.

(Continued)

(Continued)



If any electrolyte gets into your eyes, flush your eyes with clean water for at least 15 minutes and get immediate medical attention. If possible, continue to apply water with a sponge or cloth until medical attention is received.

If electrolyte gets on your skin, thoroughly wash the contacted area. If you feel a pain or a burning sensation, get medical attention immediately.



Wear eye protection when charging or working near a battery. Always provide ventilation when working in an enclosed space.

(Continued)

(Continued)

- When lifting a plastic-cased battery, excessive pressure on the case may cause battery acid to leak, resulting in personal injury. Lift with a battery carrier or with your hands on opposite corners.
- Never attempt to charge the battery when the battery cables are connected.
- The electrical ignition system works with high voltage. Never touch these components with the engine running or the ignition switched on.

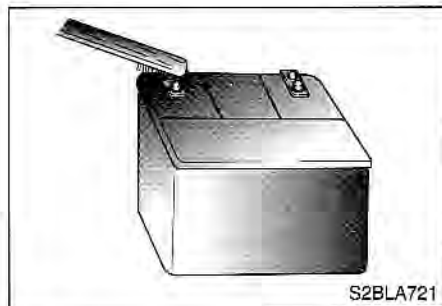

Maintenance

For optimal battery performance:

- Keep the battery securely mounted.
- Keep the battery top clean and dry.
- Keep the terminals and connections clean, tight, and coated with petroleum jelly or terminal grease.

- Rinse any spilled electrolyte from the battery immediately with a solution of water and baking soda.
- If the vehicle is not going to be used for an extended time, disconnect the battery cables.

Items to be reset after the battery has been replaced or the battery cables have been disconnected and reinstalled.

- Sunroof (See page 3-71)
- Clock (See page 4-61)
- Multi-Meter (See page 4-46)
- Climate control system (See pages 4-74 and 4-80)

Battery Recharging

Your vehicle has a maintenance-free, calcium-based battery.

- If the battery becomes discharged in a short time (because, for example, the headlights or interior lights were left on while the vehicle was not in use), recharge it by slow charging (trickle) for 10 hours.
- If the battery gradually discharges because of high electric load while the vehicle is being used, recharge it at 20-30A for two hours.

▲ WARNING**- Recharging Battery**

When recharging the battery, observe the following precautions:

- The battery must be removed from the vehicle and placed in an area with good ventilation.
- Do not allow cigarettes, sparks, or flame near the battery.
- Watch the battery during charging, and stop or reduce the charging rate if the battery cells begin gassing (boiling) violently or if the temperature of the electrolyte of any cell exceeds 120°F (49°C).
- Wear eye protection when checking the battery during charging.

(Continued)

(Continued)

- Disconnect the battery charger in the following order.
 1. Turn off the battery charger main switch.
 2. Unhook the negative clamp from the negative battery terminal.
 3. Unhook the positive clamp from the positive battery terminal.

*** NOTICE**

- Before performing maintenance or recharging the battery, turn off all accessories and stop the engine.
- The negative battery cable must be removed first and installed last when the battery is disconnected.

TIRES AND WHEELS

Tire Care

For proper maintenance, safety, and maximum fuel economy, you must always maintain the recommended tire inflation pressures and stay within the load limits and weight distribution recommended for your vehicle.

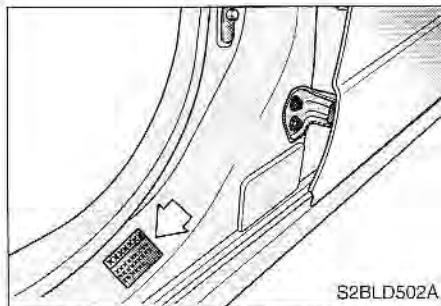

Inflation Pressures

All tire pressures (including the spare) should be checked monthly when the tires are cold. "Cold Tires" means the vehicle has not been driven for at least three hours or driven less than one mile (1.6 km). Recommended pressures must be maintained for optimum vehicle handling, and minimum tire wear.

The front and rear tires should be 30 psi (2.1 kg/cm²). The full-size spare should be inflated to 30 psi (2.1 kg/cm²).

▲ WARNING

Severe underinflation (10 psi or more) can lead to severe heat build-up, especially on hot days and when driving at high speed. This can potentially cause tread separation and other tire irregularities to appear that can result in the loss of vehicle control leading to severe injury or death.

▲ WARNING - Tire Inflation

Over inflation or under inflation can reduce tire life, adversely affect vehicle handling, and lead to sudden tire failure. You could lose control and have a serious accident. Follow all the guidelines about proper tire maintenance.

- Warm tires normally exceed recommended cold tire pressures by 4 to 6 psi (28 to 41 kPa). Do not release air from warm tires to adjust the pressure. The tires will be underinflated.
- Underinflation results in excessive wear, poor handling, reduced fuel economy, and possibility of blowouts from overheated tires. Also, low tire pressure can cause poor seating of the tire bead. If the tire pressure is excessively low, wheel deformation and/or tire separation is possible.

(Continued)

(Continued)

So keep you tire pressures at the proper levels. If a tire frequently needs refilling, have it checked by an authorized Kia dealer or a competent tire shop.

- **Overinflation produces a harsh ride, handling problems, excessive wear at the center of the tire tread, prolonged braking distance and a greater possibility of damage from road hazards.**
- **Be sure to reinstall the tire inflation valve caps. Without the valve cap, dirt or moisture could get into the valve core and cause air leakage. If the cap have been lost, install new one as soon as possible.**

Tire Rotation

To equalize tread wear, it is recommended that the tires be rotated every 7,500 miles (12,000 km) or sooner if irregular wear develops.

During rotation, check the tires for correct balance.

When rotating tires, check for uneven wear and damage. Abnormal wear is usually caused by incorrect tire pressure, improper wheel alignment, out-of-balance wheels, severe braking or severe cornering. Look for bumps or bulges in the tread or side of tire. Replace the tire if you find either of these conditions. Replace tires showing fabric or cord. After rotation, be sure to bring the front and rear tire pressures to specification and check lug nut tightness.

Refer to Section 8, Specifications.

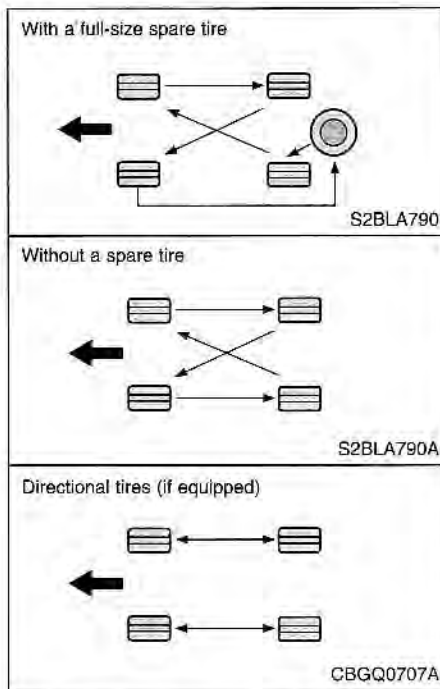

Disc brake pads and rear brake shoes should be inspected for wear whenever tires are rotated.



Tire Replacement

If the tire is worn evenly, a tread wear indicator will appear as a solid band 1/2 inch wide (12.7mm) across the tread. This shows there is less than 1/16 inch (1.6 mm) of tread left on the tire. Replace the tire when this happens.

Do not wait for the band to appear across the entire tread before replacing the tire.

Wheel Alignment and Tire Balance

The wheels on your vehicle were aligned and balanced carefully at the factory to give you the longest tire life and best overall performance.

In most cases, you will not need to have your wheels aligned again. However, if you notice unusual tire wear or your vehicle pulling one way or the other, the alignment may need to be reset.

If you notice your vehicle vibrating when driving on a smooth road, your wheels may need to be rebalanced.

* NOTICE

Improper wheel weights can damage your vehicle's aluminum wheels. Use only approved wheel weights.

⚠ WARNING - Tire Inflation

- Driving on worn-out tires or mis-matched tires is very hazardous. Worn-out tires reduce braking effectiveness, steering accuracy, and traction. You are also more likely to have a blowout on a worn-out tire. Replace any tire showing signs of being worn out.
- When replacing tires, never mix radial, bias-belted, and bias-type tires. All four tires should be of the same size, design and construction. Use only the tire sizes listed on the Tire Label located below the door striker on the driver's side. Make sure that all tires and wheels are the same size and have the same load-carrying capacity. Use only tire and wheel combinations recommended on the Tire Label or by an authorized Kia dealer. Be sure the tire size matches the wheel size.

(Continued)

(Continued)

- The use of any other tire size or type may seriously affect ride, handling, ground clearance, tire clearance, and speedometer calibration.
- It is best to replace all four tires at the same time. If that is not possible or necessary, then replace the two front or two rear tires as a pair. Replacing just one tire can seriously affect your vehicle's handling.

Wheel Replacement

When replacing the metal wheels for any reason, make sure the new wheels are equivalent to the original factory units in diameter, rim width and offset.

⚠ WARNING

A wheel that is not the correct size may adversely affect wheel and bearing life, braking and stopping abilities, handling characteristics, ground clearance, body-to-tire clearance, snow chain clearance, speedometer calibration, headlight aim and bumper height.

Tire Size Designation

A tire's sidewall is marked with a tire size designation. You will need this information when selecting replacement tires for your car. The following explains what the letters and numbers

in the tire size designation mean.

Example tire size designation: P245/70R16 106H (these numbers are provided as an example only; your tire size designator could vary depending on your vehicle.)

P – Applicable vehicle type (tires marked with the prefix “P” are intended for use on passenger cars or light trucks; however, not all tires have this marking).

245 – Tire width in millimeters.

70 – Aspect ratio. The tire's section height as a percentage of its width.

R – Tire construction code (Radial).

16 – Rim diameter in inches.

106 – Load Index, a numerical code associated with the maximum load the tire can carry.

H – Speed Rating Symbol. See the speed rating chart in this section for additional information.

Wheel Size Designation

Wheels are also marked with important information that you need if you ever have to replace one. The following explains what the letters and numbers in the wheel size designation mean.

Example wheel size designation: 7.0JJ x 16

7.0 – Rim width in inches.

J – Rim contour designation.

16 – Rim diameter in inches.

Tire Speed Ratings

The chart below shows many of the different speed ratings currently being used for passenger car and light truck tires. The speed rating symbol is part of the tire size designation on the sidewall of the tire. This symbol corresponds to that tire's designed maximum safe operating speed.

Speed Rating Symbol	Maximum Speed
S	180 km/h (112 mph)
T	190 km/h (118 mph)
H	210 km/h (130 mph)
V	240 km/h (149 mph)
Z	Above 240 km/h (149 mph)

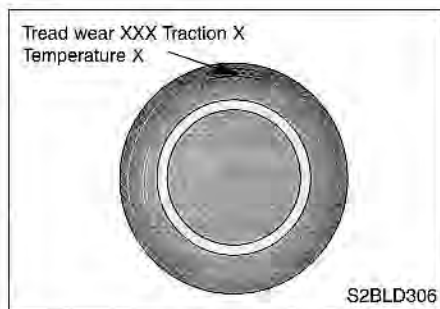

Uniform Tire Quality Grading

The following information relates to the tire grading system developed by the Canadian Motor Vehicle Safety Standard (CMVSS) for grading tires by tread wear, traction and temperature performance.

Tread Wear

The tread wear grade is a comparative rating based on the wear rate of the tire when tested under controlled conditions on a specified government test course. For example, a tire graded 150 would wear one-and-a-half times as well on the government test course as a tire graded 100.

The relative performance of tires depends upon the actual conditions of their use. However, performance may differ from the norm because of variations in driving habits, service practices and differences in road characteristics and climate.

These grades are molded on the side-walls of passenger vehicle tires. The tires available as standard or optional equipment on Kia vehicles may vary with respect to grade.

Traction – A, B & C

The traction grades, from highest to lowest, are A, B and C. The grades represent the tire's ability to stop on wet pavement as measured under controlled conditions on specified government test surfaces of asphalt and concrete. A tire marked C may have poor traction performance.

Temperature – A, B & C

The temperature grades are A (the highest),

B and C. The grades represent the tire's resistance to the generation of heat and its ability to dissipate heat when tested under controlled conditions on a specified laboratory test wheel. Sustained high temperature can cause the material of the tire to degenerate and reduce tire life, and excessive temperature can lead to sudden tire failure. Grades A and B represent higher levels of performance on the laboratory test wheel than the minimum required by the law.

⚠ WARNING

- Tire Temperature

The temperature grade for the tire on your vehicle is established for a tire that is properly inflated and not overloaded. Excessive speed, underinflation, or excessive loading, either separately or in combination, can cause heat build-up and possible sudden tire failure. This can cause loss of vehicle control and serious injury or death.

Checking a tire life

If any tires that are over 6 years based on the manufacturing date, tire strength and performance decline with age naturally (even if the tires are not used like a spare tire). Therefore, the tires should be replaced by new ones including the spare tire. You can find the manufacturing date on the tire sidewall (possibly only on the inside of the wheel), which has DOT marking. DOT is serial numbers on tires, which consist of a combination of numbers and English letters. You can check the manufacturing date to the last four position of the DOT.

DOT : XXXX XXXX OOOO

The front part of the DOT means a plant code number, tire size and tread pattern and the last four numbers indicate week and year manufactured.

For example ;

DOT XXXX XXXX 1602 represents that the tire was produced in the 16th week of 2002.

⚠ WARNING

A tire more than 6 years old may cause separation of the cord layers inside the tire leading to loss of vehicle or a serious injury. Therefore, make sure to check the manufacturing date and replace the old tire in 6 years after the tire manufacturing date.

BULB REPLACEMENT

⚠ WARNING

- Working on the lights

Prior to working on the light, firmly apply the parking brake and ensure that the ignition switch is turned to the "LOCK" position to avoid sudden movement of the vehicle and burning your fingers or receiving an electric shock.

Headlight Replacement

⚠ WARNING

- Halogen Bulbs

- Halogen bulbs contain pressurized gas that will produce flying pieces of glass if broken.
- Always handle them carefully, and avoid scratches and abrasions. If the bulbs are lit, avoid contact with liquids. Never touch the glass with bare hands. Residual oil may cause the bulb to overheat and burst when lit. A bulb should be operated only when installed in a headlight.
- If a bulb becomes damaged or cracked, replace it immediately and carefully dispose of it.
- Wear eye protection when changing a bulb. Allow the bulb to cool before handling it.

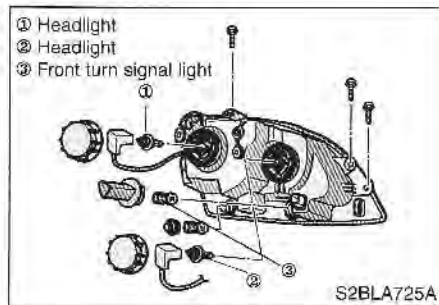

1. Open the hood.
2. Remove the light assembly from the body of the vehicle loosening the bolts.

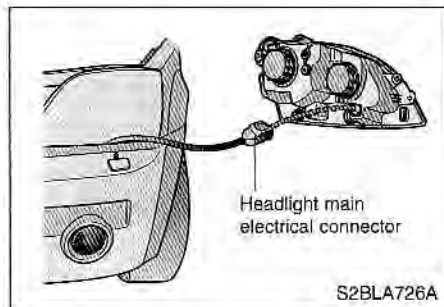

3. Disconnect the headlight main electrical connector.

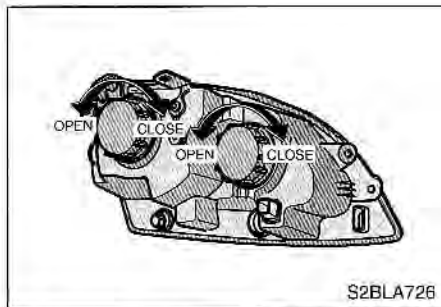

4. Remove the headlight bulb cover by turning it counterclockwise.

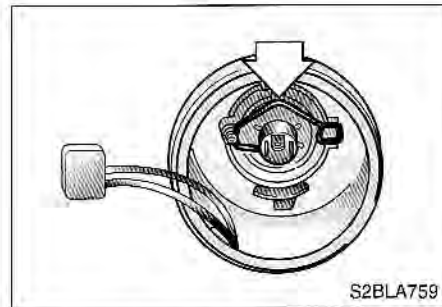

5. Disconnect the headlight bulb socket-connector.

6. Unsnap the headlight bulb retaining wire by depressing the end of it and pushing it upward.

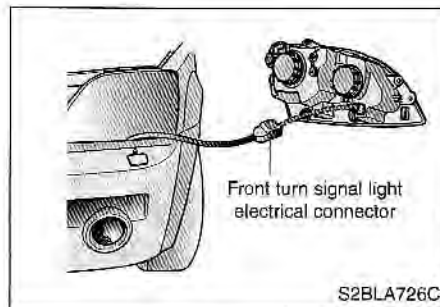
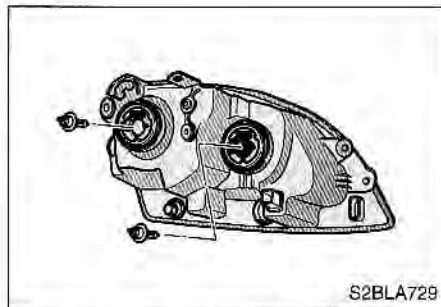

7. Remove the bulb from the headlight assembly.
8. Install a new headlight bulb and snap the headlight bulb retaining wire into position by aligning the wire with the groove on the bulb.
9. Connect the headlight bulb socket-connector.
10. Install the headlight bulb cover by turning it clockwise.
11. Connect the headlight main connector.
12. Reinstall the light assembly to the body of the vehicle.

Front Turn Signal Light Bulb Replacement

1. Open the hood.
2. Remove the light assembly from the body of the vehicle removing the bolts.
3. Disconnect the front turn signal light electrical connector.

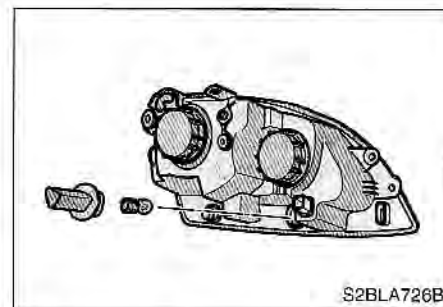

4. Remove the socket from the assembly by turning the socket counter clockwise until the tabs on the socket align with the slots on the assembly.
5. Remove the bulb from the socket by pressing it in and rotating it until the tabs on the bulb align with the slot in the socket. Pull the bulb out of the socket.

6. Install a new bulb by inserting it into the socket and rotating it until it locks into place.
7. Install the socket in the assembly by aligning the tabs on the socket with the slots in the assembly. Push the socket into the assembly and turn the socket clockwise.
8. Connect the front turn signal light electrical connector.
9. Reinstall the light assembly to the body of the vehicle.

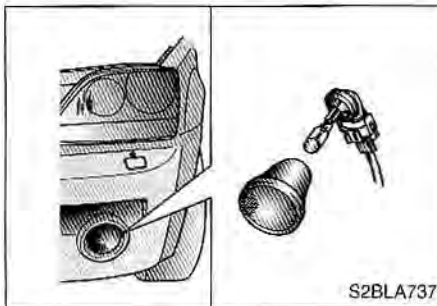

Front Fog Light Bulb Replacement

1. Reach your hand into the front bumper below the fog light housing.

2. Remove the socket from the housing by turning the socket counter clockwise until the tabs on the socket align with the slots on the housing.
3. Remove the bulb by pulling it straight out.
4. Install a new bulb in the socket.
5. Install the socket in the housing by aligning the tabs on the socket with the slots in the housing. Insert the socket into the housing and turn the socket clockwise.

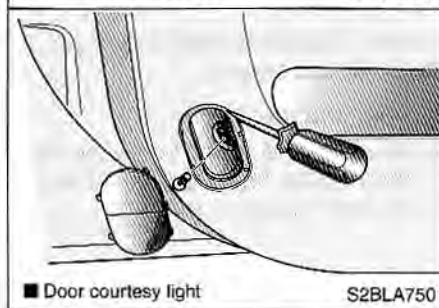
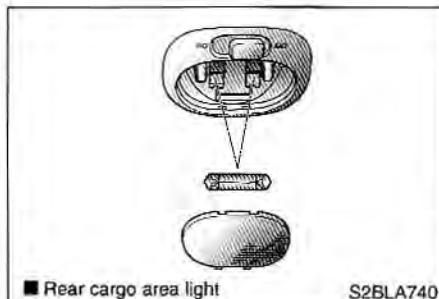
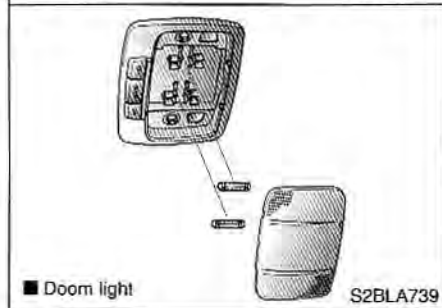
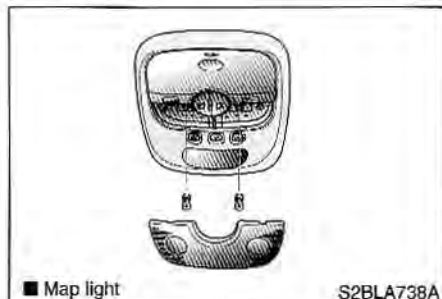

Interior Lights Bulb Replacement

1. Using a flat-blade screwdriver, gently pry the lens from the interior light housing.

CAUTION

Prior to working on the Interior Lights, ensure that the "OFF" button is depressed to avoid burning your fingers or receiving an electric shock.

2. Remove the bulb by pulling it straight out.
3. Install a new bulb.
4. Align the lens tabs with the interior light housing notches and snap the lens into place.

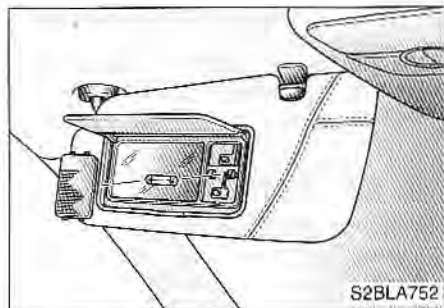

Vanity Mirror Light

1. Using a flat-blade screwdriver, gently pry the lens from the survivor.
2. Remove the bulb by pulling it straight out.
3. Install a new bulb.
4. Align the lens tabs with the light housing notches and snap the lens into place.



Center High-Mounted Stoplight Bulb Replacement

1. Open the rear hatch.
2. Remove the trim from the rear hatch after removing fasteners of the both sides on the trim.

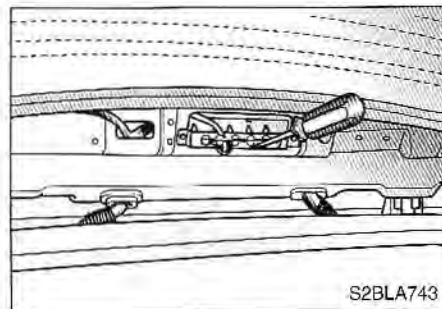

3. Separate the socket and the lens part by pulling the socket retaining tabs outward.

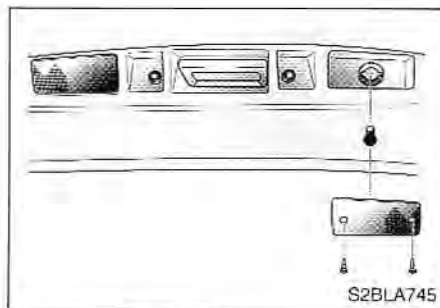
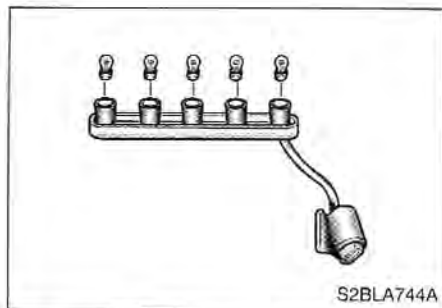

4. Remove the bulbs by pulling them straight out.
5. Install new bulbs in the socket.
6. Install the trim securely with the fasteners.

License Plate Light

1. Loosen the lens retaining screws with a cross-tip screwdriver.
2. Remove the lens.
3. Remove the bulb by pulling it straight out.
4. Install a new bulb.
5. Reinstall the lens securely with the lens retaining screws.

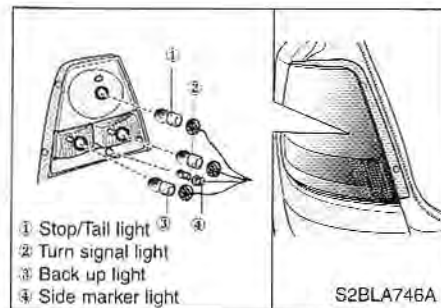

- ① Stop/Tail light
- ② Turn signal light
- ③ Back up light
- ④ Side marker light

Rear Combination Light Bulb Replacement

1. Open the rear hatch.

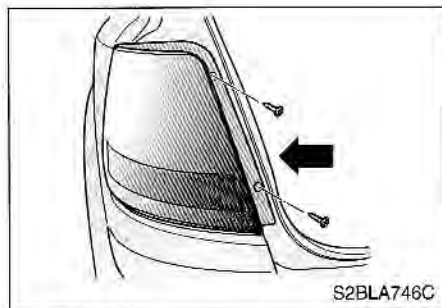

2. Loosen the light assembly retaining screws with a cross-tip screwdriver.
3. Slide the rear combination light out to disconnect the rear combination light assembly from the body of the vehicle.

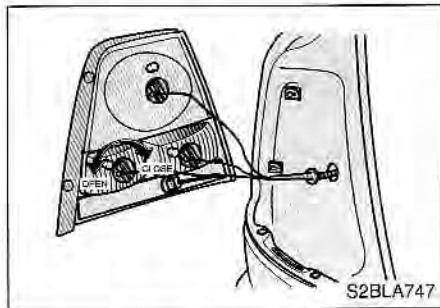

4. Remove the socket from the assembly by turning the socket counter clockwise until the tabs on the socket align with the slots on the assembly.
5. Remove the bulb from the socket by pressing it in and rotating it until the tabs on the bulb align with the slots in the socket. Pull the bulb out of the socket.

6. Insert a new bulb by inserting it into the socket and rotating it until it locks into place.
7. Install the socket in the assembly by aligning the tabs on the socket with the slots in the assembly. Push the socket into the assembly and turn the socket clockwise.
8. Reinstall the light assembly to the body of the vehicle.
9. Tighten the screws.

LUBRICANT SPECIFICATIONS

Recommended Lubricants

To help achieve proper engine and powertrain performance and durability, use only lubricants of the proper quality. The correct lubricants also help promote engine efficiency that results in improved fuel economy.

Engine oils labeled Energy Conserving Oil are now available. Along with other additional benefits, they contribute to fuel economy by reducing the amount of fuel necessary to overcome engine friction. Often, these improvements are difficult to measure in everyday driving, but in a year's time, they can offer significant cost and energy savings.

These lubricants and fluids are recommended for use in your vehicle.

Lubricant		Classification
Engine oil **		API Service SH or above
Manual transmission fluid		API Service GL-4 (SAE 75W-90)
Automatic transmission fluid		MOBIL D-II
4WD transfer case fluid		DEXRON III
Front differential fluid		API Service GL-5, SAE 90
Rear differential fluid	without LSD	API Service GL-5, SAE 90
	with LSD	API Service GL-5, SAE 85W-90 (INFILREX 33)
Power steering fluid		PSF-III
Brake / clutch fluid		FMVSS116 DOT-3 or DOT-4

** Refer to the recommended SAE viscosity numbers on the next page.

Recommended SAE Viscosity Number

* NOTICE

Always be sure to clean the area around any filler plug, drain plug, or dipstick before checking or draining any lubricant. This is especially important in dusty or sandy areas and when the vehicle is used on unpaved roads. Cleaning the plug and dipstick areas will prevent dirt and grit from entering the engine and other mechanisms that could be damaged.

When choosing an oil, consider the range of temperature your vehicle will be operated in before the next oil change. Proceed to select the recommended oil viscosity from the chart.

Temperature Range for SAE Viscosity Numbers											
Temperature	°C	-30	-20	-10	0	10	20	30	40	50	
	(°F)	-20	0	20	40	60	80	100	120		
Engine Oil	5W-30				30						
	5W-20		20W-20				40				
	10W-30										
	10W-40				10W-50						
	20W-40					20W-50					

Engine oil viscosity (thickness) has an effect on fuel economy and cold weather operating (starting and oil flow). Lower viscosity engine oils can provide better fuel economy and cold weather performance, however, higher viscosity engine oils are required for satisfactory lubrication in hot weather. Using oils of any viscosity other than those recommended could result in engine damage.

EXTERIOR CARE

Exterior General Caution

It is very important to follow the label directions when using any chemical cleaner or polish. Read all warning and caution statements that appear on the label.

Finish Maintenance

Washing

To help protect your vehicle's finish from rust and deterioration, wash it thoroughly at least once a month with lukewarm or cold water.

Pay special attention to the removal of any accumulation of salt, dirt, mud, and other foreign materials. Make sure the drain holes in the lower edges of the doors and rocker panels are kept clear and clean.

Insects, tar, tree sap, bird droppings, industrial pollution and similar deposits can damage your vehicle's finish if not removed immediately.

Even prompt washing with plain water may not completely remove all these deposits. A mild soap, safe for use on painted surfaces, may be used.

After washing, rinse the vehicle thoroughly with lukewarm or cold water. Do not allow soap to dry on the finish.

*** NOTICE**

Do not use strong soap, chemical detergents or hot water, and do not wash the vehicle in direct sunlight or when the body of the vehicle is warm.

⚠ WARNING

After washing the vehicle, test the brakes while driving slowly to see if they have been affected by water. If braking performance is impaired, dry the brakes by applying them lightly while maintaining a slow forward speed.

⚠ WARNING

- Water Washing in Engine Compartment

Water washing in the engine compartment may cause failure of electrical circuits. Systems of your vehicle could fail when you need them. Wash your engine compartment carefully. Check your vehicle's features before driving again.

Waxing

Wax the vehicle when water will no longer bead on the paint.

Always wash and dry the vehicle before waxing. Use good quality liquid or paste wax, and follow the manufacturer's instructions. Wax all metal trim to protect it and to maintain its luster.

Removing oil, tar, and similar materials with a spot remover will usually strip the wax from the finish. Be sure to re-wax these areas even if the rest of the vehicle does not yet need waxing.

*** NOTICE**

- Wiping dust or dirt off the body with a dry cloth will scratch the finish.
- Do not use steel wool, abrasive cleaners, or strong detergents containing high alkaline or caustic agents on chrome-plated or anodized aluminum parts. This may result in damage to the protective coating and cause discoloration or paint deterioration.

Finish Damage Repair

Deep scratches or stone chips in the painted surface must be repaired promptly. Exposed metal will quickly rust and may develop into a major repair expense.

*** NOTICE**

If your vehicle is damaged and requires any metal repair or replacement, be sure the body shop applies anti-corrosion materials to the parts repaired or replaced.

Bright-Metal Maintenance

- To remove road tar and insects, use a tar remover, not a scraper or other sharp object.
- To protect the surfaces of bright-metal parts from corrosion, apply a coating of wax or chrome preservative and polish to a high luster.
- During winter weather or in coastal areas, cover the bright metal parts with a heavier coating of wax or preservative. If necessary, coat the parts with non-corrosive petroleum jelly or other protective compound.

Underbody Maintenance

Corrosive materials used for ice and snow removal and dust control may collect on the underbody. If these materials are not removed, accelerated rusting can occur on underbody parts such as the fuel lines, frame, floor pan and exhaust system, even though they have been provided with rust protection.

Thoroughly flush the vehicle underbody and wheel openings with lukewarm or cold water once a month, after off-road driving (for four-wheel drive vehicles) and at the end of each winter. It will do more harm than good to wet down the road grime without removing it. The lower edges of doors, rocker panels, and frame members have drain holes that should not be allowed to clog with dirt; trapped water in these areas can cause rusting.

⚡ CAUTION

After washing the vehicle, test the brakes while driving slowly to see if they have been affected by water.

Aluminum Wheel Maintenance

The aluminum wheels are coated with a clear protective finish.

- Do not use any abrasive cleaner, polishing compound, solvent, or wire brushes on aluminum wheels. They may scratch or damage the finish.
- Use only a mild soap or neutral detergent, and rinse thoroughly with water. Also, be sure to clean the wheels after driving on salted roads. This helps prevent corrosion.
- Avoid washing the wheels with high-speed car wash brushes.
- Do not use any acid detergent. It may damage and corrode the aluminum wheels coated with a clear protective finish.

INTERIOR CARE

Interior General Precautions

Prevent caustic solutions such as perfume and cosmetic oil from contacting the dashboard because they may cause damage or discoloration. If they do contact the dashboard, wipe them off immediately. See the instructions that follow for the proper way to clean vinyl.

Cleaning the Upholstery and Interior Trim

Vinyl

Remove dust and loose dirt from vinyl with a whisk broom or vacuum cleaner. Clean vinyl surfaces with a vinyl cleaner.

Fabric

Remove dust and loose dirt from fabric with a whisk broom or vacuum cleaner. Clean with a mild soap solution recommended for upholstery or carpets. Remove fresh spots immediately with a fabric spot cleaner. If fresh spots do not receive immediate attention, the fabric can be stained and its color can be affected. Also, its fire-resistant properties can be reduced if the material is not properly maintained.

CAUTION

Using anything but recommended cleaners and procedures may affect the fabric's appearance and fire-resistant properties.

Cleaning the Lap/Shoulder Belt Webbing

Clean the belt webbing with any mild soap solution recommended for cleaning upholstery or carpet. Follow the instructions provided with the soap. Do not bleach or re-dye the webbing because this may weaken it.

Cleaning the Interior Window Glass

If the interior glass surfaces of the vehicle become fogged (that is, covered with an oily, greasy or waxy film), they should be cleaned with glass cleaner. Follow the directions on the glass cleaner container.

*** NOTICE**

Do not scrape or scratch the inside of the rear window. This may result in damage to the rear window defroster grid.

SPECIFICATIONS

Specifications	8-2
----------------------	-----

SPECIFICATIONS

SPECIFICATIONS

The specifications given here are for general information only. Please check with an authorized Kia dealer for more precise and more up-to-date information.

Air Conditioner

Refrigerant complies with SAE J639	R134a
Maximum operating charge	600 g (21 oz)

Weights

kg (lb)

Item	M/T	A/T
Curb Weight	1,953~2,026 (4,306~4,467)	1,958~2,031 (4,317~4,478)
GVWR	2,560 (5,644)	2,560 (5,644)
GAWR	Front	1,280 (2,822)
	Rear	1,500 (3,307)

Dimensions

Item	mm (in)
Overall length w/o bumper guard	4,567 (179.8)
Overall length with bumper guard	4,625 (182.1)
Overall width w/o wide garnish	1,863 (73.3)
Overall width with wide garnish	1,884 (74.2)
Overall height w/o roof rack	1,730 (68.1)
Overall height with roof rack	1,810 (71.3)
Front tread	1,580 (62.2)
Rear tread	1,580 (62.2)
Wheelbase	2,710 (106.7)

Light bulbs

Light Bulb	Wattage
Exterior Lights	
Headlights (High/Low)	55 / 55
Front turn signal / position lights	28 / 8
Front fog lights	27
Front side marker	5
Rear turn signal lights	27
Stop and tail lights	27 / 8
Back-up lights	27
License plate lights	5
High mounted stop light	5
Rear side marker	5
Interior Lights	
Room lamp	10
Map lamp	10
Rear cargo area lamp	10
Door courtesy lamp	5
Vanity mirror lamp	3

Tires

Size		Inflation Pressure
Tire	Wheel	
P245/70R16	7JJ×16	30 psi (210 kPa)

Gear Ratio

Engine Gear	Gasoline	
	M/T	A/T
1st	3.749	2.804
2nd	2.044	1.531
3rd	1.289	1.000
4th	1.000	0.705
5th	0.794	-
Reverse	3.453	2.393

SPECIFICATIONS

Engine

Item	Gasoline Engine
BoreXStroke	93 mm × 85.8 mm (3.66 in × 3.38 in)
Displacement	3496 cc (213.3 cu.in)
Compression Ratio	10.0

Electrical System

Size		Gasoline Engine
Battery	Type	MF 70 AH
	Capacity	12V / 70AH
Alternator		13.5V / 120A
Starter		12V-1.2KW
Spark Plug	Gap	1.0 mm ~ 1.1 mm
	Specification	PFR5N-11, RC10PYPB4

Capacities

Lubricant	Volume (l)		Classification	
Engine oil	With filter	4.3	API SERVICE SH or above	
	Without filter	4.0		
Transmission oil	A/T		MOBIL D-II	
	M/T	2WD	3.2	API SERVICE GL-4 SAE 75W-90 (fill for-life)
		4WD	2.7	
Coolant	11.0		Ethylene glycol base for aluminum radiator	
Brake fluid	0.35		SAE J1703, FMVSS116 DOT3 or DOT4	
Fuel	80		-	

Transfer Case

Gear	Gear Ratio
High	1,000
Low	2,480

INDEX

Index	9-2
-------------	-----

A ir Bag - Supplemental Restraint System	3-43
Air Cleaner	7-20
Antenna	3-72
Automatic Climate Control System	4-72
Automatic Transmission	4-9
Automatic Transmission	7-17
B attery	7-23
Brake System	4-24
Brakes and Clutch	7-14
Bulb Replacement	7-33
C ruise Control	4-32
Cup Holder	3-64
D efroster	4-59
Door Locks	3-5
E lectrical Circuit Protection	6-7
Electrical Power Outlet	3-68
Emergency Starting	6-4
Emission Control System	5-3
Engine Compartment	7-8

Engine Cooling System	7-11
Engine Oil and Oil Filter	7-9
Exterior Care	7-43

F our Wheel Drive(4WD)	4-15
Front Seat	3-13
Fuel Filler Lid	3-57
Fuel Requirements	5-2

G auges	4-37
----------------	------

H azard Warning Flasher	4-60
Hood	3-55
How to Use This Manual	1-2

I f You Have a Flat Tire	6-19
Ignition Switch	4-2
Immobilizer System	3-3
Instrument Cluster	4-36
Instrument Panel Overview	2-3
Interior and Exterior Overview	2-2
Interior Care	7-47
Interior Features	4-61
Interior Lights	3-62

- K**ey 3-2
- L**abel Information 5-41
- Lighting 4-52
- Limited Slip Differential 4-24
- Lubricant Specifications 7-41
- Lubricants and Fluids 7-19
- Luggage center box 3-74
- Luggage Net 3-73
- M**aintenance Schedule 7-3
- Maintenance Services 7-2
- Manual Climate Control System 4-65
- Manual Transmission 4-7
- Mirrors 3-60
- Multi-Meter 4-46
- O**verheating 6-3
- Overloading 5-41
- Owner Maintenance 7-7
- P**arking Brake 7-15
- Power Steering 4-31
- Power Steering 7-16
- R**ear Hatch 3-53
- Rear Seat 3-21
- Road Warning 6-2
- Roof Rack 3-75
- S**afety Belts 3-25
- Special Driving Conditions 5-8
- Specifications 8-2
- Starting the Gasoline Engine 4-4
- Steering Wheel 3-58
- Storage Compartment 3-66
- Suggestions for Economical Operation 5-6
- Sunglass Holder 3-65
- Sunroof 3-69
- T**ips on Driving Your Vehicle 5-5
- Tires and Wheels 7-26
- Tonneau cover 3-73
- Towing 6-13
- Trailer Towing 5-32
- U**sing Four-Wheel Drive 5-14

V ehicle Break-In Process	1-3
Vehicle Handling Instruction	1-3
W arnings and Indicators	4-39
Windows	3-10
Windshield Defrosting and Defogging (Automatic type)	4-82
Windshield Defrosting and Defogging (Manual type)	4-80
Wiper Blades	7-21
Wipers and Washers	4-56