

## **Zoom-Zoom**

**All children instinctively know it.**

**A few adults still remember it.**

**One unique car company refuses to outgrow it.**

**In grown-up language, it means the exhilaration and  
liberation that come from experiencing sheer motion.**

**But as usual, children put it much better and simply call it "Go Zoom-Zoom."**

**We practice it every day.**

**It's why we build the kind of cars we do.**

**Zoom-Zoom.**

**Can we re-awaken it in you today?**

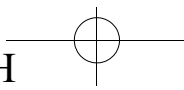
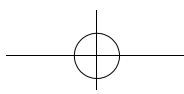

## A Word to Mazda Owners

---

Thank you for choosing a Mazda. We at Mazda design and build vehicles with complete customer satisfaction in mind.

To help ensure enjoyable and trouble-free operation of your Mazda, read this manual carefully and follow its recommendations.

An Authorized Mazda Dealer knows your vehicle best. So when maintenance or service is necessary, that's the place to go.

Our nationwide network of Mazda professionals is dedicated to providing you with the best possible service.

We assure you that all of us at Mazda have an ongoing interest in your motoring pleasure and in your full satisfaction with your Mazda product.

### Mazda Motor Corporation

#### **Important Notes About This Manual**

Keep this manual in the glove box as a handy reference for the safe and enjoyable use of your Mazda. Should you resell the vehicle, leave this manual with it for the next owner.

All specifications and descriptions are accurate at the time of printing. Because improvement is a constant goal at Mazda, we reserve the right to make changes in specifications at any time without notice and without obligation.

#### **Air Conditioning and the Environment**

Your Mazda's genuine air conditioner is filled with HFC134a (R134a), a refrigerant that has been found not to damage the earth's ozone layer. If the air conditioner does not operate properly, consult an Authorized Mazda Dealer.

#### **Perchlorate**

Certain components of this vehicle such as [air bag modules, seat belt pretensioners, lithium batteries, ...] may contain Perchlorate Material - Special handling may apply for service or vehicle end of life disposal. See [www.dtsc.ca.gov/hazardouswaste/perchlorate](http://www.dtsc.ca.gov/hazardouswaste/perchlorate).

**Please be aware that this manual applies to all models, equipment and options. As a result, you may find some explanations for equipment not installed on your vehicle.**

©2012 Mazda Motor Corporation  
Printed in Japan Nov. 2012 (Print2)

## How to Use This Manual

---

We want to help you get the most driving pleasure from your vehicle. Your owner's manual, when read from cover to cover, can do that in many ways.

Illustrations complement the words of the manual to best explain how to enjoy your Mazda. By reading your manual, you can find out about the features, important safety information, and driving under various road conditions.

The symbol below in this manual means "Do not do this" or "Do not let this happen".

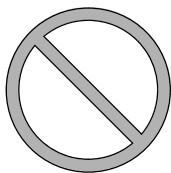

**Index:** A good place to start is the Index, an alphabetical listing of all information in your manual.

You'll find several WARNINGS, CAUTIONS, and NOTES in the manual.

### **WARNING**

*A WARNING indicates a situation in which serious injury or death could result if the warning is ignored.*

### **CAUTION**

*A CAUTION indicates a situation in which bodily injury or damage to your vehicle, or both, could result if the caution is ignored.*

### **NOTE**

*A NOTE provides information and sometimes suggests how to make better use of your vehicle.*

The symbol below, located on some parts of the vehicle, indicates that this manual contains information related to the part. Please refer to the manual for a detailed explanation.





## Table of Contents

|  |           |
|--|-----------|
| <b>Your Vehicle at a Glance</b><br>Interior, exterior views and part identification of your Mazda.   | <b>1</b>  |
| <b>Essential Safety Equipment</b><br>Use of safety equipment, including seats, seat belt system, child-restraint systems and SRS air bags. | <b>2</b>  |
| <b>Knowing Your Mazda</b><br>Explanation of basic operations and controls; opening/closing and adjustment of various parts.                | <b>3</b>  |
| <b>Before Driving Your Mazda</b><br>Important information about driving your Mazda.  | <b>4</b>  |
| <b>Driving Your Mazda</b><br>Explanation of instruments and controls.  | <b>5</b>  |
| <b>Interior Comfort</b><br>Use of various features for drive comfort, including air-conditioning and audio system.                         | <b>6</b>  |
| <b>In Case of an Emergency</b><br>Helpful information on what to do in an emergency.   | <b>7</b>  |
| <b>Maintenance and Care</b><br>How to keep your Mazda in top condition.  | <b>8</b>  |
| <b>Customer Information</b><br>Important consumer information including warranties and add-on equipment.                                   | <b>9</b>  |
| <b>Specifications</b><br>Technical information about your Mazda.   | <b>10</b> |
| <b>Index</b>   | <b>11</b> |

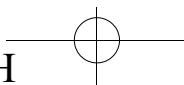
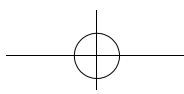



# 1 Your Vehicle at a Glance

Interior, exterior views and part identification of your Mazda.

|                                   |            |
|-----------------------------------|------------|
| <b>Interior Overview .....</b>    | <b>1-2</b> |
| Interior Equipment (View A) ..... | 1-2        |
| Interior Equipment (View B) ..... | 1-3        |
| Interior Equipment (View C) ..... | 1-4        |
| <b>Exterior Overview .....</b>    | <b>1-5</b> |
| Front (4 Door) .....              | 1-5        |
| Rear (4 Door) .....               | 1-6        |
| Front (5 Door) .....              | 1-7        |
| Rear (5 Door) .....               | 1-8        |

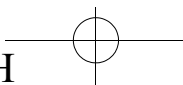

Your Vehicle at a Glance

## Interior Overview

### Interior Equipment (View A)

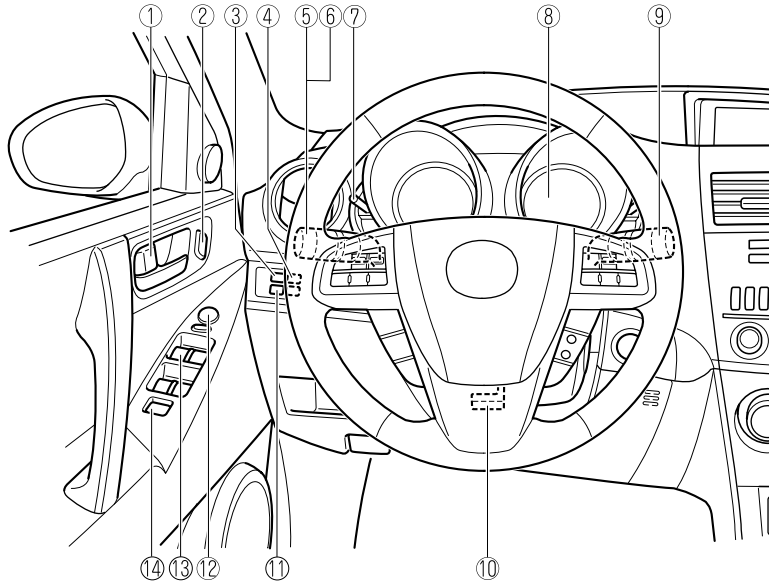

|                                      |           |
|--------------------------------------|-----------|
| ① Door-lock knob .....               | page 3-33 |
| ② Power door lock switch .....       | page 3-34 |
| ③ DSC OFF switch .....               | page 5-29 |
| ④ BSM OFF switch .....               | page 5-40 |
| ⑤ Turn and lane-change signals ..... | page 5-69 |
| ⑥ Lighting control .....             | page 5-64 |
| ⑦ Dashboard illumination knob .....  | page 5-45 |
| ⑧ Instrument cluster .....           | page 5-42 |
| ⑨ Wiper and washer lever .....       | page 5-71 |
| ⑩ Lock release lever .....           | page 3-65 |
| ⑪ AFS OFF switch .....               | page 5-68 |
| ⑫ Outside mirror switch .....        | page 3-65 |
| ⑬ Power window switches .....        | page 3-46 |
| ⑭ Power window lock switch .....     | page 3-48 |

**1-2** The equipment and installation position varies by vehicle

Your Vehicle at a Glance  
**Interior Overview**

**Interior Equipment (View B)**

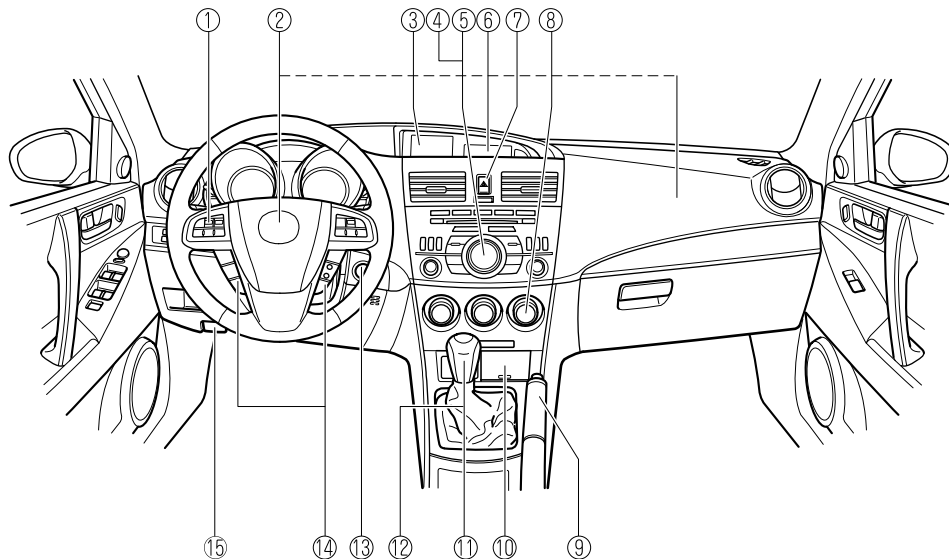

- ① Audio control switches ..... page 6-82
- ② SRS air bags ..... page 2-44
- ③ Multi information display ..... page 6-178
- ④ Navigation system (if equipped) ..... Refer to the separate manual
- ⑤ Audio system ..... page 6-17
- ⑥ Information display ..... page 6-176
- ⑦ Hazard warning flasher switch ..... page 5-77
- ⑧ Climate control system ..... page 6-2
- ⑨ Parking brake ..... page 5-6
- ⑩ Accessory socket ..... page 6-192
- ⑪ MT shift lever ..... page 5-10
- ⑫ AT shift lever ..... page 5-13
- ⑬ Push button start ..... page 3-12
- ⑭ Cruise control switches ..... page 5-22
- ⑮ Hood release handle ..... page 3-50

The equipment and installation position varies by vehicle

Your Vehicle at a Glance

## Interior Overview

### Interior Equipment (View C)

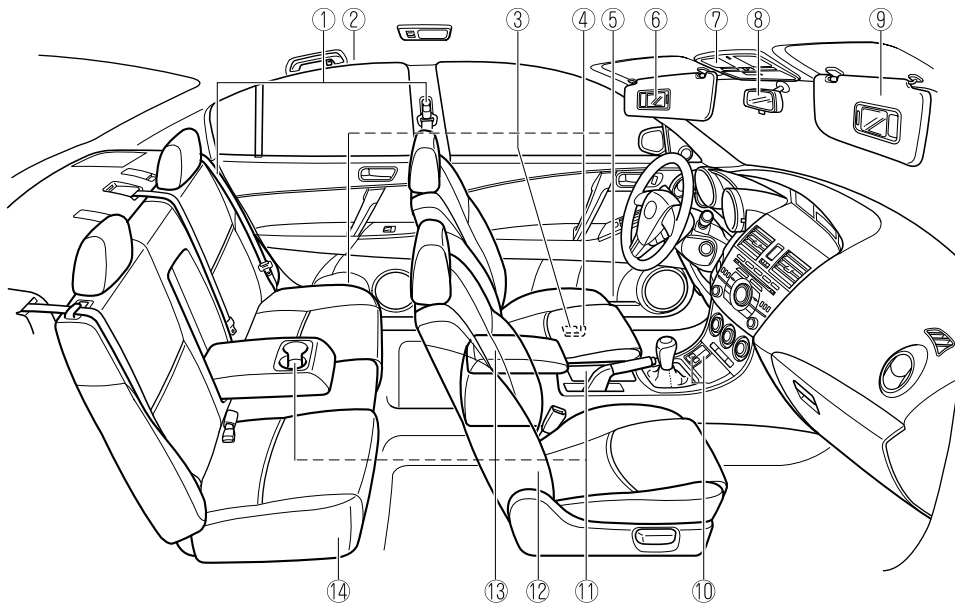

|  |            |
|--|------------|
| ① Seat belts .....                     | page 2-14  |
| ② SRS air bag .....                    | page 2-44  |
| ③ Remote fuel-filler lid release ..... | page 3-49  |
| ④ Trunk release lever .....            | page 3-42  |
| ⑤ Bottle holder .....                  | page 6-188 |
| ⑥ Vanity mirror .....                  | page 6-174 |
| ⑦ Overhead lights .....                | page 6-175 |
| ⑧ Rearview mirror .....                | page 3-66  |
| ⑨ Sunvisor .....                       | page 6-174 |
| ⑩ Seat warmer switches .....           | page 2-12  |
| ⑪ Cup holders .....                    | page 6-187 |
| ⑫ Front seats .....                    | page 2-2   |
| ⑬ Center console .....                 | page 6-190 |
| ⑭ Rear seat .....                      | page 2-7   |

**1-4** The equipment and installation position varies by vehicle

Your Vehicle at a Glance  
**Exterior Overview**

**Front (4 Door)**

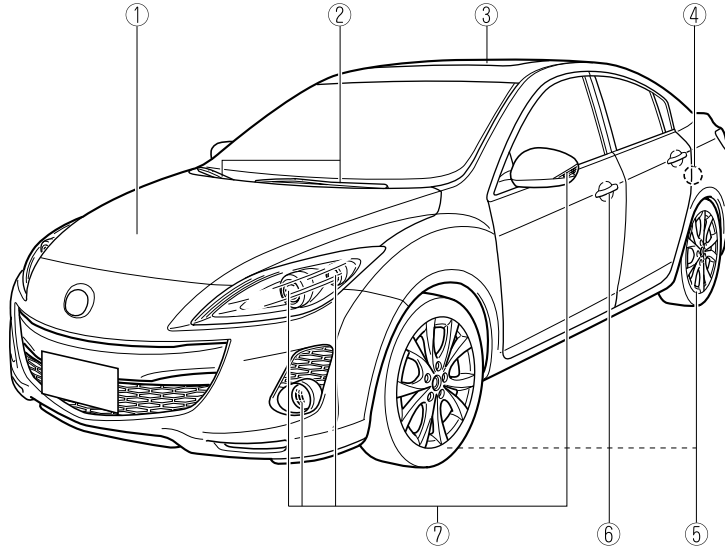

|                                 |           |
|---------------------------------|-----------|
| ① Hood .....                    | page 3-50 |
| ② Windshield wiper blades ..... | page 8-31 |
| ③ Moonroof .....                | page 3-52 |
| ④ Child safety locks .....      | page 3-37 |
| ⑤ Tires .....                   | page 8-39 |
| ⑥ Door lock .....               | page 3-32 |
| ⑦ Light bulbs .....             | page 8-46 |

The equipment and installation position varies by vehicle **1-5**

Your Vehicle at a Glance

## Exterior Overview

### Rear (4 Door)

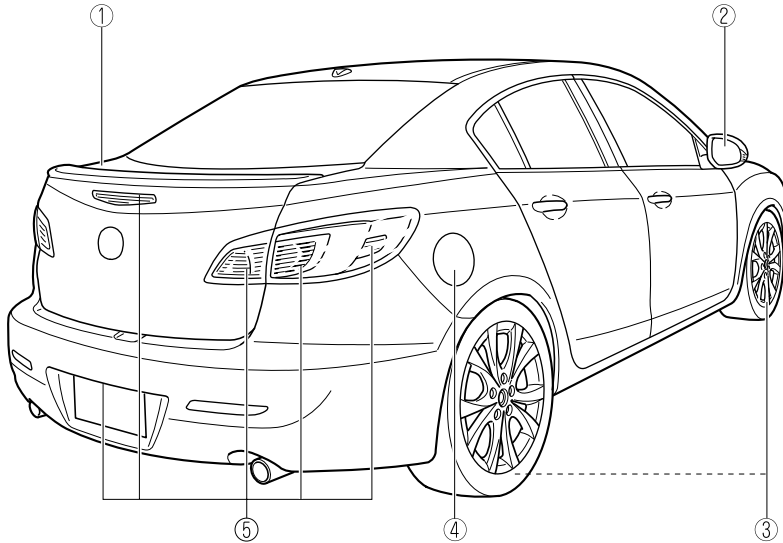

- ① Trunk lid ..... page 3-42
- ② Outside mirror ..... page 3-65
- ③ Tires ..... page 8-39
- ④ Fuel-filler lid ..... page 3-49
- ⑤ Light bulbs ..... page 8-46

**1-6** The equipment and installation position varies by vehicle



Your Vehicle at a Glance  
**Exterior Overview**

**Front (5 Door)**

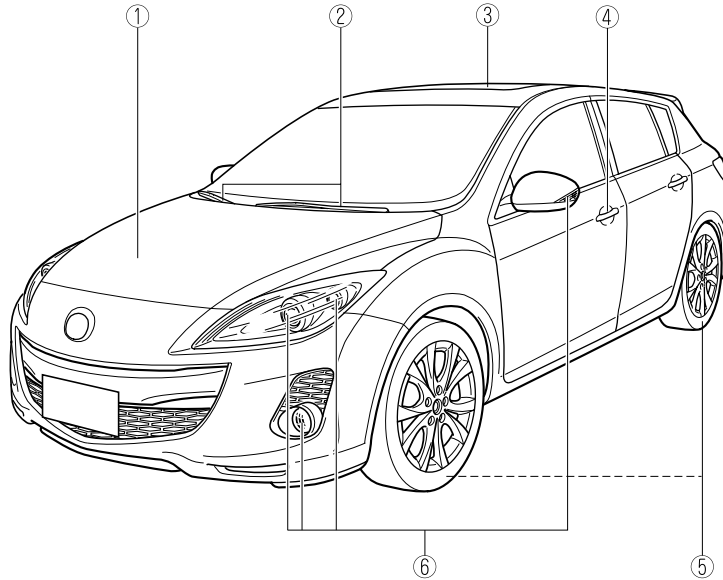

- ① Hood ..... page 3-50
- ② Windshield wiper blades ..... page 8-31
- ③ Moonroof ..... page 3-52
- ④ Door lock ..... page 3-32
- ⑤ Tires ..... page 8-39
- ⑥ Light bulbs ..... page 8-46

The equipment and installation position varies by vehicle **1-7**

Your Vehicle at a Glance

## Exterior Overview

### Rear (5 Door)

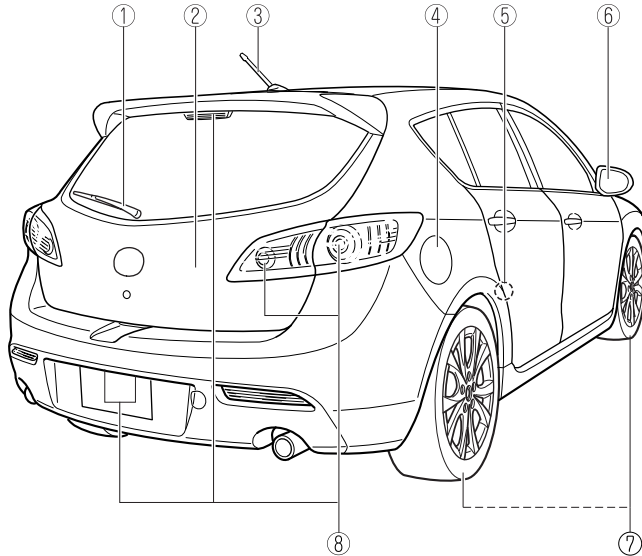

|                           |           |
|---------------------------|-----------|
| ① Rear wiper blade .....  | page 8-33 |
| ② Liftgate .....          | page 3-38 |
| ③ Antenna .....           | page 6-16 |
| ④ Fuel-filler lid .....   | page 3-49 |
| ⑤ Child safety lock ..... | page 3-37 |
| ⑥ Outside mirror .....    | page 3-65 |
| ⑦ Tires .....             | page 8-39 |
| ⑧ Light bulbs .....       | page 8-46 |

**1-8** The equipment and installation position varies by vehicle

## 2 Essential Safety Equipment

Use of safety equipment, including seats, seat belt system, child-restraint systems and SRS air bags.

|  |             |
|--|-------------|
| <b>Seats .....</b>   | <b>2-2</b>  |
| Front Seats (Manually Operated Seats) .....                  | 2-2         |
| Front Seats (Electrically Operated Seats) .....              | 2-4         |
| Rear Seat .....  | 2-7         |
| Head Restraints .....  | 2-10        |
| Seat Warmer * .....  | 2-12        |
| <br>   |             |
| <b>Seat Belt Systems .....</b>                               | <b>2-14</b> |
| Seat Belt Precautions .....                                  | 2-14        |
| Seat Belt .....  | 2-18        |
| Front Seat Belt Pretensioner and Load Limiting Systems ..... | 2-20        |
| Seat Belt Extender .....                                     | 2-23        |
| Seat Belt Warning Light .....                                | 2-24        |
| Seat Belt Reminder .....                                     | 2-25        |
| <br>   |             |
| <b>Child Restraint .....</b>                                 | <b>2-26</b> |
| Child Restraint Precautions .....                            | 2-26        |
| Child-Restraint System Installation Position .....           | 2-31        |
| Installing Child-Restraint Systems .....                     | 2-32        |
| LATCH Child-Restraint Systems .....                          | 2-39        |
| <br>   |             |
| <b>SRS Air Bags .....</b>                                    | <b>2-44</b> |
| Supplemental Restraint System (SRS) Precautions .....        | 2-44        |
| Supplemental Restraint System Components .....               | 2-49        |
| How the SRS Air Bags Work .....                              | 2-50        |
| SRS Air Bag Deployment Criteria .....                        | 2-54        |
| Limitations to SRS Air Bag .....                             | 2-55        |
| Front Passenger Occupant Classification System * .....       | 2-57        |
| Monitoring and Maintenance .....                             | 2-62        |

\*Some models. **2-1**

Essential Safety Equipment

## Seats

### Front Seats (Manually Operated Seats)

#### **⚠ WARNING**

**Do not modify or replace the front seats:**

*Modifying or replacing the front seats such as replacing the upholstery or loosening any bolts is dangerous. The front seats contain air bag components essential to the supplemental restraint system. Such modifications could damage the supplemental restraint system and result in serious injury. Consult an Authorized Mazda Dealer if there is any need to remove or reinstall the front seats.*

**Do not drive with damaged front seats:**

*Driving with damaged front seats is dangerous. A collision, even one not strong enough to inflate the air bags, could damage the front seats which contain essential air bag components. If there was a subsequent collision, an air bag may not deploy which could lead to injuries. Always have an Authorized Mazda Dealer inspect the front seats, front seat belt pretensioners and air bags after a collision.*

**Make sure the adjustable components of a seat are locked in place:**

*Adjustable seats and seatbacks that are not securely locked are dangerous. In a sudden stop or collision, the seat or seatback could move, causing injury. Make sure the adjustable components of the seat are locked in place by attempting to slide the seat forward and backward and rocking the seatback.*

**Adjust the driver's seat only when the vehicle is stopped:**

*Adjusting the driver's seat while the vehicle is moving is dangerous. The driver could lose control of the vehicle and have an accident.*

#### **⚠ CAUTION**

*Be careful not to place your hands and fingers around moving parts of the front seat when adjusting the seat positions to prevent injury.*

#### **▼ Seat Slide**

To move a seat forward or backward, raise the lever and slide the seat to the desired position and release the lever.

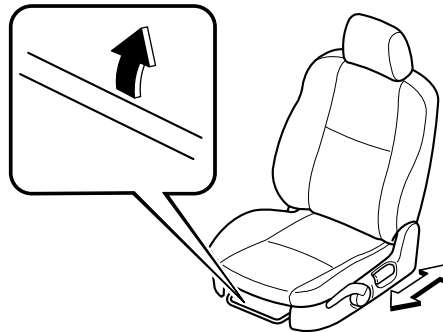

Essential Safety Equipment  
**Seats**

Make sure the lever returns to its original position and the seat is locked in place by attempting to push it forward and backward.

▼ **Seat Recline**

**⚠ WARNING**

**Do not drive with either front seat reclined:**

*Sitting in a reclined position while the vehicle is moving is dangerous because you do not get the full protection from seat belts. During sudden braking or a collision, you can slide under the lap belt and suffer serious internal injuries. For maximum protection, sit well back and upright.*

**Always sit in the front passenger seat properly with the seatback upright and feet on the floor (With Front Passenger Occupant Classification System):**

*Your front passenger seat has weight sensors, sitting in the front passenger seat improperly out of position or with the seatback reclined too far while the vehicle is moving is dangerous as it can take off weight from the seat bottom and affect the weight determination of the front passenger sensing system. As a result the front passenger will not have the supplementary protection of the air bag and seat belt pretensioner, which could result in serious injury. Always sit upright against the seatback with your feet on the floor.*

**Do not drive with the seatback unlocked:**

*All of the seatbacks play an important role in your protection in a vehicle. Leaving the seatback unlocked is dangerous as it can allow passengers to be ejected or thrown around and baggage to strike occupants in a sudden stop or collision, resulting in severe injury. After adjusting the seatback at any time, even when there are no other passengers, rock the seatback to make sure it is locked in place.*

To change the seatback angle, lean forward slightly while raising the lever. Then lean back to the desired position and release the lever.

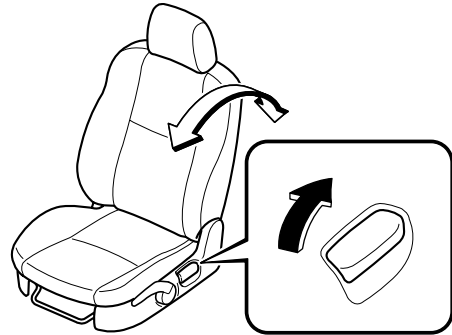

Make sure the lever returns to its original position and the seatback is locked in place by attempting to push it forward and backward.

Essential Safety Equipment

## Seats

### **⚠ CAUTION**

*When returning a rear-reclined seatback to its upright position, make sure you hold onto the seatback with your other hand while operating the lever. If the seatback is not supported, it will flip forward suddenly and could cause injury.*

### **▼ Height Adjustment (Driver's Seat)**

To adjust the seat height, move the lever up or down.

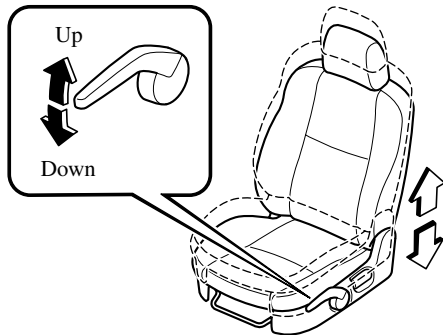

### **Front Seats (Electrically Operated Seats)**

The power operated seat is available only on the driver's seat. The front passenger seat is manually operated. Refer to Front Seats (Manually Operated Seats) (page 2-2) for adjustment instructions.

Essential Safety Equipment  
**Seats**

**⚠ WARNING**

**Do not modify or replace the front seats:**

*Modifying or replacing the front seats such as replacing the upholstery or loosening any bolts is dangerous. The front seats contain air bag components essential to the supplemental restraint system. Such modifications could damage the supplemental restraint system and result in serious injury. Consult an Authorized Mazda Dealer if there is any need to remove or reinstall the front seats.*

**Do not drive with damaged front seats:**

*Driving with damaged front seats is dangerous. A collision, even one not strong enough to inflate the air bags, could damage the front seats which contain essential air bag components. If there was a subsequent collision, an air bag may not deploy which could lead to injuries. Always have an Authorized Mazda Dealer inspect the front seats, front seat belt pretensioners and air bags after a collision.*

**Adjust the driver's seat only when the vehicle is stopped:**

*Adjusting the driver's seat while the vehicle is moving is dangerous. The driver could lose control of the vehicle and have an accident.*

**⚠ CAUTION**

- *The seat-bottom power adjustment is operated by motors. Avoid extended operation because excessive use can damage the motors.*
- *To prevent the battery from running down, avoid using the power adjustment when the engine is stopped. The adjuster uses a large amount of electrical power.*
- *Do not use the switch to make more than one adjustment at a time.*
- *Be careful not to place your hands and fingers around moving parts of the front seat when adjusting the seat positions to prevent injury.*

**▼ Seat Slide**

To slide the seat, move the slide lifter switch on the outside of the seat to the front or back and hold it. Release the switch at the desired position.

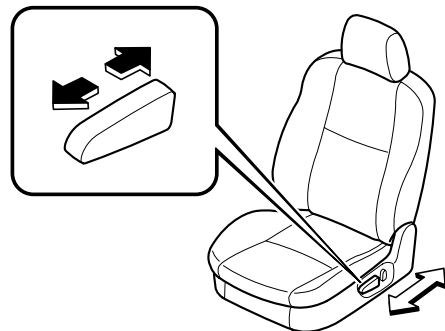

Essential Safety Equipment

## Seats

### ▼ Seat Recline

#### **⚠ WARNING**

**Do not drive with either front seat reclined:**

*Sitting in a reclined position while the vehicle is moving is dangerous because you do not get the full protection from seat belts. During sudden braking or a collision, you can slide under the lap belt and suffer serious internal injuries. For maximum protection, sit well back and upright.*

To change the seatback angle, press the front or rear side of the reclining switch. Release the switch at the desired position.

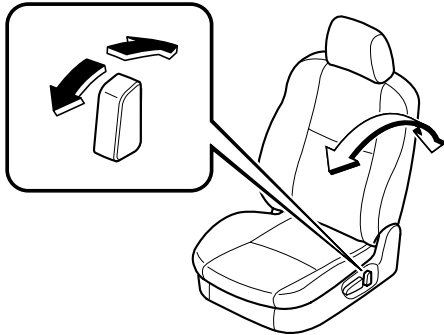

### ▼ Height Adjustment

To adjust the seat height, move the switch up or down.

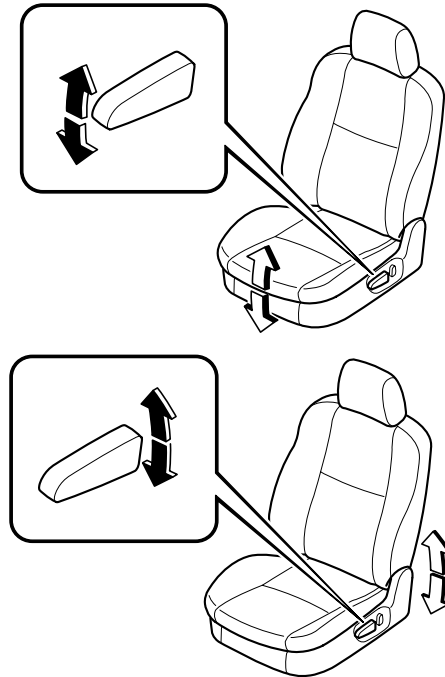



## Rear Seat

### **⚠ WARNING**

**Do not stack cargo higher than the seatbacks or place articles on the rear package tray or on the luggage compartment cover:**

*Stacking luggage or other cargo higher than the seatbacks, and placing articles on the rear package tray or on the luggage compartment cover is dangerous. During sudden braking or a collision, objects can fly around and become projectiles that may hit and injure passengers.*

**Make sure luggage and cargo are secured before driving:**

*Not securing cargo while driving is dangerous as it could move or be crushed during sudden braking or a collision and cause injury.*

**Do not drive with the seatback unlocked:**

*All of the seatbacks play an important role in your protection in a vehicle. Leaving the seatback unlocked is dangerous as it can allow passengers to be ejected or thrown around and baggage to strike occupants in a sudden stop or collision, resulting in severe injury. After returning the seatback at any time, even when there are no other passengers, rock the seatback to make sure it is locked in place.*

**Never allow a passenger to sit or stand on the folded seatback while the vehicle is moving:**

*Driving with a passenger on the folded seatback is dangerous. Allowing a child to sit up on the folded seatback while the vehicle is moving is particularly dangerous. In a sudden stop or even a minor collision, a child not in a proper seat or child-restraint system and seat belt could be thrown forward, back or even out of the vehicle resulting in serious injuries or death. The child in the baggage area could be thrown into other occupants and cause serious injury.*

**Never give the car keys to children and do not allow them to play in the vehicle (4 Door):**

*Playing with the folding rear seats is dangerous. The folding rear seatbacks cannot be folded down from inside the trunk. Once the seatbacks are back up, a child in the trunk would not be able to get out the way they had entered. If you have small children, keep the seatbacks locked.*

## Essential Safety Equipment

# Seats

### **Always leave your car locked and keep the car keys safely away from children:**

*Leaving your car unlocked or the keys in reach of children is dangerous. Children who find their way into the trunk through an unlocked rear seatback or an open trunk can become accidentally locked in the trunk. This could result in death or brain damage from heat prostration, particularly in the summer. Always lock the doors and the trunk, and as an added measure, keep the rear seatbacks locked, whether you have children in your home or not.*

### **Do not leave the key in your vehicle with children and keep them in a place where your children will not find or play with them:**

*Leaving children in a vehicle with the key is dangerous. This could result in someone being badly injured or even killed. Children may find these new kinds of keys to be an interesting toy to play with and could cause the power windows or other controls to operate, or even make the vehicle move.*

#### **NOTE**

*When returning a rear seat to its original position, also replace the seat belt to its normal position. Verify that the seat belt pulls out and retracts.*

### **▼ Split-Folding Rear Seatback**

#### **To fold the seatbacks**

#### **⚠ CAUTION**

*When operating the rear seatback knob, make sure you support the seatback with your hand. If the seatback is not supported with your hand, it will flip forward suddenly and could cause injury to the finger that pushes the rear seatback knob down.*

1. Support the seatback with your hand.
2. Push the rear seatback knob down.

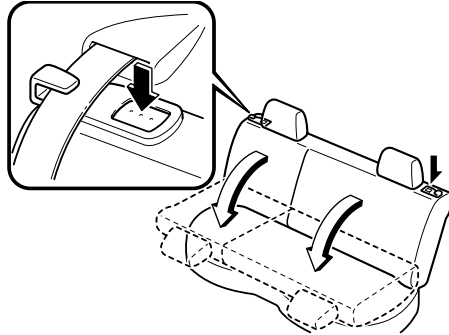

#### **To return the seatbacks to the upright position**

1. Lift the seatbacks upright.
2. Pull on the top of the seatbacks from inside the vehicle to make sure they are locked.

Essential Safety Equipment  
**Seats**

**⚠ WARNING**

**Always make sure the seat belts are fully pulled out from under the seatbacks:**

*A seat belt caught under a seatback after the seatback is returned to its upright position is dangerous. In a collision or sudden stop, the seat belt cannot provide adequate protection.*

**When returning the seatback to the upright position, make sure there is no red indication:**

*A rear seatback not fully returned and locked in the upright position is dangerous. Sudden stops or maneuvering could cause a seatback to flip forward suddenly resulting in injury. If the red indicator is visible on the back of the rear seatback knob, the seatback is not locked in the upright position.*

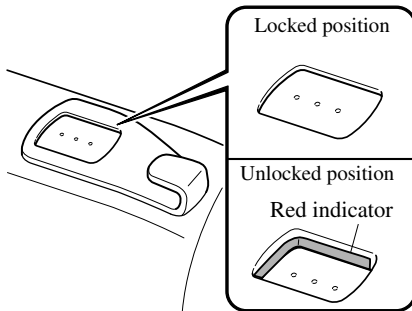

**▼ Armrest\***

The rear armrest in the center of the rear seatback can be used (no occupant in the center seat) or placed upright.

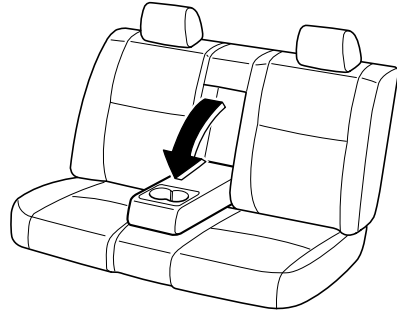

\*Some models.

Essential Safety Equipment

## Seats

### Head Restraints

Your vehicle is equipped with head restraints on all outboard seats. The head restraints are intended to help protect you and the passengers from neck injury.

#### **⚠ WARNING**

***Always drive with the head restraints installed when seats are being used and make sure they are properly adjusted:***

*Driving with the head restraints adjusted too low or removed is dangerous. With no support behind your head, your neck could be seriously injured in a collision.*

#### **▼ Normal Head Restraints**

##### **Height adjustment**

To raise a head restraint, pull it up to the desired position.

To lower the head restraint, press the stop-catch release, then push the head restraint down.

Adjust the head restraint so that the center is even with the top of the passenger's ears.

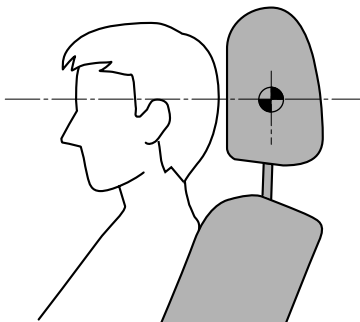

#### **Front outboard seat**

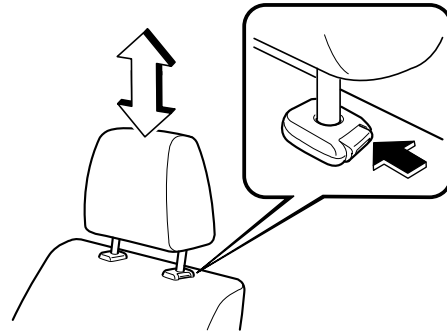

#### **Rear outboard seat**

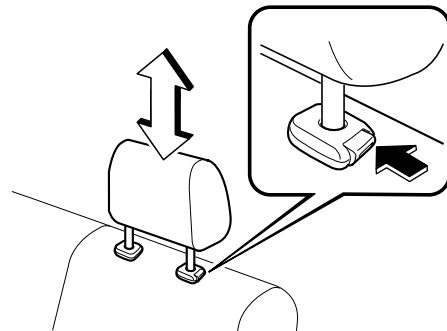

#### **Removal/Installation**

To remove the head restraint, pull it up while pressing the stop-catch.

To install the head restraint, press the uprights into the holes while pressing the stop-catch.

#### **⚠ WARNING**

***Always drive with the head restraints set up when seats are being used and make sure they are properly set up:***

*Driving with the head restraints not set up is dangerous. With no support behind your head, your neck could be seriously injured in a collision.*

Essential Safety Equipment  
**Seats**

**Active Head Restraints\***

The front seats are equipped with active head restraints. In a rear-end collision, the active head restraints use the force applied by the occupant on the seatback to instantaneously move the head restraints in the forward direction, reducing excessive rearward tilting of the head and reducing the load on the neck. The active head restraints are also highly effective at reducing whip-lash injuries which commonly occur in rear-end collisions at low to mid-range vehicle speeds.

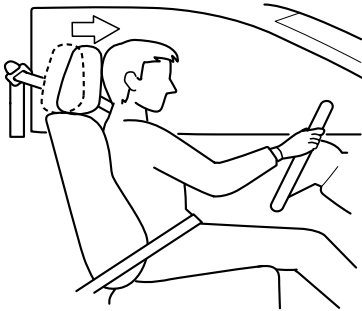

**⚠ WARNING**

- Always adjust the head restraints properly as specified in this section. Failure to do so can reduce the effectiveness of the active head restraint.
- Do not attach any accessories such as a TV screen to a front seatback and/or a front head restraint. Also do not place heavy items or thick items, or both in the seatback pocket. Doing so could reduce the effectiveness of the active head restraint in a rear-end collision.

**NOTE**

- The active head restraints operate in a rear-end collision. The head restraints return to their original position after the collision.
- The method for adjusting the active head restraints is the same as non-active head restraint.

**▼ Foldable Head Restraints\***

The rear seats are equipped with foldable head restraints.

**NOTE**

The foldable head restraints cannot be adjusted or removed.

To fold the head restraint, pull the strap and fold the head restraint downward. To return the head restraint to its upright position, lift it upward.

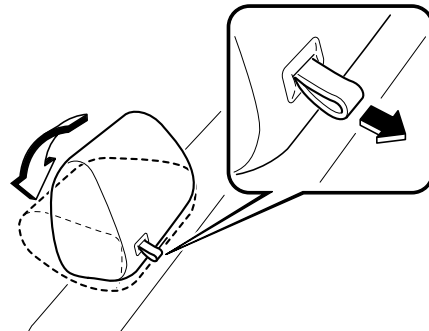

**⚠ WARNING**

**Always drive with the head restraints in their upright positions when the rear seats are occupied, and make sure they are securely locked in place:**

*Driving with the head restraints folded down is dangerous. With no support behind your head, your neck could be seriously injured in a collision.*

\*Some models. **2-11**

Essential Safety Equipment

## Seats

### Seat Warmer\*

The driver and front passenger seats can be warmed by rotating the applicable seat warmer dial while the ignition is switched ON.

The seat temperature increases as the number on the dial increases. When the seat warmers are not in use, rotate the seat warmer dials to 0.

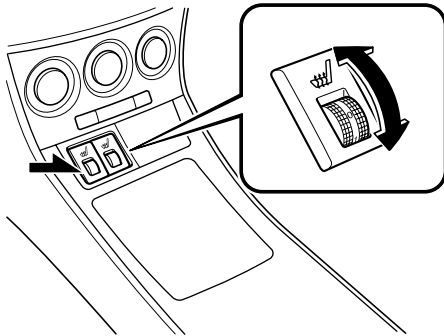

### **⚠ WARNING**

- *Be careful when using the seat warmer. The heat from the seat warmer may be too hot for some people, as indicated below, and could cause a low-temperature burn.*
- *Infants, small babies, elderly people, and physically challenged people*
- *People with delicate skin*
- *People who are excessively fatigued*
- *People who are intoxicated*
- *People who have taken sleep-inducing medicine such as sleeping pills or cold medicine*
- *Do not use the seat warmer with anything having high moisture-retention ability such as a blanket or cushion on the seat. The seat may be heated excessively and cause a low-temperature burn.*
- *Do not use the seat warmer even when taking a short nap in the vehicle. The seat may be heated excessively and cause a low-temperature burn.*
- *Do not place heavy objects with sharp projections on the seat, or insert needles or pins into it. This could cause the seat to become excessively heated and result in injury from a minor burn.*

### **⚠ CAUTION**

*Do not use organic solvents to clean the seat. It may damage the seat surface and the heater.*

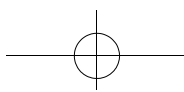

Essential Safety Equipment  
**Seats**

---

**NOTE**

*Use the seat warmer when the engine is running, and do not continue to use it for a long period of time.*

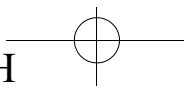
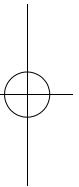
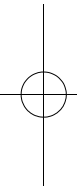

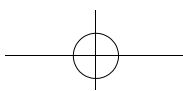

Essential Safety Equipment

## Seat Belt Systems

---

### Seat Belt Precautions

Seat belts help to decrease the possibility of severe injury during accidents and sudden stops. Mazda recommends that the driver and all passengers always wear seat belts.

All of the seat belt retractors are designed to keep the lap/shoulder belts out of the way when not in use.

The driver's seat belt has no provisions for child-restraint systems and has only an emergency locking mode. The driver may wear it comfortably, and it will lock during a collision.

However, the front passenger's seat and all rear lap/shoulder belt retractors operate in two modes: emergency locking mode, and for child-restraint systems, automatic locking mode. While we recommend you put all children in the rear seats, if you must use the front passenger seat for a child, slide the front passenger seat as far back as possible and make sure any child-restraint system is secured properly.

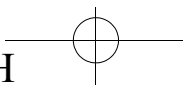



Essential Safety Equipment  
**Seat Belt Systems**

---

**⚠ WARNING**

***Always wear your seat belt and make sure all occupants are properly restrained:***

*Not wearing a seat belt is extremely dangerous. During a collision, occupants not wearing seat belts could hit someone or things inside the vehicle or even be thrown out of the vehicle. They could be seriously injured or even killed. In the same collision, occupants wearing seat belts would be much safer.*

***Do not wear twisted seat belts:***

*Twisted seat belts are dangerous. In a collision, the full width of the belt is not available to absorb the impact. This puts more force on the bones beneath the belt, which could cause serious injury or death. So, if your seat belt is twisted, you must straighten the seat belt to remove any twists and to allow the full width of the belt to be used.*

***Never use one seat belt on more than one person at a time:***

*Using one seat belt for more than one person at a time is dangerous. A seat belt used in this way cannot spread the impact forces properly and the two passengers could be crushed together and seriously injured or even killed. Never use one belt for more than one person at a time and always operate the vehicle with each occupant properly restrained.*

***Do not operate a vehicle with a damaged seat belt:***

*Using a damaged seat belt is dangerous. An accident could damage the belt webbing of the seat belt in use. A damaged seat belt cannot provide adequate protection in a collision. Have an Authorized Mazda Dealer inspect all seat belt systems in use during an accident before they are used again.*

***Have your seat belts changed immediately if the pretensioner or load limiter has been expended:***

*Always have an Authorized Mazda Dealer immediately inspect the front seat belt pretensioners and air bags after any collision. Like the air bags, the front seat belt pretensioners and load limiters will only function once and must be replaced after any collision that caused them to deploy. A seat belt with an expended pretensioner or load limiter is still better than wearing no seat belt at all; however, if the front seat belt pretensioners and load limiters are not replaced, the risk of injury in a collision will increase.*

Essential Safety Equipment

## Seat Belt Systems

---

### **CAUTION**

*Belt retraction may become difficult if the belts and rings are soiled, so try to keep them clean. For more details about cleaning the seat belts, refer to “Cleaning the Lap/Shoulder Belt Webbing” (page 8-73).*

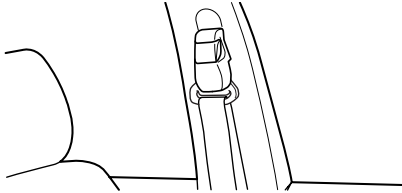

### **▼ Pregnant Women and Persons with Serious Medical Conditions**

Pregnant women should always wear seat belts. Ask your doctor for specific recommendations.

The lap belt should be worn **SNUGLY AND AS LOW AS POSSIBLE OVER THE HIPS**. The shoulder belt should be worn across your shoulder properly, but never across the stomach area.

Persons with serious medical conditions also should wear seat belts. Check with your doctor for any special instructions regarding specific medical conditions.



### **▼ Emergency Locking Mode**

In the emergency locking mode, the belt remains comfortable on the occupant and the retractor will lock in position during a collision. When the seat belt is fastened, it will always be in the emergency locking mode until it is switched to automatic locking mode by pulling it all the way out to its full length. If the belt feels tight and hinders comfortable movement while the vehicle is stopped or in motion, it may be in the automatic locking mode because the belt has been pulled too far out. To return the belt to the more comfortable emergency locking mode, wait until the vehicle has stopped in a safe, level area, retract the belt fully to convert it back to emergency locking mode and then extend it around you again.

If the belt is locked and cannot be pulled out, retract the belt once, and then try pulling it out slowly. If this fails, pull the belt strongly one time and loosen, then pull it out again slowly.



Essential Safety Equipment  
**Seat Belt Systems**

---

**▼ Automatic Locking Mode**

Always use the automatic locking mode to keep the child-restraint system from shifting to an unsafe position in the event of an accident. To enable seat belt automatic locking mode, pull it all the way out and connect it as instructed on the child-restraint system. It will retract down to the child-restraint system and stay locked on it. See the section on child restraint (page 2-26).

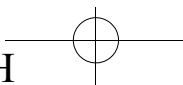
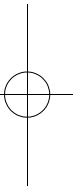
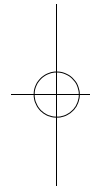

Essential Safety Equipment

## Seat Belt Systems

### Seat Belt

#### ▼ Fastening the Seat Belt

1. Grasp the seat belt tongue.
2. Slowly pull out the lap/shoulder belt.

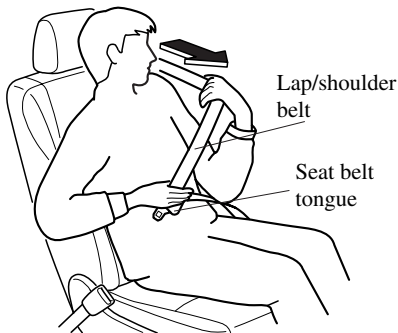

3. Insert the seat belt tongue into the seat belt buckle until you hear a click sound.

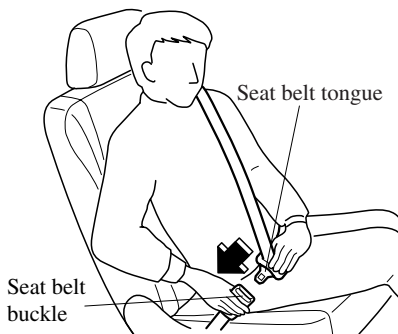

#### **⚠ WARNING**

##### **Positioning the Shoulder Portion of the Seat Belt:**

*Improper positioning of the shoulder portion of the seat belt is dangerous. Always make sure the shoulder portion of the seat belt is positioned across your shoulder and near your neck, but never under your arm, on your neck, or on your upper arm.*

4. Position the lap belt as low as possible, not on the abdominal area, then adjust the shoulder belt so that it fits snugly against your body.

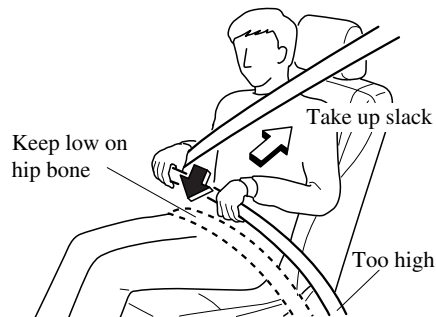

#### **⚠ WARNING**

##### **Positioning the Lap Portion of the Seat Belt:**

*The lap portion of the seat belt worn too high is dangerous. In a collision, this would concentrate the impact force directly on the abdominal area, causing serious injury. Wear the lap portion of the belt snugly and as low as possible.*

## Essential Safety Equipment Seat Belt Systems

### ▼ Unfastening the Seat Belt

Depress the button on the seat belt buckle. If the belt does not fully retract, pull it out and check for kinks or twists. Then make sure it remains untwisted as it retracts.

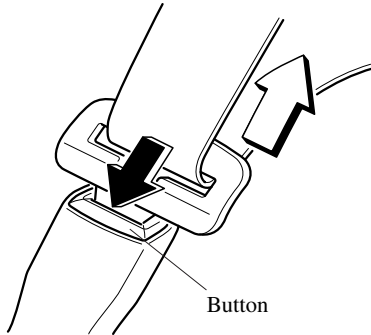

#### **NOTE**

*If a belt does not fully retract, inspect it for kinks and twists. If it is still not retracting properly, have it inspected at an Authorized Mazda Dealer.*

### ▼ Front Shoulder Belt Adjuster

Adjust the height of the shoulder belt if the seat belt touches your neck, or if it crosses your arm instead of your shoulder. To raise the shoulder belt adjuster, push the adjuster up. To lower the shoulder belt adjuster, pull the adjuster and slide it down. Make sure the adjuster is locked.

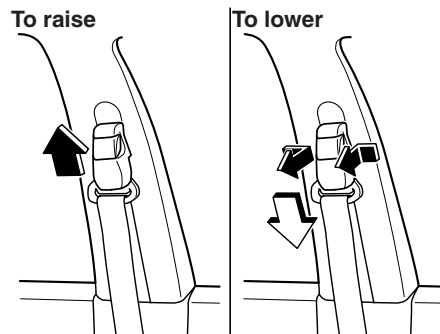

#### **! WARNING**

#### **Positioning the Shoulder Portion of the Seat Belt:**

*Improper positioning of the shoulder portion of the seat belt is dangerous. Always make sure the shoulder portion of the seat belt is positioned across your shoulder and near your neck, but never under your arm, on your neck, or on your upper arm.*

Essential Safety Equipment

## Seat Belt Systems

### Front Seat Belt Pretensioner and Load Limiting Systems

For optimum protection, the driver and front passenger seat belts are equipped with pretensioner and load limiting systems. For both these systems to work properly you must wear the seat belt properly.

#### **Pretensioners:**

In moderate or severe frontal or near-frontal accidents, the front air bag and pretensioner systems deploy simultaneously. The front seat belt retractors remove slack quickly as the air bags are expanding. Any time the air bags and front seat belt pretensioners have deployed they must be replaced.

#### **(With Front Passenger Occupant Classification System)**

During a side collision, the side air bag, curtain air bag, and pretensioner system operate simultaneously on the side in which the collision occurs.

In addition, the pretensioner system for the front passenger, like the front and side passenger air bag, is designed to only deploy in accordance with the total seated weight on the front passenger seat.

For details, refer to the front passenger seat weight sensors (page 2-57).

#### **Load limiter:**

The load limiting system releases belt webbing in a controlled manner to reduce belt force on the occupant's chest. While the most severe load on a seat belt occurs in frontal collisions, the load limiter has an automatic mechanical function and can activate in any accident mode with sufficient occupant movement.

Even if the pretensioners have not deployed, the load limiting function must be checked by an Authorized Mazda Dealer after any collision.

### **! WARNING**

***Wear seat belts only as recommended in this owner's manual:***

*Incorrect positioning of the driver and front passenger seat belts is dangerous. Without proper positioning, the pretensioner and load limiting systems cannot provide adequate protection in an accident and this could result in serious injury. For more details about wearing seat belts, refer to "Fastening the seat belts" (page 2-18).*

## Essential Safety Equipment Seat Belt Systems

### **Have your seat belts changed immediately if the pretensioner or load limiter has been expended:**

Always have an Authorized Mazda Dealer immediately inspect the front seat belt pretensioners and air bags after any collision. Like the air bags, the front seat belt pretensioners and load limiters will only function once and must be replaced after any collision that caused them to deploy. A seat belt with an expended pretensioner or load limiter is still better than wearing no seat belt at all; however, if the front seat belt pretensioners and load limiters are not replaced, the risk of injury in a collision will increase.

### **Do not modify the components or wiring, or use electronic testing devices on the pretensioner system:**

Modifying the components or wiring of the pretensioner system, including the use of electronic testing devices is dangerous. You could accidentally activate it or make it inoperable which would prevent it from activating in an accident. The occupants or repairers could be seriously injured.

### **Properly dispose of the pretensioner system:**

Improper disposal of the pretensioner system or a vehicle with non-deactivated pretensioners is dangerous. Unless all safety procedures are followed, injury could result. Ask an Authorized Mazda Dealer how to safely dispose of the pretensioner system or how to scrap a pretensioner-equipped vehicle.

### **NOTE**

- The pretensioner system will activate in a moderate or greater frontal or near-frontal collision. It will not activate in most rollovers, side or rear impacts.  
**(With Front Passenger Occupant Classification System)**  
The pretensioner system will activate in a severe side collision.  
In addition, the pretensioner system for the front passenger is designed to only deploy in accordance with the total seated weight on the front passenger seat.
- Some smoke (non-toxic gas) will be released when the air bags and pretensioners deploy. This does not indicate a fire. This gas normally has no effect on occupants, however, those with sensitive skin may experience light skin irritation. If residue from the deployment of the air bags or the front pretensioner system gets on the skin or in the eyes, wash it off as soon as possible.

### **▼ Air Bag/Front Seat Belt Pretensioner System Warning Light**



If the air bag/front seat belt pretensioner system is working properly, the warning light illuminates when the ignition is switched ON or after the engine is cranked. The warning light turns off after a specified period of time.

Essential Safety Equipment

## Seat Belt Systems

A system malfunction is indicated if the warning light constantly flashes, constantly illuminates or does not illuminate at all when the ignition is switched ON. If any of these occur, consult an Authorized Mazda Dealer as soon as possible. The system may not operate in an accident.

### **WARNING**

**Never tamper with the air bag/pretensioner systems and always have an Authorized Mazda Dealer perform all servicing and repairs:**

*Self-servicing or tampering with the systems is dangerous. An air bag/pretensioner could accidentally activate or become disabled causing serious injury or death.*

### ▼ **Air Bag/Front Seat Belt Pretensioner System Warning Beep**

If a malfunction is detected in the air bag/front seat belt pretensioner systems and the warning light, a warning beep sound will be heard for about 5 seconds every minute.

The air bag and seat belt pretensioner system warning beep sound will continue to be heard for approximately 35 minutes. Have your vehicle inspected at an Authorized Mazda Dealer as soon as possible.

### **WARNING**

**Do not drive the vehicle with the air bag/front seat belt pretensioner system warning beep sounding:**

*Driving the vehicle with the air bag/front seat belt pretensioner system warning beep sounding is dangerous. In a collision, the air bags and the front seat belt pretensioner system will not deploy and this could result in death or serious injury. Contact an Authorized Mazda Dealer to have the vehicle inspected as soon as possible.*



Essential Safety Equipment  
**Seat Belt Systems**

### Seat Belt Extender

If your seat belt is not long enough, even when fully extended, a seat belt extender may be available to you at no charge from your Authorized Mazda Dealer.

This extender will be only for you and for the particular vehicle and seat. Even if it plugs into other seat belts, it may not hold in the critical moment of a crash.

When ordering an extender, only order one that provides the necessary additional length to fasten the seat belt properly.

Please contact your Authorized Mazda Dealer for more information.

#### **! WARNING**

**Do not use a seat belt extender unless it is necessary:**

*Using a seat belt extender when not necessary is dangerous. The seat belt will be too long and not fit properly. In an accident, the seat belt will not provide adequate protection and you could be seriously injured. Only use the extender when it is required to fasten the seat belt properly.*

**Do not use an improper extender:**

*Using a seat belt extender that is for another person or a different vehicle or seat is dangerous. The seat belt will not provide adequate protection and the user could be seriously injured in an accident. Only use the extender provided for you and for the particular vehicle and seat. NEVER use the extender in a different vehicle or seat. If you sell your Mazda, do not leave your seat belt extender in the vehicle. It could be used accidentally by the new owner of the vehicle. After removing the seat belt extender, discard it. Never use the seat belt extender in any other vehicle you may own in the future.*

**Do not use an extender that is too long:**

*Using an extender that is too long is dangerous. The seat belt will not fit properly. In an accident, the seat belt will not provide adequate protection and you could be seriously injured. Do not use the extender or choose one shorter in length if the distance between the extender's buckle and the center of the user's body is less than 15 cm (6 in).*

Essential Safety Equipment

## Seat Belt Systems

### **Do not leave a seat belt extender connected to the buckle:**

*Leaving a seat belt extender connected to the buckle without using the seat belt is dangerous. When the seat belt extender is connected to the driver's seat belt buckle (or front passenger) seat, the SRS driver's (or front passenger's) air bag system will determine that the driver (or front passenger) is wearing the seat belt even if the driver (or front passenger) is not wearing it. This condition could cause the driver's (or front passenger's) air bag to not activate correctly and result in death or serious injury in the event of collision. Always wear the seat belt with the seat belt extender.*

### **Do not use the seat belt extender when installing a child-restraint system on the front or rear passenger seat:**

*Using a seat belt extender to fasten a child-restraint system on any seat is dangerous. Always follow the child-restraint system manufacturer's installation instructions and never use a seat belt extender.*

#### **NOTE**

*When not in use, remove the seat belt extender and store it in the vehicle. If the seat belt extender is left connected, the seat belt extender might get damaged as it will not retract with the rest of the seat belt and can easily fall out of the door when not in use and be damaged. In addition, the seat belt warning light will not illuminate and function properly.*

## Seat Belt Warning Light



### **With warning light for front passenger's seat**

The seat belt warning light illuminates if the driver or front passenger's seat is occupied and the seat belt is not fastened when the ignition switched ON.

### **Without warning light for front passenger's seat**

The seat belt warning light illuminates if the driver's seat belt is not fastened when the ignition switched ON.

Essential Safety Equipment  
**Seat Belt Systems**

## Seat Belt Reminder

### **NOTE**

Consult an Authorized Mazda Dealer to deactivate or restore the belt reminder. Though the belt reminder can be deactivated, doing so will defeat the purpose of the system to warn the driver and the front passenger in the event that their seat belts are not fastened. For the safety of the driver and front passenger, Mazda recommends not deactivating the belt reminder.

If the vehicle is driven with the driver or front passenger's seat belt unfastened, the seat belt warning light illuminates and a warning chime sounds.

### **NOTE**

Some models do not have the seat belt reminder function for the front passenger's seat.

If the driver or front passenger's seat belt is unfastened (only when the front passenger seat is occupied) and the vehicle is driven at a speed faster than about 20 km/h (12 mph), the warning light will flash and a beep sound will be heard. After a short time, the warning light stops flashing, but remains illuminated, and the beep sound stops.

Until a seat belt is fastened or a given period of time has elapsed, the beep sound will not stop even if the vehicle speed falls below 20 km/h (12 mph).

### **NOTE**

- The warning light flashes and a beep sound will be heard for about 6 seconds if the driver's seat belt is not fastened when the ignition is switched ON.
- If a driver or front passenger's seat belt is unfastened after the beep sound turns off (warning light remains illuminated), and the vehicle speed exceeds 20 km/h (12 mph), the warning light flashes and beep sound activates again.
- Placing items on the front passenger seat may cause the front passenger seat belt warning function to operate depending on the weight of the item.
- To allow the front passenger seat weight sensor to function properly, do not place and sit on an additional seat cushion on the front passenger seat. The sensor may not function properly because the additional seat cushion could cause sensor interference.
- When a small child sits on the front passenger seat, it is possible that the warning light will not operate.

Essential Safety Equipment

## Child Restraint

### Child Restraint Precautions

Mazda strongly urges the use of child-restraint systems for children small enough to use them.

You are required by law to use a child-restraint system for children in the U.S. and Canada. Check your local and state or provincial laws for specific requirements regarding the safety of children riding in your vehicle.

Whatever child-restraint system you consider, please pick the appropriate one for the age and size of the child, obey the law and follow the instructions that come with the individual child-restraint system.

A child who has outgrown child-restraint systems should sit in the rear and use seat belts, both lap and shoulder. If the shoulder belt crosses the neck or face, move the child closer to the center of the vehicle in the outboard seats, and towards the buckle on the right if the child is seated on the center seat.

Statistics confirm that the rear seat is the best place for all children up to 12 years of age, and more so with a supplemental restraint system (air bags).

A rear-facing child-restraint system should **NEVER** be used on the front seat with the air bag system activated. The front passenger's seat is also the least preferred seat for other child-restraint systems.

#### **(With Front Passenger Occupant Classification System)**

To reduce the chance of injuries caused by deployment of the front passenger air bag, the front passenger seat weight sensors work as a part of the supplemental restraint system. This system deactivates the front passenger front and side air bags and also the front passenger seat belt pretensioner system when the front passenger air bag deactivation indicator light illuminates.

When an infant or small child sits on the front passenger seat, the system shuts off the front passenger front and side air bags and seat belt pretensioner system, so make sure the front passenger air bag deactivation indicator light illuminates.

Even if the front passenger air bag is shut off, Mazda strongly recommends that children be properly restrained and child-restraint systems of all kinds are properly secured on the rear seats which are the best place for children.

For more details, refer to "Front passenger seat weight sensors" (page 2-57).

Essential Safety Equipment  
**Child Restraint**

**⚠ WARNING**

**Use the correct size child-restraint system:**

*For effective protection in vehicle accidents and sudden stops, a child must be properly restrained using a seat belt or child-restraint system depending on age and size. If not, the child could be seriously injured or even killed in an accident.*

**Follow the manufacturer's instructions and always keep the child-restraint system buckled down:**

*An unsecured child-restraint system is dangerous. In a sudden stop or a collision it could move causing serious injury or death to the child or other occupants. Make sure any child-restraint system is properly secured in place according to the child-restraint system manufacturer's instructions. When not in use, remove it from the vehicle or fasten it with a seat belt, or latch it down to BOTH LATCH lower anchors for LATCH child-restraint systems and the corresponding tether anchor.*

**Always secure a child in a proper child-restraint system:**

*Holding a child in your arms while the vehicle is moving is extremely dangerous. No matter how strong the person may be, he or she cannot hold onto a child in a sudden stop or collision and it could result in serious injury or death to the child or other occupants. Even in a moderate accident, the child may be exposed to air bag forces that could result in serious injury or death to the child, or the child may be slammed into an adult, causing injury to both child and adult.*

**Never use a rear-facing child-restraint system in the front seat with an air bag that could deploy:**

*Rear-facing child-restraint systems on the front seat are particularly dangerous even though you may feel assured that a front passenger air bag will not deploy based on the fact that the front passenger air bag deactivation indicator light illuminates. The child-restraint system can be hit by a deploying air bag and moved violently backward resulting in serious injury or death to the child.*

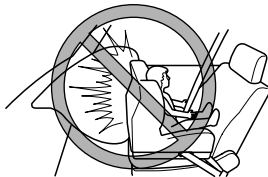

Essential Safety Equipment

## Child Restraint

---

*Vehicles with a front passenger air bag have a warning label attached as shown below. The warning label reminds you not to put a rear-facing child-restraint system on the front passenger seat at any time.*



**Do not install a front-facing child-restraint system on the front passenger seat unless it is unavoidable:**

*In a collision, the force of a deploying air bag could cause serious injury or death to the child. If installing a front-facing child-restraint system on the front passenger seat is unavoidable, move the front passenger seat as far back as possible.*



Essential Safety Equipment  
**Child Restraint**

**Seating a child in a child-restraint system on the front passenger seat is dangerous under certain conditions (With Front Passenger Occupant Classification System):**

Your vehicle is equipped with front passenger seat weight sensors. Even with the front passenger seat weight sensors, if you must use the front passenger seat to seat a child, using a child-restraint system on the front passenger seat under the following conditions increases the danger of the front passenger air bag deploying and could result in serious injury or death to the child.

- The front passenger air bag deactivation indicator light does not illuminate when seating a child in the child-restraint system.
- Luggage or other items are placed on the seat with the child in the child-restraint system.
- A rear passenger or luggage pushing or pulling down on the front passenger seatback.
- A rear passenger puts their feet on the front seat rails.
- Luggage or other items are placed on the seatback or hung on the head restraint.
- Heavy items are placed in the seatback map pocket.
- The seat is washed.
- Liquids are spilled on the seat.
- The front passenger seat is moved backward, pushing into luggage or other items placed behind it.
- The front passenger seatback contacts the rear seat.
- Luggage or other items are placed between the front passenger seat and driver seat.
- Any accessories, which might increase the total seated weight on the front passenger seat, are attached to the front passenger seat.

The designated positions with seat belts on the rear seats are the safest places for children. Always use seat belts and child restraints.

**Do not allow a child or anyone to lean over or against the side window of a vehicle with side and curtain air bags:**

It is dangerous to allow anyone to lean over or against the side window, the area of the front passenger seat, the front and rear window pillars and the roof edge along both sides from which the side and curtain air bags deploy, even if a child-restraint system is used. The impact of inflation from a side or curtain air bag could cause serious injury or death to an out of position child. Furthermore, leaning over or against the front door could block the side and curtain air bags and eliminate the advantages of supplemental protection. With the front air bag and the additional side air bag that comes out of the front seat, the rear seat is always a better location for children. Take special care not to allow a child to lean over or against the side window, even if the child is seated in a child-restraint system.

Essential Safety Equipment

## Child Restraint

---

**Never use one seat belt on more than one person at a time:**

*Using one seat belt for more than one person at a time is dangerous. A seat belt used in this way cannot spread the impact forces properly and the two passengers could be crushed together and seriously injured or even killed. Never use one belt for more than one person at a time and always operate the vehicle with each occupant properly restrained.*

**⚠ CAUTION**

*A seat belt or child-restraint system can become very hot in a closed vehicle during warm weather. To avoid burning yourself or a child, check them before you or your child touches them.*

**NOTE**

*Your Mazda is equipped with LATCH lower anchors for attachment of specially designed LATCH child-restraint systems in the rear seat. When using these anchors to secure a child-restraint system, refer to “LATCH Child-Restraint Systems” (page 2-39).*



Essential Safety Equipment  
**Child Restraint**

## Child-Restraint System Installation Position

In this owner's manual, explanation of child-restraint systems is provided for the following three types of popular child-restraint systems: infant seat, child seat, booster seat.

### NOTE

- *Installation position is determined by the type of child-restraint system. Always read the manufacturer's instructions and this owner's manual carefully.*
- *Due to variations in the design of child-restraint systems, vehicle seats and seat belts, all child-restraint systems may not fit all seating positions. Before purchasing a child-restraint system, it should be tested in the specific vehicle seating position (or positions) where it is intended to be used. If a previously purchased child-restraint system does not fit, you may need to purchase a different one that will.*

### Infant seat

An infant seat provides restraint by bracing the infant's head, neck and back against the seating surface.

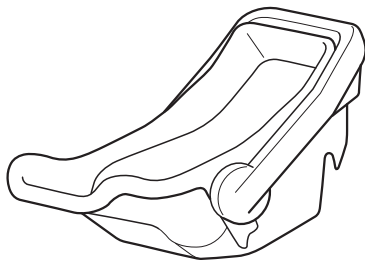

### Child seat

A child seat restrains a child's body using the harness.



### Booster seat

A booster seat is a child restraint accessory designed to improve the fit of the seat belt system around the child's body.

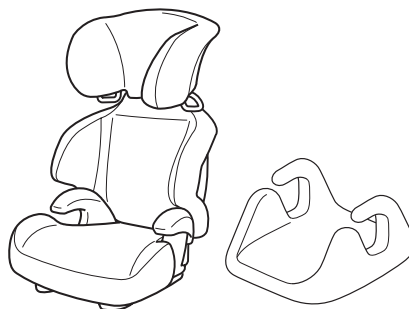

Essential Safety Equipment

## Child Restraint

### Installing Child-Restraint Systems

Accident statistics reveal that a child is safer in the rear seat. The front passenger's seat is clearly the worst choice for any child under 12, and with rear-facing child-restraint systems it is clearly unsafe due to air bags.

#### **NOTE**

*Even if your vehicle is equipped with front passenger seat weight sensors (page 2-57), which automatically deactivates the front passenger air bag, a rear seat is the safest place for a child of any age or size.*

Some child-restraint systems now come with tethers and therefore must be installed on the seats that take tethers to be effective. In your Mazda, tethered child-restraint systems can only be accommodated in the three positions on the rear seat.

Some child-restraint systems also employ specially designed LATCH attachments; refer to “LATCH Child-Restraint Systems” (page 2-39).

### **⚠ WARNING**

#### **Tethered Child-Restraint Systems Work Only on Tether-Equipped Rear Seats:**

*Installation of a tether equipped child-restraint system in the front passenger's seat defeats the safety design of the system and will result in an increased chance of serious injury if the child-restraint system goes forward without benefit of being tethered.*

*Place tether equipped child-restraint systems where there are tether anchors.*

#### **▼ Rear Seat Child-Restraint System Installation**

Follow these instructions when using a child-restraint system, unless you are attaching a LATCH-equipped child-restraint system to the rear LATCH lower anchors. Refer to “LATCH Child-Restraint Systems” (page 2-39).

#### **NOTE**

*Follow the child-restraint system manufacturer's instructions carefully. If you are not sure whether you have a LATCH system or tether, check in the child-restraint system manufacturer's instructions and follow them accordingly. Depending on the type of child-restraint system, it may use LATCH system instead of seat belts or if the belt goes across the child's chest, may recommend against using automatic locking mode.*

1. Make sure the seatback is securely latched by pushing it back until it is fully locked.

## Essential Safety Equipment Child Restraint

### 2. (4 Door)

Raise the head restraint to the top locked position (except center seat position).

Refer to Head Restraints on page 2-10.

### **NOTE**

#### **(5 Door)**

*The rear outboard head restraints are non-adjustable.*

3. Secure the child-restraint system with the lap portion of the lap/shoulder belt. See the manufacturer's instructions on the child-restraint system for belt routing instructions.

4. To get the retractor into the automatic locking mode, pull the shoulder belt portion of the seat belt until the entire length of the belt is out of the retractor.

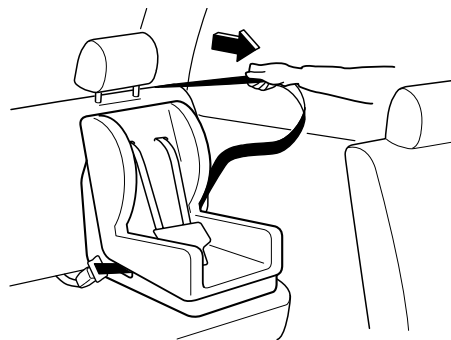

5. Push the child-restraint system firmly into the vehicle seat. Be sure the belt retracts as snugly as possible. A clicking noise from the retractor will be heard during retraction if the system is in the automatic locking mode. If the belt does not lock the seat down tight, repeat this step.

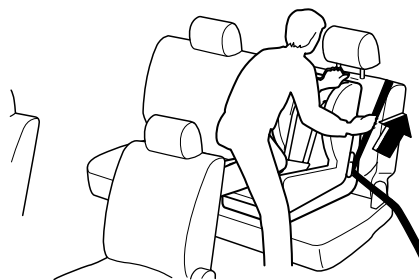

### **NOTE**

*Inspect this function before each use of the child-restraint system. You should not be able to pull the shoulder belt out of the retractor while the system is in the automatic locking mode. When you remove the child-restraint system, be sure the belt fully retracts to return the system to emergency locking mode before occupants use the seat belts.*

6. If your child-restraint system requires the use of a tether strap, refer to the manufacturer's instructions to hook and tighten the tether strap.

Essential Safety Equipment

# Child Restraint

## Anchor bracket location (4 Door)

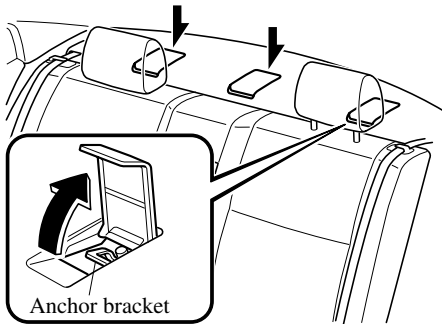

## Tether strap position (4 Door)

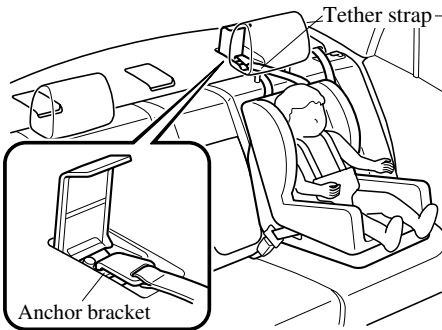

## Anchor bracket location (5 Door outboard position)

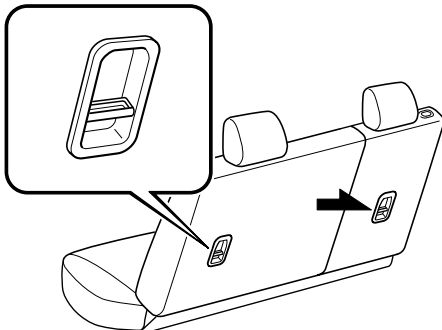

## Tether strap position (5 Door outboard position)

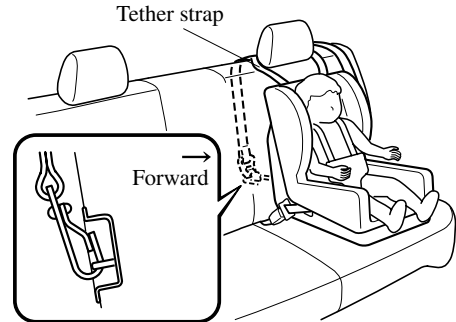

## Anchor bracket location (5 Door center position)

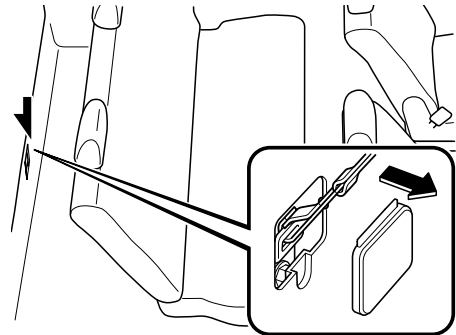

## Tether strap position (5 Door center position)

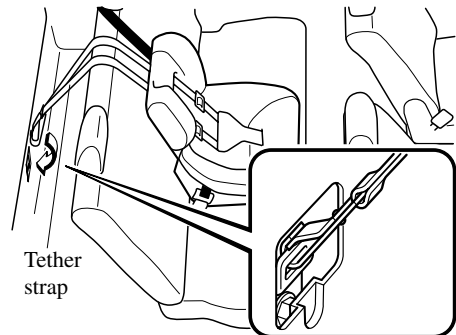

Essential Safety Equipment  
**Child Restraint**

**⚠ WARNING**

**Use the tether and tether anchor only for a child-restraint system:**

*Using the tether or tether anchor to secure anything but a child-restraint system is dangerous. This could weaken or damage the tether or tether anchor and result in injury.*

**Always route the tether strap between the head restraint and the seatback (4 Door):**

*Routing the tether strap on top of the head restraint is dangerous. In a collision the tether strap could slide off the head restraint and loosen the child-restraint system. The child-restraint system could move which may result in death or injury to the child.*

**Always attach the tether strap to the correct tether anchor position:**

*Attaching the tether strap to the incorrect tether anchor position is dangerous. In a collision, the tether strap could come off and loosen the child-restraint system. If the child-restraint system moves it could result in death or injury to the child.*

**▼ If You Must Use the Front Seat for Children**

If you cannot put all children in the rear seat, at least put the smallest children in the rear and be sure the largest child up front uses the shoulder belt over the shoulder.

NEVER put a rear-facing child-restraint system on the front passenger seat whether your vehicle is equipped with a seat weight sensor or not.

This seat is also not set up for tethered child-restraint systems, put them in one of the rear seat positions set up with tether anchors.

Likewise the LATCH child-restraint system cannot be secured in the front passenger's seat and should be used in the rear seat.

Do not allow anyone to sleep against the side window if you have optional side and curtain air bags, it could cause serious injuries to an out of position occupant. As children more often sleep in cars, it is better to put them in the rear seat. If installing the child-restraint system on the front seat is unavoidable, follow these instructions when using a front-facing child-restraint system in the front passenger's seat.

**NOTE**

- *To check if your front seats have side air bags:*

*Mazda vehicles equipped with side air bag will have a "SRS AIRBAG" tag on the outboard shoulder of the front seats.*

- *To check if your vehicle has curtain air bags:*

*Mazda vehicles equipped with curtain air bag will have an "SRS AIRBAG" marking on the window pillars along the roof edge.*

Essential Safety Equipment

## Child Restraint

### **⚠ WARNING**

**Always move the front passenger seat as far back as possible if installing a front-facing child-restraint system on it is unavoidable:**

As your vehicle has front air bags and doubly so if your vehicle has side air bags, a front-facing child-restraint system should be put on the front passenger seat only when it is unavoidable.

Even if the front passenger air bag deactivation indicator light illuminates, always move the seat as far back as possible, because the force of a deploying air bag could cause serious injury or death to the child.

**Never use a rear-facing child-restraint system in the front seat with an air bag that could deploy:**

Rear-facing child-restraint systems on the front seat are particularly dangerous.

Even in a moderate collision, the child-restraint system can be hit by a deploying air bag and moved violently backward resulting in serious injury or death to the child. Even though you may feel assured that the front passenger air bag will not deploy based on the fact that the front passenger air bag deactivation indicator light illuminates, you should not use a rear-facing child-restraint system in the front seat.

**Do not allow a child or anyone to lean over or against the side window of a vehicle with side and curtain air bags:**

It is dangerous to allow anyone to lean over or against the side window, the area of the front passenger seat, the front and rear window pillars and the roof edge along both sides from which the side and curtain air bags deploy, even if a child-restraint system is used. The impact of inflation from a side or curtain air bag could cause serious injury or death to an out of position child.

Furthermore, leaning over or against the front door could block the side and curtain air bags and eliminate the advantages of supplemental protection. With the front air bag and the additional side air bag that comes out of the front seat, the rear seat is always a better location for children. Take special care not to allow a child to lean over or against the side window, even if the child is seated in a child-restraint system.

### **▼ Front Passenger's Seat Child-Restraint System Installation**

1. Switch the ignition ON.
2. Slide the seat as far back as possible.

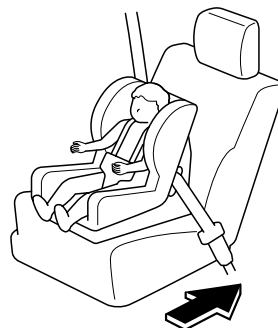

Essential Safety Equipment  
**Child Restraint**

- Place the child-restraint system on the seat without putting your weight on the seat and fasten the seat belt. See the manufacturer's instructions on the child-restraint system for belt routing instructions.
- To get the retractor into the automatic locking mode, pull the shoulder belt portion of the seat belt until the entire length of the belt is out of the retractor.
- Push the child-restraint system firmly into the vehicle seat. Be sure the belt retracts as snugly as possible. A clicking noise from the retractor will be heard during retraction if the system is in automatic locking mode. If the belt does not lock the seat down tight, repeat the previous step and also this one.

**NOTE**

- Inspect this function before each use of the child-restraint system. You should not be able to pull the shoulder belt out of the retractor while the system is in the automatic locking mode. When you remove the child-restraint system, be sure the belt fully retracts to return the system to emergency locking mode before occupants use the seat belts.*
  - Follow the child-restraint system manufacturer's instructions carefully. Depending on the type of child-restraint system, it may not employ seat belts which are in automatic locking mode.*
- Seat your child safely in the child-restraint system and secure the child according to the instructions from the child-restraint system manufacturer.

**7. (With Front Passenger Occupant Classification System)**

Make sure the front passenger air bag deactivation indicator light illuminates after installing a child-restraint system on the front passenger seat.

If the front passenger air bag deactivation indicator light does not illuminate, remove the child-restraint system, switch the ignition to OFF or ACC, and then re-install the child-restraint system.

Refer to Front Passenger Seat Weight Sensors on page 2-57.



Essential Safety Equipment

## Child Restraint

---

### **WARNING**

***Do not seat a child in a child-restraint system on the front passenger seat if the front passenger air bag deactivation indicator light does not illuminate (With Front Passenger Occupant Classification System):***

*While it is always better to install any child-restraint system on the rear seat, it is imperative that a child-restraint system **ONLY** be used on the front passenger seat if the deactivation indicator light illuminates when the child is seated in the child-restraint system (page 2-57). Seating a child in a child-restraint system installed on the front passenger seat with the front passenger air bag deactivation indicator light not illuminated is dangerous. If this indicator light does not illuminate, this means that the front passenger front and side air bags, and seat belt pretensioner are ready for deployment. If an accident were to deploy an air bag, a child in a child-restraint system sitting in the front passenger seat could be seriously injured or killed. If the indicator light does not illuminate after seating a child in a child-restraint system on the front passenger seat, seat a child in a child-restraint system on the rear seat and consult an Authorized Mazda Dealer as soon as possible.*



Essential Safety Equipment  
**Child Restraint**

## LATCH Child-Restraint Systems

Your Mazda is equipped with LATCH lower anchors for attachment of specially designed LATCH child-restraint systems in the rear seat. Both anchors must be used, otherwise the seat will bounce around and put the child in danger. Most LATCH child-restraint systems must also be used in conjunction with a tether to be effective. If they have a tether you must use it to better assure your child's safety.

### **WARNING**

**Follow the manufacturer's instructions for the use of the child-restraint system:**

*An unsecured child-restraint system is dangerous. In a sudden stop or a collision it could move causing serious injury or death to the child or other occupants. Make sure the child-restraint system is properly secured in place according to the child-restraint system manufacturer's instructions.*

**Never attach two child-restraint systems to the same LATCH lower anchor:**

*Attaching two child-restraint systems to the same LATCH lower anchor is dangerous. In a collision, one anchor may not be strong enough to hold two child-restraint system attachments, and it may break, causing serious injury or death. If you use the seat position for another child-restraint system when an outboard LATCH position is occupied, use the center seat belts instead, and the tether if tether-equipped.*

**Make sure the child-restraint system is properly secured:**

*An unsecured child-restraint system is dangerous. In a sudden stop or a collision it could move causing serious injury or death to the child or other occupants. Follow the child-restraint system manufacturer's instructions on belt routing to secure the seat just as you would with a child in it so that nobody is tempted to put a child in an improperly secured seat later on. When not in use, remove it from the vehicle or fasten it with a seat belt, or latch it down to BOTH LATCH lower anchors for LATCH child-restraint systems.*

**Make sure there are no seat belts or foreign objects near or around the LATCH child-restraint system:**

*Not following the child-restraint system manufacturer's instructions when installing the child-restraint system is dangerous. If seat belts or a foreign object prevent the child-restraint system from being securely attached to the LATCH lower anchors and the child-restraint system is installed improperly, the child-restraint system could move in a sudden stop or collision causing serious injury or death to the child or other occupants. When installing the child-restraint system, make sure there are no seat belts or foreign objects near or around the LATCH lower anchors. Always follow the child-restraint system manufacturer's instructions.*

Essential Safety Equipment

## Child Restraint

### ▼ LATCH Child-Restraint System Installation Procedure (Rear Outboard Seats)

1. First, adjust the front seat to allow clearance between the child-restraint system and the front seat (page 2-2).
2. Make sure the seatback is securely latched by pushing it back until it is fully locked.
3. Expand the area between the seat bottom and the seatback slightly to verify the locations of the LATCH lower anchors.

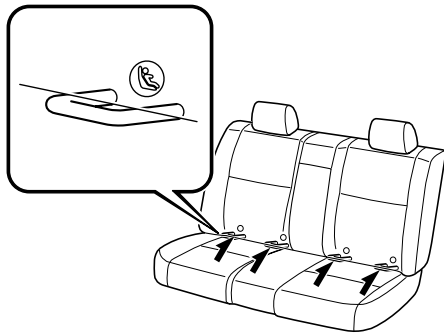

**NOTE**

The markings above the LATCH lower anchors indicate the locations of LATCH lower anchors for the attachment of a child-restraint system.

**4. (4 Door)**

- Raise the head restraint to the top locked position.
- Refer to Head Restraints on page 2-10.

**NOTE**

**(5 Door)**

The rear outboard head restraints are non-adjustable.

5. Secure the child-restraint system using BOTH LATCH lower anchors, following the child-restraint system manufacturer's instruction. Pull on the child-restraint to be sure both anchors are engaged.
6. If your child-restraint system came equipped with a tether, that means it is very important to properly secure the tether for child safety. Please carefully follow the child-restraint system manufacturer's instructions when installing tethers.

### Anchor bracket location (4 Door)

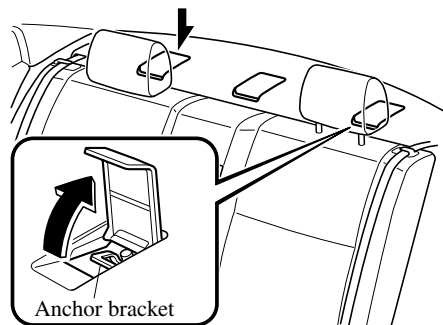

### Tether strap position (4 Door)

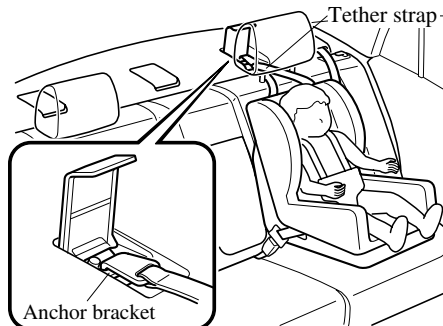

Essential Safety Equipment  
**Child Restraint**

**Anchor bracket location (5 Door)**

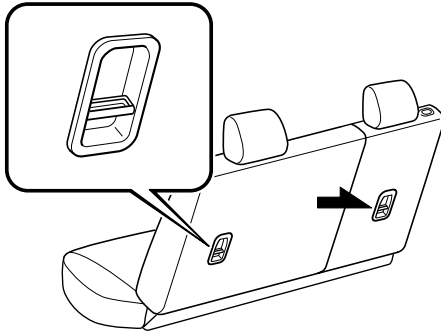

**Tether strap position (5 Door)**

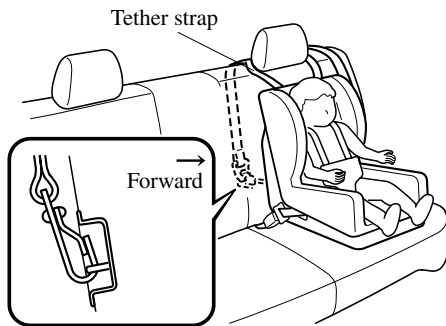

**⚠ WARNING**

**Use the tether and tether anchor only for a child-restraint system:**

Using the tether or tether anchor to secure anything but a child-restraint system is dangerous. This could weaken or damage the tether or tether anchor and result in injury.

**Always route the tether strap between the head restraint and the seatback:**

Routing the tether strap on top of the head restraint is dangerous. In a collision the tether strap could slide off the head restraint and loosen the child-restraint system. The child-restraint system could move which may result in death or injury to the child.

**Always attach the tether strap to the correct tether anchor position:**

Attaching the tether strap to the incorrect tether anchor position is dangerous. In a collision, the tether strap could come off and loosen the child-restraint system. If the child-restraint system moves it could result in death or injury to the child.

Essential Safety Equipment

## Child Restraint

### ▼ LATCH Child-Restraint System Installation Procedure (Rear Center Seat)

The LATCH lower anchors at the center of the rear seat are much further apart than the sets of LATCH lower anchors for child-restraint system installation at other seating positions. Child-restraint systems with rigid LATCH attachments cannot be installed on the center seating position. Some LATCH equipped child-restraint systems can be placed in the center position and will reach the nearest LATCH lower anchors which are 400 mm (15.75 in) apart. LATCH compatible child-restraint systems (with attachments on belt webbing) can be used at this seating position only if the child-restraint system manufacturer's instructions state that the child-restraint system can be installed to LATCH lower anchors that are 400 mm (15.75 in) apart. Do not attach two child-restraint systems to the same LATCH lower anchor. If your child-restraint system has a tether, it must also be used for your child's optimum safety.

### **⚠ WARNING**

**Use the tether and tether anchor only for a child-restraint system:**

*Using the tether or tether anchor to secure anything but a child-restraint system is dangerous. This could weaken or damage the tether or tether anchor and result in injury.*

**Always attach the tether strap to the correct tether anchor position:**

*Attaching the tether strap to the incorrect tether anchor position is dangerous. In a collision, the tether strap could come off and loosen the child-restraint system. If the child-restraint system moves it could result in death or injury to the child.*

1. Make sure the seatback is securely latched by pushing it back until it is fully locked.
2. Expand the area between the seat bottom and the seatback slightly to verify the locations of the LATCH lower anchors.

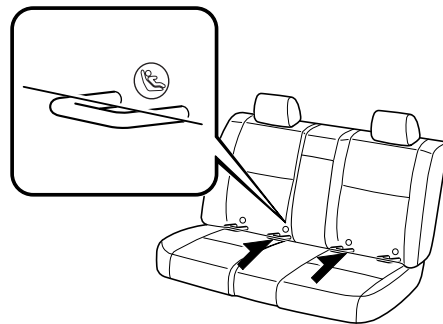

### **NOTE**

*The markings above the LATCH lower anchors indicate the locations of LATCH lower anchors for the attachment of a child-restraint system.*

Essential Safety Equipment  
**Child Restraint**

3. Secure the child-restraint system using BOTH LATCH lower anchors, following the child-restraint system manufacturer's instructions. Pull on the child-restraint to be sure both anchors are engaged.
4. If your child-restraint system came equipped with a tether, that means it is very important to properly secure the tether for child safety. Please carefully follow the child-restraint system manufacturer's instructions when installing tethers.

**Anchor bracket location (4 Door)**

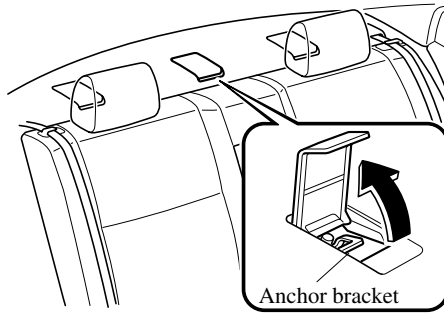

**Tether strap position (4 Door)**

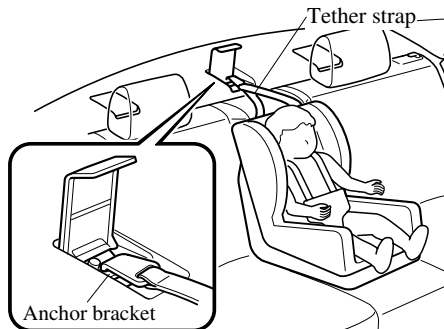

**Anchor bracket position (5 Door)**

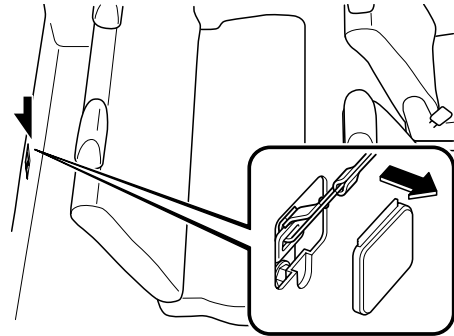

**Tether strap position (5 Door)**

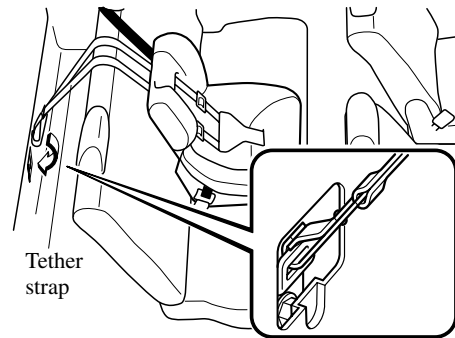

Essential Safety Equipment

## SRS Air Bags

### Supplemental Restraint System (SRS) Precautions

The front and side supplemental restraint systems (SRS) include up to 6 air bags. **Please verify the air bags equipped on your vehicle by locating the “SRS AIRBAG” location indicators.** These indicators are visible in the area where the air bags are installed.

The air bags are installed in the following locations:

- The steering wheel hub (driver air bag)
- The front passenger dashboard (front passenger air bag)
- The outboard sides of the front seatbacks (side air bags) \*
- The front and rear window pillars, and the roof edge along both sides (curtain air bags) \*

The air bag supplemental restraint systems are designed to provide supplemental protection in certain situations, so seat belts are always important in the following ways:

Without seat belt usage, the air bags cannot provide adequate protection during an accident. Seat belt usage is necessary to:

- Keep the occupant from being thrown into an inflating air bag.
- Reduce the possibility of injuries during an accident that is not designed for air bag inflation, such as roll-over or rear impact.
- Reduce the possibility of injuries in frontal, near frontal, side collisions that are not severe enough to activate the air bags.
- Reduce the possibility of being thrown from your vehicle.
- Reduce the possibility of injuries to lower body and legs during an accident because the air bags provide no protection to these parts of the body.
- Hold the driver in a position which allows better control of the vehicle.

**If your vehicle is also equipped with a front passenger occupant classification system, refer to the Front Passenger Occupant Classification System (page 2-57) for details.**

If your vehicle is equipped with a front passenger occupant classification system, the front passenger air bag deactivation indicator light illuminates for a specified time after the ignition is switched ON.



Essential Safety Equipment  
**SRS Air Bags**

Small children must be protected by a child-restraint system as stipulated by law in every state and province. In certain states and provinces, larger children must use a child-restraint system (page 2-26).

Carefully consider which child-restraint system is necessary for your child and follow the installation directions in this Owner's Manual as well as the child-restraint system manufacturer's instructions.

**! WARNING**

***Seat belts must be worn in air bag equipped vehicles:***

*Depending only on the air bags for protection during an accident is dangerous. Alone, air bags may not prevent serious injuries. The appropriate air bags can be expected to inflate only in the first accident, such as frontal, near frontal, side collisions that are at least moderate. Vehicle occupants should always wear seat belts.*

***Children should not ride in the front passenger seat:***

*Placing a child, 12 years or under, in the front seat is dangerous. The child could be hit by a deploying air bag and be seriously injured or even killed. Even if the front passenger air bag deactivation indicator light illuminates, always move the front passenger seat as far back as possible. A sleeping child is more likely to lean against the door and be hit by the side air bag in a moderate collision to the front-passenger side of the vehicle. Whenever possible, always secure a child 12 years and under on the rear seat with an appropriate child-restraint system for the child's age and size.*

***Never use a rear-facing child-restraint system in the front seat with an air bag that could deploy:***

*Rear-facing child-restraint systems on the front seat are particularly dangerous even though you may feel assured that a front passenger air bag will not deploy based on the fact that the front passenger air bag deactivation indicator light illuminates. The child-restraint system can be hit by a deploying air bag and moved violently backward resulting in serious injury or death to the child.*

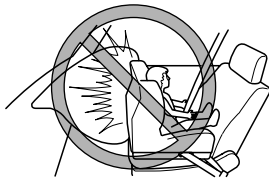

Essential Safety Equipment

## SRS Air Bags

---

**Do not sit too close to the driver and front passenger air bags:**

*Sitting too close to the driver and front passenger air bag modules or placing hands or feet on them is extremely dangerous. The driver and front passenger air bags inflate with great force and speed. Serious injuries could occur if someone is too close. The driver should always hold onto only the rim of the steering wheel. The front seat passenger should keep both feet on the floor. Front seat occupants should adjust their seats as far back as possible and always sit upright against the seatbacks with seat belts worn properly.*

**Sit in the center of the seat and wear seat belts properly:**

*Sitting too close to the side air bag modules or placing hands on them, or sleeping up against the door or hanging out the windows is extremely dangerous. The side and curtain air bags inflate with great force and speed directly expanding along the door on the side the car is hit. Serious injury could occur if someone is sitting too close to the door or leaning against a window, or if rear seat occupants grab the sides of the front seatbacks. Give the side and curtain air bags room to work by sitting in the center of the seat while the vehicle is moving with seat belts worn properly.*

**Do not attach objects on or around the area where driver and front passenger air bags deploy:**

*Attaching an object to the driver and front passenger air bag modules or placing something in front of them is dangerous. In an accident, an object could interfere with air bag inflation and injure the occupants.*

**Do not attach objects on or around the area where a side air bag deploys:**

*Attaching objects to the front seat in such a way as to cover the outboard side of the seat in any way is dangerous. In an accident the object could interfere with the side air bag, which inflates from the outboard side of the front seats, impeding the added protection of the side air bag system or redirecting the air bag in a way that is dangerous. Furthermore, the bag could be cut open releasing the gas.*

*Do not hang net bags, map pouches or backpacks with side straps on the front seats. Never use seat covers on the front seats. Always keep the side air bag modules in your front seats free to deploy in the event of a side collision.*

**Do not attach objects on or around the area where a curtain air bag deploys:**

*Attaching objects to the areas where the curtain air bag activates such as on the windshield glass, side door glass, front and rear window pillars and along the roof edge and assist grips is dangerous. In an accident the object could interfere with the curtain air bag, which inflates from the front and rear window pillars and along the roof edge, impeding the added protection of the curtain air bag system or redirecting the air bag in a way that is dangerous. Furthermore, the bag could be cut open releasing the gas.*

*Do not place hangers or any other objects on the assist grips. When hanging clothes, hang them on the coat hook directly. Always keep the curtain air bag modules free to deploy in the event of a side collision.*



Essential Safety Equipment  
**SRS Air Bags**

---

**Do not place luggage or other objects under the front seats:**

*Placing luggage or other objects under the front seats is dangerous. The components essential to the supplemental restraint system could be damaged, and in the event of a side collision, the appropriate air bags may not deploy, which could result in death or serious injury. To prevent damage to the components essential to the supplemental restraint system, do not place luggage or other objects under the front seats.*

**Do not touch the components of the supplemental restraint system after the air bags have inflated:**

*Touching the components of the supplemental restraint system after the air bags have inflated is dangerous. Immediately after inflation, they are very hot. You could get burned.*

**Never install any front-end equipment to your vehicle:**

*Installation of front-end equipment, such as frontal protection bar (kangaroo bar, bull bar, push bar, or other similar devices), snowplow, or winches, is dangerous. The air bag crash sensor system could be affected. This could cause air bags to inflate unexpectedly, or it could prevent the air bags from inflating during an accident. Front occupants could be seriously injured.*

**Do not modify the suspension:**

*Modifying the vehicle suspension is dangerous. If the vehicle's height or the suspension is modified, the vehicle will be unable to accurately detect a collision resulting in incorrect or unexpected air bag deployment and the possibility of serious injuries.*

**Do not modify a front door or leave any damage unrepaired. Always have an Authorized Mazda Dealer inspect a damaged front door:**

*Modifying a front door or leaving any damage unrepaired is dangerous. Each front door has a side crash sensor as a component of the supplemental restraint system. If holes are drilled in a front door, a door speaker is left removed, or a damaged door is left unrepaired, the sensor could be adversely affected causing it to not detect the pressure of an impact correctly during a side collision. If a sensor does not detect a side impact correctly, the side and curtain air bags and the front seat belt pretensioner may not operate normally which could result in serious injury to occupants.*

Essential Safety Equipment

## SRS Air Bags

---

**Do not modify the supplemental restraint system:**

*Modifying the components or wiring of the supplemental restraint system is dangerous. You could accidentally activate it or make it inoperable. Do not make any modifications to the supplemental restraint system. This includes installing trim, badges, or anything else over the air bag modules. It also includes installing extra electrical equipment on or near system components or wiring. An Authorized Mazda Dealer can provide the special care needed in the removal and installation of front seats. It is important to protect the air bag wiring and connections to assure that the bags do not accidentally deploy, the front passenger seat weight sensors are not damaged and that the seats retain an undamaged air bag connection.*

**NOTE**

- *When an air bag deploys, a loud inflation noise can be heard and some smoke will be released. Neither is likely to cause injury, however, the texture of the air bags may cause light skin injuries on body parts not covered with clothing through friction.*
- *Should you sell your Mazda, we urge you to tell the new owner of its air bag systems and that familiarization with all instructions about them, from the Owner's Manual, is important.*
- *This highly-visible label is displayed which warns against the use of rear-facing child-restraint systems on the front passenger seat.*



Essential Safety Equipment  
**SRS Air Bags**

**Supplemental Restraint System Components**

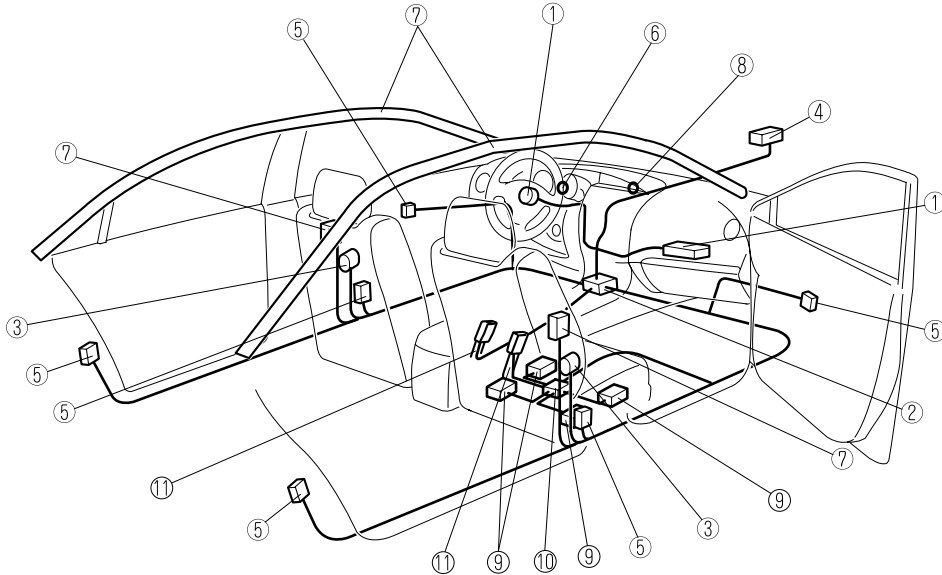

- ① Driver/Front passenger inflators and air bags
- ② Crash sensor, and diagnostic module (SAS unit)
- ③ Front seat belt pretensioner and load limiting systems (page 2-20)
- ④ Front air bag sensor
- ⑤ Side crash sensors \*
- ⑥ Air bag/front seat belt pretensioner system warning light (page 2-53)
- ⑦ Side and curtain inflators and air bags \*
- ⑧ Front passenger air bag deactivation indicator light (page 2-57)
- ⑨ Front passenger seat weight sensors (page 2-57)
- ⑩ Front passenger seat weight sensor control module
- ⑪ Driver and front passenger seat belt buckle switches (page 2-61)

**NOTE**

⑧ - ⑪ are equipped only on models with the front passenger occupant classification system.

Essential Safety Equipment

## SRS Air Bags

### How the SRS Air Bags Work

Your Mazda is equipped with the following types of SRS air bags. SRS air bags are designed to work together with the seat belts to help to reduce injuries during an accident. The SRS air bags are designed to provide further protection for passengers in addition to the seat belt functions. Be sure to wear seat belts properly.

#### ▼ Front Seat Belt Pretensioners

The front seat belt pretensioners are designed to deploy in moderate or severe frontal, near frontal collisions.

##### **(With Front Passenger Occupant Classification System)**

In addition, during a side collision, the pretensioner operates on the side in which the collision occurs.

#### ▼ Driver Air Bag

The driver's air bag is mounted in the steering wheel.

When air bag crash sensors detect a frontal impact of greater than moderate force, the driver's air bag inflates quickly helping to reduce injury mainly to the driver's head or chest caused by directly hitting the steering wheel.

For more details about air bag deployment, refer to "SRS Air Bag Deployment Criteria" (page 2-54).

##### **(With Front Passenger Occupant Classification System)**

The driver's dual-stage air bag controls air bag inflation in two energy stages. During an impact of moderate severity the driver's air bag deploys with lesser energy, whereas during more severe impacts, it deploys with more energy.



Essential Safety Equipment  
**SRS Air Bags**

---

▼ **Front Passenger Air Bag**

The front passenger air bag is mounted in the front passenger dashboard. The inflation mechanism for the front passenger air bag is the same as the driver's air bag, as mentioned above.

For more details about air bag deployment, refer to “SRS Air Bag Deployment Criteria” (page 2-54).

**(With Front Passenger Occupant Classification System)**

In addition, the front passenger air bag is designed to only deploy in accordance with the total seated weight on the front passenger seat. For details, refer to the front passenger occupant classification system (page 2-57).

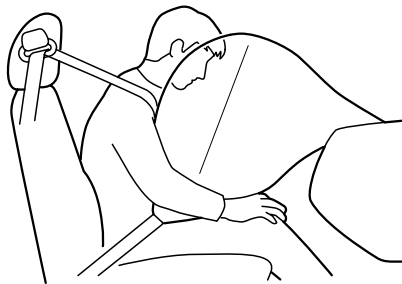

▼ **Side Air Bags \***

The side air bags are mounted in the outboard sides of the front seatbacks.

When the air bag crash sensors detect a side impact of greater than moderate force, the system inflates the side air bag only on the side in which the vehicle was hit. The side air bag inflates quickly to reduce injury to the driver or front passenger's chest caused by directly hitting interior parts such as a door or window.

For more details about air bag deployment, refer to “SRS Air Bag Deployment Criteria” (page 2-54).

\*Some models. **2-51**

## Essential Safety Equipment SRS Air Bags

---

### (With Front Passenger Occupant Classification System)

In addition, the front passenger side air bag is designed to only deploy in accordance with the total seated weight on the front passenger seat. For details, refer to the front passenger occupant classification system (page 2-57).

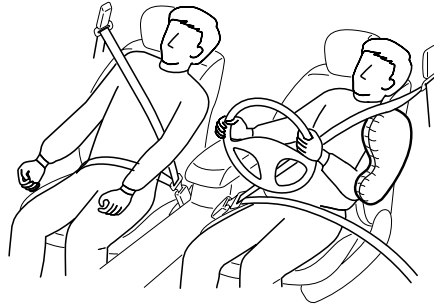

### ▼ Curtain Air Bags\*

The curtain air bags are mounted in the front and rear window pillars, and the roof edge along both sides.

When the air bag crash sensors detect a side impact of greater than moderate force, the curtain air bag inflates quickly and helps to reduce injury mainly to the rear outboard passenger's head caused by directly hitting interior parts such as a door or window. For more details about air bag deployment, refer to "SRS Air Bag Deployment Criteria" (page 2-54).

#### **In a side impact:**

Greater than moderate impact to one side of the vehicle will cause the curtain air bag on that side only to inflate.

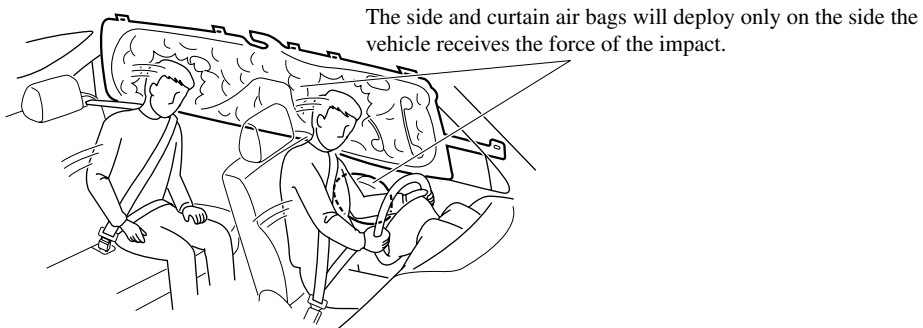

The side and curtain air bags will deploy only on the side the vehicle receives the force of the impact.

Essential Safety Equipment  
**SRS Air Bags**

▼ **Air Bag/Front Seat Belt Pretensioner System Warning Light**



If the air bag/front seat belt pretensioner system is working properly, the warning light illuminates when the ignition is switched ON or after the engine is cranked. The warning light turns off after a specified period of time.

A system malfunction is indicated if the warning light constantly flashes, constantly illuminates or does not illuminate at all when the ignition is switched ON. If any of these occur, consult an Authorized Mazda Dealer as soon as possible. The system may not operate in an accident.

**⚠ WARNING**

***Never tamper with the air bag/pretensioner systems and always have an Authorized Mazda Dealer perform all servicing and repairs:***

*Self-servicing or tampering with the systems is dangerous. An air bag/pretensioner could accidentally activate or become disabled causing serious injury or death.*

▼ **Air Bag/Front Seat Belt Pretensioner System Warning Beep**

If a malfunction is detected in the air bag/front seat belt pretensioner systems and the warning light, a warning beep sound will be heard for about 5 seconds every minute.

The air bag and seat belt pretensioner system warning beep sound will continue to be heard for approximately 35 minutes.

Have your vehicle inspected at an Authorized Mazda Dealer as soon as possible.

**⚠ WARNING**

***Do not drive the vehicle with the air bag/front seat belt pretensioner system warning beep sounding:***

*Driving the vehicle with the air bag/front seat belt pretensioner system warning beep sounding is dangerous. In a collision, the air bags and the front seat belt pretensioner system will not deploy and this could result in death or serious injury. Contact an Authorized Mazda Dealer to have the vehicle inspected as soon as possible.*



Essential Safety Equipment

**SRS Air Bags**

**SRS Air Bag Deployment Criteria**

This chart indicates the applicable SRS equipment that will deploy depending on the type of collision.

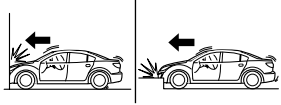
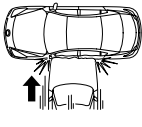
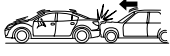
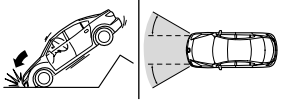
(The illustrations are the representative cases of collisions.)

|                              | Types of collision  |   |  |
|------------------------------|---|---|--|
|                              | A severe frontal/near frontal collision   | A severe side collision   | A rear collision   |
| SRS equipment                |  |  |  |
|                              |  |   |  |
|                              |  |   |  |
| Front seat belt pretensioner | X* <sup>1</sup> (both sides)  | X* <sup>1</sup> (impact side only)  | No air bag and front seat belt pretensioner will be activated in a rear collision. |
| Driver air bag               | X   |   |  |
| Front passenger air bag      | X* <sup>1</sup>   |   |  |
| Side air bag *               |   | X* <sup>1</sup> (impact side only)  |  |
| Curtain air bag *            |   | X (impact side only)  |  |

X: The SRS air bag equipment is designed to deploy in a collision.

\*1: **(With Front Passenger Occupant Classification System)**

The front passenger front and side air bags and the seat belt pretensioner are designed to deploy depending on the condition of the total seated weight on the front passenger seat.



Essential Safety Equipment  
**SRS Air Bags**

### Limitations to SRS Air Bag

In severe collisions such as those described previously in “SRS Air Bag Deployment Criteria”, the applicable SRS air bag equipment will deploy. However, in some accidents, the equipment may not deploy depending on the type of collision and its severity.

**Limitations to front/near front collision detection:**

The following illustrations are examples of front/near front collisions that may not be detected as severe enough to deploy the SRS air bag equipment.

Impacts involving trees or poles

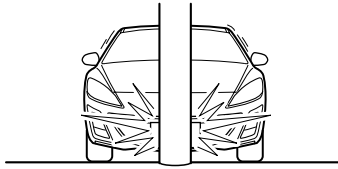

Frontal offset impact to the vehicle

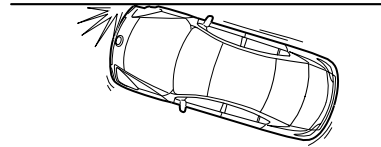

Rear-ending or running under a truck's tail gate

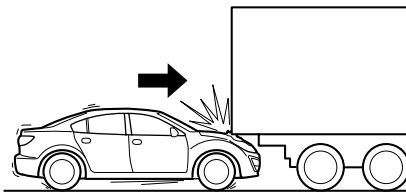

**Limitations to side collision detection:**

The following illustrations are examples of side collisions that may not be detected as severe enough to deploy the SRS air bag equipment.

Side impacts involving trees or poles

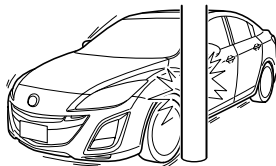

Side impacts with two-wheeled vehicles



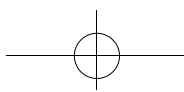

Essential Safety Equipment  
**SRS Air Bags**

---

Roll-over

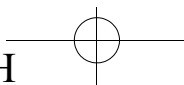
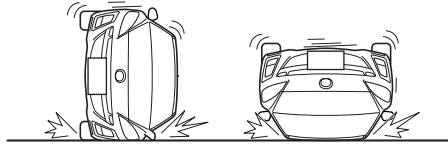

Essential Safety Equipment  
**SRS Air Bags**

## Front Passenger Occupant Classification System \*

First, please read “Supplemental Restraint System (SRS) Precautions” (page 2-44) carefully.

### ▼ Front Passenger Seat Weight Sensors

Your vehicle is equipped with a front passenger seat weight sensors as a part of the supplemental restraint system. These sensors are located under both of the front passenger seat rails. These sensors determine the total seated weight on the front passenger seat and monitor the seat belt buckle for the front passenger seat. The SAS unit is designed to prevent the front passenger front and side air bags and seat belt pretensioner system from deploying if the front passenger air bag deactivation indicator light illuminates.

To reduce the chance of injuries caused by deployment of the front passenger air bag, the system deactivates the front passenger front and side air bags and also the seat belt pretensioner system when the front passenger air bag deactivation indicator light illuminates. Refer to the following table for the front passenger air bag deactivation indicator light illumination conditions.

This system shuts off the front passenger front and side air bags and seat belt pretensioner system, so make sure the front passenger air bag deactivation indicator light illuminates according to the following table.

The air bag/front seat belt pretensioner system warning light flashes and the front passenger air bag deactivation indicator light illuminates if the sensors have a possible malfunction. If this happens, the front passenger front and side air bags and seat belt pretensioner system will not deploy.

### Front passenger air bag deactivation indicator light

This indicator light illuminates to remind you that the front passenger front and side air bags and seat belt pretensioner will not deploy during a collision.



\*Some models. **2-57**

Essential Safety Equipment

## SRS Air Bags

If the front passenger weight sensors are normal, the indicator light illuminates when the ignition is switched ON. The light turns off after a few seconds.

The front passenger air bag deactivation indicator light illuminates or is off under the following conditions:

| Condition detected by the front passenger occupant classification system | Front passenger air bag deactivation indicator light | Front passenger front and side air bags | Front passenger seat belt pretensioner system |
|--|--|---|---|
| Empty (Not occupied)* <sup>1</sup>                                       | Off  | Deactivated                             | Deactivated                                   |
| Child or child-restraint system* <sup>2</sup>                            | On   | Deactivated                             | Deactivated                                   |
| Adult* <sup>3</sup>  | Off  | Ready                                   | Ready   |

\*1 : If the front passenger seat belt is buckled, the front passenger air bag deactivation indicator light illuminates, however this does not indicate a malfunction.

\*2 : If a larger child sits on the front passenger seat, the sensors might detect the child as being an adult depending on the child's physique.

\*3 : If a smaller adult sits on the front passenger seat, the sensors might detect the person as being a child depending on the person's physique.

The curtain air bag is ready for inflating regardless of the chart above.

If the front passenger air bag deactivation indicator light does not illuminate when the ignition is switched ON and does not illuminate as indicated in the above chart, do not allow a child to sit in the front passenger seat and consult an Authorized Mazda Dealer as soon as possible. The system may not work properly in an accident.

Essential Safety Equipment  
**SRS Air Bags**

**⚠ WARNING**

**Do not decrease the total seated weight on the front passenger seat:**

*When an adult or large child sits on the front passenger seat, decreasing the total seated weight on the front passenger seat required for air bag deployment is dangerous. The front passenger seat weight sensors will detect the reduced total seated weight condition and the front passenger front and side air bags and seat belt pretensioner system will not deploy during an accident. The front passenger will not have the supplementary protection of the air bag, which could result in serious injury. Decreasing the total seated weight on the front passenger seat could result in an air bag not deploying under the following conditions, for example:*

- *A rear passenger pushes up on the front passenger seat with their feet.*
- *Luggage or other items placed under the front passenger seat or between the front passenger seat and driver seat that push up the front passenger seat bottom.*
- *The front passenger seat occupant sits in a manner that does not place the entire weight of the occupant on the seat such as by sitting too close to the door, grasping the assist grip or the rim of the moonroof and sitting with the seatback reclined too far.*
- *Any accessories which might decrease the total seated weight on the front passenger seat are attached to the front passenger seat.*

*The front passenger front and side air bags and seat belt pretensioner systems will deactivate if the front passenger air bag deactivation indicator light illuminates.*

Essential Safety Equipment

## SRS Air Bags

### **Do not increase the total seated weight on the front passenger seat:**

*When an infant or small child sits on the front passenger seat, increasing the total seated weight on the front passenger seat is dangerous. The front passenger seat weight sensors will detect the increased total seated weight, which could result in the unexpected deployment of the front passenger front and side air bags and seat belt pretensioner system in an accident and may cause serious injury. Increasing the total seated weight on the front passenger seat could result in the front passenger front and side air bags and seat belt pretensioner system deployment in an accident under the following conditions, for example:*

- *Luggage or other items are placed on the seat with the child in the child-restraint system.*
- *A rear passenger or luggage push or pull down on the front passenger seatback.*
- *A rear passenger steps on the front passenger seat rails with their feet.*
- *Luggage or other items are placed on the seatback or hung on the head restraint.*
- *Heavy items are placed in the seatback map pocket.*
- *The seat is washed.*
- *Liquids are spilled on the seat.*
- *The front passenger seat is moved backward, pushing into luggage or other items placed behind it.*
- *The front passenger seatback contacts the rear seat.*
- *Luggage or other items are placed between the front passenger seat and driver seat.*
- *Any accessories which might increase the total seated weight on the front passenger seat are attached to the front passenger seat.*

*The front passenger front and side air bags and seat belt pretensioner systems will deactivate if the front passenger air bag deactivation indicator light illuminates.*

### **⚠ CAUTION**

- *To assure proper deployment of the front air bag and to prevent damage to the sensors in the front seat bottoms:*
  - *Do not place sharp objects on the front seat bottoms or leave heavy luggage on them.*
  - *Do not spill any liquids on the front seats or under the front seats.*
- *To allow the sensors to function properly, always perform the following:*
  - *Adjust the front seats as far back as possible and always sit upright against the seatbacks with seat belts worn properly.*
  - *If you place your child on the front passenger seat, secure the child-restraint system properly and slide the front passenger seat as far back as possible (page 2-36).*

Essential Safety Equipment  
**SRS Air Bags**

---

**NOTE**

- *The system requires about 10 seconds to alternate between turning the front passenger front and side air bags and seat belt pretensioner system on or off.*
- *The front passenger air bag deactivation indicator light may illuminate repeatedly if luggage or other items are put on the front passenger seat, or if the temperature of the vehicle's interior changes suddenly.*
- *The front passenger air bag deactivation indicator light may illuminate for 10 seconds if the total seated weight on the front passenger seat changes.*
- *The air bag/front seat belt pretensioner system warning light might illuminate if the front passenger seat receives a severe impact.*
- *If the front passenger air bag deactivation indicator light does not illuminate after installing a child-restraint system on the front passenger seat, first, re-install your child-restraint system according to the procedure in this owner's manual. Then, if the front passenger air bag deactivation indicator light still does not illuminate, install the child-restraint system on the rear seat and consult an Authorized Mazda Dealer as soon as possible.*
- *If the front passenger air bag deactivation indicator light illuminates when an adult is seated in the front passenger seat, have the passenger re-adjust their posture by sitting with their feet on the floor; and then re-fastening the seat belt. If the front passenger air bag deactivation indicator light still illuminates, move the passenger to the rear seat. If sitting in the rear seat is not possible, slide the front passenger seat as far back as possible. Consult an Authorized Mazda Dealer as soon as possible.*

**▼ Driver and Front Passenger Buckle Switches**

The buckle switches on the front seat belts detect whether or not the front seat belts are securely fastened and further control the deployment of the air bags.

Essential Safety Equipment

## SRS Air Bags

### Monitoring and Maintenance

#### ▼ Constant Monitoring

The following components of the air bag systems are monitored by a diagnostic system:

- Crash sensors, and diagnostic module (SAS unit)
- Front air bag sensor
- Air bag modules
- Side crash sensors \*
- Air bag/Front seat belt pretensioner system warning light
- Front seat belt pretensioners
- Related wiring

#### (With Front Passenger Occupant Classification System)

- Front passenger air bag deactivation indicator light
- Front passenger seat weight sensors
- Front passenger seat weight sensor control module
- Front passenger seat belt buckle switch

The diagnostic module continuously monitors the system's readiness. This begins when the ignition is switched ON and continues while the vehicle is being driven.

#### ▼ Maintenance

The air bag systems do not require regular maintenance. But if any of the following occurs, take your vehicle to an Authorized Mazda Dealer as soon as possible:

- The air bag system warning light flashes.
- The air bag system warning light remains illuminated.
- The air bag system warning light does not illuminate when the ignition is switched ON.
- The air bag system warning beep sound is heard.
- The air bags have deployed.

#### (With Front Passenger Occupant Classification System)

Front passenger air bag deactivation indicator light does not illuminate when the ignition is switched ON or does not illuminate as indicated in the chart. For more details about this indicator light and this chart, refer to "Front passenger seat weight sensors" (page 2-57).



Essential Safety Equipment  
**SRS Air Bags**

**⚠ WARNING**

**Do not operate a vehicle with damaged air bag/seat belt pretensioner system components:**

*Expended or damaged air bag/seat belt pretensioner system components must be replaced after any collision which caused them to deploy or damage them. Only a trained Authorized Mazda Dealer can fully evaluate these systems to see that they will work in any subsequent accident. Driving with an expended or damaged air bag or pretensioner unit will not afford you the necessary protection in the event of any subsequent accident which could result in serious injury or death.*

**Do not remove interior air bag parts:**

*Removing any components such as the front seats, front dashboard, the steering wheel or parts on the front and rear window pillars and along the roof edge, containing air bag parts or sensors is dangerous. These parts contain essential air bag components. The air bag could accidentally activate and cause serious injuries. Always have an Authorized Mazda Dealer remove these parts.*

**Dispose of the air bag properly:**

*Improper disposal of an air bag or a vehicle with live air bags in it can be extremely dangerous. Unless all safety procedures are followed, injury can result. Ask an Authorized Mazda Dealer how to safely dispose of an air bag or how to scrap an air bag equipped vehicle.*

**NOTE**

*If it becomes necessary to have the components or wiring system for the supplementary restraint system modified to accommodate a person with certain medical conditions in accordance with a certified physician, contact an Authorized Mazda Dealer, refer to "Customer Assistance (U.S.A.)" (page 9-2).*

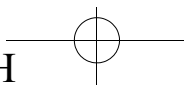
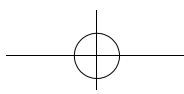

# 3 Knowing Your Mazda

Explanation of basic operations and controls; opening/closing and adjustment of various parts.

|  |             |
|--|-------------|
| <b>Advanced Keyless Entry and Start System .....</b> | <b>3-2</b>  |
| Advanced Keys * .....                                | 3-2         |
| Operation Using Advanced Keyless Functions .....     | 3-7         |
| Operation Using Advanced Key Functions .....         | 3-16        |
| Advanced Key Suspend Function .....                  | 3-20        |
| Warning Lights and Beep Sounds .....                 | 3-21        |
| When Warning Indicator/Beep is Activated .....       | 3-24        |
| <br>   |             |
| <b>Doors and Locks .....</b>                         | <b>3-25</b> |
| Keys .....   | 3-25        |
| Keyless Entry System * .....                         | 3-26        |
| Door Locks .....                                     | 3-32        |
| Liftgate (5 Door) .....                              | 3-38        |
| Trunk Lid (4 Door) .....                             | 3-42        |
| Inside Trunk Release Lever .....                     | 3-44        |
| Power Windows .....                                  | 3-46        |
| Fuel-Filler Lid and Cap .....                        | 3-49        |
| Hood .....   | 3-50        |
| Moonroof* .....                                      | 3-52        |
| <br>   |             |
| <b>Security System .....</b>                         | <b>3-54</b> |
| Immobilizer System (with Advanced Key) .....         | 3-54        |
| Immobilizer System (without Advanced Key) .....      | 3-58        |
| Theft-Deterrent System * .....                       | 3-62        |
| <br>   |             |
| <b>Steering Wheel and Mirrors .....</b>              | <b>3-65</b> |
| Steering Wheel .....                                 | 3-65        |
| Mirrors .....  | 3-65        |

\*Some models. **3-1**

Knowing Your Mazda

## Advanced Keyless Entry and Start System

### Advanced Keys \*

The advanced keyless functions (advanced keyless entry and start system) enable the following operations while the advanced key is being carried (page 3-7).

- Locking/unlocking the doors and the liftgate, and opening the liftgate, and opening the trunk lid, without operating the key.
- Starting the engine without operating the key.

Additional functions are available using the buttons on the advanced key.

Refer to Operation Using Advanced Key Functions on page 3-16.

- The following operations are possible using the transmitter of the keyless entry system from a distance (Lock/Unlock/Trunk\*/Panic button):
  - Locking/unlocking the doors and the liftgate.
  - Opening the trunk lid.
  - Operating the theft-deterrent system\*.
  - Turning on the alarm.
- Locking/unlocking the doors or starting the engine using the auxiliary key.

#### **WARNING**

**Do not leave the key in your vehicle with children and keep them in a place where your children will not find or play with them:**

*Leaving children in a vehicle with the key is dangerous. This could result in someone being badly injured or even killed. Children may find these new kinds of keys to be an interesting toy to play with and could cause the power windows or other controls to operate, or even make the vehicle move.*

**Radio waves from the advanced key may affect medical equipment such as pacemakers:**

*Before using the advanced key near people who use medical equipment, ask the medical equipment manufacturer or your physician if radio waves from the advanced key will affect the equipment.*

#### **NOTE**

- *The driver must carry the advanced key to ensure the system functions properly.*
- *Refer to Immobilizer System (page 3-54) for information regarding keys and engine starting.*
- **(With theft-deterrent system)**  
*Refer to Theft-Deterrent System (page 3-62) for information regarding keys and the prevention of vehicle and vehicle contents theft.*
- *The advanced keyless functions can be turned off.*  
*Refer to Personalization Features on page 10-13.*

Knowing Your Mazda

## Advanced Keyless Entry and Start System

---

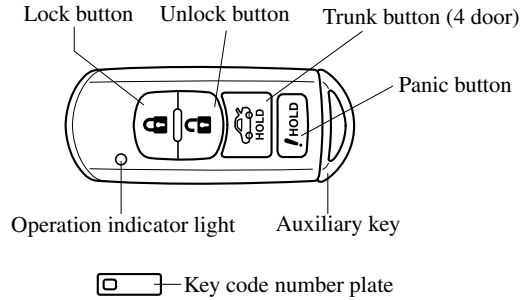

A code number is stamped on the plate attached to the key set; detach this plate and store it in a safe place (not in the vehicle) for use if you need to make a replacement key.

Also write down the code number and keep it in another safe and handy place, but not in the vehicle.

If your key is lost, consult your Authorized Mazda Dealer with the code number ready.

Knowing Your Mazda

## Advanced Keyless Entry and Start System

---

### CAUTION

- Because the advanced key uses low-intensity radio waves, it may not function correctly under the following conditions:
  - The advanced key is carried with communication devices such as cellular phones.
  - The advanced key contacts or is covered by a metal object.
  - The advanced key is near electronic devices such as personal computers or cell phones.
  - Non-Mazda genuine electronic equipment is installed in the vehicle.
  - There is equipment which discharges radio waves near the vehicle.
  - If the vehicle is near equipment such as wireless pay devices installed at certain gas stations.
- The advanced key may consume battery power excessively if it receives high-intensity radio waves. Do not place the advanced key near electronic devices such as televisions or personal computers.
- To avoid damage to the advanced key, DO NOT:
  - Drop the advanced key.
  - Get the advanced key wet.
  - Disassemble the advanced key.
  - Expose the advanced key to high temperatures on places such as the dashboard or hood, under direct sunlight.
  - Place heavy objects on the advanced key.
  - Put the advanced key in an ultrasonic cleaner.
  - Put any magnetized objects close to the advanced key.

### NOTE

- Battery life is about one year. Be sure to replace the battery as soon as you see the green KEY indicator light in the instrument cluster begin flashing for 30 seconds after turning off the engine, otherwise, you will not be able to start the engine using the advanced keyless start system once the battery is completely dead. Refer to KEY Warning Light (Red)/KEY Indicator Light (Green) (with Advanced Key) on page 5-57. If this occurs, you will have to use the auxiliary key if you need to start the engine immediately. Refer to Advanced Key Battery Dead Warning on page 3-22.



- Additional advanced keys can be obtained at an Authorized Mazda Dealer. Up to 6 advanced keys can be used with the advanced keyless functions per vehicle.

## Advanced Keyless Entry and Start System

### ▼ Advanced Key Maintenance

#### **⚠ CAUTION**

- *Make sure the battery is installed with the correct pole facing upward. Battery leakage could occur if it is not installed correctly.*
- *When replacing the battery, be careful not to touch any of the internal circuitry and electrical terminals, bend the electrical terminals, or get dirt in the transmitter as the transmitter could be damaged.*
- *There is the danger of explosion if the battery is not correctly replaced.*
- *Replace only with the same type battery (CR2025 or equivalent).*
- *Dispose of used batteries according to the following instructions.*
  - *Insulate the plus and minus terminals of the battery using cellophane or equivalent tape.*
  - *Never disassemble.*
  - *Never throw the battery into fire or water.*
  - *Never deform or crush.*

The following conditions indicate that the battery power is low:

- The KEY indicator light (green) flashes in the instrument cluster for about 30 seconds after the engine is turned off.
- The system does not operate and the operation indicator light on the transmitter does not flash when the buttons are pressed.
- The system's operational range is reduced.

Replacing the battery at an Authorized Mazda Dealer is recommended to prevent damage to the advanced key. If replacing the battery by yourself, follow the instruction below.

#### **Replacing the advanced key battery**

1. Pull out the auxiliary key.

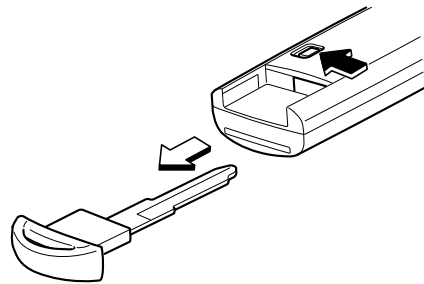

2. Insert a small, flathead screwdriver into the groove shown in the figure and rotate the screwdriver to open the cover slightly.

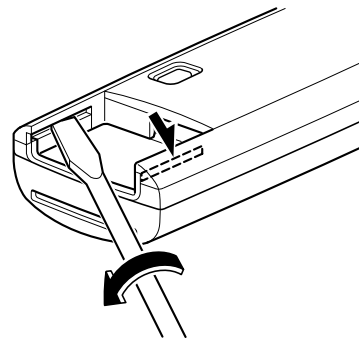

Knowing Your Mazda

## Advanced Keyless Entry and Start System

3. Insert the small, flathead screwdriver into the gap between the cover and the transmitter, and then rotate the screwdriver to detach the cover.

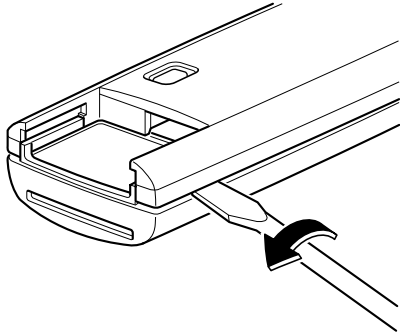

4. Remove the battery cap, then remove the battery.

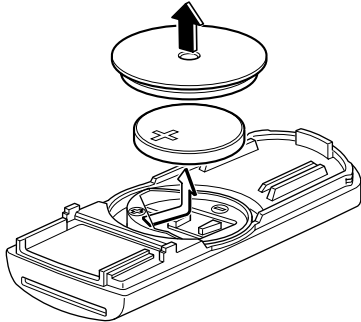

5. Insert a new battery with the positive pole facing up, and then cover the battery with the battery cap.

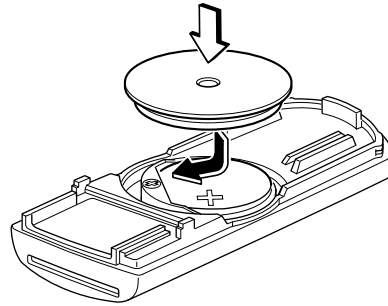

6. Close the cover.

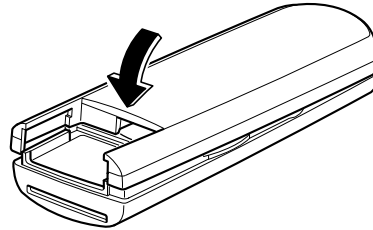

7. Reinsert the auxiliary key.



## Advanced Keyless Entry and Start System

### **CAUTION**

- Be careful not to allow the rubber ring shown in the figure to be scratched or damaged.
- If the rubber ring detaches, reattach it before inserting a new battery.

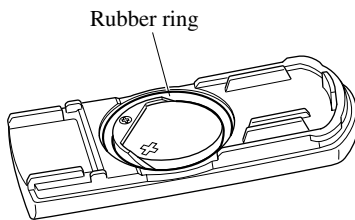

### **Service**

If you have a problem with the advanced keyless functions, consult an Authorized Mazda Dealer.

If your advanced key is lost or stolen, bring all remaining advanced keys to an Authorized Mazda Dealer as soon as possible for a replacement and to make the lost or stolen advanced key inoperative.

### **CAUTION**

Radio equipment like this is governed by laws in the United States. Changes or modifications not expressly approved by the party responsible for compliance could void the user's authority to operate the equipment.

### Operation Using Advanced Keyless Functions

#### **Operational Range**

The system operates only when the driver is in the vehicle or within operational range while the advanced key is being carried.

#### **NOTE**

When the battery power is low, or in places where there are high-intensity radio waves or noise, the operational range may become narrower or the system may not operate.

#### **Locking, unlocking the doors and the liftgate**

The operational range for locking/unlocking the doors and the liftgate is an area of up to 80 cm (31 in) from the center of the front door handles.

The operational range for locking the doors and the liftgate is within a maximum radius of 80 cm (31 in) from the center of the liftgate.

#### **4 door**

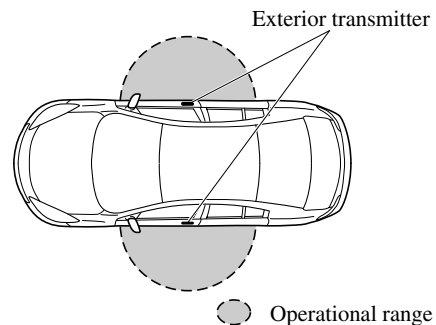

Knowing Your Mazda

# Advanced Keyless Entry and Start System

## 5 door (Locking)

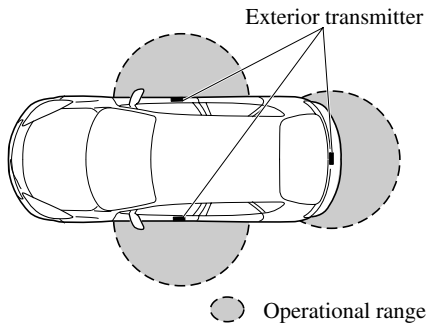

## 5 door (Unlocking)

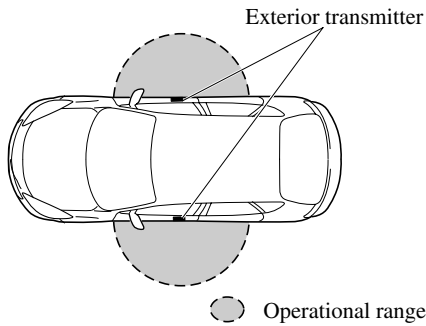

### NOTE

The system may not operate if you are too close to the windows, door handles, or liftgate.

## Opening the liftgate/trunk lid

The operational range for opening the liftgate/trunk lid is an area of up to 80 cm (31 in) from the center of the liftgate/trunk lid.

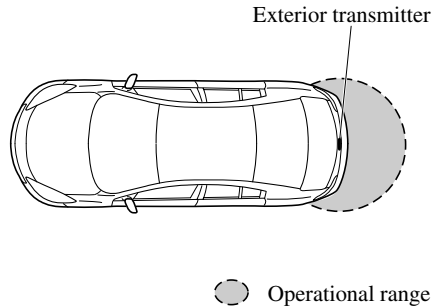

## Starting the engine

The operational range for starting the engine includes nearly the entire cabin area.

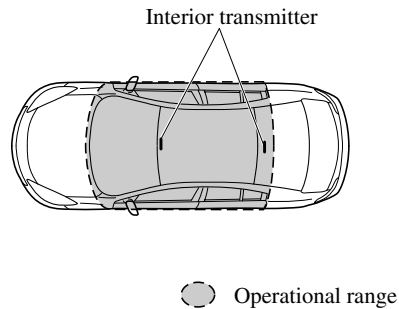

## Advanced Keyless Entry and Start System

### NOTE

- The luggage compartment/trunk is out of the operational range, however, starting the engine may be possible.
- The engine may not start if the advanced key is placed in the following areas:
  - Around the dashboard
  - In the storage compartments such as the glove box
  - On the rear parcel shelf(4 door)
- Starting the engine may be possible even if the advanced key is outside of the vehicle and extremely close to a door and window, however, always start the engine from the driver's seat.

*If the vehicle is started and driven away while the advanced key is not in the vehicle, the vehicle will not restart after it is turned off and the ignition is switched off.*

- If the advanced key is detected within operational range, the operation indicator light on the transmitter flashes momentarily.

### ▼ Locking, Unlocking with Request Switch

All doors and the liftgate can be locked/unlocked by pressing the request switch on the front doors or the liftgate while the advanced key is being carried. The request switch on the liftgate can only be used to lock all doors and the liftgate.

### Front doors

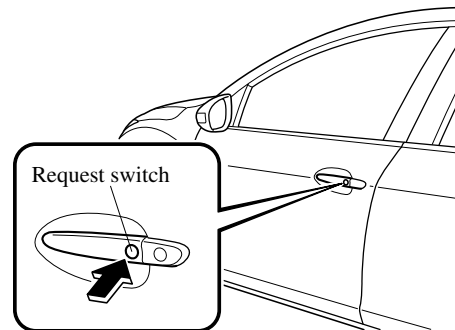

### Liftgate (Lock only)

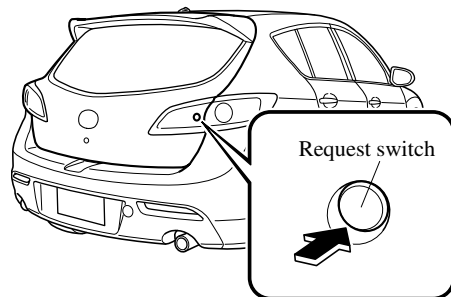

### To lock

To lock the doors and the liftgate, press the request switch. A beep sound will be heard once and the hazard warning lights will flash once.

Knowing Your Mazda

## Advanced Keyless Entry and Start System

### **NOTE**

#### ***(Without theft-deterrent system)***

The hazard warning lights will flash once to indicate that the doors and the liftgate are locked.

#### ***(With theft-deterrent system)***

The hazard warning lights flash when the theft deterrent system is armed.

The hazard warning lights do not flash if all the doors and the liftgate are locked before the theft-deterrent system is properly armed.

When the doors are locked by pressing the request switch on the front doors while the theft-deterrent system is armed, the hazard warning lights will flash once to indicate that the system is armed.

Refer to Theft-Deterrent System on page 3-62.

### **To unlock**

#### **Driver's door request switch**

To unlock the driver's door, press the request switch. A beep sound will be heard twice and the hazard warning lights will flash twice.

To unlock all doors and the liftgate, press the request switch again within 5 seconds and two more beep sounds will be heard.

#### **Front passenger door request switch**

To unlock the doors and the liftgate, press the request switch. A beep sound will be heard twice and the hazard warning lights will flash twice.

### **NOTE**

- Confirm that all doors and the liftgate are securely locked.
- All doors and the liftgate cannot be locked when any door or the liftgate is open.

- A beep sound is heard for confirmation when the doors and the liftgate are locked/unlocked using the request switch. If you prefer, the beep sound can be turned off. The volume of the beep sound can be changed. Refer to Personalization Features on page 10-13.
- The system can be set to unlock all doors by performing a single operation. Refer to Personalization Features on page 10-13.
- The setting can be changed so that the doors and the liftgate are locked automatically without pressing the request switch (page 10-13).

#### ***(Auto-lock function)***

A beep sound is heard when all doors and the liftgate are closed while the advanced key is being carried. All doors and the liftgate are locked automatically after about 3 seconds when the advanced key is out of the operational range. Also, the hazard warning lights flash once. (Even if the driver is in the operational range, all doors and the liftgate are locked automatically after about 30 seconds.)

If you are out of the operational range before the doors and the liftgate are completely closed or another advanced key is left in the vehicle, the auto-lock function will not work. Always make sure that all doors and the liftgate are closed and locked before leaving the vehicle.

## Advanced Keyless Entry and Start System

- **(Auto re-lock function)**

After unlocking all doors and the liftgate by pressing the request switch, all doors and the liftgate will automatically lock if any of the following operations are not performed within about 30 seconds. If your vehicle has a theft-deterrent system, the hazard warning lights will flash for confirmation. The time required for the doors to lock automatically can be changed. Refer to Personalization Features on page 10-13.

- A door or the liftgate/trunk lid is opened.
- The auxiliary key is inserted into the key slot.
- The push button start is in any position except off.

### ▼ Opening the Liftgate/Trunk Lid

A locked liftgate/trunk lid can also be opened while the advanced key is being carried.

#### 5 Door

Grasp the lower end of the liftgate, press the electric liftgate opener on the liftgate, and then raise the liftgate when the latch releases.

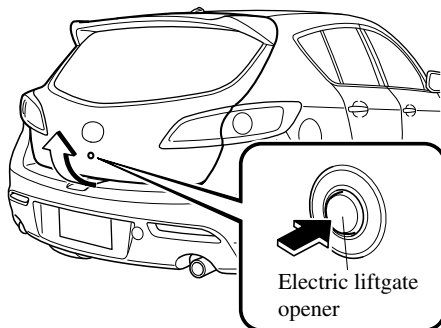

#### NOTE

When the liftgate is unlocked by pressing the electric liftgate opener button, the liftgate raises slightly to allow it to be opened. If the liftgate is not operated for a certain period of time after the electric liftgate opener button has been pressed, the liftgate cannot be raised any more from its slightly raised position. Press the electric liftgate opener button again to fully open the liftgate. To close the liftgate from its slightly raised position, open it first by pressing the electric liftgate opener button and wait for 1 second or longer, then close it. The door-ajar warning light will illuminate if the liftgate is not fully closed.

#### 4 Door

Raise the trunk lid by pressing the electric trunk lid opener on trunk lid.

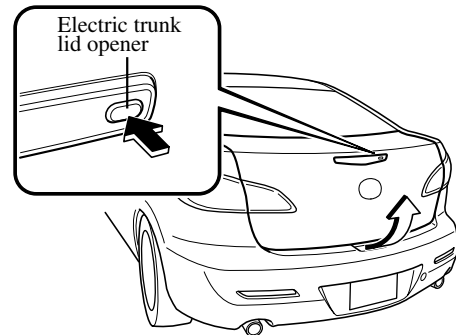

While the ignition is switched ON, the liftgate/trunk lid can be opened only when the vehicle is stopped with the parking brake applied (manual transaxle), or with the selector lever in the P position (automatic transaxle).

#### NOTE

When using the advanced keyless function to open the liftgate/trunk lid, it may require a few seconds for the liftgate/trunk lid to unlock after the electric liftgate/trunk lid opener is pressed.

Knowing Your Mazda

## Advanced Keyless Entry and Start System

The liftgate/trunk lid can be closed when the doors are locked with the advanced key left in the vehicle. However, to prevent leaving the advanced key in the vehicle, the liftgate/trunk lid can be opened by pressing the electric liftgate/trunk lid opener.

### ▼ Starting the Engine

#### Ignition positions

Each time the push button start is pressed, the ignition switches in the order of off, ACC, and ON. Pressing the push button start again from ON switches the ignition off.

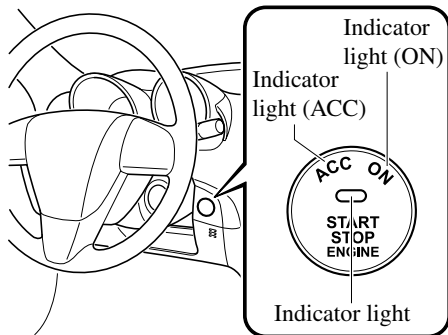

#### **NOTE**

- The order in which the ignition position transitions when pressing the push button start can be changed. Refer to Personalization Features on page 10-13.
- The engine starts by pressing the push button start while depressing the clutch pedal (manual transaxle) or the brake pedal (automatic transaxle). To switch the ignition position, press the push button start without depressing the pedal.
- Do not leave the ignition switched ON while the engine is not running. Doing so could result in the battery going dead. If the ignition is left in ACC (For automatic transaxle, the shift lever is in the P position, and the ignition is in ACC), the ignition switches off automatically after one hour. The setting can be changed to not switch the ignition off automatically. Refer to Personalization Features on page 10-13.

#### **Off**

The power supply to electrical devices turns off and the push button start indicator lights (ACC and ON) also turn off.

## Advanced Keyless Entry and Start System

### **⚠ WARNING**

**Before leaving the driver's seat, always switch the ignition off, set the parking brake, and make sure the shift lever is in P (automatic transaxle) or in 1st gear or R (manual transaxle):**

*Leaving the driver's seat without switching the ignition off, setting the parking brake, and shifting the shift lever to P (automatic transaxle) or to 1st gear or R (manual transaxle) is dangerous. Unexpected vehicle movement could occur which could result in an accident.*

*In addition, if your intention is to leave the vehicle for even a short period, it is important to switch the ignition off, as leaving it in another position will disable some of the vehicle's security systems and run the battery down.*

### **ACC (Accessory)**

Some electrical accessories will operate and the indicator light (ACC) illuminates.

### **NOTE**

*The advanced keyless entry system does not function while the push button start has been pressed to ACC, and the doors will not lock/unlock even if they have been locked manually.*

### **ON**

This is the normal running position after the engine is started. The indicator light (ON) turns off. (The indicator light (ON) illuminates when the ignition is switched ON and the engine is not running.)

The warning lights (except brakes) should be inspected before the engine is started (page 5-47).

### **Starting the engine**

#### **NOTE**

- *The advanced key must be carried because the advanced key carries an immobilizer chip that must communicate with the engine controls at short range.*
- *The engine can be started when the push button start is pressed from off, ACC, or ON.*

1. Make sure you are carrying the advanced key.
2. Occupants should fasten their seat belts.
3. Make sure the parking brake is on.
4. Continue to press the brake pedal firmly until the engine has completely started.
5. **(Manual transaxle)**  
Continue to press the clutch pedal firmly until the engine has completely started.

#### **(Automatic transaxle)**

Put the vehicle in park (P). If you must restart the engine while the vehicle is moving, shift into neutral (N).

#### **NOTE**

##### **(Manual transaxle)**

*The starter will not operate if the clutch pedal is not depressed sufficiently.*

##### **(Automatic transaxle)**

*The starter will not operate if the shift lever is not in P or N and the brake pedal is not depressed sufficiently.*

Knowing Your Mazda

## Advanced Keyless Entry and Start System

- Verify that the KEY indicator light (green) in the instrument cluster and the push button start indicator light (green) illuminate. If the KEY indicator light (green) does not illuminate, make sure that the advanced key is being carried. If the KEY indicator light (green) does not illuminate while the advanced key is being carried, you may have to use the auxiliary key to start the engine instead (page 3-24).



### **CAUTION**

If the KEY warning light (red) illuminates, and the push button start indicator light (red) illuminates, this could indicate a problem with the engine starting system and the inability to start the engine or switch the ignition to ACC or ON. Have your vehicle inspected at an Authorized Mazda Dealer as soon as possible.

### **NOTE**

- Under the following conditions, the KEY warning light (red) flashes to inform the driver that the push button start will not switch to ACC even if it is pressed from off.
    - The advanced key battery is dead.
    - The advanced key is out of operational range.
    - The advanced key is placed in areas where it is difficult for the system to detect the signal (page 3-7).
    - A key from another manufacturer similar to the advanced key is in the operational range.
  - (Forced engine starting method)**

If the KEY warning light (red) and the push button start indicator light (red) illuminate when the clutch pedal (manual transaxle) or the brake pedal (automatic transaxle) is depressed to start the engine, the engine may not start using these methods. Have your vehicle inspected at an Authorized Mazda Dealer as soon as possible. If this occurs, the engine can be force-started. Press and hold the push button start until the engine starts. Other procedures necessary for starting the engine such as having the advanced key in the cabin, and depressing the clutch pedal (manual transaxle) or the brake pedal (automatic transaxle) are required.
  - When the engine is force-started, the key warning light (red) remains illuminated and the key indicator light (green) does not illuminate.
- Press the push button start after both the KEY indicator light (green) in the instrument cluster and the push button start indicator light (green) illuminate.



## Advanced Keyless Entry and Start System

### NOTE

- After starting the engine, the push button start indicator lights (ACC and ON) turn off and the ignition is in the ON position.
- After pressing the push button start and before the engine starts, the operation sound of the fuel pump motor from near the fuel tank can be heard, however, this does not indicate a malfunction.

8. After starting the engine, let it idle for about ten seconds.

### NOTE

- Whether the engine is cold or warm, it should be started without the use of the accelerator.
- If the engine does not start the first time, refer to Starting a Flooded Engine under Emergency Starting. If the engine still does not start, have your vehicle inspected by an Authorized Mazda Dealer (page 7-18).

### Starting the engine using the auxiliary key

If the engine cannot be started for reasons such as the advanced key battery is dead, the engine can be started using the auxiliary key.

1. Slide the auxiliary key out from the bottom of the advanced key.
2. Use the auxiliary key to remove the key slot cover.
3. Depress the clutch pedal (manual transaxle) or the brake pedal (automatic transaxle) until the ring around the key slot starts flashing.

4. Insert the auxiliary key into the slot while it is flashing, but **DO NOT TURN THE AUXILIARY KEY IN THE SLOT.**

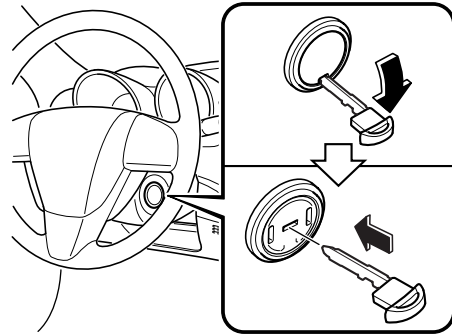

### CAUTION

After inserting the auxiliary key, do not attempt to turn it in the key slot. It could damage the vehicle or the auxiliary key.

5. Press the push button start to start the engine.

### NOTE

- Leave the auxiliary key in the key slot while the engine is running.
- When leaving the vehicle, remove the auxiliary key from the key slot and the vehicle.
- To switch the ignition position, insert the auxiliary key into the key slot and press the push button start without the clutch pedal (manual transaxle) or the brake pedal (automatic transaxle) depressed.

### Turning the engine off

1. Stop the vehicle completely.
2. **(Manual transaxle)**  
Shift into neutral.  
**(Automatic transaxle)**  
Shift the shift lever to the P position.

Knowing Your Mazda

## Advanced Keyless Entry and Start System

3. Press the push button start to turn off the engine.

### CAUTION

*When leaving the vehicle, make sure the push button start is pressed to off.*

### NOTE

- *When the push button start is pressed to off from ON, the KEY indicator light (green) flashes for approximately 30 seconds indicating that the remaining battery power of the advanced key is low. Replace with a new battery before the advanced key becomes unusable. Refer to Advanced Key Maintenance on page 3-5.*
- **(Automatic transaxle)**  
*If the engine is turned off while the shift lever is in a position other than P, the ignition switches to ACC.*

### Emergency engine stop

### WARNING

**Do not stop the engine while the vehicle is moving:**

*Stopping the engine while the vehicle is moving for any reason other than in an emergency is dangerous. Stopping the engine while the vehicle is moving will result in reduced braking ability due to the loss of power braking, which could cause an accident and serious injury.*

Continuously pressing the push button start while the engine is running and the vehicle is stopped, or quickly pressing it any number of times will turn the engine off immediately.

## Operation Using Advanced Key Functions

### ▼ Keyless Entry System

This system uses the more traditional keyless entry buttons to remotely lock and unlock the doors and the liftgate, and opens the trunk lid.

It can also help you signal for attention. Press the buttons slowly and carefully.

### NOTE

- *The keyless entry system is designed to operate up to about 2.5 m (8 ft) from the center of the vehicle, but this may vary due to local conditions.*
- *The system does not operate when the auxiliary key is in the key slot.*
- *The keyless entry system is fully operational when the push button start is switched off. The system does not operate if the push button start is switched to any position other than off.*
- *All doors and the liftgate cannot be locked by pressing the lock button while any door or the liftgate is open. The hazard warning lights will also not flash.*
- *If the transmitter does not operate when pressing a button or the operational range becomes too small, the battery may be dead. To install a new battery, refer to Maintenance (page 3-5).*

## Advanced Keyless Entry and Start System

### Transmitter

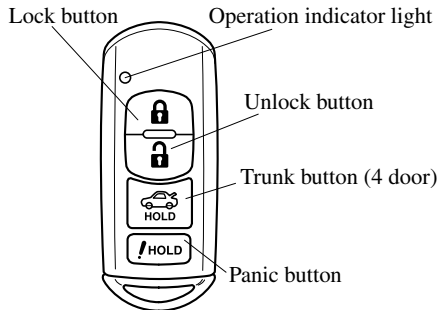

The operation indicator light flashes when the buttons are pressed.

### Lock button

To lock the doors and the liftgate, press the lock button. A beep sound will be heard once and the hazard warning lights will flash once.

To confirm that all doors and the liftgate have been locked, press the lock button again within 5 seconds. If they are closed and locked, the horn will sound.

The system can be set not to sound the horn.  
Refer to Personalization Features on page 10-13.

### NOTE

- A beep sound can be heard for confirmation when the doors are locked using the advanced keyless transmitter. If you prefer, the beep sound can be turned off. The volume of the beep sound can be changed. Refer to Personalization Features on page 10-13.

- **(Without theft-deterrent system)**

The hazard warning lights will flash once to indicate that all doors and the liftgate are locked.

- **(With theft-deterrent system)**

The hazard warning lights flash when the theft deterrent system is armed.

The hazard warning lights do not flash if all the doors and the liftgate are locked before the theft-deterrent system is properly armed.

When the doors are locked by pressing the lock button on the transmitter while the theft-deterrent system is armed, the hazard warning lights will flash once to indicate that the system is armed.

Refer to Theft-Deterrent System on page 3-62.

### NOTE

- All doors and the liftgate cannot be locked when any door or the liftgate is open.
- Confirm that all doors and the liftgate are locked visually or audibly by use of the double click.

### Unlock button

To unlock the driver's door, press the unlock button. A beep will be heard twice and the hazard warning lights will flash twice.

To unlock all doors and the liftgate, press the unlock button again within 3 seconds and two more beep sounds will be heard.

Knowing Your Mazda

## Advanced Keyless Entry and Start System

### NOTE

- *A beep sound can be heard for confirmation when the doors are unlocked using the advanced keyless transmitter. If you prefer, the beep sound can be turned off. The volume of the beep sound can be changed. Refer to Personalization Features on page 10-13.*
- **(Without theft-deterrent system)**  
*The hazard warning lights will flash twice to indicate that all doors and the liftgate are unlocked.*  
**(With theft-deterrent system)**  
*The hazard warning lights flash when the theft deterrent system is turned off. The hazard warning lights do not flash unless the theft deterrent system has been properly turned off. When the doors are unlocked by pressing the unlock button on the transmitter while the theft-deterrent system is turned off, the hazard warning lights will flash twice to indicate that the system is turned off. Refer to Theft-Deterrent System on page 3-62.*

### NOTE

#### **(Auto re-lock function)**

*After unlocking with the transmitter, all doors and the liftgate will automatically lock if any of the following operations are not performed within about 30 seconds. If your vehicle has a theft-deterrent system, the hazard warning lights will flash for confirmation. The time required for the doors to lock automatically can be changed. Refer to Personalization Features on page 10-13.*

- *A door or the liftgate/trunk lid is opened.*
- *The auxiliary key is inserted into the key slot.*
- *The push button start is in any position except off position.*

### Trunk button (4 door)

To open the trunk, press and hold the trunk button until the trunk lid opens.

### Panic button

If you witness from a distance someone attempting to break into or damage your vehicle, pressing the panic button will activate the vehicle's alarm.

### NOTE

*The panic button will work whether any door or the liftgate is open or closed.*

### (Turning on the alarm)

Pressing the panic button for 1 second or more will trigger the alarm for about 2 minutes and 30 seconds, and the following will occur:

- The horn sounds intermittently.
- The hazard warning lights flash.

### NOTE

*However, if the driver is too close to the vehicle the panic button may not function.*

### (Turning off the alarm)

The alarm stops by pressing any button on the transmitter.

## Advanced Keyless Entry and Start System

### Declaration of Conformity

#### **Keyless entry system**

(U.S.A)

FCC WARNING

Changes or modifications not expressly approved by the party responsible for compliance could void the user's authority to operate the equipment.

Note

\*This device complies with Part 15 of the FCC Rules. Operation is subject to the following two conditions:

(1) this device may not cause harmful interference, and (2) this device must accept any interference received, including interference that may cause undesired operation.

(CANADA)

This device complies with RSS-210 of Industry CANADA. Operation is subject to the following two conditions: (1) this device may not cause interference, and (2) this device must accept any interference, including interference that may cause undesired operation of the device.

(MEXICO)

Este equipo opera a título secundario, consecuentemente, debe aceptar interferencias perjudiciales incluyendo equipos de la misma clase y puede no causar interferencias a sistemas operando a título primario

Sistema de acceso normal sin llave

Modelo : SKE125-01

**Sistema de acceso normal sin llave con marcado de confirmación por radio**

**COFETEL RCPMAIM05-615**

Sistema de arranque y de acceso avanzado sin llave

Modelo : SKE11A-03

**Sistema de arranque y de acceso avanzado sin llave con marcado de confirmación por radio**

**COFETEL RCPMASK08-1067**

Knowing Your Mazda

## Advanced Keyless Entry and Start System

### ▼ Auxiliary Key Function

Use the auxiliary key stored in the advanced key in the event of a dead transmitter battery or malfunction.

#### Removing the auxiliary key

Pull out the auxiliary key from the advanced key.

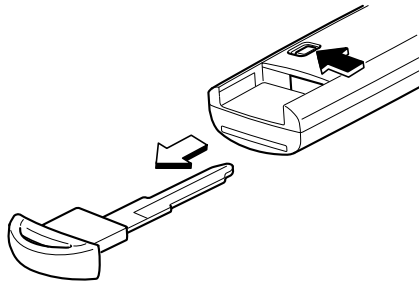

#### Locking, unlocking the doors

The doors can be locked/unlocked using the auxiliary key, refer to Locking, Unlocking with Key (page 3-32).

#### Starting the engine

The engine can be started with the auxiliary key, refer to Starting the engine (page 3-12).

### Advanced Key Suspend Function

If an advanced key is left in the vehicle, the functions of the advanced key left in the vehicle are temporarily suspended to prevent theft of the vehicle.

The following are inoperable:

- Starting the engine using the push button start.
- Operating the request switches.

To restore these functions, perform any one of the following:

- Press the lock or unlock button on the advanced key which has had its functions temporarily suspended.
- While carrying an advanced key which has had its functions temporarily suspended, lock the doors using the advanced keyless system.
- **(Manual transaxle)**  
When carrying another advanced key, depress the clutch pedal until the KEY indicator light (green) illuminates.

#### **(Automatic transaxle)**

When carrying another advanced key, depress the brake pedal until the KEY indicator light (green) illuminates.

## Advanced Keyless Entry and Start System

### Warning Lights and Beep Sounds

#### ▼ System Malfunction Warning Light

If any malfunction occurs in the advanced keyless function, the KEY warning light (red) in the instrument cluster illuminates continuously.

#### CAUTION

*If the KEY warning light (red) remains illuminated, do not continue to drive the vehicle with the advanced keyless function. Park the vehicle in a safe place and use the auxiliary key to continue driving the vehicle. Have the vehicle inspected at an Authorized Mazda Dealer as soon as possible. Refer to Starting the engine (page 3-12).*

#### ▼ Ignition Not Switched Off (STOP) Warning Beep

If the driver's door is opened while the ignition is switched to ACC, a continuous beep sound will be heard to notify the driver that the ignition has not been switched off (STOP). Left in this condition, the keyless entry system will not operate, the car cannot be locked, and the battery power will be depleted.

#### ▼ Advanced Key Removed from Vehicle Warning Beep

Under the following conditions, a beep sound will be heard and the KEY warning light (red) will flash continuously when the ignition has not been switched off to notify the driver that the advanced key has been removed. The KEY warning light (red) will stop flashing when the advanced key is back inside the vehicle:

- The ignition has not been switched off, the driver's door is open, and the advanced key is removed from the vehicle. (A beep sound will be heard three times.)

However the beep sound will be heard continuously when the ignition is switched to ACC and the door is open due to the activation of the warning beep sound indicating that the ignition is not switched off.

- The ignition has not been switched off and all the doors are closed after removing the advanced key from the vehicle. (A beep sound will be heard six times. The volume of the beep sound can be changed.)

Refer to Personalization Features on page 10-13.

#### **NOTE**

*Because the advanced key utilizes low-intensity radio waves, the Advanced Key Removed From Vehicle Warning may activate if the advanced key is carried together with a metal object or it is placed in a poor signal reception area within the vehicle.*

Knowing Your Mazda

## Advanced Keyless Entry and Start System

### ▼ Request Switch Inoperable Warning Beep

If the request switch for a front door is pressed under the following conditions while the advanced key is being carried, a beep will be heard six times to indicate that the front doors cannot be locked. The volume of the beep sound can be changed.

Refer to Personalization Features on page 10-13.

- A door is open (door ajar included).
- The ignition has not been switched off.
- The auxiliary key is inserted into the key slot.

### ▼ Advanced Key Battery Dead Warning

When the ignition is switched to ACC or switched off from ON, the KEY indicator light (green) flashes for approximately 30 seconds indicating that the remaining battery power is low. Replace with a new battery before the advanced key becomes unusable.

Refer to Advanced Key Maintenance (page 3-5).

#### **NOTE**

*The advanced key can be set so that the KEY indicator light (green) does not flash even if the battery power is low.*

*Refer to Personalization Features on page 10-13.*

### ▼ Engine Start Not Permitted Warning

Under the following conditions, the KEY warning light (red) flashes to inform the driver that the ignition cannot be switched from off.

- The advanced key battery is dead.

- The advanced key is not within operational range.
- The advanced key is placed in areas where it is difficult for the system to detect the signal (page 3-7).
- A key from another manufacturer similar to the advanced key is in the operational range.

### ▼ Advanced Key Left-in-luggage compartment/trunk Warning Beep

If the advanced key is left in the luggage compartment/trunk with all doors locked and the liftgate/trunk lid closed, a beep sound is heard for about 10 seconds to remind the driver the advanced key has been left in the luggage compartment/trunk. If this happens, open the liftgate/trunk lid by pressing the electric liftgate/trunk lid opener and remove the advanced key. An advanced key removed from the luggage compartment/trunk may not function because its functions may have been temporarily suspended. To restore the advanced key function, perform the applicable procedure (page 3-20).

The system can be set not to open the trunk.

Refer to Personalization Features on page 10-13.



## Advanced Keyless Entry and Start System

---

### ▼ Advanced Key Left-in-vehicle Warning Beep

If an advanced key is left in the vehicle cabin and all the doors are locked using a separate advanced key, a beep sound is heard for about 10 seconds to remind the driver that the advanced key has been left in the vehicle cabin. If this happens, the doors lock but the functions of the advanced key left in the vehicle cabin may be temporarily suspended. Perform the following procedure to restore the functions of the advanced key (page 3-20).

The volume of the beep sound can be changed.

Refer to Personalization Features on page 10-13.

#### **NOTE**

*The warning beep does not sound while the trunk is open. The warning beep sounds after the trunk is closed.*

### ▼ Auxiliary Key Removed Warning Beep

If the auxiliary key is removed under the following conditions while it is in use and in the ACC or ON position, the warning beep sounds three times.

- The advanced key is not in the vehicle.
- The battery for the advanced key is dead.

Knowing Your Mazda

## Advanced Keyless Entry and Start System

### When Warning Indicator/Beep is Activated

Under the following conditions, warning beeps are heard and a warning/indicator light in the instrument cluster illuminates to notify the driver of improper operation of the advanced key to prevent theft of the vehicle (page 3-21).

| Warning  | How to check   |
|--|--|
| When a door is open, a continuous beep sound will be heard.  | Check whether the ignition has been switched off.  |
| When a door is open, 3 beep sounds are heard, and the KEY warning light (red) in the instrument cluster flashes.         | Check whether the advanced key has been removed from the vehicle.  |
| When a door is closed, a beep sound is heard 6 times, and the KEY warning light (red) in the instrument cluster flashes. | Check whether the advanced key has been removed from the vehicle.  |
| When locking the doors or closing the trunk/liftgate , the chime sounds for about ten seconds.                           | Check whether the advanced key has been left in the vehicle or the trunk/liftgate .  |
| When attempting to lock the doors by pressing the request switch on the front doors, and six beep sounds are heard.      | Check whether the ignition has been switched off.  |
|  | Check whether a door is open.  |
| When the KEY indicator light (green) flashes in the instrument cluster.  | The advanced key battery power is low. Replace the battery with a new one. Refer to Advanced Key Maintenance on page 3-5.  |
| When the KEY warning light (red) remains illuminated in the instrument cluster.  | The advanced key is malfunctioning. Park the vehicle in a safe place, and use the auxiliary key to continue driving the vehicle. Have the vehicle inspected at an Authorized Mazda Dealer as soon as possible. |

## Knowing Your Mazda Doors and Locks

### Keys

#### **! WARNING**

**Do not leave the key in your vehicle with children and keep them in a place where your children will not find or play with them:**

*Leaving children in a vehicle with the key is dangerous. This could result in someone being badly injured or even killed. Children may find these new kinds of keys to be an interesting toy to play with and could cause the power windows or other controls to operate, or even make the vehicle move.*

#### **NOTE**

- Refer to *Immobilizer System* (page 3-58) for information regarding keys and engine starting.
- **(With theft-deterrent system)**  
Refer to *Theft-Deterrent System* (page 3-62) for information regarding keys and the prevention of vehicle and vehicle contents theft.

The keys operate all locks.  
**With keyless entry system**

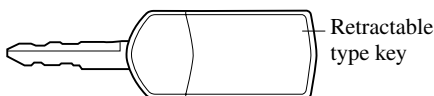

 Key code number plate

### Without keyless entry system

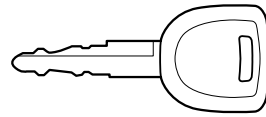

 Key code number plate

A code number is stamped on the plate attached to the key set; detach this plate and store it in a safe place (not in the vehicle) for use if you need to make a replacement key.

#### **NOTE**

- Write down the code number and keep it in a separate, safe and convenient place, but not in the vehicle.  
*If your key is lost, consult your Authorized Mazda Dealer and have your code number ready.*
- Some types of key chains cannot be attached to the retractable type key. In this case, use the key ring provided with the transmitter which has the key code number plate attached.

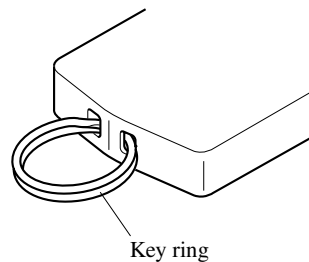

Knowing Your Mazda

## Doors and Locks

### Key extend/retract method (Retractable type key)

To extend the key, press the release button.

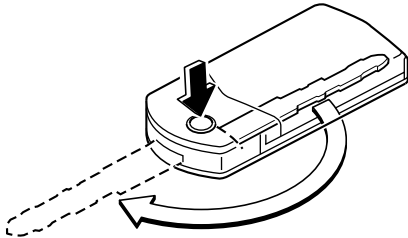

To retract the key, rotate it into the holder while pressing the release button.

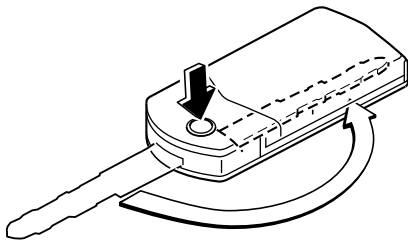

### Keyless Entry System \*

This system remotely locks and unlocks the doors and the liftgate, and opens the trunk lid.

It can also help you signal for attention. Operating the theft-deterrent system with the keyless entry system transmitter is also possible on theft-deterrent system-equipped vehicles.

Press the buttons slowly and carefully.

#### **CAUTION**

To avoid damage to the transmitter, do not:

- Drop the transmitter.
- Get the transmitter wet.
- Disassemble the transmitter.
- Expose the transmitter to any kind of magnetic field.
- Expose the transmitter to high temperatures on places such as the dashboard or hood, under direct sunlight.

#### **NOTE**

- The keyless entry system is designed to operate up to about 2.5 m (8 ft) from the center of the vehicle, but this may vary due to local conditions.
- The system does not operate when the key is in the ignition switch.
- If the transmitter does not operate when pressing a button or the operation range becomes too small, the battery may be dead. To install a new battery, refer to Maintenance (page 3-30).
- Additional transmitters can be obtained at an Authorized Mazda Dealer. Up to 3 transmitters can be used with the keyless entry system per vehicle. Bring all transmitters to an Authorized Mazda Dealer when additional transmitters are required.

## Knowing Your Mazda Doors and Locks

### ▼ Transmitter

#### 5 door

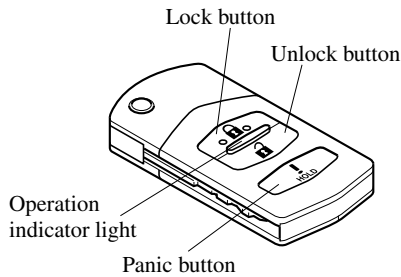

#### 4 door

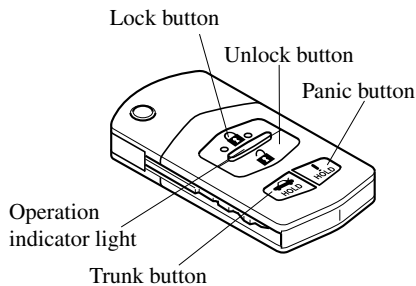

The operation indicator light flashes when the buttons are pressed.

#### **Lock button**

To lock the doors and the liftgate, press the lock button.

To confirm that all doors and the liftgate have been locked, press the lock button again within 5 seconds. If they are closed and locked, the horn will sound.

The system can be set not to sound the horn.

Refer to Personalization Features on page 10-13.

#### **NOTE**

- *Doors and the liftgate can be locked by pressing the lock button while any other door or the liftgate is open. However, the hazard warning lights will not flash and the horn will not sound.*
- **(Without theft-deterrent system)**  
*The hazard warning lights will flash once to indicate that all doors and the liftgate are locked.*
- **(With theft-deterrent system)**  
*The hazard warning lights flash when the theft deterrent system is armed.*  
*The hazard warning lights do not flash if all the doors and the liftgate are locked before the theft-deterrent system is properly armed.*  
*When the doors are locked by pressing the lock button on the transmitter while the theft-deterrent system is armed, the hazard warning lights will flash once to indicate that the system is armed.*  
*Refer to Theft-Deterrent System on page 3-62.*
- *The hazard warning lights can be set to not flash when the doors are locked or unlocked.*  
*Refer to Personalization Features on page 10-13.*
- *All doors and the liftgate cannot be locked when the key is in the ignition switch.*
- *Confirm that all doors and the liftgate are locked visually or audibly by use of the double click.*

#### **Unlock button**

To unlock the driver's door, press the unlock button.

To unlock all doors and the liftgate, press the unlock button again within 5 seconds.

Knowing Your Mazda

## Doors and Locks

### **NOTE**

#### ***(Without theft-deterrent system)***

*The hazard warning lights will flash twice to indicate that all doors and the liftgate are unlocked.*

#### ***(With theft-deterrent system)***

*The hazard warning lights flash when the theft deterrent system is turned off.*

*The hazard warning lights do not flash unless the theft deterrent system has been properly turned off.*

*When the doors are unlocked by pressing the unlock button on the transmitter while the theft-deterrent system is turned off, the hazard warning lights will flash twice to indicate that the system is turned off.*

*Refer to Theft-Deterrent System on page 3-62.*

*The system can be set to unlock all doors by performing a single operation.*

*Refer to Personalization Features on page 10-13.*

### **NOTE**

#### ***Auto re-lock function***

*After unlocking with the transmitter, all doors and the liftgate will automatically lock if one of the doors or the liftgate/trunk lid is not opened within about 30 seconds.*

*The time required for the doors to lock automatically can be changed.*

*Refer to Personalization Features on page 10-13.*

### **Trunk button**

To open the trunk, press and hold the trunk button until the trunk lid opens.

### **NOTE**

*To open the trunk when the ignition is switched to a position other than off, use the remote release lever inside the vehicle (page 3-42).*

### **Panic button**

If you witness from a distance someone attempting to break into or damage your vehicle, pressing the panic button will activate the vehicle's alarm.

### **NOTE**

*The panic button will work whether any door or the liftgate/trunk lid is open or closed.*

### **Turning on the alarm**

Pressing the panic button for 1 second or more will trigger the alarm for about 2 minutes and 30 seconds, and the following will occur:

- The horn sounds intermittently.
- The hazard warning lights flash.

### **Turning off the alarm**

Press any button on the transmitter.

Knowing Your Mazda  
**Doors and Locks**

**Declaration of Conformity**

**Keyless entry system**

(U.S.A)

FCC WARNING

Changes or modifications not expressly approved by the party responsible for compliance could void the user's authority to operate the equipment.

Note

\*This device complies with Part 15 of the FCC Rules. Operation is subject to the following two conditions:

(1) this device may not cause harmful interference, and (2) this device must accept any interference received, including interference that may cause undesired operation.

(CANADA)

This device complies with RSS-210 of Industry CANADA. Operation is subject to the following two conditions: (1) this device may not cause interference, and (2) this device must accept any interference, including interference that may cause undesired operation of the device.

(MEXICO)

Este equipo opera a título secundario, consecuentemente, debe aceptar interferencias perjudiciales incluyendo equipos de la misma clase y puede no causar interferencias a sistemas operando a título primario

Sistema de acceso normal sin llave

Modelo : SKE125-01

**Sistema de acceso normal sin llave con marcado de confirmación por radio**

**COFETEL RCPMAIM05-615**

Sistema de arranque y de acceso avanzado sin llave

Modelo : SKE11A-03

**Sistema de arranque y de acceso avanzado sin llave con marcado de confirmación por radio**

**COFETEL RCPMASK08-1067**

Knowing Your Mazda

## Doors and Locks

### ▼ Transmitter Maintenance

If the buttons on the transmitter are inoperable and the operation indicator light does not flash, the battery may be dead.

Replace with a new battery before the transmitter becomes unusable.

#### **CAUTION**

- Install the battery with the positive pole (+) facing down. Battery leakage could occur if it is not installed correctly.
- When replacing the battery, be careful not to touch any of the internal circuitry and electrical terminals, bend the electrical terminals, or get dirt in the transmitter as the transmitter could be damaged.
- There is the danger of explosion if the battery is not correctly replaced.
- Replace only with the same type battery (CR1620 or equivalent).
- Dispose of used batteries according to the following instructions.
  - Insulate the plus and minus terminals of the battery using cellophane or equivalent tape.
  - Never disassemble.
  - Never throw the battery into fire and/or water.
  - Never deform or crush.

#### **Replacing the transmitter battery**

1. Unfold the key (page 3-25).

2. Insert a screwdriver into the slot and push the tab to remove the key from the transmitter.

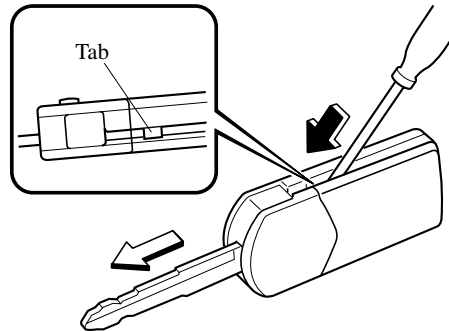

3. Insert a screwdriver into the slot and gently pry open the transmitter.

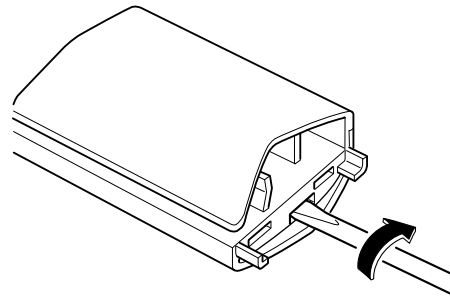

4. Remove the battery.

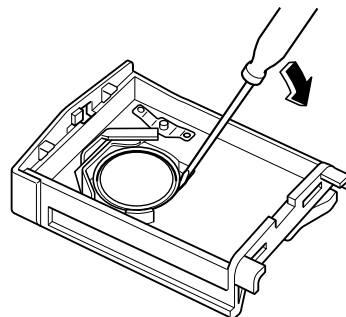



## Knowing Your Mazda Doors and Locks

- Put in the new battery (CR1620 or equivalent) with the positive pole (+) facing down.

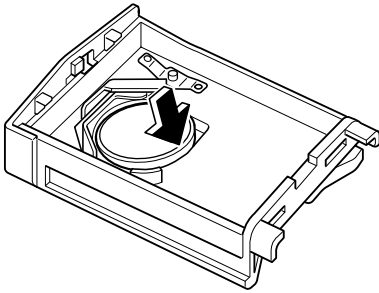

- Align the front and back covers and snap the transmitter shut.
- Align the key with the transmitter as shown in the figure, and insert the key until a click sound is heard.

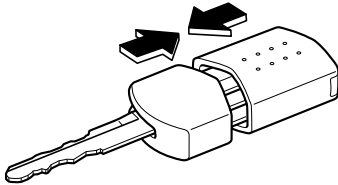

### **CAUTION**

*Insert the key into the transmitter securely until a click sound is heard. If it is not inserted securely, it could detach from the transmitter.*

### ▼ Service

If you have a problem with the keyless entry system, consult an Authorized Mazda Dealer.

If your transmitter is lost or stolen, consult an Authorized Mazda Dealer as soon as possible for a replacement and to make the lost or stolen transmitter inoperative.

### **CAUTION**

*Radio equipment like this is governed by laws in the United States. Changes or modifications not expressly approved by the party responsible for compliance could void the user's authority to operate the equipment.*

Knowing Your Mazda

## Doors and Locks

### Door Locks

#### **⚠ WARNING**

**Always take all children and pets with you or leave a responsible person with them:**

*Leaving a child or a pet unattended in a parked vehicle is dangerous. In hot weather, temperatures inside a vehicle can become high enough to cause brain damage or even death.*

**Do not leave the key in your vehicle with children and keep them in a place where your children will not find or play with them:**

*Leaving children in a vehicle with the key is dangerous. This could result in someone being badly injured or even killed.*

**Keep all doors locked when driving:**

*Unlocked doors in a moving vehicle are dangerous. Passengers can fall out if a door is accidentally opened and can more easily be thrown out in an accident.*

**Always close all the windows and the moonroof, lock the doors and take the key with you when leaving your vehicle unattended:**

*Leaving your vehicle unlocked is dangerous as children could lock themselves in a hot vehicle, or become trapped by climbing into the trunk, which could result in death. Also, a vehicle left unlocked becomes an easy target for thieves and intruders.*

**After closing the doors, always verify that they are securely closed:**

*Doors not securely closed are dangerous, if the vehicle is driven with a door not securely closed, the door could open unexpectedly resulting in an accident.*

**Always confirm the safety around the vehicle before opening a door:**

*Suddenly opening a door is dangerous. A passing vehicle or a pedestrian could be hit and cause an accident.*

#### ▼ Locking, Unlocking with Key

The driver's door can be locked/unlocked with the key.

Turn the key toward the front to lock, toward the back to unlock.

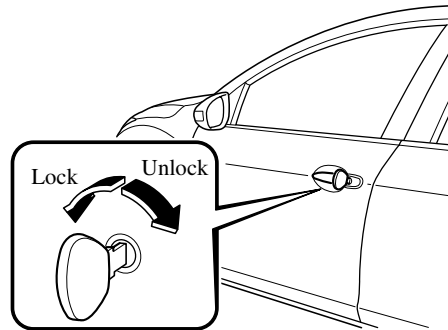

#### **NOTE**

*If your vehicle is equipped with a front passenger door key cylinder, the door can be locked/unlocked with the key.*

## Knowing Your Mazda Doors and Locks

### ▼ Locking, Unlocking with Request Switch (with Advanced Key)

The doors can be locked/unlocked by operating the request switch while carrying the advanced key outside the vehicle, refer to Operations Using Advanced Keyless Functions (page 3-7).

### ▼ Locking, Unlocking with Transmitter (with Advanced Key)

The doors can be locked/unlocked by operating the keyless entry system transmitter, refer to Keyless Entry System (page 3-16).

### ▼ Locking, Unlocking with Transmitter (with Retractable Type Key)

The doors can be locked/unlocked by operating the keyless entry system transmitter, refer to Keyless Entry System (page 3-26).

### ▼ Locking, Unlocking with Door-Lock Knob

To lock any door from the inside, press the door-lock knob.  
To unlock, pull it outward.  
This does not operate the other door locks.

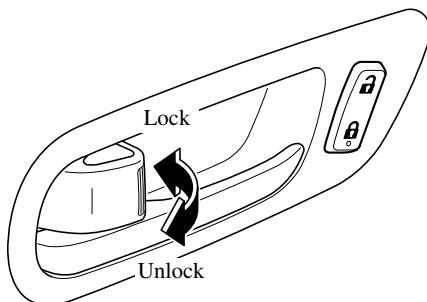

To lock the front passenger door with the door-lock knob from the outside, press the door-lock knob to the lock position and close the door.  
This does not operate the other door locks.

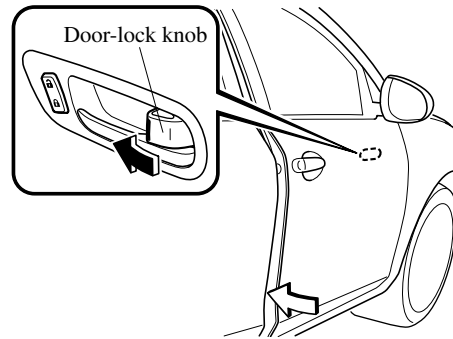

#### NOTE

- When locking the doors this way, be careful not to leave the key inside the vehicle.
- **(With advanced key)**  
The driver's door cannot be locked using the door-lock knob from the outside.
- **(Without advanced key)**  
The driver's door cannot be locked using the door-lock knob from the outside if the key is in the ignition switch.
- The red indication can be seen when the door-lock knob is unlocked.

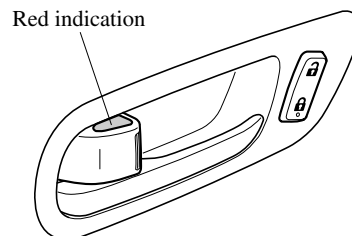

Knowing Your Mazda

## Doors and Locks

### ▼ Power Door Locks\*

#### Vehicle lock-out prevention

##### **(With advanced key)**

The vehicle lock-out prevention feature prevents you from locking yourself out of the vehicle. All doors and the liftgate will automatically unlock if they are locked using the power door locks with any door or the liftgate open.

##### **(Without advanced key)**

The vehicle lock-out prevention feature prevents you from locking yourself out of the vehicle. With the key in the ignition switch, all doors and the liftgate will automatically unlock if they are locked using the power door locks with any door or the liftgate open.

#### Locking, unlocking with key

All doors and the liftgate lock automatically when any front door is locked with the key.

All doors and the liftgate unlock when the driver's door is unlocked and the key is held in the unlock position for one second or longer.

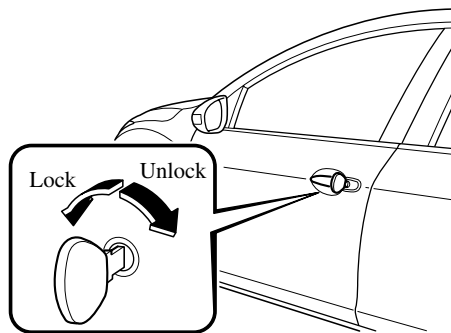

#### **NOTE**

- Holding the key in the unlocked position in the driver's door lock for about a second unlocks all doors and the liftgate. To unlock only the driver's door, insert the key into the driver's door lock and turn the key briefly to the unlock position and then immediately return it to the center position.
- The system can be set to unlock all doors by performing a single operation. Refer to Personalization Features on page 10-13.

#### Locking, unlocking with door-lock switch

All doors and the liftgate lock automatically when lock side is pressed. They all unlock when unlock side is pressed.

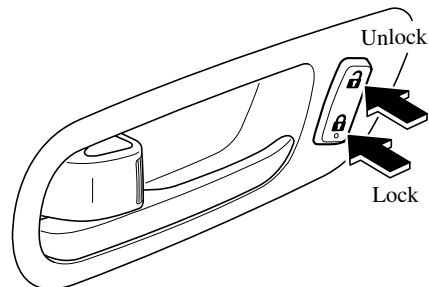

#### Locking, unlocking with request switch (with advanced key)

All doors and the liftgate can be locked/unlocked by operating the request switch on the front doors and the liftgate while carrying the advanced key outside the vehicle, refer to Operations Using Advanced Keyless Functions (page 3-7).

## Doors and Locks

### **Locking, unlocking with transmitter (with advanced key)**

All doors and the liftgate can be locked/unlocked by operating the keyless entry system transmitter, refer to Keyless Entry System (page 3-16).

### **Locking, unlocking with transmitter (with retractable type key)**

All doors and the liftgate can be locked/unlocked by operating the keyless entry system transmitter, refer to Keyless Entry System (page 3-26).

### **Auto lock/unlock function**

#### **⚠ WARNING**

**Do not pull the inner handle on a front door:**

*Pulling an inner handle on a front door while the vehicle is moving is dangerous. Passengers can fall out of the vehicle if a front door accidentally opens, which could result in death or serious injury.*

- When the vehicle speed exceeds 20 km/h (12 mph), all doors and the liftgate lock automatically.
- When the ignition is switched off, all doors and the liftgate unlock automatically.

These functions can also be disabled so that they do not operate.

### **Auto lock/unlock function setting change using door-lock switch**

The doors and the liftgate can set to lock or unlock automatically by selecting any one of the functions from the following table and using the driver's door-lock switch on the interior to perform the setting change as indicated in the procedure which follows.

Settings can be changed using the following operation.

| Function number | Function *1   |
|-----------------|---|
| 1               | The auto door-lock function is disabled.  |
| 2               | All the doors and the liftgate lock automatically when the vehicle speed is about 20 km/h (12 mph) or more.   |
| 3               | All the doors and the liftgate lock automatically when the vehicle speed is about 20 km/h (12 mph) or more. All the doors and the liftgate unlock when the ignition is switched from ON to ACC or Off.  |
| 4               | <b>(Automatic transaxle vehicles only)</b><br>When the ignition is switched ON and the shift lever is shifted from park (P) to any other gear position, all the doors and the liftgate lock automatically.  |
| 5               | <b>(Automatic transaxle vehicles only)</b><br>When the ignition is switched ON and the shift lever is shifted from park (P) to any other gear position, all the doors and the liftgate lock automatically.<br>When the shift lever is shifted to park (P) while the ignition is switched ON, all the doors and the liftgate unlock automatically. |

\*1 Other settings for the auto door lock function are available at an Authorized Mazda Dealer. For details consult an Authorized Mazda Dealer. Refer to Personalization Features on page 10-13.

1. Stop the vehicle and close all the doors.
2. Switch the ignition ON.
3. Press and hold the lock side of the driver's door-lock switch within 10 seconds of switching the ignition ON, and make sure a beep sound is heard about eight seconds afterwards.

Knowing Your Mazda

## Doors and Locks

- Referring to the auto lock/unlock function setting table, determine the function number for the desired setting and press the unlock side of the driver's door-lock switch only in the amount of the selected function number (Ex. If you select function 2, press the unlock side of the switch only 2 times).

### NOTE

*There are only a total of five auto lock/unlock settings available for automatic transaxle vehicles, and three for manual transaxle vehicles. Be sure to press the unlock side of the driver's door-lock switch the correct number of times according to the selected function number. If the switch is mistakenly pressed six times on an automatic transaxle vehicle or four times on a manual transaxle, the procedure will be invalidated. If this occurs, start the procedure from the beginning.*

- Three seconds after the function setting has been changed, a beep sound will beep in the amount of the selected function number.

### (Manual transaxle vehicles)

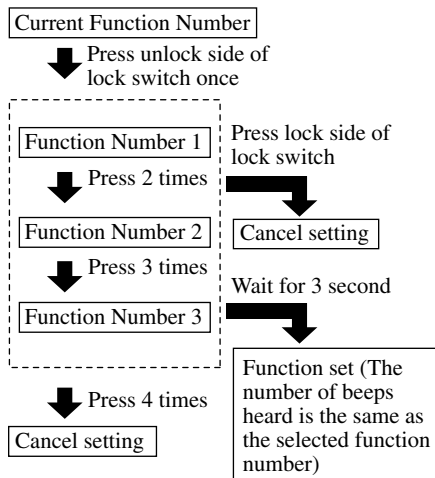

## Knowing Your Mazda Doors and Locks

### (Automatic transaxle vehicles)

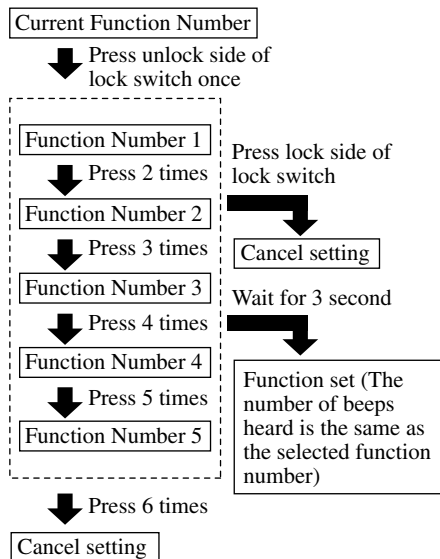

### NOTE

- The doors cannot be locked or unlocked while the setting function is being performed.
- The procedure can be cancelled by pressing the lock side of the driver's door-lock switch.

### ▼ Rear Door Child Safety Locks

These locks are intended to help prevent children from accidentally opening the rear doors. Use them both whenever a child rides in the vehicle.

If you slide the child safety lock to the lock position before closing that door, the door cannot be opened from the inside. The door can be opened only by pulling the outside handle.

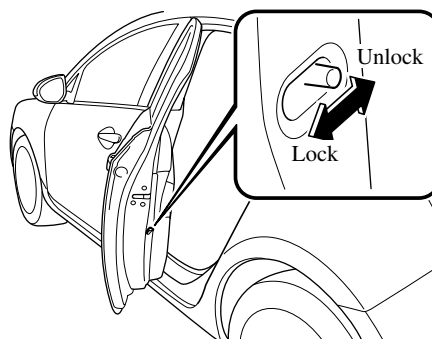

Knowing Your Mazda

## Doors and Locks

### Liftgate (5 Door)

#### **⚠ WARNING**

**Never allow a person to ride in the luggage compartment:**

*Allowing a person to ride in the luggage compartment is dangerous. The person in the luggage compartment could be seriously injured or killed during sudden braking or a collision.*

**Do not drive with the liftgate open:**

*Exhaust gas in the cabin of a vehicle is dangerous. An open liftgate in a moving vehicle will cause exhaust gas to be drawn into the cabin. This gas contains CO (carbon monoxide), which is colorless, odorless, and highly poisonous, and it can cause loss of consciousness and death. Moreover, an open liftgate could cause occupants to fall out in an accident.*

#### **⚠ CAUTION**

*Be careful not to apply excessive force to the damper stay on the liftgate such as by putting your hand on the stay. Otherwise, the damper stay may bend and affect the liftgate operation.*

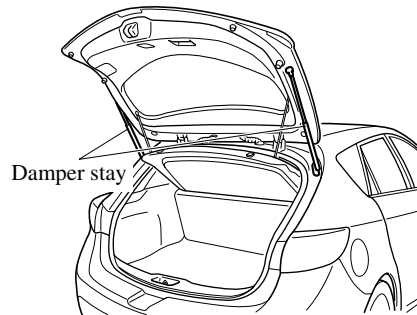

#### **▼ Locking, Unlocking with Key**

The liftgate can be locked/unlocked by inserting the key into the driver's door key cylinder, refer to Power Door Locks (page 3-34).

#### **▼ Locking, Unlocking with Request Switch (with Advanced Key)**

The liftgate can be locked/unlocked by operating the request switch while carrying the advanced key outside the vehicle, refer to Operations Using Advanced Keyless Functions (page 3-7).

#### **▼ Locking, Unlocking with Transmitter (with Advanced Key)**

The liftgate can be locked/unlocked by operating the keyless entry system transmitter, refer to Keyless Entry System (page 3-16).



## Knowing Your Mazda Doors and Locks

### ▼ Locking, Unlocking with Transmitter (with Retractable Type Key)

The liftgate can be locked/unlocked by operating the keyless entry system transmitter, refer to Keyless Entry System (page 3-26).

### ▼ Locking, Unlocking with Door-Lock Knob

The liftgate can be locked/unlocked by operating the driver's door-lock knob, refer to Power Door Locks (page 3-34).

### ▼ Locking, Unlocking with Door-Lock Switch

The liftgate can be locked/unlocked by operating the door-lock switch, refer to Power Door Locks (page 3-34).

### ▼ Opening and Closing the Liftgate

#### **NOTE**

*(With advanced key)*

*When using the advanced keyless function to open the liftgate, refer to Opening the liftgate (page 3-11).*

### Opening the liftgate

Grasp the lower end of the liftgate, press the electric liftgate opener on the liftgate, and then raise the liftgate when the latch releases.

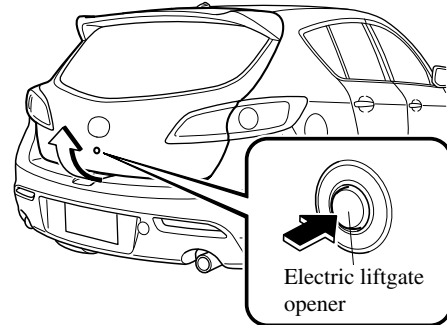

While the ignition is switched ON, the liftgate can be opened only when the vehicle is stopped with the parking brake applied (manual transaxle), or with the selector lever in the P position (automatic transaxle).

Knowing Your Mazda

## Doors and Locks

### NOTE

- *When the liftgate is unlocked by pressing the electric liftgate opener button, the liftgate raises slightly to allow it to be opened. If the liftgate is not operated for a certain period of time after the electric liftgate opener button has been pressed, the liftgate cannot be raised any more from its slightly raised position. Press the electric liftgate opener button again to fully open the liftgate. To close the liftgate from its slightly raised position, open it first by pressing the electric liftgate opener button and wait for 1 second or longer, then close it.*

*The door-ajar warning light will illuminate if the liftgate is not fully closed.*

- *The sound of the latch may be heard for a few seconds after the electric liftgate opener has been pressed, however, this does not indicate a malfunction.*

### **When the liftgate cannot be opened**

If the vehicle battery is dead or there is a malfunction in the electrical system and the liftgate cannot be unlocked, perform the following procedure as an emergency measure to unlock it:

1. Fold down the rear seatbacks.  
Refer to Split-Folding Rear Seatback on page 2-8.

2. Remove the cap on the interior surface of the liftgate with a flathead screwdriver.

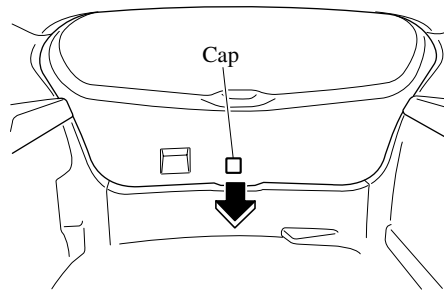

3. Turn the lever to the right to unlock the liftgate.

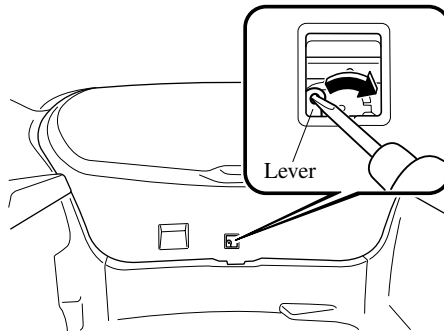

After performing this emergency measure, have the vehicle inspected at an Authorized Mazda Dealer as soon as possible.

### **Closing the liftgate**

To close, lower the liftgate slowly using the liftgate grip recess, and then push the liftgate closed using both hands.

## Knowing Your Mazda Doors and Locks

Do not slam it. Pull up on the liftgate to make sure it is secure.

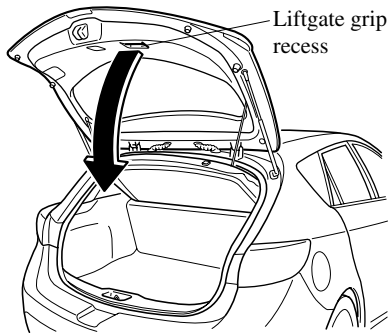

### ▼ Luggage Compartment

#### ⚠ WARNING

**Do not place anything on top of the cover:**

*Placing luggage or other cargo on top of the luggage compartment cover is dangerous. During sudden braking or a collision, the cargo could become a projectile that could hit and injure someone. The vehicle has a light weight luggage compartment cover to keep the contents of your luggage area out of sight; it will not retain heavy objects that are not tied down in an accident such as a rollover. Tie down all heavy objects, whether luggage or cargo, using the tie down hooks.*

**Make sure luggage and cargo are secured before driving:**

*Not securing cargo while driving is dangerous as it could move or be crushed during sudden braking or a collision and cause injury.*

#### ⚠ CAUTION

*Make sure the luggage compartment cover is firmly secured. If it is not firmly secured, it could unexpectedly disengage resulting in injury.*

#### Luggage compartment cover strap

The luggage compartment can be accessed by opening the liftgate when the straps are attached to the sides of the liftgate.

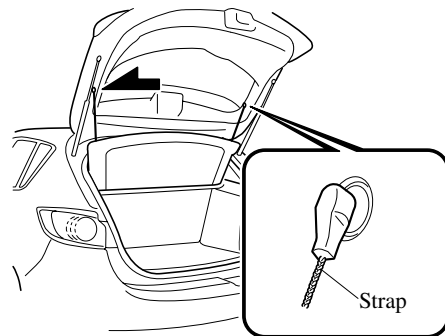

#### Luggage compartment cover

This cover can be removed for more room. To do this, just unfasten the straps; then lift and pull it out.

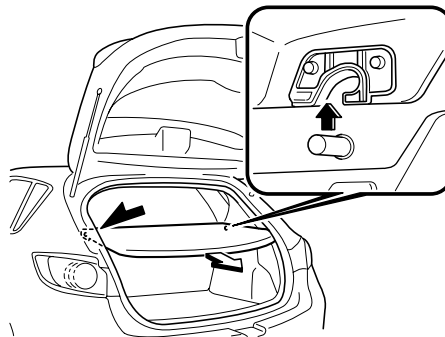

Knowing Your Mazda

## Doors and Locks

### Trunk Lid (4 Door)

#### **WARNING**

**Never allow a person to ride in the trunk:**

*Allowing a person to ride in the trunk is dangerous. In addition, the person in the trunk could be seriously injured or killed during sudden braking or a collision.*

**Keep the trunk closed when driving:**

*Exhaust gas entering the cabin of a vehicle through an open trunk is dangerous. This gas contains CO (carbon monoxide), which is colorless, odorless, and highly poisonous. If inhaled, it can cause loss of consciousness and death.*

### ▼ Opening and Closing the Trunk Lid

#### **WARNING**

**Close the trunk lid, be sure the seat backs are latched and do not allow children to play inside the vehicle:**

*Leaving the trunk lid open or leaving children in the vehicle with the keys is dangerous. Children could open the trunk lid and climb inside resulting in possible injury or death from heat exposure.*

**Always keep the car from being a tempting place to play by latching the rear seats, doors and the trunk, and keeping the keys where children can not play with them:**

*Leaving children or animals unattended in a parked vehicle is dangerous. Babies left sleeping and children who lock themselves in cars or trunks can die very quickly from heat prostration. Do not leave your children or pets alone in a car at any time. Do not leave the car, the rear folding seats or the trunk unlocked.*

#### **CAUTION**

*For vehicles equipped with a rear spoiler, do not raise or lower the trunk lid using the spoiler. Otherwise, the rear spoiler and the trunk lid could be damaged.*

## Knowing Your Mazda Doors and Locks

### **Opening the trunk lid with the key \***

Insert the key into the slot and turn it clockwise.

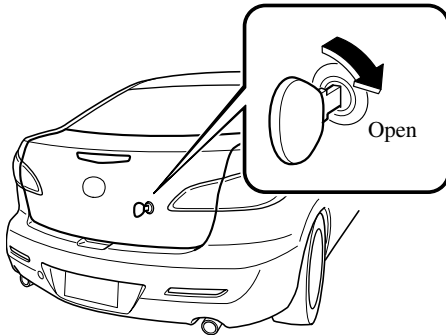

### **Opening the trunk lid with the electric trunk lid opener (with advanced key)**

The trunk lid can be opened by operating the request switch on the trunk lid while carrying the advanced key outside the vehicle, refer to Operations Using Advanced Keyless Functions (page 3-7).

### **Opening the trunk lid with the transmitter (with advanced key)**

The trunk lid can be opened by operating the keyless entry system transmitter, refer to Keyless Entry System (page 3-16).

### **Opening the trunk lid with the transmitter (with retractable type key)**

The trunk lid can be opened by operating the keyless entry system transmitter, refer to Keyless Entry System (page 3-26).

### **Opening the trunk lid with the remote release lever**

Pull up the release lever next to the driver's seat.

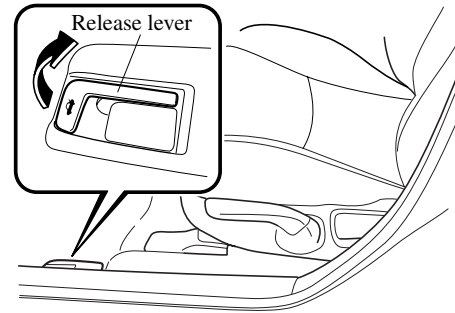

### **Closing the trunk lid**

Use both hands to push the trunk lid down until the lock snaps shut. Do not slam it. Pull up on the trunk lid to make sure it is secure.

### **▼ Trunk Light**

The trunk light is on when the lid is open and off when it's closed.

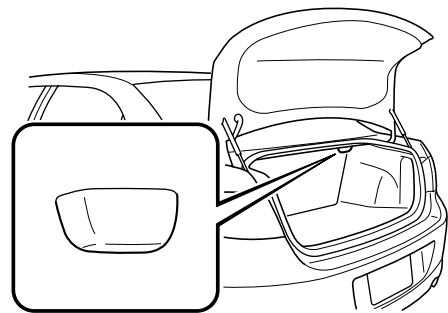

Knowing Your Mazda

## Doors and Locks

---

### NOTE

- *To prevent the battery from being discharged, do not leave the trunk open for a long period when the engine is not running.*
- **(Battery saver)**  
*If the lid is left open, the trunk light turns off after about 30 minutes to prevent battery depletion.*

### Inside Trunk Release Lever

Your vehicle is equipped with an inside trunk release lever that provides a means of escape for children and adults in the event they become locked inside the trunk.

No matter how careful adults might be with keys and locking their cars, parents should be aware that children may be tempted to play around vehicles and use the trunk as a hiding place.

Adults are advised to familiarize themselves with the operation and location of the inside trunk release lever so that all children can be told about it in an appropriate way, keeping in mind that most vehicles do not have such levers.

Knowing Your Mazda  
**Doors and Locks**

**⚠ WARNING**

**Close the trunk lid, be sure the seat backs are latched and do not allow children to play inside the vehicle:**

*Leaving the trunk lid open or leaving children in the vehicle with the keys is dangerous. Children could open the trunk lid and climb inside resulting in possible injury or death from heat exposure.*

**Always keep the car from being a tempting place to play by latching the rear seats, doors and the trunk, and keeping the keys where children can not play with them:**

*Leaving children or animals unattended in a parked vehicle is dangerous. Babies left sleeping and children who lock themselves in cars or trunks can die very quickly from heat prostration. Do not leave your children or pets alone in a car at any time. Do not leave the car, the rear folding seats or the trunk unlocked.*

**▼ Opening the Trunk Lid from the Inside**

Slide the inside trunk release lever in the direction of the arrow. The lever is made of material that will glow for hours in the darkness of the trunk following a brief exposure to ambient light.

The inside trunk release lever is located on the inside of the trunk lid.

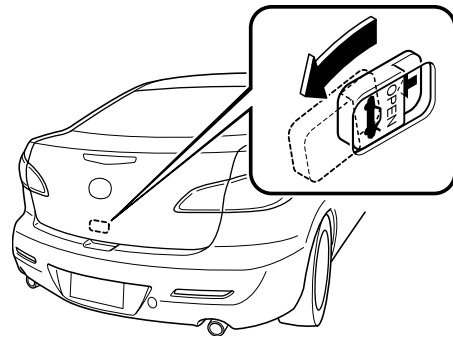

Knowing Your Mazda

## Doors and Locks

### Power Windows

The ignition must be switched ON for the power windows to operate.

#### **⚠ WARNING**

***Make sure the opening is clear before closing a window:***

*Closing power windows are dangerous. A person's hands, head, or even neck could be caught by the window and result in serious injury or even death.*

*This warning applies especially to children.*

***Never allow children to play with power window switches:***

*Power window switches that are not locked with the power window lock switch would allow children to operate power windows unintentionally which could result in serious injury if a child's hands, head or neck becomes caught by the window.*

#### **⚠ CAUTION**

*To prevent burning out the fuse and damaging the power window system, do not open or close more than three windows at once.*

### ▼ Operating the Driver's Side Power Window

#### **Normal opening/closing**

To open the window to the desired position, lightly hold down the switch.

To close the window to the desired position, lightly pull up the switch.

#### **Master control switches**

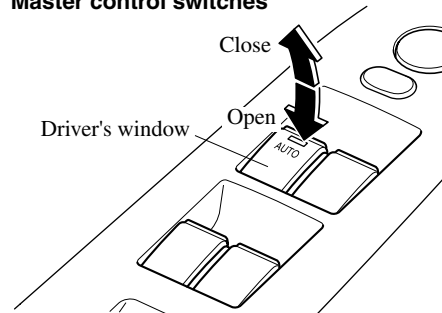

#### **Auto-opening/closing**

To fully open the window automatically, press the switch completely down, then release. The window will fully open automatically.

To fully close the window automatically, pull the switch completely up, then release. The window will fully close automatically.

To stop the window partway, pull or press the switch in the opposite direction and then release it.



Knowing Your Mazda  
**Doors and Locks**

**Power window system initialization procedure**

If the battery was disconnected during vehicle maintenance, or for other reasons (such as a switch continues to be operated after the window is fully open/closed), the window will not fully open and close automatically. Carry out the following procedure to resume operation:

1. Switch the ignition ON.
2. Press the switch and fully open the window.
3. Pull up the switch to fully close the window and continue holding the switch for about 2 seconds after the window fully closes.

**Jam-safe window**

If a person's hands, head or an object blocks the window during the auto-closing operation, the window will stop and open halfway.

**! WARNING**

***Make sure nothing blocks the window just before it reaches the fully closed position or while holding up the power window switch:***

*Blocking the power window just before it reaches the fully closed position or while holding up the power window switch is dangerous. In this case, the jam-safe function cannot prevent the window from closing all the way. If fingers are caught, serious injuries could occur.*

**NOTE**

*Depending on driving conditions, a closing power window could stop and start opening when the window feels a shock that is similar to something blocking it.*

*In the event the jam-safe function activates and the power window cannot be closed automatically, pull and hold the switch and the window will close.*

**Engine-off power window operation**

The power window can be operated for about 45 seconds after the ignition is switched from ON to ACC or OFF with all doors closed. If any door is opened, the power window will be inoperable.

**NOTE**

*For engine-off operation of the power window, the switch must be held up firmly throughout window closure because the auto-closing function will be inoperable.*

Knowing Your Mazda

## Doors and Locks

### ▼ Operating the Passenger Power Windows

The power windows may be operated when the power window lock switch on the driver's door is in the unlocked position.

The passenger windows may be opened or closed using the master control switches on the driver's door.

#### Master control switches

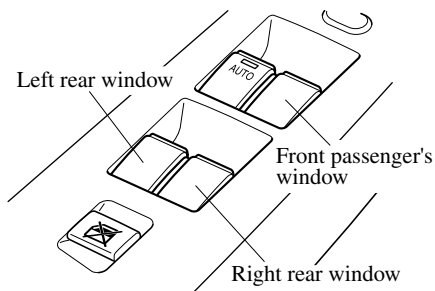

To open the window to the desired position, hold down the switch.  
To close the window to the desired position, pull up the switch.

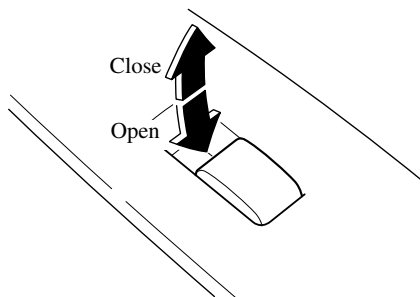

### ▼ Power Window Lock Switch

This feature prevents all power windows from operating, except the driver's power window. Keep this switch in the locked position while children are in the vehicle.

#### **Locked position (button depressed):**

Only the driver's power window can be operated.

#### **Unlocked position (button not depressed):**

All power windows on each door can be operated.

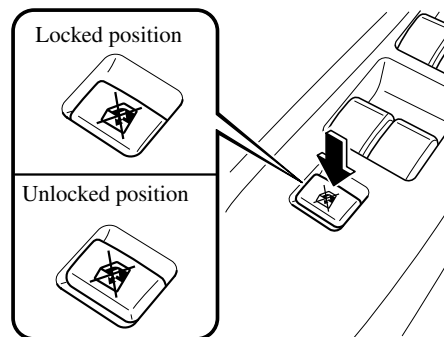

## Knowing Your Mazda Doors and Locks

### Fuel-Filler Lid and Cap

#### **⚠ WARNING**

*When removing the fuel-filler cap, loosen the cap slightly and wait for any hissing to stop. Then remove it:*

*Fuel spray is dangerous. Fuel can burn skin and eyes and cause illness if ingested. Fuel spray is released when there is pressure in the fuel tank and the fuel-filler cap is removed too quickly.*

*Before refueling, stop the engine, and always keep sparks and flames away from the filler neck:*

*Fuel vapor is dangerous. It could be ignited by sparks or flames causing serious burns and injuries.*

*Additionally, use of the incorrect fuel-filler cap or not using a fuel-filler cap may result in fuel leak, which could result in serious burns or death in an accident.*

#### **⚠ CAUTION**

*Always use only a genuine Mazda fuel-filler cap or an approved equivalent, available at an Authorized Mazda Dealer. The wrong cap can result in a serious malfunction of the fuel and emission control systems. It may also cause the check engine light in the instrument cluster to illuminate.*

#### ▼ Fuel-Filler Lid

To open, pull the remote fuel-filler lid release.

##### 5 door

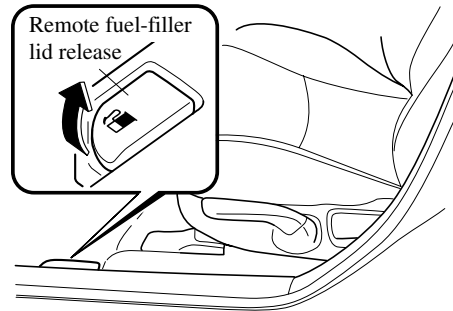

##### 4 door

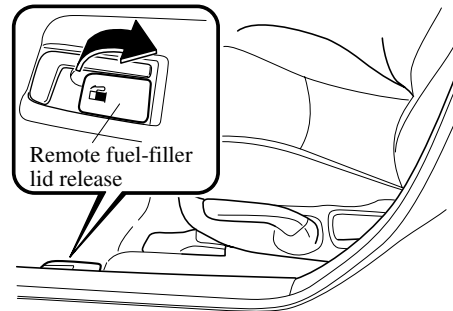

#### ▼ Fuel-Filler Cap

To remove the fuel-filler cap, turn it counterclockwise. Attach the removed cap to the inner side of the fuel lid.

Knowing Your Mazda

## Doors and Locks

To close the fuel-filler cap, turn it clockwise until a click is heard.

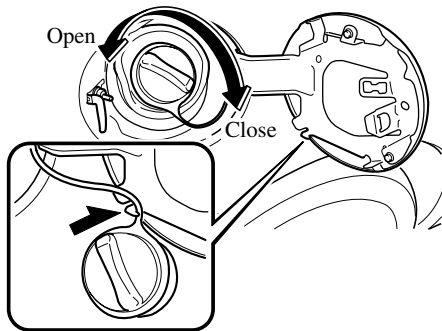

### **CAUTION**

*If the check fuel cap warning light illuminates, the fuel-filler cap may not be properly installed. If the warning light illuminates, park your vehicle safely off the right-of-way, remove the fuel-filler cap and reinstall it correctly. After the cap has been correctly installed, the fuel cap warning light may continue to illuminate until a number of driving cycles have been completed. A drive cycle consists of starting the engine (after four or more hours with the engine off) and driving the vehicle on city and highway roads. Continuing to drive with the check fuel cap warning light illuminated could cause the check engine light to illuminate as well.*

## Hood

### **WARNING**

**Always check that the hood is closed and securely locked:**

*A hood that is not closed and securely locked is dangerous as it could fly open while the vehicle is moving and block the driver's vision which could result in a serious accident.*

### ▼ Opening the Hood

1. With the vehicle parked, pull the release handle to unlock the hood.

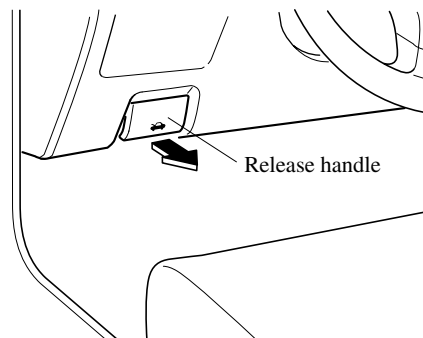

2. Insert your hand into the hood opening, slide the hood latch lever, and lift the hood.

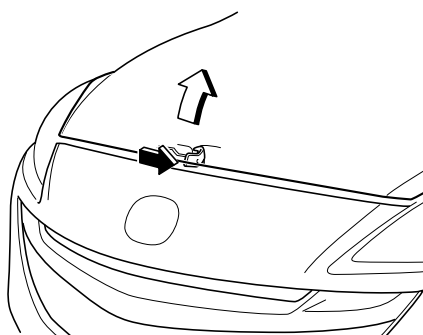

## Knowing Your Mazda Doors and Locks

3. Grasp the support rod in the padded area and secure it in the support rod hole indicated by the arrow to hold the hood open.

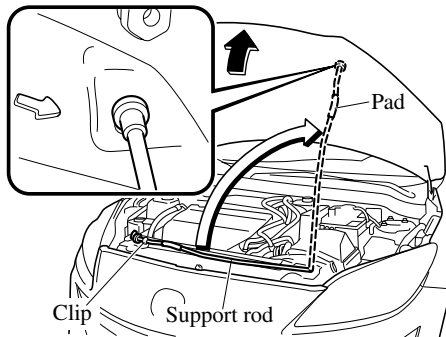

### ▼ Closing the Hood

1. Check under the hood area to make certain all filler caps are in place and all loose items (e.g. tools, oil containers, etc.) have been removed.
2. Lift the hood, grasp the padded area on the stay, and secure the stay in the clip. Verify that the support rod is secured in the clip before closing the hood.

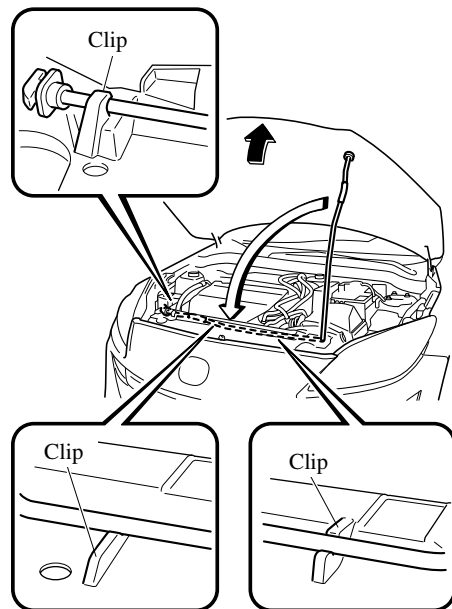

3. Lower the hood slowly from a height of about 20 cm (7.9 in) above its closed position and then let it drop.

### **⚠ CAUTION**

*When closing the hood, do not push it excessively such as by applying your weight. Otherwise, the hood could be deformed.*

Knowing Your Mazda

## Doors and Locks

### Moonroof\*

The moonroof can be opened or closed electrically only when the ignition is switched ON.

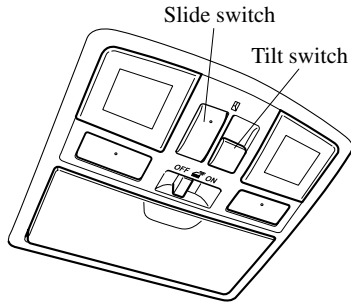

### ⚠ WARNING

**Do not let passengers stand up or extend part of their body through the open moonroof while the vehicle is moving:**

*Extending the head, arms, or other parts of the body through the moonroof is dangerous. The head or arms could hit something while the vehicle is moving. This could cause serious injury or death.*

**Make sure the opening is clear before closing the moonroof:**

*A closing moonroof is dangerous. The hands, head, or even neck of a person, especially a child, could be caught in it as it closes, causing serious injury or even death.*

### NOTE

*Before washing your Mazda, make sure the moonroof is completely closed so that water does not get inside the cabin area. After washing your Mazda or after it rains, wipe the water off the moonroof before operating it to avoid water penetration which could cause rust and water damage to your headliner.*

### ▼ Tilt Operation

The rear of the moonroof can be tilted open to provide more ventilation.

To fully tilt automatically, momentarily press the tilt switch.

To stop tilting partway, press any part of the tilt or slide switch.

To close to the desired position, press the front of the slide switch or pull the tilt switch.

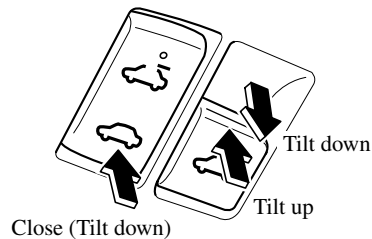

### ▼ Slide Operation

To fully open automatically, momentarily press the rear of the slide switch.

To stop sliding partway, press any part of the tilt or slide switch.

## Knowing Your Mazda Doors and Locks

To close to the desired position, press the front of the slide switch or pull the tilt switch.

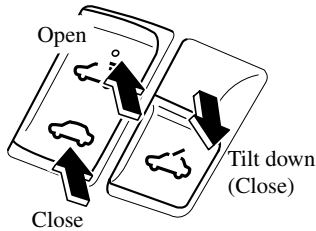

### ▼ Power Moonroof Re-set Procedure

If the battery is disconnected, the moonroof will not operate. The moonroof will not operate correctly until it is re-set. Carry out the following procedure to re-set the moonroof and resume operation:

1. Switch the ignition ON.
2. Press the tilt switch while the rear of the moonroof tilts open to the fully open position. The moonroof then closes a little.

#### **NOTE**

*If the re-set procedure is performed while the moonroof is in the slide position (partially open) it closes before the rear tilts opens.*

### ▼ Sunshade

The sunshade can be opened and closed by hand.

The sunshade opens automatically when the moonroof is opened, but must be closed by hand.

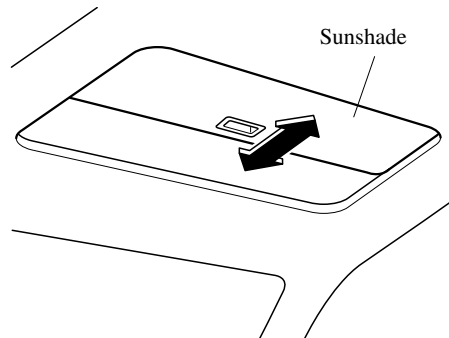

### **CAUTION**

- *The sunshade does not tilt. To avoid damaging the sunshade, do not push up on it.*
- *Do not close the sunshade while the moonroof is opening. Trying to force the sunshade closed could damage it.*

Knowing Your Mazda

## Security System

### Immobilizer System (with Advanced Key)

The immobilizer system allows the engine to start only with an advanced key the system recognizes.

If someone attempts to start the engine with an unrecognized advanced key, the engine will not start, thereby helping to prevent the theft of your vehicle. If you have a problem with the immobilizer system or the advanced key (including auxiliary key), consult an Authorized Mazda Dealer.

#### **CAUTION**

- *Radio equipment like this is governed by laws in the United States. Changes or modifications not expressly approved by the party responsible for compliance could void the user's authority to operate the equipment.*
- *To avoid damage to the key, do not:*
  - *Drop the key.*
  - *Get the key wet.*
  - *Expose the key to any kind of magnetic field.*
  - *Expose the key to high temperatures on places such as the dashboard or hood, under direct sunlight.*

#### **CAUTION**

*Do not allow the following when starting the engine with the auxiliary key due to an advanced key dead battery or other malfunction. Otherwise the signal from the auxiliary key will not be received correctly and the engine may not start.*

- *A key ring rests on the auxiliary key grip.*

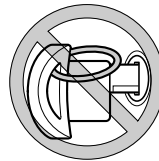

- *Metal parts of other keys or metal objects touch the auxiliary key grip.*

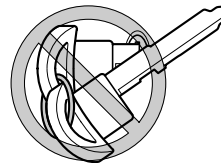

- *Spare auxiliary keys or keys for other vehicles equipped with an immobilizer system touch or come near the auxiliary key.*

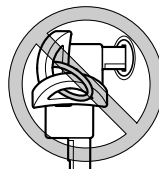



Knowing Your Mazda  
**Security System**

---

- *Devices for electronic purchases, or security passage which touch or come near the auxiliary key.*

**NOTE**

- *The advanced keys (including auxiliary key) carry a unique electronic code. For this reason, and to assure your safety, obtaining a replacement advanced key (including auxiliary key) requires some waiting time. They are only available through an Authorized Mazda Dealer.*
- *Always keep a spare advanced key in case one is lost. If an advanced key is lost, consult an Authorized Mazda Dealer as soon as possible.*
- *If you lose an advanced key (including auxiliary key), an Authorized Mazda Dealer will reset the electronic codes of your remaining advanced keys (including auxiliary keys) and immobilizer system. Bring all the remaining advanced keys (including auxiliary keys) to an Authorized Mazda Dealer to reset. Starting the vehicle with a key that has not been reset is not possible.*

Knowing Your Mazda

## Security System

---

### Declaration of Conformity

#### **Immobilizer system**

(U.S.A)

FCC WARNING

Changes or modifications not expressly approved by the party responsible for compliance could void the user's authority to operate the equipment.

Note

\*This device complies with Part 15 of the FCC Rules. Operation is subject to the following two conditions:

(1) this device may not cause harmful interference, and (2) this device must accept any interference received, including interference that may cause undesired operation.

(CANADA)

This device complies with RSS-210 of Industry CANADA. Operation is subject to the following two conditions: (1) this device may not cause interference, and (2) this device must accept any interference, including interference that may cause undesired operation of the device.

(MEXICO)

Este equipo opera a título secundario, consecuentemente, debe aceptar interferencias perjudiciales incluyendo equipos de la misma clase y puede no causar interferencias a sistemas operando a título primario

Sistema inmovilizador

Modelo : IMB111-01

**Sistema inmovilizador con marcado de confirmación por radio**

**COFETEL RCPMAIM05-616**

## Knowing Your Mazda Security System

### ▼ Operation

#### Arming

The system is armed when the ignition is switched from ON to ACC or OFF. The security indicator light in the instrument cluster flashes every 2 seconds until the system is disarmed.



#### Disarming

The system is disarmed when the ignition is switched ON with the registered advanced key.

The security indicator light illuminates for about 3 seconds and goes out.

If the engine does not start with the correct advanced key, and the security indicator light keeps illuminating or flashing, the system may have a malfunction. Consult an Authorized Mazda Dealer.

#### **NOTE**

- *The engine may not start and the security indicator light may illuminate or flash if the advanced key is placed in an area where it is difficult for the system to detect the signal, such as on the dashboard, or in the glove box. Move the advanced key to another place, switch the ignition off, and then restart the engine.*
- *Signals from a TV or radio station, or from a transceiver or a mobile telephone could interfere with your immobilizer system. If you are using the proper advanced key and the engine fails to start, check the security indicator light. If the indicator light is flashing, switch the ignition to ACC or switch the ignition off and wait for a while, then restart the engine. If it does not start after 3 or more tries, contact an Authorized Mazda Dealer.*
- *If the security indicator light flashes continuously while you are driving, do not shut off the engine. Go to an Authorized Mazda Dealer and have it checked. If the engine is shut off while the indicator light is flashing, you will not be able to restart it.*
- *Since the electronic codes are reset when repairing the immobilizer system, the advanced key (including auxiliary key) are needed. Bring all the advanced keys (including auxiliary keys) to an Authorized Mazda Dealer.*

Knowing Your Mazda

## Security System

### ▼ Modification and Add-On Equipment

Mazda cannot guarantee the immobilizer system's operation if the system has been modified or if any add-on equipment has been installed.

#### CAUTION

*To avoid damage to your vehicle, do not modify the system or install any add-on equipment to the immobilizer system or the vehicle.*

### Immobilizer System (without Advanced Key)

The immobilizer system allows the engine to start only with a key the system recognizes.

If someone attempts to start the engine with an unrecognized key, the engine will not start, thereby helping to prevent the theft of your vehicle.

If you have a problem with the immobilizer system or the key, consult an Authorized Mazda Dealer.

#### CAUTION

- *Radio equipment like this is governed by laws in the United States.  
Changes or modifications not expressly approved by the party responsible for compliance could void the user's authority to operate the equipment.*
- *To avoid damage to the key, do not:*
  - *Drop the key.*
  - *Get the key wet.*
  - *Expose the key to any kind of magnetic field.*
  - *Expose the key to high temperatures on places such as the dashboard or hood, under direct sunlight.*

## Knowing Your Mazda Security System

### **CAUTION**

When starting the engine do not allow the following, as the engine may not start due to the electronic signal from the ignition key not being transmitted correctly.

- A key ring rests on the key grip.

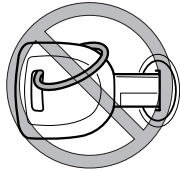

- Metal parts of other keys or metal objects touch the key grip.

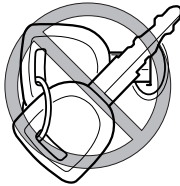

- Spare keys or keys for other vehicles equipped with an immobilizer system touch or come near the key grip.

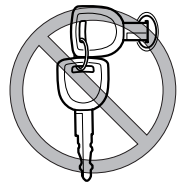

- Devices for electronic purchases, or security passage which touch or come near the key.

### **NOTE**

- The keys carry a unique electronic code. For this reason, and to assure your safety, obtaining a replacement key requires some waiting time. They are only available through an Authorized Mazda Dealer.
- Always keep a spare key, in case one is lost. If a key is lost, contact an Authorized Mazda Dealer as soon as possible.
- If you lose a key, an Authorized Mazda Dealer will reset the electronic codes of your remaining keys and immobilizer system. Bring all the remaining keys to an Authorized Mazda Dealer to reset. Starting the vehicle with a key that has not been reset is not possible.

Knowing Your Mazda

## Security System

---

### Declaration of Conformity

#### **Immobilizer system**

(U.S.A)

FCC WARNING

Changes or modifications not expressly approved by the party responsible for compliance could void the user's authority to operate the equipment.

Note

\*This device complies with Part 15 of the FCC Rules. Operation is subject to the following two conditions:

(1) this device may not cause harmful interference, and (2) this device must accept any interference received, including interference that may cause undesired operation.

(CANADA)

This device complies with RSS-210 of Industry CANADA. Operation is subject to the following two conditions: (1) this device may not cause interference, and (2) this device must accept any interference, including interference that may cause undesired operation of the device.

(MEXICO)

Este equipo opera a título secundario, consecuentemente, debe aceptar interferencias perjudiciales incluyendo equipos de la misma clase y puede no causar interferencias a sistemas operando a título primario

Sistema inmovilizador

Modelo : IMB111-01

**Sistema inmovilizador con marcado de confirmación por radio**

**COFETEL RCPMAIM05-616**

3-60

## Knowing Your Mazda Security System

### ▼ Operation

#### Arming

The system is armed when the ignition is switched from ON to ACC or OFF. The security indicator light in the instrument cluster flashes every two seconds until the system is disarmed.



#### Disarming

The system is disarmed when the ignition is switched ON with the correct ignition key.

The security indicator light illuminates for about three seconds and goes out.

If the engine does not start with the correct ignition key, and the security indicator light keeps illuminating or flashing, the system may have a malfunction. Consult an Authorized Mazda Dealer.

#### **NOTE**

- If the security indicator light illuminates and stays on or flashes when the ignition is switched ON, the engine will not start.
- Signals from a TV or radio station, or from a transceiver or a mobile telephone, could interfere with your immobilizer system. If you are using the proper key and your engine fails to start, check the security indicator light. If it is flashing, remove the ignition key and wait 2 seconds or more, then reinsert it and try starting the engine again. If it does not start after 3 or more tries, contact an Authorized Mazda Dealer.
- If the security indicator light flashes continuously while you are driving, do not shut off the engine. Go to an Authorized Mazda Dealer and have it checked. If you shut off the engine while the light is flashing you will not be able to restart it.
- Since the electronic codes are reset when repairing the immobilizer system, the keys are needed. Bring all the existing keys to an Authorized Mazda Dealer.

### ▼ Modification and Add-On Equipment

Mazda cannot guarantee the immobilizer system's operation if the system has been modified or if any add-on equipment has been installed.

#### **⚠ CAUTION**

To avoid damage to your vehicle, do not modify the system or install any add-on equipment to the immobilizer system or the vehicle.

Knowing Your Mazda

## Security System

### Theft-Deterrent System \*

If the theft deterrent system detects an inappropriate entry into the vehicle, which could result in the vehicle or its contents being stolen, the alarm alerts the surrounding area of an abnormality by sounding the horn and flashing the hazard warning lights.

Refer to Operation on page 3-62.

#### NOTE

- *The theft-deterrent system operates with the key or the keyless entry system transmitter.*
- **(With advanced key)**  
*The theft-deterrent system can also be operated using the advanced keyless function.*  
*The system operates only when the driver is in the vehicle or within operational range while the advanced key is being carried.*
- *The system will not function unless it is properly armed. To properly secure the vehicle, always make sure all windows are completely closed and all doors and the trunk lid/liftgate are locked before leaving the vehicle. Remember to take your key and transmitter.*

#### ▼ Operation

##### System triggering conditions

The horn sounds intermittently and the hazard warning lights flash for about 30 seconds when the system is triggered by any one of the following:

- Forcing open a door, the hood or the trunk lid/liftgate.
- Unlocking a door with the inside door-lock knob.
- Unlocking a door with the door lock switch.
- Opening the hood by operating the hood release handle.

- **(Without advanced key)**  
Switching the ignition ON without the key.
- **(With advanced key)**  
Switching the ignition ON without using the push button start.
- Opening the trunk lid by operating the trunk lid release lever.

If the system is triggered again, the lights and horn will activate until a door or the liftgate is unlocked or the trunk lid is opened with the key or with the transmitter.

#### **(With advanced key)**

The lights and horn can also be deactivated by pressing the request switch on a door.

#### NOTE

*If the battery goes dead while the theft-deterrent system is armed, the horn will activate and the hazard warning lights will flash when the battery is charged or replaced.*

#### ▼ How to Arm the System

1. Close the windows and the moonroof\* securely.
2. Remove the key from the ignition switch.  
**(With advanced key)**  
Press the push button start to off position, if the auxiliary key is inserted in the key slot, remove it.



## Knowing Your Mazda Security System

3. Make sure all the windows, the moonroof\*, the hood and the trunk lid are closed. Close and lock all doors and the liftgate from the outside using the key. If you have the keyless entry system, press the lock button on the transmitter.

The hazard warning lights will flash once.

The following method will also arm the theft-deterrent system:

### **(With advanced key)**

Press a request switch on the doors or the lock button on the transmitter.

### **(Without advanced key)**

Close the hood and the liftgate/trunk lid. Press the area on the door-lock switch marked “” once. Close all doors.

The security indicator light in the instrument panel flashes twice per second for 20 seconds.



The theft deterrent system can also be armed by activating the auto re-lock function with all the doors, the liftgate/trunk lid and the hood closed.

### **NOTE**

*Locking the doors with the inside door-lock knob will not arm the system.*

4. After 20 seconds, the system is fully armed.

### **NOTE**

#### • **Auto re-lock function**

*After unlocking with the transmitter or the request switch, all doors and the liftgate will automatically lock if any of the following operations are not performed within about 30 seconds.*

- *A door or the liftgate/trunk lid is opened.*
  - *The auxiliary key is inserted into the key slot (with advanced key).*
  - *The key is inserted in the ignition switch.*
  - *The push button start is in any position except off (with advanced key).*
  - *The ignition is switched ON.*
- *The system will disarm if one of the following operations takes place within 20 seconds after closing the trunk lid/hood and locking all the doors and the liftgate:*
- *Pressing the unlock button on the transmitter.*
  - *Any door or the liftgate/trunk lid is opened.*
  - *Unlocking a door with the inside door-lock knob.*
  - *Unlocking a door with the door lock switch.*
  - *Unlocking the driver's door with the key.*
  - *The hood is opened.*
  - *The key is inserted in the ignition switch.*
  - *The auxiliary key is inserted into the key slot (With advanced key).*
  - *The push button start is pressed or a door is unlocked using a request switch on the front doors (With advanced key).*
  - *The ignition is switched ON.*
- To rearm the system, do the arming procedure again.*
- *When the doors are locked by pressing the lock button on the transmitter or request switch on the front doors or using the key while the theft-deterrent system is armed, the hazard warning lights will flash once to indicate that the system is armed.*

Knowing Your Mazda

## Security System

### ▼ To Turn Off an Armed System

An armed system can be turned off by any one of the following methods:

- Unlock a door with the key.
- Press the unlock button on the keyless entry system transmitter.
- The ignition is switched ON.
- **(With advanced key)**

Press a request switch on the doors or the unlock button on the transmitter.

The hazard warning lights will flash twice to indicate that the system is turned off.

#### **NOTE**

*When the doors are unlocked by pressing the unlock button on the transmitter or request switch on the front doors or using the key while the theft-deterrent system is turned off, the hazard warning lights will flash twice to indicate that the system is turned off.*

### ▼ To Stop the Alarm

A triggered alarm can be turned off by any one of the following methods:

- Unlock a door with the key.
- Press the unlock button or press and hold the trunk button on the keyless entry system transmitter.
- The engine is started with the ignition key.
- **(With advanced key)**
  - Press a request switch on the doors.
  - Press the electric liftgate/trunk lid opener.
  - Press the unlock button or press and hold the trunk button on the transmitter.
  - The engine is started with the push button start.

#### **NOTE**

*If you have any problem with the theft-deterrent system, consult an Authorized Mazda Dealer.*

### ▼ Theft-Deterrent Labels



A label indicating that your vehicle is equipped with a Theft-Deterrent System is in the glove compartment.

Mazda recommends that you affix it to the lower rear corner of a front door window.

## Steering Wheel and Mirrors

### Steering Wheel

#### **⚠ WARNING**

**Never adjust the steering wheel while the vehicle is moving:**

*Adjusting the steering wheel while the vehicle is moving is dangerous. Moving it can very easily cause the driver to abruptly turn to the left or right. This can lead to loss of control or an accident.*

#### ▼ Steering Wheel Adjustment

To change the angle or length of the steering wheel:

1. Stop the vehicle, pull up the lock release lever under the steering column.

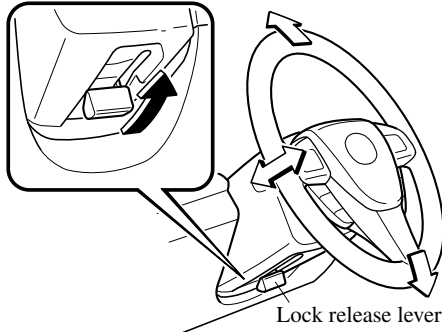

2. Tilt the steering wheel and/or adjust the steering column length to the desired positions, push the lever down to lock the column.
3. Push the wheel up and down to be certain it's locked before driving.

### Mirrors

#### ▼ Outside Mirrors

Check the mirror angles before driving.

#### Mirror type

##### **Flat type (driver's side)**

Flat surface mirror.

##### **Convex type (front passenger side)**

The mirror has single curvature on its surface.

#### **⚠ WARNING**

**Be sure to look over your shoulder before changing lanes:**

*Changing lanes without taking into account the actual distance of the vehicle in the convex mirror is dangerous. You could have a serious accident. What you see in the convex mirror is closer than it appears.*

#### Power mirror

The ignition must be switched to ACC or ON.

To adjust:

1. Press the left or right side of the selector switch to choose the left or right side mirror.

Knowing Your Mazda

## Steering Wheel and Mirrors

2. Depress the mirror switch in the appropriate direction.

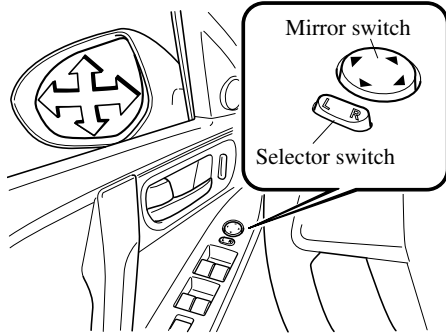

After adjusting the mirror, lock the control by placing the selector switch in the center position.

### **Folding the mirror**

Fold the outside mirror rearward until it is flush with the vehicle.

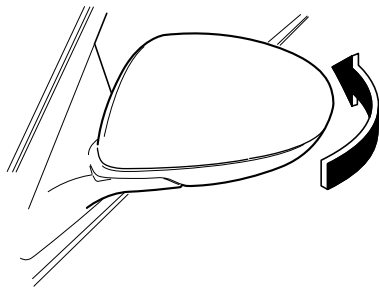

### **WARNING**

**Always return the outside mirrors to the driving position before you start driving:**

*Driving with the outside mirrors folded in is dangerous. Your rear view will be restricted, and you could have an accident.*

### **▼ Rearview Mirror**

#### **WARNING**

**Do not stack cargo or objects higher than the seatbacks:**

*Cargo stacked higher than the seatbacks is dangerous. It can block your view in the rearview mirror, which might cause you to hit another car when changing lanes.*

#### **Rearview mirror adjustment**

Before driving, adjust the rearview mirror to center on the scene through the rear window.

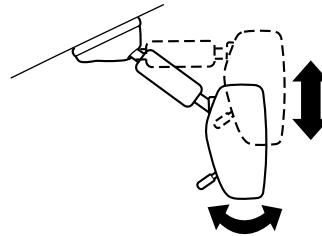

#### **NOTE**

*For the manual day/night mirror, perform the adjustment with the day/night lever in the day position.*

## Steering Wheel and Mirrors

### Reducing glare from headlights

#### Manual day/night mirror

Push the day/night lever forward for day driving. Pull it back to reduce glare of headlights from cars at the rear.

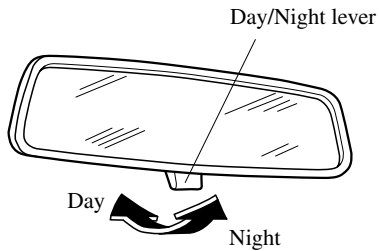

#### Auto-dimming mirror

The auto-dimming mirror automatically reduces glare of headlights from cars at the rear when the ignition is switched ON.

Press the ON/OFF button (⊕) to cancel the automatic dimming function. The indicator light will turn off. To reactivate the automatic dimming function, press the ON/OFF button (⊕). The indicator light will illuminate.

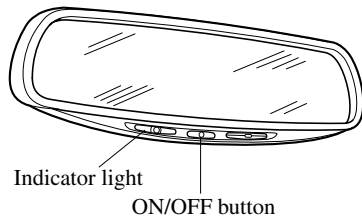

### NOTE

- Do not use glass cleaner or suspend objects on or around the light sensor. Otherwise, light sensor sensitivity will be affected and may not operate normally.

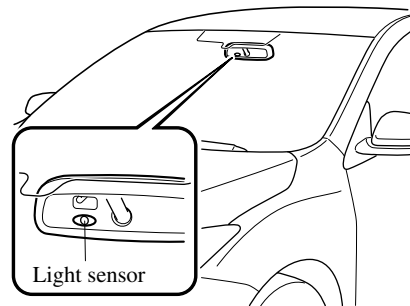
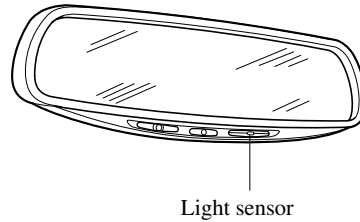

- The auto-dimmer function is canceled when the ignition is switched ON and the shift lever/selector lever is in reverse (R).

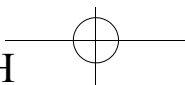
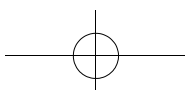

# 4 Before Driving Your Mazda

Important information about driving your Mazda.

|  |             |
|--|-------------|
| <b>Fuel and Engine Exhaust Precautions .....</b> | <b>4-2</b>  |
| Fuel Requirements .....                          | 4-2         |
| Emission Control System .....                    | 4-4         |
| Engine Exhaust (Carbon Monoxide) .....           | 4-5         |
| <b>Before Starting the Engine .....</b>          | <b>4-6</b>  |
| Before Getting In .....                          | 4-6         |
| After Getting In .....                           | 4-6         |
| <b>Driving Tips .....</b>                        | <b>4-7</b>  |
| Break-In Period .....                            | 4-7         |
| Money-Saving Suggestions .....                   | 4-7         |
| Hazardous Driving .....                          | 4-8         |
| Floor Mat .....                                  | 4-8         |
| Rocking the Vehicle .....                        | 4-9         |
| Winter Driving .....                             | 4-9         |
| Driving In Flooded Area .....                    | 4-11        |
| Overloading .....                                | 4-12        |
| Driving on Uneven Road .....                     | 4-13        |
| Turbocharger Information * .....                 | 4-14        |
| <b>Towing .....</b>                              | <b>4-15</b> |
| Trailer Towing .....                             | 4-15        |

\*Some models. **4-1**

Before Driving Your Mazda

## Fuel and Engine Exhaust Precautions

### Fuel Requirements

Vehicles with catalytic converters or oxygen sensors must use **ONLY UNLEADED FUEL**, which will reduce exhaust emissions and keep spark plug fouling to a minimum.

#### MZR 2.3 DISI Turbo

Your Mazda will perform best with fuel listed in the table.

| Fuel                  | Octane Rating* (Anti-knock index)               |
|-----------------------|---|
| Premium unleaded fuel | 91 [(R+ M)/2 method] or above (96 RON or above) |

\* U.S. federal law requires that octane ratings be posted on gasoline station pumps.

This vehicle is designed for and requires use of premium unleaded fuel. If 91 octane fuel [(R+ M)/2 method] (96RON) is not available, gasoline as low as 87 octane [(R+ M)/2 method] (91RON) can be used temporarily for emergency purposes. Use of gasoline lower than 91 octane [(R+ M)/2 method] (96RON) can decrease performance during its use. Refueling the vehicle with the correct octane fuel a couple of times will restore vehicle performance.

#### SKYACTIV-G 2.0, MZR 2.0 and MZR 2.5

Your Mazda will perform best with fuel listed in the table.

| Fuel                  | Octane Rating* (Anti-knock index)               |
|-----------------------|---|
| Regular unleaded fuel | 87 [(R+ M)/2 method] or above (91 RON or above) |

\* U.S. federal law requires that octane ratings be posted on gasoline station pumps.

Fuel with a rating lower than 87 octane (91 RON) could cause the emission control system to lose effectiveness. It could also cause engine knocking and serious engine damage.

### CAUTION

- **USE ONLY UNLEADED FUEL.**  
*Leaded fuel is harmful to the catalytic converter and oxygen sensors and will lead to deterioration of the emission control system and/or failures.*
- *Your vehicle can only use oxygenated fuels containing no more than 10 % ethanol by volume. Damage to your vehicle may occur when ethanol exceeds this recommendation, or if the gasoline contains any methanol. Stop using gasohol of any kind if your vehicle engine is performing poorly.*
- *Never add fuel system additives. Otherwise, the emission control system could be damaged. Consult an Authorized Mazda Dealer for details.*

Gasoline blended with oxygenates such as alcohol or other compounds are generally referred to as oxygenated fuels. The common gasoline blend that can be used with your vehicle is ethanol blended at no more than 10 %. Gasoline containing alcohol, such as ethanol or methanol, may be marketed under the name "Gasohol".



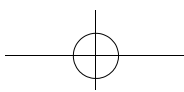

Before Driving Your Mazda

## Fuel and Engine Exhaust Precautions

---

Vehicle damage and drivability problems resulting from the use of the following may not be covered by the Mazda warranty.

- Gasohol containing more than 10 % ethanol.
- Gasoline or gasohol containing methanol.
- Leaded fuel or leaded gasohol.

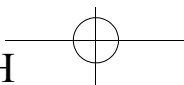

Before Driving Your Mazda

## Fuel and Engine Exhaust Precautions

### Emission Control System

Your vehicle is equipped with an emission control system (the catalytic converter is part of this system) that enables your vehicle to comply with existing exhaust emissions requirements.

#### **WARNING**

**Never park over or near anything flammable:**

*Parking over or near anything flammable, such as dry grass, is dangerous. Even with the engine turned off, the exhaust system remains very hot after normal use and could ignite anything flammable. A resulting fire could cause serious injury or death.*

#### **CAUTION**

*Ignoring the following precautions could cause lead to accumulate on the catalyst inside the converter or cause the converter to get very hot. Either condition will damage the converter and cause poor performance.*

- **USE ONLY UNLEADED FUEL.**
- *Do not drive your Mazda with any sign of engine malfunction.*
- *Do not coast with the ignition switched off.*
- *Do not descend steep grades in gear with the ignition switched off.*
- *Do not operate the engine at high idle for more than 2 minutes.*
- *Do not tamper with the emission control system. All inspections and adjustments must be made by a qualified technician.*
- *Do not push-start or pull-start your vehicle.*

#### **NOTE**

*Under U.S. federal law, any modification to the original-equipment emission control system before the first sale and registration of a vehicle is subject to penalties. In some states, such modification made on a used vehicle is also subject to penalties.*

#### **NOTE**

*While the engine is off, the sound of a valve opening and closing can be heard at the rear of the right side of the vehicle, however this does not indicate an abnormality. Your vehicle has a self-checking device and it operates while the engine is off.*

Before Driving Your Mazda

## Fuel and Engine Exhaust Precautions

### Engine Exhaust (Carbon Monoxide)

#### **WARNING**

**Do not drive your vehicle if you smell exhaust gas inside the vehicle:**

*Engine exhaust gas is dangerous. This gas contains carbon monoxide (CO), which is colorless, odorless, and poisonous. When inhaled, it can cause loss of consciousness and death. If you smell exhaust gas inside your vehicle, keep all windows fully open and contact an Authorized Mazda Dealer immediately.*

**Do not run the engine when inside an enclosed area:**

*Running the engine inside an enclosed area, such as a garage, is dangerous. Exhaust gas, which contains poisonous carbon monoxide, could easily enter the cabin. Loss of consciousness or even death could occur.*

**Open the windows or adjust the heating or cooling system to draw fresh air when idling the engine:**

*Exhaust gas is dangerous. When your vehicle is stopped with the windows closed and the engine running for a long time even in an open area, exhaust gas, which contains poisonous carbon monoxide, could enter the cabin. Loss of consciousness or even death could occur.*

**Clear snow from underneath and around your vehicle, particularly the tail pipe, before starting the engine:**

*Running the engine when a vehicle is stopped in deep snow is dangerous. The exhaust pipe could be blocked by the snow, allowing exhaust gas to enter the cabin. Because exhaust gas contains poisonous carbon monoxide, it could cause loss of consciousness or even death to occupants in the cabin.*

Before Driving Your Mazda

## Before Starting the Engine

---

### Before Getting In

- Be sure the windows, outside mirrors, and outside lights are clean.
- Inspect inflation pressures and condition of tires.
- Look under the vehicle for any sign of fluid leaks.
- If you plan to back up, make sure nothing is in your way.

**NOTE**

*Engine oil, engine coolant, brake/clutch fluid, washer fluid, and other fluid levels should be inspected. See Maintenance, Section 8.*

### After Getting In

- Are all doors closed and locked?
- Is the seat adjusted properly?
- Are the inside and outside mirrors adjusted?
- Is the steering wheel adjusted properly?
- Is everyone's seat belt fastened?
- Check all gauges.
- Check all warning lights when the ignition is switched ON.
- Release the parking brake and make sure the brake warning light goes off.

Always be thoroughly familiar with your Mazda.

## Driving Tips

### Break-In Period

No special break-in is necessary, but a few precautions in the first 1,000 km (600 miles) may add to the performance, economy, and life of your Mazda.

- Do not race the engine.
- Do not maintain one constant speed, either slow or fast, for a long period of time.
- Do not drive constantly at full-throttle or high engine rpm for extended periods of time.
- Avoid unnecessary hard stops.
- Avoid full-throttle starts.

### Money-Saving Suggestions

How you operate your Mazda determines how far it will travel on a tank of fuel. Use these suggestions to help save money on fuel and repairs.

- Avoid long warm-ups. Once the engine runs smoothly, begin driving.
- Avoid fast starts.
- Keep the engine tuned. Follow the maintenance schedule (page 8-4) and have an Authorized Mazda Dealer perform inspections and servicing.
- Use the air conditioner only when necessary.
- Slow down on rough roads.
- Keep the tires properly inflated.
- Do not carry unnecessary weight.
- Do not rest your foot on the brake pedal while driving.
- Keep the wheels in correct alignment.
- Keep windows closed at high speeds.
- Slow down when driving in crosswinds and headwinds.

### WARNING

***Never stop the engine when going down a hill:***

*Stopping the engine when going down a hill is dangerous. This causes the loss of power steering and power brake control, and may cause damage to the drivetrain. Any loss of steering or braking control could cause an accident.*

Before Driving Your Mazda

## Driving Tips

### Hazardous Driving

#### **⚠ WARNING**

**Be extremely careful if it is necessary to downshift on slippery surfaces:**

*Downshifting into lower gear while driving on slippery surfaces is dangerous. The sudden change in tire speed could cause the tires to skid. This could lead to loss of vehicle control and an accident.*

**Do not rely on ABS as a substitute for safe driving:**

*The ABS cannot compensate for unsafe and reckless driving, excessive speed, tailgating (following another vehicle too closely), driving on ice and snow, and hydroplaning (reduced tire friction and road contact because of water on the road surface). You can still have an accident.*

When driving on ice or in water, snow, mud, sand, or similar hazards:

- Be cautious and allow extra distance for braking.
- Avoid sudden braking and sudden maneuvering.
- Do not pump the brakes. Continue to press down on the brake pedal. Refer to Anti-Lock Brake System (ABS) on page 5-8.
- If you get stuck, select a lower gear and accelerate slowly. Do not spin the front wheels.
- For more traction in starting on slippery surfaces such as ice or packed snow, use sand, rock salt, chains, carpeting, or other nonslip material under the front wheels.

#### **NOTE**

*Use snow chains only on the front wheels.*

4-8

### Floor Mat

#### **⚠ WARNING**

**Make sure the floor mats are hooked on the retention pins to prevent them from bunching up under the foot pedals:**

*Using a floor mat that is not secured is dangerous as it will interfere with the accelerator and brake pedal operation, which could result in an accident.*

**Do not install two floor mats, one on top of the other, on the driver's side:**

*Installing two floor mats, one on top of the other, on the driver's side is dangerous as the retention pins can only keep one floor mat from sliding forward.*

*In using a heavy duty floor mat for winter use always remove the original floor mat.*

*Loose floor mat(s) will interfere with the foot pedal and could result in an accident.*

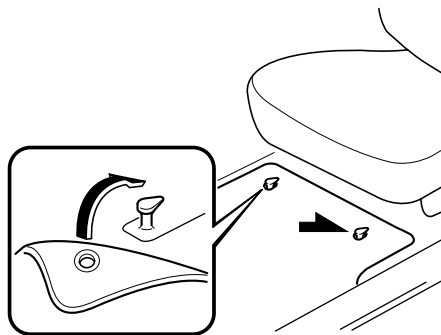

When setting a floor mat, position the floor mat so that its eyelets are inserted over the pointed end of the retention posts.

### Rocking the Vehicle

#### **WARNING**

***Do not spin the wheels at more than 56 km/h (35 mph), and do not allow anyone to stand behind a wheel when pushing the vehicle:***

*When the vehicle is stuck, spinning the wheels at high speed is dangerous. The spinning tire could overheat and explode. This could cause serious injuries.*

#### **CAUTION**

*Too much rocking may cause engine overheating, transaxle failure, and tire damage.*

If you must rock the vehicle to free it from snow, sand or mud, depress the accelerator slightly and slowly move the shift lever from 1 (D) to R.

### Winter Driving

- Carry emergency gear, including tire chains, window scraper, flares, a small shovel, jumper cables, and a small bag of sand or salt.

Ask an Authorized Mazda Dealer to perform the following precautions:

- Have the proper ratio of antifreeze in the radiator.  
Refer to Engine Coolant on page 8-25.
- Inspect the battery and its cables. Cold reduces battery capacity.
- Use only cold-weather engine oil (page 8-21).
- Inspect the ignition system for damage and loose connections.
- Use washer fluid made with antifreeze—but do not use engine coolant antifreeze for washer fluid (page 8-30).
- Do not use the parking brake in freezing weather as it may freeze. Instead, shift to P with an automatic transaxle and to 1 or R with a manual transaxle. Block the rear wheels.
- Snow left on the windshield is dangerous as it could obstruct vision. Remove snow before driving.
- Do not apply excessive force to a window scraper when removing ice or frozen snow on the mirror glass and windshield.
- Never use warm or hot water for removing snow or ice from windows and mirrors as it could result in the glass cracking.

Before Driving Your Mazda

## Driving Tips

- Braking performance can be adversely affected if snow or ice adheres to the brake equipment. If this situation occurs, drive the vehicle slowly, releasing the accelerator pedal and lightly applying the brakes several times until the brake performance returns to normal.

### ▼ Snow Tires

#### Use snow tires on all four wheels

Do not go faster than 120 km/h (75 mph) while driving with snow tires. Inflate snow tires 30 kPa (0.3 kgf/cm<sup>2</sup>, 4.3 psi) more than recommended on the tire pressure label (driver's door frame), but never more than the maximum cold-tire pressure shown on the tires.

#### SKYACTIV-G 2.0, MZR 2.0 and MZR 2.5

Your vehicle is originally equipped with all season radials designed to be used all year around. In some extreme climates you may find it necessary to replace them with snow tires during the winter months to further improve traction on snow and ice covered roads.

#### MZR 2.3 DISI Turbo

Your vehicle is originally equipped with summer tires designed for optimum traction on wet and dry roads. If your vehicle is to be used on snow and ice covered roads, Mazda recommends that you replace the tires originally equipped on your vehicle with snow tires during the winter months.

### **⚠ WARNING**

**Use only the same size and type tires (snow, radial, or non-radial) on all four wheels:**

*Using tires different in size or type is dangerous. Your vehicle's handling could be greatly affected and result in an accident.*

### **⚠ CAUTION**

*Check local regulations before using studded tires.*

#### **NOTE**

*If your vehicle is equipped with the tire pressure monitoring system, the system may not function correctly when using tires with steel wire reinforcement in the sidewalls (page 5-35).*

### ▼ Tire Chains

Check local regulations before using tire chains.

### **⚠ CAUTION**

- Chains may affect handling.
- Do not go faster than 50 km/h (30 mph) or the chain manufacturer's recommended limit, whichever is lower.
- Drive carefully and avoid bumps, holes, and sharp turns.
- Avoid locked-wheel braking.
- Do not use chains on a temporary spare tire; it may result in damage to the vehicle and to the tire.
- Do not use chains on roads that are free of snow or ice. The tires and chains could be damaged.
- Chains may scratch or chip aluminum wheels.



### NOTE

- *Use of tire chains on a vehicle equipped with P225/40R18 specification tires could cause interference with the vehicle body and scratching. If tire chains are to be used, replace both front and rear tires with P 205/50R17 tires. Please consult an Authorized Mazda Dealer.*
- *If your vehicle is equipped with the tire pressure monitoring system, the system may not function correctly when using tire chains.*

Install the chains on the front tires.  
Do not use chains on the rear tires.  
Please consult an Authorized Mazda Dealer.

### Installing the chains

1. Remove the wheel covers, or the chain bands will scratch them.
2. Secure the chains on the front tires as tightly as possible. Always follow the chain manufacturer's instructions.
3. Retighten the chains after driving 1/2 —1 km (1/4—1/2 mile).

## Driving In Flooded Area

### WARNING

**Dry wet brakes by driving very slowly and applying the brakes lightly until brake performance returns to normal:**

*Driving with wet brakes is dangerous. Increased stopping distance or the vehicle pulling to one side when braking could result in a serious accident. Light braking will indicate whether the brakes have been affected.*

### CAUTION

*Do not drive the vehicle on flooded roads as it could cause short circuiting of electrical/electronic parts, or engine damage or stalling from water absorption. If the vehicle has been immersed in water, consult an Authorized Mazda Dealer.*

Before Driving Your Mazda

## Driving Tips

---

### Overloading

#### **WARNING**

**Be careful not to overload your vehicle:**  
*The gross axle weight rating (GAWR) and the gross vehicle weight rating (GVWR) of your vehicle are on the Motor Vehicle Safety Standard Label on the driver's door frame. Exceeding these ratings can cause an accident or vehicle damage. You can estimate the weight of your load by weighing the items (or people) before putting them in the vehicle.*

## Driving on Uneven Road

Your vehicle's suspension and underbody can be damaged if driven on rough/uneven roads or over speed bumps at excessive speeds. Use care and reduce speed when traveling on rough/uneven roads or over speed bumps.

Use care not to damage the vehicle's underbody, bumpers or muffler(s) when driving under the following conditions:

- Ascending or descending a slope with a sharp transition angle
- Ascending or descending a driveway or trailer ramp with a sharp transition angle

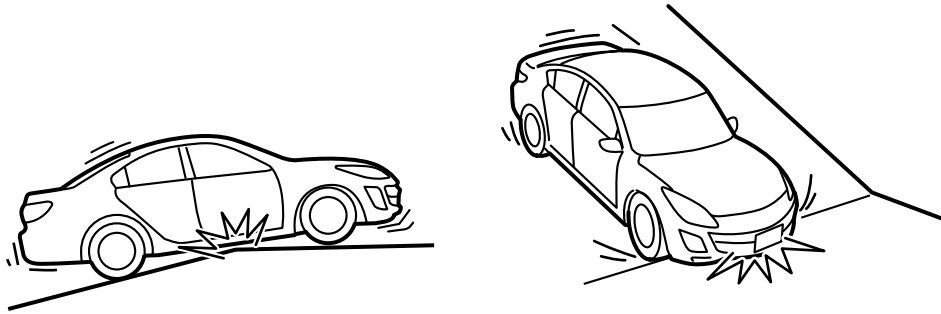

Your vehicle is equipped with low profile tires allowing class-leading performance and handling. As a result, the sidewall of the tires are very thin and the tires and wheels can be damaged if driven through potholes or on rough/uneven roads at excessive speeds. Use care and reduce speed when traveling on rough/uneven roads or through potholes.

Before Driving Your Mazda

## Driving Tips

---

### Turbocharger Information\*

The turbocharger greatly enhances engine power. Its advanced design provides improved operation and requires minimum additional maintenance. To get maximum performance from your turbocharged engine, take note of the following tips:

- The turbocharged engine is designed for optimal operation with premium unleaded gasoline (page 4-2). Do not use fuel with a lower octane rating. Extra fuel additives are NOT recommended.
- Change the engine oil and filter using the turbo engine interval outlined in the maintenance schedule (for your driving condition).
- Use only the recommended engine oil (page 8-21). Extra oil additives are NOT recommended.
- After driving at freeway speeds or up a long hill, idle the engine at least 30 seconds to cool the turbo before turning off the engine. Avoid simply shutting the engine off abruptly after a hard or long drive. Damage to the turbocharger may result.
- Do not race or over-rev the engine when starting. This should not be done with ANY engine, especially not with one that's turbocharged.
- Do not add any aftermarket devices to alter the engine's ignition timing, fuel delivery, or turbo boost pressure. This may lead to serious engine damage and may void your warranty.

**4-14** \*Some models.

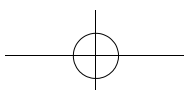

Before Driving Your Mazda  
**Towing**

---

**Trailer Towing**

The Mazda3 is not designed for towing.  
Never tow a trailer with your Mazda3.

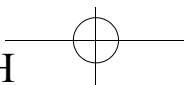

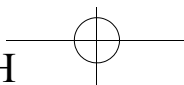
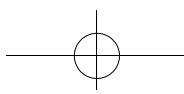

# 5 Driving Your Mazda

Explanation of instruments and controls.

|   |             |
|---|-------------|
| <b>Starting and Driving .....</b>                     | <b>5-2</b>  |
| Ignition Switch .....                                 | 5-2         |
| Starting the Engine .....                             | 5-3         |
| Turning the Engine Off .....                          | 5-4         |
| Brake System .....                                    | 5-5         |
| Manual Transaxle Operation .....                      | 5-10        |
| Automatic Transaxle Controls .....                    | 5-13        |
| Power Steering .....                                  | 5-21        |
| Cruise Control * .....                                | 5-22        |
| Traction Control System (TCS) * .....                 | 5-27        |
| Dynamic Stability Control (DSC) * .....               | 5-28        |
| Tire Pressure Monitoring System * .....               | 5-31        |
| Blind Spot Monitoring (BSM) System * .....            | 5-37        |
| <br>  |             |
| <b>Instrument Cluster and Indicators .....</b>        | <b>5-42</b> |
| Meters and Gauges .....                               | 5-42        |
| <br>  |             |
| <b>Warning/Indicator Lights and Beep Sounds .....</b> | <b>5-47</b> |
| Warning/Indicator Lights .....                        | 5-47        |
| Beep Sounds .....                                     | 5-62        |
| <br>  |             |
| <b>Switches and Controls .....</b>                    | <b>5-64</b> |
| Lighting Control .....                                | 5-64        |
| Turn and Lane-Change Signals .....                    | 5-69        |
| Fog Lights * .....                                    | 5-70        |
| Windshield Wipers and Washer .....                    | 5-71        |
| Rear Window Wiper and Washer (5 Door) .....           | 5-75        |
| Rear Window Defroster .....                           | 5-75        |
| Horn .....  | 5-76        |
| Hazard Warning Flasher .....                          | 5-77        |

\*Some models. **5-1**

Driving Your Mazda

## Starting and Driving

### Ignition Switch

#### With advanced key

Refer to “Starting the engine (page 3-12)” for information on how to use the ignition switch.

#### ▼ Ignition Switch Positions (Without Advanced Key)

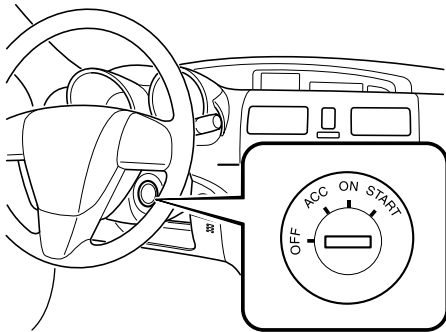

#### **OFF**

The power supply to electrical devices is turned off. Only in this position can the key be removed.

### **⚠ WARNING**

**Do not stop the engine while the vehicle is moving:**

*Stopping the engine while the vehicle is moving for any reason other than in an emergency is dangerous.*

*Stopping the engine while the vehicle is moving will result in reduced braking ability due to the loss of power braking, which could cause an accident and serious injury.*

**Before leaving the driver's seat, always switch the ignition to OFF, set the parking brake and make sure the shift lever is in P (automatic transaxle) or in 1st gear or R (manual transaxle):**

*It is important to switch the ignition to OFF even if you are not removing the key from the ignition or leaving the vehicle. Leaving the key in other positions will disable some of the vehicle security systems and run the battery down.*

*Leaving the driver's seat without switching the ignition to OFF, setting the parking brake and shifting the shift lever to P (automatic transaxle) or to 1st gear or R (manual transaxle) is dangerous. Unexpected vehicle movement could occur. This could cause an accident.*

#### **ACC (Accessory)**

In this position, some electrical accessories will operate.

#### **ON**

This is the normal running position after the engine is started. Some indicator lights/warning lights should be inspected before the engine is started (page 5-47).



## Starting and Driving

### **NOTE**

*When the ignition is switched ON, the sound of the fuel pump motor operating near the fuel tank can be heard. This does not indicate an abnormality.*

### **START**

The engine is started in this position. It will crank until you release the key. It then returns to the ON position.

### **▼ Ignition Key Reminder**

If the ignition is switched off or the ignition is switched to ACC with the key inserted, a continuous beep sound will be heard when the driver's door is opened.

### **NOTE**

*A personalized function is available to change the sound volume for the ignition key reminder. Refer to Settings on page 6-186.*

## Starting the Engine

### **With advanced key**

Refer to “Starting the engine (page 3-12)” for information on how to start the engine.

### **NOTE**

*Engine-starting is controlled by the spark ignition system.*

*This system meets all Canadian Interference-Causing Equipment Standard requirements regulating the impulse electrical field strength of radio noise.*

1. Occupants should fasten their seat belts.
2. Make sure the parking brake is on.
3. Depress the brake pedal.
4. **(Manual transaxle)**  
Depress the clutch pedal all the way and shift into neutral.  
Keep the clutch pedal depressed while cranking the engine.  
**(Automatic transaxle)**  
Put the vehicle in park (P). If you must restart the engine while the vehicle is moving, shift into neutral (N).

### **NOTE**

#### **(Manual transaxle)**

*The starter will not operate unless the clutch is depressed sufficiently.*

#### **(Automatic transaxle)**

*The starter will not operate if the shift lever is **not** in P or N.*

5. Switch the ignition to START and hold (up to 10 seconds at a time) until the engine starts.

Driving Your Mazda

## Starting and Driving

### CAUTION

*Do not try the starter for more than 10 seconds at a time. If the engine stalls or fails to start, wait 10 seconds before trying again. Otherwise, you may damage the starter and drain the battery.*

6. After starting the engine, let it idle for about 10 seconds.

### NOTE

- *In extremely cold weather or after the vehicle has not been driven in several days, let the engine warm up without operating the accelerator.*
- *Whether the engine is cold or warm, it should be started without use of the accelerator.*
- *If the engine does not start the first time, refer to Starting a Flooded Engine under Emergency Starting. If the engine still does not start, have your vehicle inspected by an Authorized Mazda Dealer (page 7-18).*
- **(SKYACTIV-G 2.0)**  
*After starting a cold engine, the engine speed increases and a whining sound from the engine compartment can be heard. This is for improved exhaust gas purification and does not indicate defect of the parts.*

### Turning the Engine Off

### WARNING

**Do not stop the engine while the vehicle is moving:**

*Stopping the engine while the vehicle is moving for any reason other than in an emergency is dangerous. Stopping the engine while the vehicle is moving will result in reduced braking ability due to the loss of power braking, which could cause an accident and serious injury.*

1. Stop the vehicle completely.
2. **(Manual transaxle)**  
Shift into neutral.  
**(Automatic transaxle)**  
Shift the shift lever to the P position.
3. **(Without Advanced Keyless Entry & Push Button Start System)**  
Switch the ignition from ON to OFF.  
**(With Advanced Keyless Entry & Push Button Start System)**  
Press the push button start to turn off the engine.

### CAUTION

*When leaving the vehicle, make sure the ignition is switched off.*

### NOTE

*The electrical fan in the engine compartment could turn on for a few minutes after the ignition is switched from ON to OFF, whether or not the A/C is on or off, to cool the engine compartment quickly.*

## Starting and Driving

### Brake System

#### ▼ Foot Brake

Your Mazda has power-assisted brakes that adjust automatically through normal use.

Should power-assist fail, you can stop by applying greater force than normal to the brake pedal. But the distance required to stop will be greater than usual.

#### **⚠ WARNING**

***Do not coast with the engine stalled or turned off, find a safe place to stop:***

*Coasting with the engine stalled or turned off is dangerous. Braking will require more effort, and the brake's power-assist could be depleted if you pump the brake. This will cause longer stopping distances or even an accident.*

***Shift to a lower gear when going down steep hills:***

*Driving with your foot continuously on the brake pedal or steadily applying the brakes for long distances is dangerous. This causes overheated brakes, resulting in longer stopping distances or even total brake failure. This could cause loss of vehicle control and a serious accident. Avoid continuous application of the brakes.*

***Dry off brakes that have become wet by driving slowly, releasing the accelerator pedal and lightly applying the brakes several times until the brake performance returns to normal:***

*Driving with wet brakes is dangerous. Increased stopping distance or the vehicle pulling to one side when braking could result in a serious accident. Light braking will indicate whether the brakes have been affected.*

Driving Your Mazda

## Starting and Driving

### **CAUTION**

- Do not drive with your foot held on the clutch pedal or brake pedal, or hold the clutch pedal depressed halfway unnecessarily. Doing so could result in the following:
  - The clutch and brake parts will wear out more quickly.
  - The brakes can overheat and adversely affect brake performance.
- Always depress the brake pedal with the right foot. Applying the brakes with the unaccustomed left foot could slow your reaction time to an emergency situation resulting in insufficient braking operation.

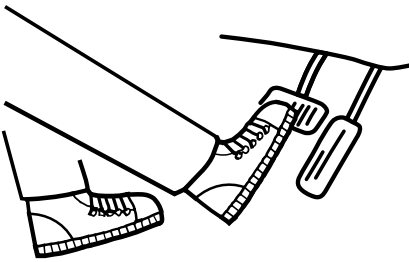

- Wear shoes appropriate for driving in order to avoid your shoe contacting the brake pedal when depressing the accelerator pedal.

### ▼ Parking Brake

### **WARNING**

**Before leaving the driver's seat, always switch the ignition off, set the parking brake, and make sure the shift lever is in P (automatic transaxle) or in 1st gear or R (manual transaxle):**

Leaving the driver's seat without switching the ignition off, setting the parking brake, and shifting the shift lever to P (automatic transaxle) or to 1st gear or R (manual transaxle) is dangerous. Unexpected vehicle movement could occur which could result in an accident.

In addition, if your intention is to leave the vehicle for even a short period, it is important to switch the ignition off, as leaving it in another position will disable some of the vehicle's security systems and run the battery down.

### **CAUTION**

Driving with the parking brake on will cause excessive wear of the brake linings or pads.

### **NOTE**

For parking in snow, refer to Winter Driving (page 4-9) regarding parking brake use.

Driving Your Mazda  
**Starting and Driving**

**Setting the parking brake**

Depress the brake pedal and then firmly pull the parking brake lever fully upwards with sufficient force to hold the vehicle in a stationary position.

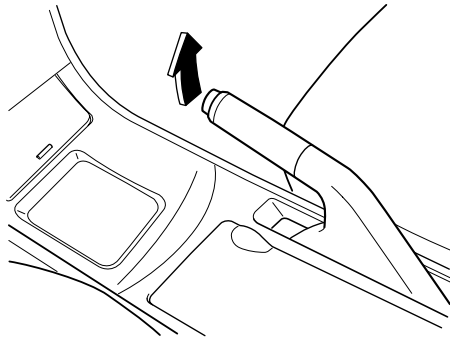

**Releasing the parking brake**

Depress the brake pedal and pull the parking brake lever upwards, then press the release button. While holding the button, lower the parking brake lever all the way down to the released position.

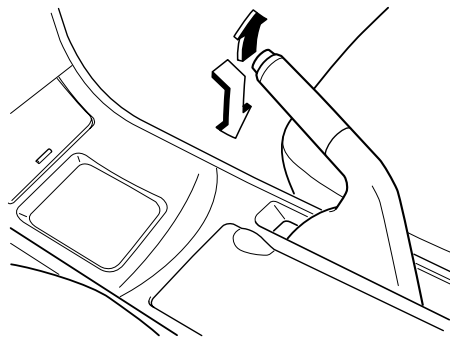

**▼ Brake System Warning Light**



This warning has the following functions:

**Parking brake warning**

The light illuminates when the parking brake is applied with the ignition switched to START or ON. It turns off when the parking brake is fully released.

**Low brake fluid level warning**

If the light stays on after the parking brake is fully released, you may have a brake problem.

Drive to the side of the road and park off the right-of-way.

You may notice that the pedal is harder to depress or that it may go closer to the floor. In either case, it will take longer to stop the vehicle.

1. With the engine stopped, open the hood and check the brake fluid level immediately, and then add fluid if required (page 8-27).
2. After adding fluid, check the light again.

If the warning light remains on, or if the brakes do not operate properly, do not drive the vehicle. Have it towed to an Authorized Mazda Dealer.

Even if the light turns off, have your brake system inspected as soon as possible by an Authorized Mazda Dealer.

Driving Your Mazda

## Starting and Driving

### NOTE

Having to add brake fluid is sometimes an indicator of leakage. Consult an Authorized Mazda Dealer as soon as possible even if the brake light is no longer illuminated.

### WARNING

**Do not drive with the brake system warning light illuminated. Contact an Authorized Mazda Dealer to have the brakes inspected as soon as possible:**

*Driving with the brake system warning light illuminated is dangerous. It indicates that your brakes may not work at all or that they could completely fail at any time. If this light remains illuminated, after checking that the parking brake is fully released, have the brakes inspected immediately.*

### ▼ Anti-Lock Brake System (ABS)

The ABS control unit continuously monitors the speed of each wheel. If one wheel is about to lock up, the ABS responds by automatically releasing and reapplying that wheel's brake.

The driver will feel a slight vibration in the brake pedal and may hear a chattering noise from the brake system. This is normal ABS system operation. Continue to depress the brake pedal without pumping the brakes.

### WARNING

**Do not rely on ABS as a substitute for safe driving:**

*The ABS cannot compensate for unsafe and reckless driving, excessive speed, tailgating (following another vehicle too closely), driving on ice and snow, and hydroplaning (reduced tire friction and road contact because of water on the road surface). You can still have an accident.*

### NOTE

- *Braking distances may be longer on loose surfaces (snow or gravel, for example) which usually have a hard foundation. A vehicle with a normal braking system may require less distance to stop under these conditions because the tires will build up a wedge of surface layer when the wheels skid.*
- *The sound of the ABS operating may be heard when starting the engine or immediately after starting the vehicle, however, it does not indicate a malfunction.*

### ▼ ABS Warning Light



The warning light stays on for a few seconds when the ignition is switched ON.

Driving Your Mazda  
**Starting and Driving**

If the ABS warning light stays on while you're driving, the ABS control unit has detected a system malfunction. If this occurs, your brakes will function normally as if the vehicle had no ABS. Should this happen, consult an Authorized Mazda Dealer as soon as possible.

**NOTE**

- *When the engine is jump-started to charge the battery, uneven rpm occurs and the ABS warning light may illuminate. If this occurs, it is the result of the weak battery and does not indicate an ABS malfunction. Recharge the battery.*
- **(With DSC vehicles)**  
*The brake assist system does not operate while the ABS warning light is illuminated.*

▼ **Electronic Brake Force  
Distribution System Warning**

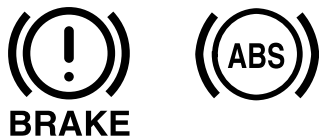

If the electronic brake force distribution control unit determines that some components are operating incorrectly, the control unit may illuminate the brake system warning light and the ABS warning light on simultaneously. The problem is likely to be the electronic brake force distribution system.

**⚠ WARNING**

**Do not drive with both the ABS warning light and brake warning light illuminated. Have the vehicle towed to an Authorized Mazda Dealer to have the brakes inspected as soon as possible:**

*Driving when the brake system warning light and ABS warning light are illuminated simultaneously is dangerous.*

*When both lights are illuminated, the rear wheels could lock more quickly in an emergency stop than under normal circumstances.*

▼ **Brake Assist**

During emergency braking situations when it is necessary to depress the brake pedal with greater force, the brake assist system provides braking assistance, thus enhancing braking performance.

When the brake pedal is depressed hard or depressed more quickly, the brakes apply more firmly.

Driving Your Mazda

## Starting and Driving

### NOTE

- *When the brake pedal is depressed hard or depressed more quickly, the pedal will feel softer but the brakes will apply more firmly. This is a normal effect of the brake assist operation and does not indicate a malfunction.*
- **(Without DSC vehicles)**  
*When the brake pedal is depressed hard or depressed more quickly, a clicking noise from the brake booster may be heard. This is a normal effect of the brake assist and does not indicate a malfunction.*
- **(With DSC vehicles)**  
*When the brake pedal is depressed hard or depressed more quickly, a motor/pump operation noise may be heard. This is a normal effect of the brake assist and does not indicate a malfunction.*
- *The brake assist equipment does not supersede the functionality of the vehicle's main braking system.*

## Manual Transaxle Operation

### ▼ Manual Transaxle Shift Pattern

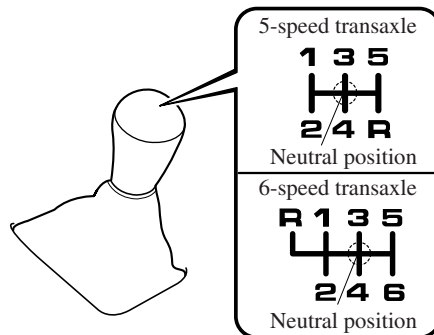

The vehicle is equipped with either a 5-speed or 6-speed manual transaxle. The shift pattern for each is shown above.

Depress the clutch pedal all the way down while shifting; then release it slowly.

#### **(5-speed transaxle)**

A safety feature prevents accidental shifting from 5 to R (reverse). The shift lever must be put in neutral before being shifted to R.



## Driving Your Mazda Starting and Driving

### (6-speed transaxle)

Vehicles with 6-speed transaxle are equipped with a device to prevent shifting to R (reverse) by mistake. Push the shift lever downward and shift to R.

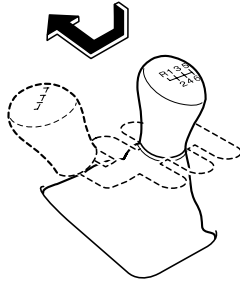

### **! WARNING**

**Do not use sudden engine braking on slippery road surfaces or at high speeds:**

*Shifting down while driving on wet, snowy, or frozen roads, or while driving at high speeds causes sudden engine braking, which is dangerous. The sudden change in tire speed could cause the tires to skid. This could lead to loss of vehicle control and an accident.*

**Be sure to leave the shift lever in 1 or R position and set the parking brake when leaving the vehicle unattended:**  
*Otherwise the vehicle could move and cause an accident.*

### **! CAUTION**

- *Keep your foot off the clutch pedal except when shifting gears. Also, do not use the clutch to hold the vehicle on an upgrade. Riding the clutch will cause needless clutch wear and damage.*
- *Do not apply any excessive lateral force to the gear lever when changing from 5th to 4th gear. This could lead to the accidental selection of 2nd gear, which can result in damage to the transaxle.*
- *Make sure the vehicle comes to a complete stop before shifting to R. Shifting to R while the vehicle is still moving may damage the transaxle.*

### **NOTE**

*If shifting to R is difficult, shift back into neutral, release the clutch pedal, and try again.*

### **▼ Recommendations for Shifting**

#### **Upshifting**

For normal acceleration, we recommend these shift points.

(MZR 2.0)

| Gear   | Vehicle speed    |
|--------|------------------|
| 1 to 2 | 21 km/h (13 mph) |
| 2 to 3 | 39 km/h (24 mph) |
| 3 to 4 | 55 km/h (34 mph) |
| 4 to 5 | 79 km/h (49 mph) |

(SKYACTIV-G 2.0)

| Gear   | Vehicle speed    |
|--------|------------------|
| 1 to 2 | 24 km/h (15 mph) |
| 2 to 3 | 42 km/h (26 mph) |
| 3 to 4 | 60 km/h (37 mph) |
| 4 to 5 | 75 km/h (46 mph) |
| 5 to 6 | 79 km/h (49 mph) |

Driving Your Mazda

## Starting and Driving

### (MZR 2.3 DISI Turbo)

| Gear   | Vehicle speed    |
|--------|------------------|
| 1 to 2 | 24 km/h (15 mph) |
| 2 to 3 | 40 km/h (25 mph) |
| 3 to 4 | 65 km/h (40 mph) |
| 4 to 5 | 73 km/h (45 mph) |
| 5 to 6 | 81 km/h (50 mph) |

### (MZR 2.5)

| Gear   | Vehicle speed    |
|--------|------------------|
| 1 to 2 | 24 km/h (15 mph) |
| 2 to 3 | 43 km/h (27 mph) |
| 3 to 4 | 56 km/h (35 mph) |
| 4 to 5 | 73 km/h (45 mph) |
| 5 to 6 | 90 km/h (56 mph) |

For cruising

### (MZR 2.0)

| Gear   | Vehicle speed    |
|--------|------------------|
| 1 to 2 | 18 km/h (11 mph) |
| 2 to 3 | 29 km/h (18 mph) |
| 3 to 4 | 47 km/h (29 mph) |
| 4 to 5 | 68 km/h (42 mph) |

### (SKYACTIV-G 2.0)

| Gear   | Vehicle speed    |
|--------|------------------|
| 1 to 2 | 13 km/h (8 mph)  |
| 2 to 3 | 29 km/h (18 mph) |
| 3 to 4 | 49 km/h (30 mph) |
| 4 to 5 | 63 km/h (39 mph) |
| 5 to 6 | 70 km/h (43 mph) |

### (MZR 2.3 DISI Turbo)

| Gear   | Vehicle speed    |
|--------|------------------|
| 1 to 2 | 24 km/h (15 mph) |
| 2 to 3 | 40 km/h (25 mph) |
| 3 to 4 | 65 km/h (40 mph) |
| 4 to 5 | 73 km/h (45 mph) |
| 5 to 6 | 81 km/h (50 mph) |

### (MZR 2.5)

| Gear   | Vehicle speed    |
|--------|------------------|
| 1 to 2 | 16 km/h (10 mph) |
| 2 to 3 | 32 km/h (20 mph) |
| 3 to 4 | 49 km/h (30 mph) |
| 4 to 5 | 60 km/h (37 mph) |
| 5 to 6 | 71 km/h (44 mph) |

### Downshifting

When you must slow down in heavy traffic or on a steep **upgrade**, downshift before the engine starts to overwork. This reduces the chance of stalling and gives better acceleration when you need more speed.



On a steep **downgrade**, downshifting helps maintain safe speed and prolongs brake life.

Driving Your Mazda  
**Starting and Driving**

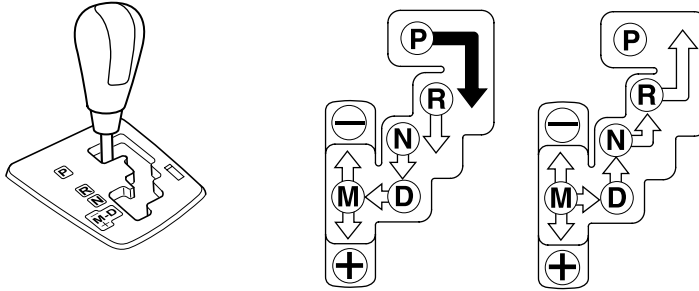
**Automatic Transaxle Controls**



**Various Lockouts:**

-  Indicates that you must depress the brake pedal to shift (The ignition must be switched to ACC or ON).
-  Indicates the shift lever can be shifted freely into any position.

**NOTE**

*The Sport AT has an option that is not included in the traditional automatic transaxle giving the driver the option of selecting each gear instead of leaving it to the transaxle to shift gears. Even if you intend to use the automatic transaxle functions as a traditional automatic, you should also be aware that you can inadvertently shift into manual shift mode and an inappropriate gear may be retained as the vehicle speed increases. If you notice the engine speed going higher or hear the engine racing, confirm you have not accidentally slipped into manual shift mode (page 5-16).*

Driving Your Mazda

## Starting and Driving

### ▼ Transaxle Ranges

The shift lever must be in P or N to operate the starter.

#### **P (Park)**

P locks the transaxle and prevents the front wheels from rotating.

#### **⚠ WARNING**

**Always set the shift lever to P and set the parking brake:**

*Only setting the shift lever to the P position without using the parking brake to hold the vehicle is dangerous. If P fails to hold, the vehicle could move and cause an accident.*

#### **⚠ CAUTION**

- *Shifting into P, N or R while the vehicle is moving can damage your transaxle.*
- *Shifting into a driving gear or reverse when the engine is running faster than idle can damage the transaxle.*

#### **R (Reverse)**

In position R, the vehicle moves only backward. You must be at a complete stop before shifting to or from R, except under rare circumstances as explained in Rocking the Vehicle (page 4-9).

#### **N (Neutral)**

In N, the wheels and transaxle are not locked. The vehicle will roll freely even on the slightest incline unless the parking brake or brakes are on.

#### **⚠ WARNING**

***If the engine is running faster than idle, do not shift from N or P into a driving gear:***

*It's dangerous to shift from N or P into a driving gear when the engine is running faster than idle. If this is done, the vehicle could move suddenly, causing an accident or serious injury.*

**Do not shift into N when driving the vehicle:**

*Shifting into N while driving is dangerous. Engine braking cannot be applied when decelerating which could lead to an accident or serious injury.*

#### **⚠ CAUTION**

*Do not shift into N when driving the vehicle. Doing so can cause transaxle damage.*

#### **NOTE**

*Apply the parking brake or depress the brake pedal before moving the shift lever from N to prevent the vehicle from moving unexpectedly.*

#### **D (Drive)**

D is the normal driving position. From a stop, the transaxle will automatically shift through a 5-gear/6-gear\* sequence.

\* SKYACTIV-G 2.0

#### **M (Manual)**

M is the manual shift mode position. Gears can be shifted up or down by operating the shift lever. Refer to Manual Shift Mode (page 5-16).

## Driving Your Mazda Starting and Driving

### ▼ Active Adaptive Shift (AAS)

Active Adaptive Shift (AAS) automatically controls the transaxle shift points to best suit the road conditions and driver input. This improves driving comfort.

#### (SKYACTIV-G 2.0)

The transaxle may switch to AAS mode when driving up and down slopes, cornering, or depressing the accelerator pedal quickly while the shift lever is in the D position.

Depending on the driving conditions and vehicle operations, it may not be possible to shift gears, however, this does not indicate a problem because the AAS mode will maintain the optimum gear position.

#### (Except SKYACTIV-G 2.0)

If the driver accelerates rapidly, or accelerates and decelerates rapidly by operating the accelerator and brake pedal for a certain period of time while the shift lever is in the D position, AAS mode could activate.

When cornering the vehicle, AAS mode will hold the transaxle in the gear the vehicle was in before entering the curve, allowing the vehicle to be accelerated from the same gear after exiting the curve. AAS mode will maintain the transaxle in the optimum gear and the driver may sense that the transaxle is not shifting, however this does not indicate an abnormality.

### ▼ Shift-Lock System

**The shift-lock system prevents shifting out of P unless the brake pedal is depressed.**

To shift from P:

1. Depress and hold the brake pedal.
2. Start the engine.
3. Move the shift lever.

#### NOTE

- When the ignition is switched off, the shift lever cannot be shifted from P.
- To be sure the vehicle is in park, **the ignition key cannot be removed unless the shift lever is in P.**
- **(With Advanced Key)**  
The ignition cannot be switched from ACC to OFF when the shift lever is not in P.

### ▼ Shift-Lock Override

If the shift lever will not move from P using the proper shift procedure, continue to hold down the pedal.

1. Remove the shift-lock override cover using a cloth-wrapped flat head screwdriver.
2. Insert a screwdriver and push it down.

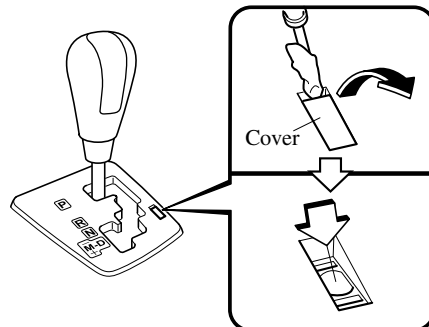

Driving Your Mazda

## Starting and Driving

3. Move the shift lever.
4. Take the vehicle to an Authorized Mazda Dealer to have the system checked.

### ▼ Manual Shift Mode

This mode gives you the feel of driving a manual transaxle vehicle by operating the shift lever and allows you to control engine rpm and torque to the front wheels much like a manual transaxle when more control is desired.

To change to manual shift mode, shift the lever from D to M.

#### **NOTE**

*Changing to manual shift mode while driving will not damage the transaxle.*

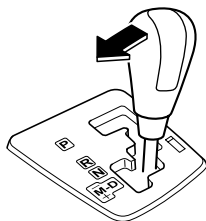

To return to automatic shift mode, shift the lever from M to D.

#### **NOTE**

- If you change to manual shift mode when the vehicle is stopped, the gear will shift to M1.
- If you change to manual shift mode without depressing the accelerator pedal when driving in D range, 5th gear, the gear will shift to M4.
- **(SKYACTIV-G 2.0 model)**  
If you change to manual shift mode without depressing the accelerator pedal when driving in D range, 6th gear, the gear will shift to M5.

#### **Indicators**

##### **Manual shift mode indicator**

In manual shift mode, the “M” of the shift position indicator in the instrument panel illuminates.

##### **Gear position indicator**

The numeral for the selected gear illuminates.

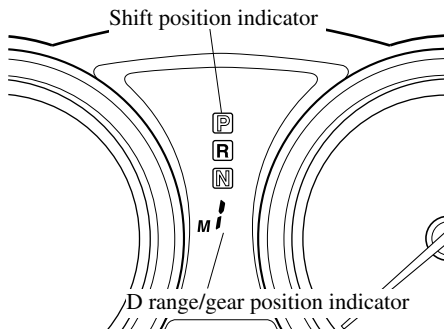

## Driving Your Mazda Starting and Driving

### NOTE

- If the gears cannot be shifted down when driving at higher speeds, the gear position indicator will flash twice to signal that the gears cannot be shifted down (to protect the transaxle).
- If the automatic transaxle fluid (ATF) temperature becomes too high, there is the possibility that the transaxle will switch to automatic shift mode, canceling manual shift mode and turning off the gear position indicator illumination. This is a normal function to protect the AT. After the ATF temperature has decreased, the gear position indicator illumination turns back on and driving in manual shift mode is restored.

### Shifting

#### Manually Shifting up

(M1 → M2 → M3 → M4 → M5 → M6\*)

To shift up to a higher gear, tap the shift lever back (+) once.

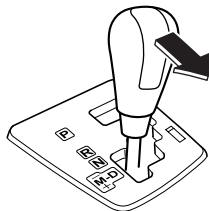

### NOTE

- When driving slowly, the gears may not shift up.
- In manual shift mode, gears do not shift up automatically. Do not run the engine with the tachometer needle in the RED ZONE. If the tachometer needle enters the RED ZONE, you may feel engine-braking because the fuel delivery will be stopped to protect the engine. However, this does not indicate an abnormality.
- When depressing the accelerator fully, the transaxle will shift to a lower gear, depending on vehicle speed (Except M2 → M1).

#### Manually Shifting down

(M6\* → M5 → M4 → M3 → M2 → M1)

To shift down to a lower gear, tap the shift lever forward (-) once.

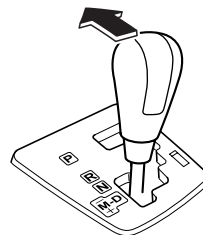

Driving Your Mazda

## Starting and Driving

### **⚠ WARNING**

**Do not use engine braking on slippery road surfaces or at high speeds:**

*Shifting down while driving on wet, snowy, or frozen roads, or while driving at high speeds causes sudden engine braking, which is dangerous. The sudden change in tire speed could cause the tires to skid. This could lead to loss of vehicle control and an accident.*

### **NOTE**

- When driving at high speeds, the gear may not shift down.
- During deceleration, the gear may automatically shift down depending on vehicle speed.
- When depressing the accelerator fully, the transaxle will shift to a lower gear, depending on vehicle speed (Except M2 → M1).

### **Second gear fixed mode**

When the shift lever is tapped back (+) while the vehicle is stopped or driven at the following speeds, the transaxle is set in the second gear fixed mode.

**SKYACTIV-G 2.0 model:**

10.1 km/h (6.27 mph) or less

**MZR 2.0, MZR 2.5 model:**

12 km/h (7.5 mph) or less

The gear is fixed in second while in this mode for easier starting and driving on slippery roads. If the shift lever is tapped back (+) or forward (-) while in the second gear fixed mode, the mode will be canceled.

### **Shifting specification**

#### **Shifting up**

If the vehicle speed is lower than the speed specified for each gear, the gear cannot be shifted up to a higher gear. (MZR 2.0)

| Gear    | Vehicle speed  |
|---------|--|
| M1 → M2 | You can shift up to M2 whether the vehicle is stopped or moving. |
| M2 → M3 | 20.5 km/h (12.8 mph)   |
| M3 → M4 | 37 km/h (23 mph)   |
| M4 → M5 |  |

(SKYACTIV-G 2.0)

| Gear    | Vehicle speed        |
|---------|----------------------|
| M1 → M2 | 10.1 km/h (6.28 mph) |
| M2 → M3 | 25.6 km/h (16.0 mph) |
| M3 → M4 | 35.2 km/h (21.9 mph) |
| M4 → M5 | 55 km/h (35 mph)     |
| M5 → M6 | 70 km/h (44 mph)     |

(MZR 2.5)

| Gear    | Vehicle speed  |
|---------|--|
| M1 → M2 | You can shift up to M2 whether the vehicle is stopped or moving. |
| M2 → M3 | 20.5 km/h (12.8 mph)   |
| M3 → M4 | 34 km/h (22 mph)   |
| M4 → M5 |  |

#### **Shifting down**

If the vehicle speed is higher than the speed specified for each gear, the gear cannot be shifted to a lower gear so as to protect the transaxle.

(MZR 2.0)

| Gear    | Vehicle speed      |
|---------|--------------------|
| M5 → M4 | 213 km/h (132 mph) |
| M4 → M3 | 153 km/h (95 mph)  |
| M3 → M2 | 100 km/h (62 mph)  |
| M2 → M1 | 40 km/h (24 mph)   |



## Starting and Driving

### (SKYACTIV-G 2.0)

| Gear    | Vehicle speed          |
|---------|------------------------|
| M6 → M5 | 271.1 km/h (168.4 mph) |
| M5 → M4 | 192 km/h (119 mph)     |
| M4 → M3 | 132.2 km/h (82.14 mph) |
| M3 → M2 | 94.9 km/h (58.9 mph)   |
| M2 → M1 | 54 km/h (33 mph)       |

### (MZR 2.5)

| Gear    | Vehicle speed      |
|---------|--------------------|
| M5 → M4 | 196 km/h (121 mph) |
| M4 → M3 | 135 km/h (83 mph)  |
| M3 → M2 | 90 km/h (55 mph)   |
| M2 → M1 | 37 km/h (22 mph)   |

### NOTE

Regarding the vehicle speed at the highest gear indicated above, achieving this speed may not actually be possible depending on various driving conditions such as the wind, upslope, and road surface.

During deceleration, the gears shift down automatically when speed is reduced to the following:

### (SKYACTIV-G 2.0)

| Gear    | Vehicle speed        |
|---------|----------------------|
| M6 → M5 | 66.8 km/h (41.5 mph) |
| M5 → M4 | 53 km/h (32 mph)     |
| M4 → M3 | 32 km/h (19 mph)     |
| M3 → M2 | 13.7 km/h (8.51 mph) |
| M2 → M1 | 7.1 km/h (4.4 mph)   |

### (MZR 2.0, MZR 2.5)

| Gear          | Vehicle speed    |
|---------------|------------------|
| M5 or M4 → M3 | 31 km/h (19 mph) |
| M3 or M2 → M1 | 10 km/h (6 mph)  |

### NOTE

The gear does not shift down to M1 automatically while in the second gear fixed mode.

If the vehicle is kicked down at the following speeds or lower, the gears shift down automatically:

### (MZR 2.0)

| Gear    | Vehicle speed      |
|---------|--------------------|
| M5 → M4 | 199 km/h (123 mph) |
| M4 → M3 | 146 km/h (90 mph)  |
| M3 → M2 | 54 km/h (33 mph)   |

### (SKYACTIV-G 2.0)

| Gear    | Vehicle speed          |
|---------|------------------------|
| M6 → M5 | 248.5 km/h (154.4 mph) |
| M5 → M4 | 160 km/h (99.4 mph)    |
| M4 → M3 | 66.1 km/h (41.0 mph)   |
| M3 → M2 | 47.4 km/h (29.4 mph)   |

### (MZR 2.5)

| Gear    | Vehicle speed      |
|---------|--------------------|
| M5 → M4 | 183 km/h (113 mph) |
| M4 → M3 | 126 km/h (78 mph)  |
| M3 → M2 | 51 km/h (31 mph)   |

## Recommendations for shifting

### Upshifting

For normal acceleration and cruising, we recommend these shift points.

### (SKYACTIV-G 2.0)

| Gear     | Vehicle speed    |
|----------|------------------|
| M1 to M2 | 24 km/h (15 mph) |
| M2 to M3 | 40 km/h (25 mph) |
| M3 to M4 | 65 km/h (40 mph) |
| M4 to M5 | 73 km/h (45 mph) |
| M5 to M6 | 81 km/h (50 mph) |

### (MZR 2.0, MZR 2.5)

| Gear     | Vehicle speed    |
|----------|------------------|
| M1 to M2 | 24 km/h (15 mph) |
| M2 to M3 | 40 km/h (25 mph) |
| M3 to M4 | 65 km/h (40 mph) |
| M4 to M5 | 73 km/h (45 mph) |

Driving Your Mazda

## Starting and Driving

---

### **Downshifting**

When you must slow down in heavy traffic or on a steep **upgrade**, downshift before the engine starts to overwork. This gives better acceleration when you need more speed.

On a steep **downgrade**, downshifting helps maintain safe speed and prolongs brake life.

### **▼ Driving Tips**

#### **⚠ WARNING**

*Do not allow the vehicle to move in reverse on an up-slope while the selector lever is in a forward gear position, or move forward on a down-slope while the selector lever is in the reverse position.*

*Otherwise, the engine will stop, causing the loss of the power brake and power steering functions, and make it difficult to control the vehicle which could result in an accident.*

### **Passing**

For extra power when passing another vehicle or climbing steep grades, depress the accelerator fully. The transaxle will shift to a lower gear, depending on vehicle speed.

### **Climbing steep grades from a stop**

To climb a steep grade from a stopped position:

1. Depress the brake pedal.
2. Shift to D or M1, depending on the load weight and grade steepness.
3. Release the brake pedal while gradually accelerating.

### **Descending steep grades**

When descending a steep grade, shift to lower gears, depending on load weight and grade steepness. Descend slowly, using the brakes only occasionally to prevent them from overheating.

Driving Your Mazda  
**Starting and Driving**

## Power Steering

Power steering is only operable when the engine is running. If the engine is off or if the power steering system is inoperable, you can still steer, but it requires more physical effort.

If the steering feels stiffer than usual during normal driving, consult an Authorized Mazda Dealer.

### CAUTION

*Never hold the steering wheel to the extreme left or right for more than 5 seconds with the engine running. This could damage the power steering system.*

### ▼ Power Steering Malfunction Indicator Light



This indicator light illuminates when the ignition is switched ON, and turns off when the engine is started.

If the light remains illuminated after the engine is started, or illuminates while driving, turn off the engine after parking in a safe place, and then start the engine again.

If the light does not illuminate after restarting the engine, this indicates that the power steering is restored and normal steering is possible.

If the light remains illuminated, the power steering is still inoperable. Consult an Authorized Mazda Dealer.

### NOTE

- *The power steering system is inoperable when the power steering malfunction indicator light illuminates. Steering is possible, but requires more physical effort.*
- *Repeatedly jerking the steering wheel left and right while the vehicle is stopped or moving at slow speeds will cause the power steering system to go into protective mode which will make the steering feel heavy, but this does not indicate a malfunction. If this occurs, park the vehicle safely and wait a few minutes for the system to return to normal.*

Driving Your Mazda

## Starting and Driving

### Cruise Control\*

With cruise control, you can set and automatically maintain any speed of more than about 32 km/h (20 mph).

#### **⚠ WARNING**

**Do not use the cruise control under the following conditions:**

*Using the cruise control under the following conditions is dangerous and could result in loss of vehicle control.*

- Hilly terrain
- Steep inclines
- Heavy or unsteady traffic
- Slippery or winding roads
- Similar restrictions that require inconsistent speed

#### ▼ **Cruise Main Indicator Light (Amber)/Cruise Set Indicator Light (Green)**

# CRUISE

The indicator light has two colors.

#### **Cruise Main Indicator Light (Amber)**

The indicator light illuminates amber when the ON switch is pressed and the cruise control system is activated.

#### **Cruise Set Indicator Light (Green)**

The indicator light illuminates green when a cruising speed has been set.

#### ▼ **Activation/Deactivation**

To activate the system, press the ON switch.

To deactivate the system, press the OFF switch.

**(Type A)**

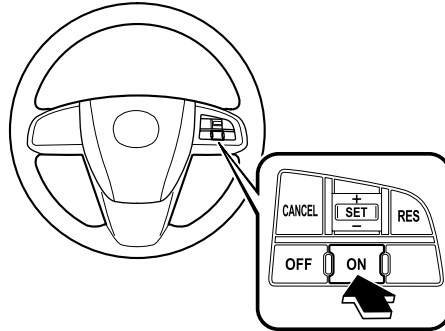

**(Type B)**

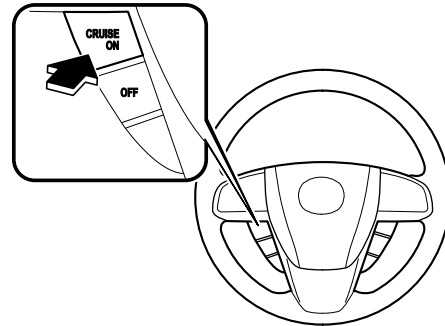

## Driving Your Mazda Starting and Driving

### **⚠ WARNING**

**Always turn off the cruise control system when it is not in use:**

*Leaving the cruise control system in an activation-ready state while the cruise control is not in use is dangerous as the cruise control could unexpectedly activate if the activation button is accidentally pressed, and result in loss of vehicle control and an accident.*

### ▼ To Set Speed

#### Type A

1. Activate the cruise control system by pressing the ON switch.
2. Accelerate to the desired speed, which must be more than 32 km/h (20 mph).
3. Set the cruise control by pressing the cruise control SET + /SET - switch up or down at the desired speed. The cruise control is set at the moment the cruise control SET + /SET - switch is pressed up or down. Release the accelerator pedal simultaneously.

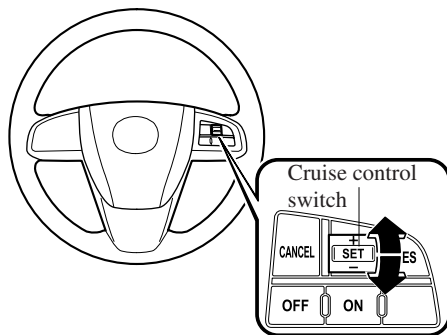

#### **NOTE**

- Release the cruise control switch at the desired speed, otherwise the speed will continue increasing while the switch is pressed up, and continue decreasing while it is pressed down (except when the accelerator pedal is depressed).
- On a steep grade, the vehicle may momentarily slow down while ascending, or speed up while descending.
- Cruise control will turn off if the vehicle speed decreases below 27 km/h (17 mph) when cruise is activated, such as when climbing a steep grade.

#### Type B

1. Activate the cruise control system by pressing the CRUISE ON switch.
2. Accelerate to the desired speed, which must be more than 32 km/h (20 mph).
3. Set the cruise control by pressing the SET + or SET - switch at the desired speed. The cruise control is set at the moment the SET + or SET - switch is pressed. Release the accelerator pedal simultaneously.

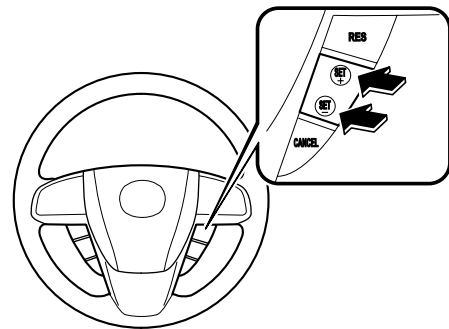

Driving Your Mazda

## Starting and Driving

### NOTE

- Release the SET + or SET- switch at the desired speed, otherwise the speed will continue increasing while the SET + switch is pressed and held, and continue decreasing while the SET- switch is pressed and held (except when the accelerator pedal is depressed).
- On a steep grade, the vehicle may momentarily slow down while ascending, or speed up while descending.
- Cruise control will turn off if the vehicle speed decreases below 27 km/h (17 mph) when cruise is activated, such as when climbing a steep grade.

### ▼ To Increase Cruising Speed

Follow either of these procedures.

#### To increase speed using cruise control switch

##### Type A

Press up the cruise control SET + switch and hold it. Your vehicle will accelerate. Release the switch at the speed you want.

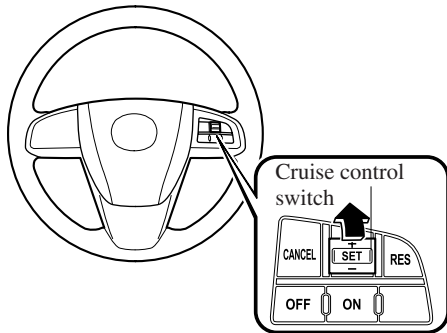

Your vehicle has a tap-up feature that allows you to increase your current speed in increments of 1.6 km/h (1 mph) by a momentary tap of the cruise control SET + switch. Multiple taps will increase your vehicle speed 1.6 km/h (1 mph) for each tap.

##### Type B

Press the SET + switch and hold it. Your vehicle will accelerate. Release the switch at the speed you want.

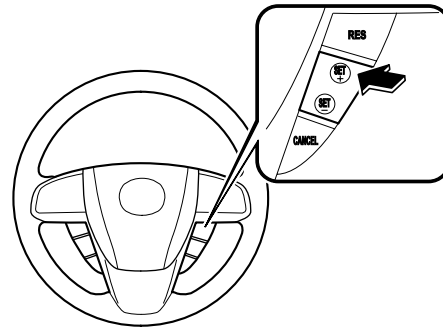

Your vehicle has a tap-up feature that allows you to increase your current speed in increments of 1.6 km/h (1 mph) by a momentary tap of the SET + switch. Multiple taps will increase your vehicle speed 1.6 km/h (1 mph) for each tap.

## Driving Your Mazda Starting and Driving

### **To increase speed using accelerator pedal**

#### **Type A**

Depress the accelerator pedal to accelerate to the desired speed.

Press down or press up on the cruise control SET + /SET - switch and release it immediately.

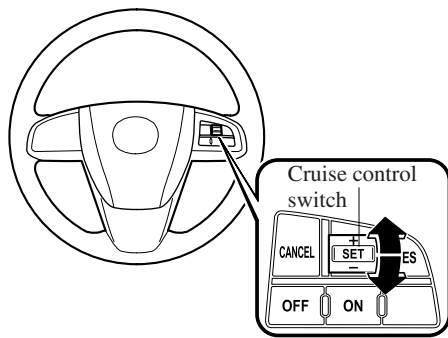

#### **NOTE**

*Accelerate if you want to speed up temporarily when the cruise control is on. Greater speed will not interfere with or change the set speed. Take your foot off the accelerator to return to the set speed.*

#### **Type B**

Depress the accelerator pedal to accelerate to the desired speed. Press the SET + or SET - switch and release it immediately.

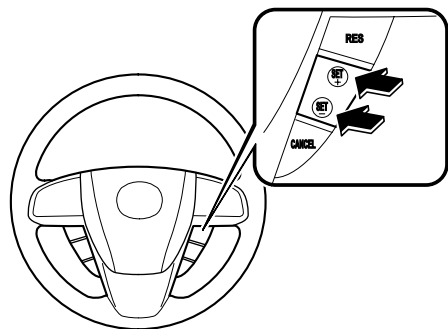

#### **NOTE**

*Accelerate if you want to speed up temporarily when the cruise control is on. Greater speed will not interfere with or change the set speed. Take your foot off the accelerator to return to the set speed.*

### **▼ To Decrease Cruising Speed**

#### **Type A**

Press down the cruise control SET - switch and hold it. The vehicle will gradually slow.

Release the switch at the speed you want.

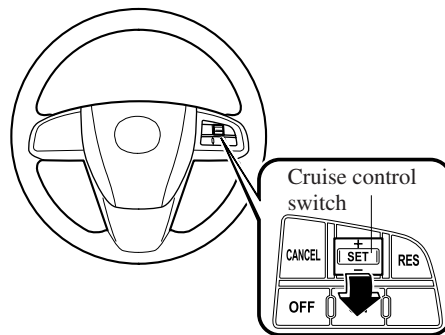

Your vehicle has a tap-down feature that allows you to decrease your current speed in decrements of 1.6 km/h (1 mph) by a momentary tap of the cruise control SET - switch. Multiple taps will decrease your vehicle speed 1.6 km/h (1 mph) for each tap.

Driving Your Mazda

## Starting and Driving

### **Type B**

Press the SET - switch and hold it. The vehicle will gradually slow.  
Release the switch at the speed you want.

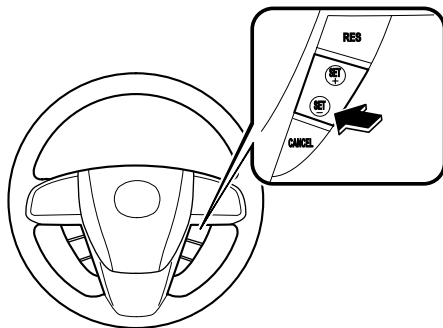

Your vehicle has a tap-down feature that allows you to decrease your current speed in decrements of 1.6 km/h (1 mph) by a momentary tap of the SET- switch. Multiple taps will decrease your vehicle speed 1.6 km/h (1 mph) for each tap.

### **▼ To Resume Cruising Speed at More Than 32 km/h (20 mph)**

If some other method besides the OFF switch was used to cancel cruising speed (such as applying the brake pedal) and the system is still activated, the most recent set speed will automatically resume when the RES switch is pressed.

If vehicle speed is below 32 km/h (20 mph), increase the vehicle speed up to 32 km/h (20 mph) or more and press the RES switch.

### **(Type A)**

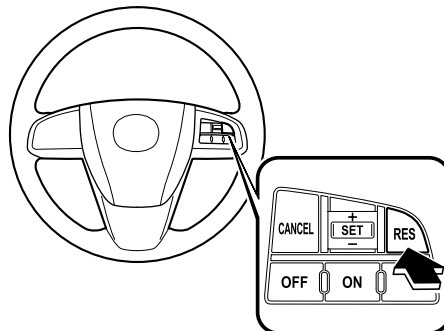

### **(Type B)**

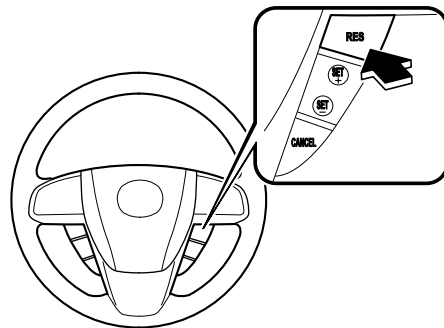

### **▼ To Cancel**

To cancel the system, use **one** of these methods:

- Press the OFF switch.
- Slightly depress the brake pedal.
- Depress the clutch pedal (Manual transaxle only).
- Press the CANCEL switch.



## Driving Your Mazda Starting and Driving

(Type A)

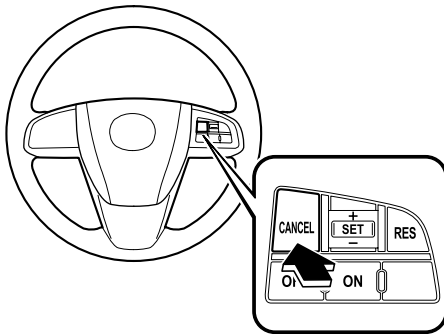

(Type B)

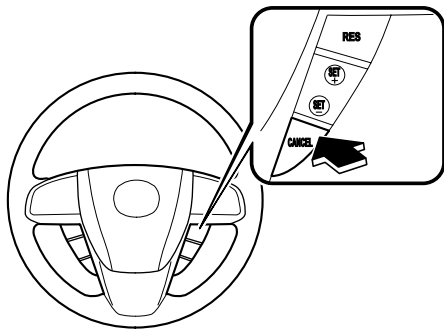

The system turns off when the ignition is switched off.

### NOTE

*Cruise control will cancel at about 15 km/h (9 mph) below the preset speed (such as may happen when climbing a long, steep grade).*

## Traction Control System (TCS)\*

The Traction Control System (TCS) enhances traction and safety by controlling engine torque and braking. When the TCS detects driving wheel slippage, it lowers engine torque and operates the brakes to prevent loss of traction.

This means that on a slick surface, the engine adjusts automatically to provide optimum power to the drive wheels, limiting wheel spin and loss of traction.

## ⚠ WARNING

**Do not rely on the traction control system as a substitute for safe driving:**

*The traction control system (TCS) cannot compensate for unsafe and reckless driving, excessive speed, tailgating (following another vehicle too closely), and hydroplaning (reduced tire friction and road contact because of water on the road surface). You can still have an accident.*

**Use snow tires or tire chains and drive at reduced speeds when roads are covered with ice and/or snow:**

*Driving without proper traction devices on snow and/or ice-covered roads is dangerous. The traction control system (TCS) alone cannot provide adequate traction and you could still have an accident.*

### NOTE

*To turn off the TCS, press the DSC OFF switch (page 5-29).*

\*Some models. **5-27**

Driving Your Mazda

## Starting and Driving

### ▼ TCS/DSC Indicator Light



This indicator light stays on for a few seconds when the ignition is switched ON. If the TCS or DSC is operating, the indicator light flashes.

If the light stays on, the TCS or DSC may have a malfunction and they may not operate correctly. Take your vehicle to an Authorized Mazda Dealer.

#### NOTE

- *In addition to the indicator light flashing, a slight lugging sound will come from the engine. This indicates that the TCS is operating properly.*
- *On slippery surfaces, such as fresh snow, it will be impossible to achieve high rpm when the TCS is on.*

### Dynamic Stability Control (DSC) \*

The Dynamic Stability Control (DSC) automatically controls braking and engine torque in conjunction with systems such as ABS and TCS to help control side slip when driving on slippery surfaces, or during sudden or evasive maneuvering, enhancing vehicle safety.

Refer to ABS (page 5-8) and TCS (page 5-27).

DSC operation is possible at speeds greater than 20 km/h (12 mph).

#### **⚠ WARNING**

**Do not rely on the dynamic stability control as a substitute for safe driving:**

*The dynamic stability control (DSC) cannot compensate for unsafe and reckless driving, excessive speed, tailgating (following another vehicle too closely), and hydroplaning (reduced tire friction and road contact because of water on the road surface). You can still have an accident.*

## Driving Your Mazda Starting and Driving

### **CAUTION**

- The DSC may not operate correctly unless the following are observed:
  - Use tires of the correct size specified for your Mazda on all four wheels.
  - Use tires of the same manufacturer, brand and tread pattern on all four wheels.
  - Do not mix worn tires.
- The DSC may not operate correctly when tire chains are used or a temporary spare tire is installed because the tire diameter changes.

### **NOTE**

After switching the ignition ON, a clicking sound may be heard behind the dashboard. This sound is the result of the DSC system self-check operation and does not indicate an abnormality.

### ▼ TCS/DSC Indicator Light



This indicator light stays on for a few seconds when the ignition is switched ON. If the TCS or DSC is operating, the indicator light flashes.

If the light stays on, the TCS or DSC may have a malfunction and they may not operate correctly. Take your vehicle to an Authorized Mazda Dealer.

### ▼ DSC OFF Indicator Light



This indicator light stays on for a few seconds when the ignition is switched ON.

It also illuminates when the DSC OFF switch is pressed and TCS/DSC is switched off (page 5-29).

If the light stays on when the TCS/DSC is not switched off, take your vehicle to an Authorized Mazda Dealer. The dynamic stability control may have a malfunction.

### ▼ DSC OFF Switch

Press the DSC OFF switch to turn off the TCS/DSC. The DSC OFF indicator light illuminates.



Press the switch again to turn the TCS/DSC back on. The DSC OFF indicator light turns off.

Driving Your Mazda

## Starting and Driving

---

### **NOTE**

- *When DSC is on and you attempt to free the vehicle when it is stuck, or drive it out of freshly fallen snow, the TCS (part of the DSC system) will activate. Depressing the accelerator will not increase engine power and freeing the vehicle may be difficult. When this happens, turn off the TCS/DSC.*
- *If the TCS/DSC is off when the engine is turned off, it automatically activates when the ignition is switched ON.*
- *Leaving the TCS/DSC on will provide the best stability.*
- *The DSC only operates when the brake pedal is depressed while driving and it is determined that operation of the DSC is required, even if the DSC OFF indicator light illuminates by pressing the DSC OFF switch.*
- *The TCS/DSC can be cancelled. By pressing the DSC OFF switch for more than five seconds, the DSC OFF indicator light illuminates, and the TCS/DSC is cancelled.*

*The TCS/DSC remains cancelled until the ignition is switched off. When the ignition is switched from OFF to ON, the system turns back on automatically.*

Driving Your Mazda  
**Starting and Driving**

### Tire Pressure Monitoring System\*

The tire pressure monitoring system (TPMS) monitors the pressure for each tire. If tire pressure is too low in one or more tires, the system will inform the driver via the warning light in the instrument panel and by the warning beep sound.

The tire pressure sensors installed on each wheel send tire pressure data by radio signal to the receiver unit in the vehicle.

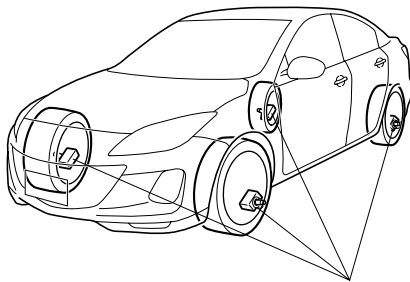

Tire pressure sensors

**NOTE**

*When the ambient temperature is low due to seasonal changes, tire temperatures are also lower. When the tire temperature decreases, the air pressure decreases as well. The TPMS warning light may illuminate more frequently. Visually inspect the tires daily before driving, and check tire pressures monthly with a tire pressure gauge. When checking tire pressures, use of a digital tire pressure gauge is recommended.*

TPMS does not alleviate your need to check the pressure and condition of all four tires regularly.

Driving Your Mazda

## Starting and Driving

---

### CAUTION

- Each tire, including the spare (if provided), should be checked monthly when cold and inflated to the inflation pressure recommended by the vehicle manufacturer on the vehicle placard or tire inflation pressure label. (If your vehicle has tires of a different size than the size indicated on the vehicle placard or tire inflation pressure label, you should determine the proper tire inflation pressure for those tires.)

As an added safety feature, your vehicle has been equipped with a tire pressure monitoring system (TPMS) that illuminates a low tire pressure telltale when one or more of your tires is significantly under-inflated. Accordingly, when the low tire pressure telltale illuminates, you should stop and check your tires as soon as possible, and inflate them to the proper pressure. Driving on a significantly under-inflated tire causes the tire to overheat and can lead to tire failure. Underinflation also reduces fuel efficiency and tire tread life, and may affect the vehicle's handling and stopping ability.

Please note that the TPMS is not a substitute for proper tire maintenance, and it is the driver's responsibility to maintain correct tire pressure, even if underinflation has not reached the level to trigger illumination of the TPMS low tire pressure telltale.

- Your vehicle has also been equipped with a TPMS malfunction indicator to indicate when the system is not operating properly. The TPMS malfunction indicator is combined with the low tire pressure telltale. When the system detects a malfunction, the telltale will flash for approximately one minute and then remain continuously illuminated. This sequence will continue upon subsequent vehicle start-ups as long as the malfunction exists. When the malfunction indicator is illuminated, the system may not be able to detect or signal low tire pressure as intended. TPMS malfunctions may occur for a variety of reasons, including the installation of replacement or alternate tires or wheels on the vehicle that prevent the TPMS from functioning properly. Always check the TPMS malfunction telltale after replacing one or more tires or wheels on your vehicle to ensure that the replacement or alternate tires and wheels allow the TPMS to continue to function properly.
- To avoid false readings, the system samples for a little while before indicating a problem. As a result it will not instantaneously register a rapid tire deflation or blow out.

### NOTE

This device complies with part 15 of the FCC Rules. Operation is subject to the following two conditions: (1) This device may not cause harmful interference, and (2) this device must accept any interference received, including interference that may cause undesired operation.

## Starting and Driving

### ▼ Tire Pressure Monitoring System Warning Light



This warning light illuminates for a few seconds when the ignition is switched ON.

Thereafter, the warning light illuminates and a beep is heard when tire pressure is too low in one or more tires, and flashes when there is a system malfunction.

### **⚠ WARNING**

*If the tire pressure monitoring system warning light illuminates or flashes, or the tire pressure warning beep sound is heard, decrease vehicle speed immediately and avoid sudden maneuvering and braking:*

*If the tire pressure monitoring system warning light illuminates or flashes, or the tire pressure warning beep sound is heard, it is dangerous to drive the vehicle at high speeds, or perform sudden maneuvering or braking. Vehicle drivability could worsen and result in an accident. To determine if you have a slow leak or a flat, pull over to a safe position where you can check the visual condition of the tire and determine if you have enough air to proceed to a place where air may be added and the system monitored again by an Authorized Mazda Dealer or a tire repair station.*

**Do not ignore the TPMS Warning Light:**  
*Ignoring the TPMS warning light is dangerous, even if you know why it is illuminated. Have the problem taken care of as soon as possible before it develops into a more serious situation that could lead to tire failure and a dangerous accident.*

### **Warning light illuminates/Warning beep sounds**

When the warning light illuminates, and the warning beep sound is heard (about 3 seconds), tire pressure is too low in one or more tires.

Driving Your Mazda

## Starting and Driving

Adjust the tire pressure to the correct tire pressure. Refer to the specification charts (page 10-12).

### CAUTION

*When replacing/repairing the tires or wheels or both, have the work done by an Authorized Mazda Dealer, or the tire pressure sensors may be damaged.*

### NOTE

- *Perform tire pressure adjustment when the tires are cold. Tire pressure will vary according to the tire temperature, therefore let the vehicle stand for 1 hour or only drive it 1.6 km (1 mile) or less before adjusting the tire pressures. When pressure is adjusted on hot tires to the cold inflation pressure, the TPMS warning light/beep may turn on after the tires cool and pressure drops below specification. Also, an illuminated TPMS warning light, resulting from the tire air pressure dropping due to cold ambient temperature, may turn off if the ambient temperature rises. In this case, it will also be necessary to adjust the tire air pressures. If the TPMS warning light illuminates due to a drop in tire air pressure, make sure to check and adjust the tire air pressures.*
- *After adjusting the tire air pressures, it may require some time for the TPMS warning light to turn off. If the TPMS warning light remains illuminated, drive the vehicle at a speed of at least 25 km/h (16 mph) for 10 minutes, and then verify that it turns off.*
- *Tires lose air naturally over time and the TPMS cannot tell if the tires are getting too soft over time or you have a flat. However, when you find one low tire in a set of four—that is an indication of trouble; you should have someone drive the vehicle slowly forward so you can inspect any low tire for cuts and any metal objects sticking through tread or sidewall. Put a few drops of water in the valve stem to see if it bubbles indicating a bad valve. Leaks need to be addressed by more than simply refilling the trouble tire as leaks are dangerous - take it to an Authorized Mazda Dealer which has all the equipment to fix tires, TPMS systems and order the best replacement tire for your vehicle.*



## Driving Your Mazda Starting and Driving

If the warning light illuminates again even after the tire pressures are adjusted, there may be a tire puncture. Replace the punctured tire with the temporary spare tire (page 7-9).

### **NOTE**

*A tire pressure sensor is not installed to the temporary spare tire. The warning light will flash continuously while the temporary spare tire is being used.*

### **Warning light flashes**

When the warning light flashes, there may be a system malfunction. Consult an Authorized Mazda Dealer.

### **▼ System Error Activation**

When the TPMS warning light flashes, there may be a system malfunction. Consult an Authorized Mazda Dealer. A system error activation may occur in the following cases:

- When there is equipment or a device near the vehicle using the same radio frequency as that of the tire pressure sensors.
- When using the following devices in the vehicle that may cause radio interference with the receiver unit.
  - A digital device such as a personal computer.
  - A current converter device such as a DC-AC converter.
- When excess snow or ice adheres to the vehicle, especially around the wheels.
- When the tire pressure sensor batteries are exhausted.
- When using a wheel with no tire pressure sensor installed.
- When using tires with steel wire reinforcement in the side walls.
- When using tire chains.

### **▼ Tires and Wheels**

#### **⚠ CAUTION**

*When inspecting or adjusting the tire air pressures, do not apply excessive force to the stem part of the wheel unit. The stem part could be damaged.*

### **Changing tires and wheels**

The following procedure allows the TPMS to recognize a tire pressure sensor's unique ID signal code whenever tires or wheels are changed, such as changing to and from winter tires.

### **NOTE**

*Each tire pressure sensor has a unique ID signal code. The signal code must be registered with the TPMS before it can work. The easiest way to do it is to have an Authorized Mazda Dealer change your tire and complete ID signal code registration.*

### **When having tires changed at an Authorized Mazda Dealer**

When an Authorized Mazda Dealer changes your vehicle's tires, they will complete the tire pressure sensor ID signal code registration.

### **When changing tires yourself**

If you or someone else changes tires, you or someone else can also undertake the steps for the TPMS to complete the ID signal code registration.

1. After tires have been changed, switch the ignition ON, then back to ACC or OFF.
2. Wait for about 15 minutes.

Driving Your Mazda

## Starting and Driving

3. After about 15 minutes, drive the vehicle at a speed of at least 25 km/h (16 mph) for 10 minutes and the tire pressure sensor ID signal code will be registered automatically.

### **NOTE**

*If the vehicle is driven within about 15 minutes of changing tires, the tire pressure monitoring system warning light will flash because the sensor ID signal code would not have been registered. If this happens, park the vehicle for about 15 minutes, after which the sensor ID signal code will register upon driving the vehicle for 10 minutes.*

### **Replacing tires and wheels**

#### **CAUTION**

- *When replacing/repairing the tires or wheels or both, have the work done by an Authorized Mazda Dealer, or the tire pressure sensors may be damaged.*
- *The wheels equipped on your Mazda are specially designed for installation of the tire pressure sensors. Do not use non-genuine wheels, otherwise it may not be possible to install the tire pressure sensors.*

Be sure to have the tire pressure sensors installed whenever tires or wheels are replaced.

When having a tire or wheel or both replaced, the following types of tire pressure sensor installations are possible.

- The tire pressure sensor is removed from the old wheel and installed to the new one.
- The same tire pressure sensor is used with the same wheel. Only the tire is replaced.

- A new tire pressure sensor is installed to a new wheel.

### **NOTE**

- *The tire pressure sensor ID signal code must be registered when a new tire pressure sensor is purchased. For purchase of a tire pressure sensor and registration of the tire pressure sensor ID signal code, consult an Authorized Mazda Dealer.*
- *When reinstalling a previously removed tire pressure sensor to a wheel, replace the grommet (seal between valve body/sensor and wheel) for the tire pressure sensor.*

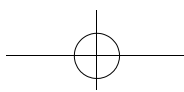

Driving Your Mazda  
**Starting and Driving**

**Blind Spot Monitoring (BSM) System\***

The Blind Spot Monitoring (BSM) system is designed to assist the driver by monitoring blind spots on both sides of the vehicle to the rear in certain situations such as when changing lanes on roads and freeways.

The BSM system monitors the detection areas on both sides of the vehicle to the rear when the vehicle speed is about 32 km/h (20 mph) or more, and notifies the driver of vehicles in the detection area by illuminating the BSM warning light.

If the turn signal lever is operated in the direction the BSM warning light is illuminated, the system warns the driver of the vehicle in the detection area with a beep sound.

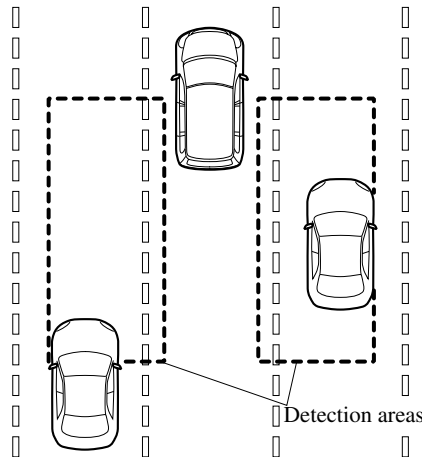

**⚠ WARNING**

**Do not rely completely on the BSM system and be sure to look over your shoulder before changing lanes:**

*The BSM system can assist the driver in confirming the safety of the surroundings but is not a complete substitute. The driver is responsible for assuring lane changes and other maneuvers. Always pay attention to the direction in which the vehicle is traveling and the vehicle's surroundings.*

**NOTE**

- The BSM system does not operate when the vehicle speed is lower than about 32 km/h (20 mph).
- The radar sensors are equipped inside the rear bumper. (page 5-40)
- The radar sensors do not detect human, animal, or static objects such as fences. In addition, the system pauses when the selector lever is shifted to the R position. (The system resumes automatically when the selector lever is shifted from the R position.)

\*Some models. **5-37**

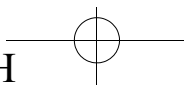

Driving Your Mazda

## Starting and Driving

---

- *The detectability of the radar sensors has its limitations. The BSM system may not operate properly under the following conditions:*
  - *Ice, snow, or soil adheres to the rear bumper surface around the radar sensors.*
  - *During adverse weather conditions such as rain or snow, or under conditions where water is sprayed.*
  - *The rear bumper area around the radar sensors is blocked by foreign material (such as stickers or a bicycle carrier).*
- *The radar sensors may not detect all types of vehicles around your vehicle, especially the following types of vehicles:*
  - *Motorcycles*
  - *Vehicles with body shapes that radar may not reflect such as a flatbed trailer with no cargo.*
  - *Vehicles with lower body height such as sports cars.*
- *Have the radar sensors inspected at an Authorized Mazda Dealer if any shock is applied to the rear bumper, even in a minor accident. If the vehicle is driven with a damaged radar sensor, the system may not operate properly resulting in an accident.*
- *For repairs or paintwork around the radar sensors, or replacement of the bumper, consult an Authorized Mazda Dealer.*
- *The radar sensors of the BSM system may be regulated under the radio wave related laws of the country where the vehicle is driven. The sensors in this system are approved for use in the U.S.A. (including territories), Canada, and Mexico. If a vehicle with a BSM system is driven in a country other than the U.S.A., Canada, or Mexico, the system has to be turned off using the BSM OFF switch.*
- *The detection area of the system has been determined based on the lane width of general freeways. Therefore on a road with a narrower lane width, the system may detect vehicles on a lane next to the adjacent lane and operate the warning light/beep. On a road with wider lane width, the system may not detect vehicles on the adjacent lane and may not operate the warning light/beep.*
- *Operation of the warning light/beep may be delayed or the system may not operate the warning light/beep under the following conditions:*
  - *The vehicle accelerates from a standing-start with a vehicle alongside.*
  - *A vehicle moves from a lane two lanes over to the adjacent lane.*
  - *The difference in vehicle speed between your vehicle and another vehicle is larger when passing or being passed, and the vehicle passes the detection area within a short period of time.*
  - *On a steep incline, or when there is a difference in height between lanes.*
  - *Immediately after the system has been activated by pressing the BSM OFF switch again after it has been turned off (BSM OFF indicator light in instrument panel illuminates) by pressing the switch.*
- *Although the system may detect objects on the road side such as parked vehicles or guardrails and operate the warning light/beep, it does not indicate a malfunction.*
- *If the vehicle is driven on a road with less traffic and few vehicles that the radar sensors can detect, the system may pause (The BSM OFF indicator light in the instrument panel flashes). However, it does not indicate a malfunction.*

## Driving Your Mazda Starting and Driving

- The following conditions may affect the visibility of the BSM warning lights on the outside mirror, making it difficult to confirm the illumination of the lights:
  - Ice or snow adheres to the surface of the outside mirrors.
  - The door window glass is tinted.

### ▼ BSM Warning Light/Beep

#### **BSM warning light**

Equipped on the left and right door mirrors.

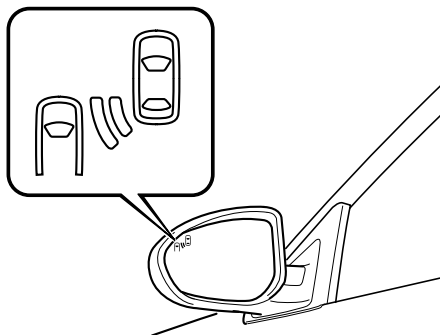

This warning light illuminates for a few seconds when the ignition is switched ON.

If the BSM system detects a vehicle in the detection area while the vehicle is driven at a speed of about 32 km/h (20 mph) or more, the BSM warning light illuminates on the side of the vehicle where the rear on-coming vehicle is detected.

#### ***NOTE***

- If ice or snow adhere to the outer mirror surface, the BSM warning light may not be visible.
- If the door window glass is tinted, it may affect the visibility of the BSM warning light, making it difficult to confirm the illumination of the light.

#### **BSM warning beep**

The warning beep operates when the turn signal lever is operated to the side where the BSM warning light is illuminated.

#### ***NOTE***

A personalized function is available to change the BSM warning beep sound volume. Refer to Settings on page 6-186.

### ▼ BSM OFF Indicator Light

# BSM OFF

This indicator light illuminates for a few seconds when the ignition is switched ON.

The BSM OFF indicator light illuminates when the BSM system is turned off by pressing the BSM OFF switch. The indicator light flashes if the BSM system has a malfunction. Consult an Authorized Mazda Dealer.

#### ***NOTE***

If the vehicle is driven on a road with less traffic and few vehicles that the radar sensors can detect, the system may pause (The BSM OFF indicator light in the instrument panel flashes). However, it does not indicate a malfunction.

Driving Your Mazda

## Starting and Driving

### ▼ BSM OFF Switch

When the BSM switch is pressed, the BSM system turns off and the BSM OFF indicator light illuminates.

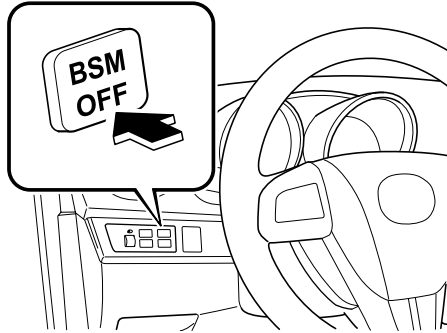

Press the BSM OFF switch again to turn on the BSM system. The BSM OFF indicator light turns off.

#### **NOTE**

*If the ignition is switched off with the BSM system turned off, the system becomes operable automatically when the ignition is switched ON.*

### ▼ Care of Radar Sensors

The radar sensors are equipped inside the rear bumper.

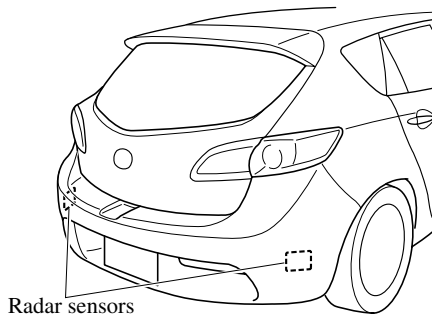

5-40

Always keep the bumper surface near the radar sensor area clean so that the BSM system operates normally. Refer to the Exterior Care (page 8-67).

#### **NOTE**

- *The BSM OFF indicator light flashes if the radar sensors cannot operate normally. If the light remains flashing after cleaning the bumper surface near the radar sensor area, consult an Authorized Mazda Dealer.*
- *For repairs or paintwork around the radar sensors, or replacement of the bumper, consult an Authorized Mazda Dealer.*

### ▼ Safety Certification

#### **Radiation Hazard**

This BSM (blind spot monitoring) device emits intentional electromagnetic radiation in the 24 GHz to 25 GHz frequency range. The total radiated average power over the entire bandwidth is below  $-14$  dBm ( $40 \mu\text{W}$ ). The active emitting antenna surface is  $72 \text{ cm}^2$ ; therefore the radiated power density in front of the BSM device is  $0.55 \mu\text{W}/\text{cm}^2$ . This value is far below the legal human exposure protection limit of  $1 \text{ mW}/\text{cm}^2$  (MPE) in Europe and US.

#### **Declaration of compliance for 24 GHz blind spot radar**

(U.S.A)

#### **FCC ID: OAYBSDTX**

This vehicle is equipped with a 24 GHz blind spot monitoring (BSM) radar system, which complies with part 15 of the FCC rules. Operation is subject to the following conditions:

1. This device may not cause harmful interference, and

Driving Your Mazda  
**Starting and Driving**

---

2. This device must accept any interference received, including interference that may cause undesired operation.
3. This device may only work when the vehicle is in operation pursuant to § 15.252 (a) (4).

**(CANADA)**

**IC:4135A-BSDTX**

This vehicle is equipped with a 24 GHz blind spot monitoring (BSM) radar system, which complies with the radio standards specification RSS-220 of Industry Canada. Operation is subject to the following conditions:

1. This device may not cause harmful interference, and
2. This device must accept any interference received, including interference that may cause undesired operation.

**(MEXICO)**

**RLVCOBS10-0567**

**NOTE**

*During printing time of this user manual the approvals listed below are granted. Further countries may become available or actual certification identifiers may be subject to change or update.*

**! WARNING**

*Changes or modifications not expressly approved by the party responsible for compliance could void the user's authority to operate the equipment.*

Driving Your Mazda

## Instrument Cluster and Indicators

### Meters and Gauges

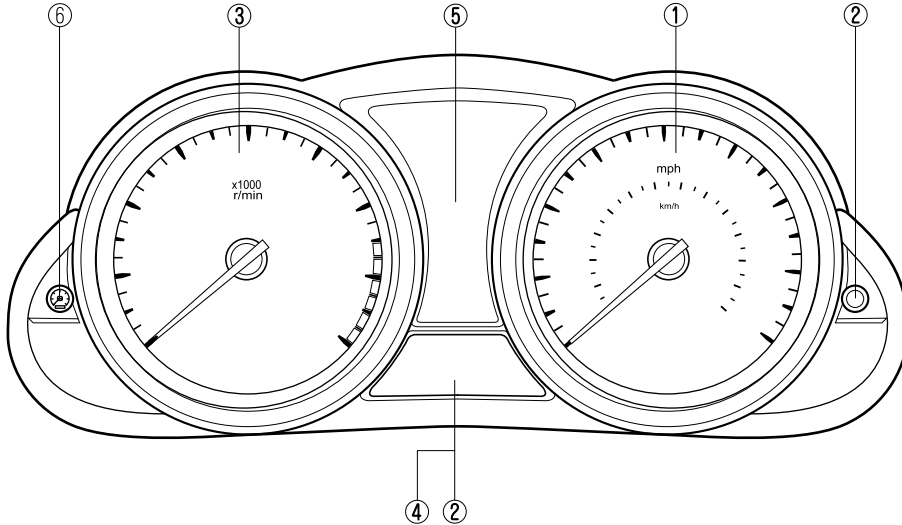

- ① Speedometer ..... page 5-43
- ② Odometer, Trip Meter and Trip Meter Selector ..... page 5-43
- ③ Tachometer ..... page 5-44
- ④ Fuel Gauge ..... page 5-44
- ⑤ Boost Gauge (MZR 2.3 DISI Turbo) ..... page 5-45
- ⑥ Dashboard Illumination ..... page 5-45



## Driving Your Mazda Instrument Cluster and Indicators

### ▼ Speedometer

The speedometer indicates the speed of the vehicle.

### ▼ Odometer, Trip Meter and Trip Meter Selector

The display mode can be changed between trip meter A and trip meter B by pressing the selector while one of them is displayed. The selected mode will be displayed.

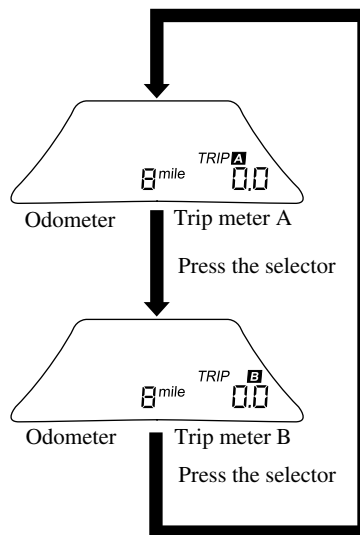
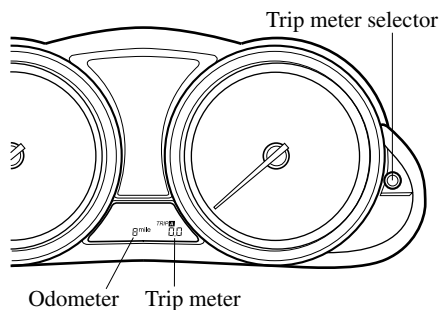

### **NOTE**

When the ignition is switched to ACC or the ignition is switched off, the odometer or trip meters cannot be displayed, however, pressing the selector button can inadvertently switch the trip meters or reset them during an approximate ten-minute period in the following cases:

- After the ignition is switched to ACC or the ignition is switched off from ON.
- After the driver's door is opened.

### **Odometer**

The odometer records the total distance the vehicle has been driven.

### **Trip meter**

The trip meter can record the total distance of two trips. One is recorded in trip meter A, and the other is recorded in trip meter B.

Driving Your Mazda

## Instrument Cluster and Indicators

For instance, trip meter A can record the distance from the point of origin, and trip meter B can record the distance from where the fuel tank is filled.

When trip meter A is selected, pressing the selector again within one second will change to trip meter B mode.

When trip meter A is selected, TRIP A will be displayed. When trip meter B is selected, TRIP B will be displayed.

The trip meter records the total distance the vehicle is driven until the meter is again reset. Return it to "0.0" by holding the selector depressed for 1 second or more. Use this meter to measure trip distances and to compute fuel consumption.

### NOTE

- Only the trip meters record tenths of kilometers (miles).
- The trip record will be erased when:
  - The power supply is interrupted (blown fuse or the battery is disconnected).
  - The vehicle is driven over 999.9 km (mile).

### ▼ Tachometer

The tachometer shows engine speed in thousands of revolutions per minute (rpm).

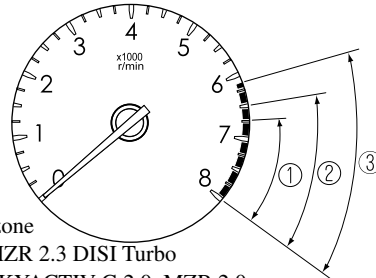

Red zone

- ① MZR 2.3 DISI Turbo
- ② SKYACTIV-G 2.0, MZR 2.0
- ③ MZR 2.5

### ▲ CAUTION

*Do not run the engine with the tachometer needle in the RED ZONE. This may cause severe engine damage.*

### ▼ Fuel Gauge

The fuel gauge shows approximately how much fuel is remaining in the tank when the ignition is switched ON. We recommend keeping the tank over 1/4 full.

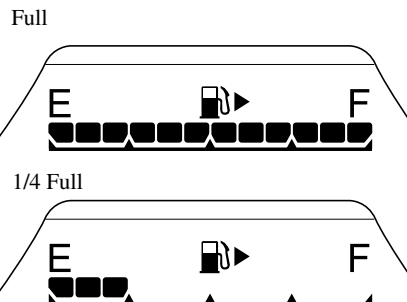

## Driving Your Mazda Instrument Cluster and Indicators

If the gauge indicates that the fuel level is near E, refuel as soon as possible.

### NOTE

- After refueling, it may require some time for the indicator to stabilize. In addition, the indicator may deviate while driving on a slope or curve since the fuel moves in the tank.
- The direction of the arrow (  ) indicates that the fuel-filler lid is on the right side of the vehicle.

### ▼ Boost Gauge (MZR 2.3 DISI Turbo)

The turbo's charging pressure is displayed while driving.

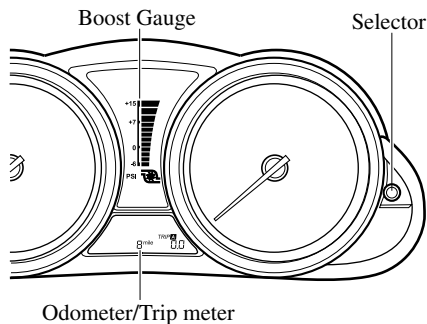

### NOTE

Display of the turbo's charging pressure can be switched off using the following operation.

1. Switch the ignition ON and press the selector six times within five seconds. ON is displayed in the odometer/trip meter. If the selector is pressed while ON is displayed, OFF is displayed.
2. Press the selector for 1 second or longer while OFF is displayed.

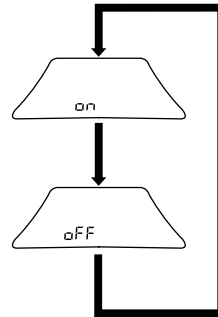

To turn the display on, press the selector as in Step 2 until ON is displayed, then press the selector again for 1 second or longer while ON is displayed.



### ▼ Dashboard Illumination

Rotate the knob to adjust the brightness of the instrument cluster and other illuminations in the dashboard.

### NOTE

- The brightness of dashboard illuminations can be adjusted when the headlight switch is in the  or  position.
- When the dashboard illumination brightness cannot be adjusted any more, a beep sound will be heard.



Driving Your Mazda

## Instrument Cluster and Indicators

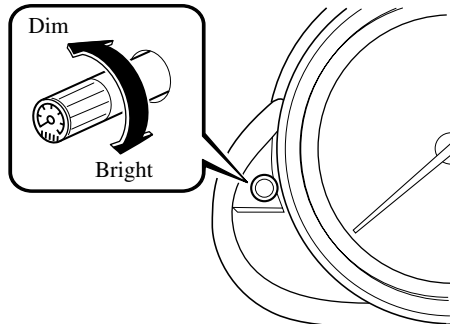
---





### **Canceling the illumination dimmer**

When the headlight switch is in the  or  position, the illumination of the instrument cluster and the information display dims.

When driving on snowy or foggy roads, or in other situations when the instrument cluster or information display's visibility is reduced due to glare from surrounding brightness, cancel the illumination dimmer and increase the illumination intensity.

To cancel the illumination dimmer, press the dashboard illumination knob.

### **NOTE**





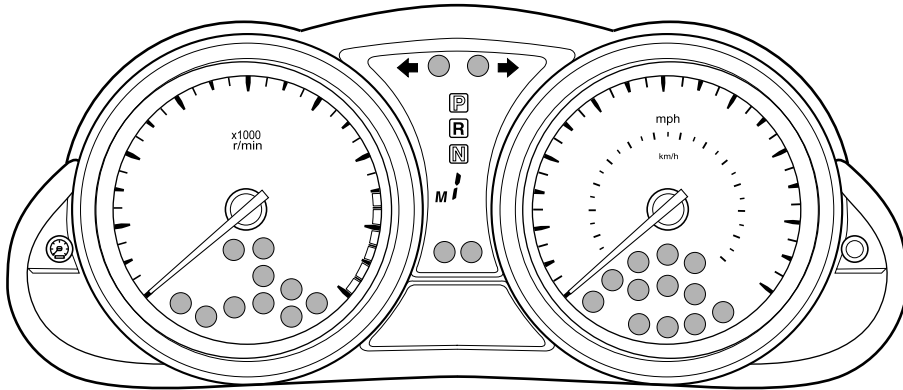

- This symbol () indicates the knob to adjust the brightness of the dashboard illumination.
- If the illumination dimmer is cancelled, the instrument cluster and the information display will not dim when the headlight switch is turned to the  or  position again. Press the dashboard illumination knob to activate the illumination dimmer.

## Warning/Indicator Lights and Beep Sounds

### Warning/Indicator Lights















Warning/Indicator lights will appear in any of the highlighted areas



| Signal   | Warning/Indicator Lights                            | Page |
|--|---|------|
| <br>BRAKE | Brake System Warning Light                          | 5-49 |
|           | Malfunction Warning Light                           | 5-50 |
|           | Charging System Warning Light                       | 5-51 |
|           | Engine Oil Pressure Warning Light                   | 5-51 |
|           | Check Engine Light                                  | 5-52 |
|           | High Engine Coolant Temperature Warning Light (Red) | 5-52 |
|           | ABS Warning Light                                   | 5-50 |

Driving Your Mazda

## Warning/Indicator Lights and Beep Sounds

| Signal  | Warning/Indicator Lights                                  | Page |
|---|---|------|
|    | Air Bag/Front Seat Belt Pretensioner System Warning Light | 5-53 |
|    | Low Fuel Warning Light                                    | 5-53 |
|    | Check Fuel Cap Warning Light                              | 5-53 |
|    | Seat Belt Warning Light                                   | 5-54 |
|    | Door-Ajar Warning Light                                   | 5-54 |
|    | Low Washer Fluid Level Warning Light                      | 5-54 |
| <b>AT</b>   | Automatic Transaxle Warning Light                         | 5-54 |
|    | Tire Pressure Monitoring System Warning Light             | 5-55 |
|   | KEY Warning Light (Red)/KEY Indicator Light (Green)       | 5-57 |
|  | Security Indicator Light                                  | 5-58 |
|  | Headlight High-Beam Indicator Light                       | 5-59 |
| <b>PRNDM</b>  | Shift Position Indicator Light                            | 5-59 |
|  | Low Engine Coolant Temperature Indicator Light (Blue)     | 5-59 |
|  | TCS/DSC Indicator Light                                   | 5-59 |
|  | DSC OFF Indicator Light                                   | 5-60 |
| <b>AFS OFF</b>  | AFS OFF Indicator Light                                   | 5-60 |

## Warning/Indicator Lights and Beep Sounds

| Signal  | Warning/Indicator Lights   | Page |
|---|--|------|
| <b>CRUISE</b>   | Cruise Main Indicator Light (Amber)/Cruise Set Indicator Light (Green) | 5-60 |
| <b>BSM OFF</b>  | BSM OFF Indicator Light  | 5-61 |
|  | Lights-On Indicator Light  | 5-61 |
|  | Power Steering Malfunction Indicator Light                             | 5-61 |
|  | Turn Signal/Hazard Warning Indicator Lights                            | 5-62 |

### ▼ Brake System Warning Light



This warning has the following functions:

#### **Parking brake warning**

The light illuminates when the parking brake is applied with the ignition switched to START or ON. It turns off when the parking brake is fully released.

#### **Low brake fluid level warning**

If the light stays on after the parking brake is fully released, you may have a brake problem.

Drive to the side of the road and park off the right-of-way.

You may notice that the pedal is harder to depress or that it may go closer to the floor. In either case, it will take longer to stop the vehicle.

1. With the engine stopped, open the hood and check the brake fluid level immediately, and then add fluid if required (page 8-27).
2. After adding fluid, check the light again.

If the warning light remains on, or if the brakes do not operate properly, do not drive the vehicle. Have it towed to an Authorized Mazda Dealer.

Even if the light turns off, have your brake system inspected as soon as possible by an Authorized Mazda Dealer.

#### ***NOTE***

*Having to add brake fluid is sometimes an indicator of leakage. Consult an Authorized Mazda Dealer as soon as possible even if the brake light is no longer illuminated.*

Driving Your Mazda

## Warning/Indicator Lights and Beep Sounds

### **WARNING**

**Do not drive with the brake system warning light illuminated. Contact an Authorized Mazda Dealer to have the brakes inspected as soon as possible:**

*Driving with the brake system warning light illuminated is dangerous. It indicates that your brakes may not work at all or that they could completely fail at any time. If this light remains illuminated, after checking that the parking brake is fully released, have the brakes inspected immediately.*

#### ▼ Malfunction Warning Light



When the ignition is switched ON, the malfunction warning light illuminates and then turns off after a few seconds.

The light illuminates continuously if any one of the following occurs. Consult an Authorized Mazda Dealer:

- The brake switch has a malfunction.
- **(SKYACTIV-G 2.0)**

There is a problem with the battery system.

### **WARNING**

**Do not drive the vehicle with the malfunction warning light illuminated.**

*Driving the vehicle with the light illuminated is dangerous as it could result in the loss of brake power and cause an accident. In addition, loss of brake power could occur when stopping the vehicle. Have your vehicle inspected by an Authorized Mazda Dealer.*

#### ▼ ABS Warning Light



The warning light stays on for a few seconds when the ignition is switched ON.

If the ABS warning light stays on while you're driving, the ABS control unit has detected a system malfunction. If this occurs, your brakes will function normally as if the vehicle had no ABS.

Should this happen, consult an Authorized Mazda Dealer as soon as possible.

#### **NOTE**

- *When the engine is jump-started to charge the battery, uneven rpm occurs and the ABS warning light may illuminate. If this occurs, it is the result of the weak battery and does not indicate an ABS malfunction. Recharge the battery.*
- **(With DSC vehicles)**  
*The brake assist system does not operate while the ABS warning light is illuminated.*



## Warning/Indicator Lights and Beep Sounds

### ▼ Electronic Brake Force Distribution System Warning

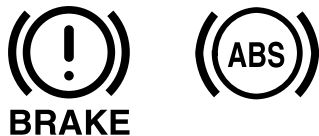

If the electronic brake force distribution control unit determines that some components are operating incorrectly, the control unit may illuminate the brake system warning light and the ABS warning light on simultaneously. The problem is likely to be the electronic brake force distribution system.

#### **⚠ WARNING**

***Do not drive with both the ABS warning light and brake warning light illuminated. Have the vehicle towed to an Authorized Mazda Dealer to have the brakes inspected as soon as possible:***

*Driving when the brake system warning light and ABS warning light are illuminated simultaneously is dangerous.*

*When both lights are illuminated, the rear wheels could lock more quickly in an emergency stop than under normal circumstances.*

### ▼ Charging System Warning Light



This warning light illuminates when the ignition is switched ON and turns off when the engine is started.

If the warning light illuminates while driving, it indicates a malfunction of the alternator or of the charging system. Drive to the side of the road and park off the right-of-way. Consult an Authorized Mazda Dealer.

#### **⚠ CAUTION**

***Do not continue driving when the charging system warning light is illuminated because the engine could stop unexpectedly.***

### ▼ Engine Oil Pressure Warning Light



This warning light illuminates when the ignition is switched ON and turns off when the engine is started.

This warning light indicates low engine oil pressure.

Driving Your Mazda

## Warning/Indicator Lights and Beep Sounds

If the light illuminates while driving:

1. Drive to the side of the road and park off the right-of-way on level ground.
2. Turn off the engine and wait 5 minutes for the oil to drain back into the oil pan.
3. Inspect the engine oil level (page 8-23). If it's low, add the appropriate amount of engine oil while being careful not to overfill.
4. Start the engine and check the warning light.

If the light remains illuminated even after you add oil, stop the engine immediately and have your vehicle towed to an Authorized Mazda Dealer.

### CAUTION

*Do not run the engine if the oil pressure is low. It could result in extensive engine damage.*

### ▼ Check Engine Light



This indicator light illuminates when the ignition is switched ON and turns off when the engine is started.

If this light illuminates while driving, the vehicle may have a problem. It is important to note the driving conditions when the light illuminated and consult an Authorized Mazda Dealer.

The check engine light may illuminate in the following cases:

- The fuel tank level being very low or approaching empty.
- The engine's electrical system has a problem.
- The emission control system has a problem.
- The fuel-filler cap is missing or not tightened securely.

If the check engine light remains on or flashes continuously, do not drive at high speeds and consult an Authorized Mazda Dealer as soon as possible.

### ▼ High Engine Coolant Temperature Warning Light (Red)



When the ignition is switched ON, the light illuminates momentarily and then turns off.

The light flashes when the engine coolant temperature is extremely high, and illuminates when the engine coolant temperature increases further.

### Handling Procedure

#### **Flashing light**

Drive slowly to reduce engine load.

#### **Illuminated light**

This indicates the possibility of overheating. Park the vehicle in a safe place immediately and stop the engine. Refer to Overheating (page 7-16).

## Warning/Indicator Lights and Beep Sounds

### **CAUTION**

*Do not drive the vehicle with the high engine coolant temperature warning light illuminated. Otherwise, it could result in damage to the engine.*

### ▼ Air Bag/Front Seat Belt Pretensioner System Warning Light



If the air bag/front seat belt pretensioner system is working properly, the warning light illuminates when the ignition is switched ON or after the engine is cranked. The warning light turns off after a specified period of time.

A system malfunction is indicated if the warning light constantly flashes, constantly illuminates or does not illuminate at all when the ignition is switched ON. If any of these occur, consult an Authorized Mazda Dealer as soon as possible. The system may not operate in an accident.

### **WARNING**

***Never tamper with the air bag/pretensioner systems and always have an Authorized Mazda Dealer perform all servicing and repairs:***

*Self-servicing or tampering with the systems is dangerous. An air bag/pretensioner could accidentally activate or become disabled causing serious injury or death.*

### ▼ Low Fuel Warning Light



This warning light signals that the fuel tank will soon be empty. Refuel as soon as possible.

### ▼ Check Fuel Cap Warning Light



This warning light illuminates for a few seconds when the ignition is switched ON.

If the check fuel cap warning light illuminates while driving, the fuel-filler cap may not be installed properly. Stop the engine and reinstall the fuel-filler cap. Refer to Fuel-Filler Cap on page 3-49.

Driving Your Mazda

## Warning/Indicator Lights and Beep Sounds

### ▼ Seat Belt Warning Light



#### With warning light for front passenger's seat

The seat belt warning light illuminates if the driver or front passenger's seat belt is not fastened (only when the front passenger seat is occupied) seat belt is not fastened when the ignition switched ON.

#### Without warning light for front passenger's seat

The seat belt warning light illuminates if the driver's seat belt is not fastened when the ignition switched ON.

### ▼ Door-Ajar Warning Light



This warning light illuminates when any door, trunk, or liftgate is not securely closed.

Close the door, trunk, or liftgate securely before driving the vehicle.

### ▼ Low Washer Fluid Level Warning Light\*



This warning light indicates that little washer fluid remains. Add fluid (page 8-30).

### ▼ Automatic Transaxle Warning Light (Automatic Transaxle)

**AT**

This warning light stays on for a few seconds when the ignition is switched ON.

The light illuminates when the transaxle has a problem.

#### **CAUTION**

*If the automatic transaxle warning light illuminates, the transaxle has an electrical problem. Continuing to drive your Mazda in this condition could cause damage to your transaxle. Consult an Authorized Mazda Dealer as soon as possible.*

## Warning/Indicator Lights and Beep Sounds

### ▼ Tire Pressure Monitoring System (TPMS) Warning Light\*



This warning light illuminates for a few seconds when the ignition is switched ON.

Thereafter, the warning light illuminates and a beep is heard when tire pressure is too low in one or more tires, and flashes when there is a system malfunction.

### **! WARNING**

*If the tire pressure monitoring system warning light illuminates or flashes, or the tire pressure warning beep sound is heard, decrease vehicle speed immediately and avoid sudden maneuvering and braking:*

*If the tire pressure monitoring system warning light illuminates or flashes, or the tire pressure warning beep sound is heard, it is dangerous to drive the vehicle at high speeds, or perform sudden maneuvering or braking. Vehicle drivability could worsen and result in an accident. To determine if you have a slow leak or a flat, pull over to a safe position where you can check the visual condition of the tire and determine if you have enough air to proceed to a place where air may be added and the system monitored again by an Authorized Mazda Dealer or a tire repair station.*

**Do not ignore the TPMS Warning Light:** Ignoring the TPMS warning light is dangerous, even if you know why it is illuminated. Have the problem taken care of as soon as possible before it develops into a more serious situation that could lead to tire failure and a dangerous accident.

### **Warning light illuminates/Warning beep sounds**

When the warning light illuminates, and the warning beep sound is heard (about 3 seconds), tire pressure is too low in one or more tires.

\*Some models. **5-55**

Driving Your Mazda

## Warning/Indicator Lights and Beep Sounds

Adjust the tire pressure to the correct tire pressure. Refer to the specification charts (page 10-12).

### CAUTION

*When replacing/repairing the tires or wheels or both, have the work done by an Authorized Mazda Dealer, or the tire pressure sensors may be damaged.*

### NOTE

- *Perform tire pressure adjustment when the tires are cold. Tire pressure will vary according to the tire temperature, therefore let the vehicle stand for 1 hour or only drive it 1.6 km (1 mile) or less before adjusting the tire pressures. When pressure is adjusted on hot tires to the cold inflation pressure, the TPMS warning light/beep may turn on after the tires cool and pressure drops below specification. Also, an illuminated TPMS warning light, resulting from the tire air pressure dropping due to cold ambient temperature, may turn off if the ambient temperature rises. In this case, it will also be necessary to adjust the tire air pressures. If the TPMS warning light illuminates due to a drop in tire air pressure, make sure to check and adjust the tire air pressures.*
- *After adjusting the tire air pressures, it may require some time for the TPMS warning light to turn off. If the TPMS warning light remains illuminated, drive the vehicle at a speed of at least 25 km/h (16 mph) for 10 minutes, and then verify that it turns off.*
- *Tires lose air naturally over time and the TPMS cannot tell if the tires are getting too soft over time or you have a flat. However, when you find one low tire in a set of four—that is an indication of trouble; you should have someone drive the vehicle slowly forward so you can inspect any low tire for cuts and any metal objects sticking through tread or sidewall. Put a few drops of water in the valve stem to see if it bubbles indicating a bad valve. Leaks need to be addressed by more than simply refilling the trouble tire as leaks are dangerous - take it to an Authorized Mazda Dealer which has all the equipment to fix tires, TPMS systems and order the best replacement tire for your vehicle.*

## Warning/Indicator Lights and Beep Sounds

If the warning light illuminates again even after the tire pressures are adjusted, there may be a tire puncture. Replace the punctured tire with the temporary spare tire (page 7-9).

### **NOTE**

*A tire pressure sensor is not installed to the temporary spare tire. The warning light will flash continuously while the temporary spare tire is being used.*

### **Warning light flashes**

When the warning light flashes, there may be a system malfunction. Consult an Authorized Mazda Dealer.

### **▼KEY Warning Light (Red)/KEY Indicator Light (Green) (with Advanced Key)**



This indicator has two colors.

### **KEY Warning Light (Red)**

#### **When illuminated**

- When the push button start is pressed ON, it illuminates momentarily and then turns off.
- If any malfunction occurs in the advanced keyless system, it illuminates continuously.

### **⚠ WARNING**

***Do not drive the vehicle with the KEY warning light illuminated:***

*If the KEY warning light remains illuminated, do not continue to drive using the advanced key system. Park the vehicle in a safe place and use the auxiliary key to continue driving the vehicle. Have the vehicle inspected at an Authorized Mazda Dealer as soon as possible.*

#### **When flashing**

- Under the following conditions, the KEY warning light (red) flashes to inform the driver that the push button start will not switch to ACC even if it is pressed from off.
  - The advanced key battery is dead.
  - The advanced key is not within operational range.
  - The advanced key is placed in areas where it is difficult for the system to detect the signal (page 3-7).
  - A key from another manufacturer similar to the advanced key is in the operational range.

Driving Your Mazda

## Warning/Indicator Lights and Beep Sounds

- Under the following conditions, the KEY warning light (red) will flash continuously when the push button start has not been pressed off to notify the driver that the advanced key has been removed. The KEY warning light (red) will stop flashing when the advanced key is back inside the vehicle:
  - The push button start has not been pressed off, the driver's door is open, and the advanced key is removed from the vehicle.
  - The push button start has not been pressed off and all the doors are closed after removing the advanced key from the vehicle.

### **NOTE**

*Because the advanced key utilizes low-intensity radio waves, the Advanced Key Removed From Vehicle Warning may activate if the advanced key is carried together with a metal object or it is placed in a poor signal reception area.*

### **KEY Indicator Light (Green)**

#### **When illuminated**

When the brake pedal is depressed with an automatic transaxle or the clutch pedal is depressed with a manual transaxle, the system confirms that the correct advanced key is inside the vehicle, the KEY indicator light (green) illuminates, and the push button start can be pressed to ACC (page 3-12).

#### **When flashing**

When the push button start is pressed off from ON, the KEY indicator light (green) flashes for approximately 30 seconds indicating that the remaining battery power is low. Replace with a new battery before the advanced key becomes unusable.

**5-58**

Refer to Service on page 3-7.

### **NOTE**

*The advanced key can be set so that the KEY indicator light (green) does not flash even if the battery power is low.  
Refer to Personalization Features on page 10-13.*

### **▼ Security Indicator Light**



This indicator light starts flashing every 2 seconds when the ignition is switched from ON to ACC and the immobilizer system is armed.

The light stops flashing when the ignition is switched ON with the correct ignition key.

At this time, the immobilizer system is disarmed and the light illuminates for about 3 seconds and then turns off.

If the engine does not start with the correct ignition key, and the security indicator light keeps illuminating or flashing, the system may have a malfunction. Consult an Authorized Mazda Dealer.



## Warning/Indicator Lights and Beep Sounds

### ▼ Headlight High-Beam Indicator Light



This light indicates one of two things:

- The high-beam headlights are on.
- The turn signal lever is in the flash-to-pass position.

### ▼ Shift Position Indicator Light (Automatic Transaxle)

This indicates the selected shift position.



Gear position indicator

In manual mode, the “M” of the shift position indicator illuminates and the numeral for the selected gear displays in the gear position indicator.

### ▼ Low Engine Coolant Temperature Indicator Light (Blue)



When the ignition is switched ON, the light illuminates momentarily and then turns off.

The light illuminates continuously when the engine coolant temperature is low and turns off after the engine is warm.

#### **NOTE**

*If the low engine coolant temperature indicator light remains illuminated after the engine has been sufficiently warmed up, the temperature sensor could have a malfunction. Consult an Authorized Mazda Dealer.*

### ▼ TCS/DSC Indicator Light \*



This indicator light stays on for a few seconds when the ignition is switched ON. If the TCS or DSC is operating, the indicator light flashes.

If the light stays on, the TCS or DSC may have a malfunction and they may not operate correctly. Take your vehicle to an Authorized Mazda Dealer.

Driving Your Mazda

## Warning/Indicator Lights and Beep Sounds

### NOTE

- In addition to the indicator light flashing, a slight lugging sound will come from the engine. This indicates that the TCS is operating properly.
- On slippery surfaces, such as fresh snow, it will be impossible to achieve high rpm when the TCS is on.

### ▼ DSC OFF Indicator Light \*



This indicator light stays on for a few seconds when the ignition is switched ON. It also illuminates when the DSC OFF switch is pressed and TCS/DSC is switched off (page 5-29).

If the light stays on when the TCS/DSC is not switched off, take your vehicle to an Authorized Mazda Dealer. The dynamic stability control may have a malfunction.

### ▼ AFS OFF Indicator Light \*

The AFS OFF indicator light illuminates briefly when the ignition is switched ON, and then turns off. Pressing the AFS OFF switch cancels the AFS function and illuminates the indicator light.

**AFS  
OFF**

The following conditions could indicate that the system is malfunctioning. If one of the following conditions occurs, consult an Authorized Mazda Dealer.

- The AFS OFF indicator light does not illuminate even though the ignition is switched ON.
- The AFS OFF indicator light flashes continuously.

### NOTE

Even if the AFS is not operating due to some malfunction, the normal headlight function is still operable.

### ▼ Cruise Main Indicator Light (Amber)/Cruise Set Indicator Light (Green) \*

**CRUISE**

The indicator light has two colors.

#### **Cruise Main Indicator Light (Amber)**

The indicator light illuminates amber when the ON switch is pressed and the cruise control system is activated.

#### **Cruise Set Indicator Light (Green)**

The indicator light illuminates green when a cruising speed has been set.

## Warning/Indicator Lights and Beep Sounds

### ▼ BSM OFF Indicator Light \*

# BSM OFF

This indicator light illuminates for a few seconds when the ignition is switched ON.

The BSM OFF indicator light illuminates when the BSM system is turned off by pressing the BSM OFF switch. The indicator light flashes if the BSM system has a malfunction. Consult an Authorized Mazda Dealer.

#### **NOTE**

*If the vehicle is driven on a road with less traffic and few vehicles that the radar sensors can detect, the system may pause (The BSM OFF indicator light in the instrument panel flashes). However, it does not indicate a malfunction.*

### ▼ Lights-On Indicator Light



This indicator light illuminates when the exterior lights and dashboard illumination are on.

### ▼ Power Steering Malfunction Indicator Light



This indicator light illuminates when the ignition is switched ON, and turns off when the engine is started.

If the light remains illuminated after the engine is started, or illuminates while driving, turn off the engine after parking in a safe place, and then start the engine again.

If the light does not illuminate after restarting the engine, this indicates that the power steering is restored and normal steering is possible.

If the light remains illuminated, the power steering is still inoperable. Consult an Authorized Mazda Dealer.

#### **NOTE**

- *The power steering system is inoperable when the power steering malfunction indicator light illuminates. Steering is possible, but requires more physical effort.*
- *Repeatedly jerking the steering wheel left and right while the vehicle is stopped or moving at slow speeds will cause the power steering system to go into protective mode which will make the steering feel heavy, but this does not indicate a malfunction. If this occurs, park the vehicle safely and wait a few minutes for the system to return to normal.*

Driving Your Mazda

## Warning/Indicator Lights and Beep Sounds

### ▼ Turn Signal/Hazard Warning Indicator Lights



When operating the turn signal lights, the left or right turn signal indicator light flashes to indicate which turn signal light is operating (page 5-69).

When operating the hazard warning lights, both turn signal indicator lights flash (page 5-77).

#### **NOTE**

*If an indicator light remains illuminated (does not flash) or if it flashes abnormally, one of the turn signal bulbs may be burned out.*

### Beep Sounds

#### ▼ Air Bag/Front Seat Belt Pretensioner System Warning Beep

If a malfunction is detected in the air bag/front seat belt pretensioner systems and the warning light, a warning beep sound will be heard for about 5 seconds every minute.

The air bag and seat belt pretensioner system warning beep sound will continue to be heard for approximately 35 minutes. Have your vehicle inspected at an Authorized Mazda Dealer as soon as possible.

#### **⚠ WARNING**

**Do not drive the vehicle with the air bag/front seat belt pretensioner system warning beep sounding:**

*Driving the vehicle with the air bag/front seat belt pretensioner system warning beep sounding is dangerous. In a collision, the air bags and the front seat belt pretensioner system will not deploy and this could result in death or serious injury. Contact an Authorized Mazda Dealer to have the vehicle inspected as soon as possible.*

## Warning/Indicator Lights and Beep Sounds

### ▼ Seat Belt Warning Beep

If the driver's seat belt is not fastened when the ignition is switched ON, a beep sound will be heard for about 6 seconds. If the driver or the front passenger's seat belt is not fastened and the vehicle is driven at a speed faster than about 20 km/h (12 mph), a beep sound will be heard again for a specified period of time. Refer to Seat Belt Reminder on page 2-25.

### ▼ Ignition Key Reminder

If the ignition is switched off or the ignition is switched to ACC with the key inserted, a continuous beep sound will be heard when the driver's door is opened.

#### **NOTE**

*A personalized function is available to change the sound volume for the ignition key reminder. Refer to Settings on page 6-186.*

### ▼ Lights-On Reminder

If lights are on and the key is removed from the ignition switch, a continuous beep sound will be heard when the driver's door is opened.

#### **NOTE**

- *When the advanced keyless function is used and the push button start is pressed to ACC, the "Push Button Start Not in OFF Warning Beep" (page 3-21) overrides the lights-on reminder.*
- **(Without auto-light control function)**  
*A personalized function is available to change the sound volume for the lights-on reminder. Refer to Settings on page 6-186.*

### ▼ Tire Inflation Pressure Warning Beep\*

The warning beep sound will be heard for about 3 seconds when there is any abnormality in tire inflation pressures (page 5-31).

### ▼ Advanced Keyless Warning\*

Warning indicators for the advanced key, such as "the advanced key removed from vehicle warning", use a beep sound and warning/indicator lights in the instrument cluster.

Refer to Warning Lights and Beep Sounds on page 3-21.

### ▼ Blind Spot Monitoring System Warning Beep\*

The warning beep operates when the turn signal lever is operated to the side where the BSM warning light is illuminated.

#### **NOTE**

*A personalized function is available to change the BSM warning beep sound volume. Refer to Settings on page 6-186.*

Driving Your Mazda

## Switches and Controls

### Lighting Control

#### ▼ Headlights



Turn the headlight switch to turn the headlights, other exterior lights and dashboard illumination on or off.

**NOTE**

To prevent discharging the battery, do not leave the lights on while the engine is off unless safety requires them.

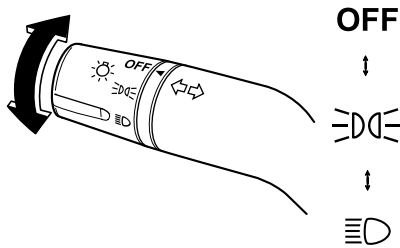
#### Without AUTO position



| Switch Position        | OFF |  |  |
|------------------------|-----|---|---|
| Headlights             | Off | Off   | On  |
| Taillights             |     |   |   |
| Parking lights         |     |   |   |
| License lights         | Off | On  | On  |
| Side-marker lights     |     |   |   |
| Dashboard illumination |     |   |   |

#### With AUTO position

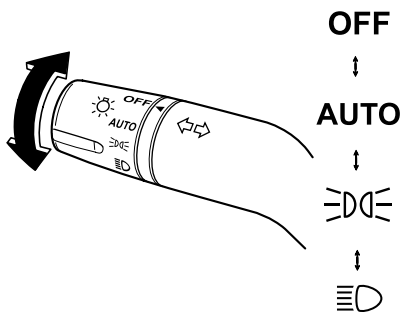

Driving Your Mazda  
**Switches and Controls**

| Switch Position  | OFF | AUTO | ☰☱☲ | ☰☱☲☳ |
|--|-----|------|-----|------|
| Headlights   | Off | Auto | Off | On   |
| Taillights<br>Parking lights<br>License lights<br>Side-marker lights<br>Dashboard illumination | Off |      | On  | On   |

**AUTO (Auto-light control)**

When the headlight switch is in the AUTO position and the ignition is switched ON, the light sensor senses the surrounding lightness or darkness and automatically turns the headlights, other exterior lights and dashboard illumination on or off (see chart above).

**⚠ CAUTION**

- Do not shade the light sensor by adhering a sticker or a label on the windshield. Otherwise the light sensor will not operate correctly.

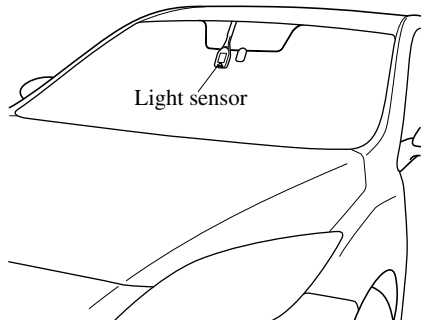

- The light sensor also works as a rain sensor for the auto-wiper control. Keep hands and scrapers clear of the windshield when the wiper lever is in the AUTO position and the ignition is switched ON as fingers could be pinched or the wipers and wiper blades damaged when the wipers activate automatically. If you are going to clean the windshield, be sure the wipers are turned off completely — this is particularly important when clearing ice and snow — when it is particularly tempting to leave the engine running.

Driving Your Mazda

## Switches and Controls

---

### **NOTE**

- *The headlights, other exterior lights and dashboard illumination may not turn off immediately even if the surrounding area becomes well-lit because the light sensor determines that it is nighttime if the surrounding area is continuously dark for several minutes such as inside long tunnels, traffic jams inside tunnels, or in indoor parking lots.  
In this case, the light turns off if the light switch is turned to the OFF position.*
- *The dashboard illumination can be adjusted by rotating the knob in the instrument cluster. Also, the day/night mode can be changed by pressing the knob. To adjust the brightness of the dashboard illumination: Refer to Dashboard Illumination on page 5-45.*
- *When the headlight switch is in the AUTO position and the ignition is switched to ACC or the ignition is switched off, the headlights, other exterior lights and dashboard illumination will turn off.*
- *The sensitivity of the AUTO lights may be changed by an Authorized Mazda Dealer. Refer to Personalization Features on page 10-13.*

### **Xenon fusion headlight bulbs\***

The low-beam bulbs of the headlights have xenon fusion bulbs that produce a bright white beam over a wide area.

### **⚠ WARNING**

#### ***Do not replace the xenon fusion bulbs yourself***

*Replacing the xenon fusion bulbs yourself is dangerous. Because the xenon fusion bulbs require high voltage, you could receive an electric shock if the bulbs are handled incorrectly. Consult an Authorized Mazda Dealer when the replacement is necessary.*

### **NOTE**

*If the headlights flicker, or the brightness weakens, the bulb-life may be depleted and a replacement is necessary. Consult an Authorized Mazda Dealer.*



## Driving Your Mazda Switches and Controls

### ▼ Lights-On Reminder

If lights are on and the key is removed from the ignition switch, a continuous beep sound will be heard when the driver's door is opened.

#### NOTE

- *When the advanced keyless function is used and the push button start is pressed to ACC, the "Push Button Start Not in OFF Warning Beep" (page 3-21) overrides the lights-on reminder.*
- **(Without auto-light control function)**  
*A personalized function is available to change the sound volume for the lights-on reminder. Refer to Settings on page 6-186.*

### ▼ Headlight High-Low Beam

Press the lever forward to turn on the high beams.  
Pull the lever back to its original position for the low beams.

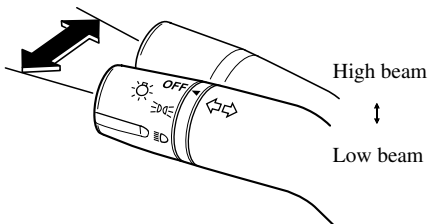

### ▼ Flashing the Headlights

To flash the headlights, pull the lever fully towards you (the headlight switch does not need to be on). The lever will return to the normal position when released.

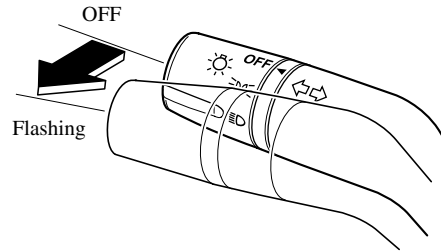

### ▼ Headlight Leveling\*

The number of passengers and weight of cargo in the luggage compartment change the angle of the headlights.

#### Auto type

The angle of the headlights will be automatically adjusted when turning on the headlights.

#### NOTE

*If there is a malfunction with the headlight auto-leveling function, the AFS OFF indicator light flashes.*

Driving Your Mazda

## Switches and Controls

### Manual type

The headlight leveling switch is used to adjust the angle of the headlights manually.

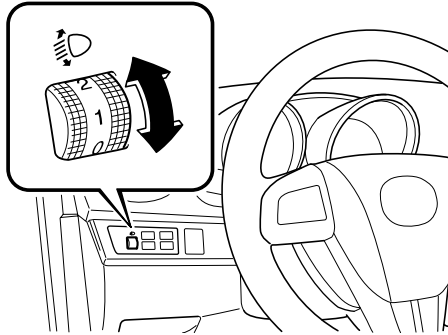

Select the proper headlight angle from the following chart.

(SKYACTIV-G 2.0, MZR 2.0, MZR 2.5)

| Front seat |           | Rear seat | Load | Switch Position |
|------------|-----------|-----------|------|-----------------|
| Driver     | Passenger |           |      |                 |
| ×          | —         | —         | —    | 0               |
| ×          | ×         | —         | —    | 0               |
| ×          | ×         | ×         | —    | 1               |
| ×          | ×         | ×         | ×    | 2               |
| ×          | —         | —         | ×    | 3               |

×: Yes  
 —: No

(MZR 2.3 DISI Turbo)

| Front seat |           | Rear seat | Load | Switch Position |
|------------|-----------|-----------|------|-----------------|
| Driver     | Passenger |           |      |                 |
| ×          | —         | —         | —    | 0               |
| ×          | ×         | —         | —    | 0               |
| ×          | ×         | ×         | —    | 1               |
| ×          | ×         | ×         | ×    | 1               |
| ×          | —         | —         | ×    | 2               |

×: Yes  
 —: No

### ▼ **Adaptive Front Lighting System (AFS)\***

The adaptive front lighting system (AFS) automatically adjusts the headlight beams to the left or right in conjunction with the operation of the steering wheel after the headlights have been turned on and the vehicle speed is about 2 km/h (2 mph) or higher.

#### AFS OFF indicator light

The AFS OFF indicator light illuminates briefly when the ignition is switched ON, and then turns off. Pressing the AFS OFF switch cancels the AFS function and illuminates the indicator light.

# AFS OFF

The following conditions could indicate that the system is malfunctioning. If one of the following conditions occurs, consult an Authorized Mazda Dealer.

- The AFS OFF indicator light does not illuminate even though the ignition is switched ON.
- The AFS OFF indicator light flashes continuously.

#### **NOTE**

*Even if the AFS is not operating due to some malfunction, the normal headlight function is still operable.*

#### AFS OFF switch

Pressing the AFS OFF switch turns off the AFS.

## Switches and Controls

Pressing the AFS OFF switch again turns off the AFS OFF indicator light and turns on the AFS.



### ▼ Daytime Running Lights (Canada)

In Canada, vehicles must be driven with the headlights on during daytime operation.

For that reason, the daytime running lights automatically turn on when the ignition is switched ON.

#### **NOTE**

*The Daytime Running Lights turn off when the parking brake is applied.*

## Turn and Lane-Change Signals

### Turn Signals

Move the signal lever down (for a left turn) or up (for a right turn) to the stop position. The signal will self-cancel after the turn is completed.

If the indicator light continues to flash after a turn, manually return the lever to its original position.

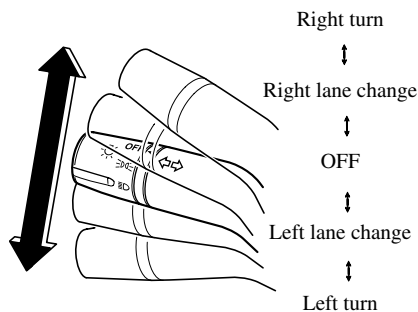

Green indicators on the dashboard show which signal is working.

### Lane-change signals

#### **(Without Smart Turn)**

Move the lever slightly toward the direction of the change —until the indicator flashes— and hold it there. It will return to the off position when released.

#### **(With Smart Turn)**

To signal a lane change, press the turn signal lever up or down halfway and release. After releasing the lever, the turn signal indicator flashes three times.

Driving Your Mazda



## Switches and Controls

### NOTE

- *If an indicator light stays on without flashing or if it flashes abnormally, one of the turn signal bulbs may be burned out.*
- *A personalized function is available to change the number of flashes.*  
*Refer to Personalization Features on page 10-13.*
- *A personalized function is available to change the turn indicator sound volume.*  
*Refer to Settings on page 6-186.*

### Fog Lights\*

Use this switch to turn on the fog lights. The fog lights will improve visibility at night and during foggy conditions.

To turn the fog lights on, rotate the fog light switch to the  position. The headlight switch must be in the  position before turning on the fog lights.

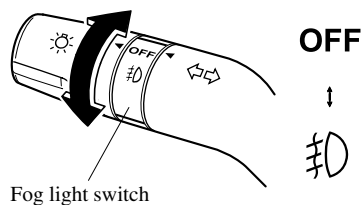

To turn them off, rotate the fog light switch to the OFF position or turn the headlight switch to the  or OFF position.

### NOTE

- *The fog lights will turn off when the headlights are set at high beam.*
- **(With auto-light control)**  
*If the fog light switch is in the ON position and the headlight switch is in the AUTO position, the fog lights will be turned on when the headlights, the exterior lights and dashboard illumination are automatically turned on.*

## Switches and Controls

### Windshield Wipers and Washer

The ignition must be switched ON.

#### **! WARNING**

**Use only windshield washer fluid or plain water in the reservoir:**

Using radiator antifreeze as washer fluid is dangerous. If sprayed on the windshield, it will dirty the windshield, affect your visibility, and could result in an accident.

**Only use windshield washer fluid mixed with anti-freeze protection in freezing weather conditions:**

Using windshield washer fluid without anti-freeze protection in freezing weather conditions is dangerous as it could freeze on the windshield and block your vision which could cause an accident. In addition, make sure the windshield is sufficiently warmed using the defroster before spraying the washer fluid.

#### **NOTE**

Because heavy ice and snow can jam the wiper blades, the wiper motor is protected from motor breakdown, overheating and possible fire by a circuit breaker. This mechanism will automatically stop operation of the blades, but only for about 5 minutes.

If this happens, turn off the wiper switch and park off the right-of-way, and remove the snow and ice.

After 5 minutes, turn on the switch and the blades should operate normally. If they do not resume functioning, consult an Authorized Mazda Dealer as soon as possible. Drive to the side of the road and park off the right-of-way. Wait until the weather clears before trying to drive with the wipers inoperative.

#### **▼ Windshield Wipers**



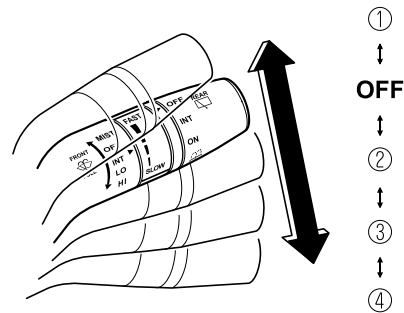

Turn the wipers on by pressing the lever up or down.

**With INT position**



Driving Your Mazda

## Switches and Controls

| Switch Position |   |             | Wiper operation          |
|-----------------|---|-------------|--------------------------|
| No.             | Type A  | Type B      |                          |
| ①               |  | <b>MIST</b> | Single wipe cycle (mist) |
| ②               |  | <b>INT</b>  | Intermittent             |
| ③               |  | <b>LO</b>   | Low speed                |
| ④               |  | <b>HI</b>   | High speed               |

With AUTO position

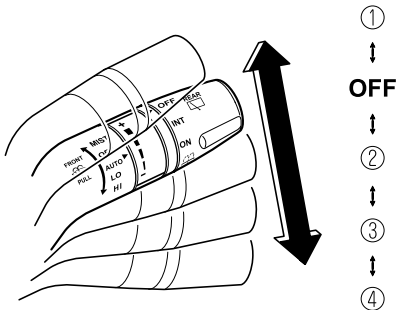

| Switch Position | Wiper operation |                          |
|-----------------|-----------------|--------------------------|
| ①               | <b>MIST</b>     | Single wipe cycle (mist) |
| ②               | <b>AUTO</b>     | Auto control             |
| ③               | <b>LO</b>       | Low speed                |
| ④               | <b>HI</b>       | High speed               |

### Variable-speed intermittent wipers

Set the lever to the intermittent position and choose the interval timing by rotating the ring.

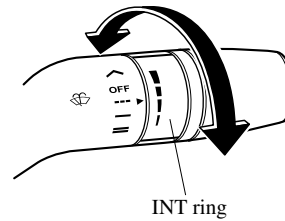

### AUTO (Auto-wiper control)

When the wiper lever is in the AUTO position, the rain sensor senses the amount of rainfall on the windshield and turns the wipers on or off automatically (off—intermittent—low speed—high speed).

## Switches and Controls

The sensitivity of the rain sensor can be adjusted by turning the switch on the wiper lever.

From the center position (normal), rotate the switch downward for higher sensitivity (faster response) or rotate it upward for less sensitivity (slower response).

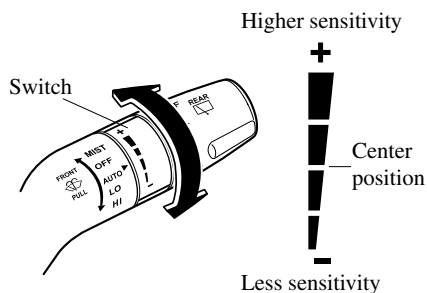

### **CAUTION**

- Do not shade the rain sensor by adhering a sticker or a label on the windshield. Otherwise the rain sensor will not operate correctly.

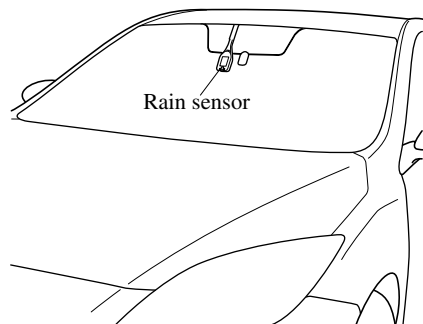

- When the wiper lever is in the AUTO position and the ignition is switched ON, the wipers may move automatically in the following cases:

- If the windshield above the rain sensor is touched or wiped with a cloth.
- If the windshield is struck with a hand or other object from either outside or inside the vehicle.

Keep hands and scrapers clear of the windshield when the wiper lever is in the AUTO position and the ignition is switched ON as fingers could be pinched or the wipers and wiper blades damaged when the wipers activate automatically.

If you are going to clean the windshield, be sure the wipers are turned off completely—this is particularly important when clearing ice and snow—when it is most likely that the engine is left running.

Driving Your Mazda

## Switches and Controls

### NOTE

- *Switching the auto-wiper lever from the OFF to the AUTO position while driving activates the windshield wipers once, after which they operate according to the rainfall amount.*
- *The auto-wiper control may not operate when the rain sensor temperature is about  $-10^{\circ}\text{C}$  ( $14^{\circ}\text{F}$ ) or lower, or about  $85^{\circ}\text{C}$  ( $185^{\circ}\text{F}$ ) or higher.*
- *If the windshield is coated with water repellent, the rain sensor may not be able to sense the amount of rainfall correctly and auto-wiper control may not operate properly.*
- *If dirt or foreign matter (Such as ice or matter containing salt water) adheres to the windshield above the rain sensor or if the windshield is iced, it could cause the wipers to move automatically. However, if the wipers cannot remove this ice, dirt or foreign matter, the auto-wiper control will stop operation. In this case, set the wiper lever to the low speed position or high speed position for manual operation, or remove the ice, dirt or foreign matter by hand to restore the auto-wiper operation.*
- *If the auto-wiper lever is left in the AUTO position, the wipers could operate automatically from the effect of strong light sources, electromagnetic waves, or infrared light because the rain sensor uses an optical sensor. It is recommended that the auto-wiper lever be switched to the OFF position other than when driving the vehicle under rainy conditions.*

### ▼ Windshield Washer

Pull the lever toward you and hold it to spray washer fluid.

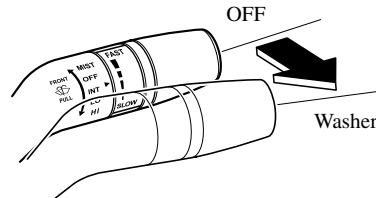

### NOTE

*With the wiper lever in the OFF or intermittent position/AUTO position, the wipers will operate continuously until the lever is released.*

If the washer does not work, inspect the fluid level (page 8-30). If it's normal, consult an Authorized Mazda Dealer.



## Switches and Controls

### Rear Window Wiper and Washer (5 Door)

The ignition must be switched ON.

#### ▼ Rear Window Wiper

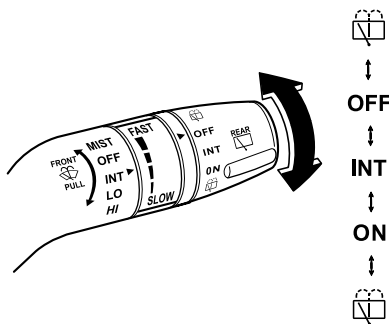

Turn the wiper on by turning the rear wiper/washer switch.

**ON** — Normal

**INT** — Intermittent

#### ▼ Rear Window Washer

To spray washer fluid, turn the rear wiper/washer switch to the  position. After the switch is released, the washer will stop.

If the washer does not work, inspect the fluid level (page 8-30). If it's normal and the washer still does not work, consult an Authorized Mazda Dealer.

### Rear Window Defroster

The rear window defroster clears frost, fog, and thin ice from the rear window.

The ignition must be switched ON.

Press the switch to turn on the rear window defroster. The rear window defroster operates for about 15 minutes and turns off automatically.

The indicator light illuminates during operation.

To turn off the rear window defroster before the 15 minutes has elapsed, press the switch again.

#### Fully Automatic Type Air-Conditioning

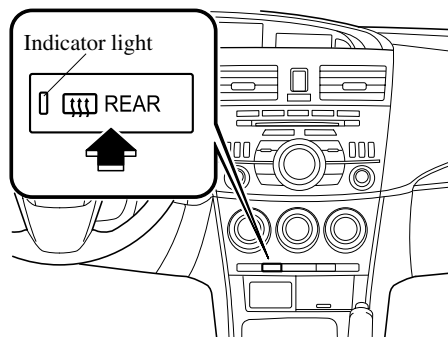

Driving Your Mazda

## Switches and Controls

### Manual Type Air-Conditioning

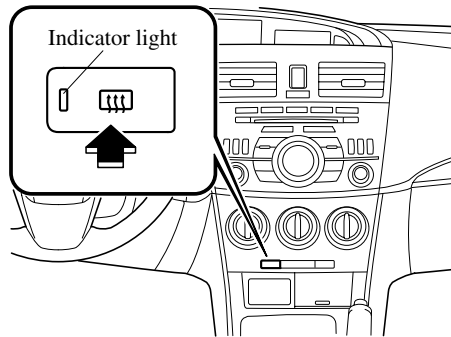

#### **CAUTION**

*Do not use sharp instruments or window cleaners with abrasives to clean the inside of the rear window surface. They may damage the defroster grid inside the window.*

#### **NOTE**

*This defroster is not designed for melting snow. If there is an accumulation of snow on the rear window, remove it before using the defroster.*

#### **▼ Mirror Defroster\***

To turn on the mirror defrosters, switch the ignition ON and press the rear window defroster switch (page 5-75).

### Horn

To sound the horn, press the  mark on the steering wheel.

Driving Your Mazda  
**Switches and Controls**

## Hazard Warning Flasher

The hazard warning lights should always be used when you stop on or near a roadway in an emergency.

The hazard warning lights warn other drivers that your vehicle is a traffic hazard and that they must take extreme caution when near it.

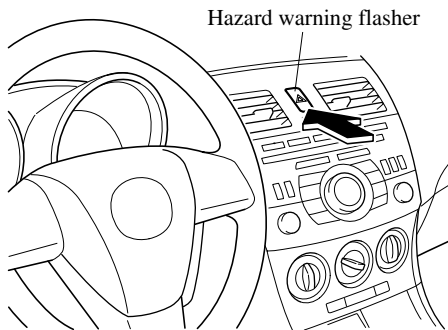

Depress the hazard warning flasher and all the turn signals will flash.

**NOTE**

- *The turn signals do not work when the hazard warning lights are on.*
- *Check local regulations about the use of hazard warning lights while the vehicle is being towed to verify that it is not in violation of the law.*

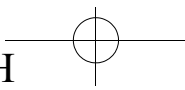
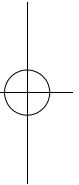
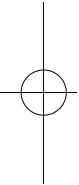
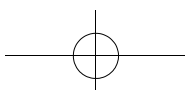

## 6 Interior Comfort

Use of various features for drive comfort, including air-conditioning and audio system.

|  |              |                                  |              |
|--|--------------|----------------------------------|--------------|
| <b>Climate Control System .....</b>                | <b>6-2</b>   | <b>Bluetooth® (Type B) .....</b> | <b>6-139</b> |
| Operating Tips .....                               | 6-2          | Bluetooth®* .....                | 6-139        |
| Vent Operation .....                               | 6-3          | Bluetooth® Hands-Free .....      | 6-145        |
| Types of the Climate Control System .....          | 6-5          | Bluetooth® Audio .....           | 6-164        |
| Manual Type* .....                                 | 6-6          | Troubleshooting .....            | 6-168        |
| Fully Automatic Type* .....                        | 6-10         | Safety Certification .....       | 6-172        |
| <br>   |              | <br>                             |              |
| <b>Audio System .....</b>                          | <b>6-16</b>  | <b>Interior Equipment .....</b>  | <b>6-174</b> |
| Antenna .....                                      | 6-16         | Sunvisors .....                  | 6-174        |
| Operating Tips for Audio System .....              | 6-17         | Interior Lights .....            | 6-174        |
| Types of the Audio Set/System .....                | 6-29         | Information Display .....        | 6-176        |
| Audio Set (Type A) .....                           | 6-31         | Multi Information Display* ..... | 6-178        |
| Audio Set (Type B) .....                           | 6-61         | Cup Holder .....                 | 6-187        |
| Audio Control Switch Operation* .....              | 6-82         | Bottle Holder .....              | 6-188        |
| AUX/USB/iPod Mode .....                            | 6-86         | Storage Compartments .....       | 6-189        |
| Safety Certification .....                         | 6-105        | Accessory Sockets .....          | 6-192        |
| <br>   |              |                                  |              |
| <b>Bluetooth® Audio (Type A) .....</b>             | <b>6-106</b> |                                  |              |
| Bluetooth® Audio* .....                            | 6-106        |                                  |              |
| <br>   |              |                                  |              |
| <b>Bluetooth® Hands-Free (Type A) .....</b>        | <b>6-116</b> |                                  |              |
| Bluetooth® Hands-Free* .....                       | 6-116        |                                  |              |
| Basic Bluetooth® Hands-Free Operation .....        | 6-120        |                                  |              |
| Convenient Use of the Hands-Free System .....      | 6-125        |                                  |              |
| Hands-Free Setting .....                           | 6-131        |                                  |              |
| When Bluetooth® Hands-Free Cannot be Used .....    | 6-137        |                                  |              |
| Safety Certification .....                         | 6-138        |                                  |              |
| Mazda Bluetooth® Hands-Free Customer Service ..... | 6-138        |                                  |              |

\*Some models.

**6-1**

Interior Comfort

## Climate Control System

### Operating Tips

#### ▼ Operating the Climate Control System

Operate the climate control system with the engine running.

##### **NOTE**

*To prevent the battery from being discharged, do not leave the fan control dial on for a long period of time with the ignition switched ON when the engine is not running.*

#### ▼ Clearing the Air Inlet

Clear all obstructions such as leaves, snow and ice from the hood and the air inlet in the cowl grille to improve the system efficiency.

#### ▼ Foggy Windows

The windows may fog up easily in humid weather. Use the climate control system to defog the windows.

To help defog the windows, operate the air conditioner to dehumidify the air.

##### **NOTE**

*The air conditioner may be used along with the heater to dehumidify the air.*

#### ▼ Parking in Direct Sunlight

If the vehicle has been parked in direct sunlight during hot weather, open the windows to let warm air escape, then run the climate control system.

#### ▼ Not Using for a Long Period

Run the air conditioner about 10 minutes at least once a month to keep internal parts lubricated.

#### ▼ Check the Refrigerant before the Weather Gets Hot

Have the air conditioner checked before the weather gets hot. Lack of refrigerant may make the air conditioner less efficient. Consult an Authorized Mazda Dealer for refrigerant inspection.

The air conditioner is filled with HFC134a (R134a), a refrigerant that will not damage the ozone layer. If the air conditioner is low on refrigerant or has a malfunction, consult an Authorized Mazda Dealer.

#### ▼ Replacement of the Cabin Air Filter\*

Your vehicle is equipped with an air filter for the air conditioner. It is necessary to change the filter periodically as indicated in scheduled maintenance (page 8-4). Consult an Authorized Mazda Dealer for replacement of the cabin air filter.

Interior Comfort  
**Climate Control System**

**Vent Operation**

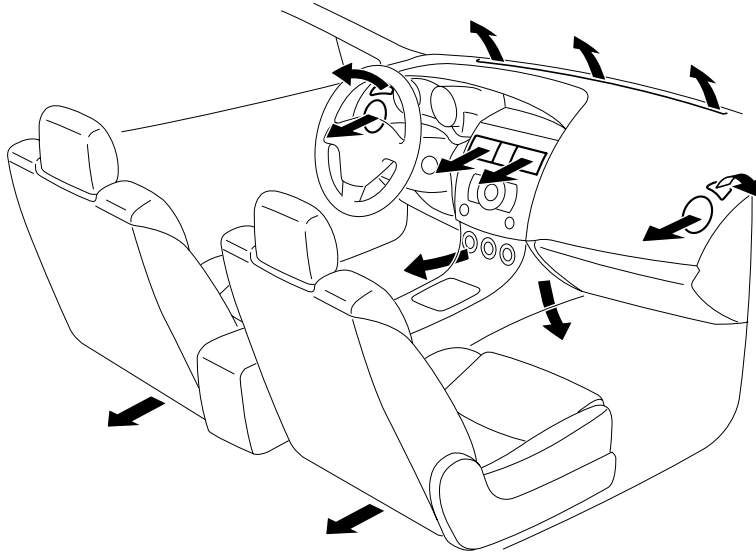

▼ **Adjusting the Vents**

**Directing airflow**

**Side Vents**

To adjust the direction of airflow, open the vents and rotate them left and right.

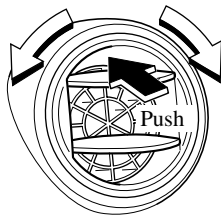

**Center Vents**

To adjust the direction of airflow, move the adjustment knob.

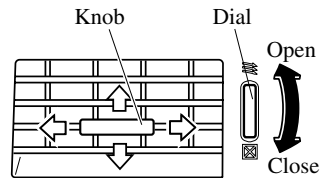

**NOTE**

*When using the air conditioner under humid ambient temperature conditions, the system may blow fog from the vents. This is not a sign of trouble but a result of humid air being suddenly cooled.*

Interior Comfort

# Climate Control System

## ▼ Selecting the Airflow Mode

### Dashboard Vents

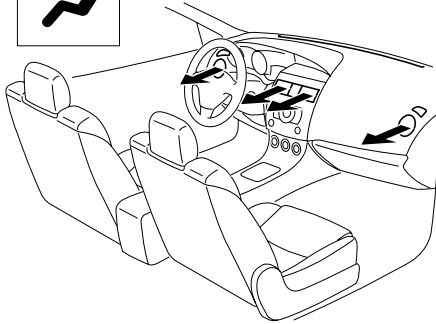

### Defroster and Floor Vents

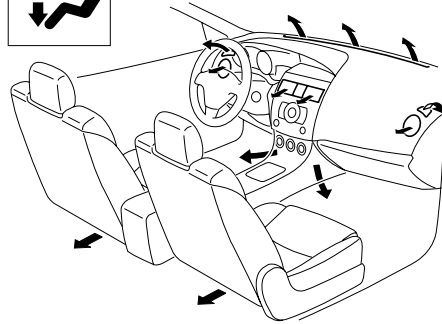

### Dashboard and Floor Vents

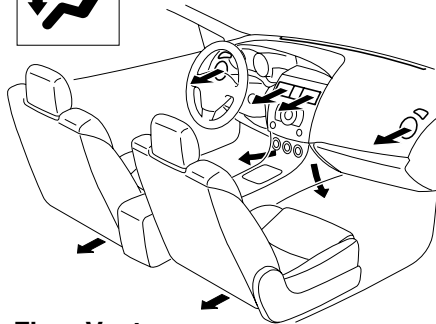

### Defroster Vents

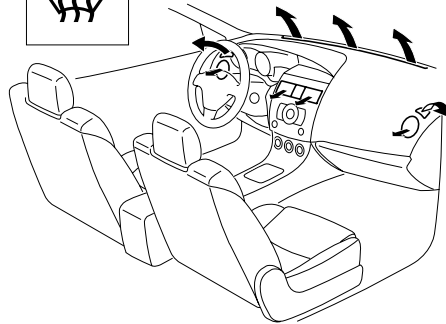

### Floor Vents

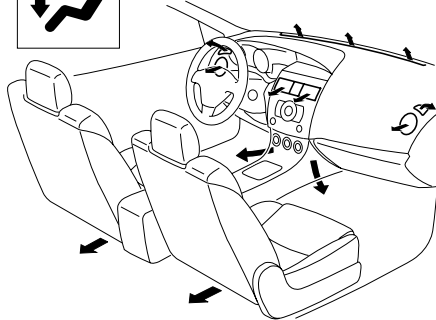



Interior Comfort  
**Climate Control System**

**Types of the Climate Control System**

Manual type and fully automatic type climate control systems are explained separately.  
Check your vehicle's climate control type and read the appropriate pages.

Manual Type ..... page 6-6

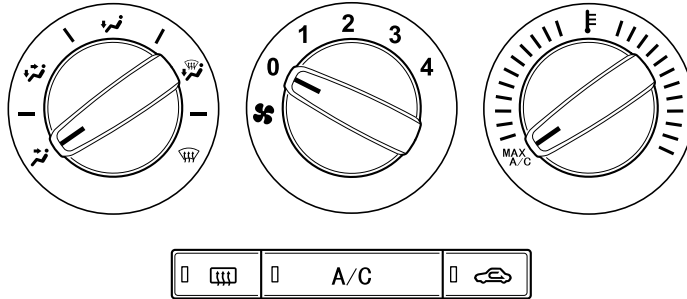

Fully Automatic Type ..... page 6-10

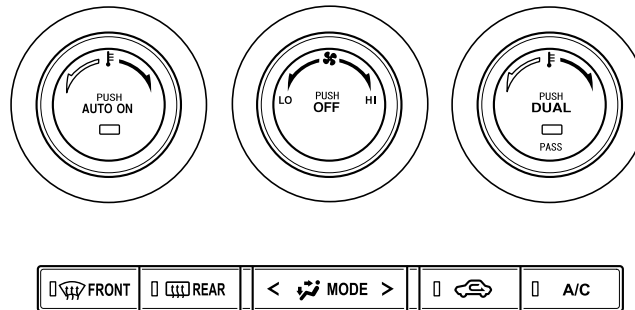

Interior Comfort

# Climate Control System

## Manual Type \*

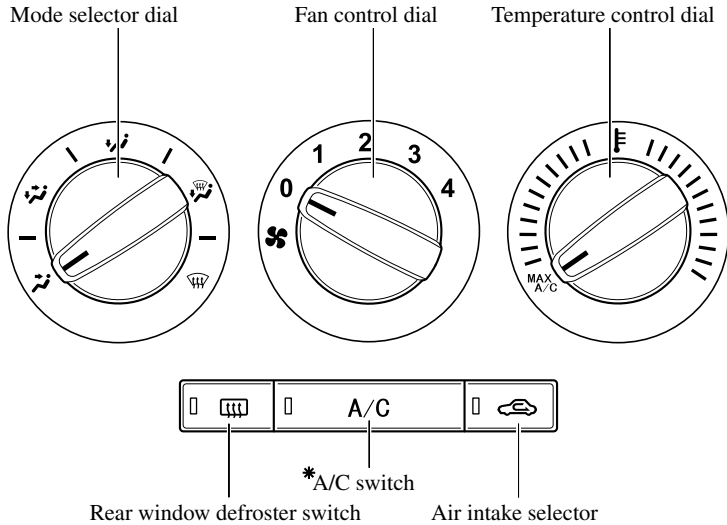

\*Some models.

### ▼ Control Switches

#### Temperature control dial

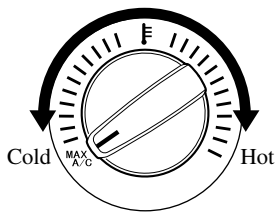

This dial controls temperature. Turn it clockwise for hot and counterclockwise for cold.

#### **NOTE**

**(U.S.A.)**

When the mode is set to or with the fan control dial in a position other than 0 and the temperature control dial in the maximum cold position, the air intake selector switches to the recirculated air mode and the A/C turns on automatically.

If A/C is not desired, press the A/C switch to turn it off.

#### Fan control dial

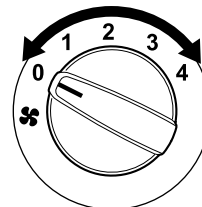

## Interior Comfort Climate Control System

This dial allows variable fan speeds.

- 0—Fan off
- 1—Low speed
- 2—Medium low speed
- 3—Medium high speed
- 4—High speed

### Mode selector dial

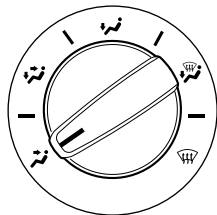

Turn the mode selector dial to select airflow mode (page 6-4).

### **NOTE**

- The mode selector dial can be set at the intermediate positions ( | ) between each mode. Set the dial to an intermediate position if you want to slightly adjust the airflow amount.
- For example, when the mode selector dial is at the | position between the front and rear positions, airflow from the floor vent is less than that of the front position.

### A/C switch\*

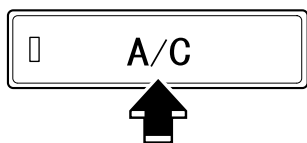

Press the A/C switch to turn the air conditioner on. The indicator light on the switch will illuminate when the fan control dial is set at position 1, 2, 3, or 4.

Press the switch once again to turn the air conditioner off.

### **NOTE**

The air conditioner may not function when the outside temperature approaches 0 °C (32 °F).

### Air intake selector

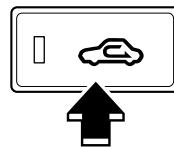

This switch controls the source of air entering the vehicle.

Press the  switch to alternate between the outside air and recirculated air modes.

It is recommended that under normal conditions the switch be kept in the outside air mode.

### **Outside air mode (indicator light turned off)**

Outside air is taken into the vehicle. Use this mode for normal ventilation and heating.

### **Recirculated air mode (indicator light illuminated)**

Outside air is shut off. Air within the vehicle is recirculated.

This mode can be used when driving on a dusty road or in similar conditions. It also helps to provide quicker cooling of the interior.

\*Some models.

Interior Comfort

## Climate Control System

### **WARNING**







**Do not use the recirculated air mode in cold or rainy weather:**

*Using the recirculated air mode in cold or rainy weather is dangerous as it will cause the windows to fog up. Your vision will be hampered, which could lead to a serious accident.*

### ▼ Heating

1. Set the mode selector dial to the  position.
2. Set the temperature control dial to the hot position.
3. Set the fan control dial to the desired speed.

### NOTE

- If the windshield fogs up easily, set the mode selector dial to the  position.
- If cooler air is desired at face level, set the mode selector dial to the  position and adjust the temperature control dial to maintain maximum comfort.
- The air to the floor is warmer than air to the face (except when the temperature control dial is set at the extreme hot or cold position).
- In the  or  position, the air conditioner is automatically turned on (however, the indicator light does not illuminate) and the outside air mode is automatically selected to defrost the windshield.  
In the  or  position, the outside air mode cannot be changed to the recirculated air mode.

### ▼ Cooling (With Air Conditioner)\*

1. Set the mode selector dial to the  position.
2. Set the temperature control dial to the cold position.
3. Set the fan control dial to the desired speed.
4. Turn on the air conditioner by pressing the A/C switch.
5. Adjust the fan control dial and temperature control dial to maintain maximum comfort.

### **CAUTION**

*If the air conditioner is used while driving up long hills or in heavy traffic, monitor the engine coolant temperature warning light to see if it is illuminated or flashing (page 5-52). The air conditioner may cause engine overheating. If the warning light is illuminated or flashing, turn the air conditioning off (page 7-16).*

### NOTE

- When maximum cooling is desired, set the temperature control dial to the extreme cold position and set the air intake selector to the recirculated air mode, then set the fan control dial to position 4.
- If warmer air is desired at floor level, set the mode selector dial to the  position and adjust the temperature control dial to maintain maximum comfort.
- The air to the floor is warmer than air to the face (except when the temperature control dial is set at the extreme hot or cold position).

## Climate Control System

### ▼ Ventilation



1. Set the mode selector dial to the  position.
2. Set the air intake selector to the outside air mode.
3. Set the temperature control dial to the desired position.
4. Set the fan control dial to the desired speed.

### ▼ Windshield Defrosting and Defogging





1. Set the mode selector dial to the  position.
2. Set the temperature control dial to the desired position.
3. Set the fan control dial to the desired speed.

### WARNING

**Do not defog the windshield using the  position with the temperature control set to the cold position:**

*Using the  position with the temperature control set to the cold position is dangerous as it will cause the outside of the windshield to fog up. Your vision will be hampered, which could lead to a serious accident. Set the temperature control to the hot or warm position when using the  position.*

### NOTE

- For maximum defrosting, set the temperature control dial to the extreme hot position and the fan control dial to position 4.
- If warm air is desired at the floor, set the mode selector dial to the  position.
- In the , or  position, the air conditioner is automatically turned on (however, the indicator light does not illuminate) and the outside air mode is automatically selected to defrost the windshield.  
In the  or  position, the outside air mode cannot be changed to the recirculated air mode.

### ▼ Dehumidifying (With Air Conditioner)\*

Operate the air conditioner in cool or cold weather to help defog the windshield and side windows.

1. Set the mode selector dial to the desired position.
2. Set the air intake selector to the outside air mode.
3. Set the temperature control dial to the desired position.
4. Set the fan control dial to the desired speed.
5. Turn on the air conditioner by pressing the A/C switch.

### NOTE

*One of the functions of the air conditioner is dehumidifying the air and, to use this function, the temperature does not have to be set to cold. Therefore, set the temperature control dial to the desired position (hot or cold) and turn on the air conditioner when you want to dehumidify the cabin air.*

\*Some models.

Interior Comfort

# Climate Control System

## Fully Automatic Type\*

Climate control information is displayed on the information display.

### Information display

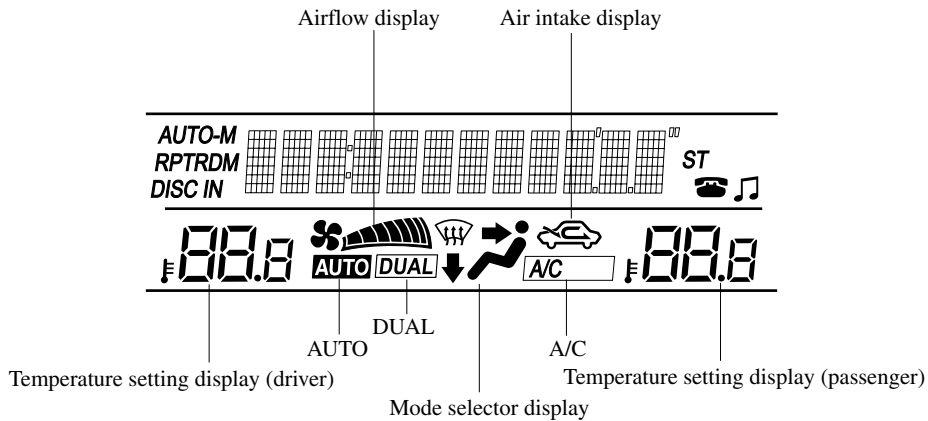

### Driver temperature control dial Fan control dial Passenger temperature control dial

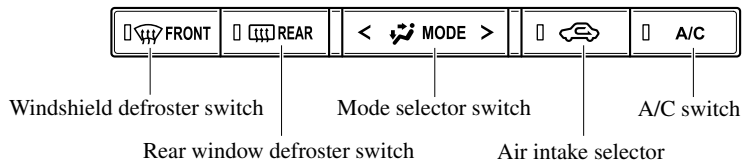
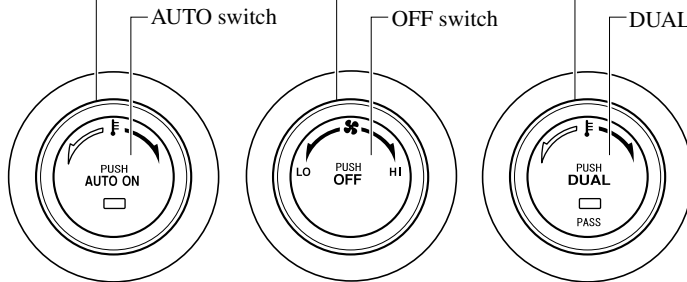

6-10 \*Some models.

## Interior Comfort Climate Control System

### ▼ Control Switches

#### AUTO switch

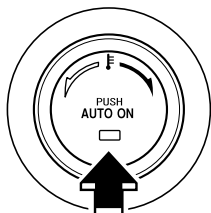

By pressing the AUTO switch the following functions will be automatically controlled in accordance with the selected set temperature:

- Airflow temperature
- Amount of airflow
- Selection of airflow mode
- Outside/Recirculated air selection
- Air conditioner operation

#### **NOTE**

*AUTO switch indicator light*

- When on, it indicates AUTO operation, and the system will function automatically.
- If any of the following dials or switches are operated while in AUTO control, the AUTO switch indicator turns off.
  - Mode selector switch
  - Fan control dial
  - Windshield defroster switch

*The functions for dials and switches other than those operated in the above continue to operate in AUTO control.*

#### OFF switch

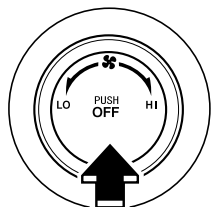

Pressing the OFF switch shuts off the climate control system.

#### Temperature control dial

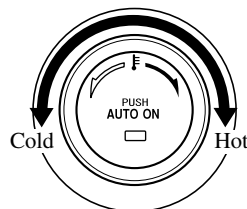

This dial controls temperature. Turn it clockwise for hot and counterclockwise for cold.

- When the DUAL switch is off: Turn the driver temperature control dial to control the temperature.
- When the DUAL switch is on: Turn the driver or front passenger temperature control dial to control the temperature.

#### **NOTE**

*The system changes to the individual operation mode (DUAL switch indicator light illuminated) by turning the front passenger temperature control dial even when the DUAL switch is off, which allows individual control of the set temperature for the driver and front passenger.*

#### Fan control dial

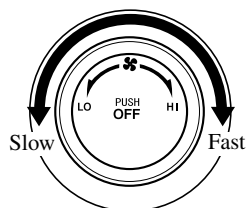

The fan has seven speeds. The selected speed will be displayed.

Interior Comfort







## Climate Control System

### Mode selector switch



The desired airflow mode can be selected (page 6-4).

#### **NOTE**

- With the airflow mode set to the  position and the temperature control dial set at a medium temperature, heated air is directed to the feet and a comparably lower air temperature will flow through the central, left and right vents.
- To set the air vent to , press the windshield defroster switch.
- In the  or  position, the air conditioner is automatically turned on and the outside air mode is automatically selected to defrost the windshield. In the  or  position, the outside air mode cannot be changed to the recirculated air mode.

### A/C switch

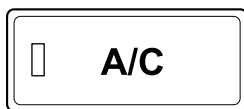

Pressing the A/C switch while the AUTO switch is turned on will turn off the air conditioning (cooling/dehumidifying functions). The air conditioning can be turned on and off by pressing the A/C switch while the fan control dial is on.

#### **NOTE**

- The air conditioning operates when the A/C switch is pressed even if the fan is off.
- The air conditioner may not function when the outside temperature approaches 0 °C (32 °F). (Indicator light remains on even when system is off.)

### Air intake selector

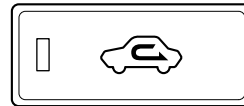

Outside or recirculated air positions can be selected. Press the switch to select outside/recirculated air positions.

#### **Recirculated air position (indicator light illuminated)**

Use this position when going through tunnels, driving in congested traffic (high engine exhaust areas) or when quick cooling is desired.

#### **Outside air position (indicator light turned off)**

Use this position for normal conditions and defogging.



## Interior Comfort Climate Control System

### **⚠ WARNING**

Do not use the  position in cold or rainy weather:

Using the  position in cold or rainy weather is dangerous as it will cause the windows to fog up. Your vision will be hampered, which could lead to a serious accident.

### **DUAL switch**

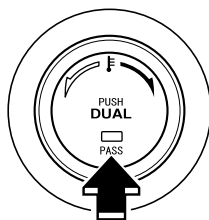

Use the DUAL switch to change the mode between the individual operation (driver and passenger) and interconnection (simultaneous) modes.

### **Individual operation mode (indicator light illuminated)**

The set temperature can be controlled individually for the driver and front passenger.

### **Interconnection mode (indicator light turned off)**

The set temperature for the driver and front passenger is controlled simultaneously.

### **NOTE**



**DUAL** is displayed on the information display while in the individual operation mode.

### **Windshield defroster switch**



Press the switch to defrost the windshield and front door windows.

### **NOTE**

In the  position, the air conditioner is automatically turned on and the outside air mode is automatically selected to defrost the windshield. In the  position, the outside air mode cannot be changed to the recirculated air mode.

### **▼ Operation of Automatic Air Conditioning**

1. Press the AUTO switch. Selection of the airflow mode, air intake selector and amount of airflow will be automatically controlled.

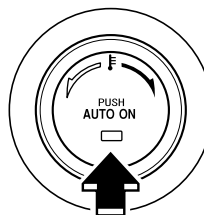

Interior Comfort

## Climate Control System

- Use the temperature control dial to select a desired temperature. Press the DUAL switch or turn the front passenger temperature control dial to control the set temperature individually for the driver and front passenger.

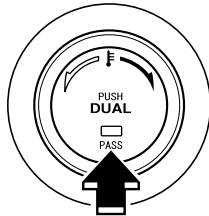

To turn off the system, press the OFF switch.

### NOTE

- Setting the temperature to the maximum high or low will not provide the desired temperature at a faster rate.
- When selecting heat, the system will restrict airflow until it has warmed to prevent cold air from blowing out of the vents.

### ▼ Windshield Defrosting and Defogging



Press the windshield defroster switch. In this position, the outside air position is automatically selected, and the air conditioner automatically turns on. The air conditioner will directly dehumidify the air to the front windshield and side windows (page 6-4). Airflow amount will be increased.

### ⚠ WARNING

**Set the temperature control to the hot or warm position when defogging (☁ position):**

*Using the ☁ position with the temperature control set to the cold position is dangerous as it will cause the outside of the windshield to fog up. Your vision will be hampered, which could lead to a serious accident.*

### NOTE

*Use the temperature control dial to increase the air flow temperature and defog the windshield more quickly.*

Interior Comfort  
**Climate Control System**

▼ **Sunlight/Temperature Sensor**

The fully automatic air conditioner function measures inside and outside temperatures, and sunlight. It then sets temperatures inside the passenger compartment accordingly.

**CAUTION**

*Do not obstruct either sensor, otherwise the automatic air conditioner will not operate properly.*

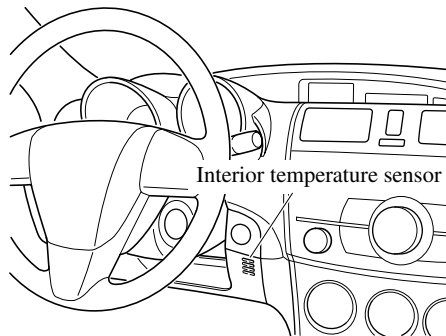
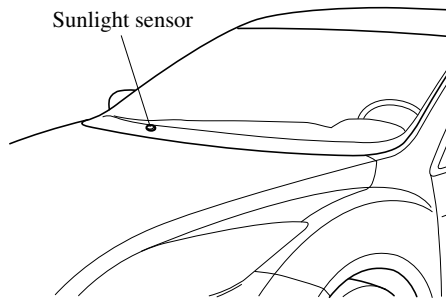

Interior Comfort

## Audio System

### Antenna

#### ▼ Antenna (4 Door)

##### AM/FM Radio Antenna

The antenna is printed onto the window glass.

#### **CAUTION**

*When washing the inside of the window which has an antenna, use a soft cloth dampened in lukewarm water, gently wiping the antenna lines.*

*Use of glass cleaning products could damage the antenna.*

##### Satellite Radio Antenna\*

The satellite radio antenna receives SIRIUS signals.

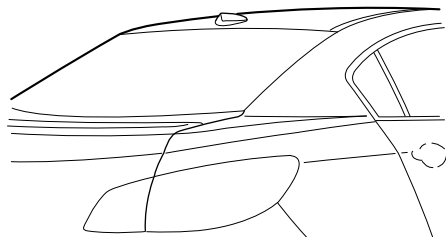

#### ▼ Antenna (5 Door)

To remove the antenna, turn it counterclockwise.

To install the antenna, turn it clockwise.  
Make sure the antenna is securely installed.

##### AM/FM Radio Antenna\*

The AM/FM radio antenna receives both AM and FM signals.

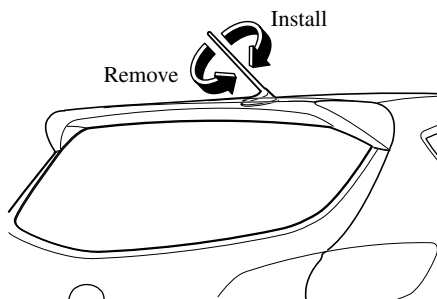

##### Antenna for AM/FM and Satellite Radio Antenna\*

The antenna for AM/FM and satellite radio antenna receives both AM and FM signals and SIRIUS signals.

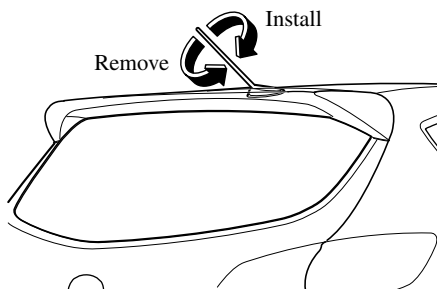

#### **CAUTION**

- *To prevent damage to the antenna, remove it before entering a car wash facility or passing beneath a low overhead clearance.*
- *Be careful around the antenna when removing snow from the roof. Otherwise the antenna could be damaged.*

Interior Comfort  
**Audio System**

**NOTE**

*When leaving your vehicle unattended, we recommend that you remove the antenna and store it inside the vehicle.*

**Operating Tips for Audio System**

**⚠ WARNING**

**Do not adjust the audio control switches while driving the vehicle:**

*Adjusting the audio while driving the vehicle is dangerous as it could distract your attention from the vehicle operation which could lead to a serious accident. Always adjust the audio while the vehicle is stopped.*

*Even if the audio control switches are equipped on the steering wheel, learn to use the switches without looking down at them so that you can keep your maximum attention on the road while driving the vehicle.*

**⚠ CAUTION**

*For the purposes of safe driving, adjust the audio volume to a level that allows you to hear sounds outside of the vehicle including car horns and particularly emergency vehicle sirens.*

**NOTE**

- *To prevent the battery from being discharged, do not leave the audio system on for a long period of time when the engine is not running.*
- *If a cellular phone or CB radio is used in or near the vehicle, it could cause noise to occur from the audio system, however, this does not indicate that the system has been damaged.*

Interior Comfort

## Audio System

### ▼ Radio Reception

#### AM characteristics

AM signals bend around such things as buildings or mountains and bounce off the ionosphere. Therefore, they can reach longer distances than FM signals. Because of this, two stations may sometimes be picked up on the same frequency at the same time.

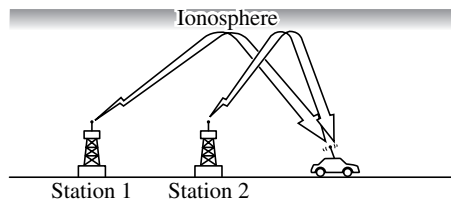

#### FM characteristics

An FM broadcast range is usually about 40—50 km (25—30 miles) from the source. Because of extra coding needed to break the sound into two channels, stereo FM has even less range than monaural (non-stereo) FM.

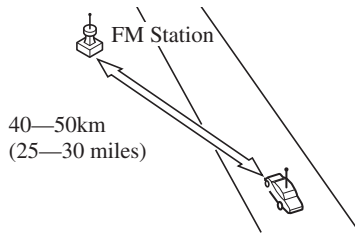

Signals from an FM transmitter are similar to beams of light because they do not bend around corners, but they do reflect. Unlike AM signals, FM signals cannot travel beyond the horizon. Therefore, FM stations cannot be received at the great distances possible with AM reception.

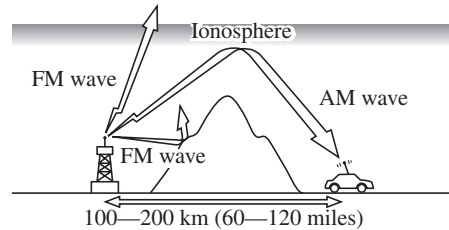

Atmospheric conditions can also affect FM reception. High humidity will cause poor reception. However, cloudy days may provide better reception than clear days.

#### Multipath noise

Since FM signals can be reflected by obstructions, it is possible to receive both the direct signal and the reflected signal at the same time. This causes a slight delay in reception and may be heard as a broken sound or a distortion. This problem may also be encountered when in close proximity to the transmitter.

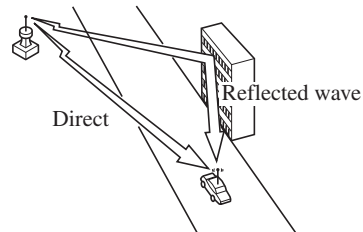

## Interior Comfort Audio System

### Flutter/Skip noise

Signals from an FM transmitter move in straight lines and become weak in valleys between tall buildings, mountains, and other obstacles. When a vehicle passes through such an area, the reception conditions may change suddenly, resulting in annoying noise.

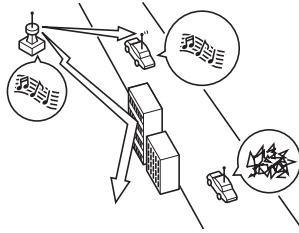

### Weak signal noise

In suburban areas, broadcast signals become weak because of distance from the transmitter. Reception in such fringe areas is characterized by sound breakup.

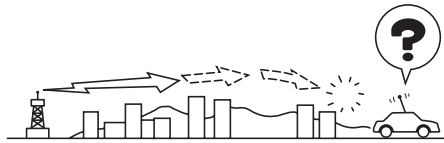

### Strong signal noise

This occurs very close to a transmitter tower. The broadcast signals are extremely strong, so the result is noise and sound breakup at the radio receiver.

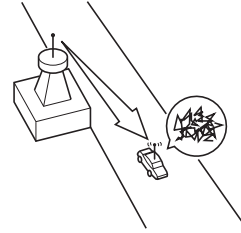

### Station drift noise

When a vehicle reaches the area of two strong stations broadcasting at similar frequencies, the original station may be temporarily lost and the second station picked up. At this time there will be some noise from this disturbance.

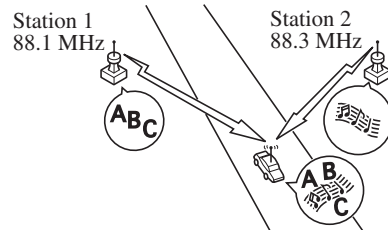

Interior Comfort

## Audio System

### ▼ Operating Tips for CD Player/In-Dash CD Changer

#### Condensation phenomenon

Immediately after turning on the heater when the vehicle is cold, the CD or optical components (prism and lens) in the CD player/In-dash CD changer may become clouded with condensation. At this time, the CD will eject immediately when placed in the unit. A clouded CD can be corrected simply by wiping it with a soft cloth. Clouded optical components will clear naturally in about an hour. Wait for normal operation to return before attempting to use the unit.

#### Handling the CD player/In-dash CD changer

The following precautions should be observed.

- Do not spill any liquid on the audio system.

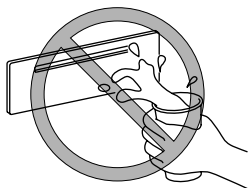

- Do not insert any objects, other than CDs, into the slot.

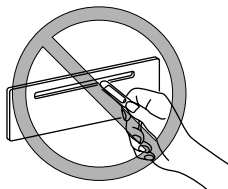

- The CD revolves at high speed within the unit. Defective (cracked or badly bent) CDs should never be used.

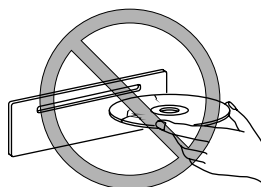

- Do not use non-conventional discs such as heart-shaped, octagonal discs, etc. The disc may not eject resulting in a malfunction.

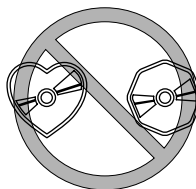

- If the memory portion of the CD is transparent or translucent, do not use the disc.

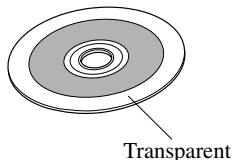



Interior Comfort  
**Audio System**

- A new CD may have rough edges on its inner and outer perimeters. If a disc with rough edges is used, proper setting will not be possible and the CD player/In-dash CD changer will not play the CD. In addition, the disc may not eject resulting in a malfunction. Remove the rough edges in advance by using a ball-point pen or pencil as shown below. To remove the rough edges, rub the side of the pen or pencil against the inner and outer perimeter of the CD.

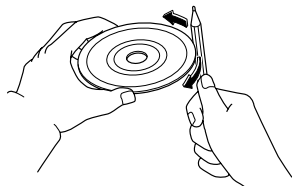

- When driving over uneven surfaces, the sound may jump.

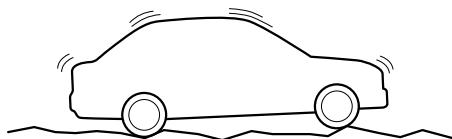

- The CD player/In-dash CD changer has been designed to play CDs bearing the identification logo as shown below. No other discs can be played.



- Use discs that have been legitimately produced. If illegally-copied discs such as pirated discs are used, the system may not operate properly.
- Be sure never to touch the signal surface when handling the CDs. Pick up a CD by grasping the outer edge or the edge of the hole and the outer edge.

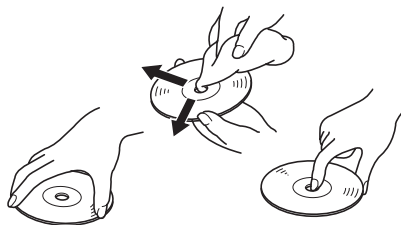

- Do not stick paper or tape on the CD. Avoid scratching the reverse side (the side without a label). The disc may not eject resulting in a malfunction.
- Dust, finger smudges, and dirt can decrease the amount of light reflected from the signal surface, thus affecting sound quality. If the CD should become soiled, gently wipe it with a soft cloth from the center of the CD to the edge.

Interior Comfort

## Audio System

- Do not use record sprays, antistatic agents, or household spray cleaners. Volatile chemicals such as benzine and thinner can also damage the surface of the CD and must not be used. Anything that can damage, warp, or fog plastic should never be used to clean CDs.
- Insert discs one by one. If two discs are inserted at the same time, the system may not operate properly.
- The CD player/In-dash CD changer ejects the CD if the CD is inserted upside down. Also dirty and/or defective CDs may be ejected.
- Do not insert cleaning discs in the CD player/In-dash CD changer.
- Do not insert any disc with a peel-off seal affixed to it.
- This unit may not be able to play certain CD-R/CD-RWs made using a computer or music CD recorder due to disc characteristics, scratches, smudges, dirt, etc., or due to dust or condensation on the lens inside the unit.
- Storing CDs in the vehicle exposed to direct sunlight or high temperature may damage the CD-R/CD-RWs, and make them unplayable.
- CD-R/CD-RW exceeding 700 MB cannot be played.
- This unit may not be able to play certain discs made using a computer due to the application (writing software) setting used. (For details, consult the store where the application was purchased.)
- It is possible that certain text data, such as titles, recorded on a CD-R/CD-RW may not be displayed when musical data (CD-DA) is playing.
- The period from when a CD-RW is inserted to when it begins playing is longer than a normal CD or CD-R.

- Completely read the instruction manual and cautions for CD-R/CD-RWs.
- Do not use discs with cellophane tape adhering, partially peeled off labels, or adhesive material exuding from the edges of the CD label. Also, do not use discs with a commercially-available CD-R label affixed. The disc may not eject resulting in a malfunction.

### ▼ Operating Tips for MP3

#### **NOTE**

*Supply of this product only conveys a license for private, non-commercial use and does not convey a license nor imply any right to use this product in any commercial (i.e. revenue-generating) real time broadcasting (terrestrial, satellite, cable and/or any other media), broadcasting/streaming via the Internet, intranets and/or other networks or in other electronic content distribution systems, such as pay-audio or audio-on-demand applications. An independent license for such use is required. For details, please visit <http://www.mp3licensing.com>.*

- This audio system handles MP3 files that have been recorded on CD-R/CD-RW/CD-ROMs. Discs that have been recorded using the following formats can be played:
  - ISO 9660 level 1
  - ISO 9660 level 2
  - Joliet extended format
  - Romeo extended format
- This unit handles MP3 files conforming to the MP3 format containing both header frames and data frames.
- This unit can play multi-session recorded discs that have up to 40<sup>\*1</sup>/50<sup>\*2</sup> sessions.
  - \*1 Type A
  - \*2 Type B

Interior Comfort  
**Audio System**

- This unit can play MP3s with sampling frequencies of 8<sup>\*1</sup>/11.025<sup>\*1</sup>/12<sup>\*1</sup>/16/22.05/24/32/44.1/48 kHz.  
<sup>\*1</sup> Type B
- This unit can play MP3 files that have been recorded in bit rates of 8 kbps to 320 kbps. Nonetheless, to insure enjoyment of music with consistent sound quality, it is recommended to use discs that have been recorded at a bit rate of 128 kbps or more.
- If a disc has both music data (CD-DA) and MP3 files, playback of the two file types differs depending on how the disc was recorded.
- Packet written discs cannot be played on this unit.
- This unit does not play CDs recorded using MP3i (MP3 interactive), MP3 PRO and RIFF MP3 formats.

**About folders and files**

- The order of hierarchy for MP3 files and folders during playback or other functions is from shallow to deep. The arrangement and playing order of a recorded disc containing MP3 files is as follows:
  - **File number**  
A numerical file number is assigned to each file in a folder starting from the deepest hierarchy.
  - **Folder number**  
A numerical folder number is assigned to each folder starting from the deepest hierarchy.

**NOTE**

*Folders and tracks (files) within the same hierarchy play in the order they were written to the disc depending on the write software.*

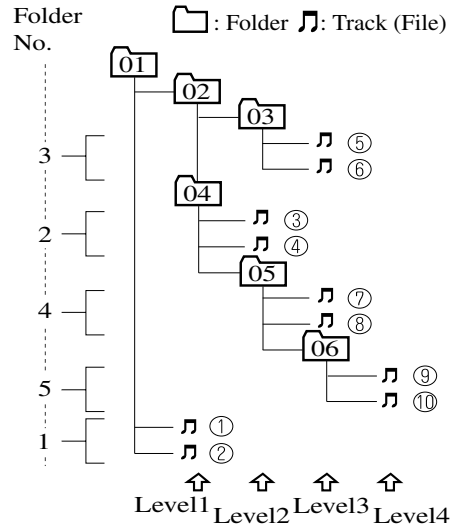

Playback may not occur in the above hierarchy depending on the audio unit.

- The folder order is automatically assigned and this order cannot be optionally set.
- Any folder without an MP3 file will be ignored. (It will be skipped and the folder number will not be displayed.)
- MP3 files not conforming to the MP3 format containing both header frames and data frames will be skipped and not played.
- This unit will play MP3 files that have up to eight levels. However, the more levels a disc has, the longer it will take to initially start playing. It is recommended to record discs with two levels or less.
- A single disc with up to 512 files can be played and a single folder with up to 255 files can be played.
- When naming an MP3 file, be sure to add an MP3 file extension (.mp3) after the file name.

Interior Comfort

## Audio System

- The number of characters which can be displayed is restricted.

### **CAUTION**

*This unit can only play MP3 files that have an MP3 file extension (.mp3) attached. Do not attach an MP3 file extension to any other type file as it could cause noise to be emitted or a malfunction in the unit.*

### **About ID3 Tag display**

- This unit can only display ID3 Tag album, track and artist names that have been input using Ver.1.0/1.1/2.2/2.3/2.4\*<sup>1</sup> formats. Any other data that may have been input cannot be displayed.  
\*<sup>1</sup> Type B
- **(Type A)**  
This unit can only display English (including numerals) one-byte characters. Use only English (including numerals) one-byte characters when inputting ID3 tags. Two-byte characters and some special symbols cannot be displayed.
- **(Type B)**  
This unit cannot display some characters. Characters which cannot be displayed are indicated by an asterisk (\*).

### **Specialized glossary**

#### **MP3**

Abbreviation for "MPEG Audio Layer 3". A technical standard for audio compression as decided by the ISO\*<sup>1</sup> MPEG working group. Use of MP3 allows for audio data to be compressed to approximately a tenth of the source data size.

\*<sup>1</sup> International Organization for Standardization

### **ISO 9660**

An international standard for logical formatting of CD-ROM files and folders. It is divided into three separate levels based on differences in file naming procedures, data configuration and other characteristics.

### **Multi-session**

A session is the complete amount of data recorded from the beginning to the end of a single period of CD-ROM, CD-R/CD-RW data recording. Multi-session refers to the existence of data from two or more sessions on a single disc.

### **Sampling**

Refers to the process of encoding analog audio data at regular intervals and converting it to digital data. The sampling rate refers to the number of times a sample is taken in one second and is expressed in Hz units. Increasing the sampling rate improves the sound quality but also increases the data size.

### **Bit rate**

Refers to the volume of data per second, expressed in bps (bits per second). Generally, the larger the number of the transfer bit rate when compressing an MP3 file, the more information regarding musical reproduction it carries, and therefore the better the sound quality.

### **Packet writing**

A general term for the method, similar to that used for floppy discs or hard drives, of recording the required file in a single increment on a CD-R and similar.

Interior Comfort  
**Audio System**

**ID3 Tag**

ID3 tag is a method for storing information related to the music in an MP3 file. Information such as track, artist and album name can be stored. This content can be freely edited using ID3 editing function software.

**VBR**

Abbreviation for Variable Bit Rate. While CBR (Constant Bit Rate) is generally used, VBR varies the bit rate for audio compression according to compression conditions and this allows for compression with preference given to sound quality.

**▼ Operating Tips for WMA**

WMA is short for Windows Media Audio and is the audio compression format used by Microsoft.

Audio data can be created and stored at a higher compression ratio than MP3.

\* Microsoft and Windows Media are registered trademarks of Microsoft Corporation U.S. in the United States and other countries.

Playable WMA files are as follows:

| Item          | Content                                   |   |
|---------------|---|---|
|               | Type A                                    | Type B  |
| Audio Type    | Type A                                    | Type B  |
| Specification | Windows Media Audio Version 7.0, 8.0, 9.0 | Ver 7.0, 8.0, 9.0 (standard)<br>Ver 10 (standard) |
| Sampling rate | 32/44.1/48 kHz                            |   |
| Bit rate      | 32—320 kbps                               |   |

**⚠ CAUTION**

*This unit plays files with the (.wma) file extension as a WMA file. Do not use the WMA file extension for files other than WMA files. Otherwise, it could result in noise or a malfunction.*

- Track, artist and album name information is recorded as data termed “WMA-Tag”, and this information is displayable.
- WMA files written under specifications other than the indicated specification may not play normally or files or folder names may not display correctly.
- The file extension may not be provided depending on the computer operating system, version, software, or settings. In this case, add the file extension “.wma” to the end of the file name, and then write it to the disc.

**▼ Operating Tips for AAC**

Advanced Audio Coding (AAC) is standardized voice compression established by the ISO\*1 working group (MPEG). Audio data can be created and stored at a higher compression ratio than MP3.

\*1 International Organization for Standardization

**Playable AAC file specifications**

This unit supports playback of AAC files recorded in CD-R and CD-RW.

Interior Comfort

## Audio System

Playable AAC files are as follows:

| Item          | Content  |
|---------------|--|
| Specification | MPEG-4 AAC   |
| Sampling rate | 8/11.025/12 kHz<br>16/22.05/24 kHz<br>32/44.1/48 kHz |
| Bit rate      | 24—320 kbps  |

### CAUTION

*This unit plays files with the file extension (.m4a) as an AAC file. Do not use the AAC file extension for files other than AAC files. Otherwise, it could result in noise or a malfunction.*

- Song, artist, and album name information in the AAC file is recorded as data termed “iTunes, m4a, Meta-Data applicable”, and this information is displayable.
- AAC files written under specifications other than the indicated specification may not play normally or files or folder names may not display correctly.
- The file extension may not be provided depending on the computer operating system, version, software, or settings. In this case, add the file extension “.m4a” to the end of the file name, then write it to the disc.

### ▼ Operating Tips for USB device

This unit supports playback of MP3/WMA/AAC files recorded to USB device.

#### NOTE

- *Music data (MP3/WMA/AAC (.m4a) format) stored in a USB mass-storage class compliant device (such as USB flash memory) can be played.*
- *Playback may not be possible depending on the type and condition of the USB flash memory even if the audio file complies with the standard above.*
- *A copyright protected WMA/AAC file cannot be played in this unit.*
- *The order of the music data stored in the device may differ from the playback order.*
- *To prevent loss or damage of stored data, we recommend that you always back up your data.*
- *If a device exceeds the maximum electric current value of 1 A (Type A), 500 mA (Type B), it may not operate or recharge when connected.*
- *Do not pull out the USB device while in the USB mode (only pull it out while in FM/AM radio or CD mode).*
- *The device will not operate if the data is password protected.*

Interior Comfort  
**Audio System**

**Playable MP3 file specifications**

Playable MP3 files are as follows:

| Item          | Content  |   |
|---------------|--|---|
| Audio Type    | Type A   | Type B  |
| Specification | MPEG1 AUDIO LAYER III<br>MPEG2 AUDIO LAYER III<br>MPEG2.5                      |   |
| Sampling rate | 44.1/48/32 kHz (MPEG1)<br>22.05/24/16 kHz (MPEG2)<br>11.025/12/8 kHz (MPEG2.5) |   |
| Bit rate      | 32—320 kbps (MPEG1)<br>32—160 kbps (MPEG2)<br>32—160 kbps (MPEG2.5)            | 32—320 kbps (MPEG1)<br>8—160 kbps (MPEG2)<br>8—160 kbps (MPEG2.5) |

**⚠ CAUTION**

*This unit plays files with the file extension (mp3) as an MP3 file. Do not use the MP3 file extension for files other than MP3 files. Otherwise, it could result in noise or a malfunction.*

- MP3 files written under specifications other than the indicated specification may not play normally or files or folder names may not display correctly.
- The file extension may not be provided depending on the computer operating system, version, software, or settings. In this case, add the file extension “.mp3” to the end of the file name, and then write it to the memory.

**Playable WMA file specification**

Playable WMA files are as follows:

| Item          | Content  |  |
|---------------|--|--|
| Audio Type    | Type A   | Type B   |
| Specification | Windows Media Audio Version 7.0, 8.0, 9.0 (standard) |  |
| Sampling rate | 22.05 kHz (MID)<br>44.1/48/32 kHz (HI)               | 8/11.025/12 kHz (LOW)<br>16/22.05 kHz (MID)<br>44.1/48/32 kHz (HI) |
| Bit rate      | 32—192 kbps  | 32—320 kbps  |

**⚠ CAUTION**

*This unit plays files with the file extension (wma) as a WMA file. Do not use the WMA file extension for files other than WMA files. Otherwise, it could result in noise or a malfunction.*

- WMA files written under specifications other than the indicated specification may not play normally or files or folder names may not display correctly.
- The file extension may not be provided depending on the computer operating system, version, software, or settings. In this case, add the file extension “.wma” to the end of the file name, and then write it to the memory.

**Playable AAC file specification**

Playable AAC files are as follows:

| Item          | Content  |             |
|---------------|--|-------------|
| Audio Type    | Type A   | Type B      |
| Specification | MPEG4 AAC-LC   |             |
| Sampling rate | 8/11.025/12 kHz<br>16/22.05/24 kHz<br>32/44.1/48 kHz |             |
| Bit rate      | 24—320 kbps  | 16—320 kbps |

Interior Comfort

## Audio System

### CAUTION

*This unit plays files with the file extension (.aac/.m4a) as an AAC file. Do not use the AAC file extension for files other than AAC files. Otherwise, it could result in noise or a malfunction.*

- AAC files written under specifications other than the indicated specification may not play normally or files or folder names may not display correctly.
- The file extension may not be provided depending on the computer operating system, version, software, or settings. In this case, add the file extension “.mp4” or “.m4a” to the end of the file name, and then write it to the memory.

### ▼ Operating Tips for iPod

This unit supports playback of music files recorded to an iPod.

- iPod is a trademark of Apple Inc., registered in the U.S. and other countries.
- iPod classic is a trademark of Apple Inc., registered in the U.S. and other countries.
- iPod nano is a trademark of Apple Inc., registered in the U.S. and other countries.
- iPod touch is a trademark of Apple Inc., registered in the U.S. and other countries.
- iPhone is a trademark of Apple Inc., registered in the U.S. and other countries.
- iPad is a trademark of Apple Inc., registered in the U.S. and other countries.

Connectable iPods are as follows:

- iPod: 5G
- iPod classic
- iPod nano: 1/2/3/4/5/6G
- iPod touch<sup>\*2</sup>: 1/2/3/4G
- iPhone<sup>\*2</sup>: iPhone/3G/3GS/4<sup>\*1</sup>/4S<sup>\*1</sup>
- iPad<sup>\*1\*2</sup>: 1st/2nd/3rd

\*1 Type B

\*2 Only iPod function

### CAUTION

- *Remove the iPod when it is not in use. Because the iPod is not designed to withstand excessive changes in temperature inside the cabin, it could be damaged or the battery may deteriorate due to the excessive temperature or humidity inside the cabin if it is left in the vehicle.*
- *If data in the iPod is lost while it is connected to the unit, Mazda cannot guarantee recovery of any lost data.*
- *If the iPod battery is deteriorated, the iPod may not recharge and playback may not be possible when it is connected to the unit. Replace the iPod battery immediately.*
- *Be careful not to pinch the iPod connecting cable when opening/closing the center console.*
- *For the details on using the iPod, refer to the iPod instruction manual.*
- *When connecting the iPod to a USB port, all commands are made from the audio unit. iPod control is not possible.*

### NOTE

*The audio unit cannot display the images or videos stored in an iPod.*



Interior Comfort  
**Audio System**

**Types of the Audio Set/System**

Audio Set (Type A) ..... page 6-31

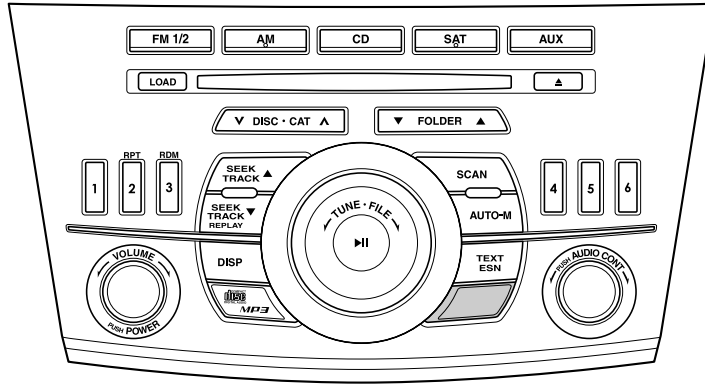

Audio Set (Type B) ..... page 6-61

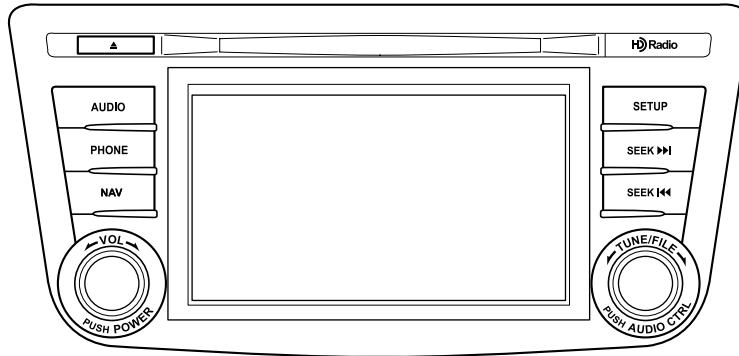

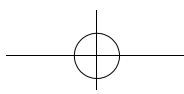

# MEMO

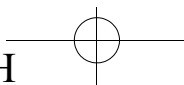
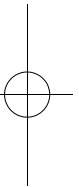
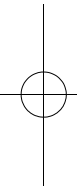

Interior Comfort  
**Audio System**

**Audio Set (Type A)**

Audio information is displayed on the information display.

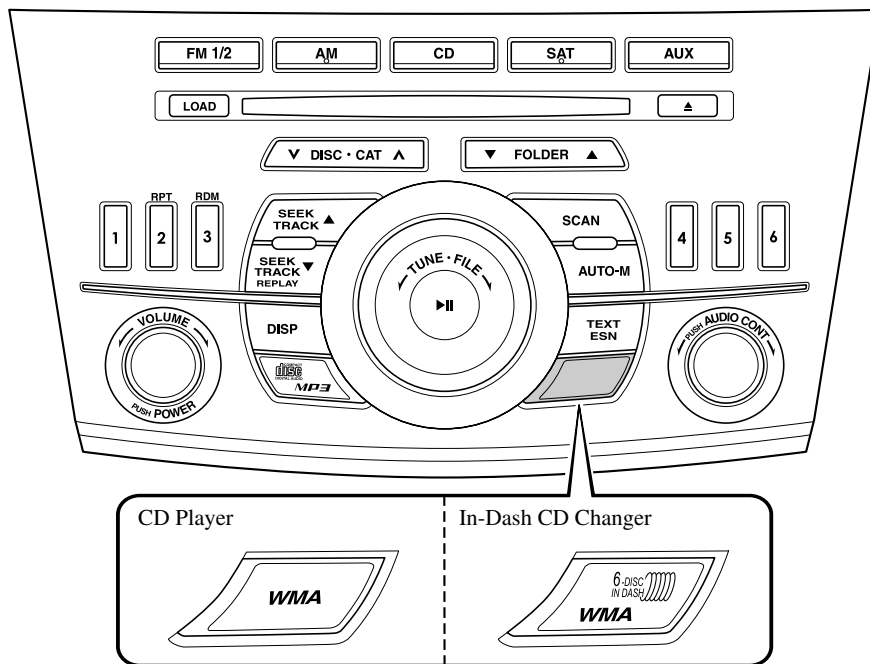

|  |           |
|--|-----------|
| Power/Volume/Sound Controls .....            | page 6-32 |
| Operating the Radio .....                    | page 6-36 |
| Operating the Satellite Radio .....          | page 6-38 |
| Operating the Compact Disc (CD) Player ..... | page 6-50 |
| Operating the In-Dash CD Changer .....       | page 6-54 |
| Operating the Auxiliary jack/USB port .....  | page 6-58 |
| Error Indications .....                      | page 6-59 |

## Interior Comfort Audio System

### ▼ Power/Volume/Sound Controls

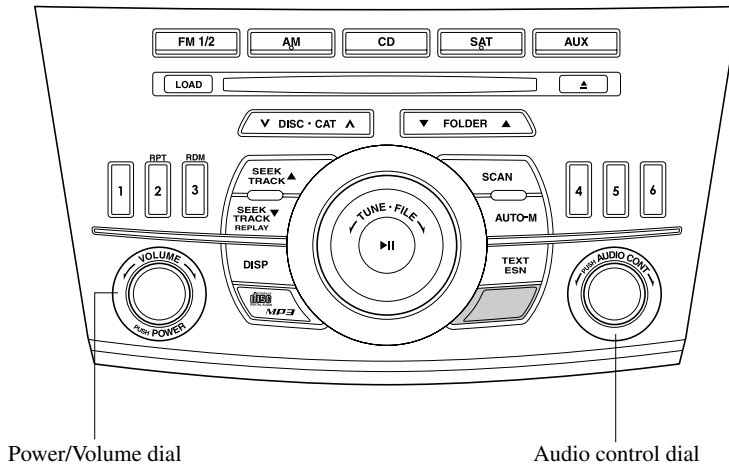

#### **Power ON/OFF**

Switch the ignition to ACC or ON.

Press the power/volume dial to turn the audio system on.

Press the power/volume dial again to turn the audio system off.

#### **NOTE**

*To prevent the battery from being discharged, do not leave the audio system on for a long period of time when the engine is not running.*

#### **Volume adjustment**

To adjust the volume, turn the power/volume dial.

Turn the power/volume dial to the right to increase volume, to the left to decrease it.

#### **Audio sound adjustment**

1. Press the audio control dial to select the function. The selected function will be indicated.

Interior Comfort  
**Audio System**

**Standard audio-equipped model**

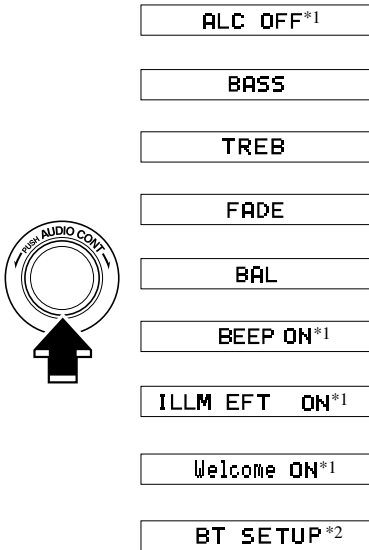

**Bose® Sound System-equipped model**

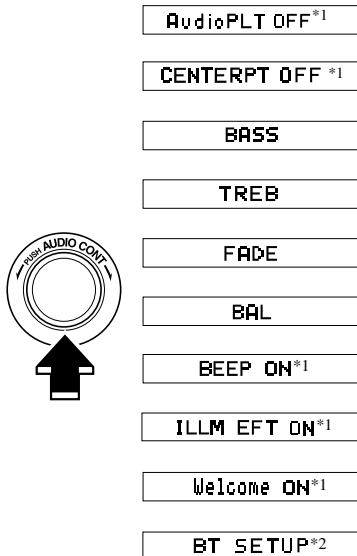

\*1 Depending on the mode selected, the indication changes.

\*2 Depending on the model, this function, may not be available.

2. Turn the audio control dial to adjust the selected functions as follows:

**Standard audio-equipped model**

| Indication | Turn Left                    | Turn Right                   |
|------------|------------------------------|------------------------------|
| ALC        | Select mode                  |                              |
| BASS       | Decrease bass                | Increase bass                |
| TREB       | Decrease treble              | Increase treble              |
| FADE       | Shift the sound to the front | Shift the sound to the rear  |
| BAL        | Shift the sound to the left  | Shift the sound to the right |
| BEEP       | Off                          | On                           |
| ILLM EFT   | Off                          | On                           |
| Welcome    | Off                          | On                           |
| BT SETUP   | Select mode                  |                              |

Interior Comfort  
**Audio System**

**Bose® Sound System-equipped model**

| Indication | Turn Left                    | Turn Right                   |
|------------|------------------------------|------------------------------|
| AudioPLT   | Off                          | On                           |
| CENTERPT   | Off                          | On                           |
| BASS       | Decrease bass                | Increase bass                |
| TREB       | Decrease treble              | Increase treble              |
| FADE       | Shift the sound to the front | Shift the sound to the rear  |
| BAL        | Shift the sound to the left  | Shift the sound to the right |
| BEEP       | Off                          | On                           |
| ILLM EFT   | Off                          | On                           |
| Welcome    | Off                          | On                           |
| BT SETUP   | Select mode                  |                              |

**NOTE**

- Depending on the type of audio unit, the order in which the functions appear differs.
- About 5 seconds after selecting any mode, the volume function will be automatically selected. To reset bass, treble, fade, and balance, press the audio control dial for 2 seconds. The unit will beep and "CLEAR" will be displayed.

**Automatic Level Control (ALC)  
 (Standard audio-equipped model)**

The automatic level control (ALC) is a feature that automatically adjusts audio volume and sound quality according to the vehicle speed.

The volume increases in accordance with the increase in vehicle speed, and decreases as vehicle speed decreases.

Select the desired ALC mode.

| Mode        | Volume change |
|-------------|---------------|
| ALC OFF     | No change     |
| ALC LEVEL 1 | Minimum       |
| ALC LEVEL 2 | ▼ ▲           |
| ALC LEVEL 3 | ▼ ▲           |
| ALC LEVEL 4 | Medium        |
| ALC LEVEL 5 | ▼ ▲           |
| ALC LEVEL 6 | ▼ ▲           |
| ALC LEVEL 7 | Maximum       |

Turn the audio control dial to select ALC OFF or ALC LEVEL1—7 modes. The selected mode will be indicated.

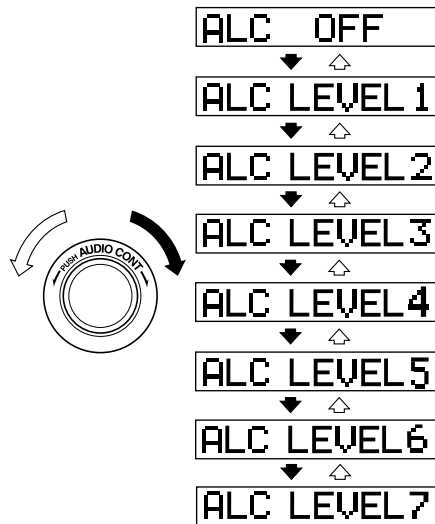

Interior Comfort  
**Audio System**

**AudioPilot® 2\* (Bose® Sound System-equipped model)**

AudioPilot® 2 automatically adjusts audio volume and sound quality in accordance with the level of noise entering the vehicle interior while driving. When AudioPilot® 2 is turned on, the system automatically calculates the conditions for optimum hearing of sound which may be difficult to hear depending on exterior noise.

\* AudioPilot® 2 is a registered trademark of Bose Corporation.

**Centerpoint®\* (Bose® Sound System-equipped model)**

Centerpoint® offers you the experience of 5.1-channel surround sound in your vehicle even with your conventional 2-channel stereo CDs.

Centerpoint® can be set on or off.

**NOTE**

- Centerpoint® operates optimally with a 2-channel stereo CD. MP3 audio files can be played, however, MP3 audio files encoded with high compression may result in poor sound quality.
- Centerpoint® is available for 2-channel stereo audio except for AM radio/FM radio/SIRIUS digital satellite radio/AUX/BT audio.

\* Centerpoint® is a registered trademark of Bose Corporation.

**BEEP setting**

The beep-sound when operating the audio system can be set on or off.

**ILLM EFT setting (Action Illumination setting during operation)**

The audio system illumination during operation can be set on or off.

**Welcome mode (Welcome sound)**

Sound is heard when the ignition is switched ON.

**BT SETUP mode\***

Music and other audio such as voice data recorded on portable audio devices and mobile phones available on the market which are equipped with the Bluetooth® transmission function can be listened to via wireless transmission over the vehicle's speakers. Using the BT SETUP mode, these devices can be programmed to the Bluetooth® unit or changed. Refer to Bluetooth® Audio (Type A) on page 6-106.

## Interior Comfort Audio System

### ▼ Operating the Radio

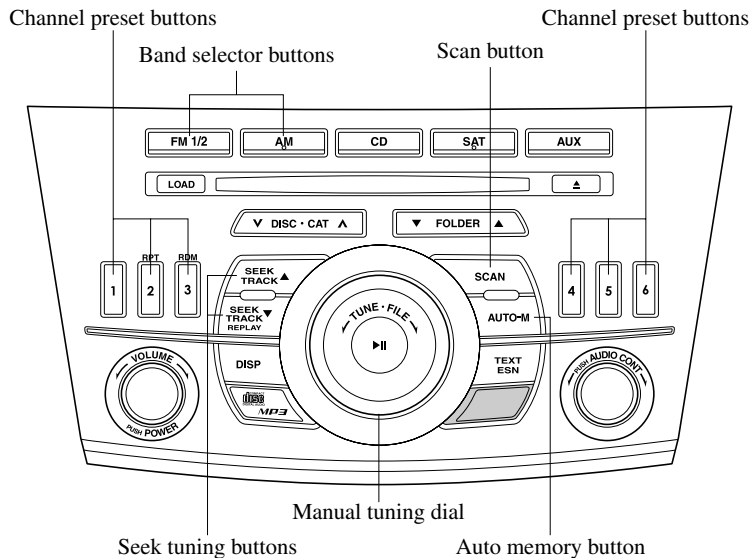

#### **Radio ON**

Press a band selector button (AM , FM ) to turn the radio on.

#### **Band selection**

Choose AM by pressing the AM button (AM ) and FM by pressing the FM button (FM ).

The selected mode will be indicated. If FM stereo is being received, "ST" will be displayed.

#### **NOTE**

*If the FM broadcast signal becomes weak, reception automatically changes from STEREO to MONO for reduced noise, and the "ST" indicator will go out.*

#### **Tuning**

The radio has the following tuning methods: Manual, Seek, Scan, Preset channel, and Auto memory tuning. The easiest way to tune stations is to set them on preset channels.

#### **NOTE**

*If the power supply is interrupted (fuse blows or the battery is disconnected), the preset channels will be erased.*

#### **Manual tuning**

Turning the manual tuning dial will change the frequency higher or lower.

#### **Seek tuning**

Pressing the seek tuning button (▲ , ▼ ) will cause the tuner to seek a higher or lower frequency automatically.



Interior Comfort  
**Audio System**

**NOTE**

*If you continue to press and hold the button, the frequency will continue changing without stopping.*

**Scan tuning**

Press the scan button (**SCAN**) to automatically sample strong stations. Scanning stops at each station for about 5 seconds. To hold a station, press the scan button (**SCAN**) again during this interval.

**Preset channel tuning**

The 6 preset channels can be used to store 6 AM and 12 FM stations.

1. To set a channel first select AM, FM1, or FM2. Tune to the desired station.
2. Depress a channel preset button for about 2 seconds until a beep sound is heard. The preset channel number and station frequency will be displayed. The station is now held in the memory.
3. Repeat this operation for the other stations and bands you want to store. To tune one in the memory, select AM, FM1, or FM2 and then press its channel preset button. The station frequency and the channel number will be displayed.

**NOTE**

*If the power supply is interrupted (fuse blows or the battery is disconnected), the preset channels will be erased.*

**Auto memory tuning**

This is especially useful when driving in an area where the local stations are not known. Additional AM/FM stations can be stored without disturbing the previously set channels.

Press and hold the auto memory button (**AUTO-M**) for about 2 seconds until a beep sound is heard; the system will automatically scan and temporarily store up to 6 stations with the strongest frequencies in each selected band in that area.

After scanning is completed, the station with the strongest frequency will be tuned and its frequency displayed. Press and release the auto memory button (**AUTO-M**) to recall stations from the auto-stored stations. One stored station will be selected each time; its frequency and channel number will be displayed.

**NOTE**

*If no stations can be tuned after scanning operations, "A" will be displayed.*

## Interior Comfort Audio System

### ▼ Operating the Satellite Radio \*

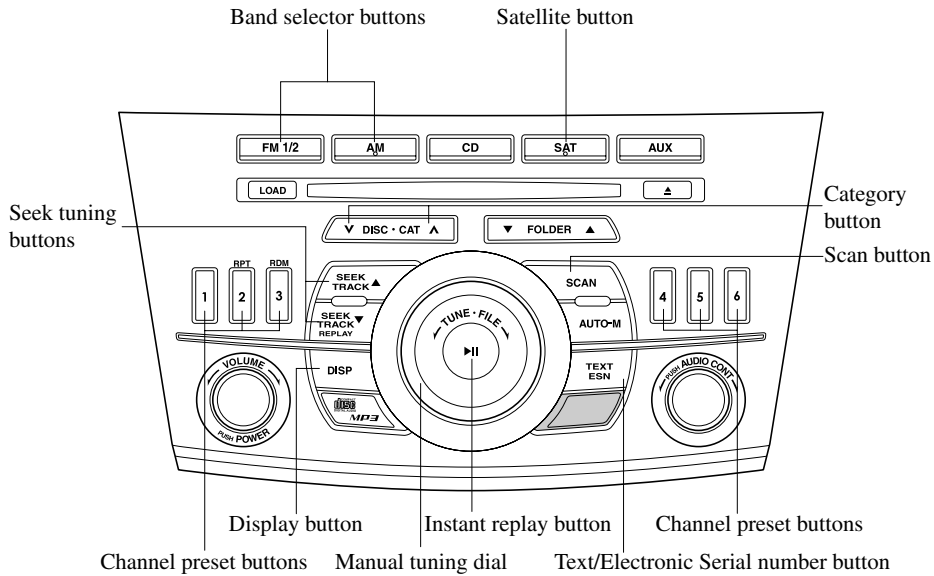

### Information display

All operations of the satellite radio are displayed on the Information display.

Channel number, Channel name, Category name, Artist name, Song title, ID code, Preset channel number, Bank number, Error signs

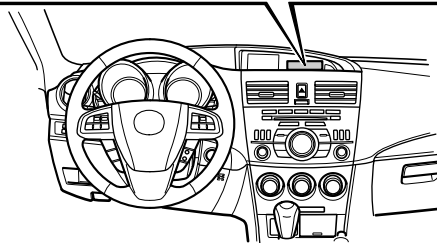
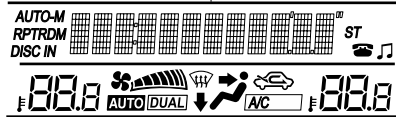

6-38 \*Some models.

Interior Comfort  
**Audio System**

**NOTE**

*This equipment has been tested and found to comply with the limits for a Class B digital device, pursuant to Part 15 of the FCC Rules. These limits are designed to provide reasonable protection against harmful interference in a residential installation. This equipment generates, uses, and can radiate radio frequency energy and if not installed and used in accordance with the instructions, may cause harmful interference to radio communications. However, there is no guarantee that interference will not occur in a particular installation. If this equipment does cause harmful interference to radio or television reception, which can be determined by turning the equipment off and on, the user is encouraged to try to correct the interference by one or more of the following measures:*

- Increase the separation between the equipment and tuner.
- Connect the equipment into an outlet on a circuit different from that to which the tuner is connected.
- Consult the dealer or an experienced radio/TV technician for help.

**What is satellite radio?**

With over 130 channels, SIRIUS Satellite Radio brings you more of what you love. Get 69 channels of 100 % commercial-free music, plus all your favorite sports, news, talk and entertainment. Everything worth listening to is now on SIRIUS.

**100 % Commercial-free Music**—With music from every genre, artist-dedicated channels, live performances and more, SIRIUS is the home of 100 % commercial-free music.

**Live Sports Play-by-Play & Expert Talk**—Hear every NFL game, every NASCAR<sup>®</sup> race and college sports coverage from over 150 schools. Plus 24/7 sports talk with channels like SIRIUS NFL Radio, SIRIUS NASCAR Radio and more.

**Exclusive Entertainment and Talk**—The biggest names, compelling talk, hilarious comedy. Hear Howard Stern, Martha Stewart, Jamie Foxx, Blue Collar Comedy, Playboy Radio, political talk and more.

**World-class News**—Stay informed with FOX, CNN, CNBC, NPR<sup>®</sup>, BBC and more.

Plus local traffic and weather.

**Family & Kids**—Entertain the entire family with Radio Disney, Kids Place Live, Laugh USA and more.

Sign up for SIRIUS Radio today! For more information, visit [www.siriusxm.com](http://www.siriusxm.com).

Satellite radio can be subscribed to and received in the United States. (Except Alaska and Hawaii) and Canada.

**How to Activate Satellite Radio**

You must call SIRIUS to activate your service. Activation is free and takes only a few minutes.

Interior Comfort

## Audio System

SIRIUS service uses an ID code to identify your radio. This code is needed to activate SIRIUS service, and report any problems.

To activate you SIRIUS radio tuner, call a SIRIUS customer service specialist at 1-888-539-7474 or you can visit SIRIUS online at [www.siriusxm.com](http://www.siriusxm.com).

Please have the following information ready:

- SIRIUS ID (12-digit electronic serial no., or ESN\*)
- Valid credit card information (may not be required at initial sign-up)

\*ESN: Electronic Serial Number

### **Displaying the SIRIUS ID (ESN)**

When the ESN button (ESN ) is pressed for 1.5 seconds or longer, or the manual tuning dial is turned to channel 0, a 12-digit Electronic Serial Number (ESN) for the SIRIUS tuner is displayed.

### **(If the SIRIUS ID (ESN) for the tuner does not display)**

If “ESN + FAIL” is displayed after pressing the ESN button (ESN ) for 1.5 seconds or longer, contact an Authorized Mazda Dealer.

Be sure you are parked outside with a clear view of open sky, you will be instructed to turn on your radio (in SAT mode and tuned to channel 184). Activation typically takes only 2—5 minutes.

### **SIRIUS operation**

All operations of the satellite radio are conducted by means of the audio unit.

### **SIRIUS radio mode selection**

When the satellite button (SAT ) is pressed during ACC ON, it will play the last SIRIUS channel in use before the mode was switched over to another mode or the power was turned off.

When the satellite button (SAT ) is pressed in a mode other than the SIRIUS mode, the last channel in use will be received.

Every time the satellite button (SAT ) is pressed, the bank changes in the order shown below.

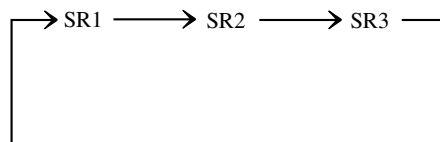

### **NOTE**

*SR1, SR2 and SR3: six stations can be stored in each bank for convenient access to your favorite stations.*

### **Operation in the initial state**

It may take some time to start up the equipment when it is in the initial state, when there is a change in the user's subscription condition, or when the SIRIUS channel map is changed.

Interior Comfort  
**Audio System**

“UPDATING xx%” is displayed when the SIRIUS channel map is changed. If the unit is initialized or the user contract content is changed, “UPDATING” is displayed. Updating could take as long as three minutes depending on the geographical area. When the unit is in an initialized state, channel 184 is displayed after the display indicates “UPDATING 100%”. If the SIRIUS channel map or the user contract content is changed, the channel prior to the change is displayed after “UPDATING” is displayed. After the initialization display, it may take as long as 12 seconds to receive channel 184.

**NOTE**

*Do not perform the following operation while “UPDATING” is displayed. Otherwise, the updating procedure will be cancelled.*

- Turning off the audio power
- Switching to other modes
- Switching the ignition off

When the SIRIUS mode is switched to another mode, or when the power is turned off, the present channel which is being received is stored as the last channel.

**Channel selection**

Turning the manual tuning dial allows you to select the desired receiving channel.

- Turn the knob clockwise: Channel Up
- Turn the knob counterclockwise: Channel Down

**Unsubscribed channel**

When a selected station has not been subscribed to, the display indicates the following:

After the channel number is displayed, [CALL + 888] and [539 + SIRI] (Flashes alternately) is displayed.

**NOTE**

*When the subscription contract is canceled, all of the channels including channel 184 appear as unsubscribed.*

**Invalid channel**

The display switches between [SR + (bank number)+ INVALID] and [SR + (bank number)+ CHANNEL] only when a selected channel is not broadcasting.

**NOTE**

*If the last channel selected has become unavailable because of a channel update the above indication is displayed until any button is pressed.*

**Preset channel programming**

**(Programming with “channel number” display)**

1. Select the desired channel to be programmed. At this point, the following is displayed:  
[SR + (bank number)+ (channel number)]
2. Keep pressing the channel preset button for 1.5 seconds or more. The programming process is complete after the channel number flashes. Then, [SR + (bank number)] is displayed and a beep sound is heard at the same time.
3. [SR + (bank number)+ CH + (preset number)+ (channel number)] are displayed.

Interior Comfort

## Audio System

### (Programming with “text” display (e.g. channel name))

1. Select the desired channel to be programmed. At this point, the following is displayed:  
[SR + (bank number)+ (selected text (e.g. channel name))]
2. Keep pressing the channel preset button for 1.5 seconds or more. The programming process is complete after the text (e.g. channel name) flashes. Then, [SR + (bank number)] is displayed and you will hear beep sound at the same time.
3. [SR + (bank number)+ CH + (preset number)+ (channel number)] are displayed.
4. Three seconds later, it returns to normal display. [SR + (bank number)+ (text (e.g. channel name))]

#### **NOTE**

*Six stations can be stored in each bank, SR1, SR2, and SR3 for convenient access to your favorite stations.*

### **Preset channel call-up**

Press and release the channel preset button,  
[SR + (bank number)+ CH + (preset number)+ (channel number)] appears. When the preset button is pressed during text mode, its channel number is displayed first for three second and then its text is displayed.

#### **NOTE**

*In the initial setting, all channels are preset to 184.*

### **Category change**

Press the category button (Λ or V) and select the desired category.

- Press the category button (Λ):  
Category up
- Press the category button (V):  
Category down

Every time the category button (Λ) is pressed, the category is changed over in the order shown below.

At this time, the lowest (smallest-number) channel within the category indicated is received.

When the highest (or lowest) category is reached, the category is changed over in the order shown below.

Highest category → All categories →  
Lowest category

#### **NOTE**

*While all categories are selected, all channels covering a category can be accessed (Category off condition).*

### **Channel selection within a category**

If you are in a selected category and the channel number is displayed, turning the manual tuning dial moves the channel number up/down in that category.

- Turn the manual tuning dial clockwise:  
Channel Up
- Turn the manual tuning dial counterclockwise: Channel Down

#### **NOTE**

*The channel number needs to be indicated in the display to use manual tuning dial for this function.*

Interior Comfort  
**Audio System**

**Scan tuning**

Press the scan button (**SCAN**) to automatically sample stations. Scanning stops at each station for about five seconds. To hold a station, press the scan button (**SCAN**) again during this interval.

**NOTE**

- *Unsubscribed channels, invalid channels, parental lock channels and channel 0 are not subject to the scan, therefore these channels will be skipped automatically.*
- *You can scan all channels while all categories are selected. If you are in a selected category, you can only scan the channels in that category.*

**Channel number, channel name, category, artist, song titles and info display**

Each time the display button (**DISP**) is pressed during SIRIUS reception, the display of the text data is changed over in the order shown below.

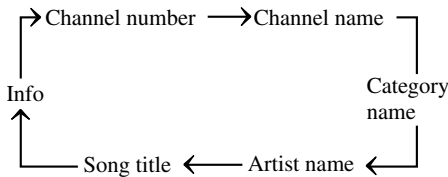

**NOTE**

- *Eight characters are displayed on one screen.*
- *To display the rest of the characters of a long title, press the text button (**TEXT**). The display scrolls the next eight characters. Press the text button (**TEXT**) again after the last eight characters have been displayed to return to the beginning of the title.*

**(Channel number display)**

- When the display button (**DISP**) is pressed while in info display mode, the mode changes to the channel number display mode.

**(Channel name display)**

- When the display button (**DISP**) is pressed while in channel number display mode, it changes to channel name display mode.
- There are short (eight fixed characters) and long names for the channel name.
- The long name is displayed first, and three seconds later the short name is displayed. If there is no short name, the long name is displayed.
- To display the rest of the characters of the channel name, press the text button (**TEXT**). The display scrolls the next eight characters. Press the text button (**TEXT**) again after the last eight characters have been displayed to return to the beginning of the title.
- Press the text button (**TEXT**) while the short name is displayed to switch the display to the long name.
- Three seconds after scrolling the long name, the display automatically returns to the first part of the long name. Three more seconds and the short name appears.

Interior Comfort

## Audio System

- If there is no channel name, “NO TITLE” is displayed.

### (Category name display)

- When the display button (**DISP**) is pressed while in channel name display mode, it changes to the category name display mode.
- There are short (eight fixed characters) and long names for the category name.
- The long name is displayed first, and three seconds later the short name is displayed. If there is no short name, the long name is displayed.
- To display the rest of the characters of the category name, press the text button (**TEXT**). The display scrolls the next eight characters. Press the text button (**TEXT**) again after the last eight characters have been displayed to return to the beginning of the title.
- Press the text button (**TEXT**) while the short name is displayed to switch the display to the long name.
- Three seconds after scrolling the long name, the display automatically returns to display the first part of the long name. Three more seconds and the short name appears.
- If there is no category name, “NO CATEGORY” is displayed.

### (Artist name display)

- When the display button (**DISP**) is pressed while in category name display mode, it changes to the artist name display mode.
- To display the rest of the characters of the artist's name, press the text button (**TEXT**). The display scrolls the next eight characters. Press the text button (**TEXT**) again after the last eight characters have been displayed to return to the beginning of the title.

- Three seconds after scrolling the artist name, the display automatically return to display the first part of the artist's name.
- If there is no artist's name, “NO ARTIST” is displayed.

### (Song title display)

- When the display button (**DISP**) is pressed while in artist name display mode, it changes to the song title display mode.
- To display the rest of the characters of the song title, press the text button (**TEXT**). The display scrolls the next eight characters. Press the text button (**TEXT**) again after the last eight characters have been displayed to return to the beginning of the title.
- Three more seconds after scrolling the song title, the display automatically returns to display the first part of the song title.
- If there is no song title, “NO SONG” is displayed.

### (INFO (such as composer's name) display)

- When the display button (**DISP**) is pressed while in song title display mode, it changes to the INFO display mode.
- To display the rest of the characters of the composer's name, press the text button (**TEXT**). The display scrolls the next eight characters. Press the text button (**TEXT**) again after the last eight characters have been displayed to return to the beginning of the title.
- Three seconds after scrolling the text, the display automatically returns to display the first part of the text.
- If there is no composer name, “NO INFO” is displayed.



Interior Comfort  
**Audio System**

### Instant replay

This function allows you to rewind and replay the program that you were previously or are currently listening to. Press the instant replay button (▶||). When the seek tuning button (▼) is pressed (about 1.5 seconds), playback starts from the beginning of the current program.

When the seek tuning button (▼) is pressed twice, playback starts from the beginning of the previous program.

When the seek tuning button (▼) is pressed for about 1.5 seconds or longer, the program is reversed while the button is being pressed.

When the seek tuning button (▲) is pressed (about 1.5 seconds), playback starts from the beginning of the next program. When the seek tuning button (▲) is pressed (about 1.5 seconds) while the last program is being played, the instant replay mode is cancelled.

When the seek tuning button (▲) is pressed for 1.5 seconds or longer, the program is fast-forwarded while the button is being pressed. When pressing and holding the button until the end of the program, the instant replay mode is cancelled.

When the instant replay button (▶||) is pressed again, playback is paused, or playback starts if it has been paused.

#### Instant replay (PAUSE)

If the instant replay button (▶||) is pressed while the instant replay mode is off, instant replay mode is turned on in a paused condition (PAUSE). Press the instant replay button (▶||) again to resume playback from the point at which it was paused.

### NOTE

- If the channel is changed, the instant replay buffer data is deleted.
- After turning on the power and switching to SIRIUS digital satellite radio mode, the instant replay mode is not available for several seconds after changing channels.

### Initialization of ID code

If the registered ID code is forgotten, return the ID code to the default [0000] by performing the following steps:  
Setting condition: SAT mode

### NOTE

The scan button refers to the operation for an In-dash CD changer-equipped vehicle, and the auto memory button refers to the operation for a CD player-equipped vehicle.

### (Master code input preparation)

1. Press and hold the auto memory button or scan button (SCAN), then press channel preset button 4. Hold both buttons together for 1.5 seconds.
2. "ENTER PIN" appears for three seconds which indicates that it is in code input mode.
3. "SR1 - - -" appears, which indicates that it is ready for code input.

### (Master code input)

4. Input the master code using the channel preset buttons 1-4.  
(The master code is already set at the time of factory shipment.)

### (Master code input determination)

5. Determine the master code which has been input by pressing the auto memory button or scan button (SCAN).

Interior Comfort

## Audio System

6. "PIN CLEARED" appears which indicates that the master code input has been completed.
7. The ID code is set to the default [0000] and the initialization process is completed.

### NOTE

#### Master code:

The Master Code is used to initialize or re-initialize the ID code in the event that the code is not set to [0000] and/or the personalized ID code is not known. The initialization process resets the ID code to [0000]. The master code can potentially defeat the intent of the security of the parental lock if it is located by persons not authorized by the owner to access certain channels.

SIRIUS Satellite Radio Master Code: [0913]

### NOTE

- When a numeric value other than the master code is input and the auto memory button or scan button (**SCAN**) is pressed, "SR1 Err" is displayed and then it returns to the "SR1 - - -" display again.
- If an ID code is not input for ten seconds, "Err" is displayed and it returns to the former display.
- Channel preset buttons 1, 2, 3, 4 and the auto memory button or scan button (**SCAN**) are used for inputting the ID code. Buttons 5 and 6 cannot be used.

### Change of ID code

Setting condition: SAT mode

When changing the ID code, the new ID code is input after the previous one is input first.

### NOTE

The scan button refers to the operation for an In-dash CD changer-equipped vehicle, and the auto memory button refers to the operation for a CD player-equipped vehicle.

### (Registered ID code input)

1. Press and hold the auto memory button or scan button (**SCAN**), then press channel preset button 5. Hold both buttons together for 1.5 seconds.
2. "ENTER PIN" appears for three seconds which indicates that it is in code input mode.
3. "SR1 - - -" appears, which indicates that it is ready for code input.
4. Input the registered ID code using channel preset buttons 1-4.  
Example: When the registered ID code is "2323", input "2323". At this time "SR1 2323" is displayed.  
Press 1 for the first digit, 2 for the second, 3 for the third, and 4 for the last digit. For example, if your number is 2323, press 1 three times (includes 0), 2 four times, 3 three times, and 4 four times. If the display goes off while inputting, begin from Step 1.

### NOTE

The registered ID code is the default [0000] at the time of factory shipment. If [0000] results in "Err" on the display, go to the "INITIALIZATION OF ID CODE" section to reset to [0000].

### (Verification with the registered ID code)

5. Determine the input code by pressing the auto memory button or scan button (**SCAN**).

Interior Comfort  
**Audio System**

6. If it does not match with the previously registered code, “SR1 Err” is displayed and then it returns to “SR1 - - -”.
7. If it matches with the previously registered code, “ENTER PIN” appears again and it switches to code input mode.
8. “SR1 - - -” appears, and it is ready for input of the new ID code.

**(New ID code input)**

9. Input the new ID code using channel preset buttons 1-4.  
Example: If “1234” is input as the new code, “SR1 1234” is displayed.

**(New ID code input determination)**

10. Determine the new ID code which has been input by pressing the auto memory button or scan button (**SCAN**).
11. “PIN CHANGED” appears for three seconds which indicates that the new ID code input has been completed.
12. It returns to the former display.

**NOTE**

- If an ID code is not input for ten seconds, “Err” is displayed and it returns to the former display.
- Channel preset buttons 1, 2, 3, 4 and the auto memory button or scan button (**SCAN**) are used for input of the ID code. Buttons 5 and 6 cannot be used.

**Individual channel locking**

If a channel is locked, the channel is muted.

**NOTE**

- If the registered ID code is forgotten, return the ID code to the default [0000]. (See “INITIALIZATION OF ID CODE” section)
- The scan button refers to the operation for an In-dash CD changer-equipped vehicle, and the auto memory button refers to the operation for a CD player-equipped vehicle.

**(Locking a channel)**

1. Select a channel to be locked by turning the manual tuning dial.  
Example: Select channel 100

**(Registered ID code input preparation)**

2. Press and hold the auto memory button or scan button (**SCAN**), then press channel preset button 6. Hold both buttons together for 1.5 seconds.
3. “ENTER PIN” appears for three seconds which indicates that it is in code input mode.
4. “SR1 - - -” appears which indicates that it is ready for code input.

**(Registered ID code input)**

5. Input the registered ID code using channel preset buttons 1-4. Example: If the registered ID code is “2323”, input “2323”. At this time “SR1 2323” is displayed.

**(Registered ID code input determination)**

6. Determine the code which has been input by pressing the auto memory button or scan button (**SCAN**).
7. If it does not match the registered code, “SR1 Err” is displayed and then it returns to “SR1 - - -”.

Interior Comfort

## Audio System

8. If it matches the registered code, “SR1 LOCK” appears for three seconds which indicates that the code input has been completed.
9. “SR1 LOCK 100” appears which indicates that the parental lock is activated. At this time, mute is on and no sound is heard.

### NOTE

- If an ID code is not input for ten seconds, “Err” is displayed and it returns to the former display.
- Channel preset buttons 1, 2, 3, 4 and the auto memory button or scan button (SCAN) are used for input of the ID code. Buttons 5 and 6 cannot be used.

### Lock cancellation

Setting condition: SAT mode

### NOTE

The scan button refers to the operation for an In-dash CD changer-equipped vehicle, and the auto memory button refers to the operation for a CD player-equipped vehicle.

### (Releasing a locked channel)

1. Select a channel to be released by turning the manual tuning dial.  
Example: Select the locked channel (i.e. 100). At this time, “SR1 LOCK 100” is displayed.

### (Registered ID code input preparation)

2. Press and hold the auto memory button or scan button (SCAN), then press channel preset button 6. Hold both buttons together for 1.5 seconds.
3. “ENTER PIN” appears for three seconds which indicates that it is in code input mode.

4. “SR1 - - - -” appears, which indicates that it is ready for code input.

### (Registered ID code input)

5. Input the registered ID code using channel preset buttons 1-4. Example:  
When the registered ID code is “2323”, input “2323”. At this time “SR1 2323” is displayed.

### NOTE

If “Err” is displayed, go to the “INITIALIZATION OF ID CODE” section to reset the ID code to [0000].

### (Registered ID code input determination)

6. Determine the input code by pressing the auto memory button or scan button (SCAN).
7. If it does not match the registered code, “SR1 Err” is displayed and then it returns to “SR1 - - - -”.
8. If it matches the registered code, “SR1 UNLOCK” appears for three seconds which indicates that the code input has been completed.
9. “SR1 100” appears which indicates that the parental lock is off. At this time, sound is heard.

### NOTE

- If an ID code is not input for ten seconds, “Err” is displayed and it returns to the former display.
- Channel preset buttons 1, 2, 3, 4 and the auto memory button or scan button (SCAN) are used for input of the ID code. Buttons 5 and 6 cannot be used.

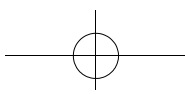

# MEMO

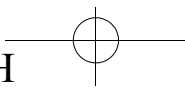
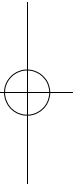
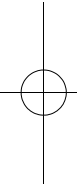

Interior Comfort  
**Audio System**

▼ **Operating the Compact Disc (CD) Player**

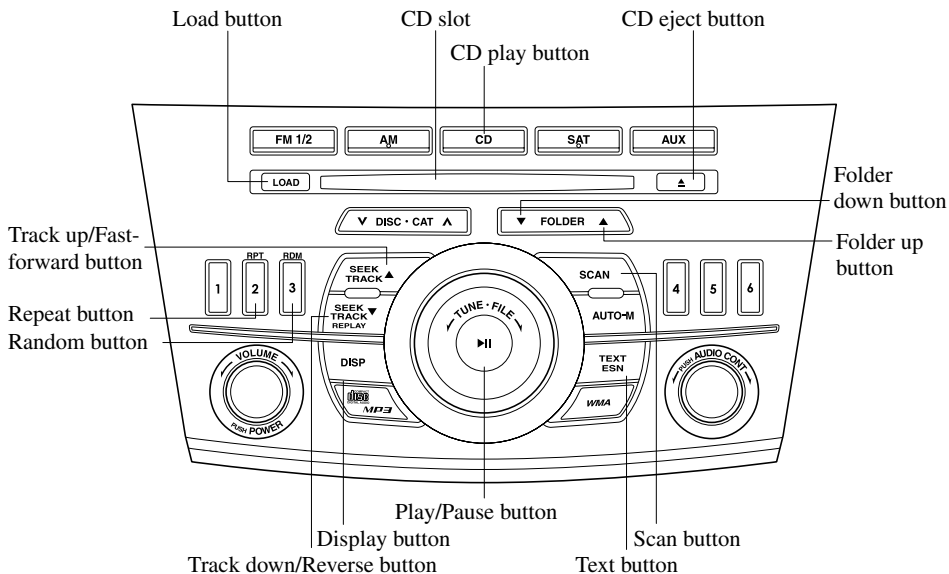

| Type                    | Playable data  |
|-------------------------|--|
| Music/MP3/WMA CD player | <ul style="list-style-type: none"> <li>• Music data (CD-DA)</li> <li>• MP3/WMA file</li> </ul> |

**NOTE**

If a disc has both music data (CD-DA) and MP3/WMA files, playback of the two or three file types differs depending on how the disc was recorded.

**Inserting the CD**

Insert the CD into the slot, label-side up. The auto-loading mechanism will set the CD and begin play.

**NOTE**

There will be a short lapse before play begins while the player reads the digital signals on the CD.

**Ejecting the CD**

Press the CD eject button (▲) to eject the CD.

**Playback**

Press the CD play button (CD) to start play when a CD is in the unit. If a CD is not in the unit when the CD play button (CD) is pressed, "NO DISC" will flash on and off.

**NOTE**

When the load button (LOAD) is pressed, the CD will load and play even if the CD eject button (▲) had been previously pressed.

**Pause**

To stop playback, press the Play/Pause button (▶||). Press the button again to resume playback.

Interior Comfort  
**Audio System**

**Fast-forward/Reverse**

Press and hold the fast-forward button (▲) to advance through a track at high speed.

Press and hold the reverse button (▼) to reverse through a track at high speed.

**Track search**

Press the track up button (▲) or turn the file dial clockwise once to skip forward to the beginning of the next track.

Press the track down button (▼) or turn the file dial counterclockwise once to skip back to the beginning of the current track.

**Folder search (during MP3/WMA CD playback)**

To change to the previous folder, press the folder down button (▼), or press the folder up button (▲) to advance to the next folder.

**Music scan**

**During music CD playback**

This function scans the titles on a CD and plays 10 seconds of each song to aid you in finding a song you want to listen to.

**During MP3/WMA CD playback**

This function scans the titles in a folder currently being played and plays 10 seconds of each song to aid you in finding a song you want to listen to.

Press the scan button (**SCAN**) during playback to start the scan play operation (the track number will flash).

Press the scan button (**SCAN**) again to cancel scan playback.

**NOTE**

*If the unit is left in scan, normal playback will resume where scan was selected.*

**Repeat playback**

**During music CD playback**

1. Press the repeat button (**RPT**) during playback to play the current track repeatedly. "RPT" is displayed.
2. Press the button again to cancel the repeat playback.

**During MP3/WMA CD playback**

**(Track repeat)**

1. Press the repeat button (**RPT**) during playback to play the current track repeatedly. "TRACK RPT" is displayed.
2. To cancel the repeat playback, press the button again after 3 seconds.

**(Folder repeat)**

1. Press the repeat button (**RPT**) during playback, and then press the button again within 3 seconds to play the tracks in the current folder repeatedly. "FOLDER RPT" is displayed.
2. Press the button again to cancel the repeat playback.

**Random playback**

Tracks are randomly selected and played.

**During music CD playback**

1. Press the random button (**RDM**) during playback to play the tracks on the CD randomly. "RDM" is displayed.
2. Press the button again to cancel the random playback.

Interior Comfort  
**Audio System**

**During MP3/WMA CD playback**

**(Folder random)**

1. Press the random button (**RDM**) during playback to play the tracks in the folder randomly. "FOLDER RDM" is displayed.
2. To cancel the random playback, press the button again after 3 seconds.

**(CD random)**

1. Press the random button (**RDM**) during playback, and then press the button again within 3 seconds to play the tracks on the CD randomly. "DISC RDM" is displayed.
2. Press the button again to cancel the random playback.

**Switching the display**

For files with a file name and other information that have been input, the display switches between display of the file name and other information each time the display button (**DISP**) is pressed during playback.

**Music CD**

Track number/Elapsed time

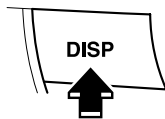

Track number

Track name

Album name

Artist name

**MP3/WMA CD**

File number/Elapsed time

Folder number/File number

File name

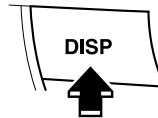

Folder name

Album name (ID3 Tag)

Song name (ID3 Tag)

Artist name (ID3 Tag)

***NOTE***

- The information viewable in the display is only CD information (such as artist name, song title) which has been recorded to the CD.
- The system can only display one-byte alphabetic characters. If two-byte or other types of characters have been recorded to the CD, they may not display correctly.

**Display scroll**

Only 8 characters (File name) or 12 characters (Except file name) can be displayed at one time. To display the rest of the characters of a long title, press the text button (**TEXT**). The display scrolls the next 12 characters. Press the text button (**TEXT**) again after the last 12 characters have been displayed to return to the beginning of the title.



Interior Comfort  
**Audio System**

---

**NOTE**

*The displayable number of characters is limited. If the number of characters, including the file extension (.mp3/.wma), exceeds 32 characters, it may not be fully displayed.*

**Message display**

If “CHECK CD” is displayed, it means that there is some CD malfunction. Check the CD for damage, dirt, or smudges, and then properly reinsert. If the message appears again, take the unit to an Authorized Mazda Dealer for service.

Interior Comfort  
**Audio System**

▼ **Operating the In-Dash CD Changer**

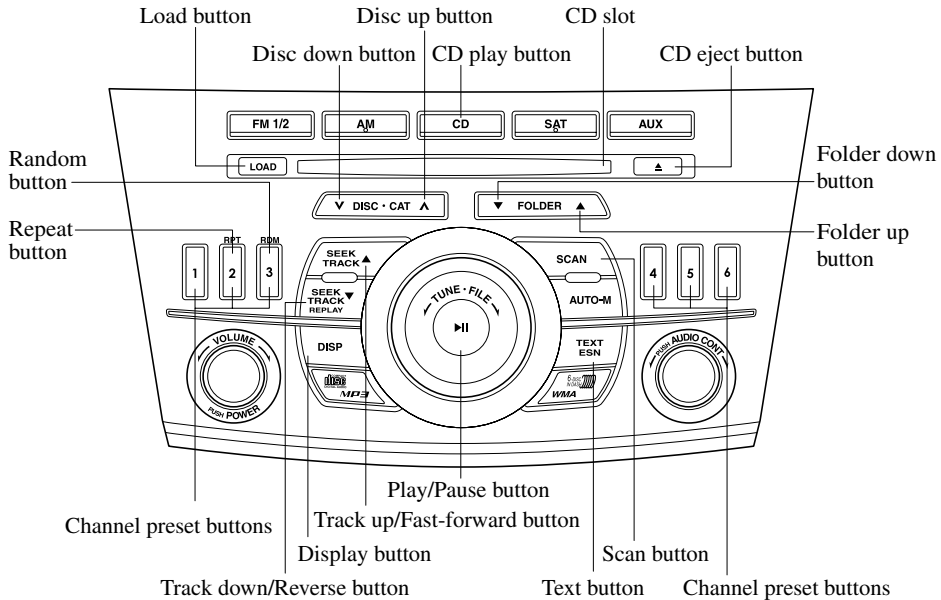

| Type                    | Playable data  |
|-------------------------|--|
| Music/MP3/WMA CD player | <ul style="list-style-type: none"> <li>• Music data (CD-DA)</li> <li>• MP3/WMA file</li> </ul> |

**NOTE**

If a disc has both music data (CD-DA) and MP3/WMA files, playback of the two or three file types differs depending on how the disc was recorded.

**Inserting the CD**

The CD must be label-side up when inserting. The auto-loading mechanism will set the CD and begin play.

**NOTE**

The CD will begin playback automatically after insertion. A CD cannot be inserted while the display reads "WAIT". A beeping sound can be heard during this waiting time. There will be a short lapse before play begins while the player reads the digital signals on the CD.

**Normal insertion**

1. Press the load button (LOAD).
2. When "IN" is displayed, insert the CD.

**Inserting CDs into desired tray number**

1. Press and hold the load button (LOAD) for about 2 seconds until a beep sound is heard.

Interior Comfort  
**Audio System**

2. Press the channel preset button for the desired tray number while “WAIT” is displayed.
3. When “IN” is displayed, insert the CD.

**NOTE**

*The CD cannot be inserted to the desired tray number if the number is already occupied.*

**Multiple insertion**

1. Press and hold the load button (LOAD ) for about 2 seconds until a beep sound is heard.
2. When “IN” is displayed, insert the CD.
3. When “IN” is displayed again, insert the next CD.

**NOTE**

*The first-inserted CD will be played automatically when:*

- No other CD is inserted within 15 seconds after “IN” is displayed.
- The CD trays are full.

**Displaying the CD-inserted tray number**

When you want to know the number for a CD-inserted tray, press the display button (DISP ). The tray number will be displayed for 5 seconds.

**Ejecting the CD**

**Normal ejection**

1. Press the CD eject button (▲ ). The disc number and “DISC OUT” will be displayed.
2. Pull out the CD.

**NOTE**

*When the CD is ejected during play, the next CD will be played automatically.*

**Ejecting CDs from desired tray number**

1. Press and hold the CD eject button (▲ ) for about 2 seconds until a beep sound is heard.  
The “DISC OUT” display flashes.
2. Press the channel preset button for the desired CD number for less than 5 seconds after the beep sound is heard.
3. Pull out the CD.

**Multiple ejection**

1. Press and hold the CD eject button (▲ ) for about 2 seconds until a beep sound is heard.  
The “DISC OUT” display flashes.
2. Press the CD eject button (▲ ) again for less than 5 seconds after the beep sound is heard.

**NOTE**

*If the button is not pressed and about 5 seconds have elapsed while “DISC OUT” is flashing, CDs are automatically ejected.*

3. Pull out the CD, then the next CD will be ejected.

**NOTE**

- CDs will be ejected starting with the one with the lowest number.
- All CDs in the tray will be ejected continuously.
- CDs can be ejected when the ignition is switched off. Press and hold the CD eject button (▲ ) for about 2 seconds and all CDs will eject.

**Playback**

Press the CD play button (CD ) to start play when a CD is in the unit.

If a CD is not in the unit when the CD play button (CD ) is pressed, “NO DISC” will flash on and off.

Interior Comfort

## Audio System

### **Pause**

To stop playback, press the Play/Pause button (▶||).  
Press the button again to resume playback.

### **Fast-forward/Reverse**

Press and hold the fast-forward button (▲) to advance through a track at high speed.  
Press and hold the reverse button (▼) to reverse through a track at high speed.

### **Track search**

Press the track up button (▲) or turn the file dial clockwise once to skip forward to the beginning of the next track.  
Press the track down button (▼) or turn the file dial counterclockwise once to skip back to the beginning of the current track.

### **Disc search**

To change the disc, press the DISC button (Λ or V) during playback.

### **Folder search (during MP3/WMA CD playback)**

To change to the previous folder, press the folder down button (▼), or press the folder up button (▲) to advance to the next folder.

### **Music scan**

#### **During music CD playback**

This function scans the titles on a CD and plays 10 seconds of each song to aid you in finding a song you want to listen to.

#### **During MP3/WMA CD playback**

This function scans the titles in a folder currently being played and plays 10 seconds of each song to aid you in finding a song you want to listen to.

Press the scan button (SCAN) during playback to start the scan play operation (the track number will flash).  
Press the scan button (SCAN) again to cancel scan playback.

### ***NOTE***

*If the unit is left in scan, normal playback will resume where scan was selected.*

### **Repeat playback**

#### **During music CD playback**

1. Press the repeat button (RPT) during playback to play the current track repeatedly. "RPT" is displayed.
2. Press the button again to cancel the repeat playback.

#### **During MP3/WMA CD playback**

##### **(Track repeat)**

1. Press the repeat button (RPT) during playback to play the current track repeatedly. "TRACK RPT" is displayed.
2. To cancel the repeat playback, press the button again after 3 seconds.

##### **(Folder repeat)**

1. Press the repeat button (RPT) during playback, and then press the button again within 3 seconds to play the tracks in the current folder repeatedly. "FOLDER RPT" is displayed.
2. Press the button again to cancel the repeat playback.

### **Random playback**

Tracks are randomly selected and played.

Interior Comfort  
**Audio System**

**During music CD playback**

1. Press the random button (**RDM**) during playback to play the tracks in the CD randomly. "RDM" is displayed.
2. Press the button again to cancel the random playback.

**During MP3/WMA CD playback**

**(Folder random)**

1. Press the random button (**RDM**) during playback to play the tracks in the folder randomly. "FOLDER RDM" is displayed.
2. To cancel the random playback, press the button again after 3 seconds.

**(CD random)**

1. Press the random button (**RDM**) during playback, and then press the button again within 3 seconds to play the tracks on the CD randomly. "DISC RDM" is displayed.
2. Press the button again to cancel the random playback.

**Switching the display**

For files with a file name and other information that have been input, the display switches between display of the file name and other information each time the display button (**DISP**) is pressed during playback.

**Music CD**

Disc number/Track number/Elapsed time

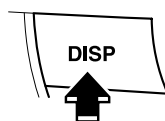

Disc number/Track number

Disc tray number

Track name

Album name

Artist name

**MP3/WMA CD**

Disc number/File number/Elapsed time

Disc number/Folder number/File number

Disc tray number

File name

Folder name

Album name (ID3 Tag)

Song name (ID3 Tag)

Artist name (ID3 Tag)

Interior Comfort

## Audio System

### NOTE

- The information viewable in the display is only CD information (such as artist name, song title) which has been recorded to the CD.
- The system can only display one-byte alphabetic characters. If two-byte or other types of characters have been recorded to the CD, they may not display correctly.

### Display scroll

Only 12 characters (Except file name) can be displayed at one time. To display the rest of the characters of a long title, press the text button (**TEXT**). The display scrolls the next 12 characters. Press the text button (**TEXT**) again after the last 12 characters have been displayed to return to the beginning of the title.

### NOTE

The displayable number of characters is limited. If the number of characters, including the file extension (.mp3/.wma), exceeds 32 characters, it may not be fully displayed.

### Message display

If "CHECK CD" is displayed, it means that there is some CD malfunction. Check the CD for damage, dirt, or smudges, and then properly reinsert. If the message appears again, take the unit to an Authorized Mazda Dealer for service.

### ▼ Operating the Auxiliary jack/ USB port

#### Without USB port

Audio can be heard from the vehicle's speakers by connecting a commercially-available portable audio unit to the auxiliary jack.

Use a commercially-available, non-impedance (3.5 $\phi$ ) stereo mini plug cable. Contact an Authorized Mazda Dealer for details.

Refer to AUX/USB/iPod Mode on page 6-86.

#### With USB port

Audio can be heard from the vehicle's speakers by connecting a commercially-available portable audio unit to the auxiliary jack.

Use a commercially-available, non-impedance (3.5 $\phi$ ) stereo mini plug cable. Contact an Authorized Mazda Dealer for details.

In addition, audio can be played from the vehicle's audio unit by connecting USB device or an iPod to the USB port. Refer to AUX/USB/iPod Mode on page 6-86.

Interior Comfort  
**Audio System**

**▼ Error Indications**

If you see an error indication on the display, find the cause in the chart. If you cannot clear the error indication, take the vehicle to an Authorized Mazda Dealer.

| Indication   | Cause   | Solution  |
|--------------|---|---|
| ACQUIRING    | Depending on the surrounding conditions (such as large trees, buildings, or tunnels) and special weather conditions, SIRIUS radio reception may be diminished or temporarily interrupted. | Improve reception by moving away from possible obstructions. If the error indication continues to display, consult an Authorized Mazda Dealer.                |
| ANTENNA FAIL | Satellite radio antenna malfunction   | Check the satellite radio antenna, antenna cable and DLP antenna connector. If the error indication continues to display, consult an Authorized Mazda Dealer. |
| CHECK CD     | CD is inserted upside down  | Insert the CD properly. If the error indication continues to display, consult an Authorized Mazda Dealer.   |
|              | CD is defective   | Insert another CD properly. If the error indication continues to display, consult an Authorized Mazda Dealer.   |

**NOTE**

*If a broken DLP\* unit is replaced with a new unit, cancel the license for the broken unit and make sure to carry out new registration for the replaced unit. If the license for the broken unit is not canceled, you will be charged a reception fee for both units.*

\* DLP: Down Link Processor (SATELLITE RADIO Module)

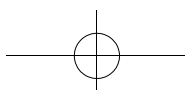

# MEMO

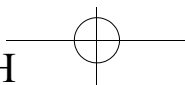
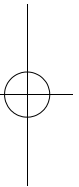
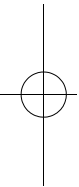



Interior Comfort  
**Audio System**

**Audio Set (Type B)**

**CAUTION**

*Do not press the panel strongly or press it with a sharp-pointed object. Otherwise, the panel could be damaged.*

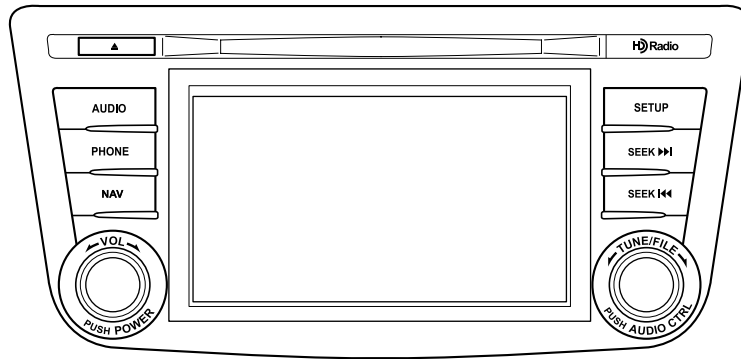

|  |           |
|--|-----------|
| ① Power/Volume/Display/Sound Controls .....    | page 6-62 |
| ② Operating the Radio .....                    | page 6-66 |
| ③ Operating the Satellite Radio .....          | page 6-70 |
| ④ Operating the Compact Disc (CD) Player ..... | page 6-78 |
| ⑤ How to use the Auxiliary jack/USB port ..... | page 6-81 |
| ⑥ Error Indication .....                       | page 6-81 |
| ⑦ Setup .....                                  | page 6-81 |

## Interior Comfort Audio System

### ▼ Power/Volume/Display/Sound Controls

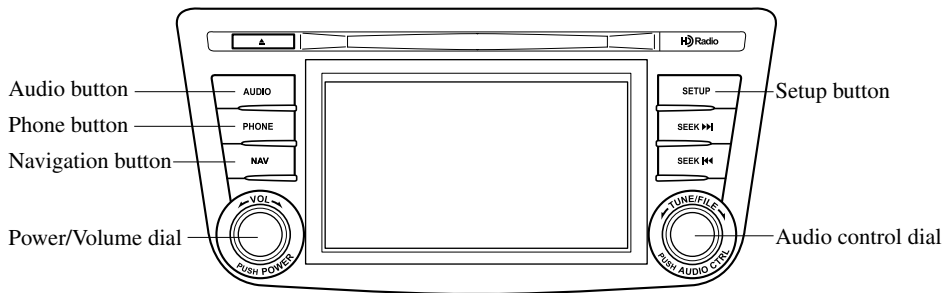

#### **Power ON/OFF**

Switch the ignition to ACC or ON.  
Press the power/volume dial to turn the audio system on. Press the power/volume dial again to turn the audio system off.

#### **Volume adjustment**

To adjust the volume, turn the power/volume dial.  
Turn the power/volume dial to the right to increase volume, to the left to decrease it.

#### **Display setting**

Press the setup button (**SETUP**) to display the display setting screen.  
Touch the **Display** on-screen tab to select the item you would like to change.

#### **Brightness adjustment**

**+** : Increase brightness  
**-** : Decrease brightness

#### **Contrast adjustment**

**+** : Higher contrast  
**-** : Lower contrast

#### **Daytime/nighttime screen setting**

The daytime or nighttime screen can be selected even if the headlights are illuminated or turned off (when bright screen is required at night or dark screen is required at noon).

**Day** : Daytime screen setting  
**Night** : Nighttime screen setting  
**Auto** : Switches screen automatically according to headlight illumination condition

Interior Comfort  
**Audio System**

**Display OFF**

The display can be turned off. Touch the  on-screen button to turn the display off.

The display can be turned back on as follows:

- Press the audio button (**AUDIO**) to display the audio screen.
- Press the navigation button (**NAV**) to display the navigation screen.
- Press the phone button (**PHONE**) to display the Bluetooth<sup>®</sup> dial screen.
- Press the setup button (**SETUP**) to display the setup dial setting screen.
- Press the audio control dial to display the setup sound setting screen.



**NOTE**

*The screen can also be turned off using voice recognition.*

*Refer to Component Parts on page 6-140.*













**Display setting reset**

All of the screen setting values can be reset to their initial settings.

1. Touch the  on-screen button.
2. Touch the  on-screen button.

**Audio sound adjustment**

Press the audio control dial or touch the  on-screen button to display the sound setting screen.

| Indication   | Setting value   |
|--|---|
| Bass<br>(Low pitch sound)                              |  : Low pitch enhancement<br> : Low pitch reduction                      |
| Treble<br>(Treble sound)                               |  : Treble enhancement<br> : Treble reduction                            |
| Balance<br>(Left/right volume balance)                 |  : Right side volume reduction<br> : Left side volume reduction       |
| Fader<br>(Front/back volume balance)                   |  : Front speaker volume reduction<br> : Rear speaker volume reduction |
| Button Beep<br>(Audio operation sound)                 |  : on/off*1   |
| Auto Level Control*2<br>(Automatic volume adjustment)  |  : Level up<br> : Level down  |
| AudioPilot*3<br>(Automatic volume adjustment)          |  : on/off   |
| Centerpoint*3<br>(Automatic surround level adjustment) |  : on/off   |

\*1 Some functions do not turn off

\*2 Standard audio

\*3 Bose<sup>®</sup> Sound System

**Automatic Level Control (ALC)**

The automatic level control is a feature that automatically adjusts audio volume and sound quality according to the vehicle speed. The volume increases in accordance with the increase in vehicle speed, and decreases as vehicle speed decreases.

Interior Comfort

## Audio System

---

### AudioPilot® 2\*4

AudioPilot® 2 automatically adjusts audio volume and sound quality in accordance with the level of noise entering the vehicle interior while driving. When AudioPilot® 2 is turned on, the system automatically calculates the conditions for optimum hearing of sound which may be difficult to hear depending on exterior noise.

AudioPilot® 2 can be set on or off.

\*4 AudioPilot® 2 is a registered trademark of Bose Corporation.

### Centerpoint®\*5

Centerpoint® offers you the experience of 5.1-channel surround sound in your vehicle even with your conventional 2-channel stereo CDs. Centerpoint® can be set on or off.

\*5 Centerpoint® is a registered trademark of Bose Corporation.

### NOTE

- *Centerpoint® operates optimally with a 2-channel stereo CD. Audio files encoded with high compression can be played, however, they may result in poor sound quality.*
- *Centerpoint® is available for 2-channel stereo audio except for AM radio/FM radio/AUX/USB/iPod/Bluetooth® audio.*

### Sound setting reset

The settings for bass, treble, balance, and fade can be returned to their initial settings.

1. Touch the  on-screen button.
2. Touch the  on-screen button.

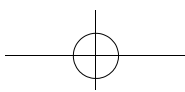

# MEMO

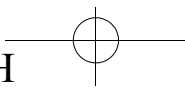
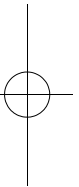
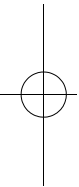

## Interior Comfort Audio System

### ▼ Operating the Radio

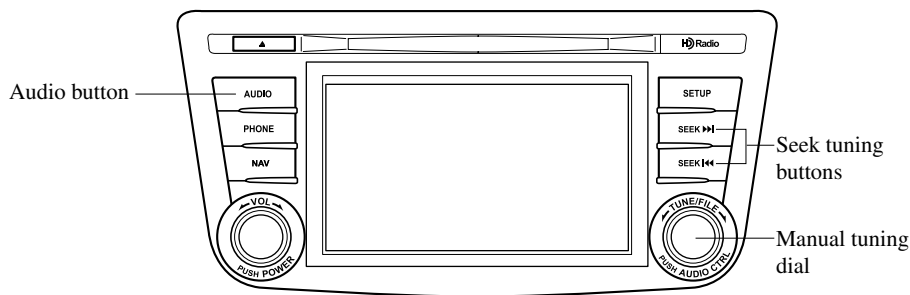

#### **Radio ON**

##### **(Connected Satellite Radio)**

Press the audio button (**AUDIO**) and touch the **FM1 /AM** on-screen tab.

##### **(Unconnected Satellite Radio)**

Press the audio button (**AUDIO**) and touch the **FM** or **AM** on-screen tab.

#### **Band selection**

##### **(Connected Satellite Radio)**

Touch the **FM1 /AM** on-screen tab to switch the band as follows:

FM1→FM2→AM

#### **NOTE**

- **FM1/FM2** is displayed when FM1 is selected, **FM2 /AM** is displayed when FM2 is selected, and **FM/AM** is displayed when AM is selected.
- If the FM broadcast signal becomes weak, reception automatically changes from **STEREO** to **MONO** for reduced noise, and the "STEREO" indicator will no longer display.

#### **(Unconnected Satellite Radio)**

Touch the **AM** on-screen tab to select AM. Touch the **FM** on-screen tab to select FM1 and FM2.

#### **NOTE**

- When FM1 is selected, **FM1/FM2** is displayed. When FM2 is selected, **FM1/FM2** is displayed.
- If the FM broadcast signal becomes weak, reception automatically changes from **STEREO** to **MONO** for reduced noise, and the "STEREO" indicator will no longer display.

#### **Tuning**

The radio has the following tuning methods: Manual, Seek, Scan, Preset channel, and Auto memory tuning. The easiest way to tune stations is to set them on preset channels.

#### **NOTE**

If the power supply is interrupted (fuse blows or the battery is disconnected), the preset channels will be erased.

## Interior Comfort Audio System

### Manual tuning

Turning the manual tuning dial will change the frequency higher or lower.

#### NOTE

When an HD Radio broadcast is being received, a receivable multicast channel is also received.

### Seek tuning

Pressing the seek tuning button (▶▶,◀◀) will cause the tuner to seek a higher or lower frequency automatically.

#### NOTE

- If you continue to press and hold the seek tuning button (▶▶,◀◀) the frequency will continue changing without stopping.
- When an HD Radio broadcast is being received, a receivable multicast channel is also received.

### Scan tuning

You can search for receivable radio stations by touching the **Scan** on-screen button.

Scanning stops at each station for about five seconds.

Touch the **Scan** on-screen button one time during reception to continue receiving a broadcasting station.

### Preset channel tuning

The six preset channels can be used to store six AM and twelve FM stations.

1. To set a channel, first select AM, FM1, or FM2. Tune to the desired station.
2. Press and hold any of the preset on-screen buttons. The reception frequency is programmed and displayed on the preset button.

3. Repeat this operation for the other stations and bands you want to store. When receiving a programmed frequency, select AM, FM1, or FM2 and touch the preset on-screen button.

#### NOTE

The programmed frequency is displayed on the preset button.

### Auto memory tuning

This is especially useful when driving in an area where the local stations are unknown. Additional AM/FM stations can be stored without disturbing the previously set channels.

1. Touch the **Auto Memory** on-screen button. The auto memory preset list is displayed and the previously tuned frequency is received.
2. Touch the **Update List** on-screen button to display the frequencies of up to ten radio stations on the auto memory preset list.
3. Touch the desired frequency.

#### NOTE

Touch the **Back** on-screen button during auto memory tuning to return to the AM/FM main screen.

### Radio Broadcast Data System (RBDS)

#### Radio text information display

A maximum of 64 characters of radio text information sent from a broadcasting station is displayed in the audio display.

Interior Comfort

## Audio System

### NOTE



Radio text information is a function of FM radio. Text information is not displayed in the following:

- During HD Radio reception
- Not an RBDS broadcast
- During HD reception
- RBDS broadcast, but radio text is not transmitted from the radio station

### Genre Seek

Some FM stations transmit Genre codes (Program type like a Rock, News, and so on). This code enables alternative stations transmitting the same Genre code to be found quickly. To select from the genre list, touch the  on-screen button while in the FM mode and the desired Genre Seek.

#### (To scan for Genre Seek:)

1. Touch the genre type which you want to select.
2. Touch the  ,  on-screen button.

Ex.)

89.3 is currently being received. With Rock selected as the Genre, the radio stations broadcasting Rock are at the following frequencies.

98.3\*<sup>1</sup>, 98.7, 104.3\*<sup>1</sup>, 107.1

\*1 Radio stations with good reception  
The frequency changes as follows each time the Genre Seek on-screen button is pressed.

89.3→98.3→104.3→98.3

### NOTE

- Only one Genre can be selected.
- Touch the  on-screen button to return to the FM1 or FM2 main screen.
- It may not be possible to receive any station even if the Genre Seek function is used.
- If a program in the selected genre is not broadcast to a region, reception is not possible even if the Genre Seek function is used.
- The Genre Seek function searches for genre code (program type) which FM analog broadcasts transmit. HD Radio specialty programs (HD2-HD8) cannot be searched because they are not FM analog broadcasts.
- If radio stations which are selected by scanning using the Genre Seek function are HD Radio broadcasting stations, they are changed from analog broadcasts to HD Radio broadcasts after a few seconds if the reception conditions are good. The genre is displayed after the switch, however, the genre for FM analog broadcasts may differ.

### HD Radio

#### What is HD Radio™ Technology and how does it work?

HD Radio™ Technology is the digital evolution of analog AM/FM radio. Your radio product has a special receiver which allows it to receive digital broadcasts (where available) in addition to the analog broadcasts it already receives. Digital broadcasts have better sound quality than analog broadcasts as digital broadcasts provide free, crystal clear audio. For more information, and a guide to available radio stations and programming, please visit [www.hdradio.com](http://www.hdradio.com).



Interior Comfort  
**Audio System**

### Benefits of HD Radio™ Technology





#### (Information)



The song title, artist name and genre will appear on the screen when available by the radio station.

#### (Multicast)



On the FM radio frequency most digital stations have “multiple” or supplemental programs on each FM station.

### Listening to HD Radio™ Technology

If  turns on by selecting a radio station which is an HD Radio broadcasting station, the analog broadcast is switched to an HD Radio broadcast automatically after a few seconds and then received. For FM, , and for AM,  is displayed, and the  illuminates in orange.





If the HD Radio broadcast is stopped and changed to an analog broadcast, press down  to turn off .

#### Multicast channel selection (FM)

Press   on-screen button to switch to the multi-cast channel for the displayed number.

The number of multi-cast channels which can be received differs depending on the radio station.

### NOTE

- If an analog broadcast is received once and HD Radio is received while HD1 is selected, the audio unit switches to the HD Radio station automatically.
- When the HD Radio button is illuminated, there could be a noticeable difference in sound quality and volume when a change from digital to analog signals occurs. If the sound quality and volume become noticeably diminished or cut off, touch the HD button to turn off HD Radio (HD Radio button is not illuminated).
- Once an analog broadcast is received when HD1 is selected from the preset channels, it is switched to HD Radio automatically. If the radio reception conditions are poor, or  is off, switching to HD Radio broadcasts is not possible.
- When an HD specialty channel (HD2 to HD8) is selected from the preset channels, “No HD signal” is displayed and no audio is output until HD Radio is received. If the radio reception conditions are poor, “No HD signal” continues to be displayed.
- If the  is not illuminated or does not illuminate in orange, information such as song titles of the HD Radio station are received, however, the audio output is analog. If information can no longer be received and the non-reception condition continues,  and  on-screen buttons disappear.

## Interior Comfort Audio System

### ▼ Operating the Satellite Radio\*

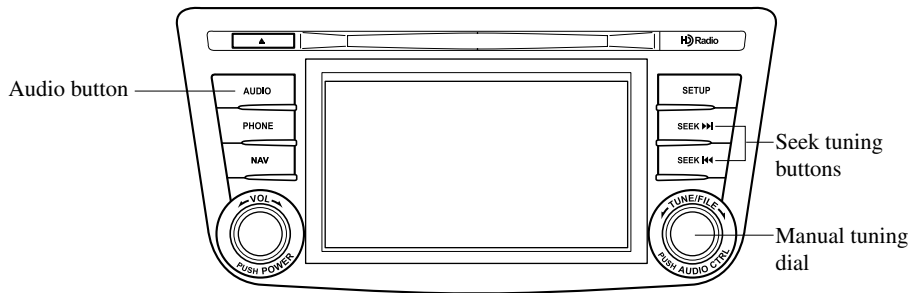

#### **NOTE**

*This equipment has been tested and found to comply with the limits for a Class B digital device, pursuant to Part 15 of the FCC Rules. These limits are designed to provide reasonable protection against harmful interference in a residential installation. This equipment generates, uses, and can radiate radio frequency energy and if not installed and used in accordance with the instructions, may cause harmful interference to radio communications. However, there is no guarantee that interference will not occur in a particular installation. If this equipment does cause harmful interference to radio or television reception, which can be determined by turning the equipment off and on, the user is encouraged to try to correct the interference by one or more of the following measures:*

- Increase the separation between the equipment and tuner.
- Connect the equipment into an outlet on a circuit different from that to which the tuner is connected.
- Consult the dealer or an experienced radio/TV technician for help.

#### **What is satellite radio?**

With over 130 channels, SIRIUS Satellite Radio brings you more of what you love. Get channels and channels of commercial-free music, plus sports, news, talk, entertainment and more.

**Commercial-free music from nearly every genre** —rock to pop, hip-hop to country, jazz, classical and more. Plus live performances and artist-dedicated channels.

**Live sports Play-by-Play & Expert Talk** —every NFL game, every NASCAR® race, 24/7 sports talk, college sports and more.

**Exclusive entertainment, comedy and talk** —The biggest names, compelling talk, hilarious comedy.

**World-class news plus local traffic and weather.**

Sign up for SIRIUS Satellite Radio today!

**6-70** \*Some models.

Interior Comfort  
**Audio System**

**NOTE**

*Exclusive to Sirius. If your vehicle is equipped with Sirius, your new Mazda includes a free introductory subscription with a limited term trial offer. Call 888-539-7474 to activate. For more information, visit [www.siriusxm.com](http://www.siriusxm.com). Satellite radio can be subscribed to and received in the United States (Except Alaska and Hawaii) and Canada. Contact Authorized Mazda Dealer for details.*

**How to Activate Satellite Radio**

You must call SIRIUS to activate your service. Activation is free and takes only a few minutes.

SIRIUS service uses an ID code to identify your radio. This code is needed to activate SIRIUS service, and report any problems.

Please have the following information ready:

- SIRIUS ID (12-digit electronic serial no, or ESN<sup>\*1</sup>)
- Valid credit card information (may not be required at initial sign-up)

\*1 ESN: Electronic Serial Number  
Be sure you are parked outside with a clear view of open sky, you will be instructed to turn on your radio (in SIRIUS mode and tuned to channel 184). Activation typically takes only 2—5 minutes.

**Displaying the SIRIUS ID (ESN)**

Turn the manual tuning dial and select channel 0 to display the twelve-digit Electronic Serial Number (ESN) for the SIRIUS tuner.

**SIRIUS operation**

All operations of the satellite radio are conducted by means of the audio unit.

**SIRIUS radio mode selection**

Touch the **SIRIUS** on-screen tab on the audio screen to receive the previously received SIRIUS channel. Every time the **SIRIUS** on-screen tab is touched, the bank changes in the order shown below.

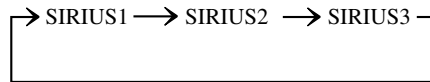

**NOTE**

- *SIRIUS1, SIRIUS2 and SIRIUS3: six stations can be stored in each bank for convenient access to your favorite stations.*
- **SIRIUS1** is displayed when SIRIUS1 is selected, **SIRIUS2** is displayed when SIRIUS2 is selected, and **SIRIUS3** is displayed when SIRIUS3 is selected.

**Operation in the initial state**

It may take some time to start up the equipment when it is in the initial state, when there is a change in the user's subscription condition, when the firmware is updated or when the SIRIUS channel map is changed.

“Updating Channels XXX %” is displayed when the SIRIUS channel map is changed.

If the user contract content is changed, “Subscription Updated” is displayed.

When the firmware is updated, the “Updating Receiver” is displayed.

Updating could take as long as a few minutes depending on the geographical area. When the unit is in an initialized state, channel 184 is displayed after the display indicates “Updating Receiver”.

Interior Comfort

## Audio System

### NOTE

Do not perform the following operation while “Updating Channels XXX%”, “Updating Receiver” is displayed. Otherwise, the updating procedure will be canceled.

- Turning off the audio power
- Switching to other modes
- Switching the ignition off

When the SIRIUS mode is switched to another mode, or when the power is turned off, the present channel which is being received is stored as the last channel.

### Channel up

Turn the manual tuning dial to the right or press the seek up button (▶▶).

### Channel down

Turn the manual tuning dial to the left or press the seek down button (◀◀).

### NOTE

The channel is continuously switched to the next or previous channel while the seek tuning button (▶▶,◀◀) is continuously pressed.

### Unsubscribed channel

When a channel which has been preset becomes unsubscribed or the current channel being listened to becomes unsubscribed, the following is displayed: “Call 888-539-SIRIUS” “to subscribe”

### NOTE

When the subscription contract is canceled, all of the channels including channel 184 appear as unsubscribed.

### Preset channel programming

1. Select the desired channel to be programmed.

2. Long-press any of the preset on-screen buttons.

### NOTE

Six stations can be stored in each bank, SIRIUS1, SIRIUS2 and SIRIUS3 for convenient access to your favorite stations.

### Preset channel call-up

Touch the preset on-screen button for the channel which you want to select.

### NOTE

In the initial setting, all channels are preset to 184.

### Selection from channel list

Receivable channels can be displayed on the channel list screen. You can easily select the channel you want to listen from the list. Each category can be also displayed.

1. Touch the  on-screen button.
2. Touch the channel you want to listen from the list.

### NOTE

Currently available channels (including parental locked channels) are all displayed in the list.

### (Select from category list)

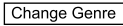
1. Touch the  on-screen button on the channel list screen.
2. Touch the category name which you want to select from the list.

### NOTE

A category can be set only when a channel which belongs to a category is being received.

Interior Comfort  
**Audio System**

### Scan tuning

Touch the  on-screen button to automatically sample stations. Scanning stops at each station for about five seconds.

To hold a station, touch the  on-screen button again during this interval.

#### **NOTE**

*Unsubscribed channels, invalid channels, parental lock channels and channel 0 are not subject to the scan, therefore these channels will skip automatically.*



### **Channel number, channel name, category name, artist name, song titles and information display**

The information regarding the channel which is currently being received is displayed.

#### **NOTE**

*If channels have not been subscribed to or parental locked, the channel name, category name, artist name, song title and information is not displayed.*

### **Display scroll**

If a whole title cannot be displayed at one time, touch the  on-screen button on the right side of the title. When the last character is displayed, touch the  on-screen button to display the first character of the title.

#### **NOTE**

*The  on-screen button is displayed only if a whole title cannot be displayed at one time.*

### **Instant replay**

This function allows you to rewind and replay the program that you were previously or are currently listening to.

When the  on-screen button is touched, playback starts from the beginning of the current program.

When the  on-screen button is touched twice, playback starts from the beginning of the previous program.

Touch and hold the  on-screen button to reverse the program while the button is being pressed.

When the  on-screen button is touched, playback starts from the beginning of the next program.

When the  on-screen button is touched while the last program is being played, the instant replay mode is canceled.

Touch and hold the  on-screen button to fast-forward the program while the button is being pressed.

When touching and holding the button until the end of the program, the instant replay mode is canceled.

### **Instant replay (PAUSE)**

If the  on-screen button is touched, instant replay mode is turned on in a paused condition (PAUSE).

Touch the  on-screen button again to resume playback from the point at which it was paused.



### **Parental lock**

Parental lock, parental unlock, parental lock code change, and parental lock code reset can be set.

Interior Comfort



## Audio System

### NOTE

- Touch the  on-screen button during all the settings to return to the previous display.
- Touch the  on-screen button during the code and master code input to delete an input number.
- If only a four-digit code or master code is input, "Done" can be selected.
- If the registered code has been forgotten, reset the code in "Initialize Parental Code" to [0000].



### Parental lock

If a channel is locked, the channel is muted.

1. Turn the manual tuning dial to select the desired channel.
2. Touch the  on-screen button to display the settings screen.
3. Touch the  on-screen button to display the parental lock settings screen.
4. "Input Parental Code" is displayed, and input of the registered code is possible. To enter a number, use the numerical keypad.
5. After inputting the four digits, touch the  on-screen button to confirm the four digits.
6. If the four digits match the registered code, "Channel XXX locked" appears and mute is turned on. If they do not match the registered code, "Wrong code" appears and then the display returns to "Input Parental Code".

### Parental unlock

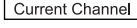
Channels locked using the parental lock function can be unlocked.



1. Select a channel to be unlocked by turning the manual tuning dial.
2. Touch the  on-screen button to display the settings screen.
3. Touch the  on-screen button to display the parental unlock settings screen.
4. "Input Parental Code" is displayed, and input of the registered code is possible. To enter a number, use the numerical keypad.
5. After inputting the four digits, touch the  on-screen button to confirm the four digits.
6. If the four digits match the registered code, "Channel XXX unlocked" appears and mute is canceled. If they do not match the registered code, "Wrong code" appears and then the display returns to "Input Parental Code".

### Parental-lock code change

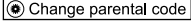
When changing the code, the new code is input after the previous one is input first.

1. Touch the  on-screen button to display the settings screen.
2. Touch the  on-screen button to display the code change screen.
3. "Enter Current Code" is displayed, and input of the registered code is possible. To enter a number, use the numerical keypad.

Interior Comfort  
**Audio System**

4. After inputting the four digits, touch the  on-screen button to confirm the four digits.
5. If the four digits match the registered code, “Enter New Code” is displayed. If they do not match the registered code, “Wrong code” appears and then the display returns to “Enter Current Code”. To enter a number, use the numerical keypad.
6. After inputting the four digits, touch the  on-screen button to confirm the four digits.
7. “Code changed” appears to indicate that the new code input has been completed.
8. The display returns to its normal display.

**NOTE**

*Channels locked before changing the code remain after changing the code. To unlock a channel, input the changed code.*

**Parental-lock code reset**

If the registered code has been forgotten, reset the code to the default [0000] code.

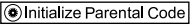
1. Touch the  on-screen button to display the settings screen.
2. Touch the  on-screen button to display the code initial screen.
3. “Enter Master Code” is displayed, and input of the registered code is possible. To enter a number, use the numerical keypad.

**NOTE**

*Master code:*

*The Master Code is used to initialize or re-initialize the code in the event that the code is not set to [0000] and/or the personalized code is not known. The initialization process resets the code to [0000]. The master code can potentially defeat the intent of the security of the parental lock if it is located by persons not authorized by the owner to access certain channels.*

*SIRIUS Satellite Radio Master Code: [0913]*

4. After inputting the four digits, touch the  on-screen button to confirm the four digits.
5. If the four digits match the master code, “Code initialized” appears. If they do not match the master code, “Wrong code” appears and the display returns to “Enter Master Code”.
6. The code returns to the default [0000] code.

**Seek alert**

The song title and artist name for the song currently being listened to, and team names at the sports game currently being listened to can be recorded as favorites. The user is notified when a program begins which has favorites-related information recorded.

**Selection from seek alert program list**

Select the station you want to listen to from the list to receive the program. Touch the  on-screen button to return to the receiving screen.

Interior Comfort

## Audio System

### Storing songs, artists, and sports team names

#### NOTE





- A maximum of 10 songs, artists, and sports team names each can be stored.
- If the song title, artist name, sports team name cannot be displayed, “No available items for this program” is displayed.
- Even if the song title, and artist name are displayed in the main screen, it may not be possible to record information for old songs.
- If a song name is stored, the song seek function is turned on.
- If an artist name is stored, the artist seek function is turned on.
- If a sports team name is stored, the game alert function is turned on.

1. Touch the  on-screen button to display the current song and artist names currently being received. The sports team name is displayed while the sports program is being received.
2. Select the item you want to store from song title, artist name and sports team name.
3. “XXXXXX (song, artist, sports team name) stored” is displayed.



#### NOTE

If there is not enough available storage space, “Song Memory Full” or “Artist Memory Full” or “Team Memory Full” and “Delete one to store new one” are displayed. Delete from the list.

### Seek alert setting

On or off switching to song seek, artist seek, or game alert function, and deletion of stored information can be performed. Touch the  on-screen button and the  on-screen button. Touch the button you want to change from , , or .

#### (On or off switching)

Touch the , , and  on-screen button.

#### (Deletion)

1. Select song title, artist name, or sports team name that you want to delete from the list.
2. Touch the  on-screen button to display “XXXXXX (song, artist, sports team name) deleted”.



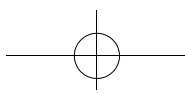

# MEMO

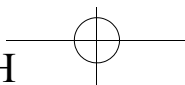
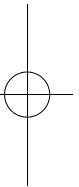
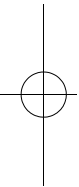

## Interior Comfort Audio System

### ▼ Operating the Compact Disc (CD) Player

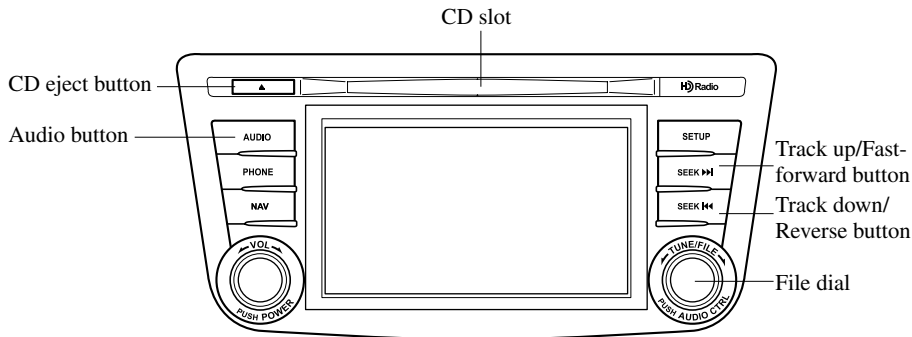

| Type                            | Playable data   |
|---------------------------------|---|
| Music/MP3/WMA/<br>AAC CD player | <ul style="list-style-type: none"><li>• Music data (CD-DA)</li><li>• MP3/WMA/AAC file</li></ul> |

#### **NOTE**

If a disc has both music data (CD-DA) and MP3/WMA/AAC files, playback of the two or three file types differs depending on how the disc was recorded.

#### **Inserting the CD**

Insert the CD into the slot, label-side up. The auto-loading mechanism will set the CD and begin play.

#### **NOTE**

There will be a short lapse before play begins while the player reads the digital signals on the CD.

#### **Ejecting the CD**

Press the CD eject button (▲) to eject the CD.

#### **Playback**

Press the audio button (AUDIO) or  on-screen tab with a CD inserted.

#### **Pause**

To pause playback, touch the  on-screen button.

Touch the  on-screen button during a pause to cancel it.

Interior Comfort  
**Audio System**

### **Fast-forward/Reverse**

#### **Operations using audio panel**

Press and hold the fast-forward button (▶▶) to advance through a track at high speed.

Press and hold the reverse button (◀◀) to reverse through a track at high speed.

#### **Operations on screen**

Touch and hold the  on-screen button to advance through a track at high speed.

Touch and hold the  on-screen button to reverse through a track at high speed.

### **Track search**

#### **Operations using audio panel**

Press the track up button (▶) or turn the file dial clockwise once to skip forward to the beginning of the next track.

Press the track down button (◀) or turn the file dial counterclockwise within a few seconds after playback begins to track down to the beginning of the previous track.

Press the track down button (◀) or turn the file dial counterclockwise after a few seconds have elapsed to start playback from the beginning of the current track.

#### **Operations on screen**

Touch the  on-screen button once to skip forward to the beginning of the next track.

Touch the  on-screen button within a few seconds after playback begins to track down to the beginning of the previous track.

Touch the  on-screen button after a few seconds have elapsed to start playback from the beginning of the current track.

### **Displaying file list**

The desired file list in the CD can be viewed.

#### **During music CD playback**

Touch the  on-screen button to display the track list in the CD.

#### **During MP3/WMA/AAC CD playback (Viewing file list in desired folder)**

1. Touch the  on-screen button to display the folder list in the CD.
2. Touch the folder which you want to select.

#### **(Viewing file list of current folder)**

Touch the  on-screen button.

### **Selecting file/track**

Select the file/track you want to play.

#### **During music CD playback**

1. Touch the  on-screen button to display the track list in the CD.
2. Touch the track you want to play.

#### **During MP3/WMA/AAC CD playback**

#### **NOTE**

Press the  on-screen button on the file list screen to display the list of folders.

#### **(Selection from all folders in CD)**

1. When the  on-screen button is touched, the folder list in the CD is displayed.
2. Select the folder name from the displayed list.
3. The files in the selected folder are displayed.
4. Select the file you want to play.

Interior Comfort

## Audio System



### (Selection from inside folder in which a song is currently being played)

1. Press the  on-screen button to select the song list.
2. Touch the song you want to listen to.

### Music scan



#### **During music CD playback**

This function scans the titles on a CD and plays 10 seconds of each song to aid you in finding a song you want to listen to.

1. Touch the  on-screen button during playback to play 10 seconds of each subsequent track starting from the next song.
2. Touch the  on-screen button during playback of the song you want to listen to and continue the playback from that point.

#### **During MP3/WMA/AAC CD playback**

This function scans the titles in a folder currently being played and plays 10 seconds of each song to aid you in finding a song you want to listen to.



1. Touch the  on-screen button during playback to play 10 seconds of each subsequent track starting from the next song.
2. Touch the  on-screen button during playback of the song you want to listen to and continue the playback from that point.



### **NOTE**

- If the unit is left in scan, normal playback will resume where scan was selected.
- If all the tracks are scanned, the unit will resume normal playback.

### Repeat playback



#### **During music CD playback**



Touch the  on-screen button during playback to play the song currently being played repeatedly. “” is displayed during playback.

Touch the  on-screen button while “” is displayed to cancel.



#### **During MP3/WMA/AAC CD playback**



##### **(Track repeat)**

Touch the  on-screen button to play the song during playback repeatedly. “” is displayed during playback.

Touch the  on-screen button two times while “” is displayed to cancel.



##### **(Folder repeat)**



Touch the  on-screen button two times to play the songs in the folder repeatedly. “” is displayed during playback.

Touch the  on-screen button while “” is displayed to cancel.

### Shuffle playback



#### **During music CD playback**



Touch the  on-screen button during playback to play the songs in the CD shuffle. “” is displayed during playback.

Touch the  on-screen button while “” is displayed to cancel.

#### **During MP3/WMA/AAC CD playback**



##### **(Folder shuffle)**



Touch the  on-screen button during playback to play the songs in the folder shuffle. “” is displayed during playback.

Touch the  on-screen button two times while “” is displayed to cancel.



Interior Comfort  
**Audio System**

**(CD shuffle)**

Touch the  on-screen button two times during playback to play the songs in the CD shuffle. “” is displayed during playback.

Touch the  on-screen button while “” is displayed to cancel.

**Display scroll**

If a whole title cannot be displayed at one time, touch the  on-screen button on the right side of the title. When the last character is displayed, touch the  on-screen button to display the first character of the title.

**NOTE**

- The  on-screen button is displayed only if a whole title cannot be displayed at one time.
- The information viewable in the display is only CD information (such as artist name, song title) which has been recorded to the CD.
- This unit cannot display some characters. Characters which cannot be displayed are indicated by an asterisk (\*).
- The number of characters which can be displayed is restricted.

**Message Display**

If “CD Error” is displayed, it means that there is some CD malfunction. Check the CD for damage, dirt, or smudges, and then properly reinsert. If the message appears again, take the unit to an Authorized Mazda Dealer for service.

**▼ How to use Auxiliary jack/USB port**

Audio can be heard from the vehicle's speakers by connecting a commercially-available portable audio unit to the auxiliary jack.

Use a commercially-available, non-impedance (3.5φ) stereo mini plug cable. Contact an Authorized Mazda Dealer for details.

In addition, audio can be played from the vehicle audio device by connecting a USB device or an iPod to the USB port.

Refer to AUX/USB/iPod Mode on page 6-86.

**▼ Error Indications**

If you see an error indication on the display, find the cause in the chart. If you cannot clear the error indication, take the vehicle to an Authorized Mazda Dealer.

| Indication | Cause                      | Solution  |
|------------|----------------------------|---|
| CD Error   | CD is inserted upside down | Insert the CD properly. If the error indication continues to display, consult an Authorized Mazda Dealer.     |
|            | CD is defective            | Insert another CD properly. If the error indication continues to display, consult an Authorized Mazda Dealer. |

**▼ Setup**

You can customize settings in the setup display as follows:

**Display**

Refer to Power/Volume/Display/Sound Controls on page 6-62.

Interior Comfort

## Audio System

### Sound

Refer to Power/Volume/Display/Sound Controls on page 6-62.

### Language

1. Press the setup button (**SETUP**).
2. Touch the **Language** on-screen tab to display the language setting screen.
3. Touch the desired language from the list.
4. Touch the **OK** on-screen button.

### NOTE

Only the available languages are displayed.

## Audio Control Switch Operation \*

When the audio unit is turned on, operation of the audio unit from the steering wheel is possible.

### NOTE

Because the audio unit will be turned off under the following conditions, the switches will be inoperable.

- When the ignition is switched off.
- When the power button on the audio unit is pressed and the audio unit is turned off.

### Without Bluetooth® Hands-Free

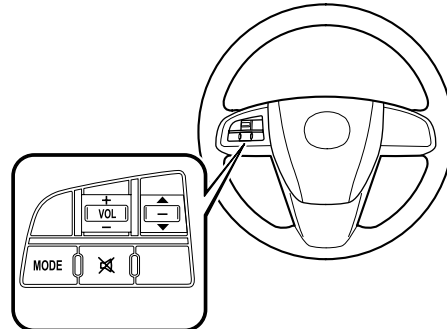

### With Bluetooth® Hands-Free only

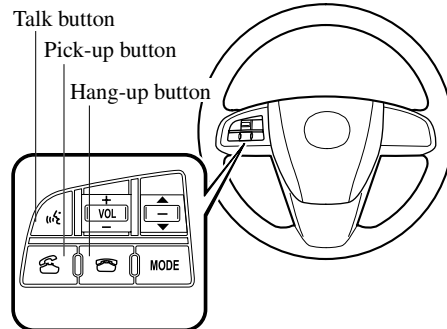

Interior Comfort  
**Audio System**

**With Bluetooth® Hands-Free and navigation system**

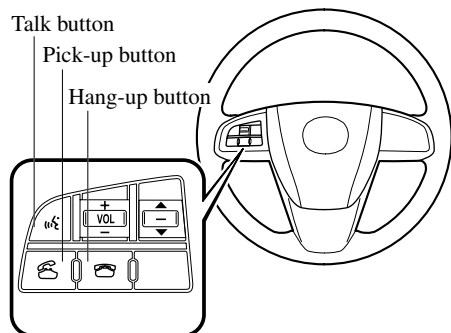

**NOTE**

- The talk button, pick-up button, and hang-up button are operable with the audio unit turned off.
- Mazda has installed this system to prevent distraction while driving the vehicle and using audio controls on the dashboard. Always make safe driving your first priority.

**▼ Adjusting the Volume**

To increase the volume, press up the volume switch.

To decrease the volume, press down the volume switch.

**Without Bluetooth® Hands-Free**

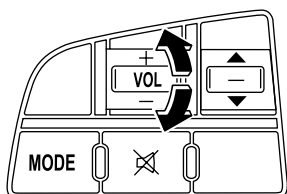

**With Bluetooth® Hands-Free**

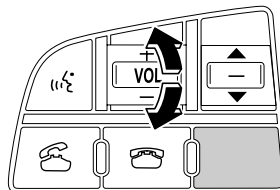

**▼ Changing the Source\***

Press the mode switch (MODE) to change the audio source (FM1 radio → FM2 radio → AM radio → CD player or CD changer → SIRIUS1 → SIRIUS2 → SIRIUS3 → AUX → BT audio → USB/iPod → cyclical).

**Without Bluetooth® Hands-Free**

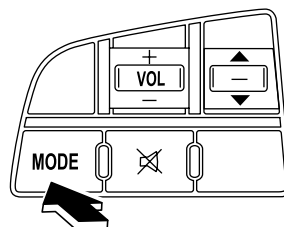

\*Some models. **6-83**

Interior Comfort  
**Audio System**

**With Bluetooth® Hands-Free only**

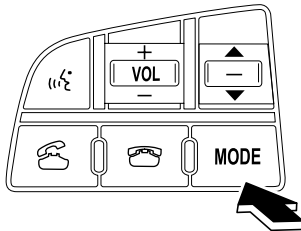

**NOTE**

- CD, CD changer, AUX, USB/iPod, SIRIUS digital satellite radio, and BT audio modes cannot be selected in the following cases:
  - Auxiliary jack, USB device, iPod, SIRIUS digital satellite radio unit, or BT audio unit is not equipped on the audio system.
  - CD has not been inserted.
- The AUX mode is unavailable unless you connect a commercially available portable audio unit (such as an MP3 player) to the auxiliary jack. Connect a portable audio unit or similar product on the market to the auxiliary jack to listen to music or audio over the vehicle's speakers. Change the audio source to AUX mode (page 6-86).

**▼ Seek Switch**

**Without Bluetooth® Hands-Free**

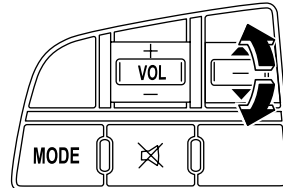

**With Bluetooth® Hands-Free**

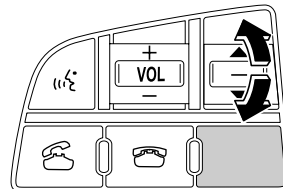

**When listening to the radio or SIRIUS digital satellite radio**

Press the seek switch up or down. The radio switches to the next/previous stored station in the order that it was stored (1—6).

**(Radio)**

Press and hold the seek switch in the up or down position to seek all usable stations at a higher or lower frequency whether programmed or not.



Interior Comfort  
**Audio System**

**(SIRIUS digital satellite radio)**

Press and hold the seek switch in the up or down position to seek all usable stations at a higher or lower channel whether programmed or not.

**NOTE**

***During radio reception***

*Radio stations which have been previously stored in the auto memory tuning can be called up by pressing the seek switch up or down while any radio station stored in the auto memory tuning is being received. Radio stations can be called up in the order they were stored with each press of the switch up or down.*

**When playing a CD, USB, iPod or BT audio**

Press the seek switch up to skip to the next track.

Press the seek switch down to repeat the current track.

Press and hold the seek switch in the up or down position to continuously switch the tracks up or down.

**▼ Mute Switch\***

Press the mute switch (⊗) once to mute audio, press it again to resume audio output.

**NOTE**

*If the ignition is switched off with the audio muted, the mute will be canceled. Therefore, when the engine is restarted, the audio is not muted. To mute the audio again, press the mute switch (⊗).*

**Without Bluetooth® Hands-Free**

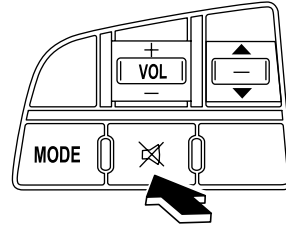

Interior Comfort

## Audio System

### AUX/USB/iPod Mode

#### Without USB port

Audio can be heard from the vehicle's speakers by connecting a commercially-available portable audio unit to the auxiliary jack.

A commercially-available, non-impedance (3.5 $\phi$ ) stereo mini plug cable is required. Contact an Authorized Mazda Dealer for details.

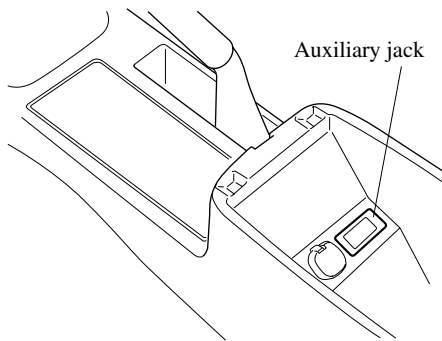

#### With USB port

Audio can be heard from the vehicle's speakers by connecting a commercially-available portable audio unit to the auxiliary jack.

A commercially-available, non-impedance (3.5 $\phi$ ) stereo mini plug cable is required. Contact an Authorized Mazda Dealer for details.

In addition, audio can be played from the vehicle audio device by connecting USB device or an iPod to the USB port.

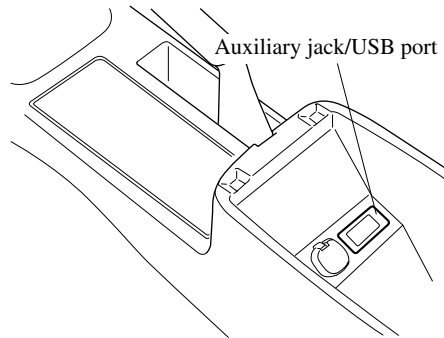

- ① How to use AUX mode ..... page 6-88
- ② How to use USB mode (Type A) ..... page 6-90
- ③ How to use USB mode (Type B) ..... page 6-94
- ④ How to use iPod mode (Type A) ..... page 6-98
- ⑤ How to use iPod mode (Type B) ..... page 6-102

Interior Comfort  
**Audio System**

**⚠ WARNING**

**Do not adjust the portable audio unit or a similar product while driving the vehicle:**

Adjusting the portable audio unit or a similar product while driving the vehicle is dangerous as it could distract your attention from the vehicle operation which could lead to a serious accident. Always adjust the portable audio unit or a similar product while the vehicle is stopped.

**⚠ CAUTION**

- Close the lid when the auxiliary jack/USB port\*<sub>1</sub> is not in use to prevent foreign objects and liquids from penetrating the auxiliary jack/USB port\*<sub>1</sub>.
- Depending on the portable audio device, noise may occur when the device is connected to the vehicle accessory socket. (If noise occurs, do not use the accessory socket.)

\*<sub>1</sub> With USB port

**NOTE**

- Before using the auxiliary jack/USB port\*<sub>1</sub>, refer to the instruction manual for the portable audio device.
- Use a commercially-available, non-impedance (3.5Φ) stereo mini plug for connecting the portable audio unit to the auxiliary jack. Before using the auxiliary jack, read the manufacturer's instructions for connecting a portable audio unit to the auxiliary jack.
- To prevent discharging of the battery, do not use the auxiliary input for long periods with the engine off or idling.
- When connecting a device to the auxiliary jack or USB port\*<sub>1</sub>, noise may occur depending on the connected device. If the device is connected to the vehicle's accessory socket, the noise can be reduced by unplugging it from the accessory socket.

\*<sub>1</sub> With USB port

**▼ How to connect USB port/  
Auxiliary jack**

**Without USB port**

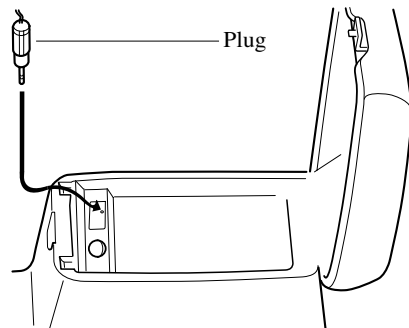

Interior Comfort

## Audio System

### With USB port

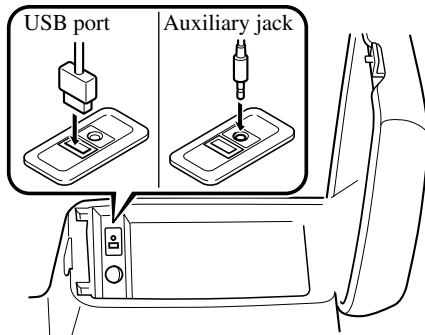

### Connecting a device

1. Open the console lid.
2. Connect the device plug to the USB port.

### Connecting with connector cable

1. Open the console lid.
2. Pass the connection plug cord through the cutout of the console and insert the plug into the auxiliary jack.

### **⚠ WARNING**

**Do not allow the connection plug cord to get tangled with the parking brake or the shift lever:**

*Allowing the plug cord to become tangled with the parking brake or the shift lever is dangerous as it could interfere with driving, resulting in an accident.*

### **⚠ CAUTION**

*Do not place objects or apply force to the auxiliary jack with the plug connected.*

### NOTE

- Insert the plug to the auxiliary jack/USB port\*1 securely.
- Insert or pull out the plug with the plug perpendicular to the auxiliary jack/USB port\*1 hole.
- Insert or remove the plug by holding its base.

\*1 With USB port

### ▼ How to use AUX mode

#### Audio Unit

(Type A)



(Type B)



#### Audio Control Switches

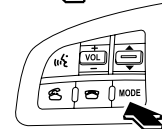
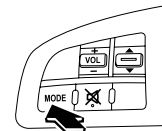

#### (Type A)

1. Switch the ignition to ACC or ON.
2. Press the power/volume dial to turn the audio system on.
3. Press the AUX button (AUX) of the audio unit or the mode switch (MODE) of the audio control switches on the steering wheel to change to the AUX mode.

#### (Type B)

1. Switch the ignition to ACC or ON.
2. Press the power/volume dial to turn the audio system on.
3. Press the audio button (AUDIO) to display the audio screen.

Interior Comfort  
**Audio System**

---

4. Press the **AUX** on-screen tab to switch to the AUX mode.

**NOTE**

- *When the device is not connected to the auxiliary jack, the mode does not switch to the AUX mode.*
- *Set the volume of the portable audio unit to the maximum within the range that the sound does not become distorted, then adjust the volume using the power/volume dial of the audio unit or the up/down switch of the audio control switch.*
- *Audio adjustments other than audio volume can only be done using the portable audio device.*
- *If the connection plug is pulled out from the auxiliary jack while in AUX mode, noise may occur.*

Interior Comfort  
**Audio System**

▼ **How to use USB mode (Type A)**

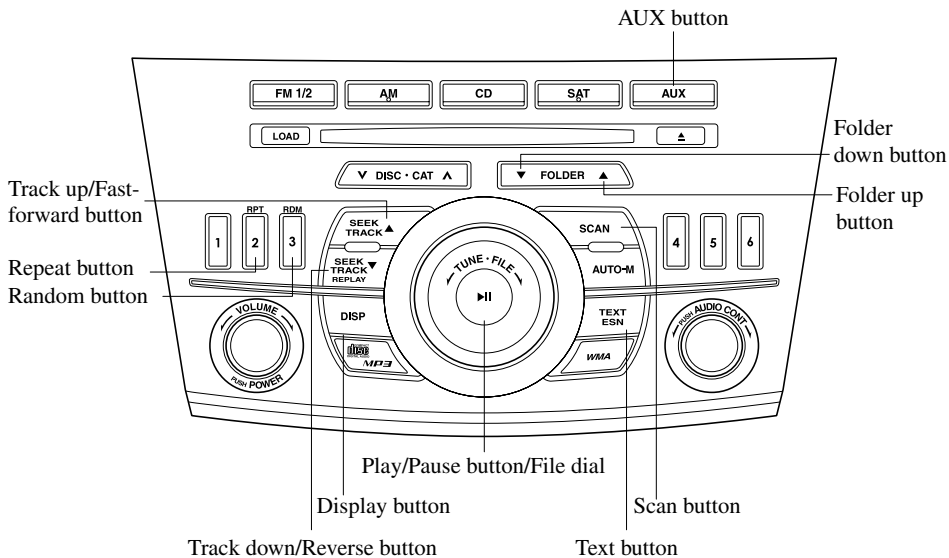

| Type     | Playable data    |
|----------|------------------|
| USB mode | MP3/WMA/AAC file |

**Playback**

1. Switch the ignition to ACC or ON.
2. Press the power/volume dial to turn the audio system on.
3. Press the AUX button (**AUX**) of the audio unit or the mode switch (**MODE**) of the audio control switches on the steering wheel to switch to the USB mode and start playback.

**NOTE**

- Some devices such as smart phones may require a setting change to allow USB operation.
- When the USB device is not connected, the mode does not switch to USB mode.
- When there is no playable data in the USB device, "NO CONTENTS" is flashed.
- Playback of the USB device is in the order of the folder numbers. Folders which have no MP3/WMA/AAC files are skipped.
- Do not remove the USB device while in the USB mode. The data may be damaged.

**Pause**

To stop playback, press the Play/Pause button (▶||). Press the button again to resume playback.

Interior Comfort  
**Audio System**

**Fast-forward/Reverse**

Press and hold the fast-forward button (▲) to advance through a track at high speed.

Press and hold the reverse button (▼) to reverse through a track at high speed.

**Track search**

Press the track up button (▲) or turn the file dial clockwise once to skip forward to the beginning of the next track.

Press the track down button (▼) or turn the file dial counterclockwise within a few seconds after playback begins to track down to the beginning of the previous track.

Press the track down button (▼) or turn the file dial counterclockwise after a few seconds have elapsed to start playback from the beginning of the current track.

**Folder search**

To change to the previous folder, press the folder down button (▼), or press the folder up button (▲) to advance to the next folder.

**Music Scan**

This function scans the titles in a folder currently being played and plays ten seconds of each song to aid you in finding a song you want to listen to.

Press the scan button (SCAN) during playback to start the scan play operation (the track number will flash). Press the scan button (SCAN) again to cancel scan playback.

**NOTE**

*If the unit is left in scan, normal playback will resume where scan was selected.*

**Repeat playback**

Press the repeat button (RPT) during playback to play the current track repeatedly. "RPT" is displayed during playback.

Press the repeat button (RPT) two times while "RPT" is displayed to cancel.

**Random playback**

Press the random button (RDM) during playback to play the tracks in the folder randomly. "RDM" is displayed during playback.

Press the random button (RDM) two times while "RDM" is displayed to cancel.

**Switching the display**

For files with a file name and other information that have been input, the display switches between display of the file name and other information each time the display button (DISP) is pressed during playback.

Track number/Elapsed time

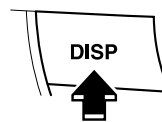

Artist name

Album name

Song name

Interior Comfort

## Audio System

---

### **NOTE**

- *The information (artist name, music name) is displayed only when the USB device information in the USB device has information which can be displayed on the screen.*
- *The system can only display one-byte alphabetic characters. If two-byte or other types of characters have been recorded to the USB device, they may not display correctly.*

### **Display scroll**

Only 8 characters (File name) or 12 characters (Except file name) can be displayed at one time. To display the rest of the characters of a long title, press the text button (**TEXT**). The display scrolls the next 12 characters. Press the text button (**TEXT**) again after the last 12 characters have been displayed to return to the beginning of the title.

### **NOTE**

*The number of characters which can be displayed is restricted.*



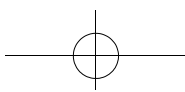

# MEMO

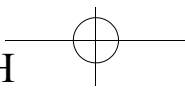
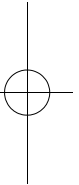
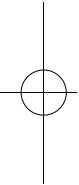

## Interior Comfort Audio System

### ▼ How to use USB mode (Type B)

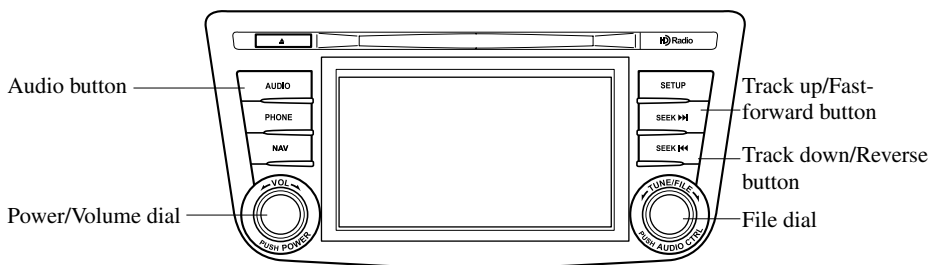

| Type     | Playable data    |
|----------|------------------|
| USB mode | MP3/WMA/AAC file |

#### **Playback**

1. Switch the ignition to ACC or ON.
2. Press the power/volume dial to turn the audio system on.
3. Press the audio button (**AUDIO**) to display the audio screen.
4. Touch the **USB** on-screen tab to switch to USB mode and start playback.

#### **NOTE**

- Some devices such as smart phones may require a setting change to allow USB operation.
- When a USB device is not connected to the USB port, the mode does not switch to the USB mode even if the **USB** on-screen tab is touched.
- Do not remove the USB device while in the USB mode. Otherwise, the data could be damaged.

#### **Pause**

Touch the **▶/||** on-screen button to pause playback.  
Touch the **▶/||** on-screen button while playback is paused to cancel the pause.

## Interior Comfort Audio System

### **Fast-forward/Reverse**

#### **Operations using audio panel**

Press and hold the fast-forward button (▶▶) to advance through a track at high speed.

Press and hold the reverse button (◀◀) to reverse through a track at high speed.

#### **Operations on screen**

Touch and hold the  on-screen button to advance through a track at high speed.

Touch and hold the  on-screen button to reverse through a track at high speed.

### **Track search**

#### **Operations using audio panel**

Press the track up button (▶) or turn the file dial clockwise once to skip forward to the beginning of the next track.

Press the track down button (◀) or turn the file dial counterclockwise within a few seconds after playback begins to track down to the beginning of the previous track.

Press the track down button (◀) or turn the file dial counterclockwise after a few seconds have elapsed to start playback from the beginning of the current track.

#### **Operations on screen**

Touch the  on-screen button once to skip forward to the beginning of the next track.

Touch the  on-screen button within a few seconds after playback begins to track down to the beginning of the previous track.

Touch the  on-screen button after a few seconds have elapsed to start playback from the beginning of the current track.

### **Displaying song list**

The song list in the USB device can be viewed.

#### **NOTE**

*The song list may not display depending on the conditions.*

### **(Displaying optional list)**

1. Touch the  on-screen button during playback.
2. Touch the category which you want to select. The record list or song list is displayed.

### **(Displaying a list being played)**

Touch the  on-screen button.

#### **NOTE**

*Press the  on-screen button to display the upper list.*

### **Selecting from list**



Select the desired song to play.



1. Press the  on-screen button to select the song list.
2. Touch the song you want to listen to.

#### **NOTE**

*The selected song list becomes the play list.*



### **Repeat playback**

Touch the  on-screen button during playback. “” is displayed during playback.

Touch the  on-screen button two times while “” is displayed to cancel.

### **Shuffle playback**



#### **(Shuffling songs in list being played)**

Touch the  on-screen button during playback. “” is displayed during playback.



Interior Comfort



## Audio System

---



Touch the  on-screen button two times while “” is displayed to cancel.

### (Shuffling album in list being played)

Touch the  on-screen button two times during playback. “” is displayed during playback.

Touch the  on-screen button while “” is displayed to cancel.

### Text scroll

If a whole title cannot be displayed at one time, touch the  on-screen button on the right side of each title. When the last character is displayed, touch the  on-screen button to display the first character of the title.

### **NOTE**

- The  on-screen button is displayed when the whole title is not displayed.
- The information (artist name, song name, album name) is displayed only when the USB device has information which can be displayed on the screen.
- This unit cannot display some characters. Characters which cannot be displayed are indicated by an asterisk (\*).
- The number of characters which can be displayed is restricted.

### Error Messages

If the message “USB Error” is displayed, it indicates that there is no playable file in the USB device or there is an error in the USB device. Verify that the content recorded in the USB device has MP3/WMA/AAC files and re-connect correctly. If the message reappears, have the unit checked by an Authorized Mazda Dealer.

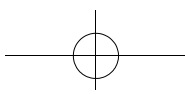

# MEMO

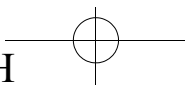
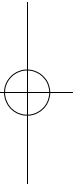
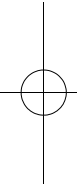

## Interior Comfort Audio System

### ▼ How to use iPod mode (Type A)

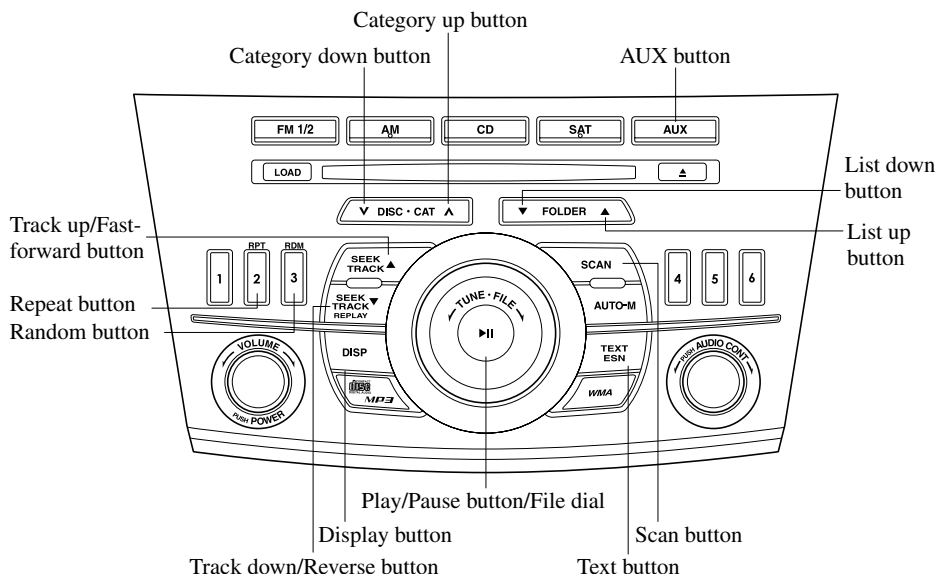

Connectable iPod is as follows:

- iPod: 5G
- iPod classic
- iPod nano: 1/2/3/4/5/6G
- iPod touch\*1: 1/2/3/4G
- iPhone\*1: iPhone/3G/3GS/4

\*1 For only iPod functions

#### **NOTE**

The iPod functions on the iPod cannot be operated while it is connected to the unit because the unit controls the iPod functions.

#### **Playback**

1. Switch the ignition to ACC or ON.
2. Press the power/volume dial to turn the audio system on.

3. Press the AUX button (AUX) of the audio unit or the mode switch (MODE) of the audio control switches on the steering wheel to switch to the iPod mode and start playback.

#### **NOTE**

- When an iPod is not connected, the mode does not switch to the iPod mode.
- When there is no playable data in the iPod, "NO CONTENTS" is flashed.
- Do not remove the iPod while in the iPod mode. Otherwise, the data could be damaged.

#### **Pause**

To stop playback, press the Play/Pause button (▶||). Press the button again to resume playback.

Interior Comfort  
**Audio System**

**Fast-forward/Reverse**

Press and hold the fast-forward button (▲) to advance through a track at high speed.

Press and hold the reverse button (▼) to reverse through a track at high speed.

**Track search**

Press the track up button (▲) or turn the file dial clockwise once to skip forward to the beginning of the next track.

Press the track down button (▼) or turn the file dial counterclockwise within a few seconds after playback begins to track down.

Press the track down button (▼) or turn the file dial counterclockwise after a few seconds have elapsed to start playback from the beginning of the track.

**Category search**

Press the category down button (∨) to select the previous category and press the category up button (∧) to select the next category.

***NOTE***

*The types of categories include Playlist, Artist, Album, Song, Podcast, Genre, Composer, and Audio book.*

**List search**

Press the list down button (▼) to select the previous list and press the list up button (▲) to select the next list.

***NOTE***

*When the selected category is Song or Audio book, there is no list.*

**Music Scan**

This function scans the titles in a list currently being played and plays ten seconds of each song to aid you in finding a song you want to listen to.

Press the scan button (**SCAN**) during playback to start the scan play operation (the track number will flash). Press the scan button (**SCAN**) again to cancel scan playback.

***NOTE***

*If the unit is left in scan, normal playback will resume where scan was selected.*

**Repeat playback**

Press the repeat button (**RPT**) during playback to repeat the playback of the song in the current list. "RPT" is displayed during playback.

Press the repeat button (**RPT**) while displaying "RPT" to cancel.

**Random playback**

Press the random button (**RDM**) during playback to play the tracks in the list randomly. "RDM" is displayed during playback.

Press the random button (**RDM**) two times while "RDM" is displayed to cancel.

***NOTE***

*The track number being played randomly is in the order of the iPod shuffle table.*

Interior Comfort

## Audio System

### Switching the display

For files with a file name and other information that have been input, the display switches between display of the file name and other information each time the display button (**DISP**) is pressed during playback.

Track number/Elapsed time

Category (Playlist title/Genre title/ Composer title/Podcast title)

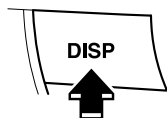

Artist name

Album name

Song name

### **NOTE**

- The information (artist name, music name) is displayed only when the iPod has information which can be displayed.
- The system can only display one-byte alphabetic characters. If two-byte or other types of characters have been recorded to the iPod, they may not display correctly.

### Display scroll

Only 8 characters (File name) or 12 characters (Except file name) can be displayed at one time. To display the rest of the characters of a long title, press the text button (**TEXT**). The display scrolls the next 12 characters. Press the text button (**TEXT**) again after the last 12 characters have been displayed to return to the beginning of the title.

### **NOTE**

*The number of characters which can be displayed is restricted.*

6-100



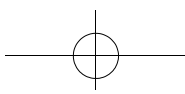

# MEMO

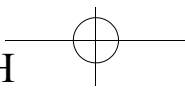
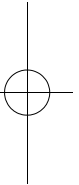
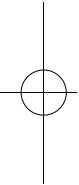

## Interior Comfort Audio System

### ▼ How to use iPod mode (Type B)

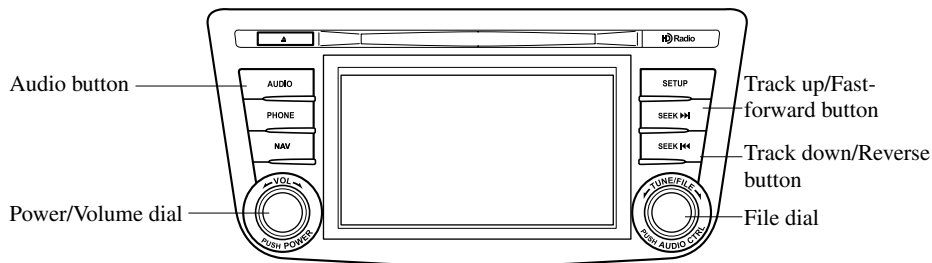

The connectable iPods are as follows:

- iPod: 5G
- iPod classic
- iPod nano: 1/2/3/4/5/6G
- iPod touch\*<sup>1</sup>: 1/2/3/4G
- iPhone\*<sup>1</sup>: iPhone/3G/3GS/4/4S
- iPad\*<sup>1</sup>: 1st/2nd/3rd

\*1 Only iPod function

#### **NOTE**

*The iPod functions on the iPod cannot be operated while it is connected to the unit because the unit controls the iPod functions.*

#### **Playback**

1. Switch the ignition to ACC or ON.
2. Press the power/volume dial to turn the audio system on.
3. Press the audio button (AUDIO) to display the audio screen.

4. Touch the **iPod** on-screen tab to switch to the iPod mode and start playback.

#### **NOTE**

- When the iPod is connected to the USB port, the **USB** on-screen tab changes to the **iPod** on-screen tab.
- Do not remove the iPod while in the iPod mode. Otherwise, the data could be damaged.

#### **Pause**

Touch the **▶/||** on-screen button to pause playback. Touch the **▶/||** on-screen button while playback is paused to cancel the pause.

Interior Comfort  
**Audio System**

**Fast-forward/Reverse**

**Operations using audio panel**

Press and hold the fast-forward button (▶▶) to advance through a track at high speed.

Press and hold the reverse button (◀◀) to reverse through a track at high speed.

**Operations on screen**

Touch and hold the [▶▶] on-screen button to advance through a track at high speed.

Touch and hold the [◀◀] on-screen button to reverse through a track at high speed.

**Track search**

**Operations using audio panel**

Press the track up button (▶▶) or turn the file dial clockwise once to skip forward to the beginning of the next track.

Press the track down button (◀◀) or turn the file dial counterclockwise within a few seconds (depends on iPod software version) after playback begins to track down to the beginning of the previous track.

Press the track down button (◀◀) or turn the file dial counterclockwise after a few seconds (depends on iPod software version) have elapsed to start playback from the beginning of the current track.

**Operations on screen**

Touch the [▶▶] on-screen button once to skip forward to the beginning of the next track.

Touch the [◀◀] on-screen button within a few seconds (depends on iPod software version) after playback begins to track down to the beginning of the previous track.

Touch the [◀◀] on-screen button after a few seconds (depends on iPod software version) have elapsed to start playback from the beginning of the current track.

**Displaying song list**

The song list in the iPod can be viewed.

**NOTE**

*The song list may not display depending on the conditions.*

**(Displaying optional list)**

1. Touch the [iPod Menu] on-screen button during playback.
2. Touch the category which you want to select. The record list or song list is displayed.

**(Displaying a list being played)**

Touch the [Song List] on-screen button.

**NOTE**

*Press the [◀] on-screen button to display the upper list.*

**Selecting from list**

Select the desired song to play.

1. Press the [Song List] on-screen button to select the song list.
2. Touch the song you want to listen to.

**NOTE**

*The selected song list becomes the play list.*

**Repeat playback**

Touch the [Repeat] on-screen button during playback. “♪” is displayed during playback.



Touch the [Repeat] on-screen button two times while “♪” is displayed to cancel.



Interior Comfort

## Audio System



### Shuffle playback



#### (Shuffling songs in list being played)

Touch the  on-screen button during playback. " " is displayed during playback.

Touch the  on-screen button two times while " " is displayed to cancel.

#### (Shuffling album in list being played)



Touch the  on-screen button two times during playback. " " is displayed during playback.

Touch the  on-screen button while " " is displayed to cancel.

#### **NOTE**

*The track number being shuffle played is in the order of the iPod shuffle table.*

### Text scroll

If a whole title cannot be displayed at one time, touch the  on-screen button on the right side of the title to display the whole title. When the last character is displayed, touch the  on-screen button to display the first character of the title.

#### **NOTE**

- The  on-screen button is displayed when the whole title is not displayed.
- The information (artist name, music name) is displayed only when the iPod has information which can be displayed on the screen.
- This unit cannot display some characters. Characters which cannot be displayed are indicated by an asterisk (\*).
- The number of characters which can be displayed is restricted.

### Error Messages

If the message "iPod Error" is displayed, it indicates that there are no playable files in the iPod or there is a malfunction.

Verify that the content recorded in the iPod has playable files and re-connect correctly. If the message reappears, have the unit checked by an Authorized Mazda Dealer.

### ▼ **Error Indications (Type B)**

If you see an error indication on the display, find the cause in the chart. If you cannot clear the error indication, take the vehicle to an Authorized Mazda Dealer.

| Indication | Cause                  | Solution   |
|------------|------------------------|--|
| USB Error  | USB device malfunction | Verify that the content recorded in the USB device has MP3/WMA/AAC files and re-connect correctly. If the error indication continues to display, consult an Authorized Mazda Dealer. |
| iPod Error | iPod malfunction       | Verify that the content recorded in the iPod has playable files and re-connect correctly. If the error indication continues to display, consult an Authorized Mazda Dealer.          |

Interior Comfort  
**Audio System**

## Safety Certification

This CD player is made and tested to meet exacting safety standards. It meets FCC requirements and complies with safety performance standards of the U.S. Department of Health and Human Services.

### CAUTION

- *This CD player should not be adjusted or repaired by anyone except qualified service personnel.  
If servicing is required, contact an Authorized Mazda Dealer.*
- *Use of controls or adjustments or performance of procedures other than those specified herein may result in hazardous laser exposure. Never operate the CD player with the top case of the unit removed.*
- *Changes or modifications not expressly approved by the party responsible for compliance could void the user's authority to operate this equipment.*

### NOTE

*For CD player section:*

*This device complies with part 15 of the FCC Rules. Operation is subject to the following two conditions: (1) This device may not cause harmful interference, and (2) this device must accept any interference received, including interference that may cause undesired operation.*

### NOTE

*This equipment has been tested and found to comply with the limits for a Class B digital device, pursuant to part 15 of the FCC Rules. These limits are designed to provide reasonable protection against harmful interference in a residential installation. This equipment generates, uses, and can radiate radio frequency energy and, if not installed and used in accordance with the instructions, may cause harmful interference to radio communications. However, there is no guarantee that interference will not occur in a particular installation.*

Interior Comfort

## Bluetooth® Audio (Type A)

### Bluetooth® Audio \*

#### ▼ What is Bluetooth® Audio?

##### Bluetooth® audio outline

By programming portable audio devices equipped with the Bluetooth® communication function to the vehicle's Bluetooth® unit, you can listen to music or audio recorded on these audio devices from the vehicle's speakers. Bluetooth® audio devices do not need to be plugged into the auxiliary jack.

After programming, operate the audio system's control panel to play/stop the music or audio.

#### **CAUTION**

- *Always program audio devices to the Bluetooth® audio system while the vehicle is stopped.*
- *Because only specified Bluetooth® audio devices can be used, consult an Authorized Mazda Dealer when purchasing or changing devices. Bluetooth® audio devices which correspond to specified Bluetooth® versions and profiles can be Bluetooth®-connected to the vehicle's Bluetooth® unit. However, even among these devices are ones which cannot be Bluetooth®-connected or have limited functionality. Each device to be used with the vehicle's Bluetooth® unit needs to be checked individually for compatibility. Consult an Authorized Mazda Dealer concerning device compatibility.*
  - *U.S.A.*  
*Phone: 800-430-0153*  
*Web: [www.MazdaUSA.com/bluetooth](http://www.MazdaUSA.com/bluetooth)*
  - *Canada*  
*Phone: 800-430-0153*  
*Web: [www.mazdahandsfree.ca](http://www.mazdahandsfree.ca)*
  - *Mexico*  
*Center of Attention to Client (CAC)*  
*Phone: 01-800-01-MAZDA*  
*Web: [www.mazdamexico.com.mx](http://www.mazdamexico.com.mx)*

**Applicable Bluetooth® specification**  
Ver. 2.0 or higher

**6-106** \*Some models.

## Bluetooth® Audio (Type A)

### Audio profile

- A2DP (Advanced Audio Distribution Profile) Ver. 1.0
- AVRCP (Audio/Video Remote Control Profile) Ver. 1.0/1.3

A2DP is a profile which transmits only audio to the Bluetooth® unit. If your Bluetooth® audio device corresponds only to A2DP, but not AVRCP, you cannot operate it using the control panel of the vehicle's audio system. In this case, the Bluetooth® audio device can be operated by controlling the device itself, the same as when a portable audio system without the Bluetooth® communication function is connected to the AUX terminal.

| Function             | A2DP | A2DP-AVRCP |          |
|----------------------|------|------------|----------|
|                      |      | Ver. 1.0   | Ver. 1.3 |
| Playback             | No   | Yes        | Yes      |
| Pause                | No   | Yes        | Yes      |
| File (Track) up/down | No   | Yes        | Yes      |
| Reverse              | No   | No         | Yes      |
| Fast-forward         | No   | No         | Yes      |
| Text display         | No   | No         | Yes      |

Yes: Available

No: Not available

### NOTE

- The system may not operate normally depending on the Bluetooth® audio device.
- To make sure that your Bluetooth® audio device is Ver. 1.0 or 1.3, refer to the Owner's Manual for the Bluetooth® audio device.
- It may not be possible to play a Bluetooth® audio device if it is placed anywhere transmission is compromised, such as inside a metal container or the trunk. Move the Bluetooth® audio device to a location where transmission is possible.
- Battery consumption of Bluetooth® audio devices is higher while Bluetooth® - connected.
- If a non-Bluetooth® device is to be used, a commercially-available Bluetooth® adapter is required. When playing an audio device with a Bluetooth® adapter installed, programming of the audio device may not be possible or audio may not be heard from the vehicle speakers if the connection of the adapter and the device is poor. If this happens, check if the Bluetooth® adapter is properly connected.

Interior Comfort

# Bluetooth® Audio (Type A)

## ▼ Bluetooth® Audio Preparation

### Bluetooth® audio device set-up

Bluetooth® audio programming, changes, deletions, and display of programmed device information can be performed.

1. The mode changes as follows each time the audio control dial is pressed. Select "BT SETUP".

#### Standard audio-equipped model



- ALC OFF\*
- BASS
- TREB
- FADE
- BAL
- BEEP ON\*
- ILLM EFT ON\*
- Welcome ON\*
- BT SETUP

#### Bose® Sound System-equipped model



- AudioPLT OFF\*
- CENTERPT OFF\*
- BASS
- TREB
- FADE
- BAL
- BEEP ON\*
- ILLM EFT ON\*
- Welcome ON\*
- BT SETUP

\* Depending on the mode selected, the indication changes.

2. Turn the audio control dial and select a desired mode.

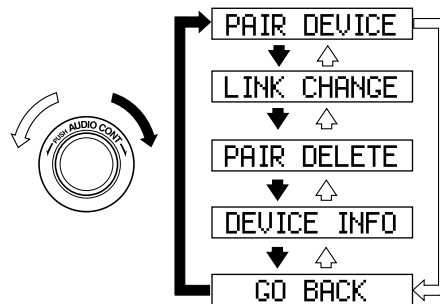



## Bluetooth® Audio (Type A)

| Display     | Mode                            | Function   |
|-------------|---------------------------------|--|
| PAIR DEVICE | Pairing program mode            | Bluetooth® audio device programming              |
| LINK CHANGE | Link change mode                | Changing link to Bluetooth® audio device         |
| PAIR DELETE | Pairing deletion mode           | Deleting link to Bluetooth® audio device         |
| DEVICE INFO | Device information display mode | Displaying vehicle's Bluetooth® unit information |

3. Press the audio control dial to determine the mode.

### **Bluetooth® audio device programming**

Any Bluetooth® audio device must be programmed to the vehicle's Bluetooth® unit before it can be listened to over the vehicle's speakers.

A maximum of seven devices including Bluetooth® audio devices and hands-free mobile phones can be programmed to one vehicle.

### ***NOTE***

- Always perform Bluetooth® audio device programming while the vehicle is stopped.
- If a Bluetooth® device has already been programmed to the vehicle as a hands-free mobile phone, it does not need to be programmed again when using the device as a Bluetooth® audio device. Conversely, it does not need to be programmed again as a hands-free mobile phone if it has already been programmed as a Bluetooth® audio device.
- Look around to be sure other likely Bluetooth® audio devices are not in range when you start to program. If in doubt, move your car to another location. The transmission range of a Bluetooth® audio device is about 10 m (32 ft). Therefore, if there is another Bluetooth® audio device within a 10 m (32 ft) radius of the vehicle, the device may be identified and programmed instead.
- Device registration can also be done using voice recognition (page 6-120).

Concerning the operation of a Bluetooth® audio device itself, refer to its instruction manual.

Some Bluetooth® audio devices have PIN codes (four digits). Refer to the audio device's instruction manual because the programming procedure differs depending on whether it has a PIN code or not.

### **Programming a Bluetooth® audio device which has a four-digit PIN code**

1. Using the audio control dial, select the pairing program mode "PAIR DEVICE" in the "BT SETUP" mode. (Refer to "Bluetooth® audio device set-up" for details.)

Interior Comfort

## Bluetooth® Audio (Type A)

2. Press the audio control dial to determine the mode.  
After “ENTER PIN” is displayed on the information display for three seconds, “PIN 0000” is displayed and the PIN code can be input.
3. Input the PIN code of your Bluetooth® audio device by pressing channel preset buttons 1 to 4 while “PIN 0000” is displayed.  
Press channel preset button 1 to input the first digit, 2 for the second, 3 for the third, and 4 for the fourth. For example, if the PIN code were “4213”, press channel preset button 1 four times (1, 2, 3, 4), button 2 twice (1, 2), button 3 once (1), and button 4 three times (1, 2, 3). If the “PIN 0000” display disappears before finishing the PIN code input, repeat the procedure from Step 1.

### NOTE

*Some devices accept only a particular pairing code (Usually, “0000” or “1234”).  
If pairing cannot be completed, refer to the owner's manual of your mobile device, and try those numbers if necessary.*

4. Press the audio control dial while the input PIN code is displayed.  
“PAIRING” flashes on the display.
5. Operate the Bluetooth® audio device and set it to the program mode while “PAIRING” is flashing.
6. When the programming is completed, “♪” and “PAIR SUCCESS” are displayed after about 10-30 seconds, after which “PAIR SUCCESS” continues to be displayed for three seconds, and then the unit returns to the normal display.

### NOTE

- Some Bluetooth® audio devices need a certain amount of time before the “♪” symbol is displayed.
- If the programming failed, “Err” flashes for three seconds.
- Programming cannot be performed while the vehicle is moving. If you attempt to perform programming while the vehicle is moving, “PAIR DISABLE” is displayed.
- If seven Bluetooth® audio devices have already been programmed to the vehicle, programming cannot be performed and “MEMORY FULL” is displayed. Delete one programmed device to program another one.

### Programming a Bluetooth® audio device which does not have a four-digit PIN code

1. Using the audio control dial, select the pairing program mode  
“PAIR DEVICE” in the “BT SETUP” mode. (Refer to “Bluetooth® audio set up” for details.)
2. Press the audio control dial to determine the mode.  
After “ENTER PIN” is displayed on the information display for three seconds, “PIN 0000” is displayed and the PIN code can be input.
3. Press the audio control dial while “PIN 0000” is displayed.  
“PAIRING” flashes on the display.
4. Operate the Bluetooth® audio device and set it to the program mode while “PAIRING” is flashing.
5. As the Bluetooth® audio device requires a PIN code, input “0000”.

## Bluetooth® Audio (Type A)

- When the programming is completed, “♫” and “PAIR SUCCESS” are displayed after about 10-30 seconds, after which “PAIR SUCCESS” continues to be displayed for three seconds, and then the unit returns to the normal display.

### NOTE

- If pairing cannot be completed, try “1234” instead. Refer to the owner's manual of your mobile device for the right PIN code.
- Some Bluetooth® audio devices need a certain amount of time before the “♫” symbol is displayed.
- If the programming failed, “Err” flashes for three seconds.
- Programming cannot be performed while the vehicle is moving. If you attempt to perform programming while the vehicle is moving, “PAIR DISABLE” is displayed.
- If seven Bluetooth® audio devices have already been programmed to the vehicle, programming cannot be performed and “MEMORY FULL” is displayed. Delete one programmed device to program another one.

### Changing the link to a Bluetooth® audio device

If several devices have been programmed, the Bluetooth® unit links the device last programmed. If you would like to link a different programmed device, it is necessary to change the link. The order of device priority after the link has been changed is maintained even when the ignition is switched off.

- Using the audio control dial, select the link change mode “LINK CHANGE” in the “BT SETUP” mode. (Refer to “Bluetooth® audio device set-up” for details.)

- Press the audio control dial to determine the mode.
- The name of the currently linked Bluetooth® audio device is displayed. If no Bluetooth® audio device is currently linked, the name of the first device among the programmed devices is displayed.
- Turn the audio control dial to select the name of the device you would like to link.

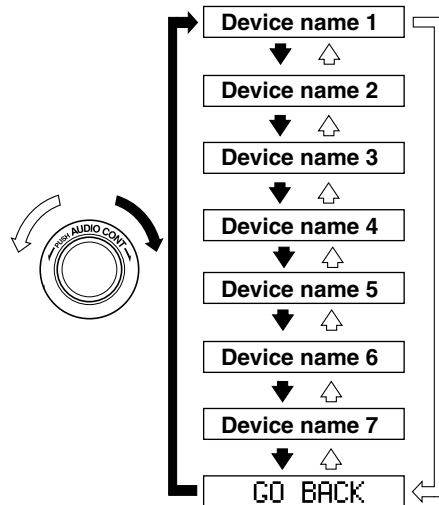

- Press the audio control dial to select the device you would like to link. The “♫” symbol disappears, and “PAIRING” flashes in the display.

### NOTE

When “GO BACK” is selected and the audio control dial is pressed, the display returns to “LINK CHANGE”.

Interior Comfort

## Bluetooth® Audio (Type A)

- If the link to the desired device is successful, the “🎵” symbol is displayed again, together with “LINK CHANGED”. “LINK CHANGED” is displayed for three seconds, then it returns to the normal display.

### NOTE

- Some Bluetooth® audio devices need a certain amount of time before the “🎵” symbol is displayed.
- If a hands-free type mobile phone has been the most recently programmed device, the Bluetooth® unit links this device. If you would like to use a Bluetooth® audio type device which has been previously programmed to the Bluetooth® unit, the link must be changed to this device.
- If an error occurs while trying to link a device, “Err” flashes in the display for three seconds, and the display returns to “LINK CHANGE”. If this occurs, check the programming status of the Bluetooth® audio device and the location of the device in the vehicle (not in the trunk or a metal-type box), and then try the link operation again.
- Device selection can also be done using voice recognition (page 6-131).

### How to confirm the device currently linked

Switch to the link-change mode. (Refer to “Changing the link to a Bluetooth® audio device”)

The device name displayed first is the device which is currently linked.

### Deleting the link to a Bluetooth® audio device

- Using the audio control dial, select the pairing delete mode “PAIR DELETE” in the “BT SETUP” mode. (Refer to “Bluetooth® audio device set-up” for details.)
- Press the audio control dial to determine the mode.
- The name of the first device among the programmed devices is displayed.
- Rotate the audio control dial and select the name of the programmed device you would like to delete.

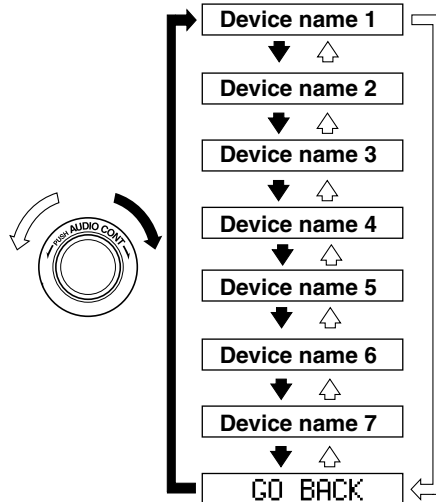

### NOTE

Only the names of programmed devices can be displayed. If only one device is programmed, only the name for this device is displayed.

Interior Comfort

## Bluetooth® Audio (Type A)

5. If a selection other than “GO BACK” is made and the audio control dial is pressed, “SURE ? NO” is displayed.
6. Rotate the audio control dial clockwise and switch the display to “SURE ? YES”.

### NOTE

The display changes as follows depending on whether the audio control dial is rotated clockwise or counterclockwise.

- Clockwise: “SURE ? YES” displayed
- Counterclockwise: “SURE ? NO” displayed

7. Press the audio control dial to delete the selected device.

### NOTE

Select “GO BACK” and press the audio control dial to return to the “PAIR DELETE” display.

8. “PAIR DELETED” is displayed for three seconds after the deletion is completed, and then it returns to the normal display.

### NOTE

If an error occurs while trying to delete the programmed device, “Err” flashes in the display for three seconds and the display returns to “LINK DELETE”.

### Bluetooth® audio device information display

1. Using the audio control dial, select the pair device information display mode “DEVICE INFO” in the “BT SETUP” mode. (Refer to “Bluetooth® audio device set-up” for details.)
2. Press the audio control dial to determine the mode.
3. The name of the Bluetooth® unit device is displayed.

4. Rotate the audio control dial to select the information for the Bluetooth® unit which you would like to view.

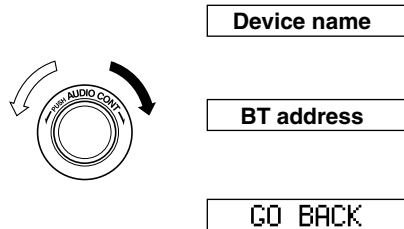

### NOTE

When “GO BACK” is selected and the audio control dial is pressed, the display returns to “DEVICE INFO”.

### ▼ How to Use the Bluetooth® Audio System

#### Switching to Bluetooth® audio mode

To listen to music or voice audio recorded to a Bluetooth® audio device, switch to the Bluetooth® audio mode to operate the audio device using the audio system control panel.

Any Bluetooth® audio device must be programmed to the vehicle's Bluetooth® unit before it can be used. (Refer to “Bluetooth® audio device programming”)

1. Switch the ignition to ACC or ON.
2. Turn on the Bluetooth® audio device's power.  
Make sure that the “♪” symbol is displayed in the information display. The symbol is not displayed if an unprogrammed Bluetooth® audio device is being used or the vehicle's Bluetooth® unit has a malfunction.

Interior Comfort

## Bluetooth® Audio (Type A)

### NOTE

Some Bluetooth® audio devices need a certain amount of time before the “🎵” symbol is displayed.

3. Press the AUX button (AUX) to switch to the Bluetooth® audio mode and start playback.

**If the current device version is lower than AVRCP Ver. 1.3:**

“BT Audio” is displayed.

**If the current device is AVRCP Ver. 1.3:**

The playback time is displayed.

### NOTE

- If the Bluetooth® audio device does not begin playback, press the Play/Pause button (▶||).
- If the mode is switched from Bluetooth® audio mode to another mode (radio mode), audio playback from the Bluetooth® audio device stops.
- If a call is received on a hands-free mobile phone during playback from the Bluetooth® audio device, the playback is stopped. Playback from the Bluetooth® audio device resumes after the call ends.

### Playback

1. To listen to a Bluetooth® audio device over the vehicle's speaker system, switch the mode to Bluetooth® audio mode. (Refer to “Switching to Bluetooth® audio mode”)
2. To stop playback, press the Play/Pause button (▶||).
3. Press the button again to resume playback.

### Selecting a file (track)

Short-press the track down button (▼) or turn the file dial counterclockwise: Selects the beginning of the current file (track). Short-press the track up button (▲) or turn the file dial clockwise: Selects the next file (track).

### Fast-forward/Reverse (only AVRCP Ver. 1.3)

#### Fast-forward

Press and hold the track up button (▲).

#### Reverse

Press and hold the track down button (▼).

### Switching the display (only AVRCP Ver. 1.3)

For files with a song title and other information that have been input, the display switches between display of the song title and other information each time the display button (DISP) is pressed during playback.

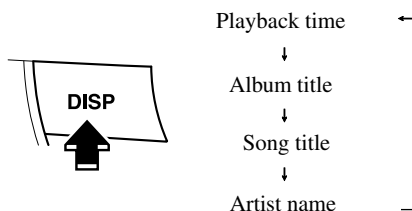

### NOTE

- If title information is not available, “NO TITLE” is displayed.
- If there are any undisplayable characters in the title, “- - - - -” is displayed.

Interior Comfort  
**Bluetooth® Audio (Type A)**

---

**Display scroll**

Only 12 characters can be displayed at one time. To display the rest of the characters of a long title, short-press the text button (**TEXT**). The display scrolls the next 12 characters. Short-press the text button (**TEXT**) again after the last 12 characters have been displayed to return to the beginning of the title.

Interior Comfort

## Bluetooth® Hands-Free (Type A)

### Bluetooth® Hands-Free \*

#### ▼ What is Bluetooth® Hands-Free?

##### Bluetooth® Hands-Free Outline

By connecting a Bluetooth® equipped device (Mobile phone) to the hands-free unit equipped on the vehicle, making and receiving calls is possible using the talk button, pick-up button and hang-up button located on the steering wheel, and saying the voice commands.

#### **⚠ WARNING**

**Perform phonebook registration related operations while the vehicle is parked:**

*Performing phonebook registration while driving the vehicle could be a distraction to your driving and result in an accident. In addition, a mistake in performing the phonebook operation could result in the loss of important data.*

##### Bluetooth® equipped device (Mobile phone)

A Bluetooth® equipped device (Mobile phone) communicates with the hands-free unit equipped on the vehicle using radio transmission (Bluetooth®).

For example, if the device (Mobile phone) is placed in a coat pocket, the phone calls can be made through your mobile service without taking out and handling the device (Mobile phone).

#### **⚠ CAUTION**

*The types of devices (Mobile phone) which can be connected to the hands-free unit are limited.*

*Therefore, before purchasing or changing your device (Mobile phone) model, consult Mazda Bluetooth® Hands-Free Customer Service or visit [www.MazdaUSA.com/bluetooth](http://www.MazdaUSA.com/bluetooth) for a complete list of compatible phones. Devices (Mobile phone) which can be connected to the hands-free system need to be compliant with Bluetooth® specifications and the appropriate profile. However, even among these Bluetooth® devices (Mobile phone) are some which will not connect with your Mazda or will have limited function. Therefore, consult Mazda Bluetooth® Hands-Free Customer Service for information regarding device (Mobile phone) compatibility:*

- U.S.A.  
Phone: 800-430-0153  
Web: [www.MazdaUSA.com/bluetooth](http://www.MazdaUSA.com/bluetooth)
- Canada  
Phone: 800-430-0153  
Web: [www.mazdahandsfree.ca](http://www.mazdahandsfree.ca)
- Mexico  
Center of Attention to Client (CAC)  
Phone: 01-800-01-MAZDA  
Web: [www.mazdamexico.com.mx](http://www.mazdamexico.com.mx)

##### **Applicable Bluetooth® specification**

Ver. 2.0 or higher

##### **Response profile**

- HFP (Hands Free Profile) Ver. 1.5
- DUN (Dial-up Networking Profile) Ver. 1.1
- PBAP (Phone Book Access Profile) Ver. 1.0

6-116 \*Some models.



Interior Comfort

## Bluetooth® Hands-Free (Type A)

- A2DP (Advanced Audio Distribution Profile) Ver. 1.0
- OPP (Object Push Profile) Ver. 1.1

### NOTE

- *The Bluetooth® Hands-Free system is operable several seconds after the ignition is switched to ACC or ON (requires less than 15 seconds).*
- *If the ignition is switched off during a hands-free call, the line is transferred to the device (Mobile phone) automatically.*
- *If the device (Mobile phone) is in a location where radio reception is difficult such as a metal container or in the trunk, the call may not be connected using Bluetooth®. If communication is not possible, change the location of the device (Mobile phone).*

### ▼ Component Parts

Bluetooth® Hands-Free consists of the following items:

- Talk button
- Pick-up button
- Hang-up button
- Information display
- Microphone
- Audio unit

### Talk button, Pick-Up button and Hang-Up button

Basic functions of Bluetooth® Hands-Free can be used for such things as making calls or hanging up using the talk button, pick-up button and hang-up button on the steering wheel.

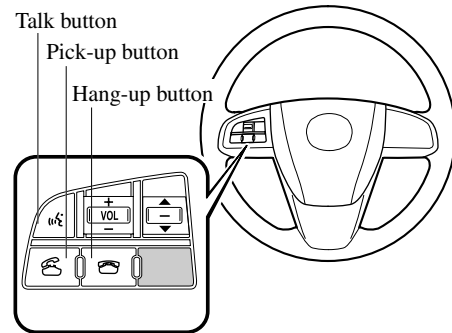

### Talk button operations

A short press or a long press of the talk button is used to operate the system as follows:

- Short press (Press the button less than 0.7 sec.)
- Long press (Press the button 0.7 sec. or more.)

Interior Comfort

## Bluetooth® Hands-Free (Type A)

### Information display

When available, the information display shows telephone numbers, Bluetooth® Hands-Free messages, and operation status.

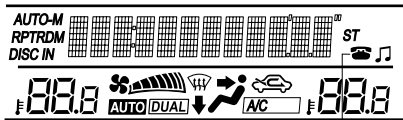

Bluetooth® phone connected

### Microphone

The microphone is used for speaking voice commands or exchanging conversation.

### Audio unit

The audio unit is used for adjusting the volume.

### ▼ Voice

To prevent the deterioration in voice recognition rate and voice quality, the following points must be observed:

- It is not necessary to face the microphone or approach it. Speak the voice commands while maintaining a safe driving position.

- Close the windows and/or the moonroof to reduce loud noises from outside the vehicle, or turn down the airflow of the climate control system while Bluetooth® Hands-Free is being used. Voice recognition may not function correctly or voice quality may deteriorate under the following conditions.
  - A passenger is speaking.
  - Driving with the window and/or the moonroof open.
  - Driving on bumpy roads.
  - Noise outside of the vehicle is loud. (Construction sites, inside tunnels, excess oncoming traffic, or heavy rain.)
  - Operation noise from turn signals, wipers, or the horn is heard.
  - A/C airflow is strong or wind is blowing on the microphone.
  - There is noise coming from cargo loaded in the vehicle.
- Voice commands may not be recognized depending on the voice. If the voice commands are not recognized correctly, repeat the commands in a louder voice, at a natural pace, as if speaking to another person.
- Dialects or different wording other than hands-free prompts cannot be recognized by voice recognition. Speak in the wording specified by the voice commands.

### NOTE

*If the voice recognition performance is not satisfactory, refer to "Voice Recognition Learning Function (Speaker Enrollment)" (page 6-135).*

Please be aware that the voice recognition may still make an error despite following the above points.

## Bluetooth® Hands-Free (Type A)

### ▼ Function Restrictions While Using Bluetooth® Hands-Free

Some functions are limited while Bluetooth® Hands-Free is being used.

They include:

- Beep sound and voice guidance related to the audio unit are not heard.
- Beep sound related to the A/C operation is not heard.

### ▼ How to Use This Section

Descriptions in the text are as follows:

**Say:** Voice commands to be spoken by you.

**Prompt:** Voice guidance output from the speaker.

#### **NOTE**

*Say voice commands after the beep sound [Beep] is heard.*

Example)

**Say:** [Beep] “Dial”

**Prompt:** “Number, please”

**Say:** [Beep] “XXXXXXXXXXXX (Ex. “555-1234”) (Telephone number)”

### **Bluetooth® Hands-Free Activation Method**

Press the pick-up button or talk button with a short press.

The hands-free system is activated.

Functions of the hands-free telephone, such as making and receiving calls, can be used after the activation. (For details on the telephone functions, refer to “Basic Bluetooth® Hands-Free Operation” or “Convenient Use of the Hands-Free System”.)

### **Tutorial**

The tutorial explains how to use Bluetooth® Hands-Free.

To activate the tutorial, do the following:

1. Press the pick-up button or talk button with a short press.
2. **Say:** [Beep] “Tutorial”
3. Follow the prompts to receive the appropriate voice guidance instructions.

### ▼ Useful Commands at Anytime, Convenient Operations

#### **Help function use**

The help function informs the user of all the available voice commands under the current conditions.

1. Press the talk button with a short press.
2. **Say:** [Beep] “Help”
3. Follow the prompts to receive the appropriate voice guidance instructions.

#### **Cancel**

The Bluetooth® Hands-Free system transitions to standby status if the following operation is performed while the system is activating.

Press the hang-up button, or the talk button with a long press.

#### **Returning to previous operation**

This command is for returning to the previous operation while in the voice recognition mode.

**Say:** [Beep] “Go Back”

Interior Comfort

## Bluetooth® Hands-Free (Type A)

### Voice guidance interrupt operation

Voice guidance can be skipped by pressing the talk button with a short press while it is being heard. A new voice input command can then be spoken by the user.

### Voice recognition mode cancel

If you want to cancel the voice recognition mode during a call, the voice recognition mode can be canceled without having to end the call.

Press the talk button with a long press.

## Basic Bluetooth® Hands-Free Operation

### ▼ Bluetooth® Hands-Free Preparation

#### Language setting

The available languages are English, Spanish, and Canadian French. If the language setting is changed, all of the voice guidance and voice input commands are done in the selected language.

#### **NOTE**

- *If the language setting is changed, device registration is maintained.  
Phonebook records are not cleared, but each language has a separate phonebook. Therefore, entries created in one language will need to be re-entered in the phonebook of the new language.*
- *Do these steps before you start driving. These less used functions are too distracting to undertake while driving until you are fully familiar with the system.*

#### **Method 1**

1. Press the pick-up button or talk button with a short press.
2. **Say:** [Beep] “Setup”
3. **Prompt:** “Select one of the following: Pairing options, confirmation prompts, language, passcode, select phone or select music player.”
4. **Say:** [Beep] “Language”
5. **Prompt:** “Select a language: English, French, or Spanish.”
6. **Say:** [Beep] “French” (Speak the desired language: “English”, “French” or “Spanish”)

Interior Comfort

## Bluetooth® Hands-Free (Type A)

### NOTE

*Other language settings can also be made while in the current setting by saying the name of the language in the native pronunciation.*

7. **Prompt:** “French (Desired language) selected. Is this correct?”
8. **Say:** [Beep] “Yes”
9. **Prompt:** “French (Desired language) selected, returning to main menu” (Spoken in the newly selected language).

### Method 2

1. Press the pick-up button or talk button with a short press.
2. **Say:** [Beep] “French” (Say the desired language: “English”, “French”, or “Spanish”.) (Change the desired language by saying the language name.)

### NOTE

*Other language settings can also be made while in the current setting by saying the name of the language in the native pronunciation.*

3. **Prompt:** “Would you like to change the language to French (Desired language)?”
4. **Say:** [Beep] “Yes”
5. **Prompt:** “Please wait. Switching to French phonebook. French selected, returning to main menu” (Spoken in the newly selected language).

### Pairing code setting

The 4-digit pairing code setting for registration of your cell phone (pairing) can be set beforehand.

### NOTE

*The initial setting value is “0000”.*

1. Press the pick-up button or talk button with a short press.
2. **Say:** [Beep] “Setup”
3. **Prompt:** “Select one of the following: Pairing options, confirmation prompts, language, passcode, select phone or select music player.”
4. **Say:** [Beep] “Pairing options”
5. **Prompt:** “Available options are: Pair, Edit, Delete, List, or Set Pairing Code.”
6. **Say:** [Beep] “Set pairing code”
7. **Prompt:** “Your current pairing code is XXXX. Do you want to change it to a different pairing code?”
8. **Say:** [Beep] “Yes”
9. **Prompt:** “Please say a 4-digit pairing code.”
10. **Say:** [Beep] “YYYY”
11. **Prompt:** “YYYY is this correct?”
12. **Say:** [Beep] “Yes” or “No”
13. If “Yes”, go to Step 14. If “No”, the procedure returns to Step 9.
14. **Prompt:** “Your new pairing code is YYYY. Use this pairing code when pairing devices to the Hands free system. Do you want to pair a device now?”
15. **Say:** [Beep] “Yes” or “No”
16. If “Yes”, the system switches to the device registration mode. If “No”, the system returns to standby status.

Interior Comfort

## Bluetooth® Hands-Free (Type A)

### **Device programming (Pairing)**

To use Bluetooth® Hands-Free, the device equipped with Bluetooth® has to be programmed to the hands-free unit using the following procedure.

A maximum of seven devices including hands-free mobile phones and Bluetooth® audio devices can be programmed to one vehicle.

#### **NOTE**

- *A device can be programmed only when the vehicle is parked. If the vehicle starts to move, the pairing procedure will end. Programming is dangerous while driving - pair up your device before you start driving. Park the car in a safe place before programming.*
- *If a Bluetooth® device has already been programmed to the vehicle as a Bluetooth® audio device, it does not need to be programmed again when using the device as a hands-free mobile phone. Conversely, it does not need to be programmed again as a Bluetooth® audio device if it has already been programmed as a hands-free mobile phone.*
- *Since the communication range of a Bluetooth® equipped device is about 10 meters (32 ft), if a device is placed within a 10-meter (32 ft) radius of the vehicle, it may be detected/programmed unintentionally while another device is being programmed.*

1. Activate the Bluetooth® application of the device.

#### **NOTE**

*For the operation of the device, refer to its instruction manual.*

2. Press the pick-up button or talk button with a short press.
3. **Say:** [Beep] “Setup”

4. **Prompt:** “Select one of the following: Pairing options, confirmation prompts, language, passcode, select phone or select music player.”
5. **Say:** [Beep] “Pairing options”
6. **Prompt:** “Available options are: Pair, Edit, Delete, List, or Set Pairing Code.”
7. **Say:** [Beep] “Pair”
8. **Prompt:** “Start the pairing process on your Bluetooth® device. Your pairing code is 0000 (XXXX). Input this on your Bluetooth® device when prompted on the device. See device manual for instructions.”
9. Using the device, perform a search for the Bluetooth® device (Peripheral device).

#### **NOTE**

*For the operation of the device, refer to its instruction manual.*

10. Select “Mazda” from the device list searched by the device.
11. Input the 4-digit pairing code to the device.
12. **Prompt:** “Please say the name of the device after the beep.”
13. **Say:** [Beep] “XXXX - - -” (Speak a “device tag”, an arbitrary name for the device.)  
Example: “Stan's device.”

#### **NOTE**

*Speak a programmed “device tag” within 10 seconds.*

*If more than two devices are to be programmed, they cannot be programmed with the same or similar “device tag”.*

## Bluetooth® Hands-Free (Type A)

14. **Prompt:** “XXXXXX - - - (Ex. “Stan’s device”) (Device tag). Is this correct?”
15. **Say:** [Beep] “Yes”
16. **Prompt:** “Pairing complete”

After a device is registered, the system automatically identifies the device. By activating Bluetooth® Hands-Free again, or by activating Bluetooth® Hands-Free first after switching the ignition from OFF to ACC, the system reads out a voice guidance, “XXXXXX - - - (Ex. “Stan’s device”) (Device tag) is connected”.

### NOTE

- Device registration can also be done by operating the audio unit.  
Refer to Bluetooth® Audio Preparation on page 6-108.
- Depending on the device, the registration status may be lost after a certain period of time. If this occurs, repeat the entire process from Step 1.

### ▼ Making a Call Using a Telephone Number

### NOTE

Practice this while parked until you are confident you can do it while driving in a non-taxing road situation. If you are not completely comfortable, make all calls from a safe parking position, and move out only when fully under control and you can devote your eyes and mind to driving.

1. Press the pick-up button or talk button with a short press.
2. **Say:** [Beep] “Dial”
3. **Prompt:** “Number, please”
4. **Say:** [Beep] “XXXXXXXXXXXX (Telephone number)”

5. **Prompt:** “XXXXXXXXXXXX. (Telephone number) After the beep, continue to add numbers, or say Go-Back to re-enter the last entered numbers, or press the Pick-Up button to execute dialing.”

### 6. (Dialing)

Press the pick-up button or say “Dial”, then go to Step 7.

### (Adding/inputting telephone number)

Say, “XXXX” (desired telephone number), then go to Step 5.

### (Telephone number correction)

Say, “Go Back”. The prompt replies, “Go Back. The last entered numbers have been removed.”. Then go back to Step 3.

### 7. Prompt: “Dialing”

### NOTE

The “Dial” command and a telephone number can be combined.

Ex. In Step 2, say, “Dial 123-4567”, then, Steps 3 and 4 can be skipped.

Interior Comfort

## Bluetooth® Hands-Free (Type A)

### ▼ Receiving an Incoming Call

1. **Prompt:** “Incoming call, press the pickup button to answer”.
2. To accept the call, press the pick-up button.  
To reject the call, press the hang-up button.

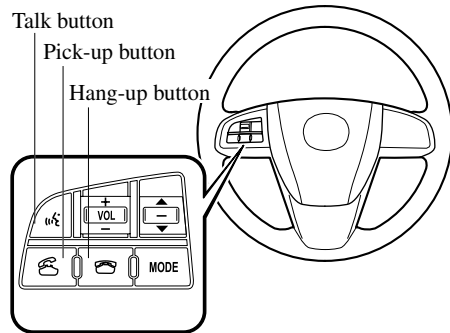

### NOTE

- The volume can also be adjusted using the volume button on the steering wheel.
- The music volume of the audio unit cannot be adjusted while Bluetooth® Hands-Free is being used.

### ▼ Hanging Up a Call

Press the hang-up button during the call.  
A beep sound will confirm that call is ended.

### ▼ Volume Adjustment

The power/volume dial of the audio unit is used to adjust the volume. Turn the dial to the right to increase volume, to the left to decrease it.

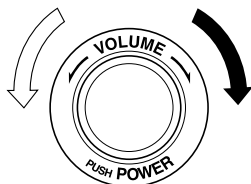



## Bluetooth® Hands-Free (Type A)

### Convenient Use of the Hands-Free System

#### ▼ Phonebook Usage

##### Phonebook registration

Phone numbers can be registered to the Bluetooth® Hands-Free phonebook.

##### **NOTE**

*Do this function only when parked. It is too distracting to attempt while driving and you may make too many errors to be effective.*

1. Press the pick-up button or talk button with a short press.
2. **Say:** [Beep] “Phonebook”
3. **Prompt:** “Select one of the following: New entry, edit, list names, delete, erase all or import contact.”
4. **Say:** [Beep] “New entry”
5. **Prompt:** “Name please.”
6. **Say:** [Beep] “XXXXX... (Ex. “Mary's phone”)” (Say a voice tag for the name registered.)
7. **Prompt:** “Adding XXXXX... (Ex. “Mary's phone”) (Registered voice tag). Is this correct?”
8. **Say:** [Beep] “Yes”
9. **Prompt:** “Home, Work, Mobile, or Other?”
10. **Say:** [Beep] “Mobile” (Say “Home”, “Work”, “Mobile”, or “Other”, for the desired location to be registered.)
11. **Prompt:** “Mobile (Location to be registered). Is this correct?”
12. **Say:** [Beep] “Yes”

13. **Prompt:** “Number, please.”
14. **Say:** [Beep] “XXXXXXXXXXXX” (Say the phone number to be registered.)
15. **Prompt:** “XXXXXXXXXXXX” (Phone number registration). After the beep, continue to add numbers, or say Go-Back to re-enter the last entered numbers, or press the Pick-Up button to save the number.”
16. **(Registration)**  
Press the pick-up button or say “Enter”, then go to Step 17.  
**(Adding/inputting telephone number)**  
Say, “XXXX” (desired telephone number), then go to Step 15.  
**(Telephone number correction)**  
Say, “Go Back”. The prompt replies, “Go Back. The last entered numbers have been removed.”. Then go back to Step 13.
17. **Prompt:** “Number saved. Would you like to add another number for this entry?”
18. **Say:** [Beep] “Yes” or “No”.
19. If “Yes”, an additional phone number registration can be made for the same entry.  
If “No”, the system returns to standby status.

##### **Import contact**

Phonebook data from your device (Mobile phone) can be sent and registered to your Bluetooth® Hands-Free phonebook using Bluetooth®.

1. Press the pick-up button or talk button with a short press.
2. **Say:** [Beep] “Phonebook”

Interior Comfort

## Bluetooth® Hands-Free (Type A)

3. **Prompt:** “Select one of the following:  
New entry, edit, list names, delete,  
erase all or import contact.”
4. **Say:** [Beep] “Import contact”
5. **Prompt:** “Ready to receive a contact  
from the phone.”
6. Device (Mobile phone) operation:  
Select one entry from the phonebook  
and send it using Bluetooth®.
7. **Prompt:** “X (Number of locations  
which include data) numbers have been  
imported. What name would you like  
to use for these numbers?”
8. **Say:** [Beep] “XXXXX... (Ex. “Mary's  
phone”)” (Say a voice tag for the name  
registered.)
9. **Prompt:** “Adding XXXXX... (Ex.  
“Mary's phone”) (Voice tag). Is this  
correct?”
10. **Say:** [Beep] “Yes”
11. **Prompt:** “Number saved. Would you  
like to import another contact?”
12. **Say:** [Beep] “Yes” or “No”
13. If “Yes”, the procedure proceeds to  
Step 5.  
If “No”, the procedure proceeds to  
Step 14.
14. **Prompt:** “Returning to main menu.”

### **Making calls using the phonebook**

Telephone calls can be made by saying  
the name of a person (voice tag) whose  
phone number has been registered in  
Bluetooth® Hands-Free in advance.  
For the phonebook setting method, refer  
to (page 6-129).

1. Press the pick-up button or talk button  
with a short press.

2. **Say:** [Beep] “Call”
3. **Prompt:** “Name please.”
4. **Say:** [Beep] “XXXXX... (Ex. “John's  
phone”)” (Say a voice tag registered in  
the phonebook.)
5. **Prompt:** “Calling XXXXX... (Ex.  
“John's phone”) XXXX (Ex. “at  
home”). Is this correct?” (Voice tag and  
phone number location registered in  
phonebook).
6. **Say:** [Beep] “Yes”
7. **Prompt:** “Dialing”

### **NOTE**

*The “Call” command and the voice tag can be  
combined.*

*Ex. In Step 2, say, “Call John's phone”, then,  
Steps 3 and 4 can be skipped.*

### **▼ Redialing Function**

Redialing the number of the person  
previously dialed using the phone is  
possible.

1. Press the pick-up button or talk button  
with a short press.
2. **Say:** [Beep] “Redial”
3. **Prompt:** “Dialing”

### **▼ Emergency Calls**

A call can be made to the emergency  
phone number (911: U.S.A/Canada, 066:  
Mexico) using the voice input command.  
It may not function properly in some areas  
in Mexico.

1. Press the pick-up button or talk button  
with a short press.
2. **Say:** [Beep] “Emergency”

## Bluetooth® Hands-Free (Type A)

3. - USA/Canada vehicles - **Prompt:** “Dialing “911”, is this correct?”  
- Mexico vehicles - **Prompt:** “Dialing “066”, is this correct?”
4. **Say:** [Beep] “Yes”
5. **Prompt:** “Dialing”

### ▼ Refusing an Incoming Call

For incoming call refusal, refer to “Receiving an incoming call” (page 6-124).

### ▼ Mute

The microphone can be muted during a call.

1. Press the talk button with a short press.
2. **Say:** [Beep] “Mute”
3. **Prompt:** “Microphone muted”

### Canceling mute

1. Press the talk button with a short press.
2. **Say:** [Beep] “Mute off”
3. **Prompt:** “Microphone unmuted”

### ▼ Transferring a Call

#### Transferring a call from Hands-Free to a device (Mobile phone)

Communication between the hands-free unit and a device (Mobile phone) is canceled, and the line can be switched to a standard call using a device (Mobile phone).

1. Press the talk button with a short press.
2. **Say:** [Beep] “Transfer call”
3. **Prompt:** “Transferred call to phone”

#### Transferring a call from a device (Mobile phone) to Hands-Free

Communication between devices (Mobile phone) can be switched to Bluetooth® Hands-Free.

1. Press the talk button with a short press.
2. **Say:** [Beep] “Transfer call”
3. **Prompt:** “Transferred call to Hands Free system”

### ▼ Multi-Call Functions

#### Call waiting

A call can be interrupted to receive an incoming call from a third party.

#### Call interrupt

A call can be switched to a new incoming call.

#### **Method 1**

1. Press the pick-up button.
2. **Prompt:** “Swapping calls.”

#### **Method 2**

1. Press the talk button with a short press.
2. **Say:** [Beep] “Swap calls”
3. **Prompt:** “Swapping calls”

#### **NOTE**

- To refuse an incoming call, press the hang-up button.
- After receiving a new incoming call, the previous call is placed on hold.

#### Switching calls

Switching back to the previous call can also be done.

Interior Comfort

## Bluetooth® Hands-Free (Type A)

---

### Method 1

1. Press the pick-up button.
2. **Prompt:** “Swapping calls.”

### Method 2

1. Press the talk button with a short press.
2. **Say:** [Beep] “Swap calls”
3. **Prompt:** “Swapping calls”

### Three-way call function

1. Press the talk button with a short press.
2. **Say:** [Beep] “Join calls”
3. **Prompt:** “Joining calls”

### Making a call using a telephone number

1. Press the talk button with a short press.
2. **Say:** [Beep] “Dial”
3. **Prompt:** “Number, please”
4. **Say:** [Beep] “XXXXXXXXXXXXX  
(Telephone number)”
5. **Prompt:** “XXXXXXXXXXXXX.  
(Telephone number) After the beep,  
continue to add numbers, or say Go-  
Back to re-enter the last entered  
numbers, or press the Pick-Up button  
to execute dialing.”

### 6. (Dialing)

Press the pick-up button or say “Dial”, then go to Step 7.

### **(Adding/inputting telephone number)**

Say, “XXXX” (desired telephone number), then go to Step 5.

### **(Telephone number correction)**

Say, “Go Back”. The prompt replies, “Go Back. The last entered numbers have been removed.”. Then go back to Step 3.

### 7. **Prompt:** “Dialing”

### Making calls using the phonebook

1. Press the talk button with a short press.
2. **Say:** [Beep] “Call”
3. **Prompt:** “Name please.”
4. **Say:** [Beep] “XXXXX... (Ex. “John's phone”)” (Say a voice tag registered in the phonebook.)
5. **Prompt:** “Calling XXXXX... (Ex. “John's phone”) XXXX (Ex. “at home”). Is this correct?” (Voice tag and phone number location registered in phonebook).
6. **Say:** [Beep] “Yes”
7. **Prompt:** “Dialing”

### Redialing function

1. Press the talk button with a short press.
2. **Say:** [Beep] “Redial”
3. **Prompt:** “Dialing”

### Ending the current call

Press the hang-up button during the call.

## Bluetooth® Hands-Free (Type A)

### ▼ Phonebook Settings

#### Editing phonebook

The data registered to the Bluetooth® Hands-Free phonebook can be edited.

#### **NOTE**

*Do this function only when parked. It is too distracting to attempt while driving and you may make too many errors to be effective.*

1. Press the pick-up button or talk button with a short press.
2. **Say:** [Beep] “Phonebook”
3. **Prompt:** “Select one of the following: New entry, edit, list names, delete, erase all or import contact.”
4. **Say:** [Beep] “Edit”
5. **Prompt:** “Please say the name of the entry you would like to edit or say, “List names”.”
6. **Say:** [Beep] “XXXXX... (Ex. “Mary's phone”)” (Say the voice tag for the registered name to be edited in the phonebook.)
7. **Prompt:** “Home, Work, Mobile, or Other?”
8. **Say:** [Beep] “Home” (Say the registered location to be edited: “Home”, “Work”, “Mobile”, or “Other”).
9. **Prompt:** “XXXXX... (Ex. “Mary's phone”) (Registered voice tag) XXXX (Ex. “Home”) (Registered location). Is this correct?”
10. **Say:** [Beep] “Yes”

11. **Prompt:** “The current number is XXXXXXXXXXXXX (Ex. “555-1234”) (Currently registered number). New number, please.”

#### **NOTE**

*If there was no previous phone number registered to a location (Ex. “Work”), the prompt will only read out “Number, please”.*

12. **Say:** [Beep] “XXXXXXXXXXXX (Ex. “555-5678”)” (Say the new phone number to be registered.)
13. **Prompt:** “XXXXXXXX (Telephone number) After the beep, continue to add numbers, or say Go-Back to re-enter the last entered numbers, or press the Pick-Up button to save the number.”
14. **(Number Change)**  
Press the pick-up button, then go to Step 15.  
**(Adding/inputting telephone number)**  
Say, “XXXX” (desired telephone number), then go to Step 13.  
**(Telephone number correction)**  
Say, “Go Back”. The prompt replies, “Go Back. The last entered numbers have been removed. Number, please.” . Then go back to Step 12.
15. **Prompt:** “Number changed.”

#### Phonebook data deletion

#### **Erasing individual phonebook data**

Individual data registered to the Bluetooth® Hands-Free phonebook can be cleared.

#### **NOTE**

*Do this function only when parked. It is too distracting to attempt while driving and you may make too many errors to be effective.*

Interior Comfort

## Bluetooth® Hands-Free (Type A)

1. Press the pick-up button or talk button with a short press.
2. **Say:** [Beep] “Phonebook”
3. **Prompt:** “Select one of the following: New entry, edit, list names, delete, erase all or import contact.”
4. **Say:** [Beep] “Delete”
5. **Prompt:** “Please say the name of the entry you would like to delete or say, “List names”.”
6. **Say:** [Beep] “XXXXX... (Ex. “John's phone”)” (Say the registered voice tag to be deleted from the phonebook.)
7. **Prompt:** “Deleting XXXXX... (Ex. “John's phone”) (Registered voice tag) Home (Registered location). Is this correct?”
8. **Say:** [Beep] “Yes”
9. **Prompt:** “XXXXX... (Ex. “John's phone”) (Registered voice tag) Home (Registered location) deleted, returning to main menu.”

### **Complete deletion of the phonebook data**

All data registered to the Bluetooth® Hands-Free phonebook can be erased.

#### **NOTE**

*Do this function only when parked. It is too distracting to attempt while driving and you may make too many errors to be effective.*

1. Press the pick-up button or talk button with a short press.
2. **Say:** [Beep] “Phonebook”
3. **Prompt:** “Select one of the following: New entry, edit, list names, delete, erase all or import contact.”

6-130

4. **Say:** [Beep] “Erase all”
5. **Prompt:** “Are you sure you want to erase everything from your Hands Free system phonebook?”
6. **Say:** [Beep] “Yes”
7. **Prompt:** “You are about to delete everything from your Hands Free system phonebook. Do you want to continue?”
8. **Say:** [Beep] “Yes”
9. **Prompt:** “Please wait, erasing the Hands Free system phonebook.”
10. **Prompt:** “Hands-Free system phonebook erased, returning to main menu.”

### **Read-out of names registered to the Bluetooth® Hands-Free phonebook**

Bluetooth® Hands-Free can read out the list of names registered to its phonebook.

1. Press the pick-up button or talk button with a short press.
2. **Say:** [Beep] “Phonebook”
3. **Prompt:** “Select one of the following: New entry, edit, list names, delete, erase all or import contact.”
4. **Say:** [Beep] “List names”
5. **Prompt:** “XXXXX..., XXXXX..., XXXXX... (Ex. “John's phone”, Mary's phone, Bill's phone)” (Voice guidance reads out the voice tags registered to the phonebook.)

Press the talk button with a short press during the read-out at the desired name, and then say one of the following voice commands to execute it.

- “Continue”: Continues the list read-out.

## Bluetooth® Hands-Free (Type A)

- “Call”: Calls the registered phonebook data when the talk button is short-pressed.
  - “Edit”: Edits the registered phonebook data when the talk button is short-pressed.
  - “Delete”: Deletes the registered phonebook data when the talk button is short-pressed.
  - “Previous”: Returns to the previous phonebook data in read-out when the talk button is short-pressed.
6. **Prompt:** “End of list, would you like to start from the beginning?”
  7. **Say:** [Beep] “No”
  8. **Prompt:** “Returning to main menu.”

### ▼DTMF (Dual Tone Multi-Frequency Signal) Transmission

This function is used when transmitting DTMF via the user's voice. The receiver of a DTMF transmission is generally a home telephone answering machine or a company's automated guidance call center (When you send tone signals back according to the voice guidance recording).

1. Press the talk button with a short press.
2. **Say:** [Beep] “XXXX... send” (Say DTMF code)
3. **Prompt:** “Sending XXXX... (DTMF code)”

### Hands-Free Setting

#### ▼ Device

##### Device registration

For the registration of a Bluetooth® equipped device to Bluetooth® Hands-Free.

Refer to Bluetooth® Hands-Free Preparation on page 6-120.

##### Registered device read-out

Bluetooth® Hands-Free can read-out the devices registered to its system.

##### **NOTE**

*Do this function only when parked. It is too distracting to attempt while driving and you may make too many errors to be effective.*

1. Press the pick-up button or talk button with a short press.
2. **Say:** [Beep] “Setup”
3. **Prompt:** “Select one of the following: Pairing options, confirmation prompts, language, passcode, select phone or select music player.”
4. **Say:** [Beep] “Pairing options”
5. **Prompt:** “Available options are: Pair, Edit, Delete, List, or Set Pairing Code”
6. **Say:** [Beep] “List”
7. **Prompt:** “XXXXXX..., XXXXX..., XXXXX... (Ex. Device A, device B, device C)” (The voice guidance reads out the device tags registered to the hands-free system.)

Interior Comfort

## Bluetooth® Hands-Free (Type A)

Press the talk button with a short press during the read-out at the desired device, and then say one of the following voice commands to execute it.

- “Select phone”: Selects device (Mobile phone) when the talk button is short-pressed.
  - “Select music player”: Selects device (Music player) when the talk button is short-pressed.
  - “Edit”: Edits device when the talk button is short-pressed.
  - “Continue”: Continues the list read-out.
  - “Delete”: Deletes the registered device when the talk button is short-pressed.
  - “Previous”: Returns to the previous device in read-out when the talk button is short-pressed.
8. **Prompt:** “End of list, would you like to start from the beginning?”
  9. **Say:** [Beep] “No”
  10. **Prompt:** “Returning to main menu.”

### Device selection

If several devices have been programmed, the Bluetooth® unit links the device last connected. If you would like to link a different programmed device, it is necessary to change the link. The order of device priority after the link has been changed is maintained even when the ignition is switched off.

### **Hands-free phone**

1. Press the pick-up button or talk button with a short press.
2. **Say:** [Beep] “Setup”

3. **Prompt:** “Select one of the following: Pairing options, confirmation prompts, language, passcode, select phone or select music player.”
4. **Say:** [Beep] “Select phone”
5. **Prompt:** “Please say the name of the device you would like to select. Available devices are XXXXX... (Ex. device A), XXXXX... (Ex. device B), XXXXX... (Ex. device C). Which device please?”
6. **Say:** [Beep] “XXXXX... (Ex. Device B)”
7. **Prompt:** “XXXXX... (Ex. Device B). Is this correct?”
8. **Say:** [Beep] “Yes” or “No”
9. If “Yes”, go to Step 10. If “No”, the procedure returns to Step 5.
10. **Prompt:** “XXXXX... (Ex. Device B) selected.”

### **Music player**

1. Press the pick-up button or talk button with a short press.
2. **Say:** [Beep] “Setup”
3. **Prompt:** “Select one of the following: Pairing options, confirmation prompts, language, passcode, select phone or select music player.”
4. **Say:** [Beep] “Select music player”
5. **Prompt:** “Please say the name of the device you would like to select. Available devices are XXXXX... (Ex. device A), XXXXX... (Ex. device B), XXXXX... (Ex. device C). Which device please?”



## Bluetooth® Hands-Free (Type A)

6. **Say:** [Beep] “XXXXX... (Ex. Device B)”
7. **Prompt:** “XXXXX... (Ex. Device B). Is this correct?”
8. **Say:** [Beep] “Yes” or “No”
9. If “Yes”, go to Step 10. If “No”, the procedure returns to Step 5.
10. **Prompt:** “XXXXX... (Ex. Device B) selected.”

### **NOTE**

*Device (Music player) selection can also be done by operating the panel button (page 6-108).*

### **Registered device (Mobile phone) deletion**

Registered devices (Mobile phone) can be deleted individually or collectively.

### **NOTE**

*Do this function only when parked. It is too distracting to attempt while driving and you may make too many errors to be effective.*

1. Press the pick-up button or talk button with a short press.
2. **Say:** [Beep] “Setup”
3. **Prompt:** “Select one of the following: Pairing options, confirmation prompts, language, passcode, select phone or select music player.”
4. **Say:** [Beep] “Pairing options”
5. **Prompt:** “Available options are: Pair, Edit, Delete, List, or Set Pairing Code.”

### **NOTE**

*A registered device (Mobile phone) can be deleted using the registration list.*

6. **Say:** [Beep] “Delete”

7. **Prompt:** “Please say the name of the device you would like to delete. Available devices are XXXXX... (Ex. device A), XXXXX... (Ex. device B), XXXXX... (Ex. device C), or all. Which device please?”

8. **Say:** [Beep] “X” (Say the number of the device to be deleted.)

### **NOTE**

*Say “All” to delete all devices (Mobile phone).*

9. **Prompt:** “Deleting XXXXX... (Ex. device B...) (Registered device tag). Is this correct?”

10. **Say:** [Beep] “Yes”

11. **Prompt:** “Deleted”

### **Registered device editing**

1. Press the pick-up button or talk button with a short press.
2. **Say:** [Beep] “Setup”
3. **Prompt:** “Select one of the following: Pairing options, confirmation prompts, language, passcode, select phone or select music player.”
4. **Say:** [Beep] “Pairing options”
5. **Prompt:** “Available options are: Pair, Edit, Delete, List, or Set Pairing Code.”
6. **Say:** [Beep] “Edit”
7. **Prompt:** “Please say the name of the device you would like to edit. Available devices are XXXXX... (Ex. device A), XXXXX... (Ex. device B), XXXXX... (Ex. device C). Which device please?”
8. **Say:** [Beep] “X” (Say the number of the device to be edited.)
9. **Prompt:** “New name please?”

Interior Comfort

## Bluetooth® Hands-Free (Type A)

10. **Say:** [Beep] “XXXXX... (Ex. device C)” (Speak a “device tag”, an arbitrary name for the device.)
11. **Prompt:** “XXXXX... (Ex. device C) (Device tag), is this correct?”
12. **Say:** [Beep] “Yes”
13. **Prompt:** “New name saved, returning to main menu.”

### ▼ Security Setting

If a passcode is set, the system cannot be activated unless the passcode is input.

#### **NOTE**

*Do this function only when parked. It is too distracting to attempt while driving and you may make too many errors to be effective.*

#### **Passcode setting**

1. Press the pick-up button or talk button with a short press.
2. **Say:** [Beep] “Setup”
3. **Prompt:** “Select one of the following: Pairing options, confirmation prompts, language, passcode, select phone or select music player.”
4. **Say:** [Beep] “Passcode”
5. **Prompt:** “Passcode is disabled. Would you like to enable it?”
6. **Say:** [Beep] “Yes”
7. **Prompt:** “Please say a 4-digit passcode. Remember this passcode. It will be required to use this system.”
8. **Say:** [Beep] “XXXX” (Say a desired 4-digit passcode, “PCode”.)
9. **Prompt:** “Passcode XXXX (Passcode, PCode). Is this correct?”

10. **Say:** [Beep] “Yes”
11. **Prompt:** “Passcode is enabled, returning to main menu.”

#### **Using Bluetooth® Hands-Free with a passcode**

1. Press the pick-up button or talk button with a short press.
2. **Prompt:** “Hands-Free system is locked. State the passcode to continue.”
3. **Say:** [Beep] “XXXX” (Say the set passcode “PCode”.)
4. If the correct passcode is input, voice guidance “XXXXXX... (Ex. “Mary’s device”) (Device tag) is connected” is announced.  
If the passcode is incorrect, voice guidance “XXXX (4-digit passcode, Pcode) incorrect passcode, please try again” is announced.

#### **Canceling the passcode**

#### **NOTE**

*Do this function only when parked. It is too distracting to attempt while driving and you may make too many errors to be effective.*

1. Press the pick-up button or talk button with a short press.
2. **Say:** [Beep] “Setup”
3. **Prompt:** “Select one of the following: Pairing options, confirmation prompts, language, passcode, select phone or select music player.”
4. **Say:** [Beep] “Passcode”
5. **Prompt:** “Passcode is enabled. Would you like to disable it?”
6. **Say:** [Beep] “Yes”

## Bluetooth® Hands-Free (Type A)

7. **Prompt:** “Passcode is disabled, returning to main menu.”

### **Confirmation Prompts**

The confirmation prompt confirms the command content to the user before advancing to the operation requested by the user. When this function is turned on, the system reads out the voice input command previously received and confirms whether the command is correct before advancing to the command execution.

When the confirmation prompt function is turned on:

(Ex. “Calling John's device. Is this correct?”)

When the confirmation prompt function is turned off:

(Ex. “Calling John's device.”)

### ***NOTE***

*If the confirmation prompt function is turned off when making an emergency call, the system reads out and confirms the command before executing it.*

1. Press the pick-up button or talk button with a short press.
2. **Say:** [Beep] “Setup”
3. **Prompt:** “Select one of the following: Pairing options, confirmation prompts, language, passcode, select phone or select music player.”
4. **Say:** [Beep] “Confirmation prompts”
5. **Prompt:** “Confirmation prompts are on/off. Would you like to turn confirmation prompts off/on?”
6. **Say:** [Beep] “Yes”
7. **Prompt:** “Confirmation prompts are off/on, returning to main menu.”

### **▼ Voice Recognition Learning Function (Speaker Enrollment)**

The voice recognition learning function enables voice recognition appropriate to the characteristics of the user's voice.

If the recognition of the voice input commands to the system is not adequate, this function can largely improve the system's voice recognition of the user. If your voice can be recognized sufficiently without using this function, you may not realize the added benefit of the function.

To register your voice, the voice input command list must be read out. Read out the list when the vehicle is parked. Perform the registration in as quiet a place as possible (page 6-118).

The registration must be performed completely. The required time is a few minutes. The user needs to be seated in the driver's seat with the voice input command list for voice recognition learning open to the page indicated below.

### **When voice recognition learning is done for the first time**

1. Press the pick-up button or talk button with a short press.
2. **Say:** [Beep] “Voice training”
3. **Prompt:** “This operation must be performed in a quiet environment while the vehicle is stopped. See the owner's manual for the list of required training phrases. Press and release the talk button when you are ready to begin. Press the hangup button to cancel at any time.”
4. Press the talk button with a short press.

Interior Comfort

## Bluetooth® Hands-Free (Type A)

5. The voice guidance reads out the voice input command number (refer to the voice input command list for voice recognition learning). (Ex. “Please read phrase 1”)
6. **Say:** [Beep] “0123456789” (Say the voice input command for voice recognition learning (1 to 8) according to the voice guidance.)
7. **Prompt:** “Speaker enrollment is complete, returning to main menu.”

### NOTE

If an error occurred in the voice recognition learning, re-learning can be done by pressing the talk button with a short press.

### Voice recognition re-learning

If voice recognition learning has already been done.

1. Press the pick-up button or talk button with a short press.
2. **Say:** [Beep] “Voice training”
3. **Prompt:** “Enrollment is enabled/ disabled. Would you like to disable/ enable or retrain?”
4. **Say:** [Beep] “Retrain”
5. **Prompt:** “This operation must be performed in a quiet environment while the vehicle is stopped. See the owner's manual for the list of required training phrases. Press and release the talk button when you are ready to begin. Press the hangup button to cancel at any time.”
6. Press the talk button with a short press.

7. The voice guidance reads out the voice input command number (refer to the voice input command list for voice recognition learning). (Ex. “Please read phrase 1”)
8. **Say:** [Beep] “0123456789” (Say the voice input command for voice recognition learning (1 to 8) according to the voice guidance.)
9. **Prompt:** “Speaker enrollment is complete, returning to main menu.”

### NOTE

If an error occurred in the voice recognition learning, re-learning can be done by pressing the talk button with a short press.

### Voice input command list for voice recognition learning

When reading out, the following points must be observed:

- Read out the numbers one at a time correctly and naturally.

(For example, “1234” must be read out “one, two, three, four”, not “twelve, thirty four”.)

- Do not read out parentheses. “(” and hyphens “-” are used for separating numbers in a phone number.

Ex.

“(888) 555-1212” must be spoken “Eight, eight, eight, five, five, five, one, two, one, two.”

| Phrase | Command        |
|--------|----------------|
| 1      | 0123456789     |
| 2      | (888) 555-1212 |
| 3      | Call           |
| 4      | Dial           |
| 5      | Setup          |
| 6      | Cancel         |
| 7      | Continue       |
| 8      | Help           |

## Bluetooth® Hands-Free (Type A)

### NOTE

- *The applicable phrase appears in the display.*
- *After user voice registration is completed, voice guidance “Speaker enrollment is complete, returning to main menu” is announced.*

### **Voice recognition learning on/off**

1. Press the pick-up button or talk button with a short press.
2. **Say:** [Beep] “Voice training”
3. **Prompt:** “Enrollment is enabled/disabled. Would you like to disable/enable or retrain?”
4. **Say:** [Beep] “Disable” or “Enable”
5. When “Disable” is spoken, the voice recognition learning is turned off. When “Enable” is spoken, the voice recognition learning is turned on.
6. **Prompt:** “Speaker Enrollment is disabled/enabled, returning to main menu.”

### **When Bluetooth® Hands-Free Cannot be Used**

Bluetooth® Hands-Free cannot be used under the following conditions:

- The device is outside of the communication area.
- The device has a malfunction.
- The device is not connected to the hands-free unit equipped on the vehicle.
- The device's battery is weak.
- The device is turned off.
- The device is placed where radio reception is difficult.
- The ignition is switched off.

Interior Comfort

## Bluetooth® Hands-Free (Type A)

### Safety Certification

FCC ID: CB2MBLUEC09 IC:279B-MBLUEC09

This device complies with Part 15 of the FCC Rules and with RSS-210 of Industry Canada. Operation is subject to the following two conditions:

- (1) This device may not cause harmful interference, and
- (2) This device must accept any interference received, including interference that may cause undesired operation.

### WARNING

*Changes or modifications not expressly approved by the party responsible for compliance could void the user's authority to operate the equipment.*

The term "IC:" before the radio certification number only signifies that Industry Canada technical specifications were met.

The antenna used for this transmitter must not be co-located or operating in conjunction with any other antenna or transmitter. End-users and installers must be provided with installation instructions and transmitter operating conditions for satisfying RF exposure compliance.

### Mazda Bluetooth® Hands-Free Customer Service

- U.S.A.  
Phone: 800-430-0153 (Toll-free)  
[www.MazdaUSA.com/bluetooth](http://www.MazdaUSA.com/bluetooth)
- Canada  
Phone: 800-430-0153 (Toll-free)  
[www.mazdahandsfree.ca](http://www.mazdahandsfree.ca)
- Mexico  
Center of Attention to Client (CAC)  
Phone: 01-800-01-MAZDA (Toll-free)  
Web: [www.mazdamexico.com.mx](http://www.mazdamexico.com.mx)

6-138

Form No.8CV6-EA-12H

Interior Comfort

## Bluetooth® (Type B)

### Bluetooth® \*

#### **Bluetooth® Hands-Free outline**

When a Bluetooth® device (mobile phone) is connected to the vehicle's Hands-Free unit via radio wave transmission, a call can be made or received by pressing the talk button, pick-up button, hang-up button, or voice command on the steering wheel, or by operating the panel. For example, even if a device (mobile phone) is in your coat pocket, a call can be made without taking the device (mobile phone) out and operating it directly.

#### **Bluetooth® audio outline**

When a portable audio unit equipped with the Bluetooth® communication function is programmed to the Bluetooth® unit, you can listen to music recorded on the programmed portable audio device from the vehicle's speakers. It is not necessary to connect the portable audio device to the vehicle's external input terminal. After programming, operate the vehicle audio control panel to play/stop the audio.

#### **Applicable Bluetooth® specification**

Ver. 2.0 or higher

#### **Response profile**

- HFP (Hands-Free Profile) Ver. 1.5
- DUN (Dial-up Networking Profile) Ver. 1.1
- PBAP (Phone Book Access Profile) Ver. 1.0
- OPP (Object Push Profile) Ver. 1.1
- MAP (Message Access Profile) Ver. 1.0

\*Some models. **6-139**

Interior Comfort

## Bluetooth® (Type B)

### ▼ Component Parts

Audio unit

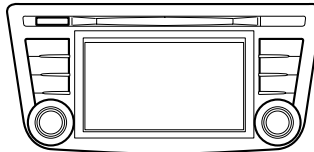

Talk button, Pick-up button and Hang-up button

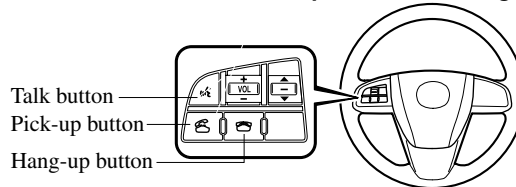

Microphone

(With moonroof)



(Without moonroof)

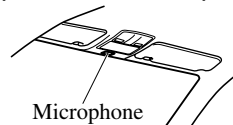

#### **Audio unit**

The audio unit is used for volume adjustment and touch panel operation. Bluetooth® information is displayed in the display. The screen is switched by touching the tab for each function to be used.

Do not press the panel strongly or press it with a sharp-pointed object.

#### **Microphone (Hands-Free)**

The microphone is used for speaking voice commands or exchanging conversation.

#### **Talk button, Pick-Up button and Hang-Up button (Hands-Free)**

The basic functions of Bluetooth® Hands-Free can be used for such things as making calls or hanging up using the talk button, pick-up button and hang-up button on the steering wheel.

#### **Volume adjustment**

The power/volume dial of the audio unit is used to adjust the volume. Turn the dial to the right to increase volume, to the left to decrease it.



The volume can also be adjusted using the volume button on the steering wheel.



Interior Comfort

## Bluetooth® (Type B)

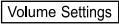
Conversation volume and the volume of the voice guidance and ringtone can each be set in advance.

1. Touch the  on-screen tab to display the Bluetooth® setting screen.
2. Touch the  on-screen button to display the volume adjustment screen.
3. **(Volume up)** Touch the  on-screen button.  
**(Volume down)** Touch the  on-screen button.
4. **Prompt:** “Phone call will be at this volume.” or  
“Voice guidance will be at this volume.”

### NOTE

The volume of the audio unit cannot be adjusted while Bluetooth® Hands-Free is being used.

### ▼ Bluetooth® Preparation

#### Device programming (Pairing)

To use Bluetooth® audio and Hands-Free, the device equipped with Bluetooth® has to be programmed to the unit using the following procedure. A maximum of seven devices including Bluetooth® audio devices and Hands-Free mobile phones can be programmed.

### NOTE



- For your safety, a device can be programmed only when the vehicle is parked. If the vehicle starts to move, the pairing procedure will end. Park the car in a safe place before programming.
- The communication range of a Bluetooth® equipped device is about 10 meters (32 ft) or less.

### ⚠ CAUTION

Some Bluetooth® mobile devices are not compatible with the vehicle. Consult an Authorized Mazda Dealer, Mazda's call center or Web support center for information regarding Bluetooth® mobile device compatibility:

- **U.S.A.**  
Phone: 800-430-0153  
Web: [www.MazdaUSA.com/bluetooth](http://www.MazdaUSA.com/bluetooth)
- **Canada**  
Phone: 800-430-0153  
Web: [www.mazdahandsfree.ca](http://www.mazdahandsfree.ca)

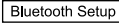
### Pairing Procedure

1. Touch the  on-screen tab.
2. Touch the  on-screen button. The list of pairing devices is displayed.
3. Touch the  on-screen button to display the message and switch to the device operation.
4. Using your device, perform a search for the Bluetooth® device (Peripheral device).

Interior Comfort

## Bluetooth® (Type B)

5. Select “Mazda” from the device list searched by the device.
6. **(Device with Bluetooth® version 2.0)**  
Input the displayed 4-digit pairing code into the device.  
**(Device with Bluetooth® version 2.1 or higher)**
  - **Just Works is detected**  
The pairing is performed automatically.
  - **Numeric Comparison is detected**  
Make sure the displayed 6-digit code on the audio is also displayed on the device, and touch the  on-screen button. A connection license agreement may be required depending on the device.
7. **(Device with PBAP profile)**  
Call history (incoming/outgoing history) for the device is downloaded automatically. The operation may be required depending on the device.

After a device is registered, the system automatically identifies the device. By activating Bluetooth® Hands-Free again, or by activating Bluetooth® Hands-Free first after switching the ignition from OFF to ACC, the device connection condition is indicated in the display.





### Device selection

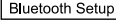

If several devices have been programmed, the Bluetooth® unit links the device last programmed. If you would like to link a different programmed device, it is necessary to change the link. The order of device priority after the link has been changed is maintained even when the ignition is switched off.

### **NOTE**



*If the device name cannot be displayed, “...” is added at the end of the title which is displayed.*

### **Connecting other devices**

1. Press the phone button (**PHONE**).
2. Touch the  on-screen tab.
3. Touch the  on-screen button.
4. Touch the device name which you want to connect to display the device information screen.
5. Touch the  on-screen button to connect as a Hands-Free device. Touch the  on-screen button to connect as a Bluetooth® audio device.
6. Touch the  on-screen button.
7. **(Device with PBAP profile)**  
Call history (incoming/outgoing history) for the device is downloaded automatically.

If the connection is completed, the device name is displayed. Touch the  on-screen button to display the device list screen and display the  or  icon in the new device name which is connected.

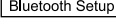

### **Disconnecting a device**

1. Touch the  on-screen tab.
2. Touch the  on-screen button.
3. Touch the device name which is currently connected to display the device information screen.
4. Touch the  on-screen button to disconnect the Hands-Free device. Touch the  on-screen button to disconnect the audio device.

## Bluetooth® (Type B)

5. Touch the  on-screen button.

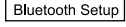
### **Deleting a device**



1. Touch the  on-screen tab.
2. Touch the  on-screen button.
3. Touch the device name which you want to delete.
4. Touch the  on-screen button.
5. Touch the  on-screen button.

### ***NOTE***

*If you want to delete all of the pairing devices, restores default.*

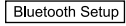

### **Changing PIN code**

PIN code (4 digits) can be changed.

1. Touch the  on-screen tab.
2. Touch the  on-screen button.
3. Touch the  on-screen button.
4. Delete the PIN code which is currently set.
5. Input the new PIN code to be set.
6. Touch the  on-screen button.

### **Restoring Defaults**

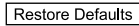
All the pairing device information and phonebook data can be deleted.

1. Touch the  on-screen tab.
2. Touch the  on-screen button.
3. Touch the  on-screen button.
4. Touch the  on-screen button.

### **▼ Available Language**

The Bluetooth® Hands-Free System applies to the following languages:

- English
- Spanish
- French

Refer to Setup on page 6-81.

### **▼ Voice Recognition**

The Mazda Bluetooth® Hands-free system can be used to make calls or operate the audio unit using voice recognition which includes numerous convenient commands. In this section, the basic operation of the voice recognition is explained.

### **Activating Voice Recognition**

To Activate the Main Menu: Press the talk-button.

To Activate the Phone Menu: Press the pick-up button, or after activating the main menu, say “Phone”.

To Activate the Navi Menu: After activating the main menu, say “Navigation”.

### ***NOTE***

- *When activating the Phone Menu from the Main Menu, the user is informed of the available options (Call, Dial, Redial, Call back, Setup or Emergency) via voice navigation.*
- *For voice recognition details with the navigation system, refer to the separate “NAVIGATION SYSTEM Owner’s Manual”.*

### **Ending Voice Recognition**

Use one of the following methods:

- Press and hold the talk-button.
- Press the hang-up button.

Interior Comfort

## Bluetooth® (Type B)

### **Skipping Voice Guidance (for faster operation)**

Press and release the talk-button.

#### **NOTE**

- *The Bluetooth® Hands-Free system is operable several seconds after the ignition is switched to ACC or ON (requires less than 15 seconds).*
- *When operating the audio unit or the A/C while using Bluetooth® Hands-Free, the beep sounds or voice guidance (audio unit)/ cannot be heard.*

#### **Tutorial**

The tutorial explains how to use Bluetooth® Hands-Free.

The available tutorial items are General, Phone, and Audio.

To activate the tutorial, do the following:

1. Press the talk button.
2. **Prompt:** “Ready”
3. **Say:** [Beep] “Tutorial”
4. **Prompt:** “Tutorial”
5. **Say:** [Beep]  
“XXXXX... (Tutorial item)”
6. Follow the prompts to receive the appropriate voice guidance instructions.

### **Commands useable anytime during voice recognition**

“Help”, “Go Back”, “Cancel”, “Display OFF/Display ON” are commands which can be used at anytime during voice recognition.

### **Help function use**

The help function informs the user of all the available voice commands under the current conditions.

1. **Say:** [Beep] “Help”
2. Follow the prompts to receive the appropriate voice guidance instructions.

### **Returning to previous operation**

This command is for returning to the previous operation while in the voice recognition mode.

**Say:** [Beep] “Go Back”

### **Cancel**

The Bluetooth® Hands-Free system transitions to standby status if the following operation is performed while the system is activated.

**Say:** [Beep] “Cancel”

### **Display OFF/Display ON**

The audio unit display can be switched off/on by voice recognition operation.

**Say:** [Beep] “Display OFF” (or “Display ON”)

### **To prevent a deterioration in the voice recognition rate and voice quality, the following points should be observed:**

- The Hands-free system cannot perform voice recognition while voice guidance or a beep sound is operating. Wait until the voice guidance or the beep sound is finished before saying your commands.
- Dialects or different wording other than Hands-Free prompts cannot be recognized by voice recognition. Speak in the wording specified by the voice commands.

## Bluetooth® (Type B)

- It is not necessary to face the microphone or approach it. Speak the voice commands while maintaining a safe driving position.
- Do not speak too slow or too loud.
- Speak clearly, without pausing between words or numbers.
- Close the windows and/or the moonroof to reduce loud noises from outside the vehicle.
- Turn down the airflow of the air-conditioning system while Bluetooth® Hands-Free is being used.
- Make sure the vents are not directing air up towards the microphone.

### NOTE

*If the voice recognition performance is not satisfactory.  
Refer to Troubleshooting on page 6-168.*

## Bluetooth® Hands-Free

### ▼ Making a Call

#### Phonebook Usage

Telephone calls can be made by saying the contact name in the downloaded phonebook or the name of a person whose phone number has been registered in the Bluetooth® Hands-Free. Refer to Import contact (Download Phonebook).

1. Press the pick-up button.
2. **Prompt:** “Ready”
3. **Say:** [Beep] “Call”
4. **Prompt:** “Name, please.”
5. **Say:** [Beep] “XXXXX... (Ex. “John”)  
(Say a name registered in the phonebook.)  
The name spoken will be searched for in the phonebook.  
If a contact is matched, go to Step 7.  
If multiple contacts are matched, go to Step 6.
6. **Prompt:**  
“Would you like to call XXXXX...  
(Choice 1)?”  
**(Person you would like to call)**  
**Say:** [Beep] “Yes.” Then go to Step 7.  
**(Person you do not want to call)**  
**Say:** [Beep] “No” Then go to Step 6  
(Maximum 3 times)
7. **Prompt:**  
“Would you like to call XXXXX... (Ex. “John”) at home, at work, or mobile, or other... or press the hang-up button to exit Hands-Free mode.”
8. **Say:** [Beep]  
“XXXXX... (Ex. “at home”)”

Interior Comfort

## Bluetooth® (Type B)

9. **Prompt:** “XXXXXX... (Ex. “John”) XXXX (Ex. “at home”). Press the pick-up button to call, or say Go Back to enter a different name.”
10. **(Dialing)** Press the pick-up button or say “Call”. Then go to Step 11. **(Name correction)** Say, “Go Back”. Then go back to Step 4.
11. The call is made.

### NOTE



The “Call” command, Name in the phonebook, and Location can be combined. Ex. In Step 3, say, “Call John’s phone”, then, Steps 4 and 5 can be skipped.

### Screen operation

1. Touch the  on-screen tab to display the phonebook screen.
2. Touch the contact you would like to call to display the details for the contact.
3. Touch the desired phone number to make the call.

### Import contact (Download Phonebook)

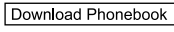
Phonebook data from your device (Mobile phone) can be sent and registered to your Bluetooth® Hands-Free phonebook using Bluetooth®.

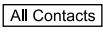

1. Touch the  on-screen tab.
2. Touch the  on-screen button.
3. Touch the  or  on-screen button to switch to the device operation.

### NOTE

- If the phonebook has been already registered to the Hands-Free unit, the current phonebook is overwritten during “all phonebooks download”.
- A maximum of 1000 contacts can be registered to the phonebook.
- Phonebook, incoming/outgoing call record, and speed dialing memory are exclusive to each mobile phone to protect privacy.

4. Download will be started from the mobile phone.

### Phonebook data deletion

1. Touch the  on-screen tab.
2. Touch the contact information which you want to delete.
3. Touch the  on-screen button.

### Call History Usage

A call can be made using the call history (incoming/outgoing history) downloaded from the mobile phone (Redial/Call back). The call history is downloaded automatically when connecting or pairing the Hands-Free and mobile phone.

### NOTE

If an anonymous call is received, the phone number displayed in the Incoming Call History may be random numbers. This is because a mobile phone sends random numbers to the vehicle. In this case, please be aware that the Redial and Call back functions below may not operate.

### Redial Function

This voice command makes a call to the last person you called (either from your mobile phone or from the vehicle).

1. Press the pick-up button.

## Bluetooth® (Type B)

2. **Prompt:** “Ready”
3. **Say:** [Beep] “Redial”
4. A call is made to the most recent call in the Call history (outgoing).

### **Call back Function**



This voice command makes a call to the last person who called you.

1. Press the pick-up button.
2. **Prompt:** “Ready”
3. **Say:** [Beep] “Call back”
4. A call is made to the most recent call in the Call history (incoming).

### **Speed Dial Function**

A maximum of eight telephone numbers can be registered. It will take less time to make a call after registering the telephone number. In addition, you do not have to look for the person you want to call in the phonebook.

### **Speed Dial registration from phonebook**





1. Touch the  on-screen tab.
2. Touch the  on-screen button.
3. Touch the contact you would like to register to the speed dial.
4. Touch the telephone number you would like to register.
5. Verify that the registered name and telephone number are displayed in the phonebook, and touch the  on-screen button.

### **Making calls using the Speed Dial**





1. Touch the  on-screen tab.

2. Touch the contact information you would like to call.

### **Changing contact**

1. Touch the  on-screen tab.
2. Touch the  on-screen button.
3. Touch the  on-screen button.
4. Touch the contact you would like to register to the speed dial.
5. Touch the telephone number you would like to register.
6. Verify that the registered name and telephone number are displayed in the phonebook, and touch the  on-screen button.

### **Speed Dial contact deleting**

1. Touch the  on-screen tab.
2. Touch the  on-screen button for the contact you would like to delete.
3. Touch the  on-screen button to display the confirmation screen.
4. Touch the  on-screen button.

### **Telephone Number Input**

#### **NOTE**

*Practice this while parked until you are confident you can do it while driving in a non-taxing road situation. If you are not completely comfortable, make all calls from a safe parking position, and only start driving when you can devote your full attention to driving.*

1. Press the pick-up button.
2. **Prompt:** “Ready”
3. **Say:** [Beep] “Dial”
4. **Prompt:** “Number, please”

Interior Comfort

## Bluetooth® (Type B)

5. **Say:** [Beep]  
“XXXXXXXXXXXX (Ex. “5551234”)  
(Telephone number)”
6. **Prompt:**  
“XXXXXXXXXXXX. (Ex “5551234”)  
(Telephone number (first choice))”
7. **Prompt:**  
“Press the pick-up button to dial, or  
continue to add numbers. You can also  
say ‘Option A’ or ‘Option B’ to replace  
the last block of digits with the  
displayed alternate, or say ‘Go Back’ to  
delete the last block of digits.”

### **NOTE**

*Option A is the second candidate, Option B is  
the third, and they may not be presented  
depending on the conditions.*

8. **(Dialing)**  
Press the pick-up button or say, “Dial”,  
then go to Step 9.  
**(Adding/inputting telephone  
number)**  
Say, “XXXX” (desired telephone  
number). Then go to Step 5.  
**(The last recognized telephone  
number is replaced by Option A or  
B)**  
Say, “Option A” or “Option B”. Then  
go to Step 6.  
**(Telephone number correction)**  
Say, “Go Back”. The prompt replies,  
“The last entered numbers have been  
removed”. Then go back to Step 4 or  
Step 7.

9. The call is made.



### **NOTE**

*For the faster operation, the “Dial” command  
and a telephone number can be combined.  
Ex. In Step 3, say, “Dial 1234567”, then, Steps  
4 and 5 can be skipped.*

### **Screen operation**

1. Input the telephone number using the  
numerical keypad.
2. Touch the  on-screen button to  
make the call.

### **Numeral or symbol entry**

Use the numerical keypad.  
Long-press the  on-screen button to  
input + .  
Touch the  on-screen button to delete  
the currently input value.

### **Emergency calls**

A call can be made to the emergency  
phone number (911) using the voice input  
command.

1. Press the pick-up button.
2. **Prompt:** “Ready”
3. **Say:** [Beep] “Emergency”
4. **Prompt:**  
“Press the Pick-Up button to dial the  
Emergency number.”
5. (Dialing) Press the pick-up button or  
say “Call.”
6. **Prompt:** “Dialing 911.”

### **Automatic 911**

If the air bags are deployed, a call is made  
automatically to 911 from the connected  
device.

1. If the air bags are deployed,  
notification of the call made to 911 is  
made via audio and screen display. To  
cancel the call, press the  on-  
screen button or hang-up button within  
10 seconds.



## Bluetooth® (Type B)

2. If the  on-screen button or hang-up button is not pressed within 10 seconds, the call is made to 911 automatically.

### NOTE

*A Hands-free device must be paired and connected. The 911 operator can verify the vehicle's position information using the Hands-free device GPS if equipped.*





*The 911 operator can verify the vehicle's position information.*

### (Switching automatic 911 on and off)

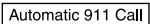

The system can be set to not call 911 if the air bags deploy.

### CAUTION

*Though the system can be set to not call 911, doing so will defeat the purpose of the system to immediately contact rescue personnel to assist you after your accident. For the safety of the driver and all passengers, Mazda recommends that the Automatic 911 system remain activated so that a call will be made to 911 when needed.*

1. Touch the  on-screen tab.
2. Touch the  on-screen button.
3. Touch the  on-screen button or  on-screen button.
4. Touch the  on screen button.

### ▼ Receiving an Incoming Call

1. **Prompt:**  
“Incoming call, press the pick-up button to answer”
2. To accept the call, press the pick-up button or touch the  on-screen button.  
To reject the call, press the hang-up button or touch the  on-screen button.

### NOTE



*To stop receiving phone calls, turn the Don't Disturb Me function on.*

### ▼ Hanging Up a Call

Press the hang-up button or touch the  on-screen button during the call.

### ▼ Mute

The microphone can be muted during a call.

Touch the  on-screen button.  
Touch the  on-screen button during mute to cancel the mute.

### ▼ Transferring a call from Hands-Free to a mobile phone

Communication between the Hands-free unit and a device (Mobile phone) is canceled, and the line can be switched to the device (Mobile phone) as a standard call.

Touch the  on-screen button.

### NOTE

*If the ignition is switched off during a Hands-Free call, the line is transferred to the device (Mobile phone) automatically.*

Interior Comfort

## Bluetooth® (Type B)

### ▼ Transferring a call from a device (mobile phone) to Hands-Free

Communication between devices (mobile phone) can be switched to Bluetooth® Hands-Free.

Touch the  on-screen button.

### ▼ Call interrupt

A call can be interrupted to receive an incoming call from a third party.

To switch to a new incoming call.

Touch the  on-screen button or press the pick-up button on the steering wheel.

#### NOTE

- After receiving a new incoming call, the previous call is placed on hold.
- Touch the  on-screen button or press the hang-up button on the steering wheel to refuse a call.

### Switching between calls

Touch the  on-screen button or press the pick-up button on the steering wheel.

### Three-way call function

Touch the  on-screen button.

### ▼ DTMF (Dual Tone Multi-Frequency Signal) Transmission

This function is used when transmitting DTMF via the Numerical Keypad. The receiver of a DTMF transmission is generally a home telephone answering machine or a company's automated guidance call center.

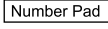
1. Touch the  on-screen button after connecting to a home device or service to display the tone transmission screen.

2. Input the number using a numerical keypad.

#### NOTE

If the DTMF code has two or more digits or symbols, each one must be transmitted individually.

### ▼ Receiving and Replying to Messages (only MAP 1.0)

SMS (Short Message Service) messages and MMS (Multimedia Messaging Service) messages received by a connected device can be downloaded, displayed, and played (read by the system).

Additionally, replies can also be made to calls and messages in the received messages.

### Downloading messages

Up to 15 new messages can be downloaded and displayed from a connected device.

1. Touch the  on-screen tab.
2. Touch the  on-screen button.

#### NOTE

- Messages that have not been read are downloaded first.
- Attached data is not downloaded.
- Messages up to 160-bytes can be downloaded.
- A message list is created for each device.
- If there are unread messages, the receive icon is displayed.
- If the connected device does not correspond to MAP 1.0, the AT command is used to download. The downloaded message indicates that it is already read.
- Downloading using the AT command may not function depending on the connected device.

Interior Comfort  
**Bluetooth® (Type B)**

**Receiving messages**

When a device receives a message, a message received notification is displayed.

When the **Download Now** on-screen button is touched, the message is downloaded.

**NOTE**

*To not display the message received notification, turn on the Don't Disturb Me function.*

**Displaying messages**

1. Touch the **Message** on-screen tab.
2. Touch the message you want to display.

**NOTE**

- Touch the **Next** on-screen button to display the next message, and press the **Previous** on-screen button to display the previous message.
- When the **Read** on-screen button is pressed, the message content is played (read by the system).

**Message playback**

1. Touch the **Message** on-screen tab.
2. Touch the message you want to have played (read) back.
3. Touch the **Read** on-screen button.

**NOTE**

*To stop the message playback, touch the **Stop** on-screen button.*

**Calling a person who sent a message**

Calls can be made to persons sending SMS and MMS messages.

1. Touch the **Message** on-screen tab.
2. Touch the message to which you want to make a call.

3. Touch the **Call** on-screen button.

**NOTE**

*Calls cannot be made to persons who have sent e-mail.*

**Replying to messages**

Replies to received messages can be sent by selecting from the stored preset messages.

1. Touch the **Message** on-screen tab.
2. Touch the message to which you want to reply.
3. Touch the **Reply** on-screen button.
4. Select the sentence to be sent from the preset messages.
5. Press the **Send** on-screen button.

**NOTE**

*The preset messages cannot be changed.*

**Erasing messages**

Downloaded messages can be erased.

1. Touch the **Message** on-screen tab.
2. Touch the message you want to erase.
3. Touch the **Delete** on-screen button.
4. Touch the **Yes** on-screen button.

**NOTE**

*The messages stored in a device cannot be erased.*



**▼ Don't Disturb Me function**

A setting can be made to not notify you of incoming phone calls and messages.

1. Touch the **Setup** on-screen tab.
2. Touch the **Don't Disturb me** on-screen button.

Interior Comfort

## Bluetooth® (Type B)

3. To set, touch the  on-screen button or the  on-screen button.
4. Touch the  on screen button.

### NOTE

The following operations are possible even when the Don't Disturb Me function is on.

- Downloading messages
- Downloading phone books
- Downloading the incoming/outgoing call record
- Sending messages

### ▼ Audio Operation Using Voice Recognition

Audio on/off, audio mode switching, and audio operations can be done using voice recognition.

### NOTE

*(When playing a USB or iPod)*

*When a track is selected using voice recognition, the track list is set to VR Playlist.*

### Starting the audio

The audio can be started using voice recognition.

1. Press the talk button.
2. **Prompt:** “Ready”
3. **Say:** [Beep] “Turn on audio”
4. Power to the audio is turned on.

### Turning off the audio

1. Press the talk button.
2. **Prompt:** “Ready”
3. **Say:** [Beep] “Change mode”

4. **Prompt:** “Available audio modes are: AM, FM, FM1, FM2, Sirius, Sirius1, Sirius2, Sirius3, USB, iPod, Bluetooth® audio, Pandora®, CD, AUX, Turn off audio”

5. **Say:** [Beep] “Turn off audio”

6. Power to the audio is turned off.

### Switching modes

1. Press the talk button.

2. **Prompt:** “Ready”

3. **Say:** [Beep] “Change mode”

4. **Prompt:** “Available audio modes are: AM, FM, FM1, FM2, Sirius, Sirius1, Sirius2, Sirius3, USB, iPod, Bluetooth® audio, Pandora®, CD, AUX, Turn off audio”

5. **Say:** [Beep] “XXX (Ex. “AM”) (audio source)”

6. The audio source is switched.

### NOTE

*CD, SIRIUS digital satellite radio, USB, iPod, BT audio, and Pandora® modes cannot be selected in the following cases:*

- SIRIUS digital satellite radio unit, USB device, iPod, BT audio, or Pandora® unit is not equipped on the audio system.
- CD has not been inserted.

*The AUX mode is locked out unless you connect a commercially available portable audio unit (such as an MP3 player) to the auxiliary jack. Connect a portable audio unit or similar product on the market to the auxiliary jack to listen to music or audio over the vehicle's speakers.*

## Bluetooth® (Type B)

### **Playing selected track numbers**

#### **(When playing a CD)**

A desired track number on a CD can be played using voice recognition. Refer to Operating the Compact Disc (CD) Player on page 6-78.

1. Press the talk button.
2. **Prompt:** “Ready”
3. **Say:** [Beep] “Play track”
4. **Prompt:**  
“What track number would you like to play?”
5. **Say:** [Beep] “XXX (Ex. “15”) (Track number)”
6. The selected track number is played.

### **Playing selected artist**

#### **(When playing a USB or iPod)**

Tracks from a desired artist on a USB device or iPod can be played using voice recognition. Refer to How to use USB mode (Type B) on page 6-94. Refer to How to use iPod mode (Type B) on page 6-102.

1. Press the talk button.
2. **Prompt:** “Ready”
3. **Say:** [Beep] “Play”
4. **Prompt:**  
“Would you like to play by Artist, Album, Playlist, or Genre?”
5. **Say:** [Beep] “Artist”
6. **Prompt:**  
“What artist would you like to play?”
7. **Say:** [Beep]  
“XXXXXX... (Ex. “Michael”) (Artist name)”

8. The name spoken will be searched for in the USB device or iPod. If a contact is matched, go to Step 10. If multiple contacts are matched, go to Step 9.

#### 9. **Prompt:**

“Would you like to play XXXXX... (Choice 1)?”

#### **(Artist you would like to play)**

**Say:** [Beep] “Yes.” Then go to Step 10.

#### **(Artist you do not want to play)**

**Say:** [Beep] “No.” Then go to Step 9. (Maximum 3 times)

10. The tracks for the selected artist are played.

### **Playing selected album**

#### **(When playing a USB or iPod)**

The tracks from a desired album on a USB device or iPod can be played using voice recognition. Refer to How to use USB mode (Type B) on page 6-94. Refer to How to use iPod mode (Type B) on page 6-102.

1. Press the talk button.
2. **Prompt:** “Ready”
3. **Say:** [Beep] “Play”
4. **Prompt:**  
“Would you like to play by Artist, Album, Playlist, or Genre?”
5. **Say:** [Beep] “Album”
6. **Prompt:**  
“What album would you like to play?”
7. **Say:** [Beep] “XXXXXX... (Ex. “I am”) (Album name)”

Interior Comfort

## Bluetooth® (Type B)

8. The name spoken will be searched for in the USB device or iPod.  
If a contact is matched, go to Step 10.  
If multiple contacts are matched, go to Step 9.
9. **Prompt:**  
“Would you like to play XXXXX... (Choice 1)?”  
**(Album you would like to play)**  
**Say:** [Beep] “Yes.” Then go to Step 10.  
**(Album you do not want to play)**  
**Say:** [Beep] “No.” Then go to Step 9.  
(Maximum 3 times)
10. The tracks from the selected album are played.

### Playing selected playlist

#### **(When playing a USB or iPod)**

The tracks from a desired playlist on a USB device or iPod can be played using voice recognition.

Refer to How to use USB mode (Type B) on page 6-94. Refer to How to use iPod mode (Type B) on page 6-102.

1. Press the talk button.
2. **Prompt:** “Ready”
3. **Say:** [Beep] “Play”.
4. **Prompt:**  
“Would you like to play by Artist, Album, Playlist, or Genre?”
5. **Say:** [Beep] “Playlist”
6. **Prompt:**  
“What playlist would you like to play?”
7. **Say:** [Beep]  
“XXXXX... (Ex. “My favorite”)  
(Playlist name)”

8. The name spoken will be searched for in the USB device or iPod.  
If a contact is matched, go to Step 10.  
If multiple contacts are matched, go to Step 9.
9. **Prompt:**  
“Would you like to play XXXXX... (Choice 1)?”  
**(Playlist you would like to play)**  
**Say:** [Beep] “Yes.” Then go to Step 10.  
**(Playlist you do not want to play)**  
**Say:** [Beep] “No.” Then go to Step 9.  
(Maximum 3 times)
10. The tracks from the selected playlist are played.

### Playing selected genre

#### **(When playing a USB or iPod)**

Tracks from a desired genre on a USB device or iPod can be played using voice recognition.

Refer to How to use USB mode (Type B) on page 6-94. Refer to How to use iPod mode (Type B) on page 6-102.

1. Press the talk button.
2. **Prompt:** “Ready”
3. **Say:** [Beep] “Play”
4. **Prompt:**  
“Would you like to play by Artist, Album, Playlist, or Genre?”
5. **Say:** [Beep] “Genre”
6. **Prompt:**  
“What genre would you like to play?”
7. **Say:** [Beep] “XXXXX... (Ex. “Rock”)  
(Genre name)”

## Bluetooth® (Type B)

- The name spoken will be searched for in the USB device or iPod.  
If a contact is matched, go to Step 10.  
If multiple contacts are matched, go to Step 9.

9. **Prompt:**

“Would you like to play XXXXX...  
(Choice 1)?”

**(Genre you would like to play)**

**Say:** [Beep] “Yes.” Then go to Step 10.

**(Genre you do not want to play)**

**Say:** [Beep] “No.” Then go to Step 9.  
(Maximum 3 times)

- Tracks from the selected genre are played.

### Scan

**(When playing a Radio, Sirius satellite radio, CD, or BT audio (AVRCPI.4))**

The scan function for the radio, Sirius satellite radio, CD and BT audio (AVRCPI.4) can be launched using voice recognition.

Refer to Operating the Radio on page 6-66.

Refer to Operating the Satellite Radio on page 6-70.

Refer to Operating the Compact Disc (CD) Player on page 6-78.

Refer to How to Use the Bluetooth® Audio System on page 6-164.

- Press the talk button.
- Prompt:** “Ready”
- Say:** [Beep] “Scan (or Scan Off)”
- Scan is performed or stopped.

### Mute

Muting of the audio can be done using voice recognition.

- Press the talk button.

- Prompt:** “Ready”

- Say:** [Beep] “Mute (or Mute Off)”

- Mute is performed or stopped.

### Track search

**(When playing a CD, USB, iPod, BT audio (AVRCPI.0/1.3/1.4))**

The track up/down function can be run using voice recognition.

Refer to Operating the Compact Disc (CD) Player on page 6-78.

Refer to How to use USB mode (Type B) on page 6-94.

Refer to How to use iPod mode (Type B) on page 6-102.

Refer to How to Use the Bluetooth® Audio System on page 6-164.

### Track up

- Press the talk button.
- Prompt:** “Ready”
- Say:** [Beep] “Next track”
- The next track is played.

### Track down

- Press the talk button.
- Prompt:** “Ready”
- Say:** [Beep] “Previous track”
- The previous track is played.

### Folder search

**(When playing BT audio (AVRCPI.4))**

The folder up/down function can be run using voice recognition.

Refer to How to Use the Bluetooth® Audio System on page 6-164.

### Folder up

- Press the talk button.

Interior Comfort

## Bluetooth® (Type B)

2. **Prompt:** “Ready”
3. **Say:** [Beep] “Next folder”
4. The next folder is played.

### Folder down

1. Press the talk button.
2. **Prompt:** “Ready”
3. **Say:** [Beep] “Previous folder”
4. The previous folder is played.

### Pause/Resume

#### **(When playing a CD, USB, iPod, BT audio (AVRCP1.0/1.3/1.4), Pandora®)**

Refer to Operating the Compact Disc (CD) Player on page 6-78.

Refer to How to use USB mode (Type B) on page 6-94.

Refer to How to use iPod mode (Type B) on page 6-102.

Refer to How to Use the Bluetooth® Audio System on page 6-164.

Refer to How to Use Pandora® on page 6-166.

### Pause

1. Press the talk button.
2. **Prompt:** “Ready”
3. **Say:** [Beep] “Pause”
4. Playback is paused.

### Resume playback

1. Press the talk button.
2. **Prompt:** “Ready”
3. **(When playing a CD, USB, iPod, BT audio (AVRCP1.0/1.3/1.4))**  
**Say:** [Beep] “Resume”  
**(When playing Pandora®)**  
**Say:** [Beep] “Play”

4. Playback is resumed.

### Repeat

#### **(When playing a CD, BT audio (AVRCP1.4))**

The repeat function can be run using voice recognition.

Refer to Operating the Compact Disc (CD) Player on page 6-78.

Refer to How to Use the Bluetooth® Audio System on page 6-164.

#### **(When playing a CD)**

1. Press the talk button.
2. **Prompt:** “Ready”
3. **Say:** [Beep] “Repeat (or Repeat Off)”
4. Repeat is performed or stopped.

#### **(When playing BT audio)**

1. Press the talk button.
2. **Prompt:** “Ready”
3. **Say:** [Beep] “Repeat”
4. **Prompt:**  
“Available repeat options are Track , Folder, and Off”
5. **Say:** [Beep]  
“XXXXX (Track, Folder or Off)”
6. If “Track” is spoken, track repeat is performed.  
If “Folder” is spoken, folder repeat is performed.  
If “Off” is spoken, repeat is stopped.

### Shuffle

#### **(When playing a CD, BT audio (AVRCP1.4))**

The shuffle function can be run using voice recognition.

Refer to Operating the Compact Disc (CD) Player on page 6-78.



## Bluetooth® (Type B)

Refer to How to Use the Bluetooth® Audio System on page 6-164.

### **(When playing a CD)**

1. Press the talk button.
2. **Prompt:** “Ready”
3. **Say:** [Beep] “Shuffle (or Shuffle Off)”
4. Shuffle is performed or stopped.

### **(When playing BT audio)**

1. Press the talk button.
2. **Prompt:** “Ready”
3. **Say:** [Beep] “Shuffle”
4. **Prompt:**  
“Available shuffle options are Folder , All, and Off”
5. **Say:** [Beep]  
“XXXXX (Folder, All or Off)”
6. If “Folder” is spoken, folder shuffle is performed.  
If “All” is spoken, device shuffle is performed.  
If “Off” is spoken, shuffle is stopped.

### **Switching between display/non-display of radio text information**

#### **(When playing FM Radio)**

Switching between display/non-display of radio text information is possible using voice recognition.  
Refer to Operating the Radio on page 6-66.

1. Press the talk button.
2. **Prompt:** “Ready”
3. **Say:** [Beep]  
“Radio text (or Radio text OFF)”

4. Radio text information is displayed/not displayed.

### **Selection by specifying frequency**

#### **(When playing the Radio)**

Selection by specifying the frequency is possible using voice recognition.  
Refer to Operating the Radio on page 6-66.

1. Press the talk button.
2. **Prompt:** “Ready”
3. **Say:** [Beep] “Frequency”
4. **Prompt:**  
“What frequency would you like?”
5. **Say:** [Beep]  
“XXX (Ex. 610) (Frequency)”
6. The specified frequency is selected.

### **Seek tuning function**

#### **(When playing the Radio)**

Seek tuning can be run using voice recognition.  
Refer to Operating the Radio on page 6-66.

#### **Seek up**

1. Press the talk button.
2. **Prompt:** “Ready”
3. **Say:** [Beep] “Seek up”
4. Seek up is performed.

#### **Seek down**

1. Press the talk button.
2. **Prompt:** “Ready”
3. **Say:** [Beep] “Seek down”
4. Seek down is performed.

Interior Comfort

## Bluetooth® (Type B)

### Auto memory seek function

#### **(When playing the Radio)**

The auto memory seek function can be run using voice recognition. Refer to Operating the Radio on page 6-66.

1. Press the talk button.
2. **Prompt:** “Ready”
3. **Say:** [Beep] “Auto memory seek”
4. Auto memory seek is performed.

### Auto memory preset function

#### **(When playing the Radio)**

Auto memory preset can be selected using voice recognition. Refer to Operating the Radio on page 6-66.

1. Press the talk button.
2. **Prompt:** “Ready”
3. **Say:** [Beep] “Auto memory preset”
4. **Prompt:** “Number, please”
5. **Say:** [Beep]  
“X (Ex. 3) (Preset number)”
6. The specified preset is selected.

### Preset switching

#### **(When playing the Radio, Sirius satellite radio)**

Radio stations programmed to the preset can be selected using voice recognition. Refer to Operating the Radio on page 6-66. Refer to Operating the Satellite Radio on page 6-70.

#### **Specify the preset number and select**

1. Press the talk button.
2. **Prompt:** “Ready”

3. **Say:** [Beep] “Preset”

4. **Prompt:**

“Say a preset number between 1 and 6”

5. **Say:** [Beep]

“X (Ex. 3) (Preset number)”

6. The specified preset is selected.

### Next preset selection

#### **(When playing the Radio)**

1. Press the talk button.
2. **Prompt:** “Ready”
3. **Say:** [Beep] “Next preset”
4. The next preset is selected.

### Previous preset selection

#### **(When playing the radio)**

1. Press the talk button.
2. **Prompt:** “Ready”
3. **Say:** [Beep] “Previous preset”
4. The previous preset is selected.

### Switching channels

#### **(When playing a Sirius satellite radio)**

Selection of the channel to be received is possible using voice recognition. Refer to Operating the Satellite Radio on page 6-70.

#### **Select by specifying the channel number**

1. Press the talk button.
2. **Prompt:** “Ready”
3. **Say:** [Beep] “Channel”
4. **Prompt:**  
“What channel number would you like?”

## Bluetooth® (Type B)

5. **Say:** [Beep]  
“XXX (Ex. 610) (Channel number)”
6. The specified channel is selected.

### **Selecting the next channel**

1. Press the talk button.
2. **Prompt:** “Ready”
3. **Say:** [Beep] “Next channel”
4. The next channel is selected.

### **Selecting the previous channel**

1. Press the talk button.
2. **Prompt:** “Ready”
3. **Say:** [Beep] “Previous channel”
4. The previous channel is selected.

### **Skip track function**

**(When playing Pandora®)**  
The skip track function can be run using voice recognition.  
Refer to How to Use Pandora® on page 6-166.

1. Press the talk button.
2. **Prompt:** “Ready”
3. **Say:** [Beep] “Skip Track”
4. The next track is skipped.

### **Thumbs up function**

**(When playing Pandora®)**  
The thumbs up function can be run using voice recognition.  
Refer to How to Use Pandora® on page 6-166.

1. Press the talk button.
2. **Prompt:** “Ready”
3. **Say:** [Beep] “Thumbs Up”

4. This tells Pandora® that you like this track and helps to bring in more tracks like it to your station.

### **Thumbs down function**

**(When playing Pandora®)**  
The thumbs down function can be run using voice recognition.  
Refer to How to Use Pandora® on page 6-166.

1. Press the talk button.
2. **Prompt:** “Ready”
3. **Say:** [Beep] “Thumbs Down”
4. This tells Pandora® not to play this track.

### **Pandora® radio station selection**

**(When playing Pandora®)**  
A Pandora® radio station can be selected using voice recognition.  
Refer to How to Use Pandora® on page 6-166.

1. Press the talk button.
2. **Prompt:** “Ready”
3. **Say:** [Beep] “Station”
4. **Prompt:** “Which Pandora® station you would like?”
5. **Say:** [Beep]  
“XXXXX... (Ex. “90’s classic”)  
(Station name)”
6. The system searches for the announced radio station.  
If a contact is matched, go to Step 8.  
If multiple contacts are matched, go to Step 7.

Interior Comfort

## Bluetooth® (Type B)

---

### 7. Prompt:

“Would you like to play XXXXX...  
(Choice 1)?”

**(Station you would like to play)**

**Say:** [Beep] “Yes.” Then go to Step 8.

**(Station you do not want to play)**

**Say:** [Beep] “No.” Then go to Step 7.  
(Maximum 3 times)

8. The specified radio station is selected.

### Bookmark function

**(When playing Pandora®)**

The bookmark function can be run using  
voice recognition.

Refer to How to Use Pandora® on page  
6-166.

1. Press the talk button.

2. **Prompt:** “Ready”

3. **Say:** [Beep] “Bookmark”

4. **Prompt:**

“Would you like to bookmark Track, or  
artist?”

5. **Say:** [Beep] “Track (or Artist)”

6. Track or artist is bookmarked.

Interior Comfort  
**Bluetooth® (Type B)**

---

▼ **Gracenote Database**

The Gracenote media database is used to improve voice recognition of artist and album names with the Mazda Hands Free system. To make best use of the voice recognition, install the most recent database.

**⚠ CAUTION**

*For information related to the most recent Gracenote database which can be used and how to install it, go to the Mazda Hands Free Website:  
<http://www.mazdahandsfree.com>*

**Introduction**

Music recognition technology and related data are provided by Gracenote®. Gracenote is the industry standard in music recognition technology and related content delivery. For more information visit [www.gracenote.com](http://www.gracenote.com).

CD and music-related data from Gracenote, Inc., copyright © 2000 to present Gracenote. Gracenote Software, copyright © 2000 to present Gracenote. One or more patents owned by Gracenote apply to this product and service. See the Gracenote website for a non-exhaustive list of applicable Gracenote patents. Gracenote, CDDDB, MusicID, MediaVOCS, the Gracenote logo and logotype, and the “Powered by Gracenote” logo are either registered trademarks or trademarks of Gracenote in the United States and/or other countries.



Interior Comfort

## Bluetooth® (Type B)

---

### Gracenote® End User License Agreement

This application or device contains software from Gracenote, Inc. of Emeryville, California (“Gracenote”). The software from Gracenote (the “Gracenote Software”) enables this application to perform disc and/or file identification and obtain music-related information, including name, artist, track, and title information (“Gracenote Data”) from online servers or embedded databases (collectively, “Gracenote Servers”) and to perform other functions. You may use Gracenote Data only by means of the intended End-User functions of this application or device.

You agree that you will use Gracenote Data, the Gracenote Software, and Gracenote Servers for your own personal non-commercial use only. You agree not to assign, copy, transfer or transmit the Gracenote Software or any Gracenote Data to any third party. **YOU AGREE NOT TO USE OR EXPLOIT GRACENOTE DATA, THE GRACENOTE SOFTWARE, OR GRACENOTE SERVERS, EXCEPT AS EXPRESSLY PERMITTED HEREIN.**

You agree that your non-exclusive license to use the Gracenote Data, the Gracenote Software, and Gracenote Servers will terminate if you violate these restrictions. If your license terminates, you agree to cease any and all use of the Gracenote Data, the Gracenote Software, and Gracenote Servers. Gracenote reserves all rights in Gracenote Data, the Gracenote Software, and the Gracenote Servers, including all ownership rights. Under no circumstances will Gracenote become liable for any payment to you for any information that you provide. You agree that Gracenote, Inc. may enforce its rights under this Agreement against you directly in its own name.

The Gracenote service uses a unique identifier to track queries for statistical purposes. The purpose of a randomly assigned numeric identifier is to allow the Gracenote service to count queries without knowing anything about who you are. For more information, see the web page for the Gracenote Privacy Policy for the Gracenote service.

The Gracenote Software and each item of Gracenote Data are licensed to you “AS IS.” Gracenote makes no representations or warranties, express or implied, regarding the accuracy of any Gracenote Data from in the Gracenote Servers. Gracenote reserves the right to delete data from the Gracenote Servers or to change data categories for any cause that Gracenote deems sufficient. No warranty is made that the Gracenote Software or Gracenote Servers are error-free or that functioning of Gracenote Software or Gracenote Servers will be uninterrupted. Gracenote is not obligated to provide you with new enhanced or additional data types or categories that Gracenote may provide in the future and is free to discontinue its services at any time.

**GRACENOTE DISCLAIMS ALL WARRANTIES EXPRESS OR IMPLIED, INCLUDING, BUT NOT LIMITED TO, IMPLIED WARRANTIES OF MERCHANTABILITY, FITNESS FOR A PARTICULAR PURPOSE, TITLE, AND NON-INFRINGEMENT. GRACENOTE DOES NOT WARRANT THE RESULTS THAT WILL BE OBTAINED BY YOUR USE OF THE GRACENOTE SOFTWARE OR ANY GRACENOTE SERVER. IN NO CASE WILL GRACENOTE BE LIABLE FOR ANY CONSEQUENTIAL OR INCIDENTAL DAMAGES OR FOR ANY LOST PROFITS OR LOST REVENUES.**

© 2000 to present. Gracenote, Inc.

**6-162**

Interior Comfort  
**Bluetooth® (Type B)**

---

**Updating the database**

The Gracenote media database can be updated using USB device.

1. Connect a USB device containing the software for updating Gracenote.
2. Touch the  on-screen button.
3. Touch the  on-screen button.
4. Touch the  on-screen button to scroll the display.  
When the display is scrolled to the end of the explanation, the  on-screen button is displayed.
5. Touch the  on-screen button. The update is initiated.
6. Touch the  on-screen button.

**NOTE**

*Do not switch the ignition off or disconnect the USB device while updating the database. Otherwise, data could be lost.*

Interior Comfort

## Bluetooth® (Type B)

### Bluetooth® Audio

#### Applicable Bluetooth® specification

Ver. 2.0 or higher

#### Response profile

- A2DP (Advanced Audio Distribution Profile) Ver. 1.0/1.2
- AVRCP (Audio/Video Remote Control Profile) Ver. 1.0/1.3/1.4

A2DP is a profile which transmits only audio to the Bluetooth® unit. If your Bluetooth® audio device corresponds only to A2DP, but not AVRCP, you cannot operate it using the control panel of the vehicle's audio system. In this case, the Bluetooth® audio device can be operated by controlling the device itself, the same as when a portable audio system without the Bluetooth® communication function is connected to the AUX terminal.

| Function             | A2DP | A2DP-AVRCP |          |          |
|----------------------|------|------------|----------|----------|
|                      |      | Ver. 1.0   | Ver. 1.3 | Ver. 1.4 |
| Playback             | —    | X          | X        | X        |
| Pause                | —    | X          | X        | X        |
| File (Track) up/down | —    | X          | X        | X        |
| Reverse              | —    | —          | X        | X        |
| Fast-forward         | —    | —          | X        | X        |
| Text display         | —    | —          | X        | X        |
| Folder up/down       | —    | —          | —        | X        |
| Repeat               | —    | —          | —        | X        |
| Shuffle              | —    | —          | —        | X        |
| Scan                 | —    | —          | —        | X        |

X: Available

—: Not available

#### NOTE

- To make sure that your Bluetooth® audio device is Ver. 1.0, 1.3 or 1.4, refer to the Owner's Manual for the Bluetooth® audio device.
- The battery consumption of Bluetooth® audio devices is higher while Bluetooth® is connected.
- If a general mobile phone device is USB connected during music playback over the Bluetooth® connection, the Bluetooth® connection is disconnected. For this reason, you cannot have music playback over a Bluetooth® connection and music playback using a USB connection at the same time.
- The system may not operate normally depending on the Bluetooth® audio device.

#### ▼ How to Use the Bluetooth® Audio System

##### Switching to Bluetooth® audio mode

To listen to music or voice audio recorded to a Bluetooth® audio device, switch to the Bluetooth® audio mode to operate the audio device using the audio system control panel. Any Bluetooth® audio device must be programmed to the vehicle's Bluetooth® unit before it can be used.

Refer to Bluetooth® Preparation on page 6-141.

1. Switch the ignition to ACC or ON.
2. Turn on the Bluetooth® audio device's power.  
Make sure that the “ⓧ” symbol is displayed in the audio unit's display.

#### NOTE

Some Bluetooth® audio devices need a certain amount of time before the “ⓧ” symbol is displayed in the audio unit's display.



## Bluetooth® (Type B)

3. Press the audio button (AUDIO) and then touch the  on-screen tab to switch to the Bluetooth® audio mode and start playback.

### NOTE



- If the Bluetooth® audio device does not begin playback, press the  on-screen button.
- If the mode is switched from Bluetooth® audio mode to another mode (radio mode), audio playback from the Bluetooth® audio device stops.

### Playback



1. To listen to a Bluetooth® audio device over the vehicle's speaker system, switch the mode to Bluetooth® audio mode. (Refer to “Switching to Bluetooth® audio mode”)
2. To stop playback, press the  on-screen button.
3. Press the button again to resume playback.

### Selecting a file (track)

#### Selects the next file (track)



Short-press the track up button () or touch the  on-screen button.

#### Selects the beginning of the current file (track)



Short-press the track down button () or touch the  on-screen button.

### Fast-forward/Reverse (AVRCP Ver. 1.3 or higher)



#### Fast-forward

Press and hold the fast-forward button () or touch and hold the  on-screen button.

### Reverse



Press and hold the reverse down button () or touch and hold the  on-screen button.

### Folder search (only AVRCP Ver. 1.4)

To change to the previous folder, touch the  on-screen button, or touch the  on-screen button to advance to the next folder.



### Music scan (only AVRCP Ver. 1.4)



This function scans the titles in a folder currently being played and plays 10 seconds of each song to aid you in finding a song you want to listen to.

1. Touch the  on-screen button during playback to play 10 seconds of each subsequent track starting from the next song.
2. Touch the  on-screen button again during playback of the song which you want to listen to continue the playback from that point.



### Repeat playback (only AVRCP Ver. 1.4)



#### Track repeat

Touch the  on-screen button to play the song during playback repeatedly. “” is displayed during playback.

Touch the  on-screen button two times while “” is displayed to cancel.

#### Folder repeat

Touch the  on-screen button two times to play the songs in the folder repeatedly. “” is displayed during playback.



Touch the  on-screen button while “” is displayed to cancel.



Interior Comfort

## Bluetooth® (Type B)



### Shuffle playback (only AVRCP Ver. 1.4)



#### Folder shuffle

Touch the  on-screen button during playback to play the songs in the folder shuffle. “” is displayed during playback.



Touch the  on-screen button two times while “” is displayed to cancel.

#### Device shuffle

Touch the  on-screen button two times during playback to play the songs in the device shuffle. “” is displayed during playback.

Touch the  on-screen button while “” is displayed to cancel.

### Display scroll

If a whole title cannot be displayed at one time, touch the  on-screen button on the right side of the title. When the last character is displayed, touch the  on-screen button to display the first character of the title.

### ▼ Bluetooth® audio device information display

If a Bluetooth® audio device is connected, the following information is displayed in the display.

|                                    | AVRCP Ver. lower than 1.3 | AVRCP Ver. 1.3 | AVRCP Ver. 1.4 or higher |
|------------------------------------|---------------------------|----------------|--------------------------|
| Device name                        | X                         | X              | X                        |
| Remaining battery charge of device | —                         | X              | X                        |
| Title                              | —                         | X              | X                        |
| Artist name                        | —                         | X              | X                        |
| Album name                         | —                         | X              | X                        |
| File number                        | —                         | X              | X                        |
| Playback time                      | —                         | X              | X                        |
| Folder number                      | —                         | —              | X                        |

6-166

### NOTE

Some information may not display depending on the device, and if the information cannot be displayed, “No Song Name” is indicated.

### ▼ How to Use Pandora®

#### What is Pandora®?

Pandora® is free personalized internet radio. Simply enter a favorite artist, track, genre, and Pandora® will create a personalized station that plays their music and more like it. Rate songs by giving thumbs-up and thumbs-down feedback to further refine your station, discover new music and help Pandora® play only music you love.



\* Pandora®, the Pandora® logo, and the Pandora® trade dress are trademarks or registered trademarks of Pandora Media, Inc., used with permission.

### NOTE

To operate Pandora® from your Bluetooth® device, perform the following in advance:

- Create Pandora® account on the web.
- Create Pandora® station using Pandora® application.
- Install Pandora® application on your device.

### Playback

1. To listen to Pandora®, touch the  on-screen tab.
2. To stop playback, press the  on-screen button.
3. Press the button again to resume playback.

### Skip song

Press the  on-screen button.

Interior Comfort  
**Bluetooth® (Type B)**

**NOTE**

- The skip function may not be available depending on the device.
- The number of skips is limited by Pandora®.

**Selection from station list**

Selection can be made from a programmed radio station list.

1. Press the  on-screen button.
2. Select the desired radio station.

**NOTE**

When  is selected, songs randomly selected from the radio station list are played.

**Thumbs up function**

Press the  on-screen button to tell Pandora® “you like this track” and it helps to bring in more tracks like it to your station.

**Thumbs down function**

Press the  on-screen button to tell Pandora® not to play this track.

**NOTE**

If the  on-screen button is touched when the skip song function is running, the next song is skipped.

**Bookmarking**

You can bookmark song or artist to check out later on the Web.

**Bookmark the song name**

Press the  on-screen button on the right side of the song name.

**Bookmark the artist name**

Press the  on-screen button on the right side of the artist name.

**Display scroll**

If a whole title cannot be displayed at one time, touch the  on-screen button on the right side of the title.

When the last character is displayed, touch the  on-screen button to display the first character of the title.

Interior Comfort

## Bluetooth® (Type B)

---

### Troubleshooting

Bluetooth® does not operate under the following conditions. Check whether the following conditions apply to your Bluetooth® device:

- The device is not being operated correctly.
- The device is not connected to the Bluetooth® unit equipped on the vehicle.
- The device's battery is weak.
- A device which interferes with radio wave reception has been placed in the vehicle.
- The ignition switch has been turned off.

If none of the above conditions apply, refer to the following to see if any of the problem symptoms correspond to your device.

If the problem cannot be resolved, consult an Authorized Mazda Dealer or Mazda Bluetooth® Hands-Free Customer Service.

#### **Mazda Bluetooth® Hands-Free Customer Service**

If you have any problems with Bluetooth®, contact with our toll-free customer service center.

- **U.S.A.**  
Phone: 800-430-0153 (Toll-free)  
Web: [www.MazdaUSA.com/bluetooth](http://www.MazdaUSA.com/bluetooth)
- **Canada**  
Phone: 800-430-0153 (Toll-free)  
Web: [www.mazdahandsfree.ca](http://www.mazdahandsfree.ca)

6-168

Interior Comfort

## Bluetooth® (Type B)

### Device pairing, connection problems

| Symptom   | Cause  | Solution method   |
|---|--|---|
| Unable to perform pairing                               | —  | First make sure the device is compatible with the Bluetooth® unit, and then check whether the Bluetooth® function and the Find Mode/Visible setting*1 on the device are turned on. If pairing is still not possible after this, contact an Authorized Mazda Dealer or Mazda Bluetooth® Hands-Free Customer Service. |
| Unable to perform pairing                               | The Bluetooth® function and the Find Mode/Visible setting*1 on the device may turn off automatically after a period of time has elapsed depending on the device. | Check whether the Bluetooth® function and the Find Mode/Visible setting*1 on the device are turned on and pairing or reconnect.   |
| Does not connect automatically when starting the engine |  |   |
| Automatically connects, but then disconnects suddenly   |  |   |
| Disconnects intermittently                              | The device is in a location in which radio wave interference can occur easily.<br>(Inside a bag in a rear seat, in the rear pocket of a pair of pants)           | Move the device to a location in which radio wave interference is less likely to occur.   |

\*1 Setting which detects the existence of a device external to the Bluetooth® unit

Interior Comfort

## Bluetooth® (Type B)

### Voice recognition related problems

| Symptom   | Cause   | Solution method   |
|---|---|---|
| Poor voice recognition<br>False recognition of numbers  | <ul style="list-style-type: none"> <li>Excessive, slow speech.</li> <li>Excessive, forceful speech (shouting).</li> <li>Speaking before the beep sound has ended.</li> <li>Loud noise (speaking or noise from outside/inside vehicle).</li> <li>Airflow from A/C is blowing against the microphone.</li> <li>Speaking in off-standard expressions (dialect).</li> </ul> | Regarding the causes indicated on the left, be careful with how you speak. In addition, when numbers are spoken in a sequence, recognition ability will improve if no stop is placed between the numbers.   |
| Names in the phonebook are not easily recognized        | The Bluetooth® system is under a condition in which recognition is difficult.   | By carrying out the following measures, the rate of recognition will improve. <ul style="list-style-type: none"> <li>Clear memory from the phonebook which is not used very often.</li> <li>Avoid shortened names, use full names.<br/>(Recognition improves the longer the name is. By not using names such as "Mom", "Dad", recognition will improve.)</li> </ul> |
| You want to skip guidance                               | —   | Guidance can be skipped by quickly pressing and releasing the Talk button.  |
| When the Talk button is pressed, voice recognition ends | The Talk button is pressed for too long.  | Operate the Talk button as follows: <ul style="list-style-type: none"> <li>Press the button and release it within 0.7 seconds to start voice recognition and skip the guidance.</li> <li>Press the button for longer than 0.7 seconds to turn off voice recognition or end a conversation.</li> </ul>   |

### Regarding problems with calls

| Symptom   | Cause   | Solution method                                   |
|---|---|---|
| When starting a call, vehicle noise from the other party can be heard | For about three seconds after starting a call, the Bluetooth® unit's Noise Suppression function requires time to adapt to the call environment. | This does not indicate a problem with the device. |
| The other party cannot be heard or the speaker's voice is quiet       | The volume is set at zero or low.   | Increase the volume.                              |

Interior Comfort  
**Bluetooth® (Type B)**

**Other problems**

| Symptom   | Cause  | Solution method   |
|---|--|---|
| The indication for the remaining battery is different between the vehicle and the device  | The indication method is different between the vehicle and the device. | —   |
| When a call is made from the vehicle, the telephone number is updated in the incoming/outgoing call record but the name does not appear | The number has not been registered into the phonebook.                 | If the number has been registered into the phonebook, the incoming/outgoing call record is updated by the name in the phonebook when the engine is restarted. |
| The cell phone does not synchronize with the vehicle regarding the incoming/outgoing call record  | Some types of cell phones do not synchronize automatically.            | Operate the cell phone for synchronization.   |
| It takes a long time to complete the function for changing the language   | A maximum of 60 seconds is required.                                   | —   |

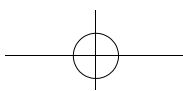

Interior Comfort

## Bluetooth® (Type B)

### Safety Certification

#### FCC

FCC: CB2MAZGEN6HFT

#### NOTE

*This device complies with Part 15 of the FCC Rules. Operation is subject to the following two conditions:*

- (1) This device may not cause harmful interference, and*
- (2) This device must accept any interference received, including interference that may cause undesired operation.*

#### **⚠ WARNING**

**Changes or modifications made to this equipment not expressly approved by the manufacturer may void the FCC authorization to operate this equipment.**

#### NOTE

*This equipment has been tested and found to comply with the limits for a Class B digital device, pursuant to Part 15 of the FCC Rules. These limits are designed to provide reasonable protection against harmful interference in a residential installation. This equipment generates, uses and can radiate radio frequency energy and, if not installed and used in accordance with the instructions, may cause harmful interference to radio communications. However, there is no guarantee that interference will not occur in a particular installation. If this equipment does cause harmful interference to radio or television reception, which can be determined by turning the equipment off and on, the user is encouraged to try to correct the interference by one or more of the following measures:*

- Reorient or relocate the receiving antenna.*
- Increase the separation between the equipment and receiver.*
- Connect the equipment into an outlet on a circuit different from that to which the receiver is connected.*
- Consult the dealer or an experienced radio/TV technician for help.*

#### IC

IC:279B-MAZGEN6HFT

Licence exempt

This device complies with Industry Canada licence-exempt RSS standard(s). Operation is subject to the following two conditions:

- (1) This device may not cause interference, and
- (2) This device must accept any interference, including interference that may cause undesired operation of the device.

6-172

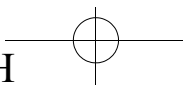





Interior Comfort  
**Bluetooth® (Type B)**

---

The term “IC: ” before the radio certification number only signifies that Industry Canada technical specifications were met. The antenna used for this transmitter must not be co-located or operating in conjunction with any other antenna or transmitter. End-users and installers must be provided with installation instructions and transmitter operating conditions for satisfying RF exposure compliance.

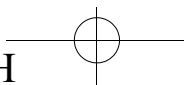
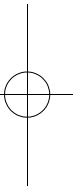
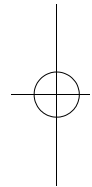

Interior Comfort

## Interior Equipment

### Sunvisors

When you need a sunvisor, lower it for use in front or swing it to the side.

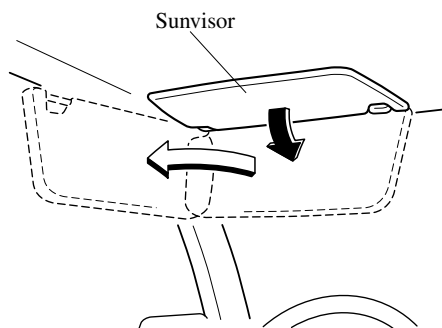

### ▼ Vanity Mirrors

To use the vanity mirror, lower the sunvisor.

If your vehicle is equipped with a vanity mirror light, it will illuminate when you open the cover.

### Interior Lights

#### ▼ Illuminated Entry System

When the illuminated entry system operates, the overhead light (switch is in the DOOR position) turns on for:

- About 30 seconds after the driver's door is unlocked and the ignition key is removed (without advanced key) or the ignition is switched off (with advanced key).
- About 15 seconds after all doors are closed.  
**(With Advanced key)**  
About 5 seconds after all doors are closed when the advanced key is outside of the vehicle.
- About 15 seconds after the ignition is switched off and the ignition key removed (without advanced key) with all doors closed.

The light also turns off when:

- The ignition is switched ON and all doors are closed.
- The driver's door is locked.

#### **NOTE**

- **Battery saver**

*If any door is left opened, the light turns off after about 30 minutes to save the battery.*

*The light turns on again when the ignition is switched ON, or when any door is opened after all doors have been closed.*

- *The operation of the illuminated entry system can be changed.*

*Refer to Personalization Features on page 10-13.*

## Interior Equipment

### ▼ Overhead Lights

#### Front

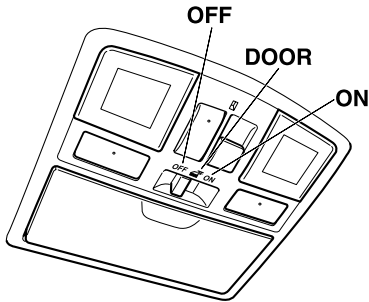

#### Rear

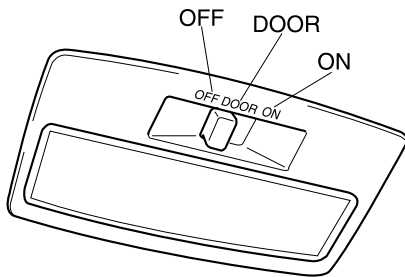

| Switch Position | Overhead Lights   |
|-----------------|---|
| OFF             | Light off   |
| DOOR            | <ul style="list-style-type: none"> <li>Light is on when any door is open</li> <li>Light is on or off when the illuminated entry system is on</li> </ul> |
| ON              | Light on  |

### ▼ Map Lights

The map lights are switched on or off by pressing the switches.

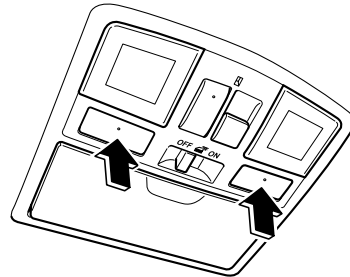

### ▼ Luggage Compartment Light (5 Door)

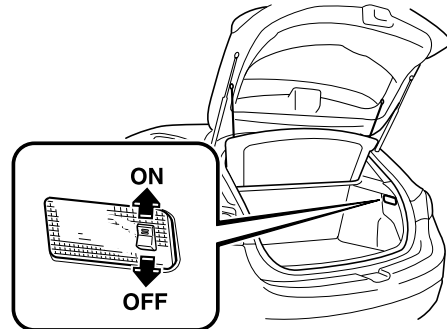

| Switch Position | Luggage Compartment Light          |
|-----------------|------------------------------------|
| OFF             | Light off                          |
| ON              | Light on when the liftgate is open |

Interior Comfort

## Interior Equipment

### Information Display

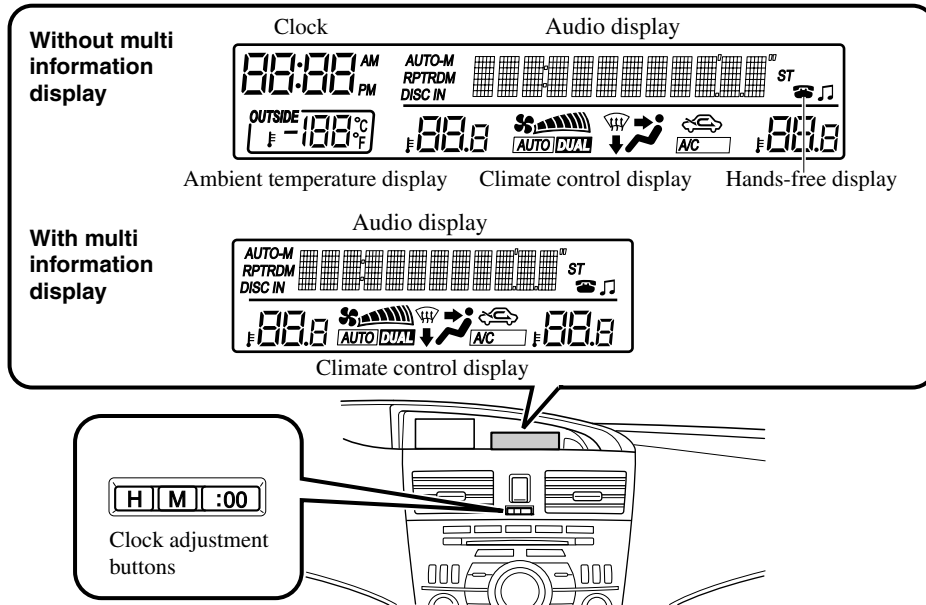

#### ▼ Information Display Functions

The information display has the following functions:

- Clock\*
- Ambient Temperature Display (Outside Temperature Display)\*
- Climate Control Display (Fully Automatic Type Air Conditioning System)
- Audio Display
- Bluetooth® Hands-Free Display\* Refer to Bluetooth® Hands-Free (Type A) on page 6-116.

6-176 \*Some models.

## Interior Equipment

### ▼ Clock \*

When the ignition is switched to ACC or ON, the time is displayed.



#### Time setting

1. Switch the ignition to ACC or ON.
2. Adjust the time using the time setting buttons (H , M ).  
The hours advance while the time setting button (H ) is pressed.  
The minutes advance while the time setting button (M ) is pressed.

#### Time resetting

1. Switch the ignition to ACC or ON.
2. Press the :00 button.
3. When the button is pressed, the time will be reset as follows:

(Example)

12:01—12:29→12:00

12:30—12:59→1:00

#### **NOTE**

When the button is pressed, the seconds will start at “00”.

### ▼ Outside Temperature Display (Fully Automatic Type)

When the ignition is switched ON, the ambient temperature is displayed.



#### **NOTE**

Under the following conditions, the ambient temperature display may differ from the actual ambient temperature depending on the surroundings and vehicle conditions:

- Significantly cold or hot temperatures.
- Sudden changes in ambient temperature.
- The vehicle is parked.
- The vehicle is driven at low speeds.

### ▼ Climate Control Display

The climate control system status is displayed. To operate the climate control system, refer to “Climate Control System” (page 6-2).

### ▼ Audio Display

The audio system status is displayed. To operate the audio system, refer to “Audio System” (page 6-16).

Interior Comfort

## Interior Equipment

### Multi Information Display\*

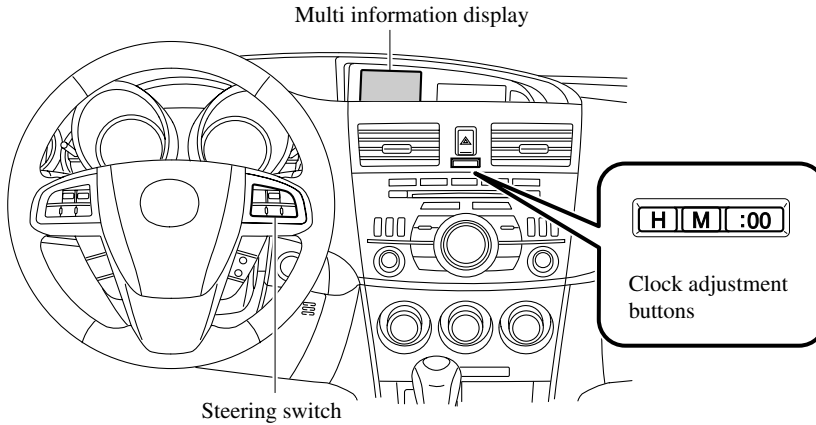

### Steering Switch

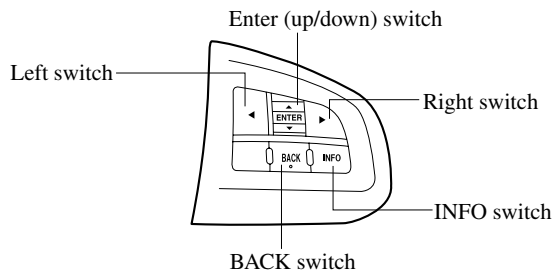

6-178 \*Some models.

## Interior Equipment

| Switch                   | Function  |
|--------------------------|---|
| Enter (up/down) switch   | Used to select a menu and change numbers. Select up or down and press enter.  |
| Right switch/Left switch | Used to select digits when setting numbers.   |
| BACK switch              | Press during SETTINGS to return to the previous screen.   |
| INFO switch              | Press to switch to the multi information display.<br>Switches the setting display in the order of Trip computer (average fuel economy/average vehicle speed) → Trip computer (current fuel economy/distance-to-empty) → Audio display → Settings (reset averages/maintenance/preferences). Each time the switch is pressed, the multi information display cycles through. |

### ▼ Multi Information Display Functions

| Function name               | Details   | See page |
|-----------------------------|---|----------|
| Clock                       | Constant display of time.   | 6-179    |
| Outside temperature display | Constant display of ambient temperature.  | 6-180    |
| Audio display               | Displays the audio operation status. Displayed when the INFO switch is pressed.   | 6-180    |
| Trip computer               | Displays the average fuel economy, average vehicle speed, current fuel economy, and distance-to-empty. Displayed when the INFO switch is pressed. | 6-180    |
| Maintenance monitor         | Notification of periodic inspection and tire rotation period  | 6-181    |
| Warning indicator           | Notification of the need to take caution  | 6-186    |
| Settings                    | Used to change the multi information display settings. Displayed when the INFO switch is pressed.   | 6-186    |

### ▼ Clock

The time is displayed when the ignition is switched to ACC or ON.

### Time setting

Refer to Clock on page 6-177.

### Time resetting

Refer to Clock on page 6-177.

10:00AM

Interior Comfort

## Interior Equipment

### ▼ Outside Temperature Display

When the ignition is switched ON, the ambient temperature is displayed.

78°F

#### NOTE

- Under the following conditions, the ambient temperature display may differ from the actual ambient temperature depending on the surroundings and vehicle conditions:
  - Significantly cold or hot temperatures.
  - Sudden changes in ambient temperature.
  - The vehicle is parked.
  - The vehicle is driven at low speeds.
- When the ignition is switched to ACC, “- - -” is displayed.

### ▼ Audio Display

Press the INFO switch until the AUDIO screen is displayed. The audio operation status is displayed.

To operate the audio system, refer to “Audio System” (page 6-16).

### ▼ Trip Computer

The trip computer can display the following:

- The average fuel economy.
- The average vehicle speed.
- The current fuel economy.

- The approximate distance you can travel on the available fuel.

1. Switch the ignition ON.
2. Press the INFO switch until the trip computer screen is displayed.

If you have any problems with your trip computer, consult an Authorized Mazda Dealer.

#### Average fuel economy

This mode displays the average fuel economy by calculating the total fuel consumption and the total traveled distance since purchasing the vehicle, re-connecting the battery after disconnection, or resetting the data. The average fuel economy is calculated and displayed every minute.

|                   |          |
|-------------------|----------|
| 78°F              | 10:00 AM |
| AVG. FUEL ECONOMY |          |
| 25.0 mpg          |          |
| AVG. SPEED        |          |
| 45 mph            |          |

To erase the displayed data, Refer to Settings on page 6-186.

After erasing, the calculated average fuel economy in - - - L/100 km (- - - mpg) is displayed after 1 minute has elapsed.

#### Average vehicle speed

This mode displays the average vehicle speed by calculating the distance and the time traveled since connecting the battery or resetting the data.



Interior Comfort

## Interior Equipment

The average vehicle speed will be calculated every 10 seconds.

|                   |          |
|-------------------|----------|
| 78°F              | 10:00 AM |
| AVG. FUEL ECONOMY |          |
| 25.0 mpg          |          |
| AVG. SPEED        |          |
| 45 mph            |          |

To erase the displayed data, Refer to Settings on page 6-186. After erasing, the calculated average vehicle speed in --- km/h (--- mph) is displayed after 1 minute has elapsed.

### Current fuel economy

This mode displays the current fuel economy by calculating the amount of fuel consumption and the distance traveled.

The current fuel economy will be calculated every 2 seconds.

|                    |          |
|--------------------|----------|
| 78°F               | 10:00 AM |
| CURRENT FUEL ECON. |          |
| 34.0 mpg           |          |
| RANGE              |          |
| 235 miles          |          |

When you've slowed to about 5 km/h (3 mph), --- L/100 km (--- mpg) will be displayed.

### Distance-to-empty

This mode displays the approximate distance (range) you can travel on the remaining fuel based on the fuel economy. The distance-to-empty will be calculated every second.

|                    |          |
|--------------------|----------|
| 78°F               | 10:00 AM |
| CURRENT FUEL ECON. |          |
| 34.0 mpg           |          |
| RANGE              |          |
| 235 miles          |          |

### **NOTE**

- Even though the distance-to-empty display may indicate a sufficient amount of remaining driving distance (range) before refueling is required, refuel as soon as possible if the fuel gauge needle nears E or the low fuel warning light illuminates.
- The display will not change unless you add more than approximately 5 L {6 US qt, 5 Imp qt} of fuel.
- When the ignition is switched to ACC, "---" is displayed.

### ▼ **Maintenance Monitor**

The maintenance monitor notifies the driver when the periodic inspection and tire rotation periods are due. The maintenance monitor displays the information when the ignition is switched to ACC or ON.

### **NOTE**

This function is inoperable while the vehicle is being driven.

Interior Comfort

## Interior Equipment

### Initial setting method

1. Press the INFO switch until the SETTINGS screen is displayed.
2. Select MAINTENANCE by pressing the Enter (up/down) switch up or down, and then press the Enter (up/down) switch.
3. Select the item you want to turn on (TIRE ROTATION or SERVICE DUE) by pressing the Enter (up/down) switch up or down, and then press the Enter (up/down) switch.

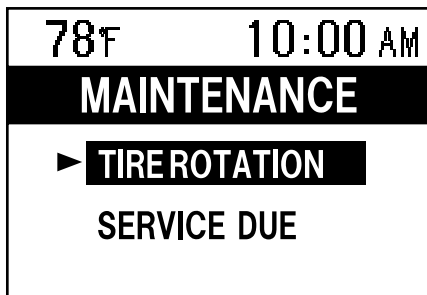

4. Press the ENTER (up/down) switch.
5. Select SET and press the Enter (up/down) switch.

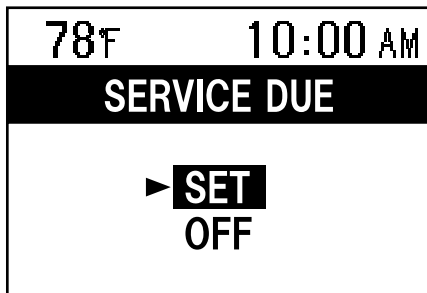

### NOTE

- For the service due notification, either the number of days or distance can be set. When selecting one of the two settings, the setting not selected is set to the initial value automatically.
  - Because tire rotation can only be set according to distance, the screen for setting distance is displayed when SET is selected.
6. Select DISTANCE or DAYS and press the Enter (up/down) switch. The screen for setting the distance or days to the next maintenance period is displayed.

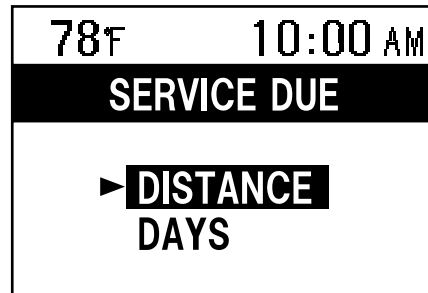

7. Select a digit using the Right switch/ Left switch, and press the Enter (up/down) switch up or down to change the value of the digit. If there is no need to change a digit, leave it as it is and press the Enter (up/down) switch.

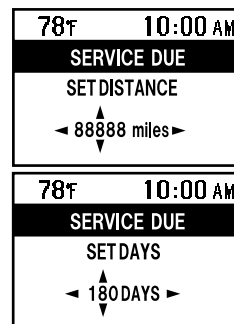

Interior Comfort  
**Interior Equipment**

**NOTE**

*The initial setting values are displayed corresponding to the maintenance schedule (except Puerto Rico). For each regional maintenance schedule, Refer to Scheduled Maintenance on page 8-4.*

**Message display**

When the remaining days or the distance approaches 0, a message is displayed for 5 seconds each time the ignition is switched to ACC or ON.

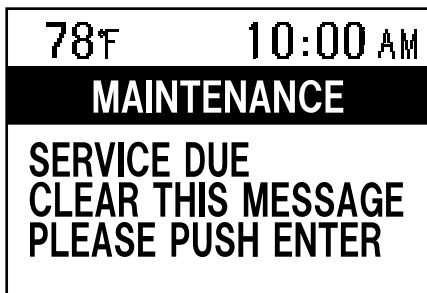

**NOTE**

- *If the Enter (up/down) switch is pressed while a message is displayed, it will no longer be displayed the next time the engine is started.*
- *After the vehicle is serviced and the remaining days/distance is reset, the message for the next maintenance period will be displayed when the remaining distance or days to the next maintenance period approaches 0 (displays when engine is started).*
- *If there are multiple tire rotation periods or service due, they are displayed according to their order.*
- *If there is more than one servicing due deadline with one past due and the other approaching, only the one which is past due will be displayed.*

Interior Comfort

# Interior Equipment

## Display period

| Item          | Start of message display  | End of message display   |
|---------------|---|--|
| TIRE ROTATION | When remaining distance is less than 500 km (300 mile)  | Distance exceeds 500 km (300 mile) from remaining distance of 0 km   |
| SERVICE DUE   | When remaining distance is less than 500 km (300 mile), or remaining days are less than 15 (which ever comes first) | Distance exceeds 500 km (300 mile) from remaining distance of 0 km, or 15 days have elapsed since remaining days reached "0" days (which ever comes first) |

## Message display

| Item                         | Timing  | Displayed message |
|------------------------------|---|-------------------|
| TIRE ROTATION                | Remaining distance:<br>500 km (300 mile) to -500 km (-300 mile) | TIRE ROTATION DUE |
| SERVICE DUE                  | Remaining distance:<br>500 km (300 mile) to 0 km (0 mile)       | SERVICE DUE       |
|                              | Remaining days: 15 to 0 days                                    |                   |
|                              | Remaining distance:<br>0 km (0 mile) to -500 km (-300 mile)     | SERVICE OVERDUE   |
| Remaining days: 0 to 15 days |   |                   |

## Reset method

If resetting is performed after a tire rotation or periodic inspection has been done, a notification of the next maintenance period will be displayed when the period approaches.

1. Press the INFO switch until the SETTINGS screen is displayed.
2. Select MAINTENANCE by pressing the Enter (up/down) switch up or down, and then press the Enter (up/down) switch.

3. Select the item you would like to reset (TIRE ROTATION or SERVICE DUE) by pressing the Enter (up/down) switch up or down, and then press the Enter (up/down) switch.

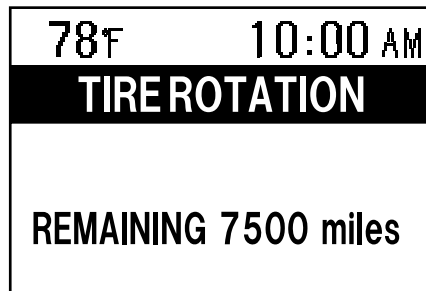

### NOTE

- The current remaining distance and days is displayed.
- Even if the remaining distance or days have surpassed 0, the display does not display a minus (—) and leaves the value at 0.

4. Press the Enter (up/down) switch.

## Interior Equipment

5. Select SET and press the Enter (up/down) switch.

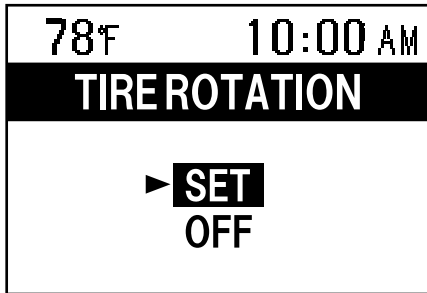

### NOTE

If the SERVICE DUE item has been set, both the days and distance can be selected. Because the tire rotation item can only be set according to distance, the screen for setting distance is displayed when SET is selected.

6. The DISTANCE or DAYS screen is displayed, and the remaining distance and days values return to the values previously set. If no changes are necessary, press the Enter (up/down) switch.

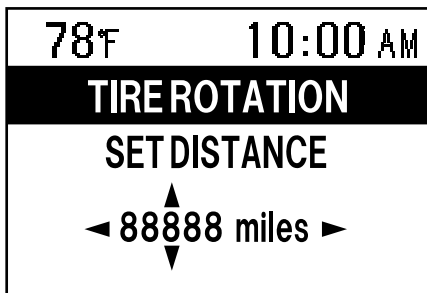

### NOTE

- If the settings are changed from the initial values, the values which you set are displayed, not the initial values.
- Even if the battery is disconnected, the remaining distance and days information is not erased.
- If the multi information display is replaced or repaired, there is the possibility that the remaining distance and days information may be erased.

### Method for turning the system off

The maintenance monitor can be turned off even after it has been turned on. If you want to turn it off, the remaining distance and days calculation to the next maintenance period is stopped, and a message does not display to indicate an approaching maintenance period.

1. Press the INFO switch until the SETTINGS screen is displayed.
2. Select MAINTENANCE by pressing the Enter (up/down) switch up or down, and then press the Enter (up/down) switch.

Interior Comfort

## Interior Equipment

3. Select the item you want to turn off (TIRE ROTATION or SERVICE DUE) by pressing the Enter (up/down) switch up or down, and then press the Enter (up/down) switch.



4. Select OFF and press the Enter (up/down) switch.

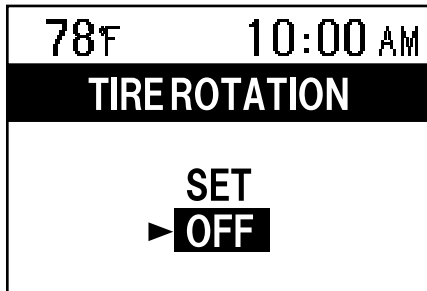

### ▼ Warning Indicator

The following warning indicators are displayed according to necessity. Warning indicators are displayed regardless of the multi information display operation.

- DOOR OPEN
- TRUNK OPEN (including the liftgate)
- TIGHTEN FUEL CAP (Displayed when the check fuel cap warning light illuminates in the instrument cluster.)
- CHECK TIRE PRESSURE

- RELEASE PARKING BRAKE
- Advanced Keyless Entry System related
  - KEY BATTERY IS LOW
  - ADVANCED KEY NOT FOUND
  - MOVE SHIFT LEVER TO P
  - DEPRESS BRAKE PEDAL TO START ENGINE
  - DEPRESS CLUTCH PEDAL TO START ENGINE
  - USE AUXILIARY KEY

### NOTE

When more than two warnings occur at the same time, indicators are switched at each specified time.

### ▼ Settings

The following settings can be changed:

- Screen adjustment (Brightness/contrast, screen-off)\*
- Buzzer volume (Ignition key reminder, lights-on reminder, Blind Spot Monitoring (BSM) warning beep)
- Turn indicator sound
- Temperature unit
- Display language

### NOTE

A personalized function is available to change the distance unit.

Refer to Personalization Features on page 10-13.

The data for the trip computer average fuel economy and the average vehicle speed can also be reset.

### To change settings

1. Press the INFO switch until the SETTINGS screen is displayed.

6-186 \*Some models.

## Interior Equipment

2. Select PREFERENCES by pressing the Enter (up/down) switch up or down, and then press the Enter (up/down) switch.
3. Select the setting item you want to change by pressing the Enter (up/down) switch up or down, and then press the Enter (up/down) switch.
4. Select the desired setting by pressing the Enter (up/down) switch up or down, and then press the Enter (up/down) switch.

### NOTE

The buzzer volume for both the ignition key reminder and the lights-on reminder is changed simultaneously. If you prefer separate buzzer volume settings, consult an Authorized Mazda Dealer. If separate buzzer volume settings have been done at an Authorized Mazda Dealer, you will be unable to change the settings.

### Resetting the data for the trip computer average fuel economy and the average vehicle speed

1. Press the INFO switch until the SETTINGS screen is displayed.
2. Select RESET AVERAGES and press the Enter (up/down) switch.
3. Select FUEL ECONOMY or SPEED, and press the Enter (up/down) switch.

## Cup Holder

### **⚠ WARNING**

**Never use a cup holder to hold hot liquids while the vehicle is moving:**  
Using a cup holder to hold hot liquids while the vehicle is moving is dangerous. If the contents spill, you could be scalded.

### **⚠ CAUTION**

To reduce the possibility of injury in an accident or a sudden stop, keep the cup holders closed when they are not in use, or when using them for storage.

### ▼ Front

To use, open the cover.

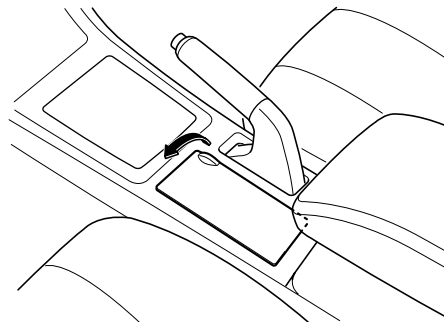

Interior Comfort

## Interior Equipment

### ▼ Rear\*

The rear cup holder is on the rear center armrest.

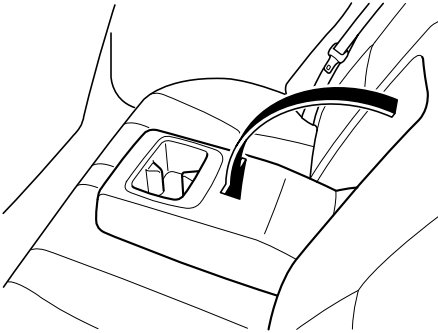

### Bottle Holder

Bottle holders are on the inside of the doors.

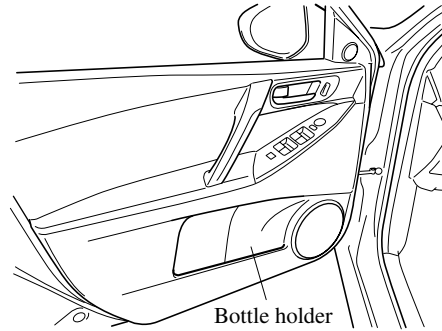

### ⚠ CAUTION

*Do not use the bottle holders for containers without caps. The contents may spill when the door is opened or closed.*



Interior Comfort  
**Interior Equipment**

### Storage Compartments

#### **! WARNING**

**Keep storage boxes closed when driving:**

*Driving with the storage boxes open is dangerous. To reduce the possibility of injury in an accident or a sudden stop, keep the storage boxes closed when driving.*

#### **! CAUTION**

*Do not leave lighters or eyeglasses in the storage boxes while parked under the sun. A lighter could explode or the plastic material in eyeglasses could deform and crack from high temperature.*

#### **▼ Overhead Console \***

This console box is designed to store eyeglasses or other accessories. Push and release to open.

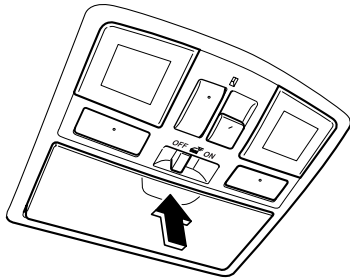

#### **▼ Center Pocket**

To use, press the cover and open it.  
**With Seat Warmer**

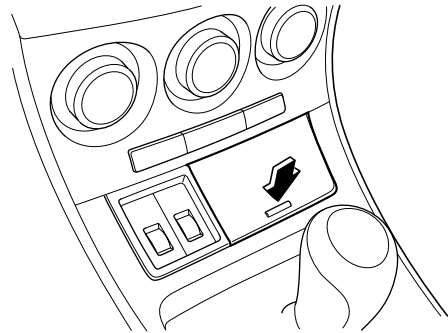

#### **Without Seat Warmer**

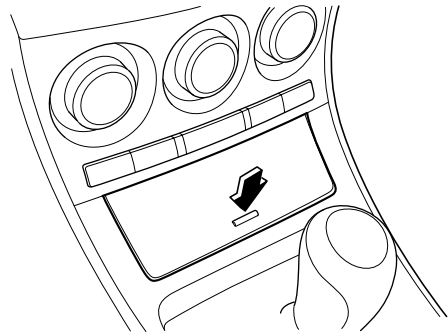

\*Some models. **6-189**

Interior Comfort

## Interior Equipment

### ▼ Glove Compartment

To open the glove compartment, pull the latch toward you.

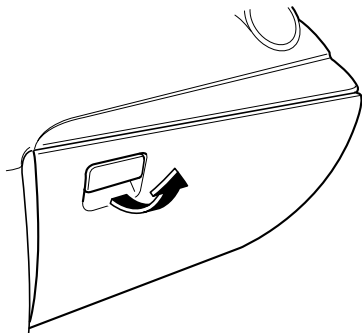

To close the glove compartment, firmly press in the center of the glove compartment lid.

### ▼ Center Console

To open, pull the lower release handle.

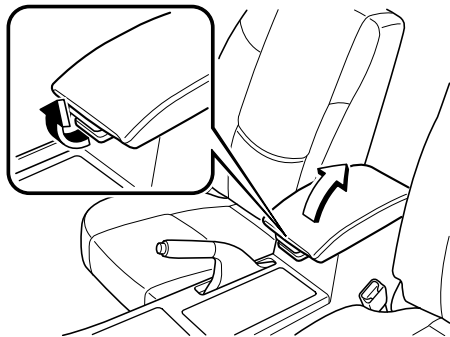

### Storage tray

The storage tray can be installed to the left/right side of the center console.

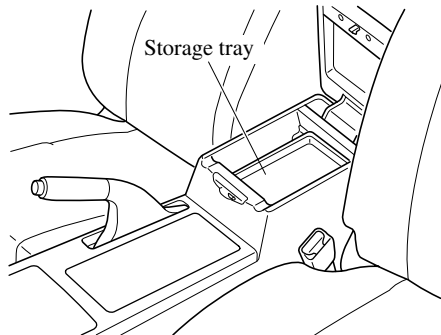

### Using the armrest\*

#### **⚠ CAUTION**

- *When sliding the armrest, be careful not to hit a drink cup placed in a cup holder and spill its contents. Remove cups or other drink containers from the cup holders before pulling out the armrest.*
- *Before opening the center console, store the armrest first. Otherwise, the armrest or center console may be damaged.*

## Interior Equipment

Press the button to slide the armrest forward.

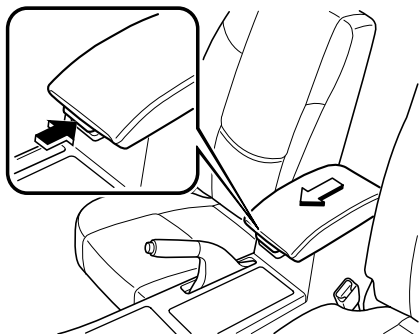

To retract the armrest, slide it completely to the rear.



### ▼ Cargo Securing Loops (5 Door)

#### **⚠ WARNING**

***Make sure luggage and cargo are secured before driving:***

*Not securing cargo while driving is dangerous as it could move or be crushed during sudden braking or a collision and cause injury.*

Use the loops in the luggage compartment to secure cargo with a rope or net. The tensile strength of the loops is 196 N (20 kgf, 44 lbf). Do not apply excessive force to the loops as it will damage them.

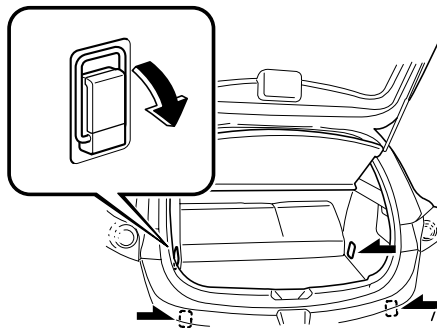

### ▼ Shopping Bag Hook (5 Door)

The shopping bag hook can be used for hanging shopping bags.

#### **⚠ CAUTION**

*Do not hang excessive weight on the shopping bag hook as it could be damaged.*

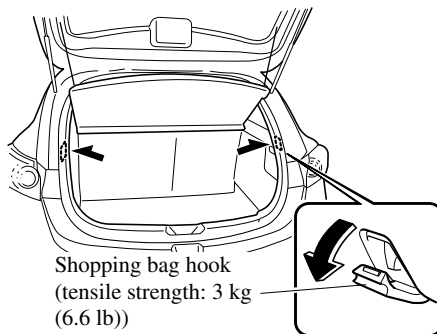

Interior Comfort

## Interior Equipment

### ▼ Rear Coat Hooks

#### **⚠ WARNING**

**Never hang heavy or sharp objects on the assist grips and coat hooks:**

*Hanging heavy or sharp-ended objects such as a coat hanger from the assist grips or coat hooks is dangerous as they can fly off and hit an occupant in the cabin if a curtain air bag was to deploy, which could result in serious injury or death.*

Always hang clothes on the coat hooks and the assist grips without hangers.

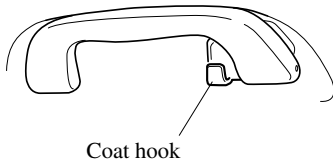

### Accessory Sockets

Only use genuine Mazda accessories or the equivalent requiring no greater than 120 W (DC 12 V, 10 A).

#### **Front**

The ignition must be switched to ACC or ON.

To use, press the cover and open it.

#### **With Seat Warmer**

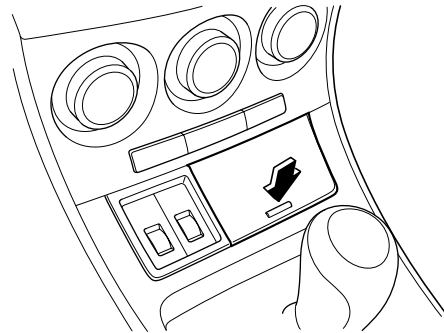

#### **Without Seat Warmer**

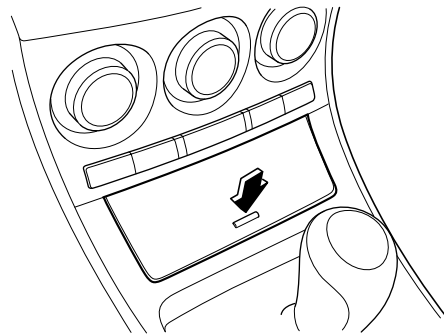

## Interior Equipment

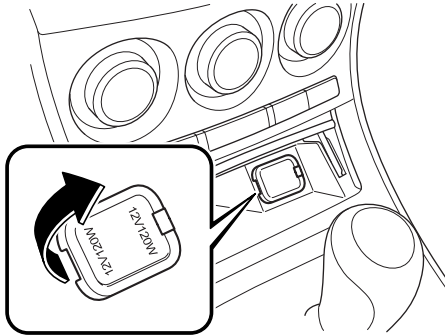

### Rear

The accessory sockets can be used regardless of whether the ignition is on or off.

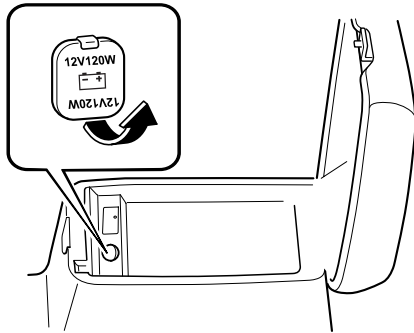

### CAUTION

- To prevent accessory socket damage or electrical failure, pay attention to the following:
  - Do not use accessories that require more than 120 W (DC 12 V, 10 A).
  - Do not use accessories that are not genuine Mazda accessories or the equivalent.
  - Close the cover when the accessory socket is not in use to prevent foreign objects and liquids from getting into the accessory socket.
  - Correctly insert the plug into the accessory socket.
  - Do not insert the cigarette lighter into the accessory socket.
- Noise may occur on the audio playback or TV reception depending on the device connected to the accessory socket.
- Depending on the device connected to the accessory socket, the vehicle's electrical system may be affected, which could cause the warning light to illuminate. Disconnect the connected device and make sure that the problem is resolved. If the problem is resolved, disconnect the device from the socket and switch the ignition off. If the problem is not resolved, consult an Authorized Mazda Dealer.

### NOTE

To prevent discharging of the battery, do not use the socket for long periods with the engine off or idling.

Interior Comfort

## Interior Equipment

---

### Connecting the accessory socket

1. Open the lid.
2. Pass the connection plug cord through the cutout of the console and insert the plug into the accessory socket.

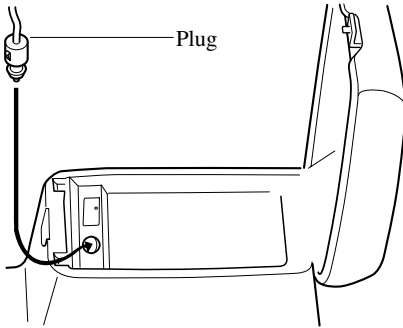

6-194

# 7

## In Case of an Emergency

Helpful information on what to do in an emergency.

|                                      |             |
|--------------------------------------|-------------|
| <b>Parking in an Emergency .....</b> | <b>7-2</b>  |
| Parking in an Emergency .....        | 7-2         |
| <b>Flat Tire .....</b>               | <b>7-3</b>  |
| Spare Tire and Tool Storage .....    | 7-3         |
| Changing a Flat Tire .....           | 7-9         |
| <b>Overheating .....</b>             | <b>7-16</b> |
| Overheating .....                    | 7-16        |
| <b>Emergency Starting .....</b>      | <b>7-18</b> |
| Starting a Flooded Engine .....      | 7-18        |
| Jump-Starting .....                  | 7-19        |
| Push-Starting .....                  | 7-24        |
| <b>Emergency Towing .....</b>        | <b>7-25</b> |
| Towing Description .....             | 7-25        |
| Tiedown Hook .....                   | 7-26        |
| Recreational Towing .....            | 7-28        |

In Case of an Emergency

## Parking in an Emergency

### Parking in an Emergency

The hazard warning lights should always be used when you stop on or near a roadway in an emergency.

The hazard warning lights warn other drivers that your vehicle is a traffic hazard and that they must take extreme caution when near it.

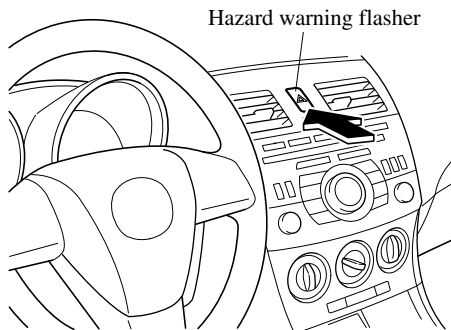

Depress the hazard warning flasher and all the turn signals will flash.

#### **NOTE**

- *The turn signals do not work when the hazard warning lights are on.*
- *Check local regulations about the use of hazard warning lights while the vehicle is being towed to verify that it is not in violation of the law.*



In Case of an Emergency  
**Flat Tire**

## Spare Tire and Tool Storage

Spare tire and tools are stored in the locations illustrated in the diagram.

### 4 Door

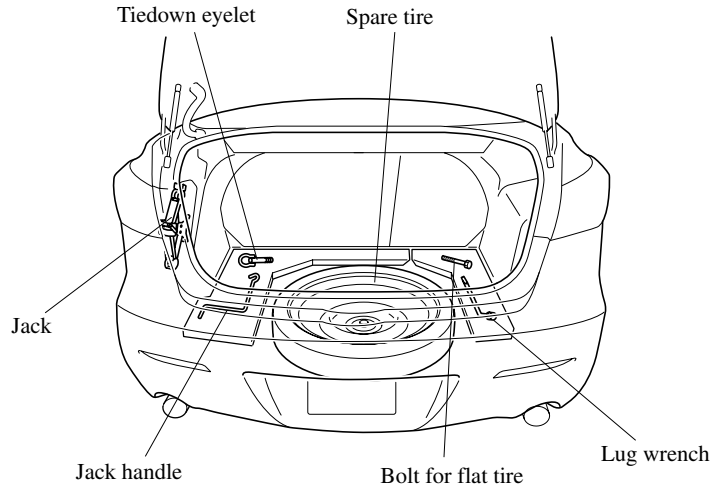

In Case of an Emergency

# Flat Tire

## 5 Door (Type A)

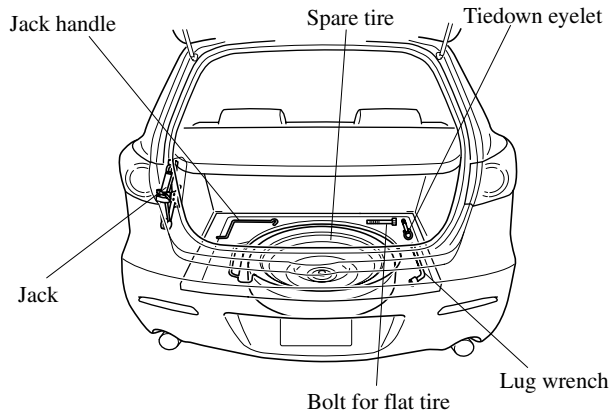

## (Type B)

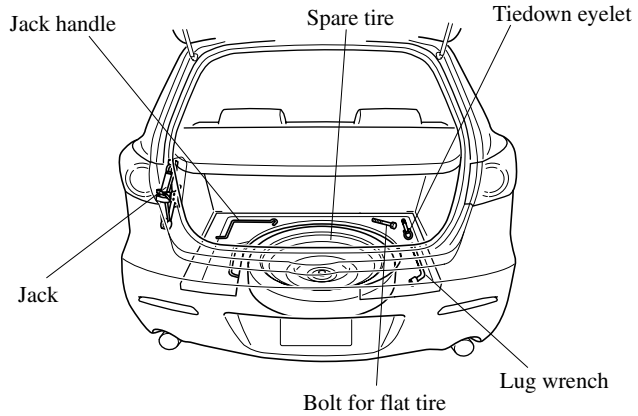

In Case of an Emergency  
**Flat Tire**

▼ **Jack**

**To remove the jack**

**(4 Door)**

1. Remove the cover.

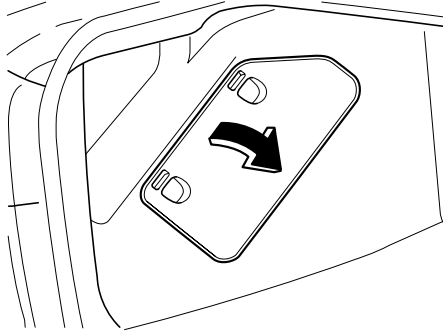

2. Turn the wing bolt and jack screw counterclockwise.

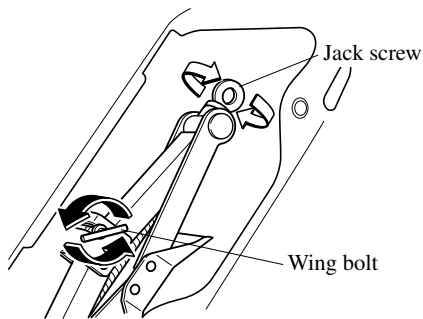

**(5 Door)**

1. Turn the knob and remove the cover.

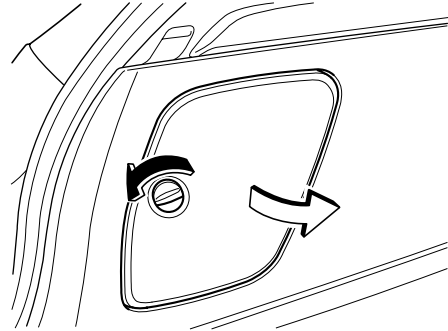

2. Turn the wing bolt and jack screw counterclockwise.

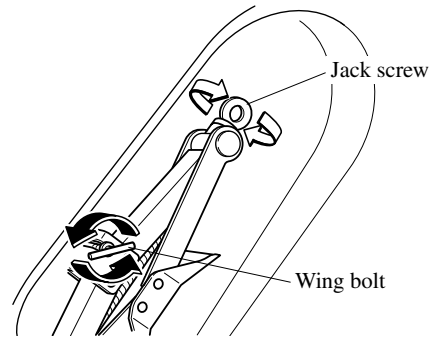

In Case of an Emergency

## Flat Tire

### To secure the jack

1. Insert the wing bolt into the jack with the jack screw pointing up and turn the wing bolt clockwise to temporarily tighten it.
2. Turn the jack screw in the direction shown in the figure.

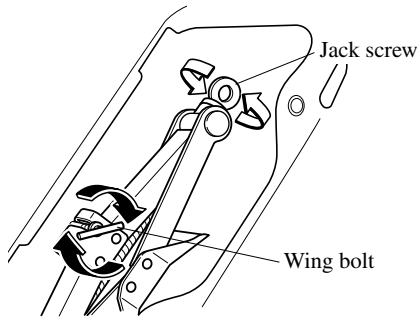

3. Turn the wing bolt completely to secure the jack.

### **NOTE**

*If the jack is not completely secured, it could rattle while driving. Make sure the jack screw is sufficiently tightened.*

### Maintenance

- Always keep the jack clean.
- Make sure the moving parts are kept free from dirt or rust.
- Make sure the screw thread is adequately lubricated.

### ▼ Spare Tire

Your Mazda has a temporary spare tire. The temporary spare tire is lighter and smaller than a conventional tire, and is designed only for emergency use and should be used only for VERY short periods. Temporary spare tires should NEVER be used for long drives or extended periods.

### **⚠ WARNING**

**Do not install the temporary spare tire on the front wheels (driving wheels):**

*Driving with the temporary spare tire on one of the front driving wheels is dangerous. Handling will be affected. You could lose control of the vehicle, especially on ice or snow bound roads, and have an accident. Move a regular tire to the front wheel and install the temporary spare tire to the rear.*

## Flat Tire

### **CAUTION**

- *When using the temporary spare tire, driving stability may decrease compared to when using only the conventional tire. Drive carefully.*
- *To avoid damage to the temporary spare tire or to the vehicle, observe the following precautions:*
  - *Do not exceed 80 km/h (50 mph).*
  - *Avoid driving over obstacles. Also, do not drive through an automatic car wash. This tire's diameter is smaller than a conventional tire, so the ground clearance is reduced about 10 mm (0.4 in).*
  - *Do not use a tire chain on this tire because it will not fit properly.*
  - *Do not use your temporary spare tire on any other vehicle, it has been designed only for your Mazda.*
  - *Use only one temporary spare tire on your vehicle at the same time.*
- **(With limited slip differential)**  
*When using the temporary spare tire on the front axle, replace it with a standard tire as soon as possible. The size difference between the spare and the standard tire will cause the limited slip differential to malfunction.*

### **NOTE**

#### **(With Tire Pressure Monitoring System)**

*A tire pressure sensor is not installed to the temporary spare tire. The warning light will flash continuously while the temporary spare tire is being used (page 5-33).*

### **To remove the spare tire**

#### **4 Door**

1. Remove the trunk mat.

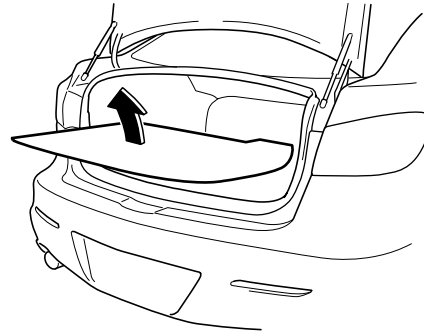

2. Turn the tire hold-down bolt counterclockwise using the lug wrench.

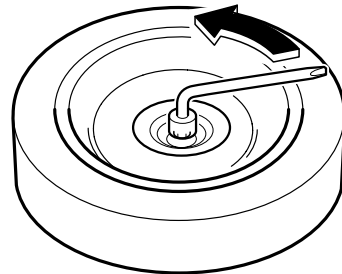

#### **5 Door**

1. Remove the trunk mat.

In Case of an Emergency

## Flat Tire

2. For vehicles equipped with a sub-woofer, uncouple the connector.

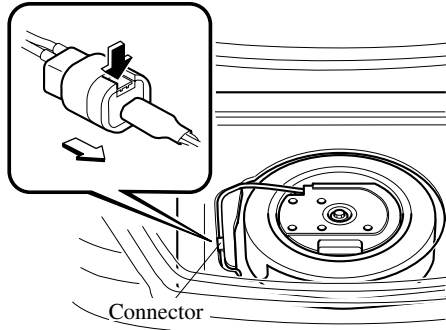

**NOTE**

Extra strength may be required to uncouple the connector. Be sure to squeeze the tab firmly.

3. For vehicles equipped with a sub-woofer, loosen the hold-down bolt and remove the woofer and spare tire.

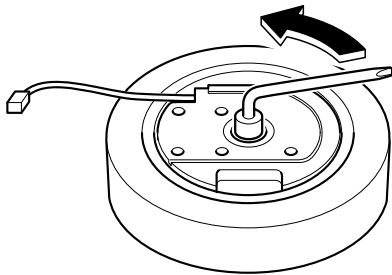

For vehicles not equipped with a sub-woofer, loosen the hold-down bolt and remove the spare tire.

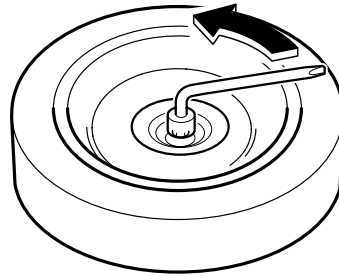

**To secure the spare tire**

Perform the removal procedure in reverse. Secure the spare tire using the hold-down bolt and tire clamp in the correct position as illustrated.

**NOTE**

**(5 Door)**

When storing a conventional tire in a vehicle equipped with a sub-woofer, you cannot connect the connector on the trunk board.

**Without sub-woofer**

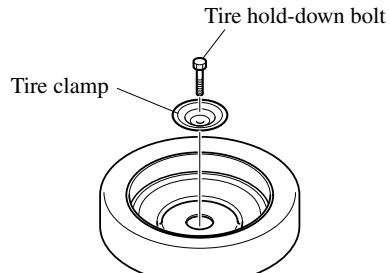

In Case of an Emergency

## Flat Tire

### With sub-woofer

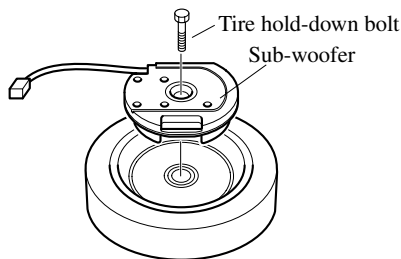

## Changing a Flat Tire

### NOTE

If the following occurs while driving, it could indicate a flat tire.

- Steering becomes difficult.
- The vehicle begins to vibrate excessively.
- The vehicle pulls in one direction.

If you have a flat tire, drive slowly to a level spot that is well off the road and out of the way of traffic to change the tire. Stopping in traffic or on the shoulder of a busy road is dangerous.

### **⚠ WARNING**

**Be sure to follow the directions for changing a tire:**

*Changing a tire is dangerous if not done properly. The vehicle can slip off the jack and seriously injure someone. No person should place any portion of their body under a vehicle that is supported by a jack.*

**Never allow anyone inside a vehicle supported by a jack:**

*Allowing someone to remain in a vehicle supported by a jack is dangerous. The occupant could cause the vehicle to fall resulting in serious injury.*

### **⚠ CAUTION**

**(With Tire Pressure Monitoring System)**

*The wheels equipped on your Mazda are specially designed for installation of the tire pressure sensors. Do not use non-genuine wheels, otherwise it may not be possible to install the tire pressure sensors.*

In Case of an Emergency

## Flat Tire

### NOTE

- Make sure the jack is well lubricated before using it.

#### (With Tire Pressure Monitoring System)

- Be sure to register the tire pressure sensor ID signal code whenever tires or wheels are changed (page 5-35).

1. Park on a level surface off the right-of-way and firmly set the parking brake.
2. Put a vehicle with an automatic transaxle in Park (P), a manual transaxle in Reverse (R) or 1, and turn off the engine.
3. Turn on the hazard warning flasher.
4. Have everyone get out of the vehicle and away from the vehicle and traffic.
5. Remove the jack, tool, and spare tire (page 7-3).
6. Block the wheel diagonally opposite the flat tire. When blocking a wheel, place a tire block both in front and behind the tire.

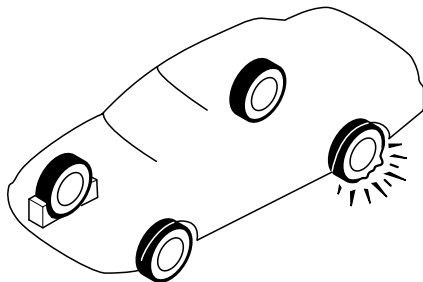

### NOTE

When blocking a tire, use rocks or wood blocks of sufficient size if possible to hold the tire in place.

### ▼ Removing a Flat Tire

1. If your vehicle is equipped with a wheel cover, pry off the wheel cover with the beveled end of the lug wrench.

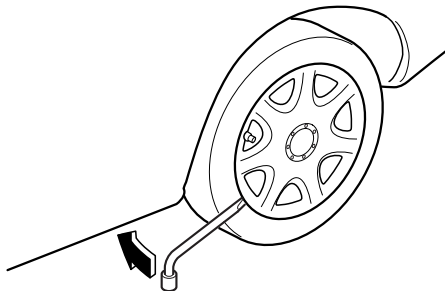

### NOTE

Force the end of the lug wrench firmly between wheel and cover, or removal will be difficult.

### ⚠ CAUTION

There is a valve-stem mark inside the wheel cover. When installing the wheel cover, align this mark with the tire's valve stem.

Damage could occur during installation if the wheel cover is not properly aligned.



In Case of an Emergency  
**Flat Tire**

2. Loosen the lug nuts by turning them counterclockwise one turn each, but do not remove any lug nuts until the tire has been raised off the ground.

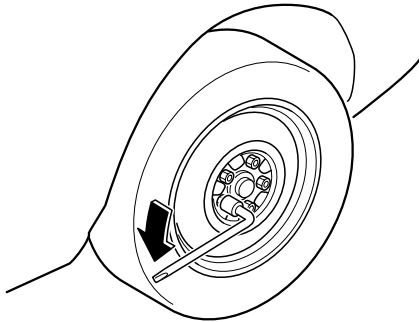

3. Place the jack on the ground.
4. Turn the jack screw in the direction shown in the figure and adjust the jack head so that it is close to the jack-up position.

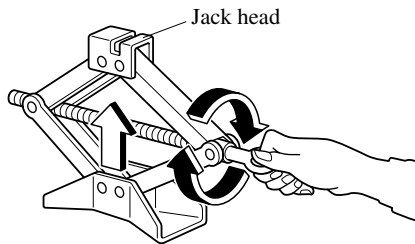

5. Place the jack under the jack-up position closest to the tire being changed with the jack head squarely under the jack-up point.

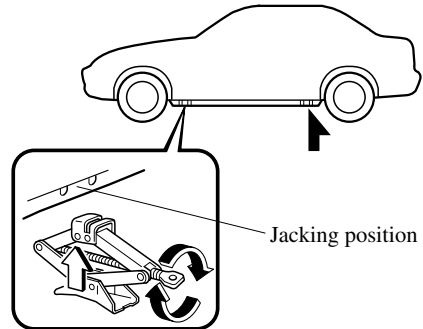

6. Continue raising the jack head gradually by rotating the screw with your hand until the jack head is inserted into the jack-up position.

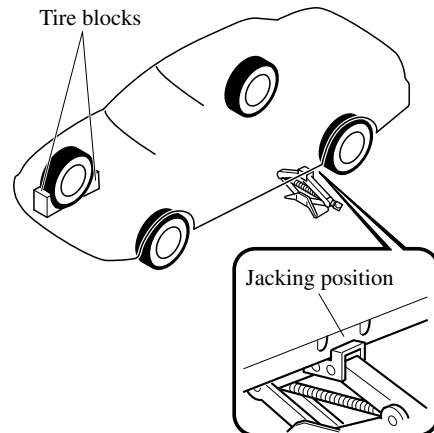

In Case of an Emergency

## Flat Tire

### **⚠ WARNING**

**Use only the front and rear jacking positions recommended in this manual:**

Attempting to jack the vehicle in positions other than those recommended in this manual is dangerous. The vehicle could slip off the jack and seriously injure or even kill someone. Use only the front and rear jacking positions recommended in this manual.

**Do not jack up the vehicle in a position other than the designated jack-up position or place any objects on or under the jack:**

Jacking up the vehicle in a position other than the designated jack-up position or placing objects on or under the jack is dangerous as it could deform the vehicle body or the vehicle could fall off the jack resulting in an accident.

**Use only the jack provided with your Mazda:**

Using a jack that is not designed for your Mazda is dangerous. The vehicle could slip off the jack and seriously injure someone.

**Never place objects under the jack:**

Jacking the vehicle with an object under the jack is dangerous. The jack could slip and someone could be seriously injured by the jack or the falling vehicle.

### **NOTE**

If it is difficult to set the jack due to a lowered vehicle height for reasons such as a tire puncture, insert the jack from the middle of the vehicle and slide it to the designated jack-up point.

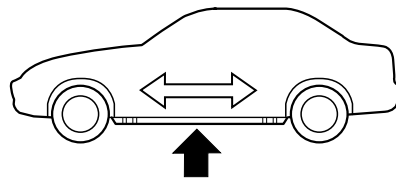

7. Insert the jack handle into the jack.
8. Turn the jack handle clockwise and raise the vehicle high enough so that the spare tire can be installed. Before removing the lug nuts, make sure your Mazda is firmly in position and that it cannot slip or move.

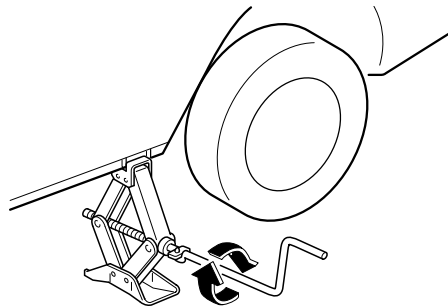

### **⚠ WARNING**

**Do not jack up the vehicle higher than is necessary:**

*Jacking up the vehicle higher than is necessary is dangerous as it could destabilize the vehicle resulting in an accident.*

**Do not start the engine or shake the vehicle while it is jacked up:**

*Starting the engine or shaking the vehicle while it is jacked up is dangerous as it could cause the vehicle to fall off the jack resulting in an accident.*

**Never go under the vehicle while it is jacked up:**

*Going under the vehicle while it is jacked up is dangerous as it could result in death or serious injury if the vehicle were to fall off the jack.*

9. Remove the lug nuts by turning them counterclockwise; then remove the wheel.

### **▼ Locking Lug Nuts \***

If your vehicle has optional anti-theft wheel lug nuts, one on each wheel will lock the tires and you must use a special key to unlock them. This key is attached to the lug wrench and is stored with the spare tire. Register them with the lock manufacturer by filling out the card provided in the glove compartment and mailing it in the accompanying envelope. If you lose this key, consult an Authorized Mazda Dealer or use the lock manufacturer's order form, which is with the registration card.

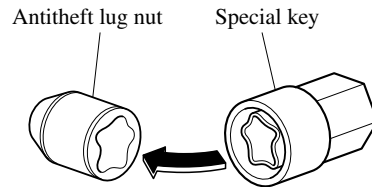

### **To remove an anti-theft lug nut**

1. Obtain the key for the anti-theft lug nut.
2. Place the key on top of the nut, and be sure to hold the key square to it. If you hold the key at an angle, you may damage both key and nut. Do not use a power impact wrench.
3. Place the lug wrench on top of the key and apply pressure. Turn the wrench counterclockwise.

In Case of an Emergency

## Flat Tire

### To install the nut

1. Place the key on top of the nut, and be sure to hold the key square to it. If you hold the key at an angle, you may damage both key and nut. Do not use a power impact wrench.
2. Place the lug wrench on top of the key, apply pressure, and turn it clockwise.

### ▼ Mounting the Spare Tire

1. Remove dirt and grime from the mounting surfaces of the wheel and hub, including the hub bolts, with a cloth.

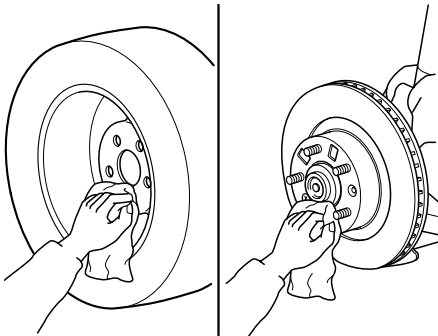

### ⚠ WARNING

**Make sure the mounting surfaces of the wheel, hub and lug nuts are clean before changing or replacing tires:**

*When changing or replacing a tire, not removing dirt and grime from the mounting surfaces of the wheel, hub and hub bolts is dangerous. The lug nuts could loosen while driving and cause the tire to come off, resulting in an accident.*

2. Mount the spare tire.

3. Install the lug nuts with the beveled edge inward; tighten them by hand.

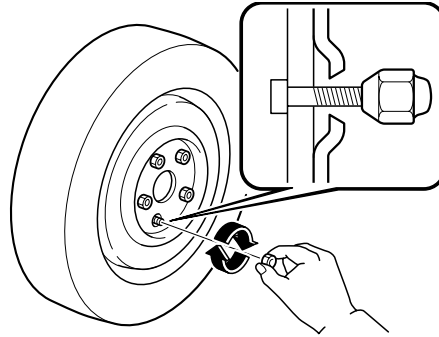

### ⚠ WARNING

**Do not apply oil or grease to lug nuts and bolts and do not tighten the lug nuts beyond the recommended tightening torque:**

*Applying oil or grease to lug nuts and bolts is dangerous. The lug nuts could loosen while driving and cause the tire to come off, resulting in an accident. In addition, lug nuts and bolts could be damaged if tightened more than necessary.*

4. Turn the jack handle counterclockwise and lower the vehicle. Use the lug wrench to tighten the nuts in the order shown.

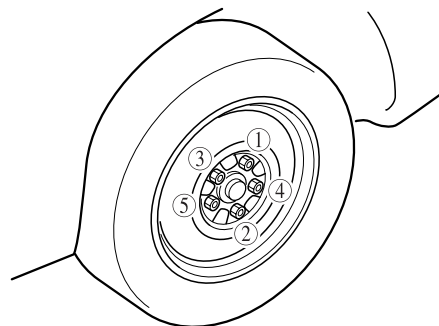

## Flat Tire

If you are unsure of how tight the nuts should be, have them inspected at an Authorized Mazda Dealer.

| Nut tightening torque |                      |
|-----------------------|----------------------|
| N·m (kgf·m, ft·lbf)   | 88—118 (9—12, 65—87) |

### **! WARNING**

**Always securely and correctly tighten the lug nuts:**

*Improperly or loosely tightened lug nuts are dangerous. The wheel could wobble or come off. This could result in loss of vehicle control and cause a serious accident.*

**Be sure to reinstall the same nuts you removed or replace them with metric nuts of the same configuration:**

*Because the wheel studs and lug nuts on your Mazda have metric threads, using a non-metric nut is dangerous. On a metric stud, it would not secure the wheel and would damage the stud, which could cause the wheel to slip off and cause an accident.*

5. Store the damaged tire, using the tire hold-down bolt to hold it in place.

**(Without sub-woofer)**

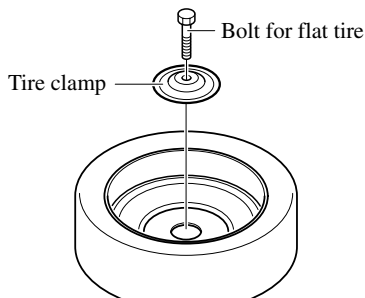

**(With sub-woofer)**

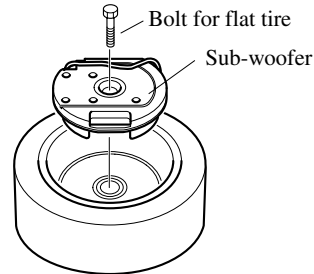

6. Remove the tire blocks and store the tools, jack, and damaged tire.
7. Check the inflation pressure. Refer to Tires on page 10-12.
8. Have the flat tire repaired or replaced as soon as possible.

### **! WARNING**

**Do not drive with any tires that have incorrect air pressure:**

*Driving on tires with incorrect air pressure is dangerous. Tires with incorrect pressure could affect handling and result in an accident. When you check the regular tires' air pressure, check the spare tire, too.*

#### **NOTE**

**(With Tire Pressure Monitoring System)**

*A tire pressure sensor is not installed to the temporary spare tire. The warning light will flash continuously while the temporary spare tire is being used (page 5-33).*

#### **NOTE**

*To prevent the jack and tool from rattling, store them properly.*

In Case of an Emergency

## Overheating

### Overheating

If the High engine coolant temperature warning light illuminates, the vehicle loses power, or you hear a loud knocking or pinging noise, the engine is probably too hot.

#### **WARNING**



**Switch the ignition to off and make sure the fan is not running before attempting to work near the cooling fan:**

*Working near the cooling fan when it is running is dangerous. The fan could continue running indefinitely even if the engine has stopped and the engine compartment temperature is high. You could be hit by the fan and seriously injured.*



**Do not remove the cooling system cap when the engine and radiator are hot:**

*When the engine and radiator are hot, scalding coolant and steam may shoot out under pressure and cause serious injury.*

**Open the hood ONLY after steam is no longer escaping from the engine:**

*Steam from an overheated engine is dangerous. The escaping steam could seriously burn you.*

If the High engine coolant temperature warning light illuminates:

1. Drive safely to the side of the road and park off the right-of-way.

2. Put a vehicle with an automatic transaxle in park (P), a manual transaxle in neutral.
3. Apply the parking brake.
4. Turn off the air conditioner.
5. Check whether coolant or steam is escaping from under the hood or from the engine compartment.

#### **If steam is coming from the engine compartment:**

Do not go near the front of the vehicle. Stop the engine.

Wait until the steam dissipates, then open the hood and start the engine.

#### **If neither coolant nor steam is escaping:**

Open the hood and idle the engine until it cools.

#### **CAUTION**

*If the cooling fan does not operate while the engine is running, the engine temperature will increase. Stop the engine and call an Authorized Mazda Dealer.*

6. Make sure the cooling fan is operating, then turn off the engine after the temperature has decreased.
7. When cool, check the coolant reservoir level.  
If it's low, look for coolant leaks from the radiator and hoses.

In Case of an Emergency  
**Overheating**

**If you find a leak or other damage, or if coolant is still leaking:**

Stop the engine and call an Authorized Mazda Dealer.

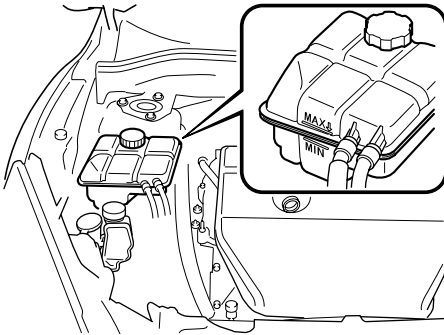

**If you find no problems, the engine is cool, and no leaks are obvious:**

Carefully add coolant as required (page 8-25).

**⚠ CAUTION**

*If the engine continues to overheat or frequently overheats, have the cooling system inspected. The engine could be seriously damaged unless repairs are made. Consult an Authorized Mazda Dealer.*

In Case of an Emergency

## Emergency Starting

### Starting a Flooded Engine

If the engine fails to start, it may be flooded (excessive fuel in the engine).

Follow this procedure:

#### (Without Advanced Keyless Entry & Push Button Start System)

1. If the engine does not start within five seconds on the first try, switch the ignition off, wait ten seconds and try again.
2. Make sure the parking brake is on.
3. Depress the accelerator all the way and hold it there.
4. Depress the clutch pedal (Manual transaxle) or the brake pedal (Automatic transaxle).
5. Switch the ignition to START and hold it there—for up to ten seconds. If the engine starts, release the key and accelerator immediately because the engine will suddenly rev up.
6. If the engine fails to start, crank it without depressing the accelerator—for up to ten seconds.

#### (With Advanced Keyless Entry & Push Button Start System)

1. If the engine does not start within five seconds on the first try, wait ten seconds and try again.
2. Make sure the parking brake is on.
3. Depress the accelerator all the way and hold it there.

4. Depress the clutch pedal (Manual transaxle) or the brake pedal (Automatic transaxle), then press the push button start. If the engine starts, release the accelerator immediately because the engine will suddenly rev up.
5. If the engine fails to start, crank it without depressing the accelerator.

If the engine still does not start using the above procedure, have your vehicle inspected by an Authorized Mazda Dealer.



In Case of an Emergency  
**Emergency Starting**

## Jump-Starting

Jump-starting is dangerous if done incorrectly. So follow the procedure carefully. If you feel unsure about jump-starting, we strongly recommend that you have a competent service technician do the work.

### **WARNING**



#### **Follow These Precautions Carefully:**

*To ensure safe and correct handling of the battery, read the following precautions carefully before using the battery or inspecting it.*



#### **Always wear eye protection when working near the battery:**

*Working without eye protection is dangerous. Battery fluid contains SULFURIC ACID which could cause blindness if splashed into your eyes. Also, hydrogen gas produced during normal battery operation, could ignite and cause the battery to explode.*



#### **Wear eye protection and protective gloves to prevent contact with battery fluid:**

*Spilled battery fluid is dangerous.*

*Battery fluid contains SULFURIC ACID which could cause serious injuries if it gets in eyes, skin or clothing. If this happens, immediately flush your eyes with water for 15 minutes or wash your skin thoroughly and get medical attention.*



#### **Always keep batteries out of the reach of children:**

*Allowing children to play near batteries is dangerous. Battery fluid could cause serious injuries if it gets in the eyes or on the skin.*



#### **Do not allow the positive (+) terminal to contact any other metal object that could cause sparks:**

*Flames and sparks near open battery cells are dangerous. Hydrogen gas, produced during normal battery operation, could ignite and cause the battery to explode. An exploding battery can cause serious burns and injuries. When working near a battery, do not allow metal tools to contact the positive (+) or negative (-) terminal of the battery.*

In Case of an Emergency

## Emergency Starting



**Keep all flames, including cigarettes, and sparks away from open battery cells:**

Flames and sparks near open battery cells are dangerous. Hydrogen gas, produced during normal battery operation, could ignite and cause the battery to explode. An exploding battery can cause serious burns and injuries.

**Do not jump-start a frozen battery or one with a low fluid level:**

Jump-starting a frozen battery or one with a low fluid level is dangerous. It may rupture or explode, causing serious injury.

**Connect the negative cable to a good ground point away from the battery:**

Connecting the end of the second jumper cable to the negative (–) terminal of the discharged battery is dangerous.

A spark could cause the gas around the battery to explode and injure someone.

**Route the jumper cables away from parts that will be moving:**

Connecting a jumper cable near or to moving parts (cooling fans, belts) is dangerous. The cable could get caught when the engine starts and cause serious injury.

### **CAUTION**

Use only a 12 V booster system. You can damage a 12 V starter, ignition system, and other electrical parts beyond repair with a 24 V power supply (two 12 V batteries in series or a 24 V motor generator set).

### SKYACTIV-G 2.0

Connect cables in numerical order and disconnect in reverse order.

Discharged battery

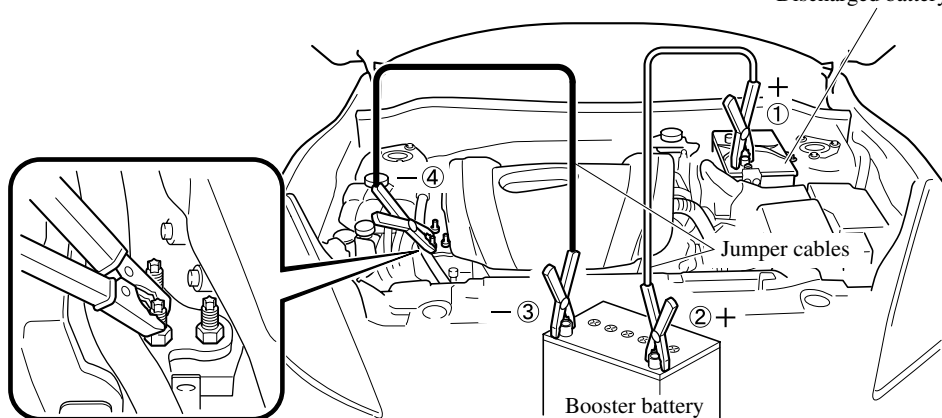

In Case of an Emergency  
**Emergency Starting**

**MZR 2.0, MZR 2.3 DISI Turbo and MZR 2.5**

Connect cables in numerical order and disconnect in reverse order.

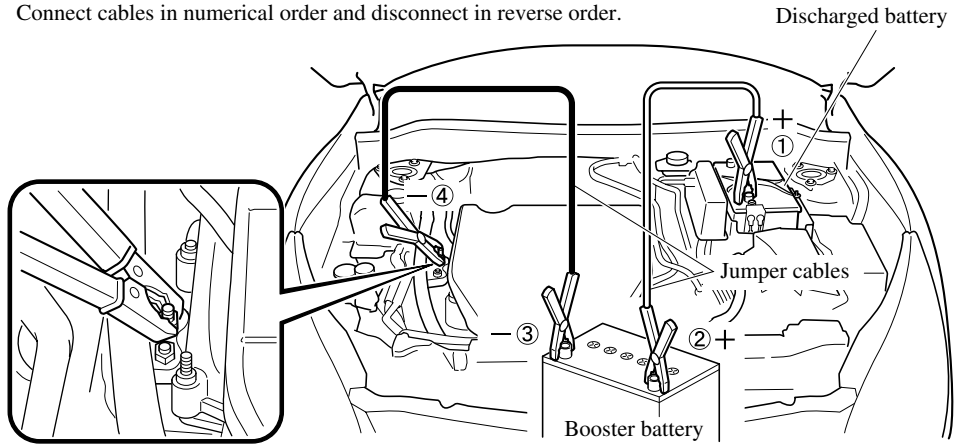

In Case of an Emergency

## Emergency Starting

1. Remove the battery cover from its front side.

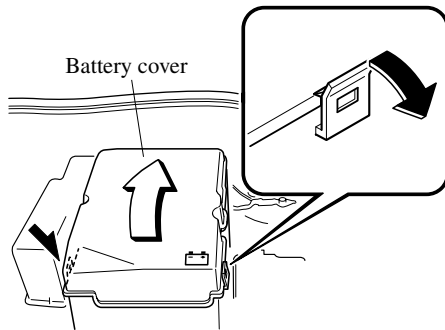

### CAUTION

- Do not use a tool which applies excessive force such as a screwdriver or pliers. If excessive force is applied to the clips, they could be damaged. To prevent damaging the battery cover, remove the battery cover using the following procedure.

- 1 Detach the clip facing the side of the vehicle first and pull it outward with your finger approx. 4 mm (0.2 in). Then, lift the cover slightly to clear the lock.

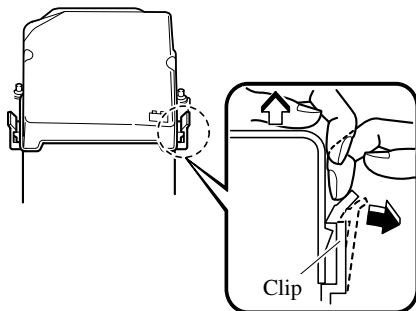

- 2 Detach the clip facing the vehicle interior first and pull it outward with your finger approx. 4 mm (0.2 in). Then, lift the cover slightly to clear the lock.

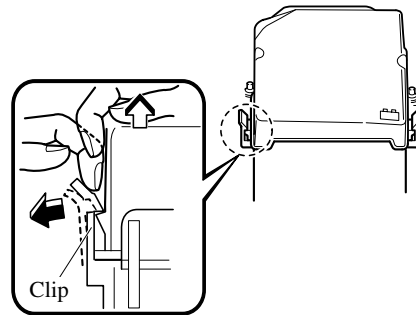

- 3 Pull out the battery cover being careful not to allow it to contact the cowl grille.

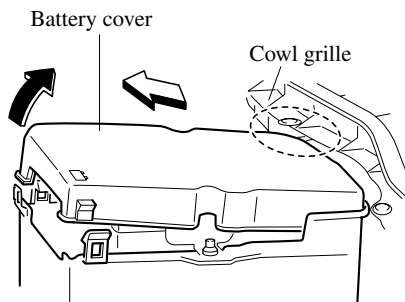

2. Make sure the booster battery is 12 V and that its negative terminal is grounded.
3. If the booster battery is in another vehicle, don't allow both vehicles to touch. Turn off the engine of the vehicle with the booster battery and all unnecessary electrical loads in both vehicles.

In Case of an Emergency  
**Emergency Starting**

4. Connect the jumper cables in the exact sequence as in the illustration.
  - Connect one end of a cable to the positive terminal on the discharged battery (1).
  - Attach the other end to the positive terminal on the booster battery (2).
  - Connect one end of the other cable to the negative terminal of the booster battery (3).
  - Connect the other end to the ground point indicated in the illustration away from the discharged battery (4).
5. Start the engine of the booster vehicle and run it a few minutes. Then start the engine of the other vehicle.
6. When finished, carefully disconnect the cables in the reverse order described in the illustration.
7. Install the battery cover.

**CAUTION**

- *Do not use a tool which applies excessive force such as a screwdriver or pliers. If excessive force is applied to the clips, they could be damaged. To prevent damaging the battery cover, install the battery cover using the following procedure.*

- 1 *Being careful not to contact the cowl grille, insert the tabs on the one end of the battery cover into the holes of the battery tray and engage the tabs.*

**SKYACTIV-G 2.0**

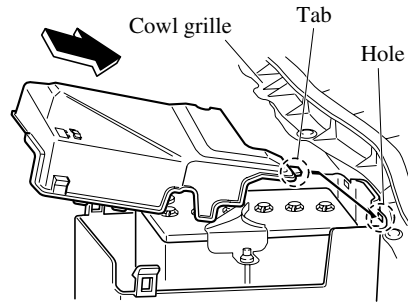

**MZR 2.0, MZR 2.3 DISI Turbo and MZR 2.5**

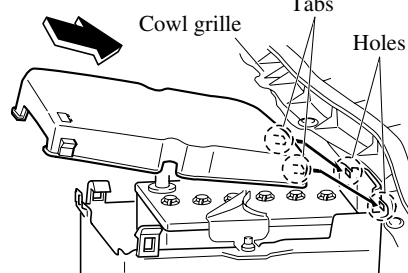

- 2 *Attach the clips on both sides of the battery cover.*

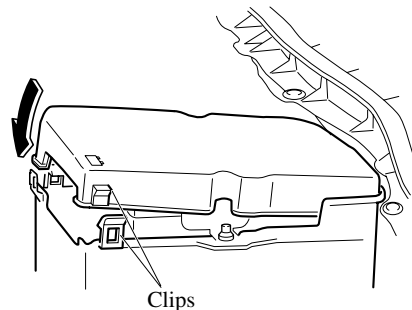

In Case of an Emergency

## Emergency Starting

### **NOTE**

*Verify that the covers are securely installed.*

### Push-Starting

Do not push-start your Mazda.

### **⚠ WARNING**

**Never tow a vehicle to start it:**

*Towing a vehicle to start it is dangerous. The vehicle being towed could surge forward when its engine starts, causing the two vehicles to collide. The occupants could be injured.*

### **⚠ CAUTION**

*Do not push-start a vehicle that has a manual transaxle. It can damage the emission control system.*

### **NOTE**

*You can't start a vehicle with an automatic transaxle by pushing it.*

In Case of an Emergency  
**Emergency Towing**

### Towing Description

We recommend that towing be done only by an Authorized Mazda Dealer or a commercial tow-truck service.

Proper lifting and towing are necessary to prevent damage to the vehicle. Government and local laws must be followed.

A towed vehicle usually should have its drive wheels (front wheels) off the ground. If excessive damage or other conditions prevent this, use wheel dollies.

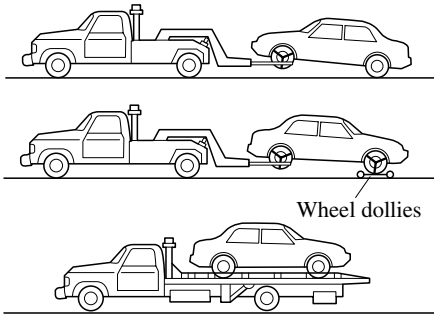

When towing with the rear wheels on the ground, release the parking brake.

### CAUTION

*Do not tow the vehicle pointed backward with driving wheels on the ground. This may cause internal damage to the transaxle.*

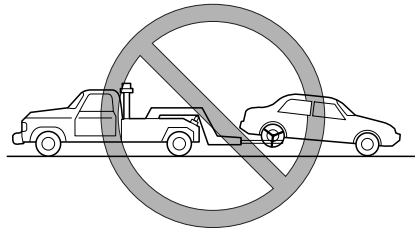

### CAUTION

*Do not tow with sling-type equipment. This could damage your vehicle. Use wheel-lift or flatbed equipment.*

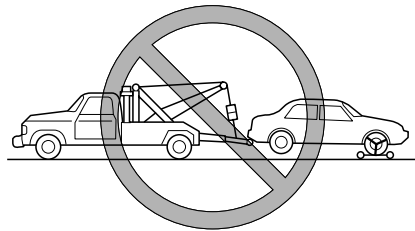

In Case of an Emergency

## Emergency Towing

### Tiedown Hook

#### **CAUTION**

Do not use the front and rear tiedown eyelets for towing the vehicle. They have been designed only for securing the vehicle to a transport vessel during shipping. Using the eyelets for any other purpose could result in the vehicle being damaged.

#### ▼ Tiedown Hook-Front

##### Type A

1. Remove the tiedown eyelet and the lug wrench from the trunk (page 7-3).
2. Wrap the lug wrench with a soft cloth to prevent damage to the bumper and remove the cover located on the front bumper.

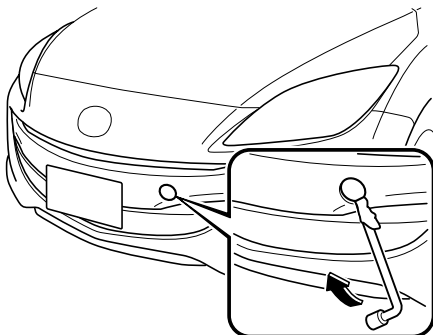

#### **NOTE**

Remove the cover completely and store it so as not to lose it.

3. Securely install the tiedown eyelet using the lug wrench.

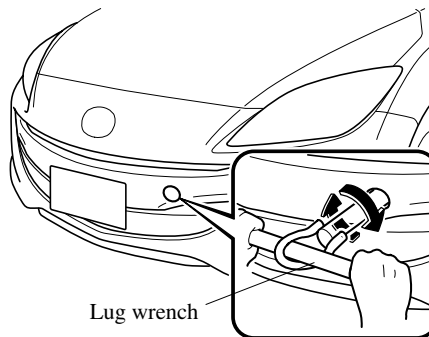

4. Hook the tying rope to the tiedown eyelet.

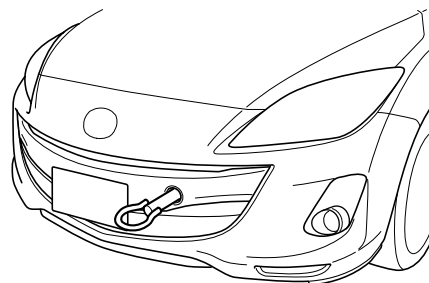

#### **CAUTION**

- If the tiedown eyelet is not securely tightened, it may loosen or disengage from the bumper when tying down the vehicle. Make sure that the tiedown eyelet is securely tightened to the bumper.
- The front tiedown hook is designed only for lashing the vehicle during overseas transport. Do not use the front tiedown hook for any other use such as transporting the vehicle on trucks or railway.



In Case of an Emergency  
**Emergency Towing**

**Type B**

1. Remove the tiedown eyelet from the trunk (page 7-3).
2. Remove the cover.

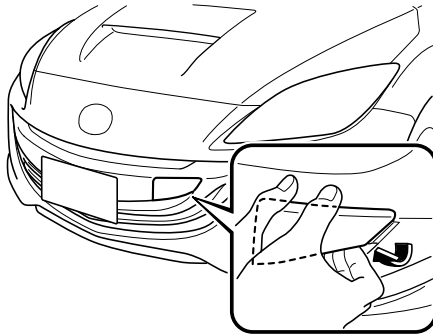

**NOTE**

Remove the cover completely and store it so as not to lose it.

3. Securely install the tiedown eyelet using the lug wrench.

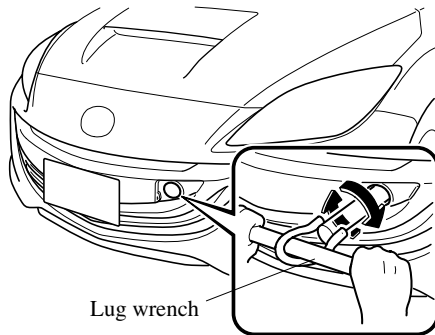

4. Hook the tying rope to the tiedown eyelet.

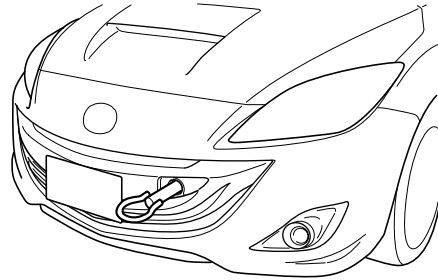

**CAUTION**

- If the tiedown eyelet is not securely tightened, it may loosen or disengage from the bumper when tying down the vehicle. Make sure that the tiedown eyelet is securely tightened to the bumper.
- The front tiedown hook is designed only for lashing the vehicle during overseas transport. Do not use the front tiedown hook for any other use such as transporting the vehicle on trucks or railway.

In Case of an Emergency

## Emergency Towing

### ▼ Tiedown Hook-Rear

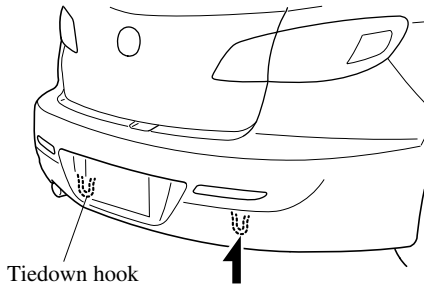

### **⚠ CAUTION**

*The rear tiedown hook is designed only for lashing the vehicle during overseas transport. Do not use the rear tiedown hook for any other use such as transporting the vehicle on trucks or railway.*

## Recreational Towing

An example of “recreational towing” is towing your vehicle behind a motorhome. The transaxle is not designed for towing this vehicle on all 4 wheels.

When doing recreational towing refer to “Towing Description” (page 7-25) and “Tiedown Hook” (page 7-26) and carefully follow the instructions.

# 8 Maintenance and Care

How to keep your Mazda in top condition.

|  |             |
|--|-------------|
| <b>Introduction .....</b>                                  | <b>8-2</b>  |
| Introduction .....   | 8-2         |
| <b>Scheduled Maintenance .....</b>                         | <b>8-4</b>  |
| Scheduled Maintenance (USA, Canada, and Puerto Rico) ..... | 8-4         |
| Scheduled Maintenance (Mexico) .....                       | 8-9         |
| <b>Owner Maintenance .....</b>                             | <b>8-16</b> |
| Owner Maintenance Schedule .....                           | 8-16        |
| Owner Maintenance Precautions .....                        | 8-17        |
| Engine Compartment Overview .....                          | 8-19        |
| Engine Oil .....   | 8-21        |
| Engine Coolant .....                                       | 8-25        |
| Brake/Clutch Fluid .....                                   | 8-27        |
| Power Steering Fluid .....                                 | 8-28        |
| Automatic Transaxle Fluid (ATF) * .....                    | 8-28        |
| Washer Fluid .....   | 8-30        |
| Body Lubrication .....                                     | 8-31        |
| Wiper Blades .....   | 8-31        |
| Battery .....  | 8-35        |
| Tires .....  | 8-39        |
| Light Bulbs .....  | 8-46        |
| Fuses .....  | 8-58        |
| <b>Appearance Care .....</b>                               | <b>8-65</b> |
| How to Minimize Environmental Paint Damage .....           | 8-65        |
| Exterior Care .....  | 8-67        |
| Interior Care .....  | 8-71        |

\*Some models. **8-1**

Maintenance and Care

## Introduction

### Introduction

Be extremely careful and prevent injury to yourself and others or damage to your vehicle when using this manual for inspection and maintenance.

If you are unsure about any procedure it describes, we strongly urge you to have a reliable and qualified service shop perform the work, preferably an Authorized Mazda Dealer.

Factory-trained Mazda technicians and genuine Mazda parts are best for your vehicle. Without this expertise and the parts that have been designed and made especially for your Mazda, inadequate, incomplete, and insufficient servicing may result in problems. This could lead to vehicle damage or an accident and injuries.

For expert advice and quality service, consult an Authorized Mazda Dealer.

To continue warranty eligibility and to protect your investment, it is your responsibility to properly maintain your vehicle according to factory recommended schedules outlined in this manual. As part of this you must keep your maintenance records, receipts, repair orders and any other documents as evidence this maintenance was performed. You must present these documents, should any warranty coverage disagreement occur. Failure to do so can result in your warranty being voided either in whole or in part.

This evidence may consist of the following:

- The Mazda Scheduled Maintenance Record, refer to the Warranty Booklet, must be completely filled out showing mileage, repair order number, date for each service, and signed by a qualified automotive service technician who service vehicles.
- Original copies of repair orders or other receipts that include the mileage and date the vehicle was serviced. Each receipt should be signed by a qualified automotive service technician.
- For self maintenance, a statement that you completed the maintenance yourself, displaying mileage and the date the work was performed. Also, receipts for the replacement parts (fluid, filters, etc.) indicating the date and mileage must accompany this statement.

#### **NOTE**

*If you elect to perform maintenance yourself or have your vehicle serviced at a location other than an Authorized Mazda Dealer, Mazda requires that all fluids, parts and materials must meet Mazda standards for durability and performance as described in this manual.*

Claims against the warranty resulting from lack of maintenance, as opposed to defective materials or authorized Mazda workmanship, will not be honored.

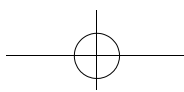

Maintenance and Care  
**Introduction**

---

Any auto repair shop using parts equivalent to your Mazda's original equipment may perform maintenance. **But we recommend that it always be done by an Authorized Mazda Dealer using genuine Mazda parts.**

For vehicles equipped with the multi information display, selecting "Maintenance Monitor" enables the system to notify you of your vehicle's approaching inspection/servicing period (page 6-181).

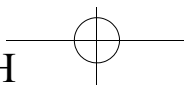
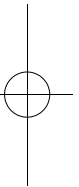
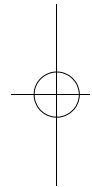

Maintenance and Care

## Scheduled Maintenance

---

### Scheduled Maintenance (USA, Canada, and Puerto Rico)

Follow Schedule 1 if the vehicle is operated mainly where none of the following conditions apply.

- Repeated short-distance driving
- Driving in dusty conditions
- Driving with extended use of brakes
- Driving in areas where salt or other corrosive materials are used
- Driving on rough or muddy roads
- Extended periods of idling or low-speed operation
- Driving for long periods in cold temperatures or extremely humid climates
- Driving in extremely hot conditions
- Driving in mountainous conditions continually

If any do apply, follow Schedule 2 (Canada and Puerto Rico residents follow Schedule 2).

**NOTE**

*After the prescribed period, continue to follow the described maintenance at the recommended intervals.*

Maintenance and Care  
**Scheduled Maintenance**

▼ **Schedule 1**

| Maintenance Interval  | Number of months or kilometers (miles), whichever comes first |   |  |      |    |      |    |      |    |
|---|---|---|--|------|----|------|----|------|----|
|   | Months  | 6   | 12   | 18   | 24 | 30   | 36 | 42   | 48 |
|   | ×1000 km  | 12  | 24   | 36   | 48 | 60   | 72 | 84   | 96 |
|   | ×1000 miles   | 7.5   | 15   | 22.5 | 30 | 37.5 | 45 | 52.5 | 60 |
| <b>ENGINE</b>   |   |   |  |      |    |      |    |      |    |
| Engine valve clearance<br>(Except SKYACTIV-G 2.0)                   |   | Audibly inspect every 120,000 km (75,000 miles), if noisy, adjust |  |      |    |      |    |      |    |
| Drive belts   |   |   |  |      |    | I    |    |      |    |
| Engine oil  |   | R   | R  | R    | R  | R    | R  | R    | R  |
| Engine oil filter   |   | R   | R  | R    | R  | R    | R  | R    | R  |
| <b>COOLING SYSTEM</b>   |   |   |  |      |    |      |    |      |    |
| Engine coolant  |   | FL22 type*1   | Replace at first 192,000 km (120,000 miles) or 10 years; after that, every 96,000 km (60,000 miles) or 5 years |      |    |      |    |      |    |
|   |   | Others  | Replace at first 96,000 km (60,000 miles) or 4 years; after that, every 2 years                                |      |    |      |    |      |    |
| <b>FUEL SYSTEM</b>  |   |   |  |      |    |      |    |      |    |
| Air filter  |   |   |  |      |    | R    |    |      |    |
| Fuel lines and hoses*2  |   |   |  |      | I  |      |    |      | I  |
| Hoses and tubes for emission*2                                      |   |   |  |      |    |      |    |      | I  |
| <b>IGNITION SYSTEM</b>  |   |   |  |      |    |      |    |      |    |
| Spark plugs   |   | Replace every 120,000 km (75,000 miles)                           |  |      |    |      |    |      |    |
| <b>CHASSIS and BODY</b>   |   |   |  |      |    |      |    |      |    |
| Brake lines, hoses and connections                                  |   |   |  |      | I  |      |    |      | I  |
| Disc brakes   |   |   | I  |      | I  |      | I  |      | I  |
| Tire (Rotation)   |   | Rotate every 12,000 km (7,500 miles)                              |  |      |    |      |    |      |    |
| Steering operation and linkages                                     |   |   |  |      | I  |      |    |      | I  |
| Front and rear suspension, ball joints and wheel bearing axial play |   |   |  |      | I  |      |    |      | I  |
| Driveshaft dust boots   |   |   |  |      | I  |      |    |      | I  |
| Bolts and nuts on chassis and body                                  |   |   |  |      | T  |      |    |      | T  |
| Exhaust system and heat shields                                     |   | Inspect every 72,000 km (45,000 miles) or 5 years                 |  |      |    |      |    |      |    |
| All locks and hinges  |   | L   | L  | L    | L  | L    | L  | L    | L  |

Maintenance and Care

## Scheduled Maintenance

| Maintenance Interval          | Number of months or kilometers (miles), whichever comes first |     |    |      |    |      |    |      |    |
|-------------------------------|---|-----|----|------|----|------|----|------|----|
|                               | Months  | 6   | 12 | 18   | 24 | 30   | 36 | 42   | 48 |
|                               | ×1000 km  | 12  | 24 | 36   | 48 | 60   | 72 | 84   | 96 |
|                               | ×1000 miles   | 7.5 | 15 | 22.5 | 30 | 37.5 | 45 | 52.5 | 60 |
| <b>AIR CONDITIONER SYSTEM</b> |   |     |    |      |    |      |    |      |    |
| Cabin air filter              |   |     |    |      | R  |      |    |      | R  |

**Chart symbols:**

**I:** Inspect: Inspect and clean, repair, adjust, fill up, or replace if necessary.

**R:** Replace

**L:** Lubricate

**T:** Tighten

**Remarks:**

- \*1 Use FL22 type coolant in vehicles with the inscription "FL22" on the radiator cap itself or the surrounding area. Use FL22 when replacing the coolant.
- \*2 According to state/provincial and federal regulations, failure to perform maintenance on these items will not void your emissions warranties. However, Mazda recommends that all maintenance services be performed at the recommended time or mileage/kilometer period to ensure long-term reliability.



Maintenance and Care  
**Scheduled Maintenance**

▼ **Schedule 2**

| Maintenance Interval                              | Number of months or kilometers (miles), whichever comes first     |  |    |    |    |    |    |    |    |    |    |    |    |
|---|---|--|----|----|----|----|----|----|----|----|----|----|----|
|   | Months  | 4  | 8  | 12 | 16 | 20 | 24 | 28 | 32 | 36 | 40 | 44 | 48 |
|   | ×1000 km  | 8  | 16 | 24 | 32 | 40 | 48 | 56 | 64 | 72 | 80 | 88 | 96 |
|   | ×1000 miles   | 5  | 10 | 15 | 20 | 25 | 30 | 35 | 40 | 45 | 50 | 55 | 60 |
| <b>ENGINE</b>                                     |   |  |    |    |    |    |    |    |    |    |    |    |    |
| Engine valve clearance<br>(Except SKYACTIV-G 2.0) | Audibly inspect every 120,000 km (75,000 miles), if noisy, adjust |  |    |    |    |    |    |    |    |    |    |    |    |
| Drive belts                                       |   |  |    |    |    |    |    | I  |    |    |    |    |    |
| Engine oil  | Puerto Rico   | Replace every 5,000 km (3,000 miles) or 3 months   |    |    |    |    |    |    |    |    |    |    |    |
|   | Others  | R  | R  | R  | R  | R  | R  | R  | R  | R  | R  | R  | R  |
| Engine oil filter                                 |   | R  | R  | R  | R  | R  | R  | R  | R  | R  | R  | R  | R  |
| <b>COOLING SYSTEM</b>                             |   |  |    |    |    |    |    |    |    |    |    |    |    |
| Engine coolant                                    | FL22 type*1   | Replace at first 192,000 km (120,000 miles) or 10 years; after that, every 96,000 km (60,000 miles) or 5 years |    |    |    |    |    |    |    |    |    |    |    |
|   | Others  | Replace at first 96,000 km (60,000 miles) or 4 years; after that, every 2 years                                |    |    |    |    |    |    |    |    |    |    |    |
| Engine coolant level                              |   | I  | I  | I  | I  | I  | I  | I  | I  | I  | I  | I  | I  |
| <b>FUEL SYSTEM</b>                                |   |  |    |    |    |    |    |    |    |    |    |    |    |
| Air filter  | Puerto Rico   |  |    |    |    |    | R  |    |    |    |    |    | R  |
|   | Others  |  |    |    |    |    |    | R  |    |    |    |    |    |
| Fuel lines and hoses*2                            |   |  |    |    |    |    | I  |    |    |    |    |    | I  |
| Hoses and tubes for emission*2                    |   |  |    |    |    |    |    |    |    |    |    |    | I  |
| <b>IGNITION SYSTEM</b>                            |   |  |    |    |    |    |    |    |    |    |    |    |    |
| Spark plugs (Except MZR 2.3 DISI Turbo)           | Replace every 120,000 km (75,000 miles)                           |  |    |    |    |    |    |    |    |    |    |    |    |
| Spark plugs<br>(for MZR 2.3 DISI Turbo)           | USA   | Replace every 96,000 km (60,000 miles)   |    |    |    |    |    |    |    |    |    |    |    |
|   | Others*3  | Replace every 120,000 km (75,000 miles)  |    |    |    |    |    |    |    |    |    |    |    |
| <b>ELECTRICAL SYSTEM</b>                          |   |  |    |    |    |    |    |    |    |    |    |    |    |
| Function of all lights                            |   | I  | I  | I  | I  | I  | I  | I  | I  | I  | I  | I  | I  |

Maintenance and Care

# Scheduled Maintenance

| Maintenance Interval  | Number of months or kilometers (miles), whichever comes first |   |    |    |    |    |    |    |    |    |    |    |    |
|---|---|---|----|----|----|----|----|----|----|----|----|----|----|
|   | Months  | 4 | 8  | 12 | 16 | 20 | 24 | 28 | 32 | 36 | 40 | 44 | 48 |
|   | ×1000 km  | 8 | 16 | 24 | 32 | 40 | 48 | 56 | 64 | 72 | 80 | 88 | 96 |
|   | ×1000 miles   | 5 | 10 | 15 | 20 | 25 | 30 | 35 | 40 | 45 | 50 | 55 | 60 |
| <b>CHASSIS and BODY</b>   |   |   |    |    |    |    |    |    |    |    |    |    |    |
| Brake lines, hoses and connections                                  |   |   |    |    |    |    | I  |    |    |    |    |    | I  |
| Brake fluid level   | I   | I | I  | I  | I  | I  | I  | I  | I  | I  | I  | I  | I  |
| Disc brakes   |   |   | I  |    |    |    | I  |    |    | I  |    |    | I  |
| Tire (Rotation)   | Rotate every 8,000 km (5,000 miles)                           |   |    |    |    |    |    |    |    |    |    |    |    |
| Tire inflation pressure and tire wear                               | I   | I | I  | I  | I  | I  | I  | I  | I  | I  | I  | I  | I  |
| Steering operation and linkages                                     |   |   |    |    |    |    | I  |    |    |    |    |    | I  |
| Power steering fluid level  | I   | I | I  | I  | I  | I  | I  | I  | I  | I  | I  | I  | I  |
| Front and rear suspension, ball joints and wheel bearing axial play |   |   |    |    |    |    | I  |    |    |    |    |    | I  |
| Driveshaft dust boots   |   |   |    |    |    |    | I  |    |    |    |    |    | I  |
| Bolts and nuts on chassis and body                                  |   |   |    |    |    |    | T  |    |    |    |    |    | T  |
| Exhaust system and heat shields                                     | Inspect every 72,000 km (45,000 miles) or 5 years             |   |    |    |    |    |    |    |    |    |    |    |    |
| All locks and hinges  | L   | L | L  | L  | L  | L  | L  | L  | L  | L  | L  | L  | L  |
| Washer fluid level  | I   | I | I  | I  | I  | I  | I  | I  | I  | I  | I  | I  | I  |
| <b>AIR CONDITIONER SYSTEM</b>                                       |   |   |    |    |    |    |    |    |    |    |    |    |    |
| Cabin air filter  | Replace every 40,000 km (25,000 miles) or 2 years             |   |    |    |    |    |    |    |    |    |    |    |    |

**Chart symbols:**

**I:** Inspect: Inspect and clean, repair, adjust, fill up, or replace if necessary.

**R:** Replace

**L:** Lubricate

**T:** Tighten

**Remarks:**

- \*1 Use FL22 type coolant in vehicles with the inscription “FL22” on the radiator cap itself or the surrounding area. Use FL22 when replacing the coolant.
- \*2 According to state/provincial and federal regulations, failure to perform maintenance on these items will not void your emissions warranties. However, Mazda recommends that all maintenance services be performed at the recommended time or mileage/kilometer period to ensure long-term reliability.
- \*3 If the vehicle is operated primarily under any of the following conditions, replace the spark plugs at every 96,000 km (60,000 miles) or shorter.
  - a) Repeated short-distance driving
  - b) Extended periods of idling or low-speed operation
  - c) Driving for long periods in cold temperatures or extremely humid climates

## Scheduled Maintenance

### Scheduled Maintenance (Mexico)

Follow Schedule 1 if the vehicle is operated mainly where none of the following conditions apply.

- Repeated short-distance driving
- Driving in dusty conditions
- Driving with extended use of brakes
- Driving in areas where salt or other corrosive materials are used
- Driving on rough or muddy roads
- Extended periods of idling or low-speed operation
- Driving for long periods in cold temperatures or extremely humid climates
- Driving in extremely hot conditions
- Driving in mountainous conditions continually

If any do apply, follow Schedule 2.

**NOTE**

*After the prescribed period, continue to follow the described maintenance at the recommended intervals.*

Maintenance and Care

# Scheduled Maintenance

## ▼ Schedule 1

| Maintenance Interval  | Number of months or kilometers, whichever comes first |   |    |     |    |    |    |     |    |    |     |     |     |
|---|---|---|----|-----|----|----|----|-----|----|----|-----|-----|-----|
|   | Months  | 6   | 12 | 18  | 24 | 30 | 36 | 42  | 48 | 54 | 60  | 66  | 72  |
|   | ×1000 km  | 10  | 20 | 30  | 40 | 50 | 60 | 70  | 80 | 90 | 100 | 110 | 120 |
| <b>ENGINE</b>   |   |   |    |     |    |    |    |     |    |    |     |     |     |
| Engine valve clearance  | Audibly inspect every 120,000 km, if noisy, adjust    |   |    |     |    |    |    |     |    |    |     |     |     |
| Drive belts   |   |   |    | I   |    |    |    | I   |    |    |     |     | I   |
| Engine oil  | R   | R   | R  | R   | R  | R  | R  | R   | R  | R  | R   | R   | R   |
| Engine oil filter   | R   | R   | R  | R   | R  | R  | R  | R   | R  | R  | R   | R   | R   |
| <b>COOLING SYSTEM</b>   |   |   |    |     |    |    |    |     |    |    |     |     |     |
| Cooling system  |   |   |    | I   |    |    |    | I   |    |    |     |     | I   |
| Engine coolant  | FL22 type*1   | Replace at first 190,000 km or 10 years; after that, every 60,000 km or 3 years |    |     |    |    |    |     |    |    |     |     |     |
|   | Others  |   |    |     | R  |    |    |     | R  |    |     |     | R   |
| <b>FUEL SYSTEM</b>  |   |   |    |     |    |    |    |     |    |    |     |     |     |
| Air filter  |   | R   |    | R   |    | R  |    | R   |    | R  |     | R   |     |
| Fuel lines and hoses  |   |   |    | I*2 |    |    |    | I*2 |    |    |     |     | I   |
| Hoses and tubes for emission  |   |   |    | I*2 |    |    |    | I*2 |    |    |     |     | I   |
| Fuel filter   |   |   |    | R   |    |    |    | R   |    |    |     |     | R   |
| <b>IGNITION SYSTEM</b>  |   |   |    |     |    |    |    |     |    |    |     |     |     |
| Spark plugs   | Replace every 60,000 km                               |   |    |     |    |    |    |     |    |    |     |     |     |
| <b>CHASSIS and BODY</b>   |   |   |    |     |    |    |    |     |    |    |     |     |     |
| Brake lines, hoses and connections                                  |   | I   |    | I   |    | I  |    | I   |    | I  |     | I   |     |
| Brake fluid level   | I   | I   | I  |     | I  | I  | I  |     | I  | I  | I   |     |     |
| Brake fluid   |   |   |    | R   |    |    |    | R   |    |    |     |     | R   |
| Disc brakes   | I   | I   | I  | I   | I  | I  | I  | I   | I  | I  | I   | I   | I   |
| Tire (Rotation)   | Rotate every 10,000 km                                |   |    |     |    |    |    |     |    |    |     |     |     |
| Tire inflation pressure and tire wear                               | I   | I   | I  | I   | I  | I  | I  | I   | I  | I  | I   | I   | I   |
| Steering operation and linkages                                     | I   | I   | I  | I   | I  | I  | I  | I   | I  | I  | I   | I   | I   |
| Power steering fluid level  | I   | I   | I  | I   | I  | I  | I  | I   | I  | I  | I   | I   | I   |
| Front and rear suspension, ball joints and wheel bearing axial play |   | I   |    | I   |    | I  |    | I   |    | I  |     | I   |     |
| Driveshaft dust boots   |   | I   |    | I   |    | I  |    | I   |    | I  |     | I   |     |
| Bolts and nuts on chassis and body                                  |   | T   |    | T   |    | T  |    | T   |    | T  |     | T   |     |
| Exhaust system and heat shields                                     |   | I   |    | I   |    | I  |    | I   |    | I  |     | I   |     |
| All locks and hinges  | L   | L   | L  | L   | L  | L  | L  | L   | L  | L  | L   | L   | L   |
| Washer fluid level  | I   | I   | I  | I   | I  | I  | I  | I   | I  | I  | I   | I   | I   |

Maintenance and Care  
**Scheduled Maintenance**

| Maintenance Interval          | Number of months or kilometers, whichever comes first |    |    |    |    |    |    |    |    |    |     |     |     |   |
|-------------------------------|---|----|----|----|----|----|----|----|----|----|-----|-----|-----|---|
|                               | Months  | 6  | 12 | 18 | 24 | 30 | 36 | 42 | 48 | 54 | 60  | 66  | 72  |   |
|                               | ×1000 km  | 10 | 20 | 30 | 40 | 50 | 60 | 70 | 80 | 90 | 100 | 110 | 120 |   |
| <b>AIR CONDITIONER SYSTEM</b> |   |    |    |    |    |    |    |    |    |    |     |     |     |   |
| Cabin air filter              |   |    |    |    |    | R  |    |    |    | R  |     |     |     | R |

**Chart symbols:**

- I:** Inspect: Inspect and clean, repair, adjust, fill up, or replace if necessary.
- R:** Replace
- L:** Lubricate
- T:** Tighten

**Remarks:**

- \*1 Use FL22 type coolant in vehicles with the inscription “FL22” on the radiator cap itself or the surrounding area. Use FL22 when replacing the coolant.
- \*2 According to state/provincial and federal regulations, failure to perform maintenance on these items will not void your emissions warranties. However, Mazda recommends that all maintenance services be performed at the recommended time or kilometer period to ensure long-term reliability.

Maintenance and Care

# Scheduled Maintenance

## ▼ Schedule 2

| Maintenance Interval  | Number of months or kilometers, whichever comes first |   |    |    |    |    |    |     |    |    |    |    |    |
|---|---|---|----|----|----|----|----|-----|----|----|----|----|----|
|   | Months  | 3   | 6  | 9  | 12 | 15 | 18 | 21  | 24 | 27 | 30 | 33 | 36 |
|   | ×1000 km  | 5   | 10 | 15 | 20 | 25 | 30 | 35  | 40 | 45 | 50 | 55 | 60 |
| <b>ENGINE</b>   |   |   |    |    |    |    |    |     |    |    |    |    |    |
| Engine valve clearance  | Audibly inspect every 120,000 km, if noisy, adjust    |   |    |    |    |    |    |     |    |    |    |    |    |
| Drive belts   |   |   |    |    |    |    |    |     | I  |    |    |    |    |
| Engine oil  | R   | R   | R  | R  | R  | R  | R  | R   | R  | R  | R  | R  | R  |
| Engine oil filter   | R   | R   | R  | R  | R  | R  | R  | R   | R  | R  | R  | R  | R  |
| <b>COOLING SYSTEM</b>   |   |   |    |    |    |    |    |     |    |    |    |    |    |
| Cooling system  |   |   |    |    |    |    |    |     | I  |    |    |    |    |
| Engine coolant  | FL22 type*1   | Replace at first 190,000 km or 10 years; after that, every 60,000 km or 3 years |    |    |    |    |    |     |    |    |    |    |    |
|   | Others  |   |    |    |    |    |    |     | R  |    |    |    |    |
| Engine coolant level  | I   | I   | I  | I  | I  | I  | I  | I   | I  | I  | I  | I  | I  |
| <b>FUEL SYSTEM</b>  |   |   |    |    |    |    |    |     |    |    |    |    |    |
| Air filter  |   | C   |    | R  |    | C  |    | R   |    | C  |    | R  |    |
| Fuel lines and hoses  |   |   |    |    |    |    |    | I*2 |    |    |    |    |    |
| Hoses and tubes for emission  |   |   |    |    |    |    |    | I*2 |    |    |    |    |    |
| Fuel filter   |   |   |    |    |    |    |    | R   |    |    |    |    |    |
| <b>IGNITION SYSTEM</b>  |   |   |    |    |    |    |    |     |    |    |    |    |    |
| Spark plugs   | Replace every 60,000 km                               |   |    |    |    |    |    |     |    |    |    |    |    |
| <b>ELECTRICAL SYSTEM</b>  |   |   |    |    |    |    |    |     |    |    |    |    |    |
| Function of all lights  | I   | I   | I  | I  | I  | I  | I  | I   | I  | I  | I  | I  | I  |
| <b>CHASSIS and BODY</b>   |   |   |    |    |    |    |    |     |    |    |    |    |    |
| Brake lines, hoses and connections                                  |   |   |    | I  |    |    |    | I   |    |    |    |    | I  |
| Brake fluid level   |   | I   |    | I  |    | I  |    |     |    | I  |    |    | I  |
| Brake fluid   |   |   |    |    |    |    |    | R   |    |    |    |    |    |
| Disc brakes   |   | I   |    | I  |    | I  |    | I   |    | I  |    |    | I  |
| Tire (Rotation)   | Rotate every 10,000 km                                |   |    |    |    |    |    |     |    |    |    |    |    |
| Tire inflation pressure and tire wear                               |   | I   |    | I  |    | I  |    | I   |    | I  |    |    | I  |
| Steering operation and linkages                                     |   | I   |    | I  |    | I  |    | I   |    | I  |    |    | I  |
| Power steering fluid level  |   | I   |    | I  |    | I  |    | I   |    | I  |    |    | I  |
| Front and rear suspension, ball joints and wheel bearing axial play |   |   |    | I  |    |    |    | I   |    |    |    |    | I  |
| Driveshaft dust boots   |   |   |    | I  |    |    |    | I   |    |    |    |    | I  |
| Bolts and nuts on chassis and body                                  |   |   |    | T  |    |    |    | T   |    |    |    |    | T  |
| Exhaust system and heat shields                                     |   |   |    | I  |    |    |    | I   |    |    |    |    | I  |
| All locks and hinges  |   | L   |    | L  |    | L  |    | L   |    | L  |    |    | L  |
| Washer fluid level  |   | I   |    | I  |    | I  |    | I   |    | I  |    |    | I  |

Maintenance and Care  
**Scheduled Maintenance**

| Maintenance Interval          | Number of months or kilometers, whichever comes first |   |    |    |    |    |    |    |    |    |    |    |    |
|-------------------------------|---|---|----|----|----|----|----|----|----|----|----|----|----|
|                               | Months  | 3 | 6  | 9  | 12 | 15 | 18 | 21 | 24 | 27 | 30 | 33 | 36 |
|                               | ×1000 km  | 5 | 10 | 15 | 20 | 25 | 30 | 35 | 40 | 45 | 50 | 55 | 60 |
| <b>AIR CONDITIONER SYSTEM</b> |   |   |    |    |    |    |    |    |    |    |    |    |    |
| Cabin air filter              |   |   |    |    | R  |    |    |    |    | R  |    |    | R  |

**Chart symbols:**

- I:** Inspect: Inspect and clean, repair, adjust, fill up, or replace if necessary.
- R:** Replace
- C:** Clean
- L:** Lubricate
- T:** Tighten

**Remarks:**

- \*1 Use FL22 type coolant in vehicles with the inscription “FL22” on the radiator cap itself or the surrounding area. Use FL22 when replacing the coolant.
- \*2 According to state/provincial and federal regulations, failure to perform maintenance on these items will not void your emissions warranties. However, Mazda recommends that all maintenance services be performed at the recommended time or kilometer period to ensure long-term reliability.

Maintenance and Care

# Scheduled Maintenance

(Cont.)

| Maintenance Interval  | Number of months or kilometers, whichever comes first |   |    |     |    |    |    |    |     |     |     |     |     |
|---|---|---|----|-----|----|----|----|----|-----|-----|-----|-----|-----|
|   | Months  | 39  | 42 | 45  | 48 | 51 | 54 | 57 | 60  | 63  | 66  | 69  | 72  |
|   | ×1000 km  | 65  | 70 | 75  | 80 | 85 | 90 | 95 | 100 | 105 | 110 | 115 | 120 |
| <b>ENGINE</b>   |   |   |    |     |    |    |    |    |     |     |     |     |     |
| Engine valve clearance  | Audibly inspect every 120,000 km, if noisy, adjust    |   |    |     |    |    |    |    |     |     |     |     |     |
| Drive belts   |   |   |    | I   |    |    |    |    |     |     |     |     | I   |
| Engine oil  | R   | R   | R  | R   | R  | R  | R  | R  | R   | R   | R   | R   | R   |
| Engine oil filter   | R   | R   | R  | R   | R  | R  | R  | R  | R   | R   | R   | R   | R   |
| <b>COOLING SYSTEM</b>   |   |   |    |     |    |    |    |    |     |     |     |     |     |
| Cooling system  |   |   |    | I   |    |    |    |    |     |     |     |     | I   |
| Engine coolant  | FL22 type*1   | Replace at first 190,000 km or 10 years; after that, every 60,000 km or 3 years |    |     |    |    |    |    |     |     |     |     |     |
|   | Others  |   |    |     | R  |    |    |    |     |     |     |     | R   |
| Engine coolant level  | I   | I   | I  | I   | I  | I  | I  | I  | I   | I   | I   | I   | I   |
| <b>FUEL SYSTEM</b>  |   |   |    |     |    |    |    |    |     |     |     |     |     |
| Air filter  |   | C   |    | R   |    | C  |    | R  |     | C   |     |     | R   |
| Fuel lines and hoses  |   |   |    | I*2 |    |    |    |    |     |     |     |     | I   |
| Hoses and tubes for emission  |   |   |    | I*2 |    |    |    |    |     |     |     |     | I   |
| Fuel filter   |   |   |    | R   |    |    |    |    |     |     |     |     | R   |
| <b>IGNITION SYSTEM</b>  |   |   |    |     |    |    |    |    |     |     |     |     |     |
| Spark plugs   | Replace every 60,000 km                               |   |    |     |    |    |    |    |     |     |     |     |     |
| <b>ELECTRICAL SYSTEM</b>  |   |   |    |     |    |    |    |    |     |     |     |     |     |
| Function of all lights  | I   | I   | I  | I   | I  | I  | I  | I  | I   | I   | I   | I   | I   |
| <b>CHASSIS and BODY</b>   |   |   |    |     |    |    |    |    |     |     |     |     |     |
| Brake lines, hoses and connections                                  |   |   |    | I   |    |    |    | I  |     |     |     |     | I   |
| Brake fluid level   |   | I   |    |     |    |    | I  |    | I   |     | I   |     |     |
| Brake fluid   |   |   |    | R   |    |    |    |    |     |     |     |     | R   |
| Disc brakes   |   | I   |    | I   |    |    | I  |    | I   |     | I   |     | I   |
| Tire (Rotation)   | Rotate every 10,000 km                                |   |    |     |    |    |    |    |     |     |     |     |     |
| Tire inflation pressure and tire wear                               |   | I   |    | I   |    |    | I  |    | I   |     | I   |     | I   |
| Steering operation and linkages                                     |   | I   |    | I   |    |    | I  |    | I   |     | I   |     | I   |
| Power steering fluid level  |   | I   |    | I   |    |    | I  |    | I   |     | I   |     | I   |
| Front and rear suspension, ball joints and wheel bearing axial play |   |   |    | I   |    |    |    |    | I   |     |     |     | I   |
| Driveshaft dust boots   |   |   |    | I   |    |    |    |    | I   |     |     |     | I   |
| Bolts and nuts on chassis and body                                  |   |   |    | T   |    |    |    |    | T   |     |     |     | T   |
| Exhaust system and heat shields                                     |   |   |    | I   |    |    |    |    | I   |     |     |     | I   |
| All locks and hinges  |   | L   |    | L   |    |    | L  |    | L   |     | L   |     | L   |
| Washer fluid level  |   | I   |    | I   |    |    | I  |    | I   |     | I   |     | I   |



Maintenance and Care  
**Scheduled Maintenance**

| Maintenance Interval          | Number of months or kilometers, whichever comes first |    |    |    |    |    |    |    |     |     |     |     |     |
|-------------------------------|---|----|----|----|----|----|----|----|-----|-----|-----|-----|-----|
|                               | Months  | 39 | 42 | 45 | 48 | 51 | 54 | 57 | 60  | 63  | 66  | 69  | 72  |
|                               | ×1000 km  | 65 | 70 | 75 | 80 | 85 | 90 | 95 | 100 | 105 | 110 | 115 | 120 |
| <b>AIR CONDITIONER SYSTEM</b> |   |    |    |    |    |    |    |    |     |     |     |     |     |
| Cabin air filter              |   |    |    |    | R  |    |    |    | R   |     |     |     | R   |

**Chart symbols:**

- I:** Inspect: Inspect and clean, repair, adjust, fill up, or replace if necessary.
- R:** Replace
- C:** Clean
- L:** Lubricate
- T:** Tighten

**Remarks:**

- \*1 Use FL22 type coolant in vehicles with the inscription “FL22” on the radiator cap itself or the surrounding area. Use FL22 when replacing the coolant.
- \*2 According to state/provincial and federal regulations, failure to perform maintenance on these items will not void your emissions warranties. However, Mazda recommends that all maintenance services be performed at the recommended time or kilometer period to ensure long-term reliability.

Maintenance and Care

## Owner Maintenance

---

### Owner Maintenance Schedule

The owner or a qualified service technician should make these vehicle inspections at the indicated intervals to ensure safe and dependable operation.

Bring any problem to the attention of an Authorized Mazda Dealer or qualified service technician as soon as possible.

#### ▼ When Refueling

- Brake and clutch fluid level (page 8-27)
- Engine coolant level (page 8-25)
- Engine oil level (page 8-23)
- Washer fluid level (page 8-30)

#### ▼ At Least Monthly

Tire inflation pressures (page 8-40)

#### ▼ At Least Twice a Year (For Example, Every Spring and Fall)

- Automatic transaxle fluid level (page 8-28)
- Power steering fluid level (page 8-28)

You can do the following scheduled maintenance items if you have some mechanical ability and a few basic tools and if you closely follow the directions in this manual.

- Engine coolant (page 8-25)
- Engine oil (page 8-21)



Maintenance and Care  
**Owner Maintenance**

---

## Owner Maintenance Precautions

Improper or incomplete service may result in problems. This section gives instructions only for items that are easy to perform.

As explained in the Introduction (page 8-2), several procedures can be done only by a qualified service technician with special tools.

Improper owner maintenance during the warranty period may affect warranty coverage. Refer to Introduction (page 8-2) for owner's responsibility in protecting your investment. For details, read the separate Mazda Warranty statement provided with the vehicle. If you are unsure about any servicing or maintenance procedure, have it done by an Authorized Mazda Dealer.

There are strict environmental laws regarding the disposal of waste oil and fluids. Please dispose of your waste properly and with due regard to the environment.

We recommend that you entrust the oil and fluid changes of your vehicle to an Authorized Mazda Dealer.

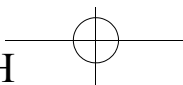

Maintenance and Care

## Owner Maintenance

---

### **WARNING**

***Do not perform maintenance work if you lack sufficient knowledge and experience or the proper tools and equipment to do the work. Have maintenance work done by a qualified technician:***

*Performing maintenance work on a vehicle is dangerous if not done properly. You can be seriously injured while performing some maintenance procedures.*

***If you must run the engine while working under the hood, make certain that you remove all jewelry (especially rings, bracelets, watches, and necklaces) and all neckties, scarves, and similar loose clothing before getting near the engine or cooling fan which may turn on unexpectedly:***

*Working under the hood with the engine running is dangerous. It becomes even more dangerous when you wear jewelry or loose clothing.*

*Either can become entangled in moving parts and result in injury.*

***Switch the ignition to off and make sure the fan is not running before attempting to work near the cooling fan:***

*Working near the cooling fan when it is running is dangerous. The fan could continue running indefinitely even if the engine has stopped and the engine compartment temperature is high. You could be hit by the fan and seriously injured.*

***Do not leave items in the engine compartment:***

*After you have finished checking or doing servicing in the engine compartment, do not forget and leave items such as tools or rags in the engine compartment.*

*Tools or other items left in the engine compartment could cause engine damage or a fire leading to an unexpected accident.*

Maintenance and Care  
**Owner Maintenance**

**Engine Compartment Overview**

**SKYACTIV-G 2.0**

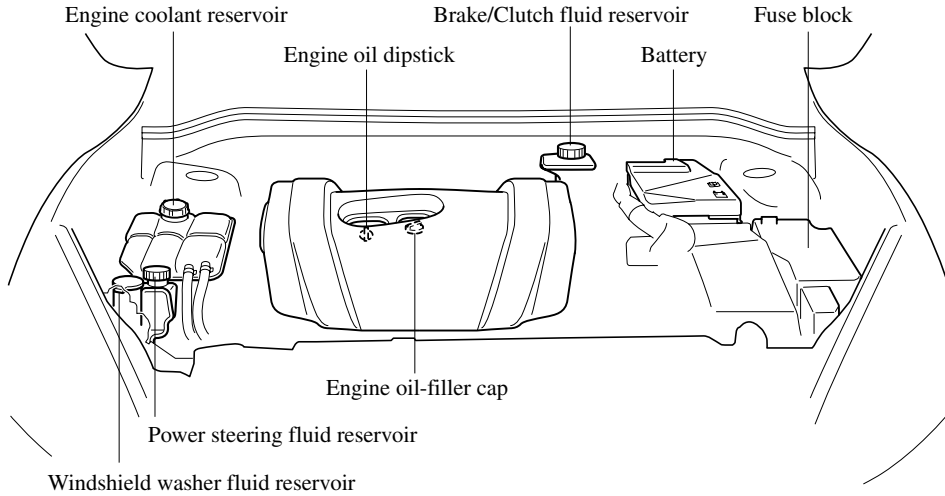

**MZR 2.0 and MZR 2.5**

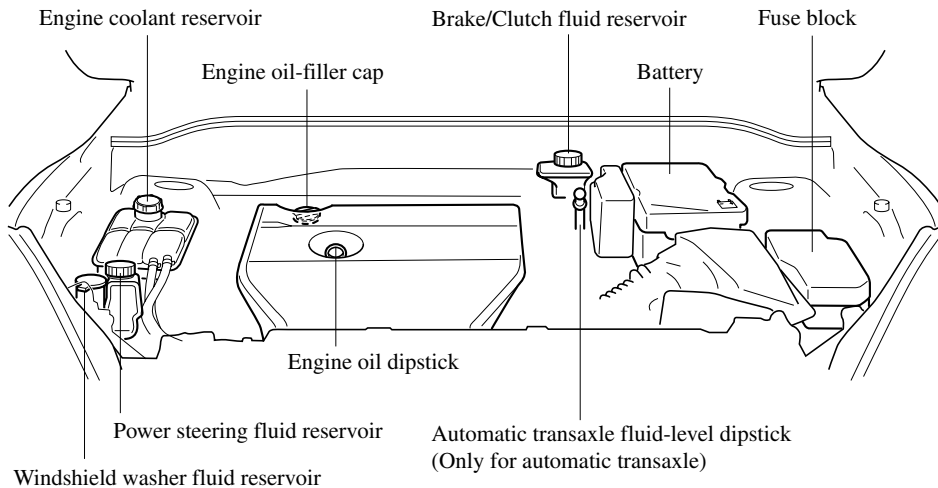

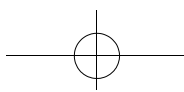

Maintenance and Care

## Owner Maintenance

---

### MZR 2.3 DISI Turbo

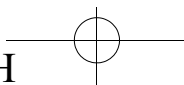
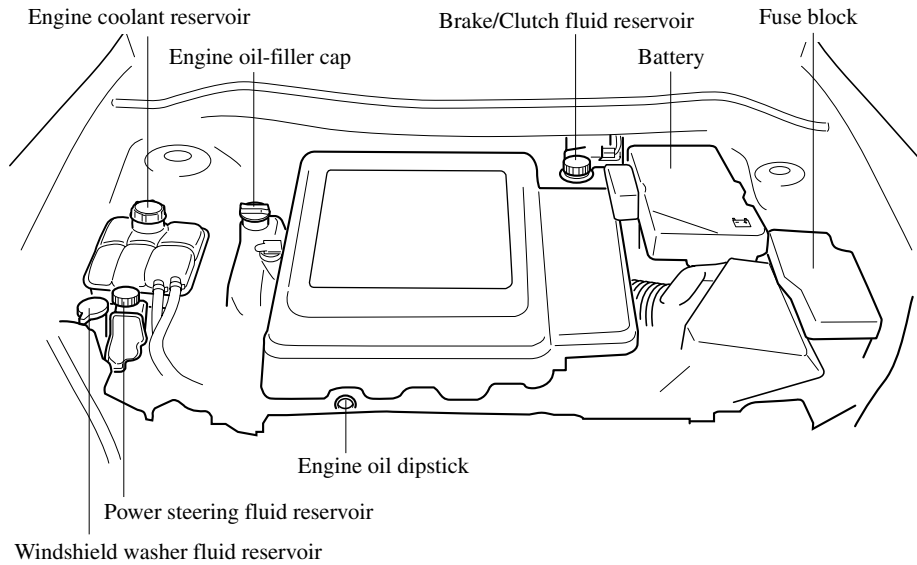

Maintenance and Care  
**Owner Maintenance**

## Engine Oil

### NOTE

*Changing the engine oil should be performed by an Authorized Mazda Dealer.*

*Refer to Introduction (page 8-2) for owner's responsibility in protecting your investment.*

### ▼ Recommended Oil

**SKYACTIV-G 2.0, MZR 2.0 and MZR 2.5**

#### U.S.A. and CANADA

##### **0W-20 full synthetic recommended:**

Mazda Genuine Oil is used in your Mazda vehicle and is the recommended 0W-20 lubricant. Mazda Genuine 0W-20 Oil is required to achieve optimum fuel economy.

Recommended viscosity: SAE 0W-20

For maintenance service, Mazda recommends Mazda Genuine Parts and Castrol® (U.S.A. only).



(ILSAC)

Only use SAE 0W-20 oil with the American Petroleum Institute (API) symbol and ILSAC GF-4/GF-5. Oil with this trademark symbol conforms to the current engine and emission system protection standards and fuel economy requirements of the International Lubricant Standardization and Approval Committee (ILSAC), comprised of U.S. and Japanese automobile manufacturers.

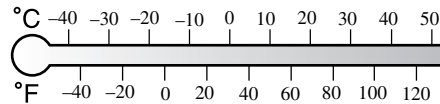

0W-20

#### Except U.S.A. and CANADA

##### **Use SAE 5W-20 engine oil.**

Oil container labels provide important information.

A chief contribution this type of oil makes to fuel economy is reducing the amount of fuel necessary to overcome engine friction.

For maintenance service, Mazda recommends Mazda Genuine Parts and Castrol® (Mexico only).



Maintenance and Care

## Owner Maintenance



(ILSAC)

### (Mexico)

Use SAE 5W-20 engine oil. If SAE 5W-20 engine oil is not available, use SAE 5W-30 engine oil.

The quality designation SM, or ILSAC must be on the label.

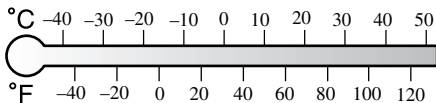

5W-20

### MZR 2.3 DISI Turbo

#### U.S.A. and CANADA

#### **5W-30 recommended:**

Mazda Genuine Oil is used in your Mazda vehicle and is the recommended 5W-30 lubricant. Mazda Genuine 5W-30 Oil is required to achieve optimum fuel economy.

Recommended viscosity: SAE 5W-30

For maintenance service, Mazda recommends Mazda Genuine Parts and Castrol® (U.S.A. only).



(ILSAC)

Only use SAE 5W-30 oil with the American Petroleum Institute (API) symbol indicated.

Oil with this trademark symbol conforms to the current engine and emission system protection standards and fuel economy requirements of the International Lubricant Standardization and Approval Committee (ILSAC), comprised of U.S. and Japanese automobile manufacturers.

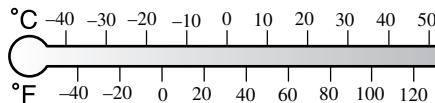

5W-30



Maintenance and Care  
**Owner Maintenance**

**Except U.S.A. and CANADA**

**Use SAE 5W-30 engine oil.**

Oil container labels provide important information.

A chief contribution this type of oil makes to fuel economy is reducing the amount of fuel necessary to overcome engine friction.

For maintenance service, Mazda recommends Mazda Genuine Parts and Castrol® (Mexico only).



(ILSAC)

The quality designation SM, or ILSAC must be on the label.

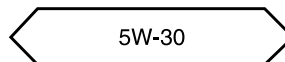
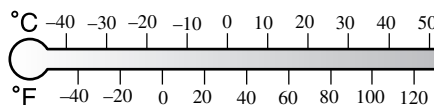

▼ **Inspecting Engine Oil Level**

1. Be sure the vehicle is on a level surface.
2. Warm up the engine to normal operating temperature.
3. Turn it off and wait at least 5 minutes for the oil to return to the oil pan.
4. Pull out the dipstick, wipe it clean, and reinsert it fully.

**SKYACTIV-G 2.0**

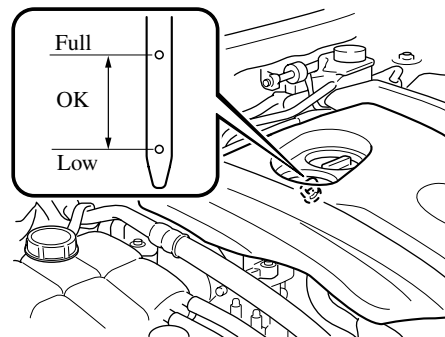

Maintenance and Care

## Owner Maintenance

### MZR 2.0 and MZR 2.5

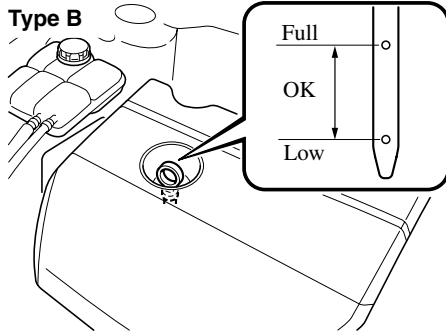
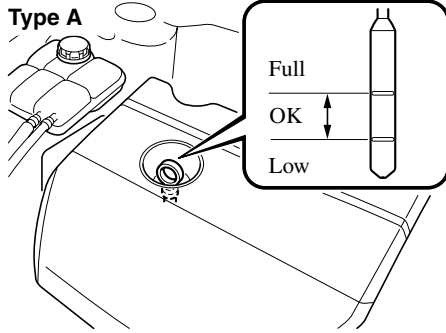

### MZR 2.3 DISI Turbo

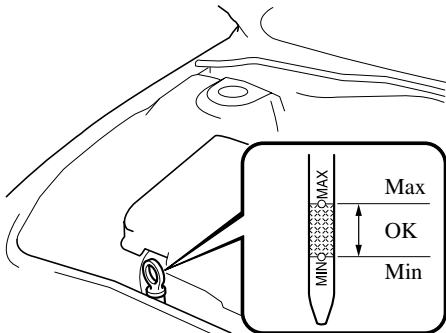

5. Pull it out again and examine the level. The level is normal if it is between Low or MIN and Full or MAX. If it is near or below Low or MIN, add enough oil to bring the level to Full or MAX.

### **CAUTION**

*Do not add engine oil over Full or MAX. This may cause engine damage.*

6. Make sure the O-ring on the dipstick is positioned properly before reinserting the dipstick.

Maintenance and Care  
**Owner Maintenance**

## Engine Coolant

### ▼ Inspecting Coolant Level

#### **⚠ WARNING**

**Do not use a match or live flame in the engine compartment. DO NOT ADD COOLANT WHEN THE ENGINE IS HOT:**

*A hot engine is dangerous. If the engine has been running, parts of the engine compartment can become very hot. You could be burned. Carefully inspect the engine coolant in the coolant reservoir, but do not open it.*



**Switch the ignition to off and make sure the fan is not running before attempting to work near the cooling fan:**

*Working near the cooling fan when it is running is dangerous. The fan could continue running indefinitely even if the engine has stopped and the engine compartment temperature is high. You could be hit by the fan and seriously injured.*



**Do not remove the cooling system cap when the engine and radiator are hot:**

*When the engine and radiator are hot, scalding coolant and steam may shoot out under pressure and cause serious injury.*

#### **NOTE**

*Changing the coolant should be done by an Authorized Mazda Dealer.*

Inspect the antifreeze protection and coolant level in the coolant reservoir at least once a year—at the beginning of the winter season—and before traveling where temperatures may drop below freezing.

Inspect the condition and connections of all cooling system and heater hoses. Replace any that are swollen or deteriorated.

The coolant should be at full in the radiator and between the MAX and MIN marks on the coolant reservoir when the engine is cool.

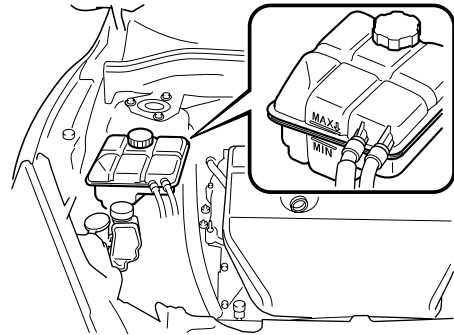

If it is at or near MIN, add enough coolant to the coolant reservoir to provide freezing and corrosion protection and to bring the level to MAX. Securely tighten the coolant reservoir tank cap after adding coolant.

Maintenance and Care

## Owner Maintenance

### **CAUTION**

- Radiator coolant will damage paint.  
*Rinse it off quickly if spilled.*
- Use only soft (demineralized) water in the coolant mixture. Water that contains minerals will cut down on the coolant's effectiveness.
- Do not add only water. Always add a proper coolant mixture.
- The engine has aluminum parts and must be protected by an ethylene-glycol-based coolant to prevent corrosion and freezing.
- **DO NOT USE** coolants Containing Alcohol, methanol, Borate or Silicate.  
*These coolants could damage the cooling system.*
- **DO NOT MIX** alcohol or methanol with the coolant. This could damage the cooling system.
- Do not use a solution that contains more than 60% antifreeze.  
*This would reduce effectiveness.*

### **NOTE**

*If the "FL22" mark is shown on or near the cooling system cap, it is recommended to use Mazda Genuine FL22 engine coolant (page 8-4).*

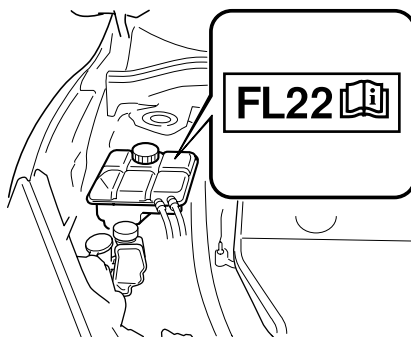

*If the coolant reservoir is empty or new coolant is required frequently, consult an Authorized Mazda Dealer.*

Maintenance and Care  
**Owner Maintenance**

## Brake/Clutch Fluid

### ▼ Inspecting Brake/Clutch Fluid Level

The brakes and clutch draw fluid from the same reservoir.

Inspect the fluid level in the reservoir regularly. It should be kept at MAX.

The level normally drops with accumulated distance, a condition associated with wear of brake and clutch linings. If it is excessively low, have the brake/clutch system inspected by an Authorized Mazda Dealer.

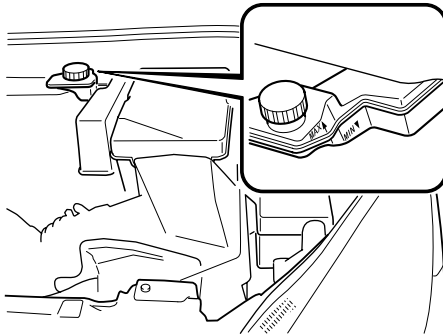

### ▼ Adding Brake/Clutch Fluid

#### **⚠ WARNING**

**Be careful not to spill brake fluid on yourself or on the engine:**

*Spilled brake fluid is dangerous. If it gets in your eyes, they could be seriously injured. If this happens, immediately flush your eyes with water and get medical attention. Brake fluid spilled on a hot engine could cause a fire.*

**If the brake/clutch fluid level is low, have the brakes and clutch inspected:**

*Low brake/clutch fluid levels are dangerous. Low levels could signal brake lining wear or a brake system leak. Your brakes could fail and cause an accident.*

If the fluid level is low, add fluid until it reaches MAX.

Before adding fluid, thoroughly clean the area around the cap.

#### **⚠ CAUTION**

- *Brake and clutch fluid will damage painted surfaces. If brake or clutch fluid does get on a painted surface, wash it off with water immediately.*
- *Using nonspecified brake and clutch fluids (page 10-5) will damage the systems. Mixing different fluids will also damage them.*

*If the brake/clutch system frequently requires new fluid, consult an Authorized Mazda Dealer.*

Maintenance and Care

## Owner Maintenance

### Power Steering Fluid

#### ▼ Inspecting Power Steering Fluid Level

#### **CAUTION**

*To avoid damage to the power steering pump, don't operate the vehicle for long periods when the power steering fluid level is low.*

#### **NOTE**

*Use specified power steering fluid (page 10-5).*

Inspect the fluid level in the reservoir at each engine oil change with the engine off and cold. Add fluid if necessary; it does not require periodic changing.

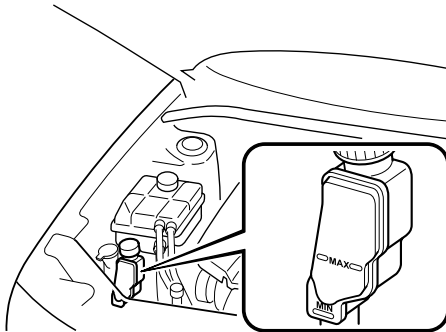

The level must be kept between MIN and MAX.

Visually examine the lines and hoses for leaks and damage.

If new fluid is required frequently, consult an Authorized Mazda Dealer.

### Automatic Transaxle Fluid (ATF)\*

#### ▼ Inspecting Automatic Transaxle Fluid Level (5-speed transaxle)

The automatic transaxle fluid level should be inspected regularly. Measure it as described below.

#### **CAUTION**

- *Always check the automatic transaxle fluid level according to the following procedure. If the procedure is not done correctly, the automatic transaxle fluid level cannot be measured accurately which could lead to automatic transaxle damage.*
- *A low fluid level can cause transaxle slippage. Overfilling can cause foaming, loss of fluid, and transaxle malfunction.*
- *It is recommended to use Mazda Genuine automatic transaxle fluid (page 10-5).*

1. Park on a level surface and set the parking brake firmly.
2. Make sure there is no ATF leakage from the ATF hose or the housing.
3. Shift the shift lever to the park position (P), start the engine and warm it up.

#### **CAUTION**

*Do not shift the shift lever while the engine is warming up. If the ATF level is extremely low, the automatic transaxle could be damaged.*

Maintenance and Care  
**Owner Maintenance**

4. While the engine is still idling, pull out the dipstick and wipe it clean, and then put it back.
5. Check the ATF level. If there is no ATF adhering 5 mm from the end of the dipstick, add ATF.

**CAUTION**

*If there is no ATF adhering to the dipstick even after the engine has been warmed up, do not drive the vehicle. Otherwise, the automatic transaxle could be damaged.*

6. Shift the shift lever to each range and position, and make sure there is no abnormality.
7. Drive the vehicle on city roads for 5 km (3.1 mile) or more.
8. Park on a level surface and set the parking brake firmly.
9. Shift the shift lever to the park position (P), check the ATF level while the engine is idling, and make sure that the ATF level is within the proper level. If the ATF level is not within the proper level, add ATF. The proper fluid level is marked on the dipstick as follows.

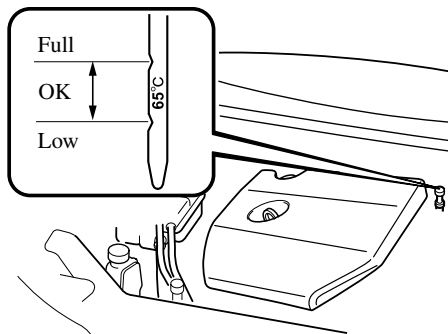

**CAUTION**

- *Use the cold scale only as a reference.*
- *If outside temperature is lower than about 20 °C (70 °F), start the engine and inspect the fluid level after the engine reaches operating temperature.*
- *If the vehicle has been driven for an extended period at high speeds or in city traffic in hot weather, inspect the level only after stopping the engine and allowing the fluid to cool for 30 minutes.*

Fully insert the dipstick. When adding fluid, inspect with the dipstick to make sure it does not pass full.

**NOTE**

*Inspect the fluid on both sides of the dipstick in a well lit area for an accurate reading.*

Maintenance and Care

## Owner Maintenance

### Washer Fluid

#### ▼ Inspecting Washer Fluid Level

#### ⚠ WARNING

**Use only windshield washer fluid or plain water in the reservoir:**

*Using radiator antifreeze as washer fluid is dangerous. If sprayed on the windshield, it will dirty the windshield, affect your visibility, and could result in an accident.*

#### **Using Washer Fluid Without Anti-freeze Protection in Cold Weather:**

*Operating your vehicle in temperatures below 4 degrees C (40 degrees F) using washer fluid without anti-freeze protection is dangerous as it could cause impaired windshield vision and result in an accident. In cold weather, always use washer fluid with anti-freeze protection.*

#### **NOTE**

*State or local regulations may restrict the use of volatile organic compounds (VOCs), which are commonly used as anti-freeze agents in washer fluid. A washer fluid with limited VOC content should be used only if it provides adequate freeze resistance for all regions and climates in which the vehicle will be operated.*

Inspect fluid level in the washer fluid reservoir; add fluid if necessary.

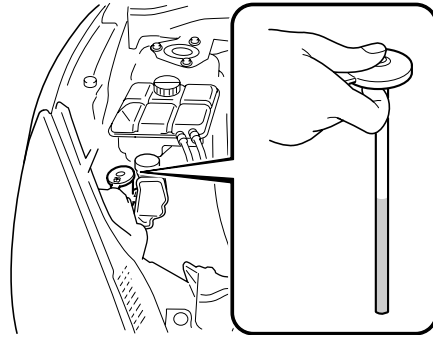

To inspect the washer fluid level in the front reservoir, pull off the cap. Then, holding your thumb over the hole in the center of the cap, lift it straight up. The fluid level can be seen from the fluid column in the pipe. Add fluid if necessary.

Use plain water if washer fluid is unavailable. But use only washer fluid in cold weather to prevent it from freezing.

#### **NOTE**

*Front and rear washer fluid is supplied from the same reservoir.*



## Owner Maintenance

### Body Lubrication

All moving points of the body, such as door and hood hinges and locks, should be lubricated each time the engine oil is changed. Use a nonfreezing lubricant on locks during cold weather.

Make sure the hood's secondary latch keeps the hood from opening when the primary latch is released.

### Wiper Blades

#### CAUTION

- *Hot waxes applied by automatic car washers have been known to affect the wiper's ability to clean windows.*
- *To prevent damage to the wiper blades, do not use gasoline, kerosene, paint thinner, or other solvents on or near them.*
- *When the wiper lever is in the AUTO position and the ignition is switched ON, the wipers may move automatically in the following cases:*
  - *If the windshield above the rain sensor is touched.*
  - *If the windshield above the rain sensor is wiped with a cloth.*
  - *If the windshield is struck with a hand or other object.*
  - *If the rain sensor is struck with a hand or other object from inside the vehicle.*

*Be careful not to pinch hands or fingers as it may cause injury, or damage the wipers. When washing or servicing your Mazda, make sure the wiper lever is in the OFF position.*

Contamination of either the windshield or the blades with foreign matter can reduce wiper effectiveness. Common sources are insects, tree sap, and hot wax treatments used by some commercial car washes.

If the blades are not wiping properly, clean the window and blades with a good cleaner or mild detergent; then rinse thoroughly with clean water. Repeat if necessary.

Maintenance and Care

## Owner Maintenance

### ▼ Replacing Windshield Wiper Blades

When the wipers no longer clean well, the blades are probably worn or cracked. Replace them.

#### **CAUTION**

*To prevent damage to the wiper arms and other components, don't try to sweep the wiper arm by hand.*

1. Raise the wiper arm and turn the blade assembly to expose the plastic locking clip. Compress the clip and slide the assembly downward; then lift it off the arm.

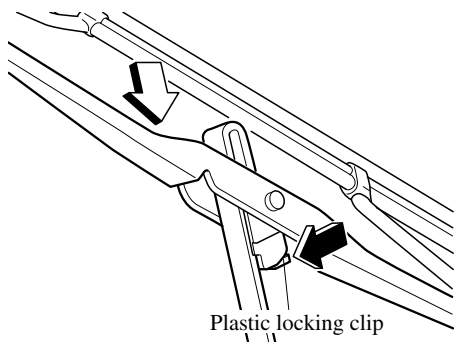

#### **CAUTION**

*To prevent damage to the windshield let the wiper arm down easily, don't let it slap down on the windshield.*

2. Hold the end of the rubber and pull until the tabs are free of the metal support.

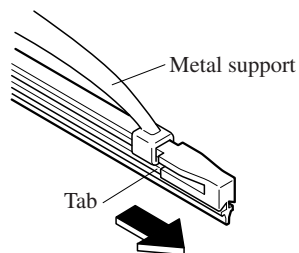

3. Remove the metal stiffener from each blade rubber and install them in the new blade.

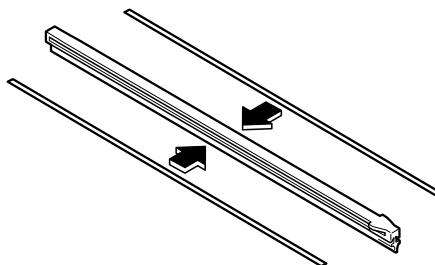

Maintenance and Care  
**Owner Maintenance**

**CAUTION**

- Don't bend or discard the stiffener. You need to use them again.
  - If the metal stiffeners are switched, the blade's wiping efficiency could be reduced. So don't use the driver's side metal stiffener on the passenger's side, or vice versa.
  - Be sure to reinstall the metal stiffener in the new blade rubber so that the curve is the same as it was in the old blade rubber.
4. Carefully insert the new blade rubber. Then install the blade assembly in the reverse order of removal.

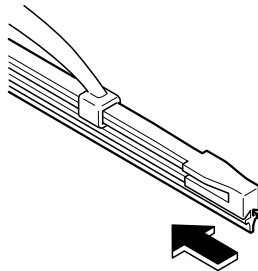

**NOTE**

Install the blade so that the tabs are toward the bottom of the wiper arm.

**▼ Replacing Rear Wiper Blade (5 Door)**

When the wiper no longer cleans well, the blade is probably worn or cracked. Replace it.

**CAUTION**

To prevent damage to the wiper arm and other components, don't try to sweep the wiper arm by hand.

1. Remove the cover and raise the wiper arm.

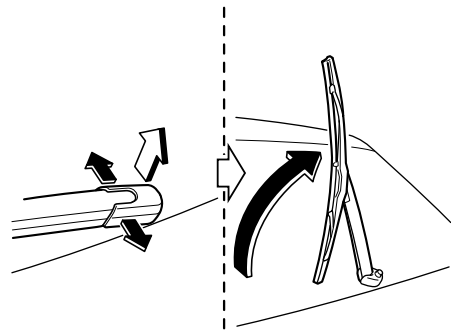

2. Firmly rotate the wiper blade to the right until it unlocks, then remove the blade.

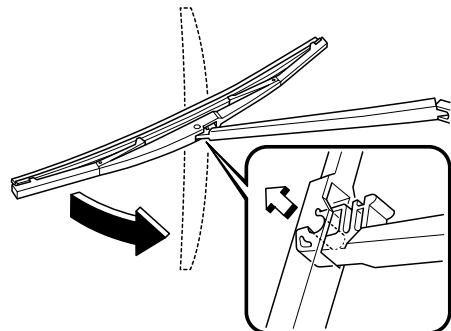

**CAUTION**

To prevent damage to the rear window let the wiper arm down easily, don't let it slap down on the rear window.

Maintenance and Care

## Owner Maintenance

3. Pull down the blade rubber and slide it out of the blade holder.

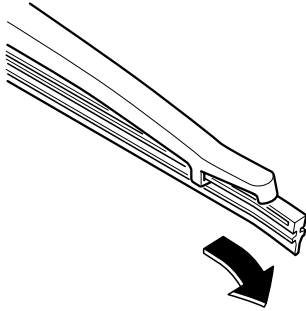

4. Remove the metal stiffeners from each blade rubber and install them in the new blade.

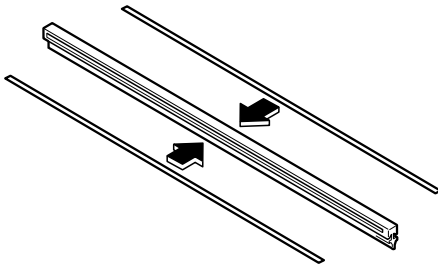

**CAUTION**

*Don't bend or discard the stiffeners.  
You need to use them again.*

5. Carefully insert the new blade rubber. Then install the blade assembly in the reverse order of removal.

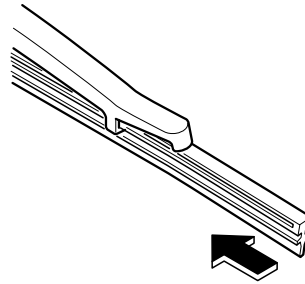

Maintenance and Care  
**Owner Maintenance**

## Battery

### **WARNING**

**Wash hands after handling the battery and related accessories:**

*Battery posts, terminals and related accessories contain lead and lead compounds, chemicals known to the State of California to cause cancer and reproductive harm.*



**Read the following precautions carefully before using the battery or inspecting to ensure safe and correct handling:**



**Always wear eye protection when working near the battery:**

*Working without eye protection is dangerous. Battery fluid contains SULFURIC ACID which could cause blindness if splashed into your eyes. Also, hydrogen gas produced during normal battery operation, could ignite and cause the battery to explode.*



**Wear eye protection and protective gloves to prevent contact with battery fluid:**

*Spilled battery fluid is dangerous.*

*Battery fluid contains SULFURIC ACID which could cause serious injuries if it gets in eyes, or on the skin or clothing. If this happens, immediately flush your eyes with water for 15 minutes or wash your skin thoroughly and get medical attention.*



**Always keep batteries out of the reach of children:**

*Allowing children to play near batteries is dangerous. Battery fluid could cause serious injuries if it gets in the eyes or on the skin.*



**Keep flames and sparks away from open battery cells and do not allow metal tools to contact the positive (+) or negative (-) terminal of the battery when working near a battery. Do not allow the positive (+) terminal to contact the vehicle body:**

*Flames and sparks near open battery cells are dangerous. Hydrogen gas, produced during normal battery operation, could ignite and cause the battery to explode. An exploding battery can cause serious burns and injuries. Keep all flames including cigarettes and sparks away from open battery cells.*

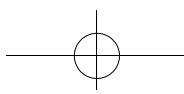

Maintenance and Care

## Owner Maintenance

---



**Keep all flames, including cigarettes, and sparks away from open battery cells:**  
*Flames and sparks near open battery cells are dangerous. Hydrogen gas, produced during normal battery operation, could ignite and cause the battery to explode. An exploding battery can cause serious burns and injuries.*

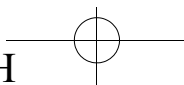

Maintenance and Care  
**Owner Maintenance**

**NOTE**

Remove the battery cover before performing battery maintenance.

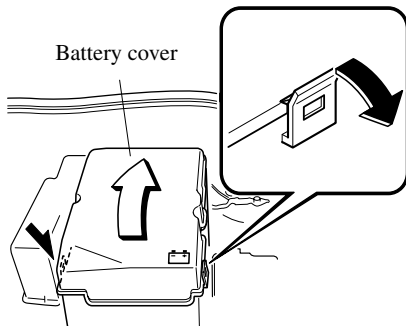

**CAUTION**

- Do not use a tool which applies excessive force such as a screwdriver or pliers. If excessive force is applied to the clips, they could be damaged. To prevent damaging the battery cover, remove/install the battery cover using the following procedure.

**Removing battery cover**

- 1 Detach the clip facing the side of the vehicle first and pull it outward with your finger approx. 4 mm (0.2 in). Then, lift the cover slightly to clear the lock.

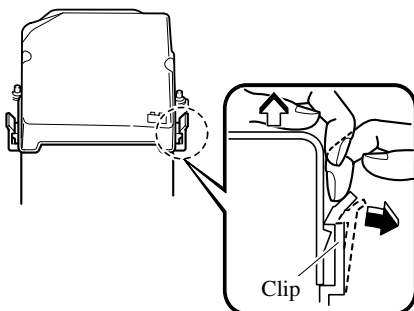

- 2 Detach the clip facing the vehicle interior first and pull it outward with your finger approx. 4 mm (0.2 in). Then, lift the cover slightly to clear the lock.

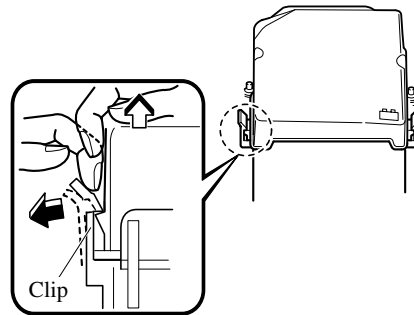

- 3 Pull out the battery cover being careful not to allow it to contact the cowl grille.

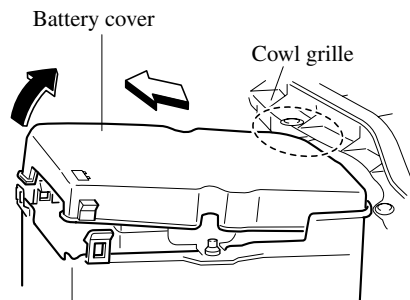

Maintenance and Care

## Owner Maintenance

### Installing battery cover

1 Being careful not to contact the cowl grille, insert the tabs on the one end of the battery cover into the holes of the battery tray and engage the tabs.

#### SKYACTIV-G 2.0

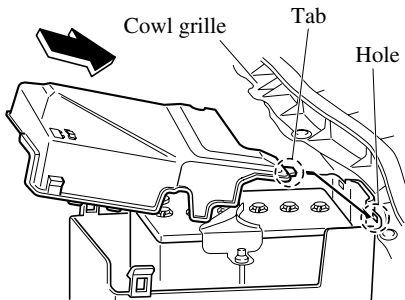

#### MZR 2.0, MZR 2.3 DISI Turbo and MZR 2.5

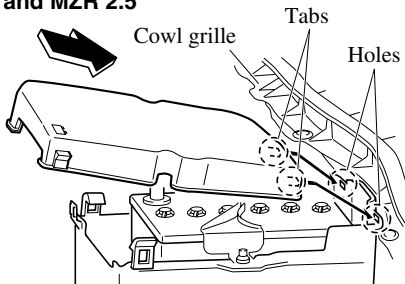

2 Attach the clips on both sides of the battery cover.

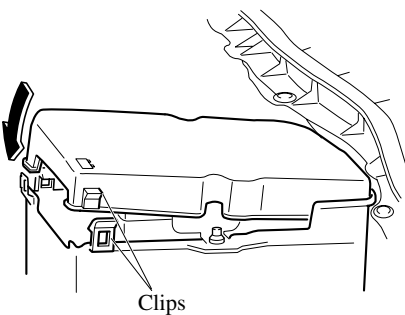

### ▼ Battery Maintenance

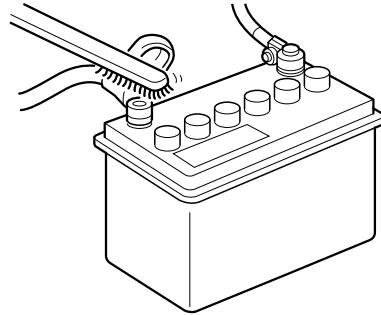

To get the best service from a battery:

- Keep it securely mounted.
- Keep the top clean and dry.
- Keep terminals and connections clean, tight, and coated with petroleum jelly or terminal grease.
- Rinse off spilled electrolyte immediately with a solution of water and baking soda.
- If the vehicle will not be used for an extended time, disconnect the battery cables.

When replacing the battery, refer to the specification charts (page 10-4).

### ▼ Inspecting Electrolyte Level

A low level of electrolyte fluid will cause the battery to discharge quickly.

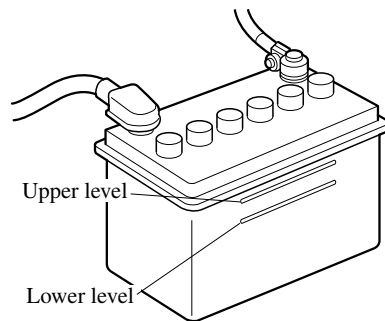



## Owner Maintenance

Inspect the electrolyte level at least once a week. If it's low, remove the caps and add enough distilled water to bring the level between the upper and lower level (illustration).

### **Don't overfill.**

Examine the specific gravity of the electrolyte with a hydrometer, especially during cold weather. If it's low, recharge the battery.

## Tires

For reasons of proper performance, safety, and better fuel economy, always maintain recommended tire inflation pressures and stay within the recommended load limits and weight distribution.

### **⚠ WARNING**

#### **Using Different Tire Types:**

*Driving your vehicle with different types of tires is dangerous. It could cause poor handling and poor braking; leading to loss of control. Except for the limited use of the temporary spare tire, use only the same type tires (radial, bias-belted, bias-type) on all four wheels.*

#### **Using Wrong-Sized Tires:**

*Using any other tire size than what is specified for your Mazda (page 10-12) is dangerous. It could seriously affect ride, handling, ground clearance, tire clearance, and speedometer calibration. This could cause you to have an accident. Use only tires that are the correct size specified for your Mazda.*

Maintenance and Care

## Owner Maintenance

### ▼ Tire Inflation Pressure

#### **⚠ WARNING**

**Always inflate the tires to the correct pressure:**

*Overinflation or underinflation of tires is dangerous. Adverse handling or unexpected tire failure could result in a serious accident.*

*Refer to Tires on page 10-12.*

**Use only a Mazda-genuine tire valve cap:**

*Use of a non-genuine part is dangerous as the correct tire air pressure cannot be maintained if the tire valve becomes damaged. If the vehicle is driven under this condition, the tire air pressure will decrease which could result in a serious accident. Do not use any part for the tire valve cap that is not a Mazda-genuine part.*

The Tire Pressure Monitoring System\* does not alleviate the need to check the tire condition every day, including whether the tires all look inflated properly. Inspect all tire pressure monthly (including the spare) when the tires are cold. Maintain recommended pressures for the best ride, handling, and minimum tire wear.

When checking the tire pressures, use of a digital tire pressure gauge is recommended.

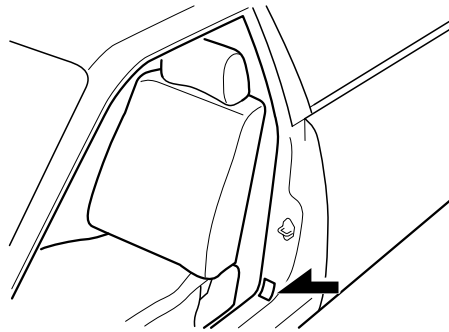

Refer to the specification charts (page 10-12).

Maintenance and Care  
**Owner Maintenance**

**NOTE**

- *Always check tire pressure when tires are cold.*
- *Warm tires normally exceed recommended pressures. Don't release air from warm tires to adjust the pressure.*
- *Underinflation can cause reduced fuel economy, uneven and accelerated tire wear, and poor sealing of the tire bead, which will deform the wheel and cause separation of tire from rim.*
- *Overinflation can produce a harsh ride, uneven and accelerated tire wear, and a greater possibility of damage from road hazards.*

*Keep your tire pressure at the correct levels. If one frequently needs inflating, have it inspected.*

▼ **Tire Rotation**

**! WARNING**

**Rotate tires periodically:**

*Irregular tire wear is dangerous. To equalize tread wear for maintaining good performance in handling and braking, rotate the tires according to the scheduled maintenance charts. Refer to Scheduled Maintenance on page 8-4.*

During rotation, inspect them for correct balance.

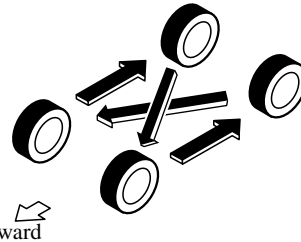

Do not include (TEMPORARY USE ONLY) spare tire in rotation.

Also, inspect them for uneven wear and damage. Abnormal wear is usually caused by one or a combination of the following:

- Incorrect tire pressure
- Improper wheel alignment
- Out-of-balance wheel
- Severe braking

After rotation, inflate all tire pressures to specification (page 10-12) and inspect the lug nuts for tightness.

**! CAUTION**

*Rotate unidirectional tires and radial tires that have an asymmetrical tread pattern or studs only from front to rear, not from side to side. Tire performance will be reduced if rotated from side to side.*

Maintenance and Care

## Owner Maintenance

### **CAUTION**

Limited-Slip Differential system;  
don't use the following:

- Tires not of the designated size
- Tires of different sizes or types at the same time
- Tires not sufficiently inflated

If these instructions aren't followed, the rotation of the left and right wheels will be different and will thus apply a constant load on the limited-slip differential.

This will cause a malfunction.

### ▼ Replacing a Tire

### **WARNING**

Always use tires that are in good condition:

Driving with worn tires is dangerous. Reduced braking, steering, and traction could result in an accident.

**Replace all four tires at the same time:** Replacing just one tire is dangerous. It could cause poor handling and poor braking resulting in loss of vehicle control. Mazda strongly recommends that you replace all four tires at the same time.

### **CAUTION**

(With Tire Pressure Monitoring System)

When replacing/repairing the tires or wheels or both, have the work done by an Authorized Mazda Dealer, or the tire pressure sensors may be damaged.

### **NOTE**

(With Tire Pressure Monitoring System)

- When tires with steel wire reinforcement in the sidewalls are used, the system may not function correctly even with a genuine wheel.  
Refer to System Error Activation on page 5-35.
- Be sure to install the tire pressure sensors whenever tires or wheels are replaced.  
Refer to Tires and Wheels on page 5-35.

If a tire wears evenly, a wear indicator will appear as a solid band across the tread.

Replace the tire when this happens.

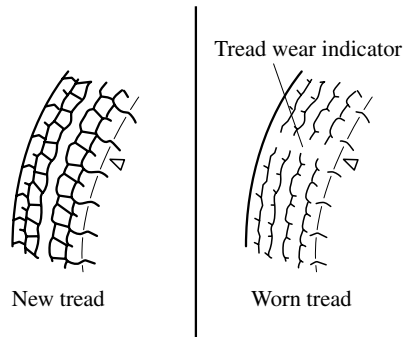

You should replace the tire before the band crosses the entire tread.

### **NOTE**

Tires degrade over time, even when they are not being used on the road. It is recommended that tires generally be replaced when they are 6 years or older. Heat caused by hot climates or frequent high loading conditions can accelerate the aging process. You should replace the spare tire when you replace the other road tires due to the aging of the spare tire. The period in which the tire was manufactured (both week and year) is indicated by a 4-digit number. Refer to Tire Labeling on page 9-24.

Maintenance and Care  
**Owner Maintenance**

### ▼ Temporary Spare Tire

Inspect the temporary spare tire at least monthly to make sure it's properly inflated and stored.

#### **NOTE**

*The temporary spare tire condition gradually deteriorates even if it has not been used.*

The temporary spare tire is easier to handle because of its construction which is lighter and smaller than a conventional tire. This tire should be used only for an emergency and only for a short distance.

Use the temporary spare tire only until the conventional tire is repaired, which should be as soon as possible.

Maintain its pressure at 420 kPa (4.2 kgf/cm<sup>2</sup> or bar, 60 psi).

#### **CAUTION**

- *Do not use your temporary spare tire rim with a snow tire or a conventional tire. Neither will properly fit and could damage both tire and rim.*
- *The temporary spare tire has a tread life of less than 5,000 km (3,000 miles). The tread life may be shorter depending on driving conditions.*
- *The temporary spare tire is for limited use, however, if the tread wear solid-band indicator appears, replace the tire with the same type of temporary spare (page 8-42).*

#### **NOTE**

*Tires degrade over time, even when they are not being used on the road. It is recommended that tires generally be replaced when they are 6 years or older. Heat caused by hot climates or frequent high loading conditions can accelerate the aging process. You should replace the spare tire when you replace the other road tires due to the aging of the spare tire. The period in which the tire was manufactured (both week and year) is indicated by a 4-digit number. Refer to Tire Labeling on page 9-24.*

### ▼ Replacing a Wheel

#### **WARNING**

**Always use wheels of the correct size on your vehicle:**

*Using a wrong-sized wheel is dangerous. Braking and handling could be affected, leading to loss of control and an accident.*

Maintenance and Care

## Owner Maintenance

---

### CAUTION

- *A wrong-sized wheel may adversely affect:*
  - *Tire fit*
  - *Wheel and bearing life*
  - *Ground clearance*
  - *Snow-chain clearance*
  - *Speedometer calibration*
  - *Headlight aim*
  - *Bumper height*
  - *Tire Pressure Monitoring System*
  - *Limited-Slip Differential System*
- **(With Tire Pressure Monitoring System)**
  - *When replacing/repairing the tires or wheels or both, have the work done by an Authorized Mazda Dealer, or the tire pressure sensors may be damaged.*
  - *The wheels equipped on your Mazda are specially designed for installation of the tire pressure sensors. Do not use non-genuine wheels, otherwise it may not be possible to install the tire pressure sensors.*

### **NOTE**

*Be sure to install the tire pressure sensors whenever tires or wheels are replaced. Refer to Tires and Wheels on page 5-35.*

When replacing a wheel, make sure the new one is the same as the original factory wheel in diameter, rim width, and offset (inset/outset).

Proper tire balancing provides the best riding comfort and helps reduce tread wear. Out-of-balance tires can cause vibration and uneven wear, such as cupping and flat spots.

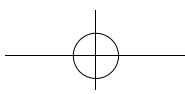

# MEMO

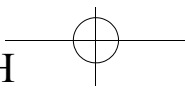
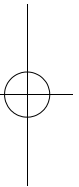
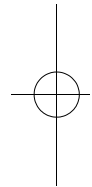

Maintenance and Care

# Owner Maintenance

## Light Bulbs

### Xenon fusion bulb/Adaptive Front Lighting System

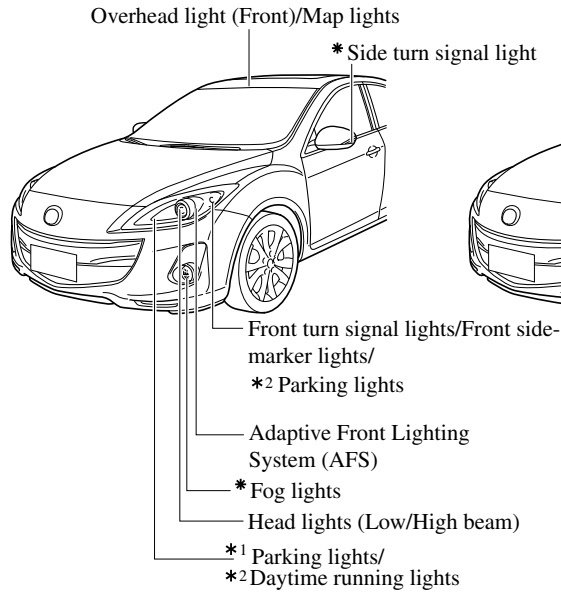

### Halogen bulb

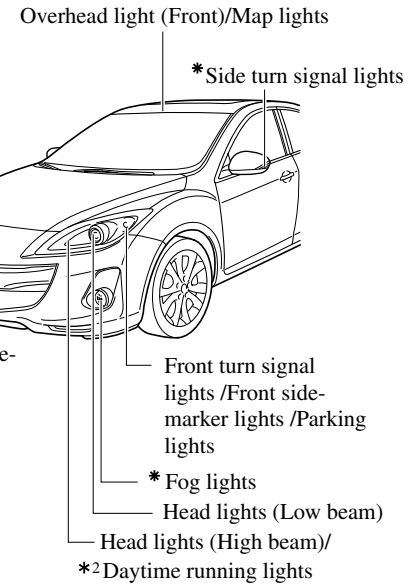

### 4 Door

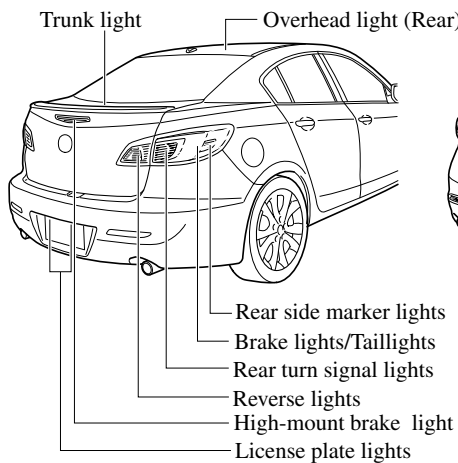

### 5 Door

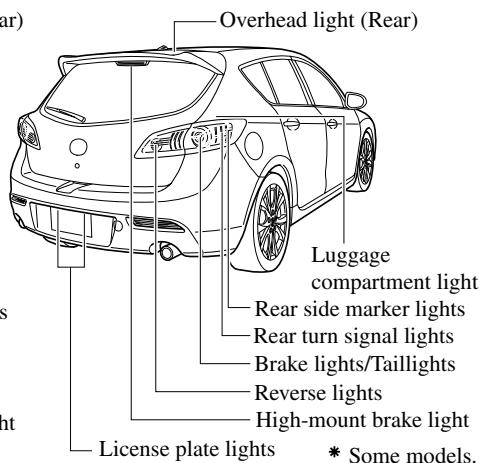

- \* Some models.
- \*1 Except Canada
- \*2 Canada



Maintenance and Care  
**Owner Maintenance**

**⚠ WARNING**

**Do not replace the xenon fusion bulbs yourself:**

*Replacing the xenon fusion bulbs yourself is dangerous. Because the xenon fusion bulbs require high voltage, you could receive an electric shock if the bulbs are handled incorrectly. Consult an Authorized Mazda Dealer when the replacement is necessary.*

**Never touch the glass portion of a halogen bulb with your bare hands and always wear eye protection when handling or working around the bulbs:**

*When a halogen bulb breaks, it is dangerous. These bulbs contain pressurized gas. If one is broken, it will explode and serious injuries could be caused by the flying glass. If the glass portion is touched with bare hands, body oil could cause the bulb to overheat and explode when lit.*

**Always keep halogen bulbs out of the reach of children:**

*Playing with a halogen bulb is dangerous. Serious injuries could be caused by dropping a halogen bulb or breaking it some other way.*

**▼ Replacing Exterior Light Bulbs**

**NOTE**

- *To replace the bulb, contact an Authorized Mazda Dealer.*
- *If the halogen bulb is accidentally touched, it should be cleaned with rubbing alcohol before being used.*
- *Use the protective cover and carton for the replacement bulb to dispose of the old bulb promptly and out of the reach of children.*

**Xenon fusion bulb/Adaptive front lighting system**

**Replacing the headlight bulbs**

**(Low/High beam bulbs)**

You cannot replace the low/high beam bulbs by yourself. The bulbs must be replaced at an expert repairer, we recommend an Authorized Mazda Dealer.

**Parking lights (Except Canada)**

1. Make sure the ignition is switched off and the headlight switch is off.
2. Turn the socket and bulb assembly counterclockwise and remove it.
3. Disconnect the bulb from the socket.

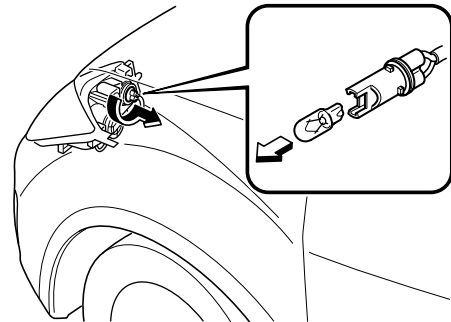

4. Install the new bulb in the reverse order of the removal procedure.

**Daytime running lights (Canada)**

**(Type A)**

1. Make sure the ignition is switched off and the headlight switch is off.

Maintenance and Care

## Owner Maintenance

2. Disconnect the electrical connector from the bulb by pressing the tab on the connector with your finger and pulling the connector downward.

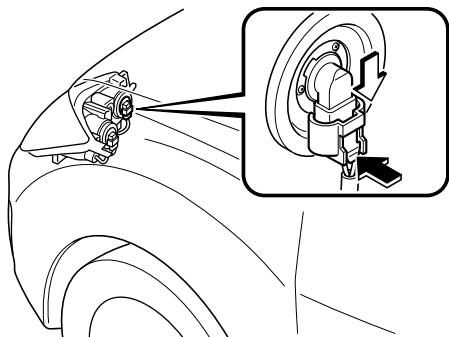

3. Turn the socket and bulb assembly to remove it. Carefully remove the bulb from its socket in the reflector by gently pulling it straight backward out of the socket.

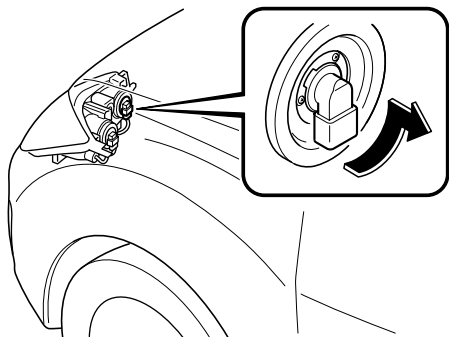

4. Install the new bulb in the reverse order of the removal procedure.

### (Type B)

1. Make sure the ignition is switched off and the headlight switch is off.
2. Turn the socket and bulb assembly counterclockwise and remove it.

3. Disconnect the bulb from the socket.

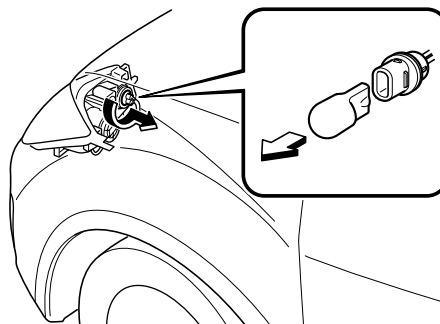

4. Install the new bulb in the reverse order of the removal procedure.

### Front turn signal lights/Front side-marker lights/Parking lights (Canada)

1. Make sure the ignition is switched off and the headlight switch is off.
2. If you are changing the right bulb, start the engine, turn the steering wheel all the way to the left, and turn off engine. If you are changing the left bulb, turn the steering wheel to the right.
3. Turn the center section of the plastic retainer counterclockwise and remove the retainers and partially peel back the mudguard.

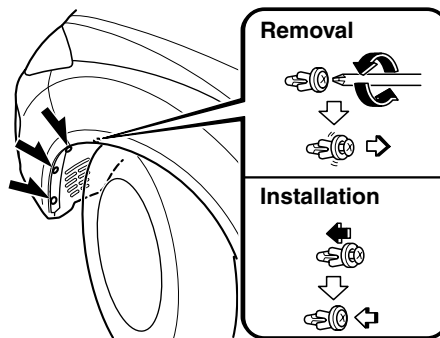

Maintenance and Care  
**Owner Maintenance**

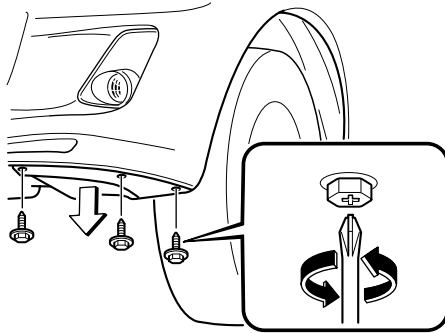

4. Turn the socket and bulb assembly counterclockwise and remove it.
5. Disconnect the bulb from the socket.

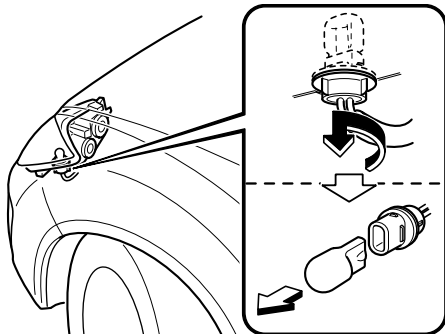

6. Install the new bulb in the reverse order of the removal procedure.

**Halogen bulb**

**High-beam bulbs/Daytime running lights (Canada)**

1. Make sure the ignition is switched off and the headlight switch is off.

2. Disconnect the electrical connector from the bulb by pressing the tab on the connector with your finger and pulling the connector downward.

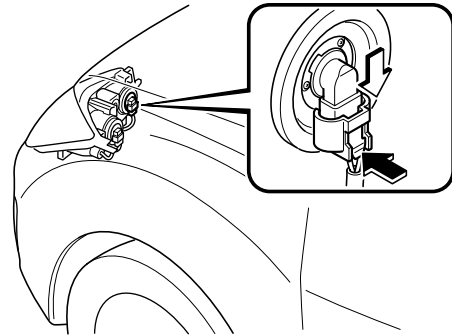

3. Turn the socket and bulb assembly to remove it. Carefully remove the bulb from its socket in the reflector by gently pulling it straight backward out of the socket.

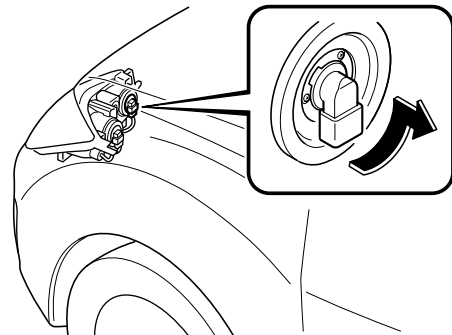

4. Install the new bulb in the reverse order of the removal procedure.

**Low-beam bulbs**

1. Make sure the ignition is switched off and the headlight switch is off.

Maintenance and Care

## Owner Maintenance

2. Disconnect the electrical connector from the bulb by pressing the tab on the connector with your finger and pulling the connector downward.

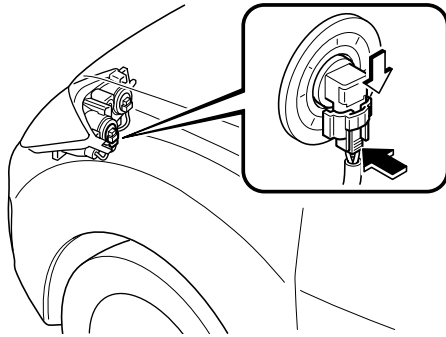

3. Turn the socket and bulb assembly to remove it. Carefully remove the bulb from its socket in the reflector by gently pulling it straight backward out of the socket.

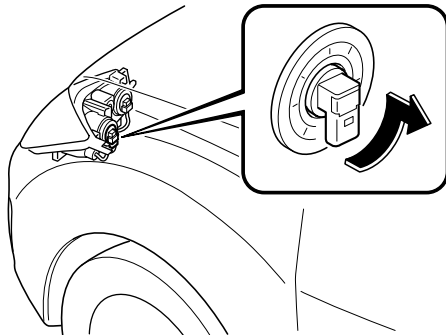

4. Install the new bulb in the reverse order of the removal procedure.

### Front turn signal lights/Front side-marker lights/Parking lights

1. Make sure the ignition is switched off and the headlight switch is off.

2. If you are changing the right bulb, start the engine, turn the steering wheel all the way to the left, and turn off engine. If you are changing the left bulb, turn the steering wheel to the right.
3. Turn the center section of the plastic retainer counterclockwise and remove the retainers and partially peel back the mudguard.

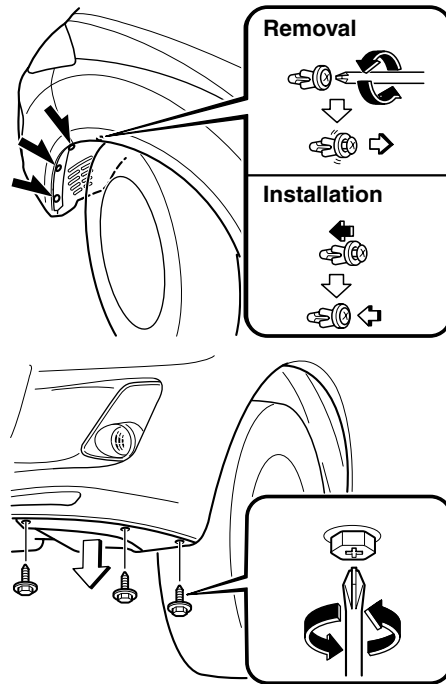

4. Turn the socket and bulb assembly counterclockwise and remove it.

Maintenance and Care  
**Owner Maintenance**

5. Disconnect the bulb from the socket.

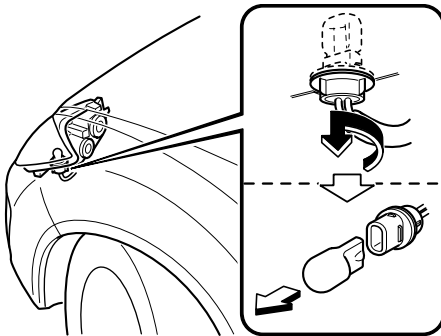

6. Install the new bulb in the reverse order of the removal procedure.

**Fog lights**\*

1. Make sure the ignition is switched off and the headlight switch is off.
2. Turn the screw counterclockwise and remove it and then partially peel back the mudguard.

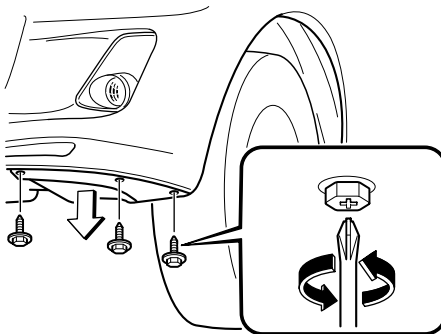

3. Disconnect the electrical connector from the bulb by pressing the tab on the connector with your finger and pulling the connector downward.

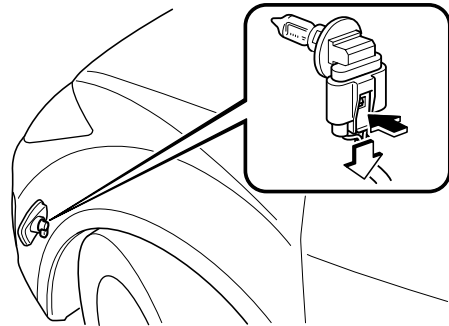

4. Turn the socket and bulb assembly to remove it. Carefully remove the bulb from its socket in the reflector by gently pulling it straight back out of the socket.

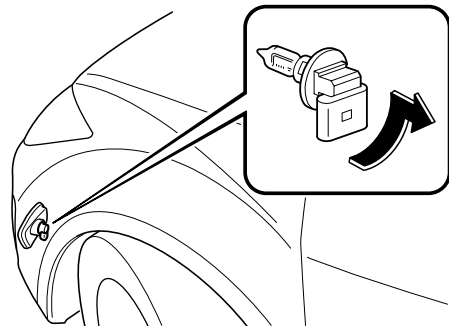

5. Install the new bulb in the reverse order of the removal procedure.

**Side-turn signal lights**\*

Due to the complexity and difficulty of the procedure, the LED bulbs must be replaced by an Authorized Mazda Dealer.

**NOTE**

*LED bulb replacement is not possible because it is built into the unit. Replace the unit.*

Maintenance and Care

## Owner Maintenance

### **Brake lights/Taillights (Rear side marker lights)**

#### **LED type**

Due to the complexity and difficulty of the procedure, the LED bulbs must be replaced by an Authorized Mazda Dealer.

#### **NOTE**

*LED bulb replacement is not possible because it is built into the unit. Replace the unit.*

#### **Bulb type**

##### **(4 Door)**

1. Make sure the ignition is switched off and the headlight switch is off.
2. Pull the center of each plastic retainer and remove the retainers and the trunk end trim.

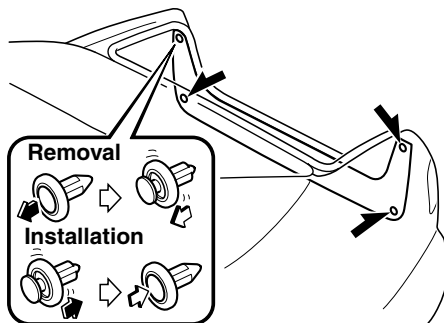

3. Turn the socket and bulb assembly counterclockwise and remove it.

4. Disconnect the bulb from the socket.

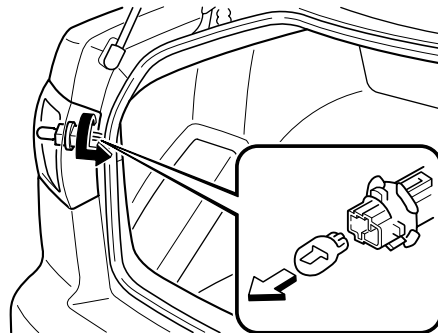

5. Install the new bulb in the reverse order of the removal procedure.

##### **(5 Door)**

1. Make sure the ignition is switched off and the headlight switch is off.
2. Remove the cover.

##### **Left side**

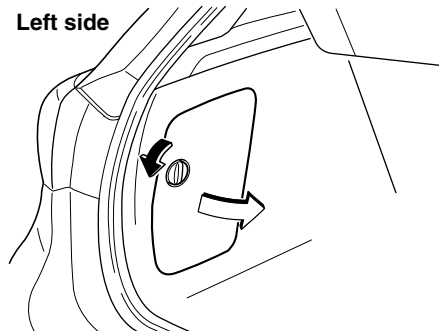

Maintenance and Care  
**Owner Maintenance**

**Right side**

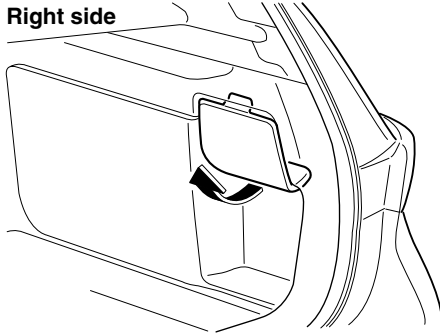

3. Turn the socket and bulb assembly counterclockwise and remove it.
4. Disconnect the bulb from the socket.

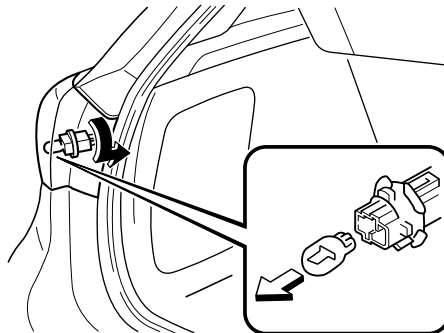

5. Install the new bulb in the reverse order of the removal procedure.

**Rear turn signal lights**

**(4 Door)**

1. Make sure the ignition is switched off and the headlight switch is off.

2. Pull the center of each plastic retainer and remove the retainers and the trunk end trim.

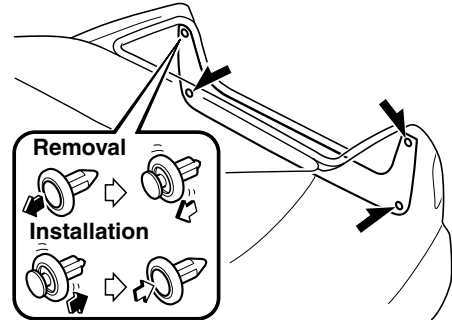

3. Turn the socket and bulb assembly counterclockwise and remove it.
4. Disconnect the bulb from the socket.

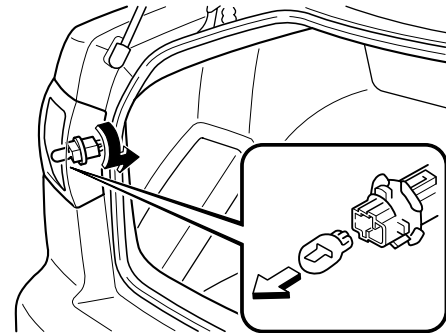

5. Install the new bulb in the reverse order of the removal procedure.

**(5 Door)**

1. Make sure the ignition is switched off and the headlight switch is off.

Maintenance and Care

## Owner Maintenance

2. Remove the cover.

**Left side**

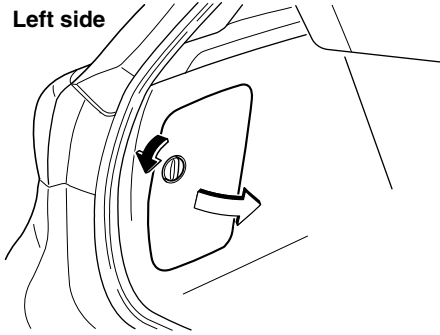

**Right side**

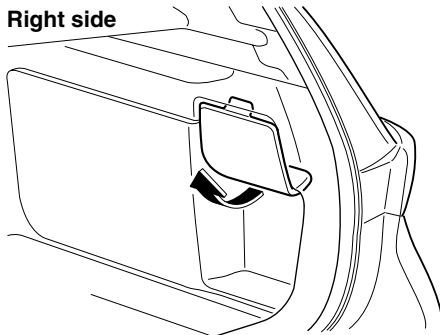

3. Turn the socket and bulb assembly counterclockwise and remove it.
4. Disconnect the bulb from the socket.

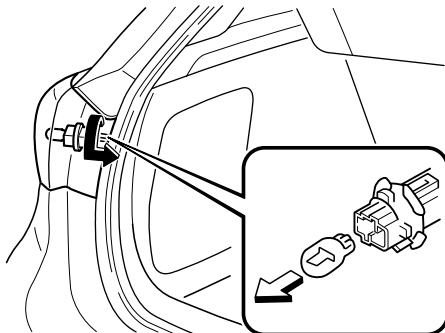

5. Install the new bulb in the reverse order of the removal procedure.

8-54

### Reverse lights

#### **(4 Door)**

1. Make sure the ignition is switched off and the headlight switch is off.
2. Pull the center of each plastic retainer and remove the retainers and the trunk lid trim.

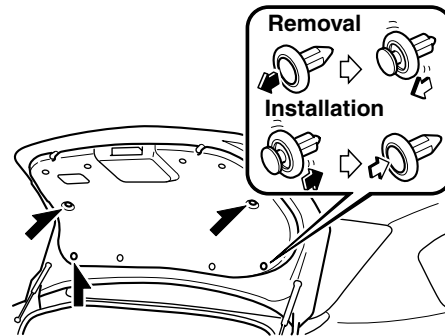

3. Turn the socket and bulb assembly counterclockwise and remove it.
4. Disconnect the bulb from the socket.

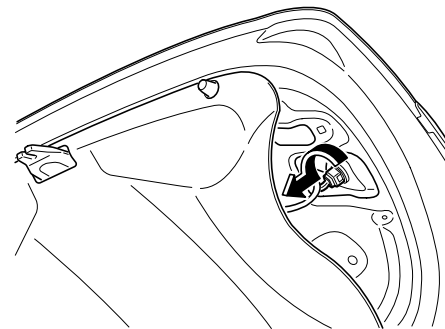

5. Install the new bulb in the reverse order of the removal procedure.

#### **(5 Door)**

1. Make sure the ignition is switched off and the headlight switch is off.



Maintenance and Care  
**Owner Maintenance**

2. Remove the cover.

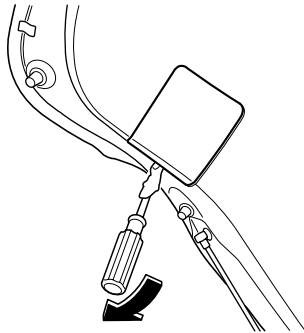

3. Turn the socket and bulb assembly counterclockwise and remove it.
4. Disconnect the bulb from the socket.

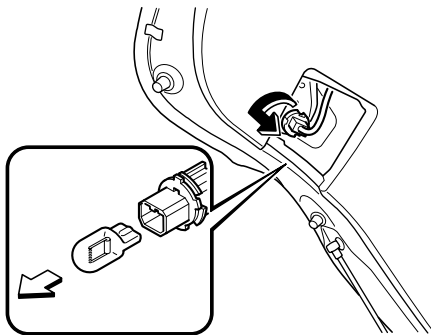

5. Install the new bulb in the reverse order of the removal procedure.

**High-mount brake light**

**(4 Door)**

1. Make sure the ignition is switched off and the headlight switch is off.

2. Pull the center of each plastic retainer and remove the retainers and the trunk lid trim.

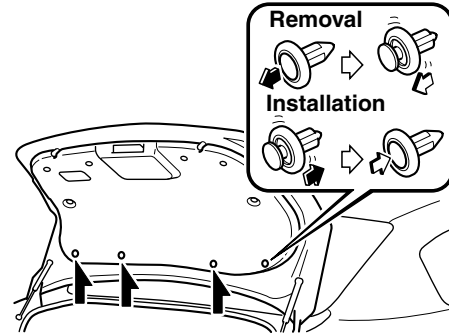

3. Turn the socket and bulb assembly counterclockwise and remove it.
4. Disconnect the bulb from the socket.

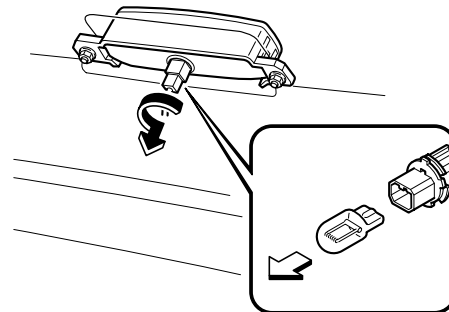

5. Install the new bulb in the reverse order of the removal procedure.

**(5 Door)**

**LED type**

Due to the complexity and difficulty of the procedure, the LED bulbs must be replaced by an Authorized Mazda Dealer.

**NOTE**

*LED bulb replacement is not possible because it is built into the unit. Replace the unit.*

Maintenance and Care

## Owner Maintenance

### Bulb type

1. Make sure the ignition is switched off and the headlight switch is off.
2. Remove the liftgate upper trim.

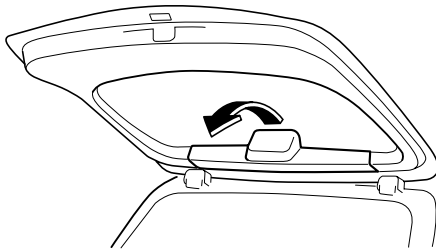

3. Disconnect the electrical connector from the bulb by pressing the tab on the connector with your finger and pulling the connector sideward to the left.

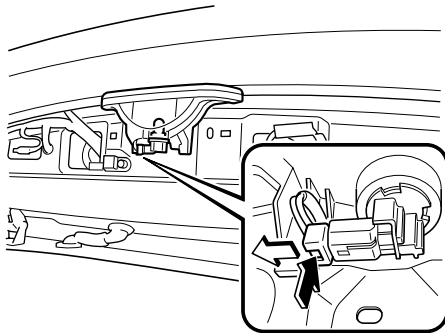

4. Turn the socket and bulb assembly counterclockwise and remove it.

5. Disconnect the bulb from the socket.

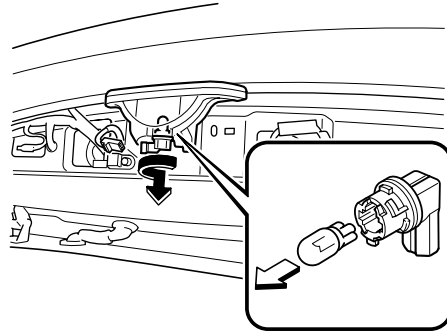

6. Install the new bulb in the reverse order of the removal procedure.

### License plate lights

1. Make sure the ignition is switched off and the headlight switch is off.
2. Wrap a flathead screwdriver with a soft cloth to prevent damage to the lens, and then remove the lens by carefully prying on the edge of the lens with a flathead screwdriver.

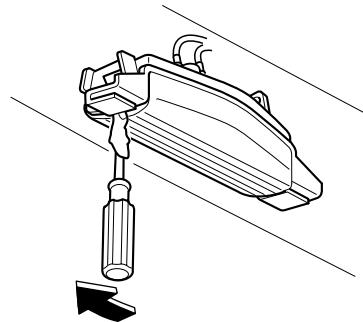

Maintenance and Care  
**Owner Maintenance**

3. Disconnect the bulb by pulling it out.

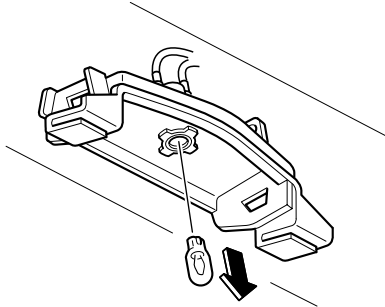

4. Install the new bulb in the reverse order of the removal procedure.

**▼ Replacing Interior Light Bulbs**

**Overhead light (Front)/Map lights,**  
**Overhead light (Rear), Vanity mirror**  
**lights\***

1. Wrap a small flathead screwdriver with a soft cloth to prevent damage to the lens, and then remove the lens by carefully prying on the edge of the lens with the flathead screwdriver.
2. Disconnect the bulb by pulling it out.

**Overhead light (Front)/Map lights**

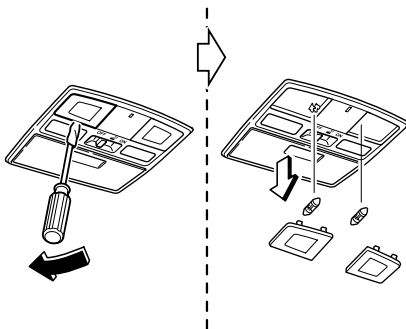

**Overhead light (Rear)**

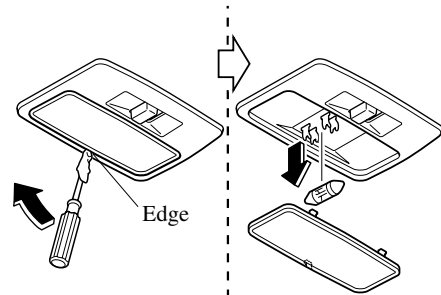

**Vanity mirror lights\***

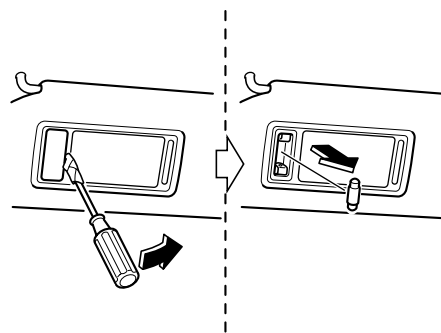

3. Install the new bulb in the reverse order of the removal procedure.

**Trunk light (4 Door)**

1. Press both sides of the lens cap to remove it.

Maintenance and Care

## Owner Maintenance

2. Disconnect the bulb by pulling it out.

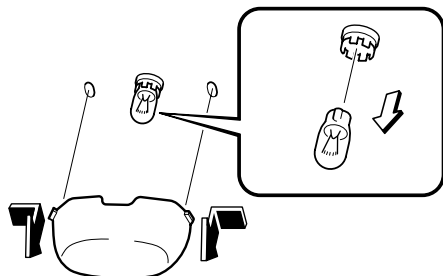

3. Install the new bulb in the reverse order of the removal procedure.

### Luggage compartment light (5 Door)

1. Wrap a small flathead screwdriver with a soft cloth to prevent damage to the lens and remove the lens by carefully prying on the edge of the lens with the flathead screwdriver.
2. Disconnect the bulb by pulling it out.

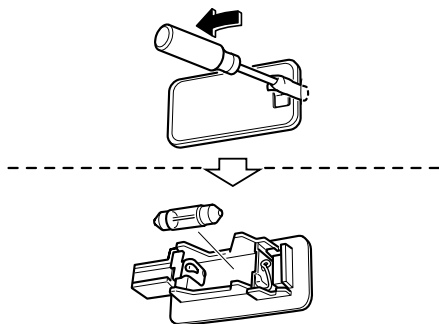

3. Install the new bulb in the reverse order of the removal procedure.

## Fuses

Your vehicle's electrical system is protected by fuses.

If any lights, accessories, or controls don't work, inspect the appropriate circuit protector. If a fuse has blown, the inside element will be melted.

If the same fuse blows again, avoid using that system and consult an Authorized Mazda Dealer as soon as possible.

### ▼ Fuse Replacement

#### Replacing the fuses on the vehicle's left side

If the electrical system does not work, first inspect the fuses on the vehicle's left side.

1. Make sure the ignition is switched off, and other switches are off.
2. Remove the cover.

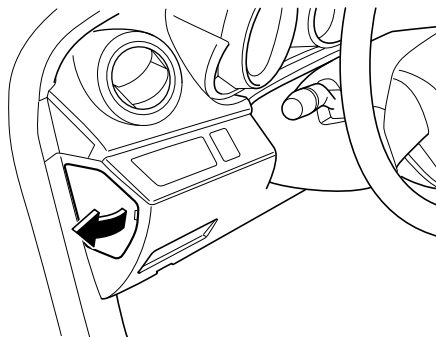

Maintenance and Care  
**Owner Maintenance**

3. Pull the fuse straight out with the fuse puller provided on the inside of the engine compartment fuse block cover.

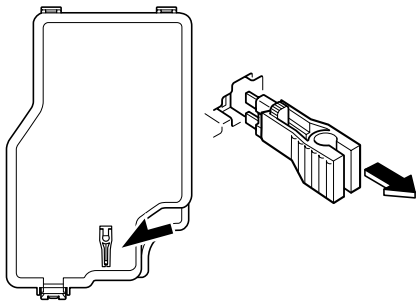

4. Inspect the fuse and replace it if it's blown.

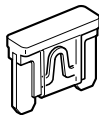

Normal

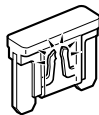

Blown

5. Insert a new fuse of the same amperage rating, and make sure it fits tightly. If it does not fit tightly, have an expert install it. We recommend an Authorized Mazda Dealer. If you have no spare fuses, borrow one of the same rating from a circuit not essential to vehicle operation, such as the AUDIO or CIGAR circuit.

**CAUTION**

*Always replace a fuse with one of the same rating. Otherwise you may damage the electric system.*

6. Reinstall the cover and make sure that it is securely installed.

**Replacing the fuses under the hood**

If the headlights or other electrical components do not work and the fuses in the cabin are normal, inspect the fuse block under the hood. If a fuse is blown, it must be replaced. Follow these steps:

1. Make sure the ignition is switched off, and other switches are off.
2. Remove the fuse block cover.

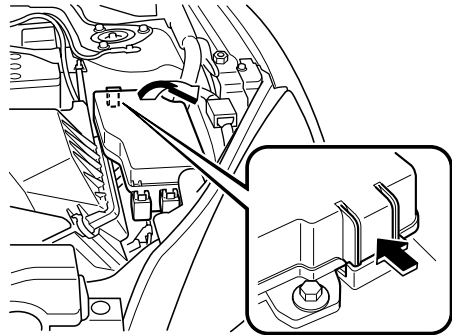

3. If any fuse but the MAIN fuse is blown, replace it with a new one of the same amperage rating.

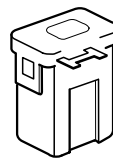

Normal

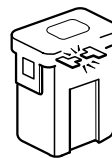

Blown

Maintenance and Care

## Owner Maintenance

---

### **WARNING**

***Do not replace the main fuse by yourself. Have an Authorized Mazda Dealer perform the replacement:***

*Replacing the fuse by yourself is dangerous because the MAIN fuse is a high current fuse. Incorrect replacement could cause an electrical shock or a short circuit resulting in a fire.*

4. Reinstall the cover and make sure that it is securely installed.

Maintenance and Care  
**Owner Maintenance**

▼ **Fuse Panel Description**

**Fuse block (Engine compartment)**

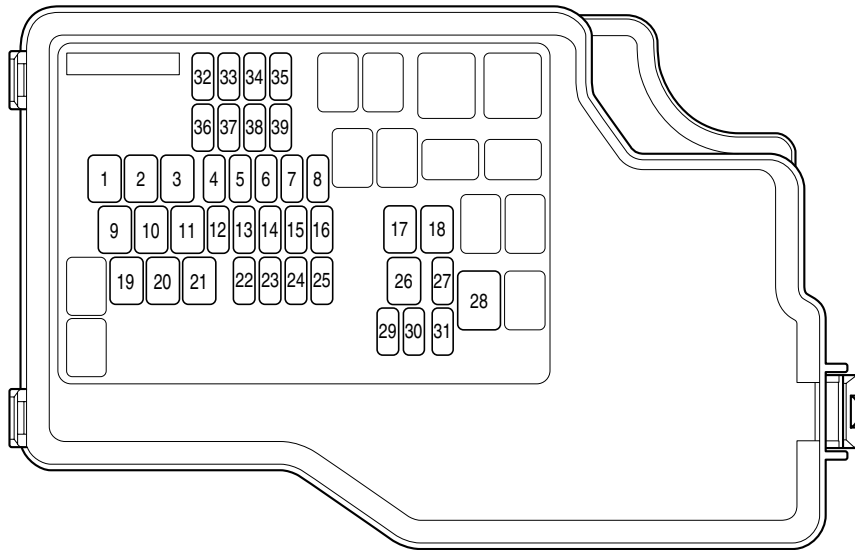

| DESCRIPTION |                        | FUSE RATING | PROTECTED COMPONENT                |
|-------------|------------------------|-------------|------------------------------------|
| 1           | DCDC* <sup>1</sup>     | —           | —                                  |
|             | FAN 2* <sup>2</sup>    | 40 A        | Cooling fan *                      |
| 2           | ENG MAIN               | 40 A        | Engine control system              |
| 3           | BTN 1                  | 50 A        | For protection of various circuits |
| 4           | A/C MAG                | 7.5 A       | Air conditioner                    |
| 5           | H/L HI                 | 20 A        | Headlight high beam                |
| 6           | FOG                    | 15 A        | Fog lights *                       |
| 7           | H/L WASH               | —           | —                                  |
| 8           | SUNROOF                | 15 A        | Moonroof*                          |
| 9           | HEATER* <sup>1</sup>   | 40 A        | Air conditioner                    |
|             | F.DEF RH* <sup>2</sup> | —           | —                                  |
| 10          | EVVT* <sup>1</sup>     | 20 A        | Engine control system              |
|             | F.DEF LH* <sup>2</sup> | —           | —                                  |
| 11          | FAN 1                  | 40 A        | Cooling fan *                      |
| 12          | ROOM                   | 15 A        | Overhead lights                    |
| 13          | TCM                    | 15 A        | Transaxle control system *         |
| 14          | DSC                    | 20 A        | Dynamic Stability Control system * |

\* Some models. **8-61**

Maintenance and Care

## Owner Maintenance

| DESCRIPTION |                         | FUSE RATING | PROTECTED COMPONENT                              |
|-------------|-------------------------|-------------|--|
| 15          | BTN 2                   | 7.5 A       | For protection of various circuits               |
| 16          | AT PUMP                 | —           | —  |
| 17          | PTC* <sup>1</sup>       | —           | —  |
|             | HEATER* <sup>2</sup>    | 40 A        | Air conditioner                                  |
| 18          | INJ                     | 30 A        | Engine control system*                           |
| 19          | R.DEF                   | 30 A        | Rear window defroster                            |
| 20          | IGKEY 2                 | 40 A        | For protection of various circuits               |
| 21          | IGKEY 1                 | 40 A        | For protection of various circuits               |
| 22          | HORN                    | 15 A        | Horn   |
| 23          | STOP                    | 15 A        | Brake lights                                     |
| 24          | ENG+B                   | 10A         | Engine control system                            |
| 25          | FUEL PUMP               | 25 A        | Fuel system                                      |
| 26          | ABS                     | 40 A        | ABS  |
| 27          | SEAT WARM               | 20 A        | Seat warmer*                                     |
| 28          | EHPAS                   | 80 A        | Power assist steering                            |
| 29          | —                       | —           | —  |
| 30          | ABS IG                  | 7.5 A       | ABS  |
| 31          | SWS                     | 7.5 A       | Air bag  |
| 32          | H/L LO RH               | 15 A        | Headlight low beam (RH)                          |
| 33          | H/L LO LH               | 15 A        | Headlight low beam (LH)                          |
| 34          | ILLUM                   | 7.5 A       | Instrument panel illumination                    |
| 35          | TAIL                    | 15 A        | Taillights, Parking lights, License plate lights |
| 36          | ENG INJ                 | 15 A        | Engine control system                            |
| 37          | ENG BAR                 | 15 A        | Engine control system                            |
| 38          | ENG INJ2* <sup>1</sup>  | 15 A        | Engine control system                            |
|             | ENG BAR 2* <sup>2</sup> | 20 A        | Engine control system                            |
| 39          | EHPAS IG* <sup>1</sup>  | —           | —  |
|             | ETV* <sup>2</sup>       | 15 A        | Engine control system                            |

\*1 SKYACTIV-G 2.0

\*2 MZR 2.0, MZR 2.3 DISI Turbo and MZR 2.5



Maintenance and Care  
**Owner Maintenance**

**Fuse block (Left side)**

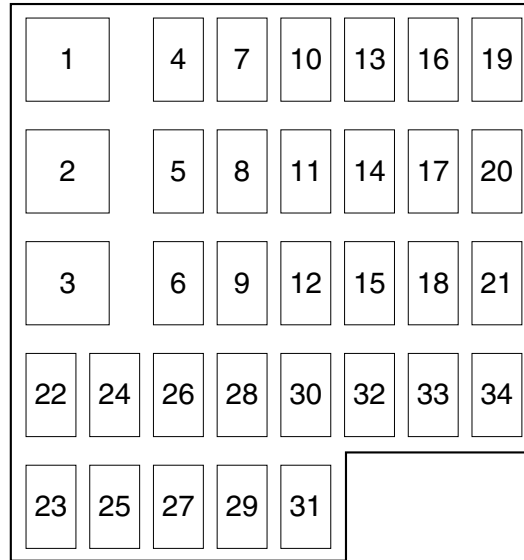

|    | DESCRIPTION | FUSE RATING | PROTECTED COMPONENT                         |
|----|-------------|-------------|---|
| 1  | BOSE        | —           | —   |
| 2  | P SEAT      | 30 A        | Power seat*                                 |
| 3  | P.WIND      | 30 A        | Power window                                |
| 4  | D.LOCK      | 25 A        | Power door lock                             |
| 5  | —           | —           | —   |
| 6  | —           | —           | —   |
| 7  | ESCL        | —           | —   |
| 8  | SAS         | 15 A        | Air bag                                     |
| 9  | —           | —           | —   |
| 10 | HAZARD      | 15 A        | Hazard warning flashers, Turn signal lights |
| 11 | METER       | 15 A        | Instrument cluster                          |
| 12 | OUTLET      | 15 A        | Accessory sockets                           |
| 13 | R.WIPER     | 15 A        | Rear window wiper and washer*               |
| 14 | CIGAR       | 15 A        | Accessory sockets                           |
| 15 | ROOM2       | —           | —   |
| 16 | HEATER      | 10 A        | Air conditioner                             |
| 17 | MIRROR      | 10 A        | Power control mirror                        |
| 18 | ST SIG      | 10 A        | Engine control system                       |
| 19 | —           | —           | —   |

\*Some models. **8-63**

Maintenance and Care

## Owner Maintenance

| DESCRIPTION |         | FUSE RATING | PROTECTED COMPONENT                 |
|-------------|---------|-------------|-------------------------------------|
| 20          | AUDIO   | 7.5 A       | Audio system                        |
| 21          | M.DEF   | 7.5 A       | Mirror defroster *                  |
| 22          | AFS     | 7.5 A       | Adaptive Front-Lighting System *    |
| 23          | —       | —           | —                                   |
| 24          | ENG     | 20 A        | Engine control system               |
| 25          | —       | —           | —                                   |
| 26          | METER2  | —           | —                                   |
| 27          | —       | —           | —                                   |
| 28          | AUDIO2  | —           | —                                   |
| 29          | —       | —           | —                                   |
| 30          | P.WIND  | 25 A        | Power window                        |
| 31          | —       | —           | —                                   |
| 32          | F.WIPER | 25 A        | Front window wiper and washer       |
| 33          | BOSE 2  | 25 A        | Bose® Sound System-equipped model * |
| 34          | —       | —           | —                                   |

**8-64** \*Some models.

## Appearance Care

### How to Minimize Environmental Paint Damage

The paintwork on your Mazda represents the latest technical developments in composition and methods of application.

Environmental hazards, however, can harm the paint's protective properties, if proper care is not taken.

Here are some examples of possible damage, with tips on how to prevent them.

#### ▼ Etching Caused by Acid Rain or Industrial Fallout

##### Occurrence

Industrial pollutants and vehicle emissions drift into the air and mix with rain or dew to form acids. These acids can settle on a vehicle's finish. As the water evaporates, the acid becomes concentrated and can damage the finish.

And the longer the acid remains on the surface, the greater the chance is for damage.

##### Prevention

It is necessary to wash and wax your vehicle to preserve its finish according to the instructions in this section. These steps should be taken immediately after you suspect that acid rain has settled on your vehicle's finish.

#### ▼ Damage Caused by Bird Dropping, Insects, or Tree Sap

##### Occurrence

Bird droppings contain acids. If these aren't removed they can eat away the clear and color base coat of the vehicle's paintwork.

When insects stick to the paint surface and decompose, corrosive compounds form. These can erode the clear and color base coat of the vehicle's paintwork if they are not removed.

Tree sap will harden and adhere permanently to the paint finish. If you scratch the sap off while it is hard, some vehicle paint could come off with it.

##### Prevention

It is necessary to have your Mazda washed and waxed to preserve its finish according to the instructions in this section. This should be done as soon as possible.

Bird droppings can be removed with a soft sponge and water. If you are traveling and these are not available, a moistened tissue may also take care of the problem. The cleaned area should be waxed according to the instructions in this section.

Insects and tree sap are best removed with a soft sponge and water or a commercially available chemical cleaner.

Another method is to cover the affected area with dampened newspaper for one to two hours. After removing the newspaper, rinse off the loosened debris with water.

Maintenance and Care

## Appearance Care

---

### ▼ Water Marks

#### Occurrence

Rain, fog, dew, and even tap water can contain harmful minerals such as salt and lime. If moisture containing these minerals settles on the vehicle and evaporates, the minerals will concentrate and harden to form white rings. The rings can damage your vehicle's finish.

#### Prevention

It is necessary to wash and wax your vehicle to preserve its finish according to the instructions in this section. These steps should be taken immediately after you find water marks on your vehicle's finish.

### ▼ Paint Chipping

#### Occurrence

Paint chipping occurs when gravel thrown in the air by another vehicle's tires hits your vehicle.

#### How to avoid paint chipping

Keeping a safe distance between you and the vehicle ahead reduces the chances of having your paint chipped by flying gravel.

#### **NOTE**

- *The paint chipping zone varies with the speed of the vehicle. For example, when traveling at 90 km/h (56 mph), the paint chipping zone is 50 m (164 ft).*
- *In low temperatures a vehicle's finish hardens. This increases the chance of paint chipping.*
- *Chipped paint can lead to rust forming on your Mazda. Before this happens, repair the damage by using Mazda touch-up paint according to the instructions in this section. Failure to repair the affected area could lead to serious rusting and expensive repairs.*

## Appearance Care

### Exterior Care

Follow **all** label and container directions when using a chemical cleaner or polish. Read all warnings and cautions.

#### ▼ Maintaining the Finish

##### Washing

#### CAUTION

- *When the wiper lever is in the AUTO position and the ignition is switched ON, the wipers may move automatically in the following cases:*
  - *If the windshield above the rain sensor is touched or wiped with a cloth.*
  - *If the windshield is struck with a hand or other object from either outside or inside the vehicle.*

*Keep hands and scrapers clear of the windshield when the wiper lever is in the AUTO position and the ignition is switched ON as fingers could be pinched or the wipers and wiper blades damaged when the wipers activate automatically.*

*If you are going to clean the windshield, be sure the wipers are turned off completely—this is particularly important when clearing ice and snow—when it is most likely that the engine is left running.*

- *Do not spray water in the engine compartment. Otherwise, it could result in engine-starting problems or damage to electrical parts.*

To help protect the finish from rust and deterioration, wash your Mazda thoroughly and frequently, at least once a month, with lukewarm or cold water.

If the vehicle is washed improperly, the paint surface could be scratched. Here are some examples of how scratching could occur.

Scratches occur on the paint surface when:

- The vehicle is washed without first rinsing off dirt and other foreign matter.
- The vehicle is washed with a rough, dry, or dirty cloth.
- The vehicle is washed at a car wash that uses brushes that are dirty or too stiff.
- Cleansers or wax containing abrasives are used.

#### **NOTE**

- *Mazda is not responsible for scratches caused by automatic car washes or improper washing.*
- *Scratches are more noticeable on vehicles with darker paint finishes.*

To minimize scratches on the vehicle's paint finish:

- Rinse off any dirt or other foreign matter using lukewarm or cold water before washing.
- Use plenty of lukewarm or cold water and a soft cloth when washing the vehicle. Do not use a nylon cloth.
- Rub gently when washing or drying the vehicle.
- Take your vehicle only to a car wash that keeps its brushes well maintained.
- Do not use abrasive cleansers or wax that contain abrasives.

Maintenance and Care

## Appearance Care

### CAUTION

*Do not use steel wool, abrasive cleaners, or strong detergents containing highly alkaline or caustic agents on chrome-plated or anodized aluminum parts. This may damage the protective coating; also, cleaners and detergents may discolor or deteriorate the paint.*

Pay special attention to removing salt, dirt, mud, and other foreign material from the underside of the fenders, and make sure the drain holes in the lower edges of the doors and rocker panels are clean.

Insects, tar, tree sap, bird droppings, industrial fallout, and similar deposits can damage the finish if not removed immediately. When prompt washing with plain water is ineffective, use a mild soap made for use on vehicles.

Thoroughly rinse off all soap with lukewarm or cold water. Do not allow soap to dry on the finish.

After washing the vehicle, dry it with a clean chamois to prevent water spots from forming.

### WARNING

***Dry off brakes that have become wet by driving slowly, releasing the accelerator pedal and lightly applying the brakes several times until the brake performance returns to normal:***

*Driving with wet brakes is dangerous. Increased stopping distance or the vehicle pulling to one side when braking could result in a serious accident. Light braking will indicate whether the brakes have been affected.*

#### **When using a high water pressure car wash**

High water temperature and high water pressure car washers are available depending on the type of car wash machine. If the car washer nozzle is put too close to the vehicle, the force of the spray could damage or deform the molding, affect the sealability of parts, and allow water to penetrate the interior. Keep a sufficient space (30 cm or more) between the nozzle and the vehicle. In addition, do not spend too much time spraying the same area of the vehicle, and be very careful when spraying between gaps in doors and around windows.

#### **Waxing**

Your vehicle needs to be waxed when water no longer beads on the finish. Always wash and dry the vehicle before waxing it. In addition to the vehicle body, wax the metal trim to maintain its luster.

1. Use wax which contains no abrasives. Waxes containing abrasive will remove paint and could damage bright metal parts.

## Appearance Care

2. Use a good grade of natural wax for metallic, mica, and solid colors.
3. When waxing, coat evenly with the sponge supplied or a soft cloth.
4. Wipe off the wax with a soft cloth.

### NOTE

*A spot remover to remove oil, tar, and similar materials will usually also take off the wax. Rewax these areas even if the rest of the vehicle does not need it.*

### ▼ Repairing Damage to the Finish

Deep scratches or chips on the finish should be repaired promptly. Exposed metal quickly rusts and can lead to major repairs.

### ⚠ CAUTION

*If your Mazda is damaged and needs metal parts repaired or replaced, make sure the body shop applies anti-corrosion materials to all parts, both repaired and new. This will prevent them from rusting.*

### ▼ Bright-Metal Maintenance

- Use tar remover to remove road tar and insects. Never do this with a knife or similar tool.
- To prevent corrosion on bright-metal surfaces, apply wax or chrome preservative and rub it to a high luster.
- During cold weather or in coastal areas, cover bright-metal parts with a coating of wax or preservative heavier than usual. It would also help to coat them with noncorrosive petroleum jelly or some other protective compound.

### ⚠ CAUTION

*Don't use steel wool, abrasive cleaners, or strong detergents containing highly alkaline or caustic agents on chrome-plated or anodized aluminum parts. This may result in damage to the protective coating and cause discoloration or paint deterioration.*

### ▼ Underbody Maintenance

Road chemicals and salt used for ice and snow removal and solvents used for dust control may collect on the underbody. If not removed, they will speed up rusting and deterioration of such underbody parts as fuel lines, frame, floor pan, and exhaust system, even though these parts may be coated with anti-corrosive material.

Thoroughly flush the underbody and wheel housings with lukewarm or cold water at the end of each winter. Try also to do this every month.

Pay special attention to these areas because they easily hide mud and dirt. **It will do more harm than good to wet down the road grime without removing it.**

The lower edges of doors, rocker panels, and frame members have drain holes that should not be clogged. Water trapped there will cause rusting.

Maintenance and Care

## Appearance Care

### **WARNING**

**Dry wet brakes by driving very slowly and applying the brakes lightly until brake performance is normal:**

*Driving with wet brakes is dangerous. Increased stopping distance or the vehicle pulling to one side when braking could result in a serious accident. Light braking will indicate whether the brakes have been affected.*

### **Aluminum Wheel Maintenance\***

A protective coating is provided over the aluminum wheels. Special care is needed to protect this coating.

### **CAUTION**

*Do not use any detergent other than mild detergent. Before using any detergent, verify the ingredients. Otherwise, the product could discolor or stain the aluminum wheels.*

### **NOTE**

- *Do not use a wire brush or any abrasive cleaner, polishing compound, or solvent on aluminum wheels. They may damage the coating.*
- *Always use a sponge or soft cloth to clean the wheels.*  
*Rinse the wheels thoroughly with lukewarm or cold water. Also, be sure to clean the wheels after driving on dusty or salted roads to help prevent corrosion.*
- *Avoid washing your vehicle in an automatic car wash that uses high-speed or hard brushes.*
- *If your aluminum wheels lose luster, wax the wheels.*

### **(With Tire Pressure Monitoring System)**

*Check special requirements for Tire Pressure Monitoring System.*

*Refer to Tires and Wheels on page 5-35.*

### **Plastic Part Maintenance**

- *When cleaning the plastic lenses of the lights, do not use gasoline, kerosene, rectified spirit, paint, thinner, highly acidic detergents, or strongly alkaline detergents. Otherwise, these chemical agents can discolor or damage the surfaces resulting in a significant loss in functionality. If plastic parts become inadvertently exposed to any of these chemical agents, flush with water immediately.*
- *If plastic parts such as the bumpers become inadvertently exposed to chemical agents or fluids such as gasoline, oil, engine coolant, or battery fluid, it could cause discoloration, staining, or paint peeling. Wipe off any such chemical agents or fluids using a soft cloth immediately.*



## Appearance Care

- High water temperature and high water pressure car washers are available depending on the type of high pressure car washer device. If the car washer nozzle is put too close to the vehicle or aimed at one area for an extended period of time, it could deform plastic parts or damage the paint.
- Do not use wax containing compounds (polish). Otherwise, it could result in paint damage.
- In addition, do not use an electrical or air tool to apply wax. Otherwise, the frictional heat generated could result in deformation of plastic parts or paint damage.

### Interior Care

#### **WARNING**

***Do not spray water in the cabin:***

*Splashing water on electrical parts such as the audio unit and switches is dangerous as it could cause a malfunction or a fire.*

#### **Dashboard Precautions**

Prevent caustic solutions such as perfume and cosmetic oils from contacting the dashboard. They'll damage and discolor the dashboard. If these solutions get on the dashboard, wipe them off immediately.

#### **CAUTION**

*Do not use glazing agents. Glazing agents contain ingredients which may cause discoloration, wrinkling, cracks and peeling.*

#### **Front passenger's side instrument panel top (soft pad)**

- Extremely soft material is used for the soft pad surface. When cleaning, it is recommended that you use a clean towel dampened in a mild detergent to remove soiling.
- If the soft pad surface is rubbed harshly, it could result in the surface being damaged leaving white scratch marks.

Maintenance and Care

## Appearance Care

---

### ▼ Cleaning the Upholstery and Interior Trim

#### Vinyl

Remove dust and loose dirt from vinyl with a whisk broom or vacuum cleaner. Clean vinyl with a leather-and-vinyl cleaner.

#### Leather\*

Remove dust and sand first using a vacuum cleaner or other means, then wipe dirt off using a soft cloth with a leather cleaner or a soft cloth soaked in mild soap.

Wipe off the remaining cleaner or soap using a cloth soaked in clean water and wrung out well.

Remove moisture with a dry, soft cloth and allow the leather to further dry in a well-ventilated, shaded area. If the leather gets wet such as from rain, also remove moisture and dry it as soon as possible.

#### **NOTE**

- *Because genuine leather is a natural material, its surface is not uniform and it may have natural scars, scratches, and wrinkles.*
- *To maintain the quality for as long as possible, periodical maintenance, about twice a year, is recommended.*
- *Sand and dust on the seat surface may damage the overcoat of the genuine leather surfaces and accelerate wear.*
- *Greasy soiling on genuine leather may cause molding and stains.*
- *Rubbing hard with a stiff brush or cloth may cause damage.*
- *Do not wipe the leather using alcohol, chlorine bleach, or organic solvents such as thinner, benzene, or gasoline. Otherwise, it may cause discoloration or stains.*
- *If the seats get wet, promptly remove moisture with a dry cloth. Remaining moisture on the surface may cause deterioration such as hardening and shrinkage.*
- *Exposure to direct sunlight for long periods may cause deterioration and shrinkage. When parking the car under direct sunlight for long periods, shade the interior using sunshades.*
- *Do not leave vinyl products on the seats for long periods as they may affect the leather quality and coloring. If the cabin temperature becomes hot, the vinyl may deteriorate and adhere to the genuine leather.*

#### **Fabric**

Remove dust and loose dirt from fabric with a whisk broom or vacuum cleaner. Clean it with a mild soap solution good for upholstery and carpets. Remove fresh spots immediately with a fabric spot cleaner.

## Appearance Care

To keep the fabric looking clean and fresh, take care of it. Otherwise its color will be affected, it can be stained easily, and its fire-resistance may be reduced.

### **CAUTION**

*Use only recommended cleaners and procedures. Others may affect appearance and fire-resistance.*

#### **Piano black panel\***

The following parts are fitted with panels that have been treated with a special coating that resists scratching.

· Shift lever panel

When the panel needs to be cleaned, use a soft cloth to wipe off dirt from the surface.

#### **NOTE**

*Scratches or nicks on the panels resulting from the use of a hard brush or cloth may not be repairable.*

#### **Multi information display edge panel\* Panel beside the multi information display\***

Multi information display edge panel and panel beside the multi information display are fitted with panels that have been treated with a special coating that resists scratching.

When the panel needs to be cleaned, use a soft cloth to wipe off dirt from the surface.

#### **NOTE**

*Scratches or nicks on the panels resulting from the use of a hard brush or cloth may not be repairable.*

#### **▼ Cleaning the Lap/Shoulder Belt Webbing**

Clean the webbing with a mild soap solution recommended for upholstery or carpets. Follow instructions. Don't bleach or dye the webbing; this may weaken it.

After cleaning the belts, thoroughly dry the belt webbing and make sure there is no remaining moisture before retracting them.

### **WARNING**

***Have an Authorized Mazda Dealer replace damaged seat belts immediately:***

*Using damaged seat belts is dangerous. In a collision, damaged belts cannot provide adequate protection.*

#### **▼ Cleaning the Window Interiors**

If the windows become covered with an oily, greasy, or waxy film, clean them with glass cleaner. Follow the directions on the container.

### **CAUTION**

- *Do not scrape or scratch the inside of the window glass. It could damage the thermal filaments and the antenna lines.*
- *When washing the inside of the window glass, use a soft cloth dampened in lukewarm water, gently wiping the thermal filaments and the antenna lines. Use of glass cleaning products could damage the thermal filaments and the antenna lines.*

Maintenance and Care

## Appearance Care

---

### ▼ Cleaning the Floor Mats

Rubber floor mats should be cleaned with mild soap and water only.

#### **WARNING**

***Do not use rubber cleaners, such as tire cleaner or tire shine, when cleaning rubber floor mats:***

*Cleaning the rubber floor mats with rubber cleaning products makes the floor mats slippery.*

*This may cause an accident when depressing the accelerator, brake, or clutch (Manual transaxle) pedal or when getting in or out of the vehicle.*

After removing the floor mats for cleaning, always reinstall them securely. Refer to Floor Mat on page 4-8.

# 9

## Customer Information

Important consumer information including warranties and add-on equipment.

|   |             |   |             |
|---|-------------|---|-------------|
| <b>Customer Assistance</b> .....  | <b>9-2</b>  | <b>Tire Information (U.S.A.)</b> .....                | <b>9-24</b> |
| Customer Assistance (U.S.A.) .....  | 9-2         | Tire Labeling .....                                   | 9-24        |
| Customer Assistance (Canada) .....  | 9-7         | Location of the Tire Label<br>(Placard) .....         | 9-30        |
| Customer Assistance (Puerto Rico) ...   | 9-10        | Tire Maintenance .....                                | 9-33        |
| Customer Assistance (Mexico) .....  | 9-11        | Vehicle Loading .....                                 | 9-36        |
| <b>Mazda Importer/Distributors</b> .....  | <b>9-13</b> | Steps for Determining the Correct Load<br>Limit ..... | 9-42        |
| Importer/Distributor .....  | 9-13        | <b>Reporting Safety Defects</b> .....                 | <b>9-43</b> |
| Distributor in Each Area .....  | 9-13        | Reporting Safety Defects (U.S.A.) ....                | 9-43        |
| <b>Warranty</b> .....   | <b>9-15</b> | Reporting Safety Defects (Canada) ...                 | 9-44        |
| Warranties for Your Mazda .....   | 9-15        | <b>Service Publications</b> .....                     | <b>9-45</b> |
| Outside the United States .....   | 9-16        | Service Publications .....                            | 9-45        |
| Outside Canada .....  | 9-17        |   |             |
| Registering Your Vehicle in A Foreign<br>Country (Except United States and<br>Canada) ..... | 9-18        |   |             |
| Add-On Non-Genuine Parts and<br>Accessories .....   | 9-19        |   |             |
| <b>Cell Phones</b> .....  | <b>9-20</b> |   |             |
| Cell Phones Warning .....   | 9-20        |   |             |
| <b>Event Data Recorder</b> .....  | <b>9-21</b> |   |             |
| Event Data Recorder .....   | 9-21        |   |             |
| <b>Uniform Tire Quality Grading System<br/>(UTQGS)</b> .....                                | <b>9-22</b> |   |             |
| Uniform Tire Quality Grading System<br>(UTQGS) .....  | 9-22        |   |             |

Customer Information

## Customer Assistance

### Customer Assistance (U.S.A.)

Your complete and permanent satisfaction is our business. We are here to serve you. All Authorized Mazda Dealers have the knowledge and the tools to keep your Mazda vehicle in top condition.

If you have any questions or recommendations for improvement regarding the service of your Mazda vehicle or servicing by Mazda Dealer personnel, we recommend that you take the following steps:

**NOTE**

*If it becomes necessary to have the components or wiring system for the supplementary restraint system modified to accommodate a person with certain medical conditions in accordance with a certified physician, contact an Authorized Mazda Dealer.*

#### ▼STEP 1: Contact Your Mazda Dealer

Discuss the matter with an Authorized Mazda Dealer. This is the quickest and best way to address the issue.

- If your concern has not been resolved by the CUSTOMER RELATIONS, SALES, SERVICE, or PARTS MANAGER, then please contact the GENERAL MANAGER of the dealership or the OWNER.
- If it becomes necessary to have the components or wiring system for the supplementary restraint system modified to accommodate a person with certain medical conditions in accordance with a certified physician, go to STEP 2.

#### ▼STEP 2: Contact Mazda North American Operations

If for any reason you feel the need for further assistance after contacting your dealership management or it becomes necessary to have the components or wiring system for the supplementary restraint system modified to accommodate a person with certain medical conditions in accordance with a certified physician, you can reach Mazda North American Operations by one of the following ways.

Log on: at [www.mazdaUSA.com](http://www.mazdaUSA.com)

Answers to many questions, including how to locate or contact a local Mazda dealership in the U.S., can be found here.

E-mail: click on “Contact Us” located on the “Inside Mazda” tab, or at the bottom of the page at [www.mazdaUSA.com](http://www.mazdaUSA.com)

By phone at: 1 (800) 222-5500

Customer Information  
**Customer Assistance**

---

By letter at:

Attn: Customer Assistance  
Mazda North American Operations  
7755 Irvine Center Drive  
Irvine, CA 92618-2922  
P.O. Box 19734  
Irvine, CA 92623-9734

In order to serve you efficiently and effectively, please help us by providing the following information:

1. Your name, address, and telephone number
2. Year and model of vehicle
3. Vehicle Identification Number (17 digits, noted on your registration or title or located on the upper driver's side corner of the dash)
4. Purchase date and current mileage
5. Your dealer's name and location
6. Your question(s)

If you live outside the U.S.A., please contact your nearest Mazda Distributor.

**▼STEP 3: Contact Better Business Bureau (BBB)**

Mazda North American Operations realizes that mutual agreement on some issues may not be possible. As a final step to ensure that your concerns are being fairly considered, Mazda North American Operations has agreed to participate in a dispute settlement program administered by the Better Business Bureau (BBB) system, at no cost to you the consumer.

BBB AUTO LINE works with consumers and the manufacturer in an attempt to reach a mutually acceptable resolution of any warranty related concerns. If the BBB is not able to facilitate a settlement they will provide an informal hearing before an arbitrator.

You are required to resort to BBB AUTO LINE before exercising rights or seeking remedies under the Federal Magnuson-Moss Warranty Act, 15 U.S.C. § 2301 et seq. To the extent permitted by the applicable state "Lemon Law", you are also required to resort to BBB AUTO LINE before exercising any rights or seeking remedies under the "Lemon Law". If you choose to seek remedies that are not created by the Magnuson-Moss Warranty Act or the applicable state "Lemon Law", you are not required to first use BBB AUTO LINE.

Customer Information

## Customer Assistance

---

The whole process normally takes 40 days or less. The arbitration decision is not binding on you or Mazda unless you accept the decision. For more information about BBB AUTO LINE, including current eligibility standards, please call 1-800-955-5100 or visit the BBB website at [www.lemonlaw.bbb.org](http://www.lemonlaw.bbb.org).

Being truly committed to customer satisfaction is more than a phrase with Mazda. We hope to satisfy every customer directly, but if there is ever a question about our decision, Mazda believes in providing a fast, fair and free method such as the BBB AUTO LINE to ensure Mazda delivers on our commitment to do the right thing for our customers!

### ▼ California Customers

1. Mazda North American Operations participates in BBB AUTO LINE, a mediation/arbitration program administered by the Council of Better Business Bureaus [4200 Wilson Boulevard, Arlington, Virginia 22203] through local Better Business Bureaus. BBB AUTO LINE and Mazda have been certified by the Arbitration Certification Program of the California Department of Consumer Affairs.
2. If you have a problem arising under a Mazda written warranty, we encourage you to bring it to our attention. If we are unable to resolve it, you may file a claim with BBB AUTO LINE. Claims must be filed with BBB AUTO LINE within six (6) months after the expiration of the warranty.
3. To file a claim with BBB AUTO LINE, call 1-800-955-5100. There is no charge for the call.
4. In order to file a claim with BBB AUTO LINE, you will have to provide your name and address, the brand name and vehicle identification number (VIN) of your vehicle, and a statement of the nature of your problem or complaint. You will also be asked to provide: the approximate date of your acquisition of the vehicle, the vehicle's current mileage, the approximate date and mileage at the time any problem(s) were first brought to the attention of Mazda or one of our dealers, and a statement of the relief you are seeking.
5. BBB AUTO LINE staff may try to help resolve your dispute through mediation. If mediation is not successful, or if you do not wish to participate in mediation, claims within the program's jurisdiction may be presented to an arbitrator at an informal hearing. The arbitrator's decision should ordinarily be issued within 40 days from the time your complaint is filed; there may be a delay of 7 days if you did not first contact Mazda about your problem, or a delay of up to 30 days if the arbitrator requests an inspection/report by an impartial technical expert or further investigation and report by BBB AUTO LINE.



Customer Information  
**Customer Assistance**

---

6. You are required to use BBB AUTO LINE before asserting in court any rights or remedies conferred by California Civil Code Section 1793.22. You are also required to use BBB AUTO LINE before exercising rights or seeking remedies created by Title I of the Magnuson-Moss Warranty Act, 15 U.S.C. sec. 2301 et seq. If you choose to seek redress by pursuing rights and remedies not created by California Civil Code Section 1793.22 or Title I of the Magnuson-Moss Warranty Act, resort to BBB AUTO LINE is not required by those statutes.
7. California Civil Code Section 1793.2 (d) requires that, if Mazda or its representative is unable to repair a new motor vehicle to conform to the vehicle's applicable express warranty after a reasonable number of attempts, Mazda may be required to replace or repurchase the vehicle. California Civil Code Section 1793.22 (b) creates a presumption that Mazda has had a reasonable number of attempts to conform the vehicle to its applicable express warranties if, within 18 months from delivery to the buyer or 18,000 miles on the vehicle's odometer, whichever occurs first, one or more of the following occurs:
  - The same nonconformity [a failure to conform to the written warranty that substantially impairs the use, value or safety of the vehicle] results in a condition that is likely to cause death or serious bodily injury if the vehicle is driven **AND** the nonconformity has been subject to repair two or more times by Mazda or its agents **AND** the buyer or lessee has directly notified Mazda of the need for the repair of the nonconformity; OR
  - The same nonconformity has been subject to repair 4 or more times by Mazda or its agents **AND** the buyer has notified Mazda of the need for the repair of the nonconformity; OR
  - The vehicle is out of service by reason of repair of nonconformities by Mazda or its agents for a cumulative total of more than 30 calendar days after delivery of the vehicle to the buyer.

**NOTICE TO Mazda AS REQUIRED ABOVE SHALL BE SENT TO THE FOLLOWING ADDRESS:**

Mazda North American Operations  
7755 Irvine Center Drive  
Irvine, CA 92618  
ATTN: Customer Mediation

8. The following remedies may be sought in BBB AUTO LINE: repairs, reimbursement for money paid to repair a vehicle or other expenses incurred as result of a vehicle nonconformity, repurchase or replacement of your vehicle, and compensation for damages and remedies available under Mazda's written warranty or applicable law.
9. The following remedies may **not** be sought in BBB AUTO LINE: punitive or multiple damages, attorneys' fees, or consequential damages other than as provided in California Civil Code Section 1794 (a) and (b).



Customer Information

## Customer Assistance

---

10. You may reject the decision issued by a BBB AUTO LINE arbitrator. If you reject the decision, you will be free to pursue further legal action. The arbitrator's decision and any findings will be admissible in a court action.
11. If you accept the arbitrator's decision, Mazda will be bound by the decision, and will comply with the decision within a reasonable time not to exceed 30 days after we receive notice of your acceptance of the decision.
12. Please call BBB AUTO LINE at 1-800-955-5100 for further details about the program.

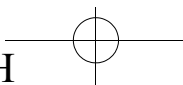

Customer Information  
**Customer Assistance**

## Customer Assistance (Canada)

### ▼ Satisfaction Review Process

Your complete and permanent satisfaction is of primary concern to Mazda. All Authorized Mazda Dealers have both the knowledge and tools to keep your Mazda in top condition. In our experience, any questions, problems, or complaints regarding the operation of your Mazda or any other general service transactions are most effectively resolved by your dealer. If the cause of your dissatisfaction cannot adequately be addressed by normal dealership procedures, we recommend that you take the following steps:

### ▼ STEP 1: Contact the Mazda Dealer

Discuss the matter with a member of dealership management. If the Service Manager has already reviewed your concerns, contact the owner of the dealership or its General Manager.

### ▼ STEP 2: Contact the Mazda Regional Office

If you feel that you still require assistance, ask the dealer Service Manager to arrange for you to meet the local Mazda Service Representative. If more expedient, contact Mazda Canada Inc. Regional Office nearest you for such arrangements. Regional Office address and phone numbers are shown (page 9-9).

### ▼ STEP 3: Contact the Mazda Customer Relations Department

If still not substantially satisfied, contact the Customer Relations Department, Mazda Canada Inc., 55 Vogell Road, Richmond Hill, Ontario, L4B 3K5 Canada TEL: 1 (800) 263-4680.

Provide the Department with the following information:

1. Your name, address and telephone number
2. Year and model of vehicle
3. Vehicle Identification Number (VIN). Refer to the "Vehicle Identification Labels" page of section 10 of this manual for the location of the VIN.
4. Purchase date
5. Present odometer reading
6. Your dealer's name and location
7. The nature of your problem and/or cause of dissatisfaction

The Department, in cooperation with the local Mazda Service Representative, will review the case to determine if everything possible has been done to ensure your satisfaction.

Customer Information

## Customer Assistance

---

Please recognize that the resolution of service problems in most cases requires the use of your Mazda dealer's service facilities, personnel and equipment. We urge you to follow the above three steps in sequence for most effective results.

### ▼ Mediation/Arbitration Program

Occasionally a customer concern cannot be resolved through Mazda's Customer Satisfaction Program. If after exhausting the procedures in this manual your concern is still not resolved, you have another option.

Mazda Canada Inc. participates in an arbitration program administered by the Canadian Motor Vehicle Arbitration Plan (CAMVAP). CAMVAP will advise you about how your concern may be reviewed and resolved by an independent third party through binding arbitration.

Your complete satisfaction is the goal of Mazda Canada Inc. and our dealers. Mazda's participation in CAMVAP makes a valuable contribution to our achieving that goal. There is no charge for using CAMVAP. CAMVAP results are fast, fair and final as the award is binding on both you and Mazda Canada Inc.

### ▼ Canadian Motor Vehicle Arbitration Plan (CAMVAP)

If a specific item of concern arises, where a solution cannot be reached between an owner, Mazda, and/or one of its dealers (that all parties cannot agree upon), the owner may wish to use the services offered by the Canadian Motor Vehicle Arbitration Plan (CAMVAP).

CAMVAP uses the services of Provincial Administrators to assist consumers in scheduling and preparing for their arbitration hearings. However, before you can proceed with CAMVAP you must follow your Mazda dispute resolution process as outlined previously.

Customer Information  
**Customer Assistance**

CAMVAP is fully implemented in all provinces and territories. Consumers wishing to obtain further information about the Program should contact the Provincial Administrator at 1 (800) 207-0685, or by contacting the Canadian Motor Vehicle Arbitration Plan Office at:

Canadian Motor Vehicle Arbitration Plan  
 235 Yorkland Boulevard, suite 300  
 North York, Ontario  
 M2J 4Y8  
<http://camvap.ca>

Provincial Administrators may be reached locally as listed below:

| Province/Territory                   | CAMVAP Number    |
|--------------------------------------|------------------|
| British Columbia & Yukon Territories | 1 (800) 207-0685 |
| Alberta & Northwest Territories      | 1 (800) 207-0685 |
| Saskatchewan                         | 1 (800) 207-0685 |
| Manitoba                             | 1 (800) 207-0685 |
| Ontario                              | 1 (800) 207-0685 |
| Atlantic Canada                      | 1 (800) 207-0685 |
| Quebec                               | 1 (800) 207-0685 |

**▼ Regional Offices**

| REGIONAL OFFICES   | AREAS COVERED  |
|--|--|
| MAZDA CANADA INC.<br>WESTERN REGION<br>8171 ACKROYD ROAD<br>SUITE 2000<br>RICHMOND B.C.<br>V6X 3K1<br>(604) 303-5670       | ALBERTA,<br>BRITISH COLUMBIA,<br>MANITOBA,<br>SASKATCHEWAN,<br>YUKON               |
| MAZDA CANADA INC.<br>CENTRAL/ATLANTIC REGION<br>55 VOGELL ROAD,<br>RICHMOND HILL,<br>ONTARIO, L4B 3K5<br>(905) 787-7000    | ONTARIO  |
| MAZDA CANADA INC.<br>QUEBEC REGION<br>6111 ROUTE TRANS<br>CANADIENNE<br>POINTE CLAIRE, QUEBEC<br>H9R 5A5<br>(514) 694-6390 | QUEBEC,<br>NEW BRUNSWICK,<br>NOVA SCOTIA,<br>PRINCE EDWARD ISLAND,<br>NEWFOUNDLAND |

Customer Information

## Customer Assistance

---

### Customer Assistance (Puerto Rico)

Your complete and permanent satisfaction is our business. That is why all Authorized Mazda Dealers have the knowledge and the tools to keep your Mazda vehicle in top condition.

If you have any questions or recommendations for improvement regarding the service of your Mazda vehicle or servicing by Mazda Dealer personnel, we recommend that you take the following steps:

#### ▼STEP 1

Discuss the matter with an Authorized Mazda Dealer. This is the quickest and best way to address the issue. If your concern has not been resolved by the CUSTOMER RELATIONS, SALES, SERVICE, or PARTS MANAGER, then please contact the GENERAL MANAGER of the dealership or the OWNER.

#### ▼STEP 2

If, after following STEP 1, you feel the need for further assistance, please contact your area's Mazda representative (Indicated on the next page).

Please help us by providing the following information:

1. Your name, address, and telephone number
2. Year and model of vehicle
3. Vehicle Identification Number (17 digits, noted on your registration or title or located on the upper driver's side corner of the dash)
4. Purchase date and current mileage
5. Your dealer's name and location
6. Your question(s)

9-10

## Customer Assistance

### Customer Assistance (Mexico)

Your complete and permanent satisfaction is our business. We are here to serve you. All Authorized Mazda Dealers have the knowledge and the tools to keep your Mazda vehicle in top condition.

If you have any questions or recommendations for improvement regarding the service of your Mazda vehicle or servicing by Mazda Dealer personnel, we recommend that you take the following steps:

#### ▼ Contact Your Mazda Dealer

Discuss the matter with an Authorized Mazda Dealer. This is the quickest and best way to address the issue.

- If your concern has not been resolved by the CUSTOMER RELATIONS, SALES, SERVICE, or PARTS MANAGER, then please contact the GENERAL MANAGER of the dealership or the OWNER.
- If it becomes necessary to have the components or wiring system for the supplementary restraint system modified to accommodate a person with certain medical condition in accordance with a certified physician you must contact your dealership in order to avoid the potential loss of the warranty of your vehicle which may occur if some third party is hired by the customer to make any modifications to this system.

Log on: at [www.MazdaMexico.com.mx](http://www.MazdaMexico.com.mx)

Answers to many questions, including how to locate or contact a local Mazda dealership in Mexico, can be found here.

E-mail: click on “Contactanos” at the top of the page at [www.MazdaMexico.com.mx](http://www.MazdaMexico.com.mx)

By phone at: 01 800 01 MAZDA (62932)

By letter at:

Attn: Customer Assistance  
Mazda Motor de Mexico  
Mario Pani #150, PB Col. Lomas de Santa Fe  
Mexico, D.F. C.P. 05300  
Del. Cuajimalpa de Morelos  
Tel: Customer Assistance  
01 800 01 MAZDA (62932).

In order to serve you efficiently and effectively, please help us by providing the following information:

1. Your name, address, and telephone number

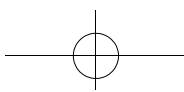

**Customer Information**

## **Customer Assistance**

---

2. Year and model of vehicle
3. Vehicle Identification Number (17 digits, noted on your registration or title or located on the upper driver's side corner of the dash)
4. Purchase date and current mileage
5. Your dealer's name and location
6. Your question(s)

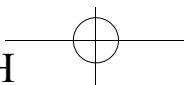



## Mazda Importer/Distributors

### Importer/Distributor

#### ▼ U.S.A.

##### **Mazda North American Operations**

7755 Irvine Center Drive  
Irvine, CA 92618-2922 U.S.A.  
P.O. Box 19734  
Irvine, CA 92623-9734 U.S.A.  
TEL: 1 (800) 222-5500 (in U.S.A.)  
(949) 727-1990 (outside U.S.A.)

### Distributor in Each Area

#### ▼ CANADA

##### **Mazda Canada Inc.**

55 Vogell Road, Richmond Hill,  
Ontario, L4B 3K5 Canada  
TEL: 1 (800) 263-4680 (in Canada)  
(905) 787-7000 (outside Canada)

#### ▼ PUERTO RICO/U.S. Virgin Island

##### **Plaza Motors Corp. (Mazda de Puerto Rico)**

P.O. Box 362722, San Juan, Puerto Rico  
00936-2722  
TEL: (787) 641-9300

#### ▼ MEXICO

##### **Mazda Motor de Mexico**

Mario Pani # 150, PB Col. Lomas de  
Santa Fe Mexico, D.F. C.P. 05300 Del.  
Cuajimalpa  
TEL: Center of Attention to Clients:  
01 (800) 016 2932. in Mexico

#### ▼ GUAM

##### **Triple J Motors**

157 South Marine Drive, Tamuning,  
GUAM 96911 USA  
P.O. Box 6066 Tamuning, Guam 96931  
TEL: (671) 649-6555

#### ▼ SAIPAN

##### **Pacific International Marianas, Inc. (d.b.a. Midway Motors)**

P.O. Box 887 Saipan, MP 96950  
TEL: (670) 234-7524

Customer Information

## Mazda Importer/Distributors

---

**Triple J Saipan, Inc.**  
**(d.b.a. Triple J Motors)**  
P.O. Box 500487 Saipan, MP 96950-0487  
TEL: (670) 234-7133/3051

▼ **AMERICAN SAMOA**

**Polynesia Motors, Inc.**  
P.O. Box 1120, Pago Pago, American  
Samoa 96799  
TEL: (684) 699-9347

Customer Information  
**Warranty**

## Warranties for Your Mazda

- New Vehicle Limited Warranty
- Powertrain Limited Warranty
- Safety Restraint System Limited Warranty
- Anti-perforation Limited Warranty
- Federal Emission Control Warranty/California Emission Control Warranty
  - Emission Defect Warranty
  - Emission Performance Warranty
- Emission Control Warranty
- Replacement Parts and Accessories Limited Warranty
- Tire Warranty

**NOTE**

*Warranty information varies depending on the country. Refer to the Warranty Booklet for detailed warranty information.*

Customer Information

## Warranty

---

### Outside the United States

Government regulations in the United States require that automobiles meet specific emission regulations and safety standards. Therefore, vehicles built for use in the United States may differ from those sold in other countries.

The differences may make it difficult or even impossible for your vehicle to receive satisfactory servicing in other countries. We strongly recommend that you NOT take your Mazda outside the United States. However, in the event that you are moving to Canada permanently, Mazda vehicles built for use in the United States could be eligible for exportation to Canada with specific vehicle modifications to comply with the Canadian Motor Vehicle Safety Standards (CMVSS).

**NOTE**

*The above is applicable for a permanent import/export situation and not related to travelers on vacation.*

You may have the following problems if you do take your vehicle outside of the United States:

- Recommended fuel may be unavailable. Any kind of leaded fuel or low-octane fuel will affect vehicle performance and damage the emission controls and engine.
- Proper repair facilities, tools, testing equipment, and replacement parts may not be available.

Please refer to your Manufacturer's Warranty Booklet for more information.

## Outside Canada

Government regulations in Canada require that automobiles meet specific emission regulations and safety regulations. Therefore, vehicles built for use in Canada may differ from those sold in other countries.

The differences may make it difficult or even impossible for your vehicle to receive satisfactory servicing in other countries. We strongly recommend that you NOT take your Mazda outside Canada. However, in the event that you are moving to the United States permanently, Mazda vehicles built for use in Canada could be eligible for exportation to the United States with specific vehicle modifications to comply with the United States Federal Motor Vehicle Safety Standards (FMVSS).

**NOTE**

*The above is applicable for a permanent import/export situation and not related to travelers on vacation.*

You may have the following problems if you do take your vehicle outside of Canada:

- Recommended fuel may be unavailable. Any kind of leaded fuel or low-octane fuel will affect vehicle performance and damage the emission controls and engine.
- Proper repair facilities, tools, testing equipment, and replacement parts may not be available.

Please refer to your Manufacturer's Warranty Booklet for more information.

Customer Information

## Warranty

---

### Registering Your Vehicle in A Foreign Country (Except United States and Canada)

Registering your vehicle in a foreign country may be problematic depending on whether it meets the specific emission and safety standards of the country in which the vehicle will be driven. Consequently, your vehicle may require modifications at personal expense in order to meet the regulations.

In addition, you should be aware of the following issues:

Satisfactory vehicle servicing may be difficult or impossible in another country.

The fuel specified for your vehicle may be unavailable.

Parts, servicing techniques, and tools necessary to maintain and repair your vehicle may be unavailable.

There might not be an Authorized Mazda Dealer in the country you plan to take your vehicle.

The Mazda warranty is valid only in certain countries.

Customer Information  
**Warranty**

## Add-On Non-Genuine Parts and Accessories

Non-genuine parts and accessories for Mazda vehicles can be found in stores. These may fit your vehicle, but they are not approved by Mazda for use with Mazda vehicles. When you install non-genuine parts or accessories, they could affect your vehicle's performance or safety systems; the Mazda warranty doesn't cover this. Before you install any non-genuine parts or accessories, consult an Authorized Mazda Dealer.

### **⚠ WARNING**

**Always consult an Authorized Mazda Dealer before you install non-genuine parts or accessories:**

*Installation of non-genuine parts or accessories is dangerous. Improperly designed parts or accessories could seriously affect your vehicle's performance or safety systems. This could cause you to have an accident or increase your chances of injuries in an accident.*

**Be very careful in choosing and installing add-on electrical equipment, such as mobile telephones, two-way radios, stereo systems, and car alarm systems:**

*Incorrectly choosing or installing improper add-on equipment or choosing an improper installer is dangerous. Essential systems could be damaged, causing engine stalling, air-bag (SRS) activation, ABS/TCS/DSC inactivation, or a fire in the vehicle.*

Mazda assumes no responsibility for death, injury, or expenses that may result from the installation of add-on non-genuine parts or accessories.

Customer Information

## Cell Phones

---

### Cell Phones Warning

#### **WARNING**

***Please comply with the legal regulations concerning the use of communication equipment in vehicles in your State or Province:***

*Use of any electrical devices such as cell phones, computers, portable radios, vehicle navigation or other devices by the driver while the vehicle is moving is dangerous. Dialing a number on a cell phone while driving also ties-up the driver's hands. Use of these devices will cause the driver to be distracted and could lead to a serious accident. If a passenger is unable to use the device, pull off the right-of-way to a safe area before use. If use of a cell phone is necessary despite this warning, use a hands-free system to at least leave the hands free to drive the vehicle. Never use a cell phone or other electrical devices while the vehicle is moving and, instead, concentrate on the full-time job of driving.*



## Event Data Recorder

### Event Data Recorder

This vehicle is equipped with an event data recorder (EDR). The main purpose of an EDR is to record, in certain crash or near crash-like situations, such as an air bag deployment or hitting a road obstacle, data that will assist in understanding how a vehicle's systems performed. The EDR is designed to record data related to vehicle dynamics and safety systems for a short period of time, typically 30 seconds or less. The EDR in this vehicle is designed to record such data as:

- How various systems in your vehicle were operating;
- Whether or not the driver and passenger safety belts were buckled/fastened;
- How far (if at all) the driver was depressing the accelerator and/or brake pedal; and,
- How fast the vehicle was traveling.

These data can help provide a better understanding of the circumstances in which crashes and injuries occur.

**NOTE:**

EDR data are recorded by your vehicle only if a non-trivial crash or near crash-like situation occurs; no data are recorded by the EDR under normal driving conditions and no personal data (e.g., name, gender, age, and crash location) are recorded. However, other parties, such as law enforcement, could combine the EDR data with the type of personally identifying data routinely acquired during a crash investigation.

To read data recorded by an EDR, special equipment is required, and access to the vehicle or the EDR is needed. In addition to the vehicle manufacturer, other parties, such as law enforcement, that have the special equipment, can read the information if they have access to the vehicle or the EDR.

Mazda will not disclose any of the data recorded in an EDR to a third party unless:

- A written agreement from the vehicle owner or the lessee is obtained
- Officially requested by the police or other law enforcement authorities
- Used as a defense for Mazda in a law suit, claim, or arbitration
- Ordered by a judge or court

However, if necessary Mazda will:

- Use the data for research on Mazda vehicle performance, including safety.
- Disclose the data or the summarized data to a third party for research purposes without disclosing vehicle or owner identification information.



Customer Information

## Uniform Tire Quality Grading System (UTQGS)

---

### Uniform Tire Quality Grading System (UTQGS)

This information relates to the tire grading system developed by the U.S. National Highway Traffic Safety Administration for grading tires by tread wear, traction, and temperature performance.

#### ▼ Tread Wear

The tread wear grade is a comparative rating based on the wear rate of the tire when tested under controlled conditions on a specified government test course. For example, a tire graded 150 would wear one-and-a-half times as well on the government course as a tire graded 100.

The relative performance of tires depends upon the actual conditions of their use, however, and may depart significantly from the norm because of variations in driving habits, service practices and differences in road characteristics and climate.

#### ▼ Traction-AA, A, B, C

The traction grades, from highest to lowest, are AA, A, B, and C. These grades represent the tire's ability to stop on wet pavement as measured under controlled conditions on specified government test surfaces of asphalt and concrete. A tire marked C may have poor traction performance.

#### **⚠ WARNING**

*The traction grade assigned to this tire is based on braking (straight ahead) traction tests and does not include acceleration cornering (turning), hydroplaning, or peak traction characteristics.*

#### ▼ Temperature-A, B, C

The temperature grades A (the highest), B, and C, represent the tire's resistance to the generation of heat and its ability to dissipate heat when tested under controlled conditions on a specified indoor laboratory test wheel.

Sustained high temperature can cause the material of the tire to degenerate and reduce tire life, and excessive temperatures can lead to sudden tire failure.

Grade C corresponds to a level of performance which all passenger vehicle tires must meet under the Federal Motor Vehicle Safety Standard No. 109. Grades B and A represent higher levels of performance on the laboratory test wheel than the minimum required by law.

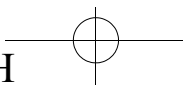

## Uniform Tire Quality Grading System (UTQGS)

### **⚠ WARNING**

**Keep your vehicle's tires properly inflated and not overloaded:**

*Driving with improperly inflated or overloaded tires is dangerous. Excessive speed, underinflation, or excessive loading, either separately or in combination, can cause heat buildup and possible tire failure. The temperature grade for this tire is established for a tire that is properly inflated and not overloaded.*

These grades will be added to the sidewalls of passenger vehicle tires over the next several years according to a schedule established by the NHTSA and the tire manufacturers.

The grade of tires available as standard or optional equipment on Mazda vehicles may vary with respect to grade.

**ALL PASSENGER VEHICLE TIRES MUST CONFORM TO THESE GRADES AND TO ALL OTHER FEDERAL TIRE-SAFETY REQUIREMENTS.**

### **▼ UNIFORM TIRE QUALITY GRADING**

Quality grades can be found where applicable on the tire sidewall between tread shoulder and maximum section width.

For example:

**TREADWEAR 200 TRACTION AA TEMPERATURE A**

**UTQGS MARK (example)**

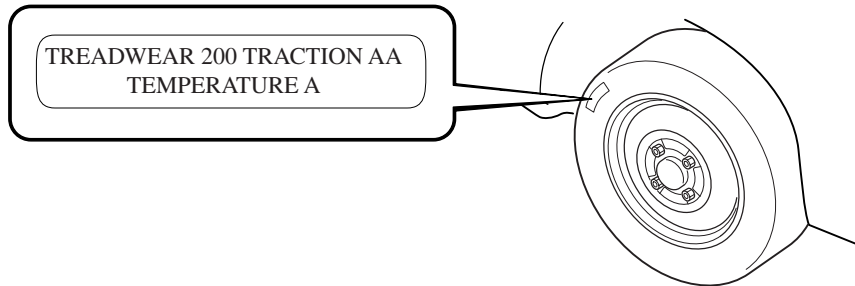

Customer Information

## Tire Information (U.S.A.)

### Tire Labeling

Federal law requires tire manufacturers to place standardized information on the sidewall of all tires. This information identifies and describes the fundamental characteristics of the tire and also provides a tire identification number for safety standard certification and in case of a recall.

#### ▼ Information on Passenger Vehicle Tires

Please refer to the sample below.

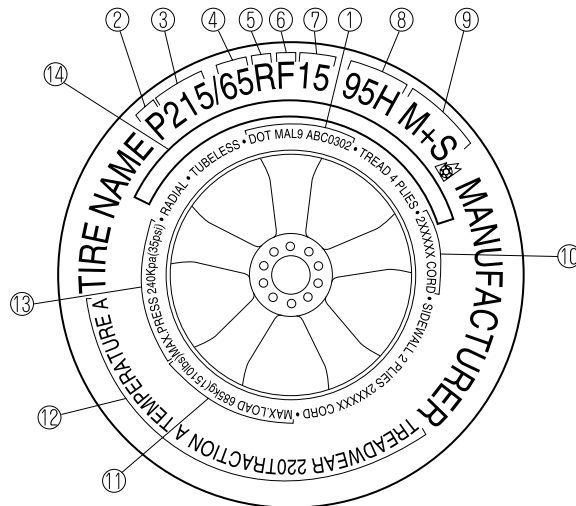

1. TIN: U.S. DOT tire identification number
2. Passenger car tire
3. Nominal width of tire in millimeters
4. Ratio of height to width (aspect ratio)
5. Radial
6. Run-flat tire
7. Rim diameter code
8. Load index & speed symbol
9. Severe snow conditions
10. Tire ply composition and materials used

9-24

Customer Information  
**Tire Information (U.S.A.)**

---

11. Max. load rating
12. Tread wear, traction and temperature grades
13. Max. permissible inflation pressure
14. SAFETY WARNING

P215/65R15 95H is an example of a tire size and load index rating. Here is an explanation of the various components of that tire size and load index rating. Note that the tire size and load index rating may be different from the example.

**P**

Indicates a tire that may be installed on cars, SUVs, minivans and light trucks as designated by the Tire and Rim Association (T&RA).

**NOTE**

*If your tire size does not begin with a letter this may mean it is designated by either ETRTO (European Tire and Rim Technical Organization) or JATMA (Japan Tire Manufacturing Association).*

**215**

“215” is the nominal width of the tire in millimeters. This three-digit number gives the width in millimeters of the tire from sidewall edge to sidewall edge. In general, the larger the number, the wider the tire.

**65**

“65” is the aspect ratio. This two-digit number indicates the tire's ratio of height to width.

**R**

“R” is the tire construction symbol. R indicates “Radial ply construction”.

**15**

“15” is the wheel rim diameter in inches.

**95**

“95” is the Load Index. This two-or three-digit number indicates how much weight each tire can support.

Customer Information

## Tire Information (U.S.A.)

---

### H

“H” is the speed rating. The speed rating denotes the maximum speed for which the use of the tire is rated.

| Letter Rating | Speed Rating |
|---------------|--------------|
| Q             | 99 mph       |
| R             | 106 mph      |
| S             | 112 mph      |
| T             | 118 mph      |
| U             | 124 mph      |
| H             | 130 mph      |
| V             | 149 mph      |
| W             | 168* mph     |
| Y             | 186* mph     |

\* For tires with a maximum speed capability over 149 mph, tire manufacturers sometimes use the letters ZR. For tires with a maximum speed capability over 186 mph, tire manufacturers always use the letters ZR.

### **M+ S or M/S: Mud and Snow**

AT: All Terrain.

AS: All Season. The “M+ S” or “M/S” indicates that the tire has some functional use in mud and snow.

### **U.S. DOT Tire Identification Number (TIN)**

This begins with the letters “DOT” which indicates the tire meets all federal standards. The next two numbers or letters are the plant code where it was manufactured, and the last four numbers represent the week and year the tire was manufactured. For example, the numbers 457 means the 45st week of 1997. After 2000 the numbers go to four digits. For example, the number 2102 means the 21th week of 2002. The other numbers are marketing codes used at the manufacturer's discretion. This information is used to contact consumers if a tire defect requires a recall.

### **Tire Ply Composition and Materials Used**

The number of plies indicates the number of layers of rubber-coated fabric in the tire. In general, the greater the number of plies, the more weight a tire can support. Tire manufacturers also must indicate the tire materials, which include steel, nylon, polyester, and other.

### **Maximum Load Rating**

This number indicates the maximum load in kilograms and pounds that can be carried by the tire.

### **Maximum Permissible Inflation Pressure**

This number is the greatest amount of air pressure that should ever be put in the tire under normal driving conditions.

Customer Information

## Tire Information (U.S.A.)

### **Tread Wear, Traction and Temperature Grades**

**Tread wear:** The tread wear grade is a comparative rating based on the wear rate of the tire when tested under controlled conditions on a specified government test course. For example, a tire graded 150 would wear one and one-half (1 1/2) times as well on the government course as a tire graded 100.

**Traction:** The traction grades, from highest to lowest are AA, A, B, and C. The grades represent the tire's ability to stop on wet pavement as measured under controlled conditions on specified government test surfaces of asphalt and concrete. A tire marked C may have poor traction performance.

**Temperature:** The temperature grades are A (the highest), B and C, representing the tire's resistance to the generation of heat and its ability to dissipate heat when tested under controlled conditions on a specified indoor laboratory test wheel.

### **Snow Tires**

In some heavy snow areas, local governments may require true snow tires, those with very deeply cut tread. These tires should only be used in pairs or placed on all four wheels. Make sure you purchase snow tires that are the same size and construction type as the other tires on your vehicle.

### **SAFETY WARNING**

The following safety warning appears on the tire's sidewall.

SERIOUS INJURY MAY RESULT FROM:

- EXPLOSION OF TIRE/RIM ASSEMBLY DUE TO IMPROPER MOUNTING-MATCH TIRE DIAMETER TO RIM DIAMETER; NEVER EXCEED 40 psi (275 kPa) TO SEAT BEADS-ONLY SPECIALLY TRAINED PERSONS SHOULD MOUNT TIRES.
- TIRE FAILURE DUE TO UNDER-INFLATION/OVERLOADING/DAMAGE-FOLLOW OWNER'S MANUAL AND PLACARD IN VEHICLE-FREQUENTLY CHECK INFLATION PRESSURE AND INSPECT FOR DAMAGE.



Customer Information

## Tire Information (U.S.A.)

---

### ▼ Information on Temporary Tires

Please refer to the sample below.

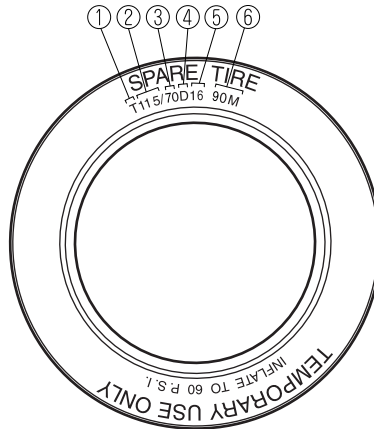

1. Temporary tires
2. Nominal width of tire in millimeters
3. Ratio of height to width (aspect ratio)
4. Diagonal
5. Rim diameter code
6. Load index & speed symbol

T115/70D 16 90M is an example of a tire size and load index rating. Here is an explanation of the various components of that tire size and load index rating. Note that the tire size and load index rating may be different from the example.

#### **T**

Indicates a tire that may be installed on cars, SUVs, minivans and light trucks as designated by the Tire and Rim Association (T&RA).

#### **115**

“115” is the nominal width of the tire in millimeters. This three-digit number gives the width in millimeters of the tire from sidewall edge to sidewall edge. In general, the larger the number, the wider the tire.

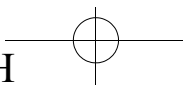



Customer Information  
**Tire Information (U.S.A.)**

---

**70**

“70” is the aspect ratio. This two-digit number indicates the tire's ratio of height to width.

**D**

“D” is the tire construction symbol. D indicates “diagonal ply construction”.

**16**

“16” is the wheel rim diameter in inches.

**90**

“90” is the Load Index. This two-or three-digit number indicates how much weight each tire can support.

**M**

“M” is the speed rating. The speed rating denotes the maximum speed for which the use of the tire is rated.

| Letter Rating | Speed Rating |
|---------------|--------------|
| M             | 81 mph       |

Customer Information

**Tire Information (U.S.A.)**

**Location of the Tire Label (Placard)**

You will find the tire label containing tire inflation pressure by tire size and other important information on the driver's side B-pillar or on the edge of the driver's door frame.

**SAMPLE**



**TIRE AND LOADING INFORMATION**  
**RENSEIGNEMENTS SUR LES PNEUS ET LE CHARGEMENT**

|                                      |         |                  |                   |
|--------------------------------------|---------|------------------|-------------------|
| SEATING CAPACITY<br>NOMBRE DE PLACES | TOTAL 5 | FRONT<br>AVANT 2 | REAR<br>ARRIÈRE 3 |
|--------------------------------------|---------|------------------|-------------------|

The combined weight of occupants and cargo should never exceed **xxx** kg or **xxx** lbs.\*  
 Le poids total des occupants et du chargement ne doit jamais dépasser **xxx** kg ou **xxx** lb.\*

| TIRE<br>PNEU        | SIZE<br>DIMENSIONS | COLD TIRE PRESSURE<br>PRESSION DES<br>PNEUS À FROID | SEE OWNER'S<br>MANUAL FOR<br>ADDITIONAL<br>INFORMATION                   |
|---------------------|--------------------|---|--|
| FRONT<br>AVANT      | P195/70R14         | 200 kPa, 29 psi                                     | VOIR LE MANUEL<br>DE L'USAGER<br>POUR PLUS DE<br>RENSEIGNEMENTS<br>(XXX) |
| REAR<br>ARRIÈRE     | P195/70R14         | 200 kPa, 29 psi                                     |  |
| SPARE<br>DE SECOURS | T125/70D15         | 420 kPa, 60 psi                                     |  |

**▼ Recommended Tire Inflation Pressure**

On the tire label you will find the recommended tire inflation pressure in both kPa and psi for the tires installed as original equipment on the vehicle. It is very important that the inflation pressure of the tires on your vehicle is maintained at the recommended pressure. You should check the tire pressure regularly to insure that the proper inflation pressure is maintained.

Refer to Tires on page 10-12.

**NOTE**

*Tire pressures listed on the vehicle placard or tire information label indicate the recommended cold tire inflation pressure, measured when the tires are cold, after the vehicle has been parked for at least 3 hours. As you drive, the temperature in the tire warms up, increasing the tire pressure.*

## Tire Information (U.S.A.)

### **WARNING**

**Always check the tire inflation pressures on a regular basis according to the recommended tire inflation pressure on the tire label and in conjunction with the information in this owner's manual:**

*Driving your vehicle with under-inflated tires is dangerous.*

*Under-inflation is the most common cause of failures in any kind of tire and may result in severe cracking, tread separation or "blowout", with unexpected loss of vehicle control and increased risk of injury. Under-inflation increases sidewall flexing and rolling resistance, resulting in heat buildup and internal damage to the tire. It results in unnecessary tire stress, irregular wear, loss of control and accidents. A tire can lose up to half of its air pressure and not appear to be flat!*

*It is impossible to determine whether or not tires are properly inflated just by looking at them.*

### ▼ **Checking Tire Pressure**

1. When you check the air pressure, make sure the tires are cold —meaning they are not hot from driving even a mile.
2. Remove the cap from the valve on one tire.
3. Firmly press a tire gauge onto the valve.
4. Add air to achieve recommended air pressure.
5. If you overfill the tire, release air by pushing on the metal stem in the center of the valve. Then recheck the pressure with your tire gauge.
6. Replace the valve cap.
7. Repeat with each tire, including the spare.

#### **NOTE**

*Some spare tires require higher inflation pressure.*

8. Visually inspect the tires to make sure there are no nails or other objects embedded that could poke a hole in the tire and cause an air leak.
9. Check the sidewalls to make sure there are no gouges, cuts, bulges, cracks or other irregularities.

#### **NOTE**

*Warm tires normally exceed recommended pressures. Don't release air from warm tires to adjust the pressure.*

*Under-inflation can cause serious failures and accidents.*

*Over-inflation can produce a harsh ride and the greater possibility of damage from road hazards.*

Customer Information

## Tire Information (U.S.A.)

---

### ▼ Glossary of Terms

**Tire Placard:** A label indicating the OE tire sizes, recommended inflation pressure, and the maximum weight the vehicle can carry.

**Tire Identification Number (TIN):** A number on the sidewall of each tire providing information about the tire brand and manufacturing plant, tire size, and date of manufacture.

**Inflation Pressure:** A measure of the amount of air in a tire.

**kPa:** Kilopascal, the metric unit for air pressure.

**psi:** Pounds per square inch, the English unit for air pressure.

**B-pillar:** The structural member at the side of the vehicle behind the front door.

**Original Equipment (OE):** Describes components originally equipped on the vehicle.

**Vehicle Load Limit:** The maximum value of the combination weight of occupants and cargo.

**Bead Area of the Tire:** Area of the tire next to the rim.

**Sidewall Area of the Tire:** Area between the bead area and the tread.

**Tread Area of the Tire:** Area on the perimeter of the tire that contacts the road when it's mounted on the vehicle.

**Seating capacity** means the total allowable number of vehicle occupants. Seating capacity is described on the tire label.

**Production options weight** is the combination weight of installed regular production options weighing over 2.3 kilograms in excess of the standard items which they replace, and not previously considered in the curb weight or accessory weight, including heavy duty brakes, ride levelers, roof rack, heavy duty battery, and special trim.

**Rim** is the metal support (wheel) for a tire or a tire and tube assembly upon which the tire beads are seated.

Customer Information  
**Tire Information (U.S.A.)**

## Tire Maintenance

Improper or inadequate vehicle maintenance can cause tires to wear abnormally. Here are some important maintenance points:

### ▼ Tire Inflation Pressure

Inspect all tire pressure monthly (including the spare) when the tires are cold. Maintain recommended pressures for the best ride, top handling, and minimum tire wear. Use the pressures specified on the vehicle tire information placard or tire label for optimum service.

### ▼ Tire Rotation

To equalize tread wear, rotate the tires every 12,000 km (7,500 miles) or sooner if irregular wear develops. During rotation, inspect them for correct balance.

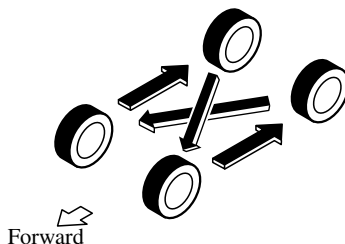

Do not include (TEMPORARY USE ONLY)  
spare tire in rotation.

Inspect the tires for uneven wear and damage. Abnormal wear is usually caused by one or a combination of the following:

- Incorrect tire pressure
- Improper wheel alignment
- Out-of-balance wheel
- Severe braking

After rotation, inflate all tire pressures to specification (page 10-12) and inspect the lug nuts for tightness.

Customer Information

## Tire Information (U.S.A.)

---

### **⚠ CAUTION**

Rotate unidirectional tires and radial tires that have an asymmetrical tread pattern or studs only from front to rear, not from side to side. Tire performance will be weakened if rotated from side to side.

#### **(With limited-slip differential)**

Don't use the following:

- Tires not of the designated size
- Tires of different sizes or types at the same time
- Tires not sufficiently inflated

If these instructions aren't followed, the rotation of the left and right wheels will be different and will thus apply a constant load on the limited-slip differential.

This will cause a malfunction.

### ▼ Replacing a Tire

### **⚠ WARNING**

**Always use tires that are in good condition:**

*Driving with worn tires is dangerous. Reduced braking, steering, and traction could result in an accident.*

If a tire wears evenly, a wear indicator will appear as a solid band across the tread. Replace the tire when this happens.

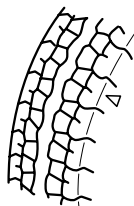

New tread

Tread wear indicator

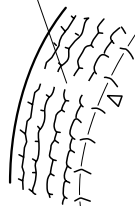

Worn tread

You should replace the tire before the band crosses the entire tread.

Customer Information

## Tire Information (U.S.A.)

### NOTE

*Tires degrade over time, even when they are not being used on the road. It is recommended that tires generally be replaced when they are 6 years or older. Heat caused by hot climates or frequent high loading conditions can accelerate the aging process. You should replace the spare tire when you replace the other road tires due to the aging of the spare tire. The period in which the tire was manufactured (both week and year) is indicated by a 4-digit number.*

*Refer to Tire Labeling on page 9-24.*

### ▼ Safety Practices

The way you drive has a great deal to do with your tire mileage and safety. So cultivate good driving habits for your own benefit.

- Observe posted speed limits
- Avoid fast starts, stops and turns
- Avoid potholes and objects on the road
- Do not run over curbs or hit the tire against the curb when parking

### CAUTION

*If you feel a sudden vibration or ride disturbance while driving or you suspect your tire or vehicle has been damaged, immediately reduce your speed. Drive with caution until you can safely pull off the road. Stop and inspect the tire for damage. If the tire is under-inflated or damaged, deflate it, remove the tire and rim and replace it with your spare tire. If you cannot detect a cause, have the vehicle towed to the nearest vehicle or tire dealer to have the vehicle inspected.*

Customer Information

## Tire Information (U.S.A.)

### Vehicle Loading

#### **WARNING**

**Do not tow a trailer with this vehicle:**

*Towing a trailer with this vehicle is dangerous because it has not been designed to tow a trailer and doing so will affect the drive system which could result in vehicle damage.*

This section will guide you in the proper loading of your vehicle, to keep your loaded vehicle weight within its design rating capability. Properly loading your vehicle will provide maximum return of vehicle design performance. Before loading your vehicle, familiarize yourself with the following terms for determining your vehicle's weight ratings, from the vehicle's Safety Certification Label and Tire and Load Information Label:

#### **WARNING**

**Overloaded Vehicle:**

*Overloading a vehicle is dangerous. The results of overloading can have serious consequences in terms of passenger safety. Too much weight on a vehicle's suspension system can cause spring or shock absorber failure, brake failure, handling or steering problems, irregular tire wear, tire failure or other damage. Overloading makes a vehicle harder to drive and control. It also increases the distance required for stopping. In cases of serious overloading, brakes can fail completely, particularly on steep grades. The load a tire will carry safely is a combination of the size of the tire, its load range, and corresponding inflation pressure.*

*Never overload the vehicle and always observe the vehicle's weight ratings from the vehicle's Safety Certification and Tire and Load Information labels.*



Customer Information  
**Tire Information (U.S.A.)**

**Base Curb Weight** is the weight of the vehicle including a full tank of fuel and all standard equipment. It does not include passengers, cargo, or optional equipment.

**Vehicle Curb Weight** is the weight of your new vehicle when you picked it up from your dealer plus any aftermarket equipment.

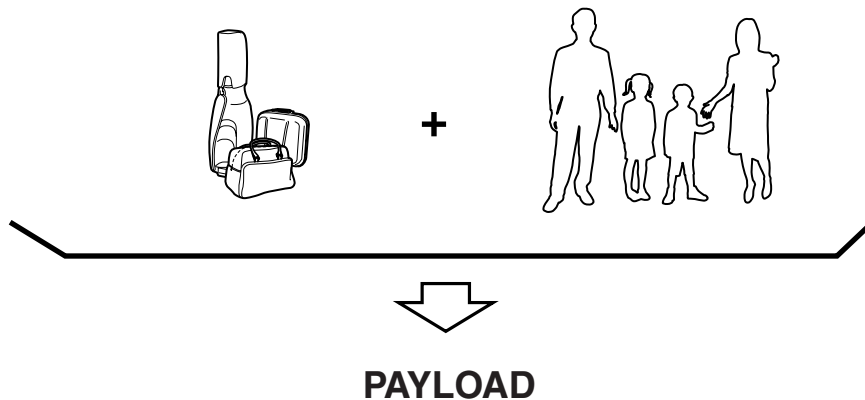

**Payload** is the combination weight of cargo and passengers that the vehicle is designed to carry. The maximum payload for your vehicle can be found on the Tire and Load Information label on the driver's door frame or door pillar. Look for "THE COMBINATION WEIGHT OF OCCUPANTS AND CARGO SHOULD NEVER EXCEED XXX kg or XXX lbs" for your maximum payload. The payload listed on the tire label is the maximum payload for the vehicle as built by the assembly plant. If any aftermarket or dealer installed equipment has been installed on the vehicle, the weight of the equipment must be subtracted from the payload listed on the tire label in order to be accurate.

Customer Information

**Tire Information (U.S.A.)**

SAMPLE

|  <b>TIRE AND LOADING INFORMATION</b><br><b>RENSEIGNEMENTS SUR LES PNEUS ET LE CHARGEMENT</b>                              |                 |   |  |                     |
|--|-----------------|---|--|---------------------|
| <b>SEATING CAPACITY</b><br><b>NOMBRE DE PLACES</b>   |                 | TOTAL 5                                       | FRONT 2<br>AVANT 2   | REAR 3<br>ARRIÈRE 3 |
| The combined weight of occupants and cargo should never exceed <b>xxx</b> kg or <b>xxx</b> lbs.*<br>Le poids total des occupants et du chargement ne doit jamais dépasser <b>xxx</b> kg ou <b>xxx</b> lb.* |                 |   |  |                     |
| TIRE PNEU  | SIZE DIMENSIONS | COLD TIRE PRESSURE PRESSION DES PNEUS À FROID | SEE OWNER'S MANUAL FOR ADDITIONAL INFORMATION                |                     |
| FRONT AVANT  | P195/70R14      | 200 kPa, 29 psi                               | VOIR LE MANUEL DE L'USAGER POUR PLUS DE RENSEIGNEMENTS (XXX) |                     |
| REAR ARRIÈRE   | P195/70R14      | 200 kPa, 29 psi                               |  |                     |
| SPARE DE SECOURS   | T125/70D15      | 420 kPa, 60 psi                               |  |                     |



**CARGO**

**Cargo Weight** includes all weight added to the Base Curb Weight, including cargo and optional equipment.

The cargo weight limit decreases depending on the number of vehicle occupants. The cargo weight limit can be calculated by subtracting the total weight of the vehicle occupants from the "combination weight of occupants and cargo should never exceed" value on the tire label.

Customer Information  
**Tire Information (U.S.A.)**

Examples: Based on a single occupant weight of 68 kg (150 lbs), and a value of 385 kg (849 lbs) for the “combination weight of occupants and cargo should never exceed”:  
The cargo weight limit with one occupant is 385 kg (849 lbs) – 68 kg (150 lbs) = 317 kg (699 lbs)  
The cargo weight limit with two occupants is 385 kg (849 lbs) – (68 × 2) kg ((150 × 2) lbs) = 249 kg (549 lbs)  
If the weight of the occupant increases, the cargo weight limit decreases by that much.

**GAW (Gross Axle Weight)** is the total weight placed on each axle (front and rear) - including vehicle curb weight and all payload.

**GAWR (Gross Axle Weight Rating)** is the maximum allowable weight that can be carried by a single axle (front or rear). **These numbers are shown on the Safety Compliance Certification Label located on the driver's door frame or door pillar. The total load on each axle must never exceed its GAWR.**

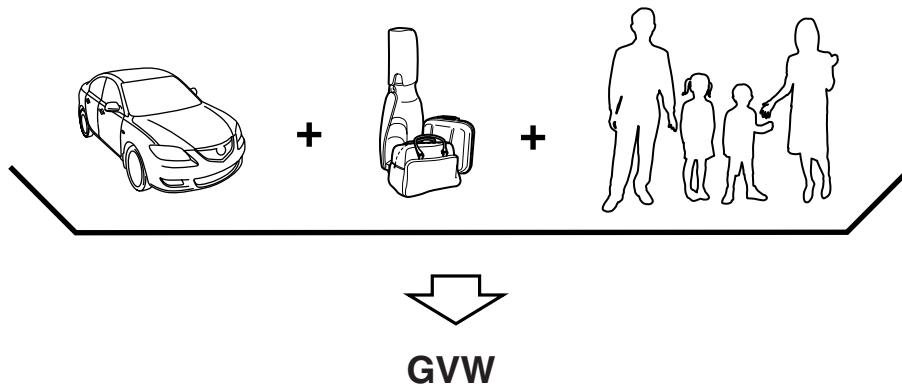

**GVW (Gross Vehicle Weight)** is the Vehicle Curb Weight + cargo + passengers.

**GVWR (Gross Vehicle Weight Rating)** is the maximum allowable weight of the fully loaded vehicle (including all options, equipment, passengers and cargo). **The GVWR is shown on the Safety Compliance Certification Label located on the driver's door frame or door pillar. The GVW must never exceed the GVWR.**



Customer Information  
**Tire Information (U.S.A.)**

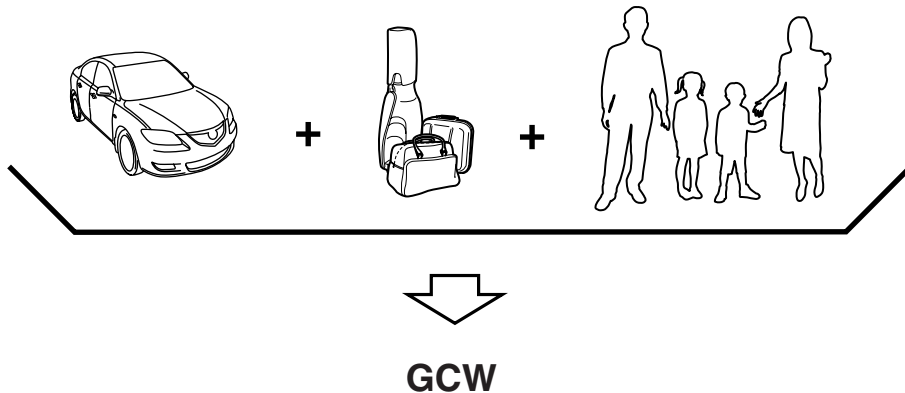

**GCW (Gross Combination Weight)** is the weight of the loaded vehicle (GVW).

**GCWR (Gross Combination Weight Rating)** is the maximum allowable weight of the vehicle - including all cargo and passengers - that the vehicle can handle without risking damage. **The GCW must never exceed the GCWR.**

**! WARNING**

**Exceeding GVWR or GAWR Specifications:**

*Exceeding the GVWR or the GAWR specified on the certification label is dangerous. Exceeding any vehicle rating limitation could result in a serious accident, injury, or damage to the vehicle.*

*Do not use replacement tires with lower load carrying capacities than the originals because they may lower the vehicle's GVWR and GAWR limitations. Replacement tires with a higher limit than the originals do not increase the GVWR and GAWR limitations.*

*Never exceed the GVWR or the GAWR specified on the certification label.*

Customer Information

## Tire Information (U.S.A.)

---

### Steps for Determining the Correct Load Limit

#### Steps for Determining Correct Load Limit-

- (1) Locate the statement “The combined weight of occupants and cargo should never exceed XXX kg or XXX lbs.” on your vehicle's placard.
- (2) Determine the combined weight of the driver and passengers that will be riding in your vehicle.
- (3) Subtract the combined weight of the driver and passengers from XXX kg or XXX lbs.
- (4) The resulting figure equals the available amount of cargo and luggage load capacity. For example, if the “XXX” amount equals 1400 lbs. and there will be five 150 lb passengers in your vehicle, the amount of available cargo and luggage load capacity is 650 lbs. ( $1400 - 750 (5 \times 150) = 650$  lbs.)
- (5) Determine the combined weight of luggage and cargo being loaded on the vehicle. That weight may not safely exceed the available cargo and luggage load capacity calculated in Step 4.
- (6) If your vehicle will be towing a trailer, load from your trailer will be transferred to your vehicle. Consult this manual to determine how this reduces the available cargo and luggage load capacity of your vehicle.

## Reporting Safety Defects

### Reporting Safety Defects (U.S.A.)

If you believe that your vehicle has a defect which could cause a crash or could cause injury or death, you should immediately inform the National Highway Traffic Safety Administration (NHTSA) in addition to notifying Mazda Motor Corporation (Your Mazda Importer/Distributor).

If NHTSA receives similar complaints, it may open an investigation, and if it finds that a safety defect exists in a group of vehicles, it may order a recall and remedy campaign. However, NHTSA cannot become involved in individual problems between you, your dealer, or Mazda Motor Corporation (Your Mazda Importer/Distributor).

To contact NHTSA, you may call the Vehicle Safety Hotline toll-free at 1-888-327-4236 (TTY:1-800-424-9153); go to <http://www.safercar.gov>; or write to: Administrator, NHTSA, 1200 New Jersey Avenue, SE., Washington, DC, 20590. You can also obtain other information about motor vehicle safety from <http://www.safercar.gov>.

**NOTE**

*If you live in the U.S.A., all correspondence to Mazda Motor Corporation should be forwarded to:*

*Mazda North American Operations*

*7755 Irvine Center Drive*

*Irvine, California 92618-2922*

*or*

*P.O. Box 19734*

*Irvine, CA 92623-9734*

*Customer Assistance Center or toll free at 1 (800) 222-5500*

*If you live outside of the U.S.A., please contact the nearest Mazda Distributor shown (page 9-13) in this booklet.*



Customer Information

## Reporting Safety Defects

---

### Reporting Safety Defects (Canada)

Canadian customers who wish to report a safety-related defect to Transport Canada, Defect Investigations and Recalls, may telephone the toll free hotline 1-800-333-0510, or contact Transport Canada by mail at: Transport Canada, ASFAD, Place de Ville Tower C, 330 Sparks Street, Ottawa ON K1A 0N5.

For additional road safety information, please visit the Road Safety website at:  
<http://www.tc.gc.ca/roadsafety/menu.htm>

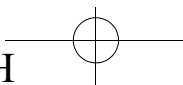



Customer Information  
**Service Publications**

## Service Publications

Factory-authorized Mazda service publications are available for owners who wish to do some of their own maintenance and repair.

When requesting any of our publications through an Authorized Mazda Dealer, refer to the chart below.

If they do not have what you need in stock, they can order it for you.

| PUBLICATION ORDER NUMBER | PUBLICATION DESCRIPTION                                    |
|--------------------------|--|
| 9999-95-017B-13          | 2013 WORKSHOP MANUAL (English)                             |
| 9999-MX-017B-13          | 2013 WORKSHOP MANUAL (Spanish)                             |
| 9999-95-019G-13          | 2013 WIRING DIAGRAM (English)                              |
| 9999-MX-019G-13          | 2013 WIRING DIAGRAM (Spanish)                              |
| 9999-95-028C-13R         | 2013 OWNER'S MANUAL (English)                              |
| 9999-EC-028C-13R         | 2013 OWNER'S MANUAL (English and French)                   |
| 9999-PR-028C-13R         | 2013 OWNER'S MANUAL (Spanish)                              |
| 9999-95-MODL-13          | 2013 SERVICE HIGHLIGHTS                                    |
| 9999-95-NAV1-13          | 2013 NAVIGATION SYSTEM OWNER'S MANUAL (English)            |
| 9999-EC-NAV1-13          | 2013 NAVIGATION SYSTEM OWNER'S MANUAL (English and French) |
| 9999-PR-NAV1-13          | 2013 NAVIGATION SYSTEM OWNER'S MANUAL (Spanish)            |

### ▼ WORKSHOP MANUAL:

Covers recommended maintenance and repair procedures of the drive train, body and chassis.

### ▼ WIRING DIAGRAM:

Provides electrical schematics as well as component location for the entire electrical system.

### ▼ OWNER'S MANUAL:

This booklet contains information regarding the proper care and operation of your vehicle. This is not a technician's manual.

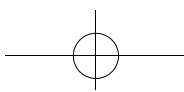

Customer Information

## Service Publications

---

### ▼SERVICE HIGHLIGHTS:

Provides description and operation of the many systems of your Mazda.

### ▼NAVIGATION SYSTEM OWNER'S MANUAL:

This booklet contains information regarding the proper operation and use of the navigation system. This is not a technician's manual.

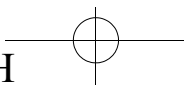

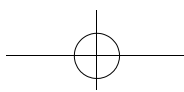

# 10 Specifications

Technical information about your Mazda.

|                                       |              |
|---------------------------------------|--------------|
| <b>Identification Numbers .....</b>   | <b>10-2</b>  |
| Vehicle Information Labels .....      | 10-2         |
| <b>Specifications .....</b>           | <b>10-4</b>  |
| Specifications .....                  | 10-4         |
| <b>Personalization Features .....</b> | <b>10-13</b> |
| Personalization Features .....        | 10-13        |

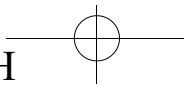

## Identification Numbers

### Vehicle Information Labels

#### ▼ Vehicle Identification Number

The vehicle identification number legally identifies your vehicle. The number is on a plate attached to the cowl panel located on the left corner of the dashboard. This plate can easily be seen through the windshield.

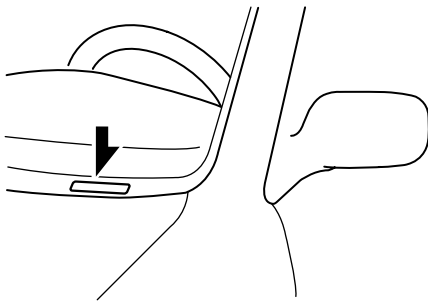

#### ▼ Motor Vehicle Safety Standard Label\*

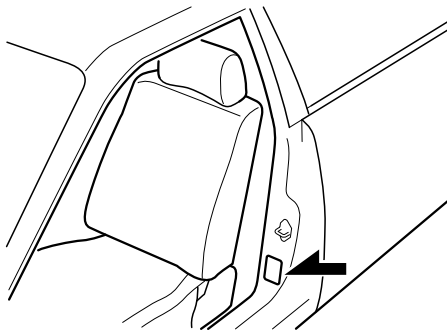

#### ▼ Chassis Number

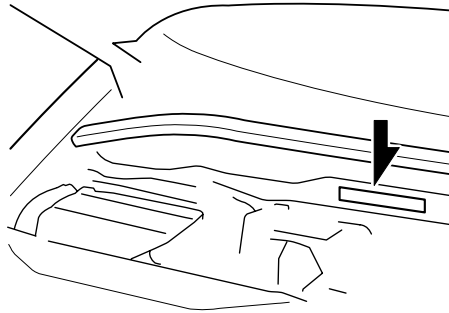

#### ▼ Vehicle Emission Control Information Label\*

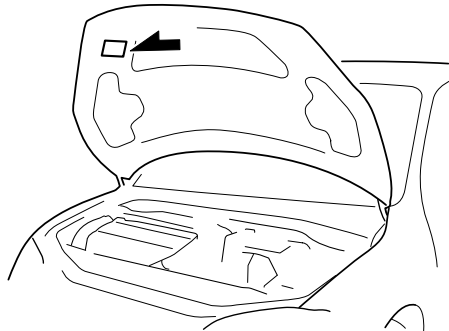

#### ▼ Tire Pressure Label

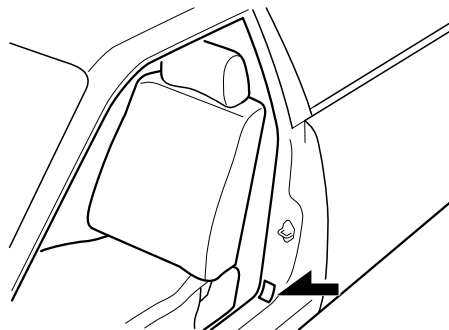

## Identification Numbers

### ▼ Engine Number

**MZR 2.0, MZR 2.5**

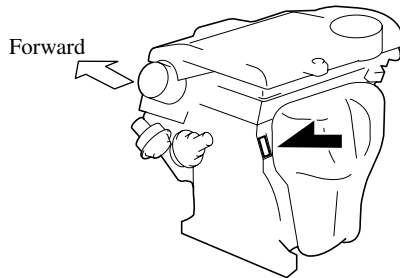

**SKYACTIV-G 2.0**

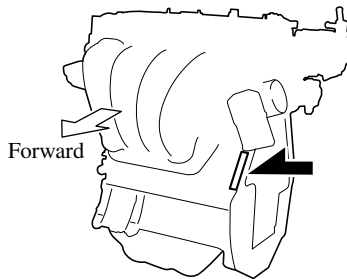

**MZR 2.3 DISI Turbo**

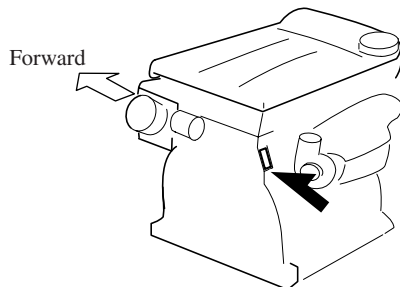

## Specifications

### Specifications

#### ▼ Engine

| Item              | Specification                    |                                  |
|-------------------|----------------------------------|----------------------------------|
|                   | MZR 2.0                          | SKYACTIV-G 2.0                   |
| Type              | DOHC-16V in-line, 4-cylinder     |                                  |
| Bore × Stroke     | 87.5 × 83.1 mm (3.44 × 3.27 in)  | 83.5 × 91.2 mm (3.29 × 3.59 in)  |
| Displacement      | 1,999 ml (1,999 cc, 122.0 cu in) | 1,998 ml (1,998 cc, 121.9 cu in) |
| Compression ratio | 10.0                             | 12.0                             |

| Item              | Specification                    |                                  |
|-------------------|----------------------------------|----------------------------------|
|                   | MZR 2.3 DISI Turbo               | MZR 2.5                          |
| Type              | DOHC-16V in-line, 4-cylinder     |                                  |
| Bore × Stroke     | 87.5 × 94.0 mm (3.44 × 3.70 in)  | 89.0 × 100 mm (3.50 × 3.94 in)   |
| Displacement      | 2,261 ml (2,261 cc, 138.0 cu in) | 2,488 ml (2,488 cc, 151.8 cu in) |
| Compression ratio | 9.5                              | 9.7                              |

#### ▼ Electrical System

| Item              | Classification               |                             |  |   |
|-------------------|------------------------------|-----------------------------|--|---|
|                   | MZR 2.0                      |                             | SKYACTIV-G 2.0                         |   |
| Battery           | 12V-50Ah/20HR, 12V-65Ah/20HR |                             | 12V-60Ah/20HR, 12V-65Ah/20HR           |   |
| Spark-plug number | Mazda Genuine spark plug     | LFJD-18-110,<br>L3Y2-18-110 | Mazda Genuine spark plug* <sup>1</sup> | PE01-18-110,<br>PE02-18-110,<br>PE5R-18-110,<br>PE5S-18-110 |

| Item              | Classification               |                             |  |                             |
|-------------------|------------------------------|-----------------------------|--|-----------------------------|
|                   | MZR 2.3 DISI Turbo           |                             | MZR 2.5  |                             |
| Battery           | 12V-60Ah/20HR, 12V-65Ah/20HR |                             | 12V-50Ah/20HR, 12V-60Ah/20HR,<br>12V-65Ah/20HR |                             |
| Spark-plug number | Mazda Genuine spark plug     | L3BD-18-110,<br>L3YD-18-110 | Mazda Genuine spark plug                       | LFJD-18-110,<br>L3Y2-18-110 |

\*1 This spark plug provides the SKYACTIV-G engine with optimum performance. Contact an Authorized Mazda Dealer for details.

#### CAUTION

*When cleaning the iridium plugs, do not use a wire brush. The fine particulate coating on the iridium alloy and platinum tips could be damaged.*

## Specifications

### ▼ Lubricant Quality

| Lubricant                 | Classification  |                       |
|---------------------------|---|-----------------------|
| Engine oil                | Refer to Recommended Oil on page 8-21.                        |                       |
| Manual transaxle oil      | API Service   | GL-4                  |
|                           | SAE   | 75W-80                |
| Automatic transaxle fluid | 5-speed transaxle   | Mazda Genuine ATF M-V |
|                           | 6-speed transaxle   | Mazda Genuine ATF FZ  |
| Power steering fluid      | Mazda Genuine ATF M-III, M-V, or equivalent (e.g. Dexron® II) |                       |
| Brake/Clutch fluid        | SAE J1703 or FMVSS116 DOT-3                                   |                       |

#### **NOTE**

*Refer to Introduction on (page 8-2) for owner's responsibility in protecting your investment.*

## Specifications

### ▼ Capacities

(Approximate Quantities)

| Item                      |                             | Capacity                           |                               |
|---------------------------|-----------------------------|------------------------------------|-------------------------------|
| Engine oil                | MZR 2.0                     | With oil filter replacement        | 4.3 L (4.5 US qt, 3.8 Imp qt) |
|                           |                             | Without oil filter replacement     | 3.9 L (4.1 US qt, 3.4 Imp qt) |
|                           | SKYACTIV-G 2.0              | With oil filter replacement        | 4.2 L (4.4 US qt, 3.7 Imp qt) |
|                           |                             | Without oil filter replacement     | 4.0 L (4.2 US qt, 3.5 Imp qt) |
|                           | MZR 2.3 DISI Turbo          | With oil filter replacement        | 5.7 L (6.0 US qt, 5.0 Imp qt) |
|                           |                             | Without oil filter replacement     | 5.3 L (5.6 US qt, 4.7 Imp qt) |
|                           | MZR 2.5                     | With oil filter replacement        | 5.0 L (5.3 US qt, 4.4 Imp qt) |
|                           |                             | Without oil filter replacement     | 4.6 L (4.9 US qt, 4.0 Imp qt) |
| Coolant                   | SKYACTIV-G 2.0              | Manual transaxle                   | 7.4 L (7.8 US qt, 6.5 Imp qt) |
|                           |                             | Automatic transaxle                | 8.2 L (8.7 US qt, 7.2 Imp qt) |
|                           | Except SKYACTIV-G 2.0       | 7.5 L (7.9 US qt, 6.6 Imp qt)      |                               |
| Manual transaxle oil      | MZR 2.0                     | 2.77 L (2.93 US qt, 2.44 Imp qt)   |                               |
|                           | SKYACTIV-G 2.0              | 1.70 L (1.80 US qt, 1.50 Imp qt)   |                               |
|                           | MZR 2.3 DISI Turbo          | 2.5 L (2.6 US qt, 2.2 Imp qt)      |                               |
|                           | MZR 2.5                     | 2.85 L (3.01 US qt, 2.51 Imp qt)   |                               |
| Automatic transaxle fluid | 5-speed transaxle           | 8.14 L (8.60 US qt, 7.16 Imp qt)   |                               |
|                           | 6-speed transaxle           | 7.8 L (8.2 US qt, 6.9 Imp qt)      |                               |
| Fuel tank                 | MZR 2.0, SKYACTIV-G 2.0     | 55.0 L (14.5 US gal, 12.1 Imp gal) |                               |
|                           | MZR 2.3 DISI Turbo, MZR 2.5 | 60.0 L (15.9 US gal, 13.2 Imp gal) |                               |

Check oil and fluid levels with dipsticks or reservoir gauges.



## Specifications

### ▼ Dimensions

#### Except Mexico

##### 4 Door

| Item           |                       | Vehicle specification |
|----------------|-----------------------|-----------------------|
| Overall length |                       | 4,595 mm (180.9 in)   |
| Overall width  |                       | 1,755 mm (69.1 in)    |
| Overall height |                       | 1,470 mm (57.9 in)    |
| Front tread    | 16-inch wheel vehicle | 1,535 mm (60.4 in)    |
|                | 17-inch wheel vehicle | 1,530 mm (60.2 in)    |
| Rear tread     | 16-inch wheel vehicle | 1,520 mm (59.8 in)    |
|                | 17-inch wheel vehicle | 1,515 mm (59.6 in)    |
| Wheelbase      |                       | 2,640 mm (103.9 in)   |

##### 5 Door

#### (Except MZR 2.3 DISI Turbo)

| Item           |                       | Vehicle specification |
|----------------|-----------------------|-----------------------|
| Overall length |                       | 4,505 mm (177.4 in)   |
| Overall width  |                       | 1,755 mm (69.1 in)    |
| Overall height |                       | 1,470 mm (57.9 in)    |
| Front tread    | 16-inch wheel vehicle | 1,535 mm (60.4 in)    |
|                | 17-inch wheel vehicle | 1,530 mm (60.2 in)    |
| Rear tread     | 16-inch wheel vehicle | 1,520 mm (59.8 in)    |
|                | 17-inch wheel vehicle | 1,515 mm (59.6 in)    |
| Wheelbase      |                       | 2,640 mm (103.9 in)   |

#### (MZR 2.3 DISI Turbo)

| Item           |  | Vehicle specification |
|----------------|--|-----------------------|
| Overall length |  | 4,510 mm (177.6 in)   |
| Overall width  |  | 1,770 mm (69.7 in)    |
| Overall height |  | 1,460 mm (57.5 in)    |
| Front tread    |  | 1,535 mm (60.4 in)    |
| Rear tread     |  | 1,525 mm (60.0 in)    |
| Wheelbase      |  | 2,640 mm (103.9 in)   |

## Specifications

### Mexico

#### 4 Door

| Item           |                              | Vehicle specification |
|----------------|------------------------------|-----------------------|
| Overall length | Without license plate holder | 4,580 mm (180.3 in)   |
|                | With license plate holder    | 4,595 mm (180.9 in)   |
| Overall width  |                              | 1,755 mm (69.1 in)    |
| Overall height |                              | 1,470 mm (57.9 in)    |
| Front tread    | 16-inch wheel vehicle        | 1,535 mm (60.4 in)    |
|                | 17-inch wheel vehicle        | 1,530 mm (60.2 in)    |
| Rear tread     | 16-inch wheel vehicle        | 1,520 mm (59.8 in)    |
|                | 17-inch wheel vehicle        | 1,515 mm (59.6 in)    |
| Wheelbase      |                              | 2,640 mm (103.9 in)   |

#### 5 Door

#### (Except MZR 2.3 DISI Turbo)

| Item           |                              | Vehicle specification |
|----------------|------------------------------|-----------------------|
| Overall length | Without license plate holder | 4,490 mm (176.8 in)   |
|                | With license plate holder    | 4,505 mm (177.4 in)   |
| Overall width  |                              | 1,755 mm (69.1 in)    |
| Overall height |                              | 1,470 mm (57.9 in)    |
| Front tread    |                              | 1,530 mm (60.2 in)    |
| Rear tread     |                              | 1,515 mm (59.6 in)    |
| Wheelbase      |                              | 2,640 mm (103.9 in)   |

#### (MZR 2.3 DISI Turbo)

| Item           |  | Vehicle specification |
|----------------|--|-----------------------|
| Overall length |  | 4,510 mm (177.6 in)   |
| Overall width  |  | 1,770 mm (69.7 in)    |
| Overall height |  | 1,460 mm (57.5 in)    |
| Front tread    |  | 1,535 mm (60.4 in)    |
| Rear tread     |  | 1,525 mm (60.0 in)    |
| Wheelbase      |  | 2,640 mm (103.9 in)   |

## Specifications

### ▼ Weights

#### Except Mexico

##### 4 Door (MZR 2.0)

| Item                               | Weight               |                      |
|------------------------------------|----------------------|----------------------|
|                                    | Manual transaxle     | Automatic transaxle  |
| GVWR (Gross Vehicle Weight Rating) | 1,768 kg (3,898 lbs) | 1,800 kg (3,968 lbs) |
| GAWR (Gross Axle Weight Rating)    | Front                | 933 kg (2,057 lbs)   |
|                                    | Rear                 | 835 kg (1,841 lbs)   |
|                                    |                      | 967 kg (2,132 lbs)   |
|                                    |                      | 833 kg (1,836 lbs)   |

##### (SKYACTIV-G 2.0)

| Item                               | Weight               |                      |
|------------------------------------|----------------------|----------------------|
|                                    | Manual transaxle     | Automatic transaxle  |
| GVWR (Gross Vehicle Weight Rating) | 1,772 kg (3,907 lbs) | 1,803 kg (3,975 lbs) |
| GAWR (Gross Axle Weight Rating)    | Front                | 944 kg (2,081 lbs)   |
|                                    | Rear                 | 828 kg (1,825 lbs)   |
|                                    |                      | 977 kg (2,154 lbs)   |
|                                    |                      | 826 kg (1,821 lbs)   |

##### (MZR 2.5)

| Item                               | Weight               |                      |
|------------------------------------|----------------------|----------------------|
|                                    | Manual transaxle     | Automatic transaxle  |
| GVWR (Gross Vehicle Weight Rating) | 1,816 kg (4,004 lbs) | 1,851 kg (4,081 lbs) |
| GAWR (Gross Axle Weight Rating)    | Front                | 971 kg (2,141 lbs)   |
|                                    | Rear                 | 845 kg (1,863 lbs)   |
|                                    |                      | 1,002 kg (2,209 lbs) |
|                                    |                      | 849 kg (1,872 lbs)   |

##### 5 Door (MZR 2.0 (Canada))

| Item                               | Weight               |                      |
|------------------------------------|----------------------|----------------------|
|                                    | Manual transaxle     | Automatic transaxle  |
| GVWR (Gross Vehicle Weight Rating) | 1,764 kg (3,889 lbs) | 1,788 kg (3,942 lbs) |
| GAWR (Gross Axle Weight Rating)    | Front                | 931 kg (2,052 lbs)   |
|                                    | Rear                 | 833 kg (1,836 lbs)   |
|                                    |                      | 964 kg (2,125 lbs)   |
|                                    |                      | 824 kg (1,817 lbs)   |

##### (SKYACTIV-G 2.0)

| Item                               | Weight               |                      |
|------------------------------------|----------------------|----------------------|
|                                    | Manual transaxle     | Automatic transaxle  |
| GVWR (Gross Vehicle Weight Rating) | 1,778 kg (3,920 lbs) | 1,810 kg (3,990 lbs) |
| GAWR (Gross Axle Weight Rating)    | Front                | 941 kg (2,075 lbs)   |
|                                    | Rear                 | 837 kg (1,845 lbs)   |
|                                    |                      | 975 kg (2,149 lbs)   |
|                                    |                      | 835 kg (1,841 lbs)   |

##### (MZR 2.3 DISI Turbo)

| Item                               | Weight           |                      |
|------------------------------------|------------------|----------------------|
|                                    | Manual transaxle | Automatic transaxle  |
| GVWR (Gross Vehicle Weight Rating) |                  | 1,922 kg (4,237 lbs) |
| GAWR (Gross Axle Weight Rating)    | Front            | 1,062 kg (2,341 lbs) |
|                                    | Rear             | 860 kg (1,896 lbs)   |

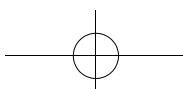

## Specifications

(MZR 2.5)

| Item                               |       | Weight               |                      |
|------------------------------------|-------|----------------------|----------------------|
|                                    |       | Manual transaxle     | Automatic transaxle  |
| GVWR (Gross Vehicle Weight Rating) |       | 1,837 kg (4,050 lbs) | 1,863 kg (4,107 lbs) |
| GAWR (Gross Axle Weight Rating)    | Front | 977 kg (2,154 lbs)   | 1,006 kg (2,218 lbs) |
|                                    | Rear  | 860 kg (1,896 lbs)   | 857 kg (1,889 lbs)   |

### Mexico

**4 Door**

(MZR 2.0)

| Item                        |       | Weight               |                      |
|-----------------------------|-------|----------------------|----------------------|
|                             |       | Manual transaxle     | Automatic transaxle  |
| GVW (Gross Vehicle Weight)  | Total | 1,765 kg (3,891 lbs) | 1,795 kg (3,957 lbs) |
|                             | Front | 930 kg (2,050 lbs)   | 965 kg (2,127 lbs)   |
|                             | Rear  | 835 kg (1,841 lbs)   | 830 kg (1,830 lbs)   |
| GAW (Permissible axle load) | Front | 930 kg (2,050 lbs)   | 965 kg (2,127 lbs)   |
|                             | Rear  | 840 kg (1,852 lbs)   | 835 kg (1,841 lbs)   |

(MZR 2.5)

| Item                        |       | Weight               |                      |
|-----------------------------|-------|----------------------|----------------------|
|                             |       | Manual transaxle     | Automatic transaxle  |
| GVW (Gross Vehicle Weight)  | Total | 1,815 kg (4,001 lbs) | 1,845 kg (4,067 lbs) |
|                             | Front | 970 kg (2,138 lbs)   | 1,000 kg (2,205 lbs) |
|                             | Rear  | 845 kg (1,863 lbs)   | 845 kg (1,863 lbs)   |
| GAW (Permissible axle load) | Front | 970 kg (2,138 lbs)   | 1,000 kg (2,205 lbs) |
|                             | Rear  | 850 kg (1,874 lbs)   | 850 kg (1,874 lbs)   |

**5 Door**

(MZR 2.3 DISI Turbo)

| Item                               |       | Weight               |
|------------------------------------|-------|----------------------|
| GVWR (Gross Vehicle Weight Rating) |       | 1,922 kg (4,237 lbs) |
| GAWR (Gross Axle Weight Rating)    | Front | 1,062 kg (2,341 lbs) |
|                                    | Rear  | 860 kg (1,896 lbs)   |

(MZR 2.5)

| Item                        |       | Weight               |                      |
|-----------------------------|-------|----------------------|----------------------|
|                             |       | Manual transaxle     | Automatic transaxle  |
| GVW (Gross Vehicle Weight)  | Total | 1,835 kg (4,045 lbs) | 1,860 kg (4,101 lbs) |
|                             | Front | 975 kg (2,149 lbs)   | 1,005 kg (2,216 lbs) |
|                             | Rear  | 860 kg (1,896 lbs)   | 855 kg (1,885 lbs)   |
| GAW (Permissible axle load) | Front | 975 kg (2,149 lbs)   | 1,005 kg (2,216 lbs) |
|                             | Rear  | 865 kg (1,907 lbs)   | 860 kg (1,896 lbs)   |

**10-10**

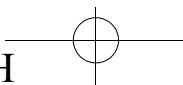

## Specifications

### ▼ Air Conditioner

| Item             | Classification   |
|------------------|------------------|
| Refrigerant Type | HFC134a (R-134a) |

### ▼ Light Bulbs

#### Exterior light

| Light bulb  |                   |               | Category |                |
|---|-------------------|---------------|----------|----------------|
|   |                   |               | Wattage  | ECE R (SAE)    |
| Headlights  | Halogen           | High beam     | 60       | HB3 (#9005)    |
|   |                   | Low beam      | 55       | H11 (H11)      |
|   | Xenon fusion bulb | High/Low beam | 35       | D2S (D2S)      |
| Daytime running lights (Canada) *                           | Type A            |               | 35       | H8 (H8)        |
|   | Type B            |               | 21       | W21/5W (#7443) |
| Front turn signal lights/Front side-marker lights           |                   |               | 27/8     | — (#7444NA)    |
| Parking lights (Except Canada) *                            |                   |               | 5        | W5W (4CP)      |
| Fog lights *  |                   |               | 55       | H11 (H11)      |
| Side turn signal lights (Integrated with outside mirrors) * |                   |               | LED*1    | — (—)          |
| High-mount brake light                                      | 4 Door            |               | 21       | W21W (1120)    |
|   | 5 Door            | Bulb type     | 18       | W16W (#921)    |
|   |                   | LED type      | LED*1    | — (—)          |
| Rear turn signal lights                                     | Type A            |               | 21       | WY21W (32CP)   |
|   | Type B            |               | 21       | W21W (#7440)   |
| Brake lights/Taillights (Rear side-marker lights)           | Bulb type         |               | 21/5     | W21/5W (#7443) |
|   | LED type          |               | LED*1    | — (—)          |
| Reverse lights  |                   |               | 21       | W21W (#7440)   |
| License plate lights  |                   |               | 5        | W5W (—)        |

\*1 LED is the abbreviation for Light Emitting Diode.

#### Interior light

| Light bulb                         | Category |       |
|------------------------------------|----------|-------|
|                                    | Wattage  | ECE R |
| Trunk light (4 Door)               | 3        | —     |
| Luggage compartment light (5 Door) | 5        | —     |
| Overhead light (Front)/Map lights  | 8        | —     |
| Overhead light (Rear)              | 10       | —     |
| Vanity mirror lights *             | 2        | —     |

\*Some models. **10-11**

## Specifications

### ▼ Tires

#### **NOTE**

*The tires have been optimally matched with the chassis of your vehicle.*

*When replacing tires, Mazda recommends that you replace tires of the same type originally fitted to your vehicle. For details, contact an Authorized Mazda Dealer.*

Check the tire pressure label for tire size and inflation pressure.

Refer to Tire Inflation Pressure on page 8-40.

#### **Standard tire**

**(Except MZR 2.3 DISI Turbo)**

| Tire size         |                             | Inflation pressure |                  |
|-------------------|-----------------------------|--------------------|------------------|
|                   |                             | Front              | Rear             |
| P205/55R16<br>89H | SKYACTIV-G 2.0              | 250 kPa (36 psi)   | 250 kPa (36 psi) |
|                   | Except<br>SKYACTIV-G<br>2.0 | 240 kPa (35 psi)   | 240 kPa (35 psi) |
| P205/50R17 88V    |                             | 220 kPa (32 psi)   | 220 kPa (32 psi) |

**(MZR 2.3 DISI Turbo)**

| Tire size      |  | Inflation pressure |                  |
|----------------|--|--------------------|------------------|
|                |  | Front              | Rear             |
| P225/40R18 88Y |  | 240 kPa (35 psi)   | 230 kPa (34 psi) |

#### **Temporary spare tire**

| Tire size      | Inflation pressure |
|----------------|--------------------|
| T115/70D15 90M | 420 kPa (60 psi)   |
| T125/70D16 96M | 420 kPa (60 psi)   |
| T125/70D17 98M | 420 kPa (60 psi)   |

### ▼ Fuses

Refer to Fuses on page 8-58.

## Personalization Features

### Personalization Features

The following “Personalization Features” are available. These settings can only be changed by an Authorized Mazda Dealer.

| Item               | Feature  | Factory Setting | Available Settings |
|--------------------|--|-----------------|--------------------|
| Illumination entry | The time required for the interior lamp to turn off automatically after all doors are closed can be changed  | 15 seconds      | 7.5/30/60 seconds  |
|                    | The time required for the interior lamp to illuminate after unlocking any door can be changed  | 30 seconds      | 7.5/15/60 seconds  |
|                    | The function allowing the interior lamp to illuminate automatically when the ignition is switched off can be deactivated                               | Activated       | Deactivated        |
|                    | The function allowing the interior lamp to illuminate automatically when the doors are unlocked can be deactivated                                     | Activated       | Deactivated        |
|                    | The function allowing the interior lamp to turn off automatically when any door is opened (or not securely closed) can be changed                      | Activated       | Deactivated        |
|                    | The time required for the interior lamp to turn off automatically can be changed (prevents battery depletion when a door is open/ajar)                 | 30 minutes      | 60/10 minutes      |
| Keyless entry      | The time required for the doors to relock automatically after unlocking with the transmitter can be changed  | 30 seconds      | 60/90 seconds      |
|                    | The flashing of the hazard warning lights when the doors are locked/unlocked can be changed  | Activated       | Deactivated        |
|                    | The function allowing the horn to sound automatically when the doors are locked by pressing the transmitter two times consecutively can be deactivated | Activated       | Deactivated        |
| Smart turn         | The function allowing the turn signal lights to flash three times with a momentary turn switch operation (when changing lanes) can be changed          | Deactivated     | Activated          |

## Personalization Features

| Item                                    | Feature  | Factory Setting   | Available Settings  |
|---|--|---|---|
| Advanced keyless entry and Start system | The method for unlocking the doors using the request switch can be selected  | Press × 2   | Press × 1   |
|   | The function to automatically lock the doors when leaving the vehicle while carrying the key can be activated  | Deactivated   | Activated   |
|   | The advanced key's remaining battery level warning light in the instrument cluster can be deactivated  | Activated   | Deactivated   |
|   | The volume of the answer-back beep during keyless entry system operation can be adjusted   | High  | Low/Deactivated   |
|   | The volume of the warning beep for the advanced keyless entry system can be adjusted   | High  | Low   |
|   | The advanced key function can be deactivated   | Activated   | Deactivated   |
|   | The function allowing the power supply to turn off automatically after the ignition has been left in the ACC position for a long period of time can be deactivated | Activated   | Deactivated   |
|   | The time required for the doors to relock automatically after unlocking with the request switch/transmitter can be changed   | 30 seconds  | 60/90 seconds   |
|   | The order in which the ignition position transitions when pressing the push button start can be changed  | ON → Off  | ON → ACC → Off  |
| Auto headlight on/off                   | The headlight illumination on/off timing based on surrounding lightness/darkness can be changed  | Standard (Illuminates under average levels of darkness) | Earlier/<br>Somewhat earlier/<br>Somewhat later/<br>Later |
| Multi information display               | The distance unit can be changed   | mile or km  | km or mile  |



## Personalization Features

| Item            | Feature  | Factory Setting  | Available Settings  |
|-----------------|--|------------------|---|
| Power door lock | The system can be changed to a function which unlocks all doors using a single operation             | Driver's door    | All doors   |
|                 | The vehicle-speed-response auto lock function can be deactivated                                     | Activated        | Deactivated   |
|                 | Locking/unlocking of the doors can be set in conjunction with the selector lever position            | Deactivated      | 1. Not in Park (P) position: Lock all doors<br>Park (P) position: Unlock all doors<br>2. Not in Park (P) position: Lock all doors<br>Park (P) position: Unlock the driver's door only<br>3. Not in Park (P) position: Lock all doors<br>Park (P) position: Inoperable |
|                 | The function for unlocking the doors simultaneously when the ignition is switched off can be changed | Unlock all doors | Unlock driver's door/Inoperable   |

## Personalization Features

The following “Personalization Features” can be changed by the vehicle owner.

| Item                                | Feature  | Factory Setting  | Available Settings   |
|-------------------------------------|--|--|--|
| Key reminder warning alarm          | The volume of the key reminder warning alarm can be changed 6-186  | High   | Low  |
| Lights-on reminder warning alarm    | The volume of the lights-on reminder warning alarm can be changed 6-186  | High   | Low  |
| Turn indicator                      | The beep volume level can be changed 6-186   | Mid  | Low  |
| Multi information display           | The display language can be selected 6-186   | English, French, or Spanish  | English/German/French/Italian/Spanish  |
|                                     | The temperature unit can be changed 6-186  | °F or °C   | °C or °F   |
| Power door lock                     | Changes the auto lock/unlock function setting for all the doors according to the vehicle speed, the vehicle power supply condition, and the selector lever position 3-34 | All the doors and the liftgate lock automatically when the vehicle speed is about 20 km/h (12 mph) or more. All the doors and the liftgate unlock when the ignition is switched from ON to ACC or Off. | The auto door-lock function is disabled  |
|                                     |  |  | All the doors and the liftgate lock automatically when the vehicle speed is about 20 km/h (12 mph) or more   |
|                                     |  |  | When the ignition is switched ON and the shift lever is shifted from park (P) to any other gear position, all the doors and the liftgate lock automatically.   |
|                                     |  |  | When the ignition is switched ON and the shift lever is shifted from park (P) to any other gear position, all the doors and the liftgate lock automatically. When the shift lever is shifted to park (P) while the ignition is switched ON, all the doors and the liftgate unlock automatically. |
| Action illumination                 | Deactivates action illumination function 6-32  | Activated  | Deactivated  |
| Welcome sound                       | Deactivates welcome sound function 6-32  | Activated  | Deactivated  |
| Blind Spot Monitoring (BSM) warning | The warning beep function can be changed 6-186   | High   | Low  |
| Boost gauge                         | Display of the boost gauge can be switched off 5-45  | Display  | Non-display  |

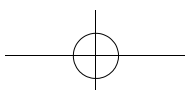

---

**11** **Index**

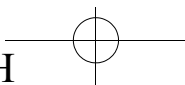
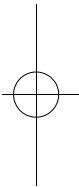
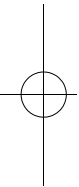

## Index

### A

- Accessory Socket ..... 6-192
- Adaptive Front Lighting System (AFS) ..... 5-68
- Add-On Non-Genuine Parts and Accessories ..... 9-19
- Advanced Key ..... 3-2
  - Advanced key maintenance ..... 3-5
  - Advanced key suspend function ..... 3-20
  - Auxiliary key ..... 3-20
  - Locking, unlocking with request switch ..... 3-9
  - Opening the liftgate/trunk lid .... 3-11
  - Operational range ..... 3-7
  - Remote control function ..... 3-16
  - Service ..... 3-7
  - Warning and beep sounds ..... 3-21
  - When warning indicator/beep is activated ..... 3-24
- Air Bag Systems ..... 2-44
- Antenna ..... 6-16
- Anti-Lock Brake System (ABS) ..... 5-8
  - Warning light ..... 5-8
- Appearance Care ..... 8-65
- Audio System ..... 6-16
  - Audio control switch ..... 6-82
  - Audio set (Type A) ..... 6-31
  - Audio set (Type B) ..... 6-61
  - AUX/USB/iPod mode ..... 6-86
  - Operating tips for audio system ..... 6-17
  - Safety certification ..... 6-105

### A

- Automatic Transaxle
  - Driving tips ..... 5-20
  - Fluid ..... 8-28
  - Manual shift mode ..... 5-16
  - Shift-lock override ..... 5-15
  - Shift-lock system ..... 5-15
  - Transaxle ranges ..... 5-14

### B

- Battery
  - Emergency starting ..... 7-18
  - Maintenance ..... 8-35
  - Specifications ..... 10-4
- Beep Sounds
  - Blind spot monitoring system warning ..... 5-63
  - Ignition key reminder ..... 5-63
  - Lights-on reminder ..... 5-63
  - Seat belt warning ..... 5-63
  - Tire inflation pressure warning... 5-63
- Before Starting the Engine ..... 4-6
  - After getting in ..... 4-6
  - Before getting in ..... 4-6
- Blind Spot Monitoring (BSM) System ..... 5-37
  - BSM OFF indicator light ..... 5-39
  - BSM OFF switch ..... 5-40
  - Care of radar sensors ..... 5-40
  - Warning light/beep ..... 5-39
- Bluetooth® (Type B) ..... 6-139
  - Bluetooth® Audio ..... 6-164
  - Bluetooth® Hands-Free ..... 6-145
  - Safety Certification ..... 6-172
  - Troubleshooting ..... 6-168
- Bluetooth® Audio (Type A) ..... 6-106

## Index

### B

- Bluetooth® Hands-Free (Type A) ... 6-116
  - Basic Bluetooth® Hands-Free operation ..... 6-120
  - Convenient use of the hands-free system ..... 6-125
  - Hands-free setting ..... 6-131
  - Mazda Bluetooth® Hands-Free customer service ..... 6-138
  - Safety certification ..... 6-138
  - When Bluetooth® Hands-Free cannot be used ..... 6-137
- Body Lubrication ..... 8-31
- Boost Gauge ..... 5-45
- Bottle Holder ..... 6-188
- Brake/Clutch
  - Fluid ..... 8-27
- Brakes
  - Anti-lock brake system (ABS) ..... 5-8
  - Brakes assist ..... 5-9
  - Foot brake ..... 5-5
  - Parking brake ..... 5-6
  - Warning light ..... 5-7
- Break-In Period ..... 4-7
- Bulb Replacement ..... 8-46

### C

- Capacities ..... 10-6
- Carbon Monoxide ..... 4-5
- Cargo Securing Loops ..... 6-191
- Catalytic Converter ..... 4-4
- Cell Phones ..... 9-20
- Center Console ..... 6-190
- Center Pocket ..... 6-189

### C

- Child Restraint
  - Child restraint precautions ..... 2-26
  - Child-restraint system installation position ..... 2-31
  - Installing child-restraint systems ..... 2-32
  - LATCH child-restraint systems ..... 2-39
- Child Safety Locks for Rear Doors ... 3-37
- Climate Control System ..... 6-2
  - Gas specifications ..... 10-11
- Clock ..... 6-177
- Cruise Control ..... 5-22
- Cup Holder ..... 6-187
- Customer Assistance ..... 9-2

### D

- Dashboard Illumination ..... 5-45
- Daytime Running Lights ..... 5-69
- Defroster
  - Mirror ..... 5-76
  - Rear window ..... 5-75
- Dimensions ..... 10-7
- Door Locks ..... 3-32
- Driving In Flooded Area ..... 4-11
- Driving on Uneven Road ..... 4-13
- Driving Tips ..... 4-7
  - Automatic transaxle ..... 5-20
  - Break-in period ..... 4-7
  - Driving in flooded area ..... 4-11
  - Driving on uneven road ..... 4-13
  - Hazardous driving ..... 4-8
  - Money-saving suggestions ..... 4-7
  - Rocking the vehicle ..... 4-9
  - Turbocharged vehicles ..... 4-14
  - Winter driving ..... 4-9

## Index

---

### D

- Dynamic Stability Control (DSC) ..... 5-28
  - DSC OFF indicator light ..... 5-29
  - DSC OFF switch ..... 5-29
  - TCS/DSC indicator light ..... 5-29

### E

- Emergency Starting ..... 7-18
  - Flooded engine ..... 7-18
  - Jump-starting ..... 7-19
  - Push-starting ..... 7-24
- Emergency Towing ..... 7-25
- Emission Control System ..... 4-4
- Engine
  - Coolant ..... 8-25
  - Exhaust gas ..... 4-5
  - Hood release ..... 3-50
  - Oil ..... 8-21
  - Overheating ..... 7-16
  - Starting ..... 5-3
- Engine Compartment Overview ..... 8-19
- Engine Coolant
  - Overheating ..... 7-16
- Event Data Recorder ..... 9-21
- Exhaust Gas ..... 4-5
- Exterior Care ..... 8-67

### F

- Flasher
  - Hazard warning ..... 5-77
  - Headlights ..... 5-64
- Flat Tire ..... 7-3
  - Changing ..... 7-9
  - Spare tire and tool storage ..... 7-3
- Fluids
  - Classification ..... 10-5
  - Owner maintenance ..... 8-16

11-4

### F

- Fog Lights ..... 5-70
- Foot Brake ..... 5-5
- Front Seats
  - (Electrically Operated Seats) ..... 2-4
  - Front Seats
    - (Manually Operated Seats) ..... 2-2
- Fuel
  - Filler lid and cap ..... 3-49
  - Gauge ..... 5-44
  - Requirements ..... 4-2
  - Tank capacity ..... 10-6
- Fuses ..... 8-58
  - Panel description ..... 8-61
  - Replacement ..... 8-58

### G

- Gauges ..... 5-42
- Glove Compartment ..... 6-190

### H

- Hazard Warning Flasher ..... 5-77
- Hazardous Driving ..... 4-8
- Headlights
  - Control ..... 5-64
  - Flashing ..... 5-67
  - High-low beam ..... 5-67
  - Leveling ..... 5-67
  - On reminder ..... 5-67
- Hood Release ..... 3-50
- Horn ..... 5-76

### I

- Ignition
  - Keys ..... 3-25
  - Switch ..... 5-2

## Index

### I

|  |       |
|--|-------|
| Illuminated Entry System .....                     | 6-174 |
| Immobilizer System<br>(with Advanced Key) .....    | 3-54  |
| Immobilizer System<br>(without Advanced Key) ..... | 3-58  |
| Indicator Lights .....                             | 5-47  |
| AFS OFF .....                                      | 5-60  |
| BSM OFF .....                                      | 5-61  |
| Cruise .....                                       | 5-60  |
| DSC OFF .....                                      | 5-60  |
| Headlight high-beam .....                          | 5-59  |
| KEY .....  | 5-57  |
| Low engine coolant<br>temperature .....            | 5-59  |
| Power steering malfunction .....                   | 5-61  |
| Security .....                                     | 5-58  |
| Shift position .....                               | 5-59  |
| TCS/DSC .....                                      | 5-59  |
| Turn signal/hazard warning .....                   | 5-62  |
| Information Display .....                          | 6-176 |
| Audio display .....                                | 6-177 |
| Climate control display .....                      | 6-177 |
| Clock .....  | 6-177 |
| Information display functions... ..                | 6-176 |
| Outside temperature display .....                  | 6-177 |
| Inside Trunk Release Lever .....                   | 3-44  |
| Instrument Cluster .....                           | 5-42  |
| Interior Care .....                                | 8-71  |
| Interior Lights .....                              | 6-174 |

### J

|                     |      |
|---------------------|------|
| Jump-Starting ..... | 7-19 |
|---------------------|------|

### K

|                            |      |
|----------------------------|------|
| Keyless Entry System ..... | 3-26 |
| Keys .....                 | 3-25 |

### L

|                                 |       |
|---------------------------------|-------|
| Label Information .....         | 10-2  |
| Lane-Change Signals .....       | 5-69  |
| Liftgate .....                  | 3-38  |
| Luggage compartment .....       | 3-41  |
| Light Bulbs                     |       |
| Replacement .....               | 8-46  |
| Specifications .....            | 10-11 |
| Lighting Control .....          | 5-64  |
| Lubricant Quality .....         | 10-5  |
| Luggage Compartment Light ..... | 6-175 |

### M

|  |       |
|--|-------|
| Maintenance                            |       |
| Introduction .....                     | 8-2   |
| Owner maintenance<br>precautions ..... | 8-17  |
| Owner maintenance schedule .....       | 8-16  |
| Scheduled .....                        | 8-4   |
| Manual Transaxle Operation .....       | 5-10  |
| Recommendations for shifting.... ..    | 5-11  |
| Map Lights .....                       | 6-175 |
| Meters and Gauges .....                | 5-42  |
| Mirror Defroster .....                 | 5-76  |
| Mirrors                                |       |
| Outside mirrors .....                  | 3-65  |
| Rearview mirror .....                  | 3-66  |
| Money-Saving Suggestions .....         | 4-7   |
| Moonroof .....                         | 3-52  |

## Index

### M

- Multi Information Display ..... 6-178
  - Audio Display ..... 6-180
  - Clock ..... 6-179
  - Maintenance Monitor ..... 6-181
  - Multi Information Display
    - Functions ..... 6-179
    - Outside Temperature Display... 6-180
    - Settings ..... 6-186
    - Trip Computer ..... 6-180
    - Warning Indicator ..... 6-186

### O

- Odometer and Trip Meter ..... 5-43
- Outside Mirrors ..... 3-65
- Outside Temperature Display ..... 6-177
- Overhead Console ..... 6-189
- Overhead Lights ..... 6-175
- Overheating ..... 7-16
- Overloading ..... 4-12

### P

- Paint Damage ..... 8-65
- Parking Brake ..... 5-6
- Parking in an Emergency ..... 7-2
- Personalization Features ..... 10-13
- Power Door Locks ..... 3-34
- Power Steering ..... 5-21
  - Fluid ..... 8-28
  - Power steering malfunction indicator light ..... 5-21
- Power Windows ..... 3-46
- Push-Starting ..... 7-24

### R

- Rear Coat Hooks ..... 6-192

### R

- Rear Door Child Safety Locks ..... 3-37
- Rear Seat ..... 2-7
- Rear Window Defroster ..... 5-75
- Rear Window Washer ..... 5-75
- Rear Window Wiper ..... 5-75
- Rearview Mirror ..... 3-66
- Recreational Towing ..... 7-28
- Registering Your Vehicle in A Foreign Country ..... 9-18
- Rocking the Vehicle ..... 4-9

### S

- Safety Defects, Reporting ..... 9-43
- Seat Belt System
  - 3-point type ..... 2-18
  - Automatic locking ..... 2-17
  - Emergency locking ..... 2-16
  - Extender ..... 2-23
  - Pregnant women ..... 2-16
  - Pretensioner and load limiting .... 2-20
  - Seat belt precautions ..... 2-14
  - Seat belt reminder ..... 2-25

#### Seats

- Front seat
  - (Electrically operated seats) ..... 2-4
- Front seat
  - (Manually operated seats) ..... 2-2
- Rear seat ..... 2-7
- Seat warmer ..... 2-12

#### Security System

- Immobilizer system
  - (with advanced key) ..... 3-54
- Immobilizer system
  - (without advanced key) ..... 3-58
- Theft-deterrent system ..... 3-62
- Service Publications ..... 9-45
- Shopping Bag Hook ..... 6-191



## Index

### S

|                                   |       |
|-----------------------------------|-------|
| Spare Tire and Tool Storage ..... | 7-3   |
| Specifications .....              | 10-4  |
| Speedometer .....                 | 5-43  |
| Starting the Engine .....         | 5-3   |
| Steering Wheel .....              | 3-65  |
| Horn .....                        | 5-76  |
| Storage Compartments .....        | 6-189 |
| Cargo securing loops .....        | 6-191 |
| Center console .....              | 6-190 |
| Center pocket .....               | 6-189 |
| Glove compartment .....           | 6-190 |
| Overhead console .....            | 6-189 |
| Rear coat hooks .....             | 6-192 |
| Shopping bag hook .....           | 6-191 |
| Sunshade .....                    | 3-53  |
| Sunvisors .....                   | 6-174 |

### T

|  |      |
|--|------|
| Tachometer .....                                       | 5-44 |
| Temporary Spare Tire .....                             | 8-43 |
| Theft-Deterrent System .....                           | 3-62 |
| Tiedown  |      |
| Hook .....   | 7-26 |
| Tire Information .....                                 | 9-24 |
| Tire Pressure Monitoring System .....                  | 5-31 |
| System error activation .....                          | 5-35 |
| Tire pressure monitoring system<br>warning light ..... | 5-33 |
| Tires and wheels .....                                 | 5-35 |

### T

|  |       |
|--|-------|
| Tires  |       |
| Flat Tire .....                                      | 7-3   |
| Inflation pressure .....                             | 8-40  |
| Replacement .....                                    | 8-42  |
| Rotation .....                                       | 8-41  |
| Snow tires .....                                     | 4-10  |
| Spare tire and tool storage .....                    | 7-3   |
| Specifications .....                                 | 10-12 |
| Tire chains .....                                    | 4-10  |
| Uniform tire quality grading system<br>(UTQGS) ..... | 9-22  |
| Tool .....   | 7-3   |
| Towing   |       |
| Description .....                                    | 7-25  |
| Emergency towing .....                               | 7-25  |
| Recreational towing .....                            | 7-28  |
| Trailer towing .....                                 | 4-15  |
| Traction Control System (TCS) .....                  | 5-27  |
| TCS/DSC indicator light .....                        | 5-28  |
| Trailer Towing .....                                 | 4-15  |
| Trip Meter .....                                     | 5-43  |
| Trunk Lid .....                                      | 3-42  |
| Inside trunk release lever .....                     | 3-44  |
| Trunk Light .....                                    | 3-43  |
| Turn and Lane-Change Signals .....                   | 5-69  |

### V

|                                  |       |
|----------------------------------|-------|
| Vanity Mirrors .....             | 6-174 |
| Vehicle Information Labels ..... | 10-2  |

## Index

---

### W

|  |      |
|--|------|
| Warning Lights .....                         | 5-47 |
| ABS .....                                    | 5-50 |
| Air bag system .....                         | 5-53 |
| Automatic transaxle .....                    | 5-54 |
| Brake system .....                           | 5-49 |
| Charging system .....                        | 5-51 |
| Check engine .....                           | 5-52 |
| Check fuel cap .....                         | 5-53 |
| Door-ajar .....                              | 5-54 |
| Engine oil pressure .....                    | 5-51 |
| Front seat belt pretensioner<br>system ..... | 5-53 |
| High engine coolant<br>temperature .....     | 5-52 |
| KEY .....                                    | 5-57 |
| Low fuel .....                               | 5-53 |
| Low washer fluid level .....                 | 5-54 |
| Malfunction .....                            | 5-50 |
| Seat belt .....                              | 5-54 |
| Tire pressure monitoring<br>system .....     | 5-55 |
| Warranty .....                               | 9-15 |
| Washer Fluid .....                           | 8-30 |
| Weights .....                                | 10-9 |
| Wheel Replacement .....                      | 8-43 |
| Windows                                      |      |
| Power windows .....                          | 3-46 |
| Windshield Washer .....                      | 5-74 |
| Windshield Wipers .....                      | 5-71 |
| Blades replacement .....                     | 8-31 |
| Winter Driving .....                         | 4-9  |